

EYE/FACEWASH



PARTS

SERVICE



KNOWLEDGE



SELF-CONTAINED

QUALITY



INNOVATION

Encon[®]
SAFETY PRODUCTS

SHOWER, EYEWASH & FACEWASH PRODUCTS

LEADERS

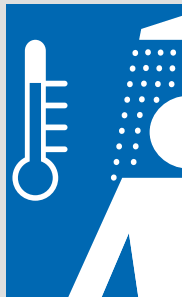

SOLUTIONS



EXCELLENCE

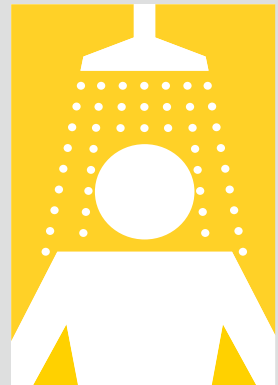

SAFETY



2017

Catalog Contents

Combination Eyewash/Facewash Showers

<i>Galvanized Piping</i>	5
<i>Stainless Steel Piping</i>	10
<i>PVC Piping</i>	12
<i>Corrosion-Resistant Coating</i>	13
<i>Vertical & Horizontal Showers</i>	14

Freeze – Resistant Showers

<i>Freeze & Scald Protection Valves</i>	16
<i>Subsurface Showers & Eye/Facewash</i>	17
<i>Through-Wall Shower & Eyewash</i>	18

Self-Contained

<i>Aquarion®</i>	20
<i>Helios®</i>	21
<i>Gravity Fed</i>	22
<i>Standard Pressurized Portable Eyewash</i>	23
<i>Large Pressurized Portable Eyewash</i>	24
<i>Personal Flushing Stations</i>	25

Eyewash & Facewash

<i>Wall Mount</i>	27
<i>Supply Mount</i>	29
<i>Pedestal Mount</i>	31

Freeze-Protected Showers

<i>Therma-Flow® Freeze-Protected Showers</i>	34
<i>Therma-Flow® PLUS Freeze-Protected Shower Enclosures</i>	36

Tempered Water Systems

<i>Electrically Heated & Blended</i>	39
<i>Air Driven</i>	40
<i>Steam Heated & Blended</i>	41
<i>Saf-T-Flo® Fail-Safe Blending</i>	42

Accessories & Parts

<i>Alarm Systems & Lighting</i>	43
<i>Awareness 100™ Signage</i>	45
<i>Awareness® & Awareness 360™ Signage</i>	46
<i>Emergency Signs</i>	47
<i>Shower Accessories & Test Units</i>	48
<i>Assemblies - Heads & Nozzles</i>	50
<i>Bowls & Covers</i>	51
<i>Self-Contained</i>	51
<i>Activation Kits & Valves</i>	52
<i>Protection Valves & Fittings</i>	53
<i>Alarms</i>	53
<i>Curtains & Testing Accessories</i>	53

Representative Performance Data

54

Limited Warranty Statement

54

Numerical Parts Index

55

Key

ABS	<i>Acrylonitrile Butadiene Styrenes</i>
BCP	<i>Brass Chrome-Plated</i>
CP	<i>Chrome-Plated</i>
DH	<i>Drench Hose</i>
FTR	<i>Foot Treadle</i>
PVC	<i>Poly Vinyl Chloride</i>
SS	<i>Stainless Steel</i>



Encon Safety Products built its reputation as “**The most sought-after name in Industrial Safety**” with years of **Experience**, through product **Innovation**, and with an unwavering **Commitment to Excellence**. Today, with over 50 years of commitment to excellence in product design and development, Encon® continues to lead the way with the most reliable and innovative emergency shower and eyewash products.

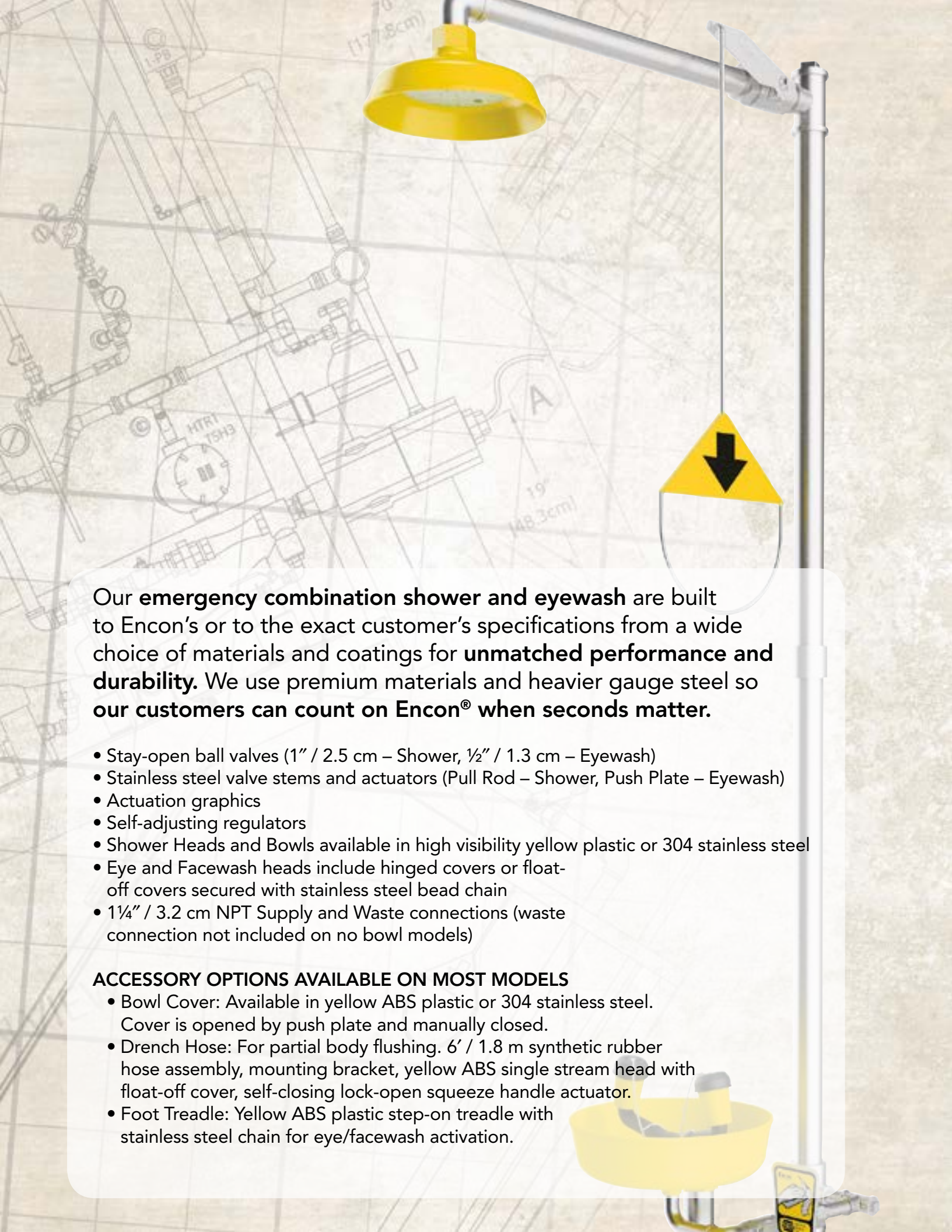

Our **emergency combination shower and eyewash** are built to Encon's or to the exact customer's specifications from a wide choice of materials and coatings for **unmatched performance and durability**. We use premium materials and heavier gauge steel so **our customers can count on Encon® when seconds matter**.

- Stay-open ball valves (1" / 2.5 cm – Shower, ½" / 1.3 cm – Eyewash)
- Stainless steel valve stems and actuators (Pull Rod – Shower, Push Plate – Eyewash)
- Actuation graphics
- Self-adjusting regulators
- Shower Heads and Bowls available in high visibility yellow plastic or 304 stainless steel
- Eye and Facewash heads include hinged covers or float-off covers secured with stainless steel bead chain
- 1¼" / 3.2 cm NPT Supply and Waste connections (waste connection not included on no bowl models)

ACCESSORY OPTIONS AVAILABLE ON MOST MODELS

- Bowl Cover: Available in yellow ABS plastic or 304 stainless steel. Cover is opened by push plate and manually closed.
- Drench Hose: For partial body flushing. 6' / 1.8 m synthetic rubber hose assembly, mounting bracket, yellow ABS single stream head with float-off cover, self-closing lock-open squeeze handle actuator.
- Foot Treadle: Yellow ABS plastic step-on treadle with stainless steel chain for eye/facewash activation.

Combination Showers Eyewash/Facewash

Galvanized Piping

PIPING AND VALVE CHOICES

- Schedule 80 hot dip galvanized steel piping
- Chrome-plated bronze ball valves & ball

SHIP WEIGHT

- Shower — 59 lb / 26.76 kg
- Shower with FTR — 61 lb / 27.66 kg
- Shower with DH — 62 lb / 21.12 kg



Model 01050260

20 gpm / 75.7 lpm Shower,
Facewash with ABS Heads &
Wye, Yello-Bowl®

Model 01050216

30 gpm / 113.6 lpm Shower,
Facewash with ABS Heads &
Wye, Yello-Bowl®



Note: ABS Facewash assembly, 8 gpm / 30.3 lpm Head available with BCP Wye. See model on page 7.

Model 01050251

20 gpm / 75.7 lpm Shower,
Eyewash with ABS Heads &
Wye, Yello-Bowl®

Model 01050207

30 gpm / 113.6 lpm Shower,
Eyewash with ABS Heads &
Wye, Yello-Bowl®



Note: ABS Eyewash assembly, 3.2 gpm / 12.1 lpm

Model 01050217P20

20 gpm / 75.7 lpm Shower,
Eyewash with Acetal Heads
& BCP Wye, Yello-Bowl®

Model 01050217

30 gpm / 113.6 lpm Shower,
Eyewash with Acetal Heads
& BCP Wye, Yello-Bowl®



Note: Acetal eyewash & BCP Wye, 2.4 gpm / 9.1 lpm. Bowl covers available on models with BCP Wye. See bowl covered model on page 6.



Note: Every model in this section includes a 7" x 11" / 17.7 cm x 27.9 cm sign, part number 01112892. See signs on page 47.

Combination Showers Eyewash/Facewash

Galvanized Piping

Model 01050209P20

20 gpm / 75.7 lpm Shower,
Eyewash with ABS Heads &
Wye, Strainer, Yello-Bowl®

Model 01050209

30 gpm / 113.6 lpm Shower,
Eyewash with ABS Heads &
Wye, Strainer, Yello-Bowl®



Note: Strainer



Model 01050288P20

20 gpm / 75.7 lpm Shower,
Facewash with ABS Heads, &
Wye, Drench Hose, Yello-Bowl®

Model 01050288

30 gpm / 113.6 lpm Shower,
Facewash with ABS Heads, &
Wye, Drench Hose, Yello-Bowl®



Note: Drench Hose



Model 01050290P20

20 gpm / 75.7 lpm Shower,
Eyewash with ABS Heads &
Wye, Foot Treadle, Yello-Bowl®

Model 01050290

30 gpm / 113.6 lpm Shower,
Eyewash with ABS Heads &
Wye, Foot Treadle, Yello-Bowl®



Note: Foot Treadle



Model 01050217P20PBC

20 gpm / 75.7 lpm Shower,
Eyewash with Acetal Heads
& BCP Wye, Plastic Bowl
Cover, Yello-Bowl®

Model 01050217PBC

30 gpm / 113.6 lpm Shower,
Eyewash with Acetal Heads
& BCP Wye, Plastic Bowl
Cover, Yello-Bowl®



Note: Low profile Eyewash assembly



Combination Showers Eyewash/Facewash

Galvanized Piping

Model 01050266P20PBC

20 gpm / 75.7 lpm Shower,
Facewash with ABS Heads
& BCP Wye, Strainer, Plastic
Bowl Cover, Yello-Bowl®

Model 01050266PBC

30 gpm / 113.6 lpm Shower,
Facewash with ABS Heads
& BCP Wye, Strainer, Plastic
Bowl Cover, Yello-Bowl®



Note: Low profile BCP Wye assembly and
Plastic bowl cover



Model 01050230P20

20 gpm / 75.7 lpm Shower,
Eyewash with Acetal Heads
& BCP Wye, SS Bowl

Model 01050230

30 gpm / 113.6 lpm Shower,
Eyewash with Acetal Heads
& BCP Wye, SS Bowl



Note: Stainless Steel Bowl



Model 01050234P20

20 gpm / 75.7 lpm Shower,
Facewash with ABS Heads &
BCP Wye, SS Bowl

Model 01050234

30 gpm / 113.6 lpm Shower,
Facewash with ABS Heads &
BCP Wye, SS Bowl



Model 01050281P20

20 gpm / 75.7 lpm Shower,
Eyewash with Acetal Heads
& BCP Wye, SS Bowl, Foot
Treadle

Model 01050281

30 gpm / 113.6 lpm Shower,
Eyewash with Acetal Heads
& BCP Wye, SS Bowl, Foot
Treadle



Combination Showers Eyewash/Facewash

Galvanized Piping

Model 01050293P20

20 gpm / 75.7 lpm Shower,
Facewash with ABS Heads
& BCP Wye, SS Bowl, Foot
Treadle

Model 01050293

30 gpm / 113.6 lpm Shower,
Facewash with ABS Heads
& BCP Wye, SS Bowl, Foot
Treadle



Model 01050230P20PBC

20 gpm / 75.7 lpm Shower,
Eyewash with Acetal Heads
& BCP Wye, SS Bowl, Plastic
Bowl Cover

Model 01050230PBC

30 gpm / 113.6 lpm Shower,
Eyewash with Acetal Heads
& BCP Wye, SS Bowl, Plastic
Bowl Cover



Model 01050234P20PBC

20 gpm / 75.7 lpm Shower,
Facewash with ABS Heads & BCP
Wye, SS Bowl, Plastic Bowl Cover

Model 01050234PBC

30 gpm / 113.6 lpm Shower,
Facewash with ABS Heads & BCP
Wye, SS Bowl, Plastic Bowl Cover



Model 01050234P20SBC

20 gpm / 75.7 lpm Shower,
Facewash with ABS Heads & BCP
Wye, SS Bowl & Bowl Cover

Model 01050234SBC

30 gpm / 113.6 lpm Shower,
Facewash with ABS Heads & BCP
Wye, SS Bowl & Bowl Cover



Note: Stainless Steel bowl with Plastic
bowl cover

Combination Showers Eyewash/Facewash

Galvanized Piping

Model 01050471S20SBC

20 gpm / 75.7 lpm SS Shower Head, Eyewash with Acetal Heads & BCP Wye, SS Bowl & Bowl Cover

Model 01050471SBC

30 gpm / 113.6 lpm SS Shower Head, Eyewash with Acetal Heads & BCP Wye, SS Bowl & Bowl Cover



Note: Stainless Steel bowl and cover



Model 01050221P20

20 gpm / 75.7 lpm Shower, Facewash with ABS Heads & Wye, No Bowl

Model 01050221

30 gpm / 113.6 lpm Shower, Facewash with ABS Heads & Wye, No Bowl



Note: 8 gpm / 30.3 lpm Facewash assembly with no bowl



Model 01050205P20

20 gpm / 75.7 lpm Shower, Eyewash with ABS Heads & Wye, No Bowl

Model 01050205

30 gpm / 113.6 lpm Shower, Eyewash with ABS Heads & Wye, No Bowl



Note: 3.2 gpm / 12.1 lpm Eyewash assembly with no bowl



Model 01050224P20

20 gpm / 75.7 lpm Shower, Facewash with ABS Heads & BCP Wye, No Bowl

Model 01050224

30 gpm / 113.6 lpm Shower, Facewash with ABS Heads & BCP Wye, No Bowl

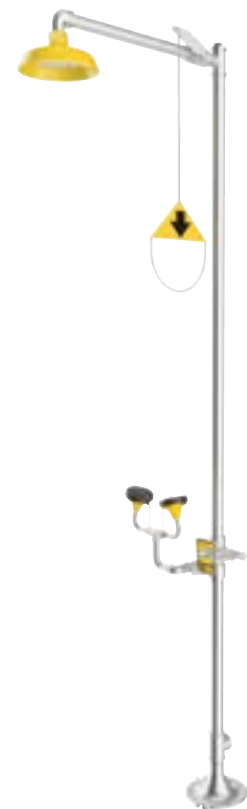

Combination Showers Eyewash/Facewash

Stainless Steel Piping

PIPING AND VALVE CHOICES

- Schedule 40, 304 Stainless Steel piping
- Stainless Steel ball valves & ball

SHIP WEIGHT

Shower — 59 lb / 26.76 kg

Shower with FTR — 61 lb / 27.66 kg

Shower with DH — 62 lb / 21.12 kg

Model 01050219P20

20 gpm / 75.7 lpm Shower,
Facewash with ABS Heads &
Wye, Yello-Bowl®

Model 01050219

30 gpm / 113.6 lpm Shower,
Facewash with ABS Heads &
Wye, Yello-Bowl®



Model 01050223P20

20 gpm / 75.7 lpm Shower,
Eyewash with ABS Heads &
Wye, Yello-Bowl®

Model 01050223

30 gpm / 113.6 lpm Shower,
Eyewash with ABS Heads &
Wye, Yello-Bowl®



Model 01050232P20

20 gpm / 75.7 lpm Shower,
Eyewash with Acetal Heads
& BCP Wye, SS Bowl

Model 01050232

30 gpm / 113.6 lpm Shower,
Eyewash with Acetal Heads
& BCP Wye, SS Bowl



Note: Every model in this section includes a 7" x 11" / 17.7 cm x 27.9 cm sign, part number 01112892. See signs on page 47.

Combination Showers Eyewash/Facewash

Stainless Steel Piping

Model 01050236P20

20 gpm / 75.7 lpm Shower,
Facewash with ABS Heads &
BCP Wye, SS Bowl

Model 01050236

30 gpm / 113.6 lpm Shower,
Facewash with ABS Heads &
BCP Wye, SS Bowl



Model 01050236P20SBC

20 gpm / 75.7 lpm Shower,
Facewash with ABS Heads & BCP
Wye, SS Bowl, SS Bowl Cover

Model 01050236SBC

30 gpm / 113.6 lpm Shower,
Facewash with ABS Heads & BCP
Wye, SS Bowl, SS Bowl Cover



Model 01050264S20

20 gpm / 75.7 lpm SS
Shower Head, Eyewash with
SS Heads & Wye, SS Bowl

Model 01050264

30 gpm / 113.6 lpm SS
Shower Head, Eyewash with
SS Heads & Wye, SS Bowl



Note: 2.5 gpm / 9.5 lpm Stainless
Steel Eyewash assembly



Model 01050470S20

20 gpm / 75.7 lpm SS
Shower Head, Eyewash with
SS Heads & Wye, SS Bowl,
Foot Treadle

Model 01050470

30 gpm / 113.6 lpm SS
Shower Head, Eyewash with
SS Heads & Wye, SS Bowl,
Foot Treadle



Combination Showers Eyewash/Facewash

PVC Piping

PIPING AND VALVE CHOICES

- Schedule 80 corrosion-resistant PVC piping with socket weld joints
- Corrosion-resistant coated bronze ball valves with chrome plated ball

SHIP WEIGHT

Shower — 34 lb / 15.42 kg



Model 01060022

20 gpm / 75.7 lpm Shower, Eyewash with ABS Heads & Wye, Yello-Bowl®, Free Standing

Model 01060021

30 gpm / 113.6 lpm Shower, Eyewash with ABS Heads & Wye, Yello-Bowl®, Free Standing



Note: Supported overhead section for free-stand mounting.

Model 01060007P20

20 gpm / 75.7 lpm Shower, Eyewash with ABS Heads & Wye, Yello-Bowl®, Wall Flange Support

Model 01060007

30 gpm / 113.6 lpm Shower, Eyewash with ABS Heads & Wye, Yello-Bowl®, Wall Flange Support



Model 01060009P20

20 gpm / 75.7 lpm Shower, Facewash with ABS Heads & Wye, Yello-Bowl®, Wall Flange Support

Model 01060009

30 gpm / 113.6 lpm Shower, Facewash with ABS Heads & Wye, Yello-Bowl®, Wall Flange Support



Note: Every model in this section includes a 7" x 11" / 17.7 cm x 27.9 cm sign, part number 01112892. See signs on page 47.

Combination Showers Eyewash/Facewash

Corrosion-Resistant Coating

PIPING AND VALVE CHOICES

- Schedule 80, hot dipped galvanized steel piping with high visibility yellow corrosion-resistant coating
- Chrome plated bronze ball valves & ball

SHIP WEIGHT

Shower — 59 lb / 26.76 kg

Model 01050276

20 gpm / 75.7 lpm Shower, Eyewash with ABS Heads & Wye, Yello-Bowl®

Model 01050210

30 gpm / 113.6 lpm Shower, Eyewash with ABS Heads & Wye, Yello-Bowl®



Model 01050277

20 gpm / 75.7 lpm Shower, Facewash with ABS Heads & Wye, Yello-Bowl®

Model 01050228

30 gpm / 113.6 lpm Shower, Facewash with ABS Heads & Wye, Yello-Bowl®



Model 01050376

20 gpm / 75.7 lpm Shower, Eyewash with ABS Heads & Wye, Yello-Bowl®, Foot Treadle

Model 01050381

30 gpm / 113.6 lpm Shower, Eyewash with ABS Heads & Wye, Yello-Bowl®, Foot Treadle



Note: Every model in this section includes a 7" x 11" / 17.7 cm x 27.9 cm sign, part number 01112892. See signs on page 47.

Combination Showers Eyewash/Facewash

Vertical & Horizontal Showers

PIPING

- Mounts directly onto overhead pipe
- Available with galvanized or stainless steel piping (standard ball valve included assembly with actuation graphic)

SHIP WEIGHT

Horizontal Shower 1" / 2.5 cm supply — 8 lb / 3.62 kg

Vertical Shower 1" / 2.5 cm supply — 6 lb / 2.72 kg

Shower 1¼" / 3.2 cm supply — 11 lb / 4.98 kg



Model 01052522

20 gpm / 75.7 lpm Shower, 1" / 2.5 cm Horizontal Pipe Mount

Model 01052501

30 gpm / 113.6 lpm Shower, 1" / 2.5 cm Horizontal Pipe Mount



Model 01052524

20 gpm / 75.7 lpm Shower, 1" / 2.5 cm Vertical Pipe Mount

Model 01052502

30 gpm / 113.6 lpm Shower, 1" / 2.5 cm Vertical Pipe Mount



Model 01053001P20

20 gpm / 75.7 lpm Shower, 1¼" / 3.2 cm Horizontal Pipe Mount

Model 01053001

30 gpm / 113.6 lpm Shower, 1¼" / 3.2 cm Horizontal Pipe Mount



Note: Every model in this section includes a 7" x 11" / 17.7 cm x 27.9 cm sign, part number 01112891. See signs on page 47.



Encon® offers a complete line of **freeze-resistant showers and eyewash products** designed to **withstand subfreezing temperatures for brief periods**. Our freeze-resistant products utilize **temperature-sensitive valves** to circulate water during freezing periods and our **subsurface models** feature underground self-drain systems to **prevent freezing of exposed piping**.

- Schedule 80 hot dipped galvanized steel piping or schedule 40, 304 stainless steel piping
- Stay-open ball valves
- Stainless steel valve stems and actuators
- Actuation graphics
- Self-adjusting regulators
- Heads and Bowls available in high visibility yellow plastic or 304 stainless steel
- Eye and Facewash heads include hinged covers or float-off covers secured with stainless steel beads

ACCESSORY OPTIONS AVAILABLE ON MOST MODELS

- Bowl Cover: Available in yellow ABS plastic or 304 stainless steel
- Drench Hose for partial body flushing
- Step-on foot treadle for eye/facewash activation

Freeze-Resistant Showers

Freeze & Scald Protection Valves

FREEZE & SCALD VALVE OPTIONS

- Freeze Protection Valve: Opens automatically when internal temperature reaches 35°F / 2°C and closes at 40°F / 4.5°C
- Scald Protection Valve: Opens automatically when internal temperature reaches 105°F / 40.6°C and closes at 94°F / 34.4°C

SHIP WEIGHT

Automatic — 60 lb / 27.22 kg

Model 01050362P20

20 gpm / 75.7 lpm Shower, Eyewash with ABS Heads & Wye, Auto. Freeze & Scald Protection Valves, Galvanized Pipe

Model 01050362

30 gpm / 113.6 lpm Shower, Eyewash with ABS Heads & Wye, Auto. Freeze & Scald Protection Valves, Galvanized Pipe



Note: External drain temperature sensing valves

Model 01050317P20

20 gpm / 75.7 lpm Shower, Eyewash with ABS Heads & Wye, Auto. Freeze Protection Valve, Galvanized Pipe

Model 01050317

30 gpm / 113.6 lpm Shower, Eyewash with ABS Heads & Wye, Auto. Freeze Protection Valve, Galvanized Pipe



Note: Temperature sensing valve with drain back to pipe stanchion

Model 01050314P20

20 gpm / 75.7 lpm Shower, Eyewash with ABS Heads & Wye, Auto. Freeze Protection Valve, Drench Hose, Galvanized Pipe

Model 01050314

30 gpm / 113.6 lpm Shower, Eyewash with ABS Heads & Wye, Auto. Freeze Protection Valve, Drench Hose, Galvanized Pipe



Note: Drench hose



Note: Every model in this section includes a 7" x 11" / 17.7 cm x 27.9 cm sign, part number 01112892. See signs on page 47.

Freeze-Resistant Showers

Subsurface Showers & Eye/Facewash

AUTOMATIC DRAIN

Water drains from exposed piping to help prevent freezing.

SHIP WEIGHT

Subsurface Combination Shower — 115 lb / 52.16 kg

Subsurface Shower — 75 lb / 34.02 kg

Subsurface Eyewash — 40 lb / 18.14 kg

Model FRSSC-GP20

20 gpm / 75.7 lpm Shower,
Eyewash with ABS Heads &
Wye, Galvanized Pipe

Model FRSSC-G

30 gpm / 113.6 lpm Shower,
Eyewash with ABS Heads &
Wye, Galvanized Pipe

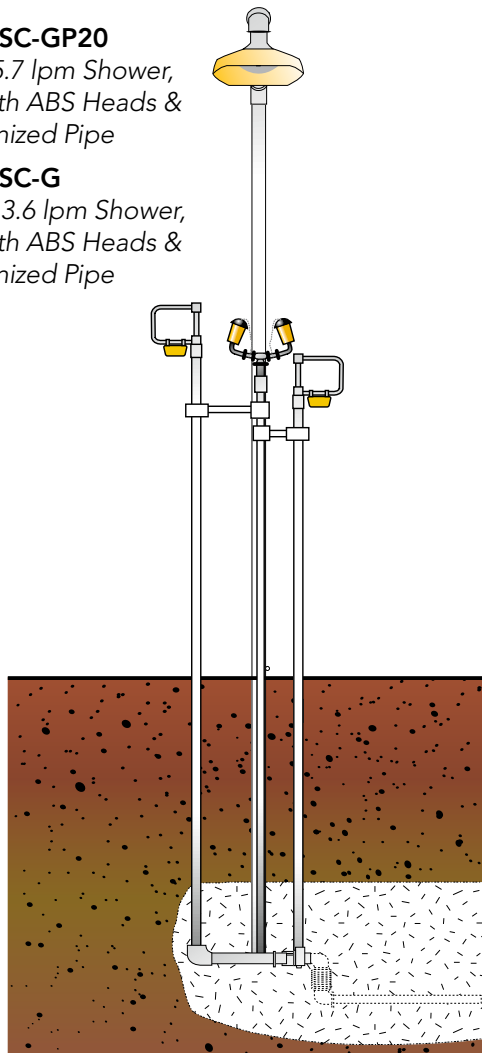

Model 01050201P20

20 gpm / 75.7 lpm Shower,
Galvanized Pipe

Model 01050201

30 gpm / 113.6 lpm Shower,
Galvanized Pipe

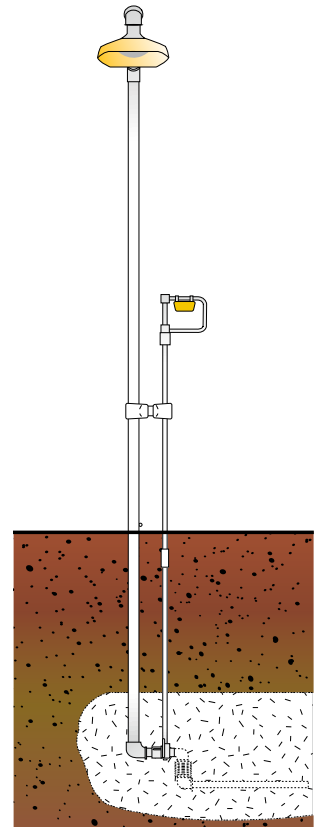

Model 01030104

Eyewash with ABS Heads &
Wye, Galvanized Pipe

Model 01035604

Facewash, ABS Heads &
Wye & Galvanized Pipe

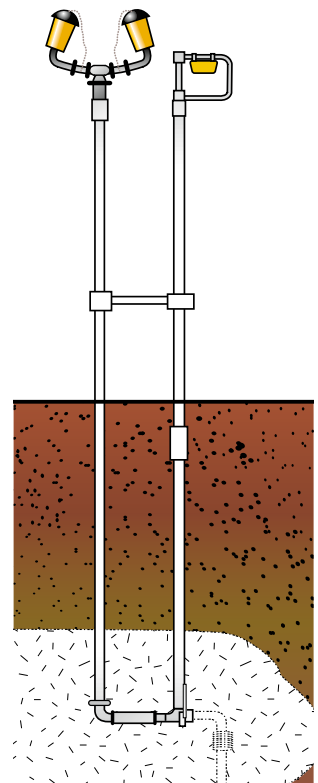

Note: Every model in this section includes a 7" x 11" / 17.7 cm x 27.9 cm sign, part number 01112892. See signs on page 47.

Freeze-Resistant Showers

Through-Wall Shower & Eyewash

AUTOMATIC DRAIN

Water drains from exposed piping to help prevent freezing

SHIP WEIGHT

Shower — 38 lb / 17.24 kg

Eye/Facewash — 9 lb / 4.08 kg

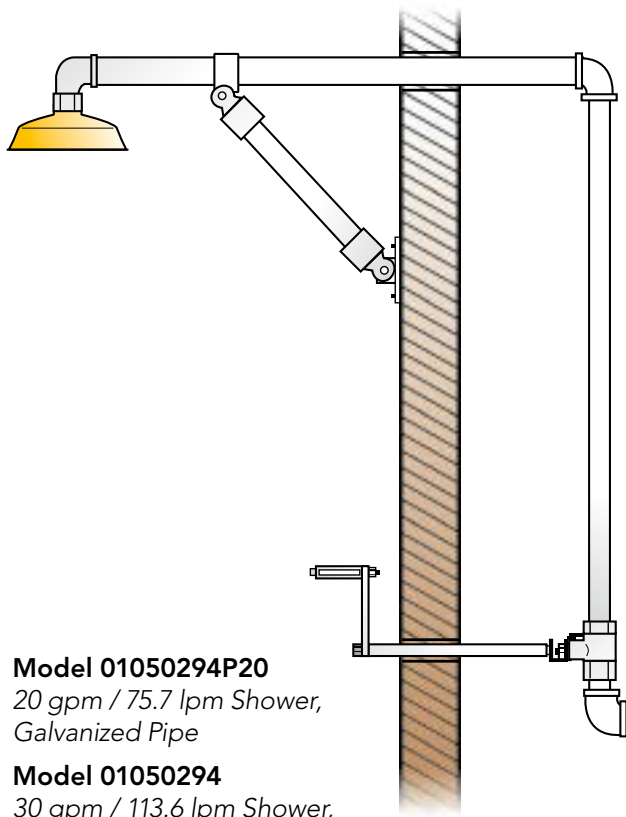

Model 01050294P20

20 gpm / 75.7 lpm Shower,
Galvanized Pipe

Model 01050294

30 gpm / 113.6 lpm Shower,
Galvanized Pipe

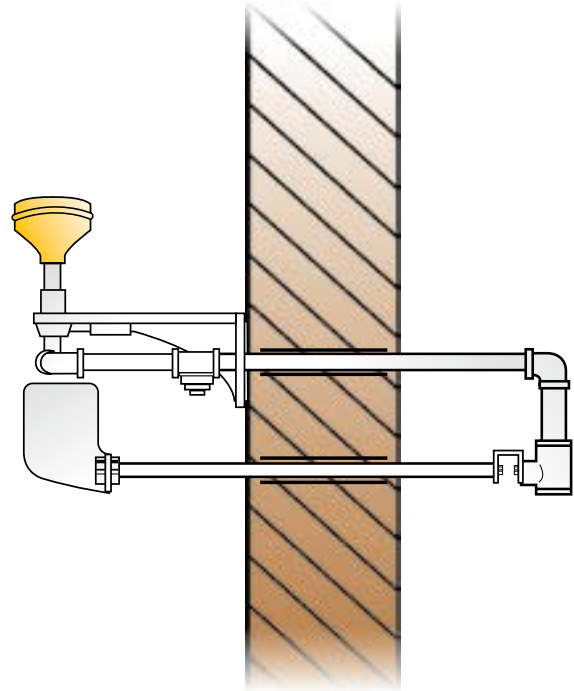

Model 01035606

Facewash with ABS Heads,
Wye & Galvanized Pipe

Model 01030106

Eyewash, ABS Heads,
Galvanized Pipe



Note: Every model in this section includes a 7" x 11" / 17.7 cm x 27.9 cm sign, part number 01112891. See signs on page 47.

NOTE: Allow minimum of 16" / 40.6 cm lateral clearance between shower and eyewash target areas for actuator arm movement.



Extend your safety perimeter. For areas where **plumbed potable water is not readily available**, Encon® offers a wide array of choices for self-contained emergency eyewash stations, including pressurized, gravity-fed, and sealed-cartridge units. Encon's self-contained eyewash stations meet **ANSI Z358.1-2014 requirements for emergency eyewash equipment**. Additionally, the Firststep® FirstFlush® station and the 5 Gallon / 22 Liter pressurized self-contained unit meet ANSI Z358.1-2014 standard for personal flushing equipment.

GRAVITY FEDS

- Durable Polyethylene body
- 0.4 gpm / 1.5 L ABS plastic dual-stream eyewash nozzles
- Pull-down tray for eyewash nozzle activation
- Instructions located on front graphics. Available in English, Spanish, and French/Canadian where noted
- CSA approved heated models with UL & FM components

PRESSURIZED PORTABLES

- 304 stainless steel ASME rated, CRN registered vessel
- ½" / 1.3 cm brass chrome-plated piping with stay-open ball valve
- Stainless steel valve stem and actuator
- Actuation graphics
- Self-adjusting regulator
- Brass relief valve opens at 115 PSI
- Custom face pressure gauge
- Drench Hose option available with self-closing, lock-open handle

ACCESSORY OPTIONS AVAILABLE ON MOST MODELS

- Insulating jacket and thermostat controlled heater
- Transport cart: Yellow tubular steel (gravity fed) or yellow polyethylene with strap (pressurized portable)
- Waste receptacle

Self-Contained

Aquarion®

The Aquarion® offers the sealed flexible cartridge that completely self-evacuates without external forces being applied, providing reliable performance when you need it most.

- High visibility yellow ABS removable cover
- Tinted translucent ABS side windows for internal visual inspection
- Black ABS base slides onto the Back Plate
- Gray retracting tray to protect the enclosed eyewash nozzles from the environment
- Preserved saline solution in individual bags

SHIP WEIGHT

23 lb / 12.7 kg Unit

75 lb / 34.02 kg AQ120 fluid cartridges

37 lb / 16.78 kg AQ110 fluid cartridges

TRANSPORT CART (Optional)

Yellow tubular steel with wheels

Weight — 66 lb / 22.94 kg

WASTE RECEPTACLE (Optional)

Weight — 14 lb / 6.35 kg

AQUARION®

Model AQ120
*Preserved Saline Solution Fluid Cartridges**

Model AQ110
*Sterile Saline Solution Fluid Cartridges***

Model AQ111
User Fillable Cartridges



Note: *Not available in Canada & Mexico
**Available only in Canada



Model AQ100
Aquarion® Self-Contained Eyewash

Model AQ100S
Aquarion® Self-Contained Eyewash - Spanish



Model AQ100H130
Heated Aquarion® Self-Contained Eyewash

Helios® Gravity Fed

Helios® has one of the sleekest profile of self-contained products available allowing simple installation and use in a tighter, smaller area close to facility hazards.

- High visibility yellow polyethylene tank
- Internal, rotating actuating valve integral to the eye wash tray
- Eyewash Heads inset directly into the black pull-down tray offering protection from airborne particulate
- Molded eyelet hangers for mounting
- Mounting bracket available. See page 51.

SHIP WEIGHT
15 lb / 6.8 kg



Model HS100
*Helios® Gravity Fed
Eyewash - Spanish*

Model HF100
*Helios® Gravity Fed
Eyewash - French*



Model HE100
*Helios® Gravity Fed
Eyewash*



Model 01110764
*A case reorder of
Hydrosep® includes
four 8 oz. / 236.6 mL
bottles.*

Self-Contained

Gravity Fed

With its fillable tank design, the Self-Contained Gravity Fed has proven to be a reliable safety eyewash unit.

- High visibility yellow polyethylene tank; two carrying handles.
- Enclosed eyewash heads integral to hinged drain tray.

SHIP WEIGHT
32 lb / 14.52 kg

TRANSPORT CART (Optional)
Yellow tubular steel with wheels
Weight — 66 lb / 22.94 kg

WASTE RECEPTACLE (Optional)
Weight — 14 lb / 6.35 kg

Model 01104070
*Hazardous Area
C1D2 Gp. BCD
Heated Gravity
Fed Eyewash*



Model 01104050
*Self-Contained Gravity
Fed Eyewash*

Model 01104050S
*Self-Contained Gravity
Fed Eyewash - Spanish*

Model 01104050C
*Self-Contained Gravity
Fed Eyewash - French*



Model 01104055
*Gravity Fed
Eyewash with
Transport Cart and
Waste Receptacle*

Model 00015006
Receptacle Lid

Standard Pressurized Portable Eyewash

The large water fill opening, convenient air fill stem and customized fill indicator pressure gauge makes the standard pressurized portables easy to maintain.

- 13 Gallon / 57.2 Liter capacity; ASME, Div. VIII, Section 1 rated, and CRN registered vessel
- Heated option maintained at a temperature between 60-90°F / 15.5-32.2°C

SHIP WEIGHT

32 lb / 14.52 kg

34 lb / 15.42 kg with Drench Hose

YELLOW CART (Optional)

Yellow polyethylene w/wheels & strap

Weight — 26.8 lb / 12.16 kg

Model 01103004

13 Gallon / 57.2 Liter,
Socket Mount Eyewash
with 8' / 2.4 m Hose,
Heated 120 VAC

Model 01103006

13 Gallon / 57.2 Liter,
Socket Mount Eyewash
with 8' / 2.4 m Hose,
Heated 120 VAC, C1D2 Gr.
BCD



Model 01104002

13 Gallon / 57.2 Liter,
Fixed Eyewash with
handheld 8' / 2.4 m
Drench Hose

Model 01103002

13 Gallon / 57.2 Liter,
Socket Mount Eyewash
with 8' / 2.4 m Hose



Model 01103008

Transport cart only
(Eyewash station
not included)



Self-Contained

Large Pressurized Portable Eyewash

The large 37 Gallon / 162.9 Liter tank allows you the freedom to set up a dependable pressurized eyewash and drench station where you need it most.

- 37 Gallon / 162.9 Liter is ASME, Div. VIII, Section 1 rated, and CRN registered vessel

SHIP WEIGHT
160 lb / 72.6 kg

DOLLY CART
Green tubular steel with wheels and retaining chains
Weight — 30 lb / 13.61 kg

Model 01106002
37 Gallon / 162.9
Liter Eyewash &
Drench Hose



Model 01106001

37 Gallon / 162.9 Liter Eyewash with Drench Hose & Dolly cart



Model 01106004
37 Gallon / 162.9 Liter
Eyewash with Drench
Hose, Insulation &
Heat Reflective Jacket



Personal Flushing Stations

Firststep® Firstflush®

- 32 oz. / 946 mL Sterile buffered isotonic saline solution
- Highly visible yellow ABS plastic holder with operational instructions; vibration and UV resistant
- HDPE, durable, non-resealable bottle

SHIP WEIGHT

Single — 20 lb / 9.07 kg

Dual — 20 lb / 9.07 kg

Personal Pressurized Portable

- 5 Gallon / 22 Liter capacity; 25" x 8¼" / 63 cm x 21 cm with carrying handles

SHIP WEIGHT

15 lb / 6.8 kg

Model 01103001

5 Gallon / 22 Liter Personal Pressurized Portable, Socket Mount Nozzles, 8' / 2.4 m Coil Hose



Model 01110786S

Firststep® FirstFlush® Single Station Units

Model 01110793S

Firststep® FirstFlush® Dual Station Units



Model 01101001

5 Gallon / 22 Liter Personal Pressurized Portable, 8' / 2.4 m Coiled Drench Hose





The Eyewash & Facewash station is most appropriate in areas where **hazards to the eyes and face** are most common. Our Eyewash & Facewash units are designed for ease of installation to your facility's **plumbed water supply**. We offer **installation options to a wall, a supply-pipe, or a pedestal** to facilitate installations nearest to those areas where exposure can occur. **Don't forget a bowl cover to keep dirt and debris away from the eye/facewash.**

- 1/2" / 1.3 cm Stay-open ball valve
- Stainless steel valve stem and Push Plate actuator
- Actuation graphics
- Self-adjusting regulator
- Heads and Bowls available in high visibility yellow plastic or 304 stainless steel
- Eye and Facewash heads include hinged covers or float-off covers secured with stainless steel beads
- 1/2" / 1.3 cm NPT Supply connection

ACCESSORY OPTIONS AVAILABLE ON MOST MODELS

- **Bowl Cover:** Available in yellow ABS plastic or 304 stainless steel. Cover is opened by push plate and manually closed.
- **Drench Hose:** For partial body flushing. 6' / 1.8 m synthetic rubber hose assembly, mounting bracket, yellow ABS single stream head with float-off cover, self-closing lock-open squeeze handle actuator.
- **Foot Treadle:** Yellow ABS plastic step-on treadle with stainless steel chain for eye/facewash activation.

Eyewash & Facewash

Wall Mount

BOWL WASTE CHOICES

- Yello-Bowl® — 1¼" x 6" / 3.2 cm x 15.2 cm slip joint tailpiece
- 304 SS Bowl — 1¼" / 3.2 cm NPT connection
- P-trap — 1¼" / 3.2 cm tube connection

SHIP WEIGHT

Wall Mount SS Bowl — 9 lb / 4.08 kg

Wall Mount Yello-Bowl® — 6 lb / 2.72 kg



Model 01030403

Eyewash, ABS Heads & Wye, Yello-Bowl®, Wall Bracket, BCP Pipe & Valve, Strainer

Model 01035503

Facewash, ABS Heads & Wye, Yello-Bowl®, Wall Bracket, BCP Pipe & Valve, Strainer



Note: Strainer



Model 01030401

Eyewash, ABS Heads and Wye, BCP Pipe & Valve, Yello-Bowl®, Wall Bracket

Model 01035501

Facewash, ABS Heads and Wye, BCP Pipe & Valve, Yello-Bowl®, Wall Bracket



Model 01030416

Eyewash, Acetal Heads, BCP Wye, Yello-Bowl®, Wall Bracket, BCP Pipe & Valve, Strainer

Model 01035511

Facewash, ABS Heads, BCP Wye, Yello-Bowl®, Wall Bracket, BCP Pipe & Valve, Strainer



Note: 2.4 gpm / 9.1 lpm Acetal eyewash heads. Bowl covers are available on models with BCP Wye. See bowl covered model on page 28.



Note: Every model in this section includes a 7" x 11" / 17.7 cm x 27.9 cm sign, part number 01112893. See signs on page 47.

Eyewash & Facewash

Wall Mount



Model 01045001
Eyewash, Acetal Heads & BCP
Wye, BCP Pipe & Valve, SS
Bowl, Wall Bracket

Model 01045501
Facewash, ABS Heads & BCP
Wye, BCP Pipe & Valve, SS
Bowl, Wall Bracket



Model 01045001PBC
Eyewash, Acetal Heads, BCP
Wye, SS Bowl, Plastic Bowl
Cover, Wall Bracket

Model 01045501PBC
Facewash, ABS Heads, BCP
Wye, SS Bowl, Plastic Bowl
Cover, Wall Bracket



Model 01045501SBC
Facewash, ABS Heads & Low
Profile BCP Wye, BCP Pipe &
Valve, SS Bowl & Cover, Wall
Bracket

Model 01045001SBC
Eyewash, Acetal Heads, BCP
Wye, SS Bowl & Bowl Cover,
Wall Bracket



Model 01045010
Eyewash, Acetal Heads, BCP
Wye, SS Bowl, Wall Bracket,
BCP Pipe & Valve, P-Trap

Model 01045510
Facewash, ABS Heads, BCP
Wye, SS Bowl, Wall Bracket,
BCP Pipe & Valve, P-Trap

Eyewash & Facewash

Supply Pipe Mount

BOWL WASTE CHOICES

- Yello-Bowl® — 1¼" x 6" / 3.2 cm x 15.2 cm slip joint tailpiece
- 304 SS Bowl — 1¼" / 3.2 cm tube connection

SHIP WEIGHT

- Supply Mount Yello-Bowl® — 6 lb / 2.72 kg
- Supply Mount SS Bowl — 9 lb / 4.08 kg



Model 01045505

Facewash, ABS Heads & BCP Wye, BCP Pipe & Valve, SS Bowl

Model 01045005

Eyewash, Acetal Heads, BCP Wye, SS Bowl, BCP Pipe & Valve



Model 01030301

Eyewash, ABS Heads & Wye, BCP Pipe & Valve, Yello-Bowl®

Model 01035401

Facewash, ABS Heads & Wye, BCP Pipe & Valve, Yello-Bowl®



Model 01038301

Eyewash, ABS Heads & Wye, Yello-Bowl®, PVC Pipe & Valve

Model 01038801

Facewash, ABS Heads & Wye, Yello-Bowl®, PVC Pipe & Valve



Note: Every model in this section includes a 7" x 11" / 17.7 cm x 27.9 cm sign, part number 01112893. See signs on page 47.

Eyewash & Facewash

Supply Pipe Mount



Model 01035601
Facewash, ABS Heads
& Wye, No Bowl, BCP
Pipe & Valve

Model 01030101
Eyewash, ABS Heads
& Wye, No Bowl, BCP
Pipe & Valve



Model 01035603
Facewash, ABS Heads
& Wye, No Bowl, BCP
Pipe & Valve, Strainer

Model 01030103
Eyewash, ABS Heads
& Wye, No Bowl, BCP
Pipe & Valve, Strainer



Model 01045601
Facewash, ABS Heads &
BCP Wye, No Bowl, BCP
Pipe & Valve

Model 01040103
Eyewash, Acetal Heads,
BCP Wye, No Bowl, BCP
Pipe & Valve



Model 01040135
Eyewash, SS Heads & Wye,
No Bowl, SS Pipe & Valve

Model 01114021
Facewash, SS Heads & Wye,
No Bowl, SS Pipe & Valve

Eyewash & Facewash

Pedestal Mount

Schedule 80 galvanized pedestal.

WASTE

- 1¼" / 3.2 cm NPT connection

SHIP WEIGHT

Pedestal Mount — 25 lb / 11.34 kg



Model 01030302

Eyewash with ABS Heads & Wye, BCP Pipe & Valve, Yello-Bowl®

Model 01035402

Facewash with ABS Heads & Wye, BCP Pipe & Valve, Yello-Bowl®

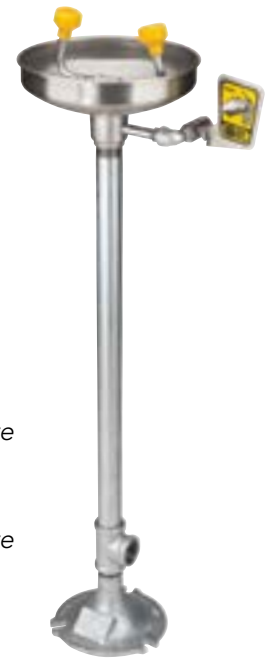

Model 01045002

Eyewash, Acetal Heads, BCP Wye, SS Bowl, BCP Pipe & Valve

Model 01045502

Facewash, ABS Heads, BCP Wye, SS Bowl, BCP Pipe & Valve



Model 01045002SBC

Eyewash, Acetal Heads, BCP Wye, SS Bowl & Bowl Cover, BCP Pipe & Valve

Model 01045502SBC

Facewash, ABS Heads, BCP Wye, SS Bowl & Bowl Cover, BCP Pipe & Valve



Note: Every model in this section includes a 7" x 11" / 17.7 cm x 27.9 cm sign, part number 01112893. See signs on page 47.

Eyewash & Facewash

Pedestal Mount



Model 01030316PBC
Eyewash, Acetal Heads,
BCP Wye, Yello-Bowl®,
Plastic Bowl Cover, BCP
Pipe & Valve

Model 01035415PBC
Facewash, ABS Heads,
BCP Wye, Yello-Bowl®,
Plastic Bowl Cover, BCP
Pipe & Valve



Model 01045006
Eyewash, Acetal Heads,
BCP Wye, SS Bowl,
BCP Pipe & Valve, Foot
Treadle

Model 01045506
Facewash, ABS Heads,
BCP Wye, SS Bowl,
BCP Pipe & Valve, Foot
Treadle



Model 01045008
Eyewash, Acetal Heads,
BCP Wye, SS Bowl, BCP
Pipe & Valve, Strainer

Model 01045514
Facewash, ABS Heads,
BCP Wye, SS Bowl, BCP
Pipe & Valve, Strainer



Model 01035410
Facewash, ABS Heads
& Wye, Yello-Bowl®,
BCP Pipe & Valve,
Drench Hose

Model 01030310
Eyewash, ABS Heads &
Wye, Yello-Bowl®, BCP
Pipe & Valve, Drench
Hose

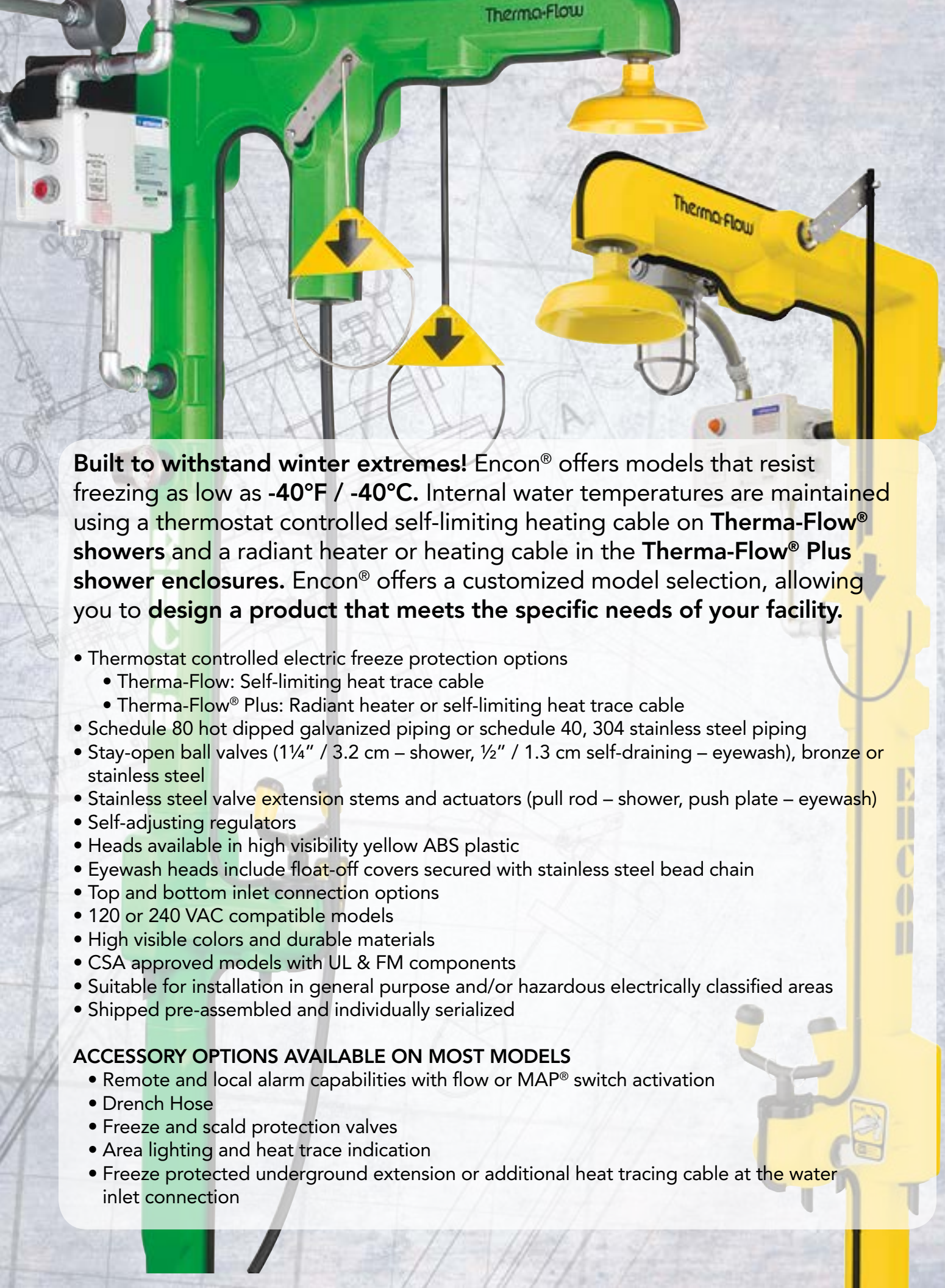

Built to withstand winter extremes! Encon® offers models that resist freezing as low as **-40°F / -40°C**. Internal water temperatures are maintained using a thermostat controlled self-limiting heating cable on **Therma-Flow® showers** and a radiant heater or heating cable in the **Therma-Flow® Plus shower enclosures**. Encon® offers a customized model selection, allowing you to **design a product that meets the specific needs of your facility**.

- Thermostat controlled electric freeze protection options
 - Therma-Flow: Self-limiting heat trace cable
 - Therma-Flow® Plus: Radiant heater or self-limiting heat trace cable
- Schedule 80 hot dipped galvanized piping or schedule 40, 304 stainless steel piping
- Stay-open ball valves (1¼" / 3.2 cm – shower, ½" / 1.3 cm self-draining – eyewash), bronze or stainless steel
- Stainless steel valve extension stems and actuators (pull rod – shower, push plate – eyewash)
- Self-adjusting regulators
- Heads available in high visibility yellow ABS plastic
- Eyewash heads include float-off covers secured with stainless steel bead chain
- Top and bottom inlet connection options
- 120 or 240 VAC compatible models
- High visible colors and durable materials
- CSA approved models with UL & FM components
- Suitable for installation in general purpose and/or hazardous electrically classified areas
- Shipped pre-assembled and individually serialized

ACCESSORY OPTIONS AVAILABLE ON MOST MODELS

- Remote and local alarm capabilities with flow or MAP® switch activation
- Drench Hose
- Freeze and scald protection valves
- Area lighting and heat trace indication
- Freeze protected underground extension or additional heat tracing cable at the water inlet connection

Freeze-Protected Showers

Therma-Flow[®] Freeze-Protected Showers

- Shower piping is heat traced and insulated, and includes high visibility covers
- Freeze protected to -40°F / -40°C in most applications
- Covers are field removable for field maintenance



Model TF35B5376300

20 gpm / 75.7 lpm Shower, Eyewash, C1D2 Gp. BCD, Green Area Light, Heat Trace Indicator, Freeze & Scald Protection Valves, Red Alarm Light & Horn, MAP[®] Switch, Yellow covers



Model TF36B2000302

20 gpm / 75.7 lpm Shower, Eyewash, C1D2 Gp. BCD, Heat Trace Indicator, MAP[®] Switch, Remote Alarm, Green covers



Model TF34B2300001

20 gpm / 75.7 lpm Shower, Eyewash, C1D2 Gp. BCD, Heat Trace Indicator, Freeze & Scald Protection Valves, Orange covers



Note: Every model in this section includes a 16½" x 6" / 41.1 cm x 15.2 cm sign, part number 35001810. See signs on page 46.

Freeze-Protected Showers

CUSTOM DESIGN YOUR THERMA-FLOW® SYSTEM

Create your model to meet the specific needs of your facility.

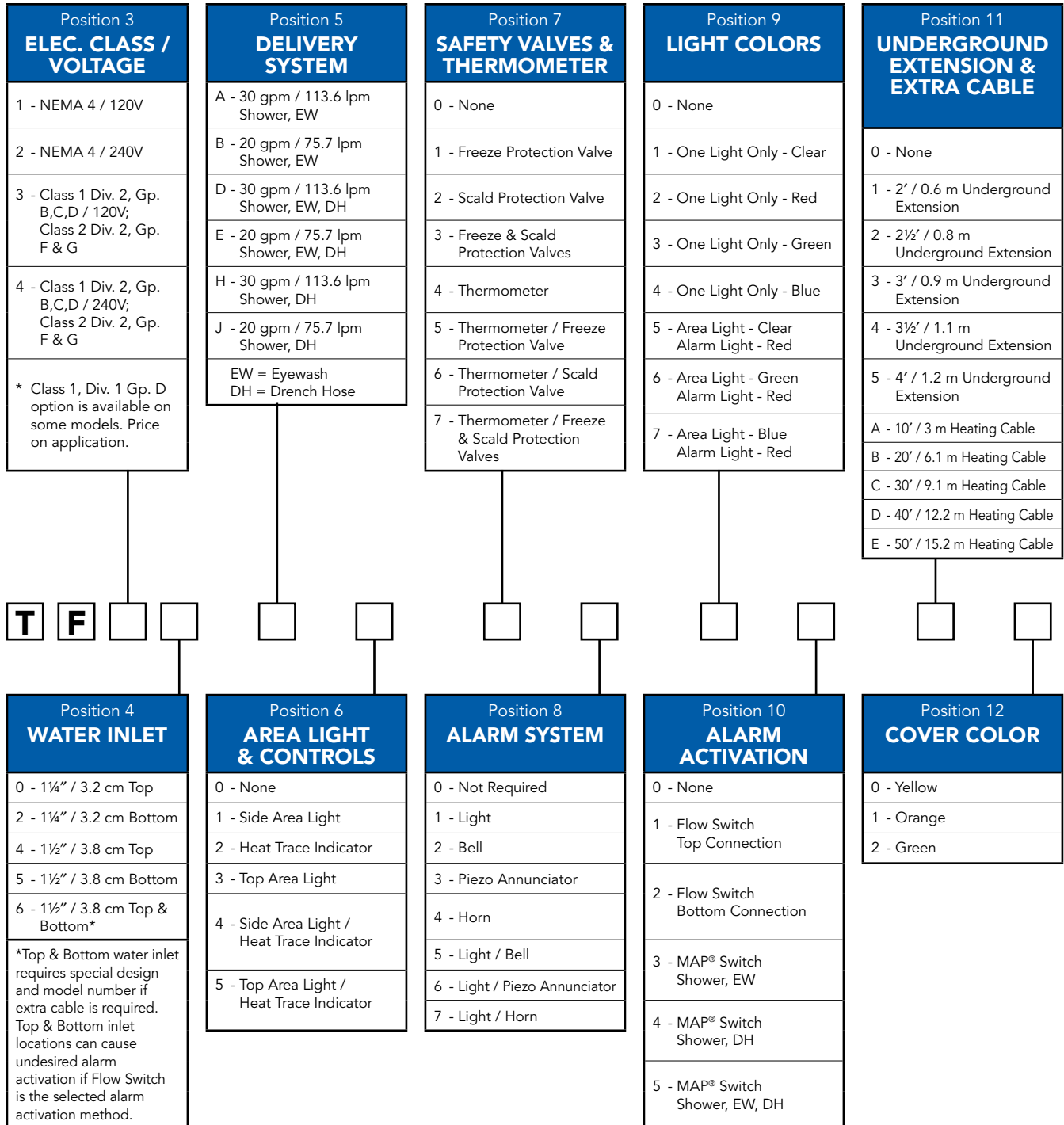

NOTES:

Position 8 - Options 3,6: The piezo annunciator (intermittent signal) is suitable for electrical classification up to Class 1 Div. 2 Gp. B only, not for use in

Class 1, Div. 1 applications. Includes reset button on audible alarm.

Position 11 - Underground Extension dimensions references length of pipe below grade.

Freeze-Protected Showers

Therma-Flow® PLUS Freeze-Protected Shower Enclosures

- Fully enclosed shower and eyewash
- Freeze protection provided by internal radiant heater or Therma-Flow® shower and eyewash
- Enclosure includes fire-retardant fiberglass reinforced plastic and urethane foam walls, chemical resistant UV inhibited gel coat finish, and adjustable double swinging doors with weather seals



Model TP21323230

Therma-Flow® 20 gpm / 75.7 lpm Shower, Eyewash, C1D2 Gp. BCD, Drench Hose, Red Lights & Bell, Green Area Light, Room Heater, Flow Switch

Fountain
Section
detail



Overhead
Section
detail



Freeze-Protected Showers

CUSTOM DESIGN YOUR SYSTEM

Create your model to meet the specific needs of your facility.

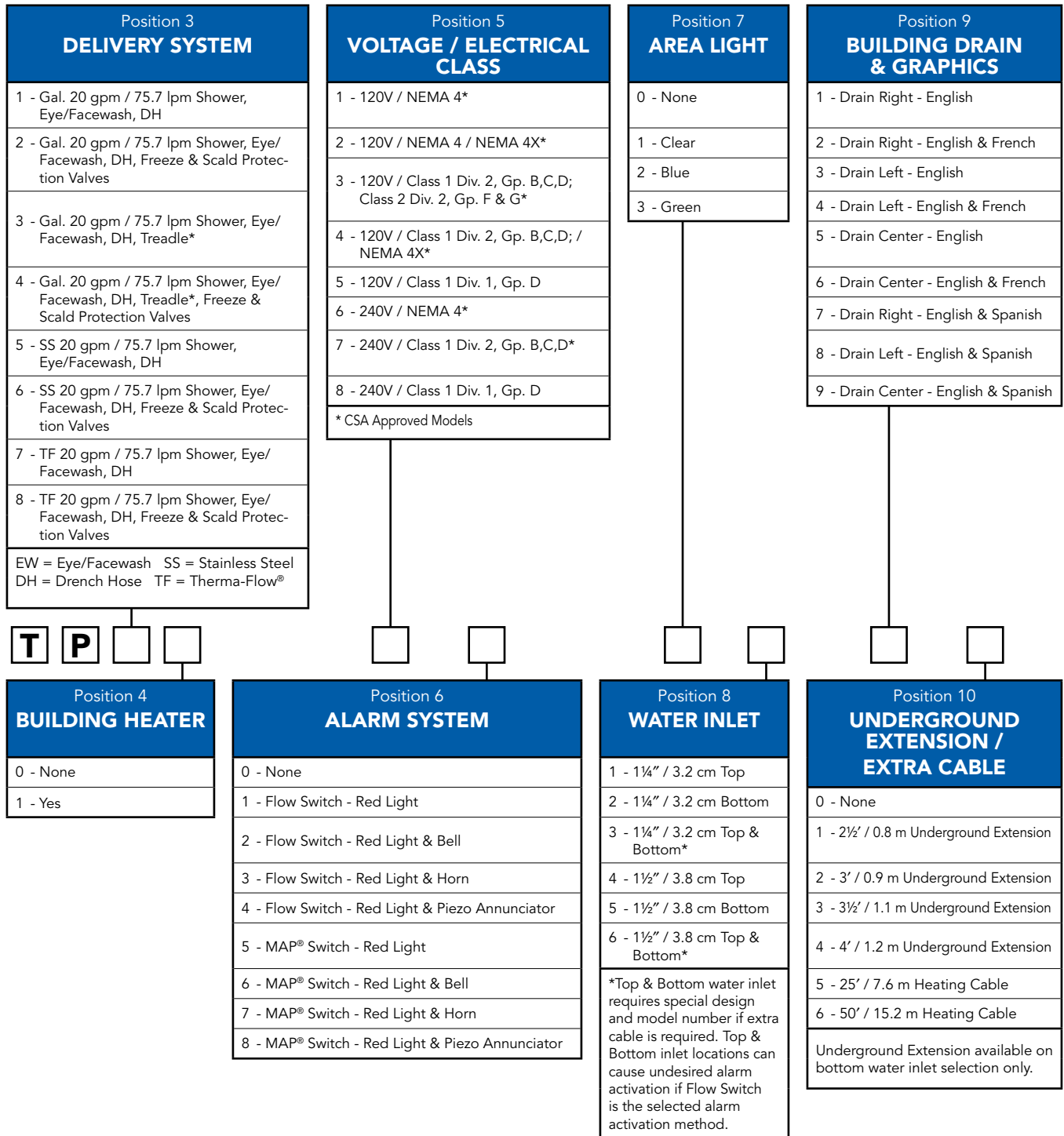

NOTES:

Position 3 - *Foot Treadle shall activate Eye/Facewash only.

Position 6 - Options 4, 8: The piezo annunciator (intermittent signal) is suitable for electrical classification up to Class

1 Div. 2 Gp. B only, not for use in Class 1, Div. 1 applications. Includes reset button on audible alarm.

Position 10 - Underground Extension dimensions references length of pipe below grade.



Tempered Water Systems from Encon® are deployed all over the world, from the frigid Canadian Oil Sands, to the salt-water soaked North Sea Oil Platforms, and in the scorching heat of the Texas Gulf Coast. Our systems are custom built and designed to provide water at temperatures and flow levels consistent with current **requirements for tepid potable water**. The central element of our tempered water systems is a blending system that is used to manage tepid water delivery and **developed with fail-safe mechanisms** for use in emergency shower and eyewash equipment. Our systems are **turnkey delivered** to the specific needs of your facility and can be optioned for electrical or steam heated water and then blended and driven with the addition of electrical water pumps or pressurized air if required.

- Systems provide tempered water according to standard requirements
- Various tempering and delivery system options available
- Fail-safe designs
- Indoor and freeze-protected outdoor models
- Schedule 80 hot dipped galvanized piping
- Available with shower and eyewash station included, or without to provide tempered water to separate stations in the facility loop
- Suitable for installation in general purpose and hazardous electrically classified areas
- CSA approved models with FM, UL, and CSA approved components
- Custom ordering system
- Ships pre-assembled and individually serialized

OPTIONS AVAILABLE ON MOST MODELS

- Freeze protection by thermostat controlled radiant heater for enclosed models
- Various local and remote alarm capabilities and alarm activation devices
- Custom engineered pump packages
- Corrosion-resistant coating for exposed piping and metal components
- High visibility color and signage options
- Area lighting
- Freeze-protected underground extension at the water inlet connection

Tempered Water Systems

Electrically Heated & Blended

- 120 Gallon, 30 gpm / 454.2 Liter, 113.6 lpm blending or 300 Gallon, 60 gpm / 1135.6 Liter, 227.1 lpm blending models
- Water delivered from electrically heated vessel and mixed with cold water through electrically controlled fail-safe blending system
- Target 85°F / 29.4°C outlet water
- Plumbed from local facility cold water supply

Custom Design Your System

Create your model to meet the specific needs of your facility



300 Gallon, 60 gpm / 1135.6 liter, 227.1 lpm electric blending system, Dual recirculation and booster pumps, skid mounted



120 Gallon, 30 gpm / 454.2 liter, 113.6 lpm electric blending system, Yellow corrosion-resistant coating, alarm, skid mounted

Wondering if customization is right for you? Call Encon Customer Service Representative with your questions or to place an order at 1-800-283-6266.

Tempered Water Systems

Air Driven

- 400 Gallon / 1514.2 Liter self-contained system
- Designed for areas where plumbed potable water is not always available
- Water delivered from electrically heated vessel at pressure supplied from compressed air cylinders, facility instrument or clean utility air
- Treated water stored at 85°F / 29.4°C
- Uses water from portable transport, temporary supply, or plumbed lines with insufficient volume and pressure

Custom Design Your System

Create your model to meet the specific needs of your facility

Air Driven 400 Gallon / 1514.2 Liter, Blue enclosure, Alarm Light and Horn



Air driven 400 Gallon / 1514.2 Liter, Shower & Eyewash, Grey corrosion-resistant coating, Stainless Steel Eyewash Bowl, Heat reflective tank cover, skid mounted



Air driven 400 Gallon / 1514.2 Liter, Horizontal tank, Stainless Steel Shower and Eyewash heads, Alarm Light and Horn



01110802
32 oz. / 946.4 mL
Hydrosep® included
with air-driven unit.
Reorder in case of
12. See page 51.

**Wondering if customization is right for you?
Call Encon Customer Service Representative with your
questions or to place an order at 1-800-283-6266.**

Tempered Water Systems

Steam Heated & Blended

- Water heated and delivered through a steam heat exchanger and mixed with cold water through a blending valve
- Redundant blending system included for fail-safe operation
- Target 85°F / 29.4°C outlet water
- Plumbed from local facility cold water supply and facility steam source

Custom Design Your System

Create your model to meet the specific needs of your facility



Steam heating, 60 gpm / 227.1 lpm
Electric Blending System, Dual
Recirculation Pumps, Single Booster
Pump, Yellow enclosure

Wondering if customization is right for you? Call Encon Customer Service Representative with your questions or to place an order at 1-800-283-6266.

Fail-Safe Blending

Saf-T-Flo® Fail-Safe Blending

- 30 and 60 gpm / 113.6 and 227.1 lpm models
- Target 85°F / 29.4°C outlet water
- Redundant solenoid valves for tempering control
- Fail-safe to cold-water bypass
- Temperature gauge included
- 120 or 240 VAC compatible models
- Bracket or corrosion-resistant case for wall mounting
- Heated wall case option available

PIPING CHOICES

- Galvanized with brass valves
- Polyurethane coated galvanized pipe and brass valves
- Copper with brass valves
- Stainless steel with stainless steel valves (available for 30 gpm / 113.6 lpm units only)

Model STF30WB120G

30 gpm / 113.6 lpm, Wall Bracket, Galvanized Pipe, Brass Valves, 120V



Model

STF60WB120G

60 gpm / 227.1 lpm, Wall Bracket, Galvanized Pipe, Brass Valves, 120V

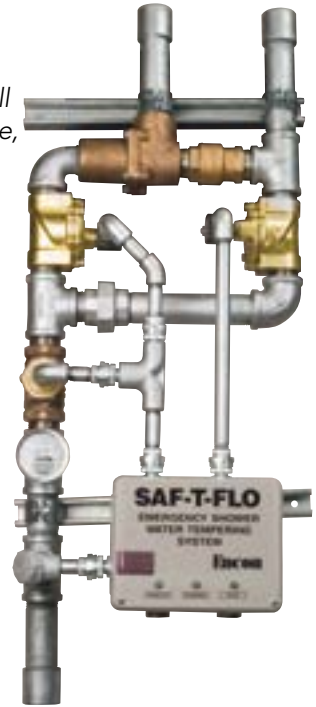

Model STF30WP120C

30 gpm / 113.6 lpm, Wall Case, Copper Pipe, Brass Valves, 120V

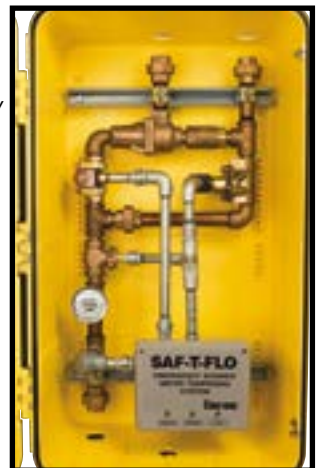

Alarm Systems & Lighting

STANDARD IN ALL SYSTEMS

Installation

For existing or new Shower stations to alert local and/or remote locations when in use

Remote Capability

Spare NO/NC "dry" contacts available on all alarm products; 120V, 3 amp rating on relay remote

WALL/SOWER MOUNT

- NEMA 3 rated
- Displays red blinking alarm light and rings bell when activated

SHOWER MOUNT OPTIONS

Light & Audio Alarm with Reset Switch

- Provides intermittent pulsing signal when activated; local reset button to silence the audible alarm

Visual Alarm

- Displays red blinking alarm light when activated

Area Light

- Provides constant illumination to emergency station when area vision is compromised; choice of clear, blue or green globe light

ACTIVATION DEVICE OPTIONS

Flow Switch*

- Detects flow through piping when emergency assembly activated; suitable for Class 1 Div. 2 Gp. B, C & D areas

MAP® Switch (Magnetic Activated Proximity Switch)

- Senses shower pull rod and/or push plate activation; Yello-Bowl®, SS bowl, or no bowl options available



Model 01052155
Wall/Shower Mount, Audio/Visual Alarm, Flow Switch

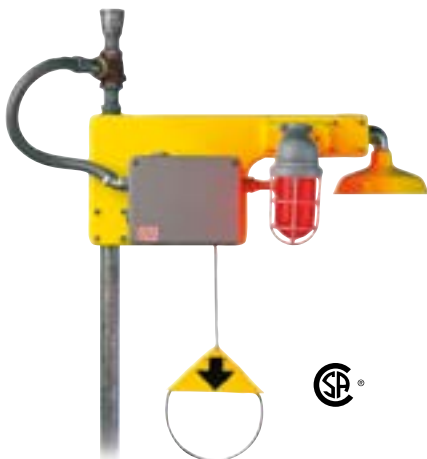

Model 02111000
Audible Alarm, Red Alarm Light, contacts for remote, Flow Switch

Shower Mount Model Number Generator

	Activation Device	Audible Alarm	Visual Alarm	Area Light
No	0	No 0	No 0	No 0
Flow Switch	1	Yes 1	Yes 1	Yes Clear Globe 1
MAP® Switch for Yello-Bowl® & No Bowl Models	2			Yes Blue Globe 2
MAP® Switch for Stainless Steel Bowl Models	3			Yes Green Globe 3

Model #: 02- ___ - ___ - ___ -00

*Flow switch systems include flexible conduit for top water entry systems. Midpoint or lower-water entry systems require additional conduit and field assembly by others.

Accessories and Parts

Alarm Systems & Lighting



Model 02200000
Remote alarm contacts only, MAP®
switch

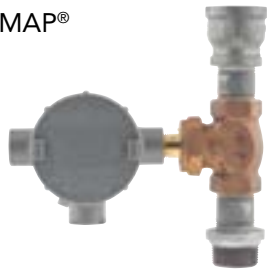

Model 02100000
Remote alarm contacts only, flow switch

Model 02000200
Area Light only, blue



Model 02000300
Area Light only, green



Model 02211300
Audible Alarm, Red Alarm Light, remote
contacts, MAP® switch, Green Area Light



Model 02311000 240
Audible Alarm, Red Alarm Light, remote
contacts, MAP® switch

AWARENESS 100™ Signage

High visibility graphics and reflective strip on chemical resistant ABS plastic shell.

MOUNTING CHOICES

- Pipe Mount
Includes plastic snap rivets for easy and secure mounting on piping stanchion.
- Wall Mount
Suitable for wall mounting above fountains or below shower (hardware not included).

GRAPHIC CHOICES

- Shower/Eyewash Icons
- Shower/Shower Icons
- Eyewash/Eyewash Icons

DIMENSIONS

- 6½" x 4" x 20" / 16.5 cm x 10.1 cm x 50.8 cm

SHIP WEIGHT

- 5 lb / 2.27 kg



Model 00113003

AWARENESS 100™ Sign
Orange, Black Shower/Shower, Pipe Mount

Model 00113000

AWARENESS 100™ Sign
Yellow, Black Shower/Shower, Pipe Mount

Model 00113006

AWARENESS 100™ Sign
Green, White Shower/Shower, Pipe Mount



Model 00113001

AWARENESS 100™ Sign
Yellow, Black Shower/Eyewash, Pipe Mount

Model 00113007

AWARENESS 100™ Sign
Green, White Shower/Eyewash, Pipe Mount

Model 00113004

AWARENESS 100™ Sign
Orange, Black Shower/Eyewash, Pipe Mount



Model 00113017

AWARENESS 100™ Sign
Green, White Eyewash/Eyewash, Wall Mount

Model 00113011

AWARENESS 100™ Sign
Yellow, Black Eyewash/Eyewash, Wall Mount

Model 00113014

AWARENESS 100™ Sign
Orange, Black Eyewash/Eyewash, Wall Mount

Accessories and Parts

AWARENESS® & AWARENESS 360™ Signage

AWARENESS® 360™

High visibility graphics on chemical resistant ABS plastic shell.

MOUNTING

Mounts directly onto shower piping above shower hood.

DIMENSIONS

- 16½" x 6" / 41.1 cm x 15.2 cm

SHIP WEIGHT

5 lb / 2.27 kg

AWARENESS® SIGNS

High visibility graphics on chemical resistant ABS plastic shell.

MOUNTING CHOICES

Includes tie wraps & trim strip for shower piping stanchion mount.

- For top/bottom entry showers.
- For midpoint entry showers.
- On walls above fountains or below shower.

LANGUAGE CHOICES

- English
- French
- Spanish
- Others upon request

DIMENSIONS

- 9¼" x 8" x 40" / 23.5 cm x 20.3 cm x 101.6 cm

SHIP WEIGHT

5 lb / 2.27 kg



Model 35001810

AWARENESS 360° Sign Green, White Shower/Eyewash graphics

Model 01112911

AWARENESS® Sign
Yellow, Shower/Eyewash,
Black Letters, Top/Bottom

Model 01112953

AWARENESS® Sign Green,
Shower/Eyewash, White
Letters, Top/Bottom

Model 01112951

AWARENESS® Sign
Orange, Shower/Eyewash,
Black Letters, Top/Bottom



Note: Sign with Shower/Shower graphic is also available

Model 01112942

AWARENESS® Sign
Orange, Eyewash/
Eyewash, Black Letters,
Wall Mount

Model 01112912

AWARENESS® Sign
Yellow, Eyewash/Eyewash,
Black Letters, Wall Mount

Model 01112946

AWARENESS® Sign Green,
Eyewash/Eyewash, White
Letters, Wall Mount



Emergency Signs

White placard sign with green letters and graphics.

Suitable for wall mounting or pipe mounting (hardware not included.)

DIMENSIONS

- 7" x 11" & 8" x 18" / 17.8 cm x 27.9 cm & 20.3 cm x 45.7 cm

Model 01112892
Emergency Shower/
Eyewash Sign, 7" x 11" /
17.8 cm x 27.9 cm

Model 01112847
Emergency Shower/
Eyewash Sign, 8" x 18" /
20.3 cm x 45.7 cm



Model 01112893
Emergency Eyewash Sign,
7" x 11" / 17.8 cm x 27.9 cm

Model 01112848
Emergency Eyewash Sign,
8" x 18" / 20.3 cm x 45.7 cm



Model 01112891
Emergency Shower Sign, 7"
x 11" / 17.8 cm x 27.9 cm

Model 01112846
Emergency Shower Sign, 8"
x 18" / 20.3 cm x 45.7 cm

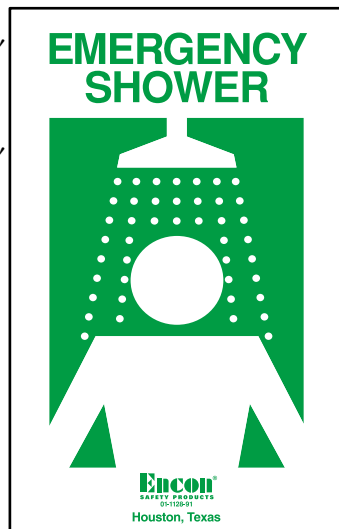

Model 01112900
Drench Hose Station, 7" x
11" / 17.8 cm x 27.9 cm



Accessories and Parts

Shower Accessories & Test Units

MODESTY CURTAIN ASSEMBLY

Provides immediate privacy; easily mounts to most floor mounted shower stations.
Includes ABS plastic blocks, SS rod & support bracket with SS U-bolts to hold assembly in place. Large hooks included.

- 70" x 145" / 177.8 cm x 368.3 cm high visibility yellow
- Water-resistant PVC nylon-coated heavy duty material with weighted bottom
- Clean Room Option — for electronic clean room; highly fluid repellent; 70" x 145" / 177.8 cm x 368.3 cm

SHIP WEIGHT
15 lb / 6.80 kg

SHOWER SHELTER

3-sided wind break structure

- SS clamp & hardware,
- Galvanized steel pipe supports & flanges
- Fiberglass panels and molded roof
- 111" x 45" x 51" / 281.9 cm x 114.3 cm x 129.5 cm

SHIP WEIGHT
345 lb / 156.49 kg

SHOWER TEST UNIT

Light weight, durable and portable PVC-coated nylon test chute for volume flow testing of shower.
Large opening with drawstring secures around shower head & hemmed bottom to neatly direct water into bucket

MOBILITY CHOICES

- Cart — High visibility yellow with 10" / 25.4 cm semi-pneumatic back wheels and 6" / 15.2 cm locking front casters
- Dolly — A wheel castered square dolly; twist on/off receptacle

SHIP WEIGHT
81 lb / 36.74 kg

Model 01052149

Modesty Curtain Assembly
(shower not included)



Model 01052187

Modesty Curtain Replacement Kit



Model 01080024

Shower Shelter
(shower not included)



Model STU1

Shower testing mobile cart with receptacle and chute
(shower not included)

Shower Accessories & Test Units

TREADLE KIT ASSEMBLY

ABS foot treadle with chain usable for indoor applications

SHIP WEIGHT

1 lb / 0.45 kg

RETROFIT DRENCH HOSE KITS

- ½" / 1.3 cm Tee connection with squeeze valve and lock open handle
- ½" / 1.3 cm Tee connection with push plate and stay-open chrome plated ball valve
- 6' / 1.8 m Neoprene® rubber hose, yellow ABS head with float off cover, support bracket

SHIP WEIGHT

1 lb / 0.45 kg

DRAIN PAN

- 36" x 36" / 91.4 cm x 91.4 cm high visibility yellow gel coating, 6" / 15.2 cm depth fiberglass shower catch basin
- Attaches to 1" / 2.5 cm structural open grates in multi-level process areas
- PVC slip joint 2" / 5.1 cm inside, 3" / 7.6 cm outside
- SS nuts, bolts & washer; galvanized steel clips

SHIP WEIGHT

50 lb / 22.67 kg



Model 01052232

Drain pan assembly,
36" x 36" / 91.4 cm x 91.4 cm



Model 01052382

Treadle Kit



Model 01090098

6' / 1.8 m Drench hose with ABS Head & Self-Close Locking BCP Valve, ½" / 1.3 cm Tee Connection



Model 01090017

6' / 1.8 m Drench hose with ABS Head,
Push Plate CP Valve

Accessories and Parts

Assemblies - Heads & Nozzels



Model 01052123
Eyewash Assembly, ABS Heads & Wye w/Flip Lids, 1/2" / 1.3 cm Inlet, 3.2 gpm / 12.1 lpm
Model 01052185
Eyewash Assembly, ABS Heads & Wye w/Flip Lids, 3/8" / 1 cm Inlet, 3.2 gpm / 12.1 lpm

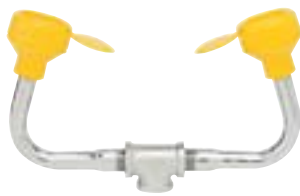

Model 01052132
Eyewash Assembly, Acetal Heads w/Hinged Covers, BCP Wye, 1/2" / 1.3 cm Inlet, 2.4 gpm / 9.1 lpm
Model 01052129
Eyewash Assembly, Acetal Heads w/Hinged Covers, BCP Wye, 3/8" / 1 cm Inlet, 2.4 gpm / 9.1 lpm



Model 01052208
Eyewash Assembly, Low Profile, Acetal Heads w/Hinged Covers, BCP Wye, 3/8" / 1 cm Inlet, 2.4 gpm / 9.1 lpm



Model 01052263
Eyewash Assembly, SS Heads & Wye, w/Hinged Covers, 1/2" / 1.3 cm Inlet, 2.5 gpm / 9.5 lpm



Model 01052045
Eyewash Head, Plastic 1/4" / 0.6 cm NPT 1.2 gpm / 4.5 lpm Regulated w/Hinge Cap
Model 01052037
Eyewash Head, Plastic 1/4" / 0.6 cm NPT 1.4 gpm / 5.3 lpm Regulated w/Hinge Cap



Model 01052122
Facewash Assembly, ABS Heads & Wye w/Covers, SS Bead Chain, 1/2" / 1.3 cm Inlet, 8 gpm / 30.3 lpm
Model 01052189
Facewash Assembly, ABS Heads & Wye w/Covers, SS Bead Chain, 3/8" / 1 cm Inlet, 8 gpm / 30.3 lpm



Model 01052133
Facewash Assembly, ABS Heads & BCP Wye w/Covers, SS Bead Chain, 1/2" / 1.3 cm Inlet, 8 gpm / 30.3 lpm
Model 01052130
Facewash Assembly, ABS Heads & BCP Wye w/Covers, SS Bead Chain, 3/8" / 1 cm Inlet, 8 gpm / 30.3 lpm



Model 01052040
Facewash Head only, 1/4" / 0.6 cm NPT
Model 01052041
Drench Hose Head only, 3/8" / 1 cm NPT



Model 01054005
Shower Head Assembly, Yellow ABS, integral 20 gpm / 75.7 lpm regulator, 1" / 2.5 cm connection



Model 01054003
Shower Head Assembly, Yellow ABS, integral 30 gpm / 113.6 lpm regulator, 1" / 2.5 cm connection



Model 01055007
Shower Head Assembly, SS, integral 30 gpm / 75.7 lpm regulator, 1" / 2.5 cm connection

Model 01055005
Shower Head Assembly, SS, integral 20 gpm / 113.6 lpm regulator, 1" / 2.5 cm connection



Model 01120002
ABS Bowl Cover Kit for Encon Eyewash Yello-Bowl®

Bowls & Covers

Accessories and Parts

Bowls & Covers



Model 01120001
ABS Bowl Cover Kit for Encon Facewash Yello-Bowl®



Model 01110462
Encon Yello-Bowl®, ABS



Model 01110096
Bowl, Stainless Steel



Model 01052020
Facewash Cover with 10" / 25.4 cm SS Bead Chain

Self-Contained



Model 01052113
Eyewash Cover with 8" / 20.3 cm SS Bead Chain



Model 01110764
Hydrosep® water additive - 4pk



Model 01110802
Hydrosep® QT water additive - 12/case



Model 01110803
Hydrosep® GL water additive - Four, 1-gallon jugs per case



Model 01110738
Gravity Fed Eyewash "J Hook" mounting bracket



Model 01110741
Mounting bracket for Helios®



Model 00015003
Gravity Fed Eyewash Receptacle, 28 gal / 106 L, grey plastic



Model 01110700
Transport Cart & Receptacle - For Gravity Fed and Aqurion® only
Model 01110302
Transport Cart only - For Gravity Fed and Aqurion® only



Model 00014314
Air Gauge for Pressurized Portable



Model 00014337
Hose, 1/4" x 8' / 0.6 cm x 243.8 cm Red recoil



Model 01052124
Nozzel assembly, for 00011406 portable drenching hose, 0.4 gpm / 1.5 lpm



Model 01052131
Eyewash head cover, with 8" / 20.3 cm SS bead chain, for 01052111A

Accessories and Parts



Model 01105001
Relief valve retrofit kit for self-contained portable, 115 psi



Model 00011077
Relief valve only, 115 psi



Model 01105005
Drench Hose Assembly



Model 01052111
Eyewash Assembly with ABS Heads, Wye & Covers, SS bead chain, 1/2" / 1.3 cm Inlet, 0.4 gpm / 1.5 lpm, for self contained portable

Activation Kits & Valves



Model 01052103
Ball Valve Kit for Shower, 1 1/4" / 3.2 cm BCP, with Nut



Model 01052120
Ball Valve Kit, 1" / 2.5 cm for Emergency Showers



Model 01052018
Push Plate, SS with Decal



Model 01052101
Ball Valve Kit for Eyewash, 1/2" / 1.3 cm BCP, with Nut, Push Plate

Model 01052104
Ball Valve Kit, Shower, 1 1/4" / 3.2 cm SS with Nut

Model 01052197
Ball Valve Kit, 1" / 2.5 cm horizontal, SS with actuator arm



Model 01052114
Ball Valve Kit for Eyewash, 1/2" / 1.3 cm Self-drain, with Push Plate



Model 01052001
Pull Rod, SS with Graphic & Pin Fastener, 29" / 73.7 cm



Model 01052065
Ball Valve Kit, 1 1/4" / 3.2 cm BCP, with 29" / 73.7 cm SS Pull Rod Actuator



Model 01110142
Extension Stem 2 1/4" / 5.7 cm for 1/2" / 1.3 cm Ball Valve Freeze Protection



Model 01110147
Extension Stem for 1 1/4" / 3.2 cm or 1 1/2" / 3.8 cm Ball Valve Freeze Protection

Model 01052086
Ball Valve Kit, 1" / 2.5 cm BCP, with 29" / 73.7 cm SS Pull Rod Actuator

Accessories and Parts

Protection Valves & Fittings



Model 00011082
Freeze Protection Valve, 1/2" / 1.3 cm opens at 35°F / 2°C



Model 03900006
Freeze Protection Valve Assembly, for exterior drain at 35°F / 2°C



Model 00011081
Scald Protection Valve 1/2" / 1.3 cm opens at 95°F / 35°C



Model 03900003
Scald Protection Valve Assembly, for exterior drain at 95°F / 35°C

Alarms



Model 01052098
Strainer Tee Assembly, BCP, 1/2" / 1.3 cm, 16 Mesh



Model 00013460
Clear Light Globe



Model 00013582
Blue Light Globe



Model 00013571
Green Light Globe



Model 00014606
Red Light Globe



Model 00014685
Flow Switch Assembly, 2 gpm / 7.6 lpm, 1" / 2.5 cm



Model 00014683
Flow Switch Bonnet, 2 gpm / 7.6 lpm



Model 00013319M
MAP® Switch & Magnet

Curtains & Testing Accessories



Model 01110447
Hook for Modesty Curtain, Zinc Plated



Model 01110593
Hook for Mod Curtain, Stainless Steel



Model 01112894
Shower eyewash inspection tag, yellow



Model 01110469
Eye/Facewash Test Gauge to ANSI Z358.1



Model 02570001
Shower Tester Chute

Representative Performance Data & Limited Warranty Statement

Encon utilizes self-adjusting flow regulators to deliver a constant, even flow under varying hydraulic conditions. ANSI Standard Z358.1 requires a minimum dynamic (flowing) pressure of 30 psi. It is important to include dynamic pressure drops through the potable water system when calculating system hydraulic requirements. Dynamic pressure above 80 psi to shower and eyefacewash equipment is not recommended.

	Dynamic Pressure	GPM / LPM Output
Eyewash Dual-stream Heads	30	3.2 / 12.1
	40	3.4 / 12.9
	50	3.5 / 13.2
	60	3.6 / 13.6
	70	3.7 / 14
Eye/Facewash Dual-stream Heads	30	7.0 / 26.5
	40	7.5 / 28.4
	50	8.0 / 30.3
	60	8.5 / 32.2
	70	9.0 / 34.1
Regulated Showers on Combination Units with 20 gpm / 75.7 lpm shower & 8 gpm / 30.3 lpm FW	40	28 / 106
	30	38 / 143.8
	40	23.5 / 89
	30	33.5 / 126.8
Hand-held Drench Hose with squeeze valve, black-braided hose (Nylon recoil hose requires minimum 45 psi)	30	3.6 / 13.6
	40	4.5 / 17
	50	4.8 / 18.2
	60	4.9 / 18.5
	70	5.0 / 18.9
Hand-held Drench Hose with stay-open valve, black-braided hose (Nylon recoil hose requires minimum 45 psi)	30	5.3 / 20.1
	40	6.0 / 22.7
	50	6.9 / 26.1
	60	7.5 / 28.4
	70	7.8 / 29.5

WITH RESPECT TO EMERGENCY SHOWERS (THE "EQUIPMENT") ENCON SAFETY PRODUCTS HEREBY DISCLAIMS ALL WARRANTIES, EXPRESSED OR IMPLIED, INCLUDING THE IMPLIED WARRANTY OF MERCHANTABILITY AND FITNESS FOR A PARTICULAR PURPOSE, EXCEPT AS HEREAFTER PROVIDED.

ENCON warrants the Equipment to be free of defects in material and workmanship if properly installed, cared for, and operated under normal conditions, with competent supervision, and in accordance with ENCON installation, operating, and maintenance instructions. With respect to the Equipment, ENCON's only obligation under this warranty is to repair or replace such components of the Equipment:

As prove defective and ENCON is so advised within one year after shipment, and shall appear to ENCON's satisfaction to have been defective in material or workmanship. However, in no event shall ENCON be liable under this Warranty unless ENCON is provided an opportunity to inspect such material or workmanship and, at its option, allowed to repair or replace such material or workmanship.

No warranty is given in connection with any portion of the Equipment, which is altered or rebuilt without ENCON's express written consent.

ENCON shall not be liable for loss, damage, or expense, arising directly, or indirectly, as a consequence of use of the Equipment with other products, or from any other cause, other than ENCON's obligation to repair or replace defective components of the Equipment as expressly provided in this warranty statement.

THE CUSTOMER'S PURCHASE AND ACCEPTANCE OF THE EQUIPMENT SHALL BE DEEMED TO BE ITS AGREEMENT TO BE BOUND BY THE TERMS AND PROVISIONS OF THIS WARRANTY.

Under no circumstances will ENCON ever be liable for indirect or consequential loss or damage arising out of the ownership or use of the Equipment.

The terms of this warranty shall apply to any replacement parts installed on, or furnished in connection with, the Equipment.

The equipment was designed using information and specifications supplied by the customer and sized and fitted, using common piping elements, accordingly. ENCON is not liable for the correctness of any design, materials or construction criteria furnished or specified in the equipment performance specification documents.

Numerical Parts Index

<u>Part No.</u>	<u>Page No.</u>	<u>Part No.</u>	<u>Page No.</u>	<u>Part No.</u>	<u>Page No.</u>	<u>Part No.</u>	<u>Page No.</u>
00011077	52	01050207	5	01052086	52	01110700	51
00011081	53	01050209	6	01052098	53	01110738	51
00011082	53	01050209P20	6	01052101	52	01110741	51
00013319M	53	01050210	13	01052103	52	01110764	21
00013460	53	01050216	5	01052104	52	01110764	51
00013571	53	01050217	5	01052111	52	01110786S	25
00013582	53	01050217P20	5	01052113	51	01110793S	25
00014314	51	01050217P20PBC	6	01052114	52	01110802	51
00014337	51	01050217PBC	6	01052120	52	01110803	51
00014606	53	01050219	10	01052122	50	01112846	47
00014683	53	01050219P20	10	01052123	50	01112847	47
00014685	53	01050221	9	01052124	51	01112848	47
00015003	51	01050221P20	9	01052129	50	01112891	47
00015006	22	01050223	10	01052130	50	01112892	47
00113000	45	01050223P20	10	01052131	51	01112893	47
00113001	45	01050224	9	01052132	50	01112894	53
00113003	45	01050224P20	9	01052133	50	01112900	47
00113004	45	01050228	13	01052149	48	01112911	46
00113006	45	01050230	7	01052155	43	01112912	46
00113007	45	01050230P20	7	01052185	50	01112942	46
00113011	45	01050230P20PBC	8	01052187	48	01112946	46
00113014	45	01050230PBC	8	01052189	50	01112951	46
00113017	45	01050232	10	01052197	52	01112953	46
01030101	30	01050232P20	10	01052208	50	01114021	30
01030103	30	01050234	7	01052232	49	01120001	51
01030104	17	01050234P20	7	01052263	50	01120002	50
01030106	18	01050234P20PBC	8	01052382	49	02000200	44
01030301	29	01050234P20SBC	8	01052501	14	02000300	44
01030302	31	01050234PBC	8	01052502	14	02100000	44
01030310	32	01050234SBC	8	01052522	14	02111000	43
01030316PBC	32	01050236	11	01052524	14	02200000	44
01030401	27	01050236P20	11	01053001	14	02211300	44
01030403	27	01050236P20SBC	11	01053001P20	14	02311000 240	44
01030416	27	01050236SBC	11	01054003	50	02570001	53
01035401	29	01050251	5	01054005	50	03900003	53
01035402	31	01050260	5	01055005	50	03900006	53
01035410	32	01050264	11	01055007	50	35001810	46
01035415PBC	32	01050264S20	11	01060007	12	AQ100	20
01035501	27	01050266P20PBC	7	01060009	12	AQ100H130	20
01035503	27	01050266PBC	7	0106009P20	12	AQ100S	20
01035511	27	01050276	13	01060021	12	AQ110	20
01035601	30	01050277	13	01060022	12	AQ111	20
01035603	30	01050281	7	01080024	48	AQ120	20
01035604	17	01050281P20	7	01090017	49	FRSSC-G	17
01035606	18	01050288	6	01090098	49	FRSSC-GP20	17
01038301	29	01050288P20	6	01101001	25	HE100	21
01038801	29	01050290	6	01103001	25	HF100	21
01040103	30	01050290P20	6	01103002	23	HS100	21
01040135	30	01050293	8	01103004	23	STF30WB120G	42
01045001	28	01050293P20	8	01103006	23	STF30WP120C	42
01045001PBC	28	01050294	18	01103008	23	STF60WB120G	42
01045001SBC	28	01050294P20	18	01104002	23	STU1	48
01045002	31	01050314	16	01104050	22	TF34B2300001	34
01045002SBC	31	01050314P20	16	01104050C	22	TF35B5376300	34
01045005	29	01050317	16	01104050S	22	TF36B2000302	34
01045006	32	01050317P20	16	01104055	22	TP21323230	36
01045008	32	01050362	16	01104070	22		
01045010	28	01050362P20	16	01105001	52		
01045501	28	01050376	13	01105005	52		
01045501PBC	28	01050381	13	01106001	24		
01045501SBC	28	01050470	11	01106002	24		
01045502	31	01050470S20	11	01106004	24		
01045505	29	01050471S20SBC	9	01110096	51		
01045506	32	01050471SBC	9	01110142	52		
01045502SBC	31	01052001	52	01110147	52		
01045510	28	01052018	52	01110302	21		
01045514	32	01052020	51	01110302	51		
01045601	30	01052037	50	01110447	53		
01050201	17	01052040	50	01110462	51		
01050201P20	17	01052041	50	01110469	53		
01050205	9	01052045	50	01110593	53		
01050205P20	9	01052065	52				

SAFETY

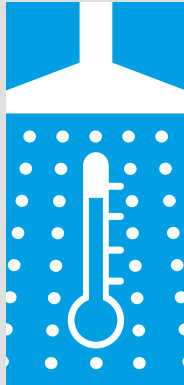

PROTECTION



EXCELLENCE



SOLUTIONS

LEADERS

Encon[®]
SAFETY PRODUCTS

6825 West Sam Houston Pkwy. North, Houston, TX 77041
Toll Free: 1(800) AT ENCON 1(800) 283-6266
Fax: (713) 466-1703
customerservice@enconsafety.com
www.enconsafety.com
ESEWFULL-08-25-2017

WALL
CASES



SELF-CONTAINED



PARTS



ENGINEERED



QUALITY

