

RESIDENTIAL

GARAGE DOORS



A SUPERIOR DOOR INSIDE & OUT

WE BUILD GARAGE DOORS THAT OUR DEALERS LOVE TO INSTALL AND THEIR CUSTOMERS ARE PROUD TO OWN

For over 40 years, Midland has been manufacturing the longest-lasting, smoothest-running residential and commercial overhead doors in the industry. From the construction of our doors, to the quality of materials, Midland manufactures a product that is simply better.

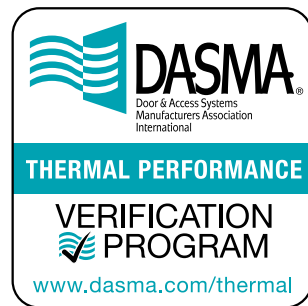

THERMAL PERFORMANCE VERIFICATION PROGRAM

The DASMA (Door & Access Systems Manufacturers Association) Thermal Performance Verification Program certifies and verifies the thermal performance ratings of sectional doors using third-party testing and inspection.

WHAT IS U-FACTOR?

- U-factor is a measure of the rate of “non-solar heat flow” through a material.
- A lower U-Factor indicates better insulation, because less heat is being transferred through the garage door. If the garage is attached to the house, a lower U-Factor helps maintain a more stable indoor temperature and can contribute to energy savings.
- U-factor ratings are tested whereas R-value is calculated.
- U-factor tests the whole installed garage door assembly while R-value is calculated for only a portion of insulated section.
- U-Factor is commonly used in energy efficiency standards and is considered a more comprehensive and accurate metric than R-Value.

NOT ALL GARAGE DOORS ARE CREATED EQUAL

WHERE IS THE PROOF?

The infrared images below show a side-by-side comparison of a Midland ThermoGuard™ door, next to a competitor’s polyurethane door. This was observed with the doors installed next to the other in the same location. The outside temperature was 0°F and the inside temperature was 55°F. The dark areas show where energy loss occurs.

MIDLAND GARAGE DOOR MFG CO
THERMOGUARD™ DOOR

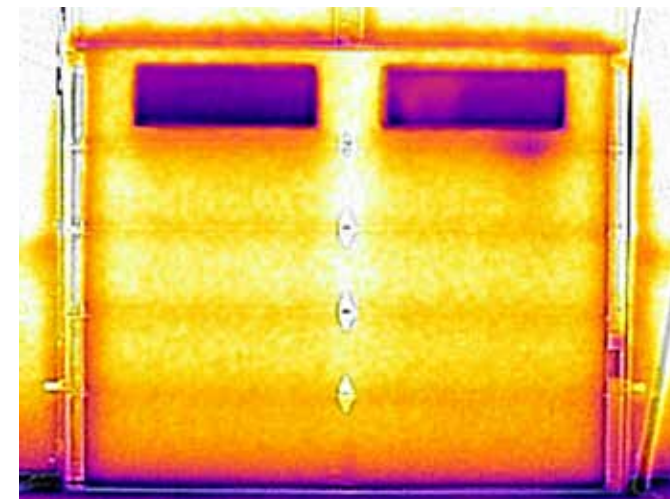

COMPETITOR'S POLYURETHANE DOOR

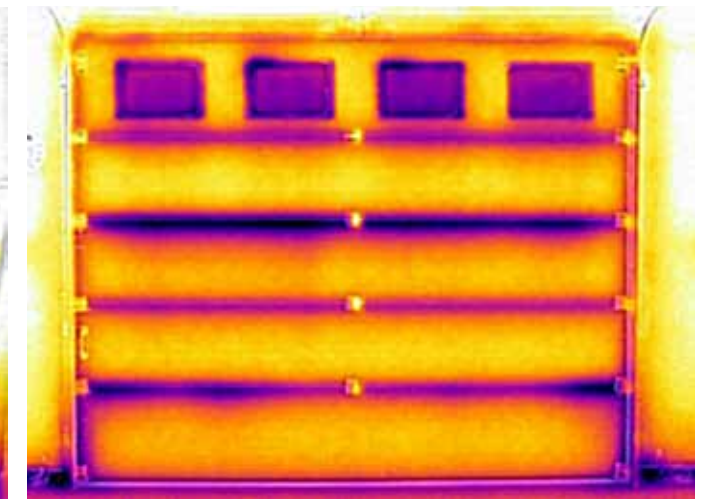

WHY DO MIDLAND THERMOGUARD™ DOORS PERFORM BETTER?

- 1 TRUE THERMAL BREAK**
Midland door sections utilize a true thermal break that minimizes energy loss between sections
- 2 MINIMAL AIR INFILTRATION**
A flexible commercial-grade seal between the door sections minimizes air infiltration
- 3 SUPERIOR FIT**
Midland door sections have tighter and more consistent section gaps
- 4 MOISTURE RESISTANT**
Closed cell end dams help to keep moisture away from insulation
- 5 STRUCTURAL RIGIDITY**
Concealed full-height vertical center stiles and tailor-made custom end stiles provide structural rigidity
- 6 QUALITY STEEL**
Hot dipped galvanized steel, that is conditioned and embossed with a pebble texture for maximum durability





The Art Of Craftsmanship

The landscape of the garage door industry has changed over the years. Today, home owners expect more than just a quality door, they want something that enhances the appearance of their home. With that in mind, Midland offers a variety of panel designs, complimented by numerous colors and window combinations.

PANEL DESIGN OPTIONS



RAISED STEEL PANEL
PAGE 5



SHORT PANEL CARRIAGE
PAGE 7



LONG PANEL CARRIAGE
PAGE 9



RECESSED PANEL
PAGE 11



RANCH PANEL
PAGE 13

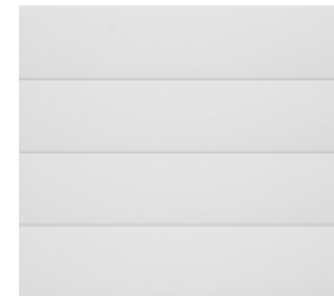

FLUSH PANEL
PAGE 15



CLASSIC PANEL
PAGE 17



SERIES 26 RIBBED
PAGE 19



STEEL OVERLAY
PAGE 21

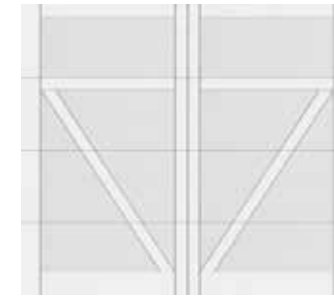

SMOOTH OVERLAY
PAGE 23

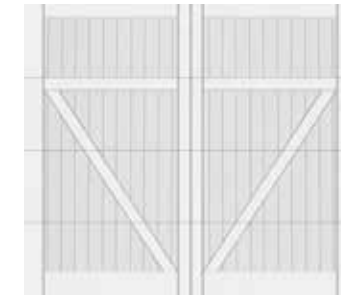

V-GROOVE OVERLAY
PAGE 23



FULLVIEW
PAGE 25



FULLVIEW STYLIST
PAGE 27

SEE THESE DOORS ON YOUR HOME

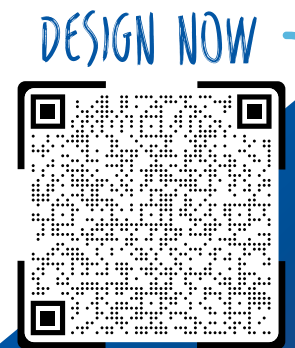



Raised Steel Panel

TIMELESS STYLE

This iconic design is the standard in the industry. Its sculpted panels fit nearly any home design, ensuring a lasting and timeless look.

**Images may not depict current model options*



CHOOSE YOUR OPTIONS

SPECIFICATIONS	ThermoGuard™	ThermoSteel™	TS-138	Series 24	ValuCraft Plus
U-Factor R-Value	0.14 ✓ 18.0	0.22 ✓ 9.25	0.26 ✓ 7.50	0.38* ✓ 7.0*	0.38* ✓ 7.0*
Foam/Insulate	Polyurethane	Polystyrene	Polystyrene	T-Bond/ Plain Steel	T-Bond/ Plain Steel
Thickness	2 inches	2 inches	1¾ inches	2 inches	2 inches
Exterior Steel	27 gauge	25 gauge	27 gauge	24 gauge	25 gauge
Interior Steel	27 gauge	26 gauge	27 gauge	N/A	N/A
Warranty* Excludes Springs	Lifetime	Lifetime	25 years	Lifetime *With T-Bond	25 years *With T-Bond
COLORS					
White	•	•	•	•	•
Almond	•	•	•	•	•
Sandtone	•	•	•	•	•
Tera-Bronze	•	•	•	•	•
Green	•	•	•	•	•
Gray	•	•	•	•	•
Coffee	•	•	•	•	•
Black	•	•	•	•	•
Light Oak	•	•	•	•	•
Dark Oak	•	•	•	•	•
Weathered Oak	•	•	•	•	•
Rosewood	•	•	•	•	•
Color Select**	•	•	•	•	•

*For full warranty details contact your Midland dealer

**ColorSelect™ uses Sherwin Williams Polane® Solar Reflective Polyurethane Enamel, providing a durable, heat-repelling coating.



COLORS



Color Select™

*Printed colors may not be accurate. Contact your local Midland dealer for exact color samples

WINDOWS



GLASS



*Tempered only. All other glass is available in both tempered and untempered.



Short Panel Carriage

HANDCRAFTED BEAUTY & ELEGANCE

Add historic charm and distinguished elegance to your home. This classic "rail and stile" design blends beautifully with a variety of home styles.

**Images may not depict current model options*



CHOOSE YOUR OPTIONS

SPECIFICATIONS

	ThermoGuard™	ThermoSteel™	TS-138	Series 24
U-Factor R-Value	0.14 18.0	0.22 9.25	0.26 7.50	0.38* 7.0*
Foam/Insulate	Polyurethane	Polystyrene	Polystyrene	T-Bond/ Plain Steel
Thickness	2 inches	2 inches	1¾ inches	2 inches
Exterior Steel	27 gauge	25 gauge	27 gauge	24 gauge
Interior Steel	27 gauge	26 gauge	27 gauge	N/A
Warranty* <i>Excludes Springs</i>	Lifetime	Lifetime	25 years	Lifetime

COLORS

	ThermoGuard™	ThermoSteel™	TS-138	Series 24
White	•	•	•	•
Almond	•	•	•	•
Sandtone	•	•	•	•
Tera-Bronze	•	•	•	•
Green	•	•	•	•
Gray	•	•	•	•
Coffee	•	•	•	•
Black	•	•	•	•
Light Oak	•	•	•	•
Dark Oak	•	•	•	•
Weathered Oak	•	•	•	•
Rosewood	•	•	•	•
Color Select™	•	•	•	•

*For full warranty details contact your Midland dealer

**ColorSelect™ uses Sherwin Williams Polane® Solar Reflective Polyurethane Enamel, providing a durable, heat-repelling coating.



HARDWARE

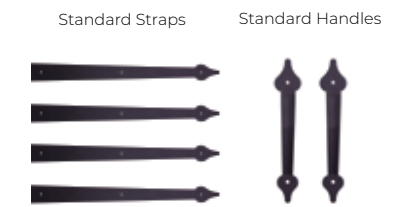

 *Printed colors may not be accurate. Contact your local Midland dealer for exact color samples

WINDOWS

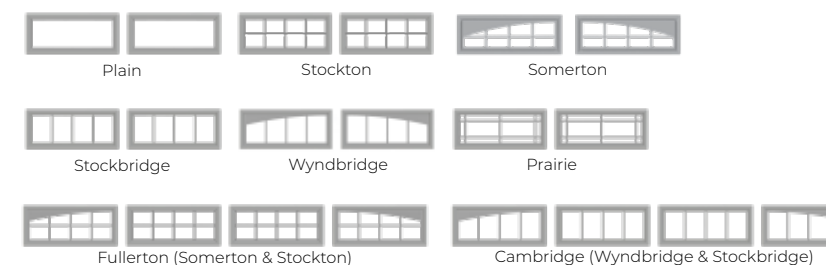

GLASS



*Tempered only. All other glass is available in both tempered and untempered.



Long Panel Carriage

CONTEMPORARY CHARM & STYLE

A fresh dimension to a classic. This design offers a cleaner and more contemporary look while maintaining the classic charm of the Short Panel Carriage design.

**Images may not depict current model options*



CHOOSE YOUR OPTIONS

SPECIFICATIONS	ThermoGuard™	ThermoSteel™	TS-138	Series 24
U-Factor R-Value	0.14	0.22	0.26	0.38*
Foam/Insulate	Polyurethane	Polystyrene	Polystyrene	T-Bond/ Plain Steel
Thickness	2 inches	2 inches	1¾ inches	2 inches
Exterior Steel	27 gauge	25 gauge	27 gauge	24 gauge
Interior Steel	27 gauge	26 gauge	27 gauge	N/A
Warranty* <i>Excludes Springs</i>	Lifetime	Lifetime	25 years	Lifetime
COLORS				*With T-Bond
White	•	•	•	•
Almond	•	•	•	•
Sandtone	•	•	•	•
Tera-Bronze	•	•	•	•
Green	•	•	•	•
Gray	•	•	•	•
Coffee	•	•	•	•
Black	•	•	•	•
Light Oak	•	•	•	•
Dark Oak	•	•	•	•
Weathered Oak	•	•	•	•
Rosewood	•	•	•	•
Color Select**	•	•	•	•

**For full warranty details contact your Midland dealer*

***ColorSelect™ uses Sherwin Williams Polane® Solar Reflective Polyurethane Enamel, providing a durable, heat-repelling coating.*



WINDOWS



HARDWARE

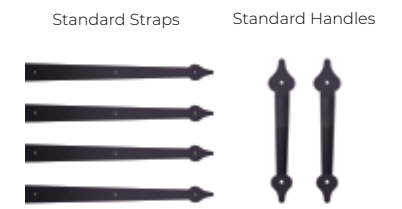

COLORS



**Printed colors may not be accurate. Contact your local Midland dealer for exact color samples*

GLASS



**Tempered only. All other glass is available in both tempered and untempered.*



Recessed Long Panel

BOLD & TRADITIONAL REFINEMENT

Enjoy the time-honored look of the wood frame and panel design with the modern-day efficiency and operation of steel doors.

**Images may not depict current model options*



CHOOSE YOUR OPTIONS

SPECIFICATIONS	ThermoGuard™	ThermoSteel™	TS-138	Series 24
U-Factor R-Value	0.14	0.22	0.26	0.38*
Foam/Insulate	Polyurethane	Polystyrene	Polystyrene	T-Bond/ Plain Steel
Thickness	2 inches	2 inches	1¾ inches	2 inches
Exterior Steel	27 gauge	25 gauge	27 gauge	24 gauge
Interior Steel	27 gauge	26 gauge	27 gauge	N/A
Warranty* <i>Excludes Springs</i>	Lifetime	Lifetime	25 years	Lifetime
COLORS				*With T-Bond
White	•	•	•	•
Almond	•	•	•	•
Sandtone	•	•	•	•
Tera-Bronze	•	•	•	•
Green	•	•	•	•
Gray	•	•	•	•
Coffee	•	•	•	•
Black	•	•	•	•
Light Oak	•	•	•	•
Dark Oak	•	•	•	•
Weathered Oak	•	•	•	•
Rosewood	•	•	•	•
Color Select™	•	•	•	•

*For full warranty details contact your Midland dealer

**ColorSelect™ uses Sherwin Williams Polane® Solar Reflective Polyurethane Enamel, providing a durable, heat-repelling coating.



HARDWARE

Standard Straps Standard Handles



COLORS



Color Select™

*Printed colors may not be accurate. Contact your local Midland dealer for exact color samples

WINDOWS

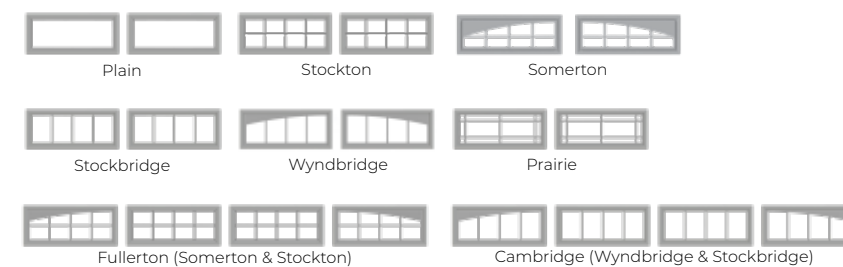

GLASS



*Tempered only. All other glass is available in both tempered and untempered.



Ranch Panel

SIMPLE LINES FOR A BIG STATEMENT

With clean lines and a classic appearance, this design features distinctive long panels that will compliment your home.

**Images may not depict current model options*



CHOOSE YOUR OPTIONS

SPECIFICATIONS	ThermoGuard™	ThermoSteel™	TS-138	Series 24
U-Factor R-Value	0.14	0.22	0.26	0.38*
Foam/Insulate	Polyurethane	Polystyrene	Polystyrene	T-Bond/ Plain Steel
Thickness	2 inches	2 inches	1¾ inches	2 inches
Exterior Steel	27 gauge	25 gauge	27 gauge	24 gauge
Interior Steel	27 gauge	26 gauge	27 gauge	N/A
Warranty* <i>Excludes Springs</i>	Lifetime	Lifetime	25 years	Lifetime
COLORS				*With T-Bond
White	•	•	•	•
Almond	•	•	•	•
Sandtone	•	•	•	•
Tera-Bronze	•	•	•	•
Green	•	•	•	•
Gray	•	•	•	•
Coffee	•	•	•	•
Black	•	•	•	•
Light Oak	•	•	•	•
Dark Oak	•	•	•	•
Weathered Oak	•	•	•	•
Rosewood	•	•	•	•
Color Select**	•	•	•	•

**For full warranty details contact your Midland dealer*

***ColorSelect™ uses Sherwin Williams Polane® Solar Reflective Polyurethane Enamel, providing a durable, heat-repelling coating.*



HARDWARE

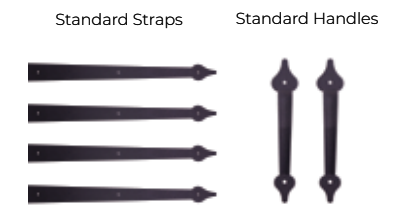

COLORS



**Printed colors may not be accurate. Contact your local Midland dealer for exact color samples*

GLASS



**Tempered only. All other glass is available in both tempered and untempered.*

WINDOWS





Flush Panel

MINIMALIST MODERN PANEL DESIGN

This minimalist design provides homeowners a clean, modern look that is an exceptional addition for that style. With several window layout options, you are certain to find the look you want.

**Images may not depict current model options*



CHOOSE YOUR OPTIONS

SPECIFICATIONS	ThermoGuard™	ThermoSteel™	TS-138
U-Factor R-Value	0.14 18.0	0.22 9.25	0.26 7.50
Foam/Insulate	Polyurethane	Polystyrene	Polystyrene
Thickness	2 inches	2 inches	1¾ inches
Exterior Steel	27 gauge	25 gauge	27 gauge
Interior Steel	27 gauge	26 gauge	27 gauge
Warranty* <i>Excludes Springs</i>	Lifetime	Lifetime	25 years
COLORS			
White	•	•	•
Almond	•	•	•
Sandtone	•	•	•
Tera-Bronze	•	•	•
Green	•	•	•
Gray	•	•	•
Coffee	•	•	•
Black	•	•	•
Rosewood	•	•	•
Color Select™	•	•	•

**For full warranty details contact your Midland dealer*

***ColorSelect™ uses Sherwin Williams Polane® Solar Reflective Polyurethane Enamel, providing a durable, heat-repelling coating.*



COLORS



**Printed colors may not be accurate. Contact your local Midland dealer for exact color samples*

WINDOWS*

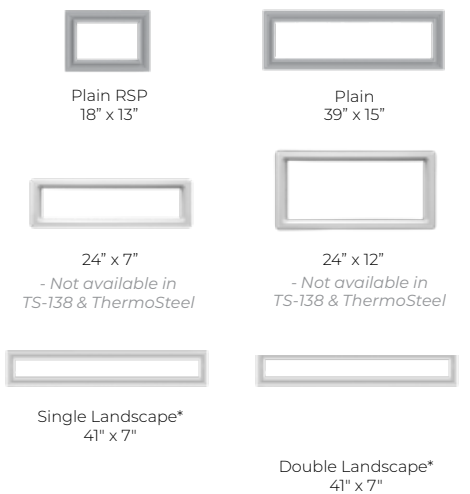

**ThermoGuard only
White & Black frames only
Plain, Satin & Double Dark glass only*

***Contact your dealer for custom window options.*

GLASS



**Tempered only. All other glass is available in both tempered and untempered.*



Classic Panel

MINIMALIST RAISED PANEL DESIGN

This traditional design provides homeowners with a sophisticated design that will bring added charm and curb-appeal.

**Images may not depict current model options*



CHOOSE YOUR OPTIONS

SPECIFICATIONS	ThermoGuard™	ThermoSteel™	TS-138	Series 24
U-Factor R-Value	0.14	0.22	0.26	0.38*
Foam/Insulate	Polyurethane	Polystyrene	Polystyrene	T-Bond/ Plain Steel
Thickness	2 inches	2 inches	1¾ inches	2 inches
Exterior Steel	27 gauge	25 gauge	27 gauge	24 gauge
Interior Steel	27 gauge	26 gauge	27 gauge	N/A
Warranty* <i>Excludes Springs</i>	Lifetime	Lifetime	25 years	Lifetime
COLORS				*With T-Bond
White	•	•	•	•
Almond	•	•	•	•
Sandtone	•	•	•	•
Tera-Bronze	•	•	•	•
Green	•	•	•	•
Gray	•	•	•	•
Coffee	•	•	•	•
Black	•	•	•	•
Light Oak	•	•	•	•
Dark Oak	•	•	•	•
Weathered Oak	•	•	•	•
Rosewood	•	•	•	•
Color Select™	•	•	•	•

**For full warranty details contact your Midland dealer*

***ColorSelect™ uses Sherwin Williams Polane® Solar Reflective Polyurethane Enamel, providing a durable, heat-repelling coating.*



WINDOWS

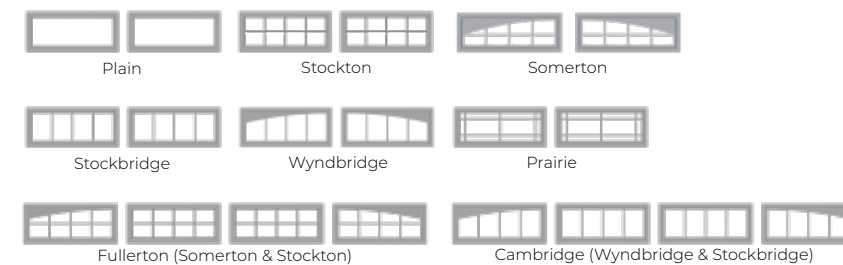

HARDWARE

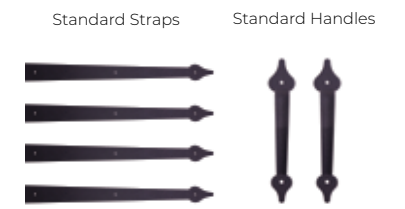

COLORS



Color Select™

**Printed colors may not be accurate. Contact your local Midland dealer for exact color samples*

GLASS



**Tempered only. All other glass is available in both tempered and untempered.*



Series 26 Ribbed

DURABLE PEBBLE GRAIN STEEL FINISH

An affordable, reliable option for homes, apartment buildings or storage units. Rolled from 26-gauge pebble-grain steel, this door provides superior strength, durability, and low maintenance.

**Images may not depict current model options*



CHOOSE YOUR OPTIONS

SPECIFICATIONS	Series 26
U-Factor R-Value	0.38*  7.0*
Foam/Insulate	T-Bond/ Plain Steel
Thickness	2 inches
Exterior Steel	24 gauge
Interior Steel	N/A
Warranty* Excludes Springs	Lifetime
	*With T-Bond

COLORS	
White	•
Coffee	•
Color Select**	•

**For full warranty details contact your Midland dealer*

***ColorSelect™ uses Sherwin Williams Polane® Solar Reflective Polyurethane Enamel, providing a durable, heat-repelling coating.*



COLORS

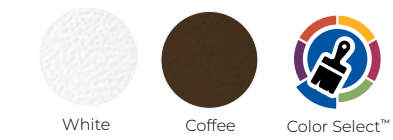

**Printed colors may not be accurate. Contact your local Midland dealer for exact color samples*

WINDOWS

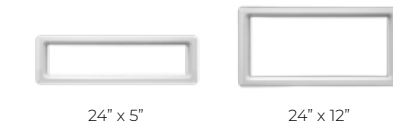

GLASS



**Tempered only. All other glass is available in both tempered and untempered.*

LOCK OPTIONS



Mini Warehouse Lock pictured above.

INSIDE LOCK

- Side bolt door latch, attached on inside
- Not visible from the outside
- Harder for an intruder to tamper with

RESIDENTIAL KEYED LOCK

- T-handle keyed lock, attached on outside
- Cylinder-shaped key that is difficult to reproduce
- Impossible to operate the handle without key

MINI WAREHOUSE LOCK

- Side bolt door latch
- Attached on outside of garage door
- Latch fits with padlock



Steel Overlay

POLISHED OVERLAY DESIGN

This door leaves some of our Flush Panel steel door visible while accenting it with an overlay design. Choose from 20 overlay options or customize your own design to match your home.

**Images may not depict current model options*



CHOOSE YOUR OPTIONS

SPECIFICATIONS

U-Factor R-Value	0.14  18.0
Foam/Insulate	Polyurethane
Thickness	2 inches
Exterior Steel	27 gauge
Interior Steel	27 gauge
Warranty* <i>Excludes Springs</i>	Lifetime Smart Trim: Limited Warranty

COLORS

White	•
Almond	•
Sandtone	•
Tera-Bronze	•
Green	•
Gray	•
Coffee	•
Black	•
Light Oak	•
Dark Oak	•
Weathered Oak	•
Color Select**	•

*For full warranty details contact your Midland dealer

**ColorSelect™ uses Sherwin Williams Polane® Solar Reflective Polyurethane Enamel, providing a durable, heat-repelling coating.



HARDWARE



COLORS



**Printed colors may not be accurate. Contact your local Midland dealer for exact color samples*

OVERLAY DESIGNS

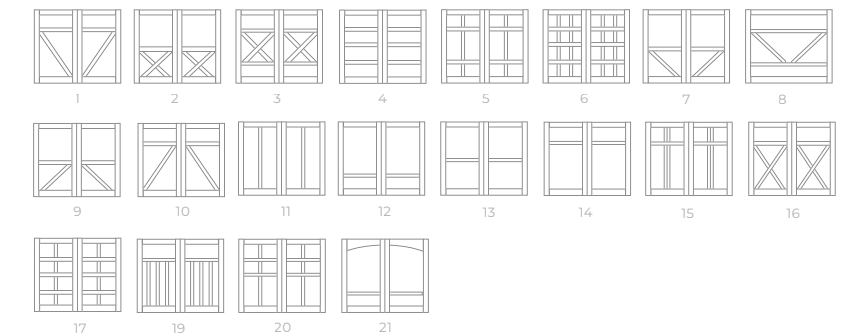

Custom designs available

WINDOWS

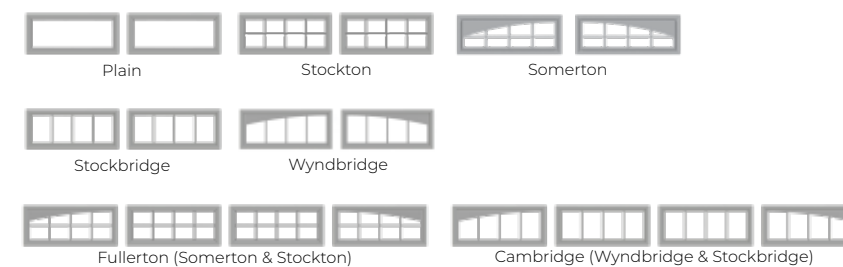

GLASS



**Tempered only. All other glass is available in both tempered and untempered.*



Smooth & V-Groove

CLASSIC LOOK OF REAL WOOD

Garage doors with superb energy efficiency and the charm of traditional carriage-house-style designs. Each design uses state-of-the-art weather-resistant wood composite Smart Trim® boards to create a distinguished and durable garage door.

**Images may not depict current model options*



CHOOSE YOUR OPTIONS

SPECIFICATIONS

U-Factor R-Value	0.14  18.0
Foam/Insulate	Polyurethane
Thickness	2 inches
Exterior Steel	27 gauge
Interior Steel	27 gauge
Warranty* <i>Excludes Springs</i>	Lifetime Smart Trim: Limited Warranty

COLORS

White	•
Almond	•
Sandtone	•
Tera-Bronze	•
Green	•
Gray	•
Coffee	•
Black	•
Color Select™	•

*For full warranty details contact your Midland dealer

**ColorSelect™ uses Sherwin Williams Polane® Solar Reflective Polyurethane Enamel, providing a durable, heat-repelling coating.



HARDWARE



COLORS*



*Printed colors may not be accurate. Contact your local Midland dealer for exact color samples

OVERLAY DESIGNS

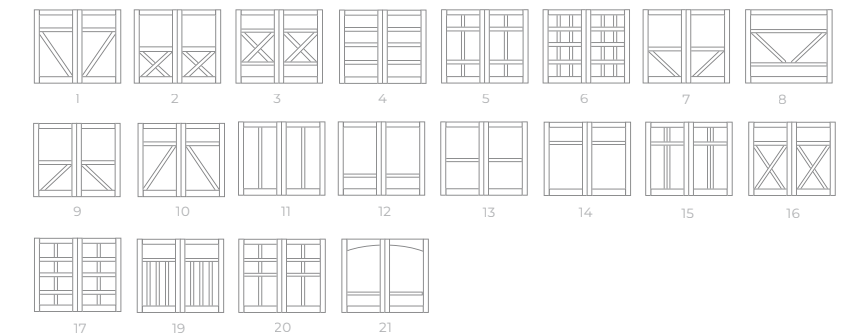

Custom designs available

WINDOWS

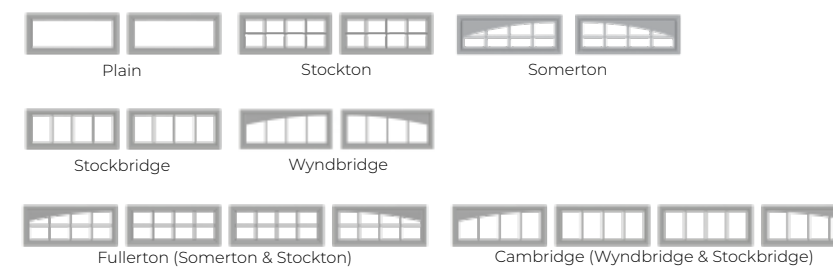

GLASS



*Tempered only. All other glass is available in both tempered and untempered.



FullView

SLEEK LINES OF STYLISH GLASS

Stand out with the clean lines of a modern glass and aluminum garage door. Whether you are upgrading your home's curb-appeal or letting in natural light, you will appreciate this contemporary door and it's distinctive, upscale look.

**Images may not depict current model options*



CHOOSE YOUR OPTIONS

SPECIFICATIONS

FullView Glass Panel

U-Factor	0.85 
Frame	6063-T Aluminum
Thickness	2 inches
Glass	½ inch insulated ¼ inch non-insulated ⅛ inch non-insulated
Panel	—
Rails	Insulated non-insulated
Air Infiltration Seal	•
Warranty* Excludes Springs	5 years

*For full warranty details contact your Midland dealer

FRAME COLORS



*Printed colors may not be accurate. Contact your local Midland dealer for exact color samples

**ColorSelect™ uses Sherwin Williams Polane® Solar Reflective Polyurethane Enamel, providing a durable, heat-repelling coating.

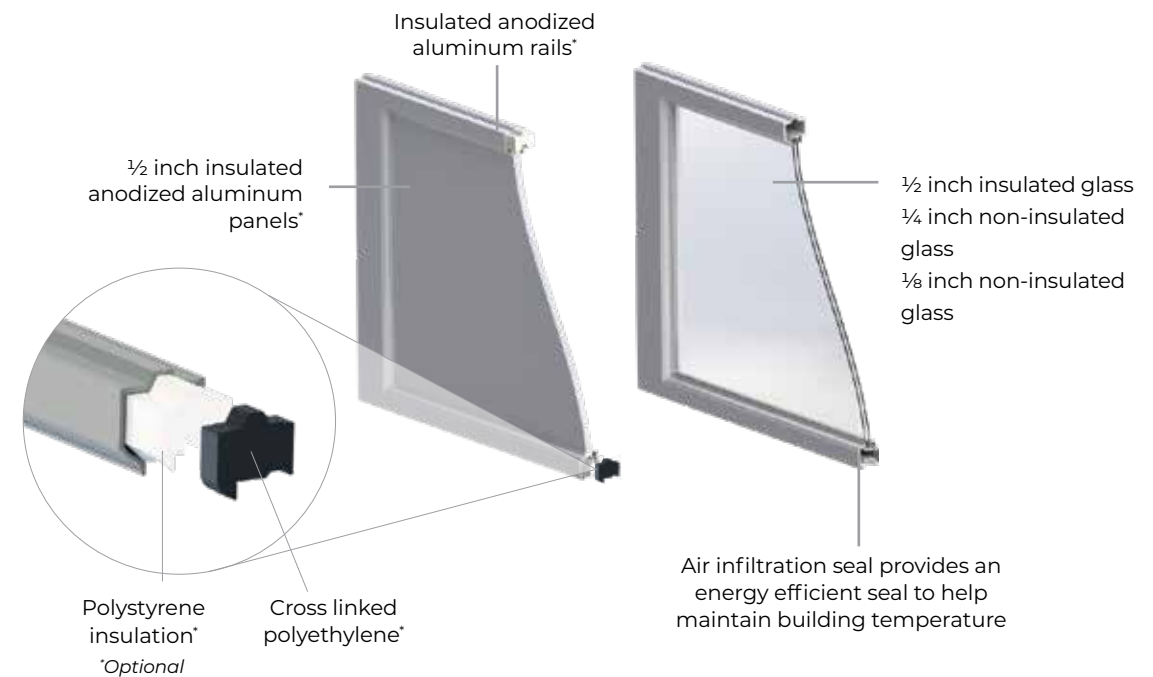

GLASS



*Tempered only. All other glass is available in both tempered and untempered.



FullView Stylist

ULTRA MODERN UPSCALE GLASS

Make a dramatic statement with our ultra-modern glass and aluminum garage door. This modern look is taken to another level with our FullView "Stylist" Models. Offered in "Lite" and "XL", these doors utilize horizontal glass with minimal stiles.

**Images may not depict current model options*



CHOOSE YOUR OPTIONS

SPECIFICATIONS

	Stylist
U-Factor	Not Tested
Frame	6063-T Aluminum
Thickness	2 inches
Glass	½ inch insulated ¼ inch non-insulated ⅜ inch non-insulated
Panel	—
Rails	Insulated non-insulated
Air Infiltration Seal	·
Warranty* Excludes Springs	5 years

*For full warranty details contact your Midland dealer

FRAME COLORS

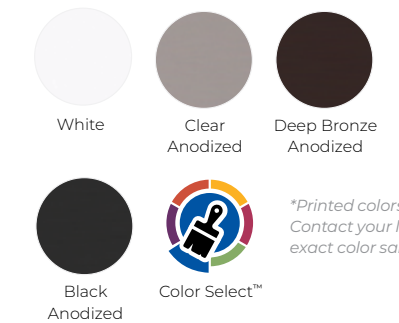

*Printed colors may not be accurate. Contact your local Midland dealer for exact color samples

STYLIST LITE

Doors up to 7' 2" wide = 1 panel
Doors 7' 3" to 12' 2" wide = 2 panels

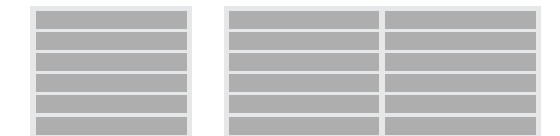

Doors 12' 3" to 18' 2" wide = 3 panels

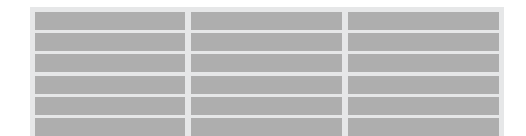

STYLIST XL

Doors up to 10' 2" wide = 1 panel
Doors 10' 3" to 18' 2" wide = 2 panels

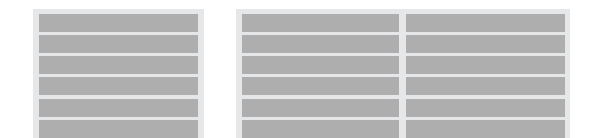

Stylist Cross Section*
*Pictured with optional insulation

1/2 inch tempered insulated glass
3/4 inch tempered insulated glass

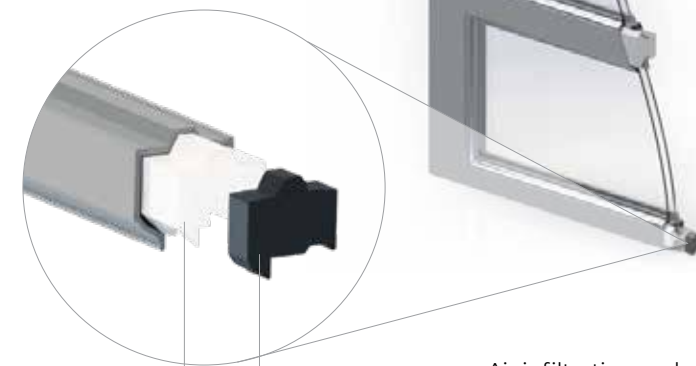

Polystyrene insulation*
Cross linked polyethylene*
*Optional

Air infiltration seal provides an energy efficient seal to help maintain building temperature

GLASS



Plain



Satin Stylist

Design YOUR DOOR



Colors	Raised Steel Panel	Short Panel Carriage	Long Panel Carriage	Recessed Panel	Ranch Panel	Flush Panel	Classic Panel	Series 26 Ribbed	FullView	FullView Stylist	Steel Overlay	Smooth & V-Groove Overlay
White	•	•	•	•	•	•	•	•	•	•	•	•
Almond	•	•	•	•	•	•	•	•	•	•	•	•
Sandtone	•	•	•	•	•	•	•	•	•	•	•	•
Tera-Bronze	•	•	•	•	•	•	•	•	•	•	•	•
Green	•	•	•	•	•	•	•	•	•	•	•	•
Coffee	•	•	•	•	•	•	•	•	•	•	•	•
Gray	•	•	•	•	•	•	•	•	•	•	•	•
Black	•	•	•	•	•	•	•	•	•	•	•	•
Light Oak	•	•	•	•	•	•	•	•	•	•	•	•
Dark Oak	•	•	•	•	•	•	•	•	•	•	•	•
Weathered Oak	•	•	•	•	•	•	•	•	•	•	•	•
Rosewood	•	•	•	•	•	•	•	•	•	•	•	•
Clear Anodized									•	•		
Deep Bronze Anodized									•	•		
Black Anodized									•	•		
Color Select	•	•	•	•	•	•	•	•	•	•	•	•
Windows												
Cascade	•					•						
Cathedral	•					•						
Plain	•	•	•	•	•	•	•				•	•
Prairie	•	•	•	•	•	•	•					
Sherwood	•					•						
Somerton		•	•	•	•	•	•				•	•
Stockton	•	•	•	•	•	•	•				•	•
Stockbridge		•	•	•	•	•	•					
Waterton	•					•						
Wyndbridge		•	•	•	•	•	•				•	•
Cambridge		•	•	•	•	•	•				•	•
Fullerton		•	•	•	•	•	•				•	•
Landscape, 24"x7", 24" x 12"						•						
Glass												
Plain	•	•	•	•	•	•	•	•	•	•	•	•
Obscure	•	•	•	•	•	•	•	•	•	•	•	•
Satin	•	•	•	•	•	•	•	•	•	•	•	•
Gray	•	•	•	•	•	•	•	•	•	•	•	•
Bronze	•	•	•	•	•	•	•	•	•	•	•	•
Low E	•	•	•	•	•	•	•	•	•	•	•	•
Double Dark	•	•	•	•	•	•	•	•	•	•	•	•
Satin Stylist										•		
Insulation												
ThermoGuard™	•	•	•	•	•	•	•	•	•	•	•	•
ThermoSteel™	•	•	•	•	•	•	•	•	•	•	•	•
TS-138	•	•	•	•	•	•	•	•	•	•	•	•
ValuCraft Plus	•											
Series 24	•	•	•	•	•	•	•	•	•	•	•	•
Series 26								•				
Hardware												
Standard		•	•	•	•		•				•	•
Adirondack											•	•

TRANSFORM THE LOOK OF YOUR HOME



Choose from an assortment of styles and features to perfectly compliment the exterior of your home. Go to midlandgaragedoor.com today to get started designing your quality door.

DESIGN NOW

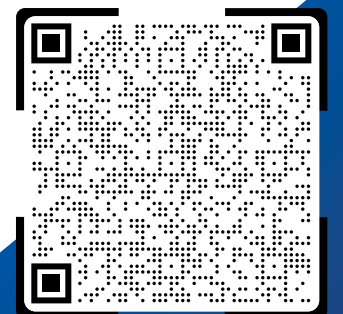

midlandgaragedoor.com

MIDLAND™

GARAGE DOOR MFG CO

NORTH DAKOTA
800.437.4056

MINNESOTA
800.521.0047

NEBRASKA
800.533.8358



Images may not depict current model options

© 2023 MIDLAND GARAGE DOOR MFG. CO. INC. ALL RIGHTS RESERVED.

MIDLAND GARAGE DOORS SOLD BY: