

AG SUPPLY

PARTS & PRODUCTS



See your local A&I Products reseller
or visit www.aiproducts.com

SECTION NAME	PAGE NUMBER
Accessories115-121
Chains/Sprockets/Pulleys/Hubs74-88
Hitch & PTO Parts128-144
Hydraulic Parts3-73
Ignition & Electrical Parts.89-96
Policies & Procedures and Freight Policy160-161
Quick Stem Valves158-159
Shop Supply97-114
Tillage Parts145-157
Wheel Rims / Hub & Spindle Assemblies122-127

Catalog Navigation Guide:

In the Table of Contents click on the section name that you want to navigate to.

Once in the Section Table of Contents click on the sub-section name that you want to navigate to.

To go back to the Section Table of Contents click on the half circle arrow icon  at the bottom of each page.

To go back to the main Table of Contents click on the half circle arrow icon  at the bottom of the Section Table of Contents pages.



Hydraulic Contents

HC SERIES

Male/Female NPTF	5-6
Female NPSM	6
Male O-Ring Boss	7-8
Male/Female JIC 37°	8-11
Male/Female SAE 45°	11-12
Flareless Compression SAE	13
Female Grease Connection	13
Male Standpipe	13
Male Standpipe Metric S	14
Male Inverted SAE 45°	14-15
Male/Female Seal Lok	15-17
DIN Light Universal Seat	17-18
Male/Female BSP Parallel Pipe	18
Male BSP Taper Pipe	19

HW SERIES

Male/Female NPTF Pipe	20-21
Female NPSM Pipe	21
Male Boss O-Ring	22
Male/Female JIC 37°	23-26
SAE 45° Swivel	26
SAE Male Inverted - SAE 45°	26
Male/Female Seal-Lok	27-29
SAE Flareless Compression	29
Caterpillar Flange Head	29-30
Code 61 Flange Head	30-31
Code 62 Flange Head	31
Din Light 24° Seat	32
Ag Coupler Adapters	49
Breakaway Couplers	49
Conversion Kit	50
Coupler Kit	39
Crimping Machines & Dies	33-34
Dust Caps & Plugs	39-40
Filter Assemblies	71
Flat Face Socket/Plug Set	51-52
Hose	34-35
Hose Assemblies	36-37
Hydraulic Adapters	53-60
Hydraulic Cylinders	68
Hydraulic Cylinder Parts Accessories	69
Hydraulic Multipliers & Replacement Parts	71-73
OEM Coupler Adapters	50
O-Rings	70-71
Protective Sleeves & Straps	38-39
Quick Couplers	41-48
Valves & Accessories	61-67

Click to go back to top



Hydraulic Fitting Part Number System

FJX90L-08-08 W

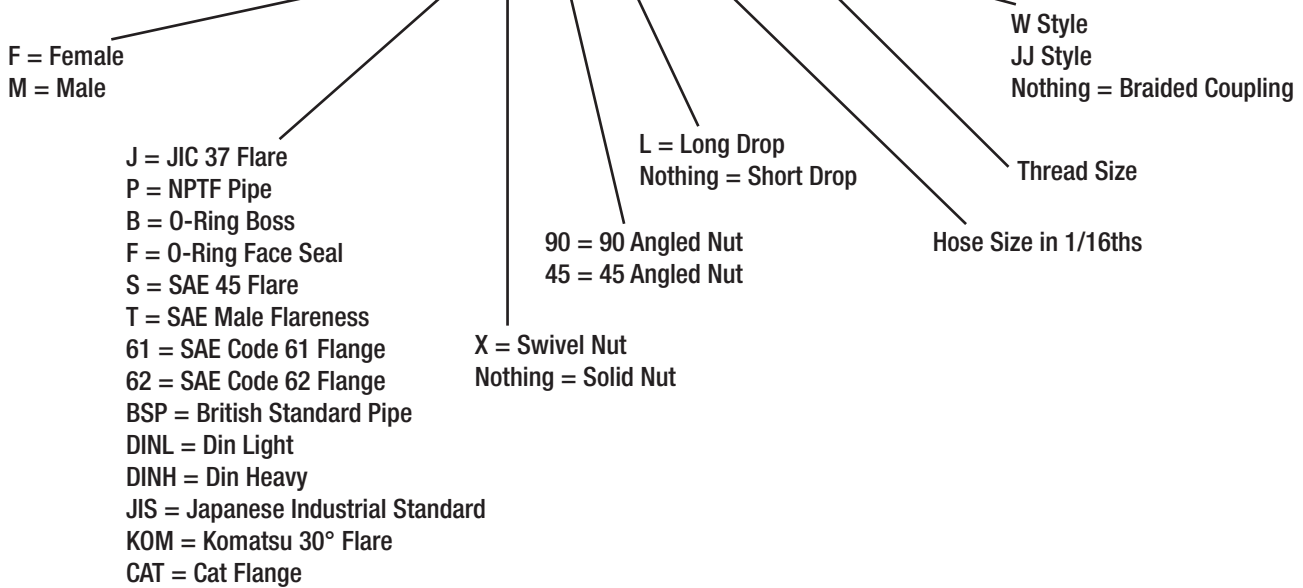

HC - Compression Style

HC Series

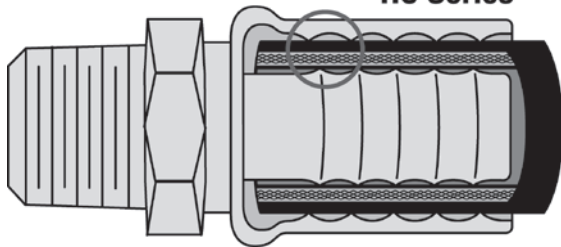

HW - Grip Style

HW Series

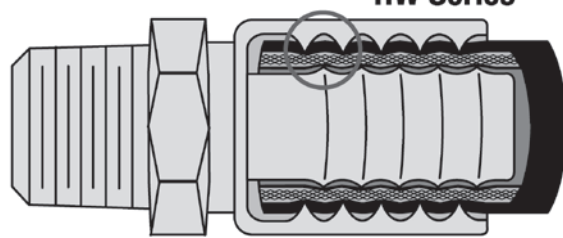

2 Wire Suggested Crimp Diameters for A&I Hose and Fittings

Hose Part #	Hose Size	Die	HC Micrometer Setting	HC Crimp Specification	HW Micrometer Setting	HW Crimp Specification
P100R16-4	1/4"	15	.875	.625 +/- .005	2.220	.678 +/- .005
P100R16-6	3/8"	18	.415	.725 +/- .005	2.190	.795 +/- .005
P100R16-8	1/2"	21	1.090	.870 +/- .005	3.000	.945 +/- .005
P100R16-10	5/8"	25	.530	1.005 +/- .005	Not Applicable	Not Applicable
P100R16-10	5/8"	28	Not Applicable	Not Applicable	2.300	1.180 +/- .005
P100R16-12	3/4"	28	1.210	1.150 +/- .005	3.620	1.245 +/- .005
P100R16-16	1"	37	.340	1.470 +/- .005	2.750	1.565 +/- .005

4 Wire Suggested Crimp Specifications

Hose Part #	Hose Size	Die	HW Micrometer Setting	HW Crimp Specification
A-38624SH-12	3/4"	31	2.500	1.32 +/- .005
A-38624SH-16	1"	39	2.400	1.63 +/- .005
A-38624SH-20	1 1/4"	49	1.500	1.99 +/- .005

NOTE: The Metric Micro-Crimp Adjuster on A&I Products crimpers is a direct reading micrometer. Add the setting on the micrometer to the closed diameter of the die set to obtain the finished crimp diameter. For example: With a 39mm die and the adjuster set at 3, the finished crimp diameter would be 42mm.

* This is a suggested crimp diameter, please use this as a guide line only. Machining tolerances on crimp dies and crimper wear do and will effect actual crimper settings.

Parts are not Original Equipment parts and are not sponsored, affiliated or otherwise connected with any major brand.

HC SERIES

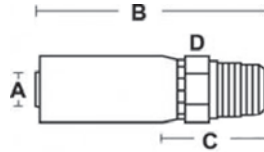

(HC-MP) Male NPTF Pipe - Rigid - Straight

PART	HOSE I.D.	THREAD SIZE	A	B	C	D
A-MP-04-02	1/4"	1/8 x 27	0.250"	2.134"	0.879"	9/16"
A-MP-04-04	1/4"	1/4 x 18	0.250"	2.315"	1.070"	9/16"
A-MP-04-06	1/4"	3/8 x 18	0.250"	2.409"	1.164"	11/16"
A-MP-04-08	1/4"	1/2 x 14	0.250"	2.656"	1.401"	7/8"
A-MP-06-04	3/8"	1/4 x 18	0.375"	2.670"	1.170"	11/16"
A-MP-06-06	3/8"	3/8 x 18	0.375"	2.665"	1.170"	11/16"
A-MP-06-08	3/8"	1/2 x 14	0.375"	2.917"	1.422"	7/8"
A-MP-08-06	1/2"	3/8 x 18	0.500"	2.743"	1.248"	7/8"
A-MP-08-08	1/2"	1/2 x 14	0.500"	2.995"	1.495"	7/8"
A-MP-08-12	1/2"	3/4 x 14	0.500"	2.995"	1.500"	1-1/8"
A-MP-10-08	5/8"	1/2 x 14	0.625"	3.011"	1.511"	1-1/8"
A-MP-10-12	5/8"	3/4 x 14	0.625"	3.011"	1.511"	1-1/8"
A-MP-12-08	3/4"	1/2 x 14	0.750"	3.104"	1.511"	1-1/8"
A-MP-12-12	3/4"	3/4 x 14	0.750"	3.104"	1.511"	1-1/8"
A-MP-12-16	3/4"	1 x 11-1/2	0.750"	3.294"	1.701"	1-3/8"
A-MP-16-12	1"	3/4 x 14	1.000"	3.261"	1.527"	1-1/8"
A-MP-16-16	1"	1 x 11-1/2	1.000"	3.451"	1.717"	1-3/8"

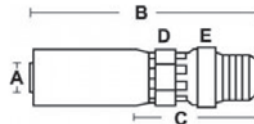

(HC-MPX) Male NPTF - Pipe Swivel - Straight

PART	HOSE I.D.	THREAD SIZE	A	B	C	D	E
A-MPX-04-02	1/4"	1/8 x 27	0.250"	2.590"	1.335"	9/16"	1/2"
A-MPX-04-04	1/4"	1/4 x 18	0.250"	2.875"	1.620"	9/16"	11/16"
A-MPX-04-06	1/4"	3/8 x 18	0.250"	2.880"	1.625"	9/16"	3/4"
A-MPX-06-04	3/8"	1/4 x 18	0.375"	3.196"	1.672"	11/16"	11/16"
A-MPX-06-06	3/8"	3/8 x 18	0.375"	3.201"	1.706"	11/16"	3/4"
A-MPX-06-08	3/8"	1/2 x 14	0.375"	3.401"	1.896"	11/16"	7/8"
A-MPX-08-06	1/2"	3/8 x 18	0.500"	3.309"	1.813"	7/8"	3/4"
A-MPX-08-08	1/2"	1/2 x 14	0.500"	3.533"	2.037"	7/8"	15/16"
A-MPX-12-12	3/4"	3/4 x 14	0.750"	3.695"	2.102"	1-1/8"	1-1/8"
A-MPX-16-16	1"	1 x 11-1/2	1.000"	4.115"	2.381"	1-3/8"	1-1/2"

Parts are not Original Equipment parts and are not sponsored, affiliated or otherwise connected with any major brand.

HYDRAULICS

HYDRAULICS

Fittings

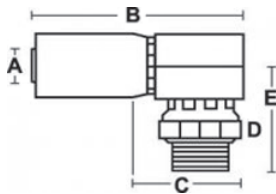

(HC-MPX90) Male NPTF - Pipe Swivel - 90°

PART	HOSE I.D.	THREAD SIZE	A	B	C	D	E
A-MPX90-04-04	1/4"	1/4 x 18	0.250"	2.312"	0.650"	11/16"	1.540"
A-MPX90-04-06	1/4"	3/8 x 18	0.250"	2.312"	0.650"	3/4"	1.540"
A-MPX90-06-04	3/8"	1/4 x 18	0.375"	2.766"	0.741"	11/16"	1.540"
A-MPX90-06-06	3/8"	3/8 x 8	0.375"	2.766"	0.741"	3/4"	1.637"
A-MPX90-06-08	3/8"	1/2 x 14	0.375"	2.766"	0.741"	7/8"	1.836"
A-MPX90-08-08	1/2"	1/2 x 14	0.500"	2.906"	0.875"	15/16"	1.920"
A-MPX90-12-12	3/4"	3/4 x 14	0.750"	3.630"	1.000"	1-1/8"	2.140"
A-MPX90-16-16	1"	1 x 11-1/2	1.000"	3.860"	1.251"	1-1/2"	2.575"

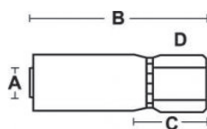

(HC-FP) Female NPTF Pipe - Rigid - Straight

PART	HOSE I.D.	THREAD SIZE	A	B	C	D
A-FP-04-02	1/4"	1/8 x 27	0.250"	2.340"	1.085"	5/8"
A-FP-04-04	1/4"	1/4 x 18	0.250"	2.344"	1.089"	11/16"
A-FP-04-06	1/4"	3/8 x 18	0.250"	2.438"	1.183"	7/8"
A-FP-06-04	1/4"	1/4 x 18	0.250"	2.699"	1.199"	11/16"
A-FP-06-06	3/8"	3/8 x 18	0.375"	2.699"	1.199"	7/8"
A-FP-06-08	3/8"	1/2 x 14	0.375"	2.855"	1.355"	1"
A-FP-08-08	1/2"	1/2 x 14	0.500"	2.933"	1.438"	1"
A-FP-12-08	3/4"	1/2 x 14	0.750"	2.830"	1.250"	1 1/4"
A-FP-12-12	3/4"	3/4 x 14	0.750"	3.138"	1.545"	1-1/4"
A-FP-16-16	1"	1 x 11-1/2	1.000"	3.485"	1.751"	1-1/2"

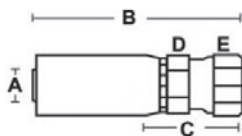

(HC-FPX) Female NPSM Pipe - Swivel - Straight

PART	HOSE I.D.	THREAD SIZE	A	B	C	D	E
A-FPX-04-04	1/4"	1/4 x 18	0.250"	2.370"	1.089"	9/16"	3/4"
A-FPX-06-06	3/8"	3/8 x 18	0.375"	2.344"	1.089"	11/16"	3/4"
A-FPX-08-08	1/2"	1/2 x 14	0.500"	2.699"	1.432"	11/16"	7/8"
A-FPX-12-12	3/4"	3/4" x 14	0.750"	2.927"	1.699"	1"	1"
A-FPX-16-16	1"	1 x 11-1/2"	1.000"	3.292"	1.780"	1-1/8"	1-1/4"

Parts are not Original Equipment parts and are not sponsored, affiliated or otherwise connected with any major brand.

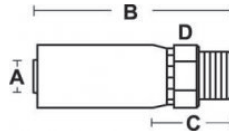

(HC-MB) Male O-Ring Boss - Rigid

PART	HOSE I.D.	THREAD SIZE	A	B	C	D
A-MB-04-04	1/4"	7/16 x 20	0.250"	2.110"	0.855"	5/8"
A-MB-04-05	1/4"	1/2 x 20	0.250"	2.110"	0.855"	5/8"
A-MB-04-06	1/4"	9/16 x 18	0.250"	2.146"	0.891"	11/16"
A-MB-06-06	3/8"	9/16 x 18	0.375"	2.496"	0.996"	11/16"
A-MB-06-08	3/8"	3/4 x 16	0.375"	2.543"	1.043"	13/16"
A-MB-06-10	3/8"	7/8 x 14	0.375"	2.651"	1.154"	1-1/16"
A-MB-08-08	1/2"	3/4 x 16	0.500"	2.683"	1.183"	1-1/8"
A-MB-08-10	1/2"	7/8 x 14	0.500"	2.745"	1.849"	1"
A-MB-08-12	1/2"	1-1/16 x 12	0.500"	2.844"	1.344"	1-1/4"
A-MB-10-10	5/8"	7/8 x 14	0.625"	2.761"	1.261"	1-1/4"
A-MB-10-12	5/8"	1-1/16 x 12	0.625"	2.860"	1.360"	1-1/4"
A-MB-12-12	3/4"	1-1/16 x 12	0.750"	2.953"	1.360"	1-1/4"
A-MB-12-16	3/4"	1-5/16 x 12	0.750"	2.920"	1.340"	1-1/2"
A-MB-16-16	1"	1-5/16 x 12	1.000"	3.210"	1.476"	1-1/2"

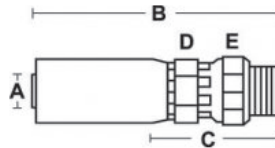

(HC-MBX) Male O-Ring Boss - Swivel

PART	HOSE I.D.	THREAD SIZE	A	B	C	D	E
A-MBX-04-04	1/4"	7/16 x 20	0.250"	2.750"	1.495"	9/16"	11/16"
A-MBX-04-05	1/4"	1/2 x 20	0.250"	2.780"	1.520"	9/16"	3/4"
A-MBX-04-06	1/4"	9/16 x 18	0.250"	2.790"	1.531"	9/16"	3/4"
A-MBX-06-06	3/8"	9/16 x 18	0.375"	3.110"	1.636"	11/16"	3/4"
A-MBX-06-08	3/8"	3/4 x 16	0.375"	3.180"	1.624"	11/16"	15/16"
A-MBX-08-08	1/2"	3/4 x 16	0.500"	3.280"	2.027"	7/8"	15/16"
A-MBX-08-10	1/2"	7/8 x 14	0.500"	3.490"	1.849"	7/8"	1"
A-MBX-12-12	3/4"	1-1/16 x 12	0.750"	3.915"	2.342"	1-1/8"	1-1/8"
A-MBX-16-16	1"	1-5/16 x 12	1.000"	3.980"	2.340"	1-3/8"	1-1/2"

Parts are not Original Equipment parts and are not sponsored, affiliated or otherwise connected with any major brand.

HYDRAULICS

Fittings

HYDRAULICS

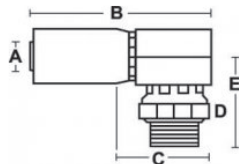

(HC-MBX90) Male O-Ring Boss - Swivel - 90° Elbow

PART	HOSE I.D.	THREAD SIZE	A	B	C	D	E
A-MBX90-04-06	1/4"	9/16 x 18	0.250"	2.312"	0.650"	3/4"	1.450"
A-MBX90-06-06	3/8"	9/16 x 18	0.375"	2.770"	0.741"	3/4"	1.543"
A-MBX90-06-08	3/8"	3/4 x 16	0.375"	2.770"	0.741"	15/16"	1.610"
A-MBX90-06-10	3/8"	7/8 x 14	0.375"	2.750"	0.725"	1"	1.61"
A-MBX90-08-08	1/2"	3/4 x 16	0.500"	2.910"	0.875"	15/16"	1.680"
A-MBX90-08-10	1/2"	7/8 x 14	0.500"	2.910"	0.875"	1"	1.740"
A-MBX90-12-12	3/4"	1-1/16 x 12	0.750"	3.630"	1.000"	1-1/8"	2.360"

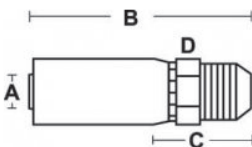

(HC-MJ) Male JIC 37° - Rigid - Straight

PART	HOSE I.D.	THREAD SIZE	A	B	C	D
A-MJ-04-04	1/4"	7/16 x 20	0.250"	2.300"	1.045"	9/16"
A-MJ-04-05	1/4"	1/2 x 20	0.250"	2.305"	1.050"	9/16"
A-MJ-04-06	1/4"	9/16 x 18	0.250"	2.305"	1.050"	9/16"
A-MJ-06-04	3/8"	7/16" x 20	0.375"	2.655"	1.155"	11/16"
A-MJ-06-06	3/8"	9/16 x 18	0.375"	2.661"	1.166"	11/16"
A-MJ-06-08	3/8"	3/4 x 16	0.375"	2.762"	1.267"	3/4"
A-MJ-06-10	3/8"	7/8 x 14	0.375"	2.935"	1.435"	7/8"
A-MJ-08-06	1/2"	9/16 x 18	0.500"	2.720"	1.380"	7/8"
A-MJ-08-08	1/2"	3/4 x 16	0.500"	2.845"	1.345"	7/8"
A-MJ-08-10	1/2"	7/8 x 14	0.500"	3.003"	1.508"	15/16"
A-MJ-08-12	1/2"	1-1/16 x 12	0.500"	3.109"	1.609"	1-1/8"
A-MJ-10-10	5/8"	7/8 x 14	0.625"	3.019"	1.519"	1-1/8"
A-MJ-10-12	5/8"	1-1/16 x 12	0.625"	3.125"	1.625"	1-1/16"
A-MJ-12-10	3/4"	7/8 x 14	0.750"	3.061"	1.470"	1-1/8"
A-MJ-12-12	3/4"	1/16 x 12	0.750"	3.218"	1.625"	1-1/8"
A-MJ-12-14	3/4"	1-3/16 x 12	0.750"	3.244"	1.651"	1-1/4"
A-MJ-12-16	3/4"	1-5/16 x 12	0.750"	3.265"	1.672"	1-3/8"
A-MJ-16-16	1"	1-5/16 x 12	1.000"	3.422"	1.688"	1-3/8"

Parts are not Original Equipment parts and are not sponsored, affiliated or otherwise connected with any major brand.

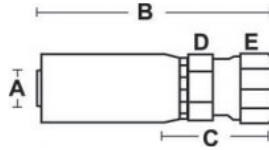

(HC-FJX) Female JIC 37° - Swivel - Straight

PART	HOSE I.D.	THREAD SIZE	A	B	C	D	E
A-FJX-04-03	1/4"	3/8 x 24	0.250"	2.437"	1.187"	5/8"	9/16"
A-FJX-04-04	1/4"	7/16 x 20	0.250"	2.355"	1.100"	9/16"	9/16"
A-FJX-04-05	1/4"	1/2 x 20	0.250"	2.500"	1.245"	9/16"	5/8"
A-FJX-04-06	1/4"	9/16 x 18	0.250"	2.454"	1.194"	9/16"	11/16"
A-FJX-06-04	3/8"	7/16 x 20	0.375"	2.616"	1.116"	11/16"	9/16"
A-FJX-06-05	3/8"	1/2 x 20	0.375"	2.761"	1.261"	3/4"	5/8"
A-FJX-06-06	3/8"	9/16 x 18	0.375"	2.699"	1.360"	11/16"	11/16"
A-FJX-06-08	3/8"	3/4 x 16	0.375"	2.855"	1.344"	11/16"	7/8"
A-FJX-06-10	3/8"	7/8 x 14	0.375"	3.011"	1.516"	7/8"	1-1/16"
A-FJX-08-06	1/2"	9/16 x 18	0.500"	2.935"	1.433"	7/8"	7/8"
A-FJX-08-08	1/2"	3/4 x 16	0.500"	2.854"	1.594"	7/8"	7/8"
A-FJX-08-10	1/2"	7/8 x 14	0.500"	3.089"	1.594"	7/8"	1-1/16"
A-FJX-08-12	1/2"	1-1/16 x 12	0.500"	3.185"	1.690"	1-1/8"	1-1/4"
A-FJX-10-08	5/8"	3/4 x 16	0.625"	3.105"	1.605"	1-1/8"	7/8"
A-FJX-10-10	5/8"	7/8 x 14	0.625"	3.167"	1.667"	1-1/8"	1-1/16"
A-FJX-10-12	5/8"	1-1/16 x 12	0.625"	3.192"	1.692"	1-1/8"	1-1/4"
A-FJX-12-08	3/4"	3/4 x 16	0.750"	3.198"	1.605"	1-1/8"	7/8"
A-FJX-12-10	3/4"	7/8 x 14	0.750"	3.260"	1.667"	1-1/8"	1-1/16"
A-FJX-12-12	3/4"	1-1/16 x 12	0.750"	3.251"	1.704"	1-1/8"	1-1/4"
A-FJX-12-14	3/4"	1-3/16 x 12	0.750"	3.354"	1.761"	1-3/8"	1-1/2"
A-FJX-12-16	3/4"	1-5/16 x 12	0.750"	3.234"	1.665"	1-3/8"	1-1/2"
A-FJX-16-12	1"	1-1/16 x 12	1.000"	3.408"	1.715"	1-3/8"	1-1/4"
A-FJX-16-16	1"	1-5/16 x 12	1.000"	3.391"	1.657"	1-3/8"	1-1/2"
A-FJX-16-20	1"	1-5/8 x 12	1.000"	3.699"	1.970"	1-11/16"	2"

Parts are not Original Equipment parts and are not sponsored, affiliated or otherwise connected with any major brand.

HYDRAULICS

Fittings

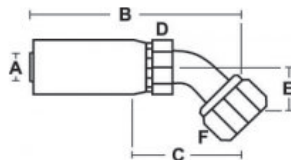

(HC-FJX45) Female JIC 37° - Swivel - 45° Elbow

PART	HOSE I.D.	THREAD SIZE	A	B	C	D	E	F
A-FJX45-04-04	1/4"	7/16 x 20	0.250"	3.135"	1.880"	5/8"	0.394"	9/16"
A-FJX45-04-05	1/4"	1/2 x 20	0.250"	3.165"	1.910"	5/8"	0.394"	5/8"
A-FJX45-04-06	1/4"	9/16 x 18	0.250"	3.214"	1.959"	5/8"	0.433"	11/16"
A-FJX45-06-04	3/8"	7/16 x 20	0.375"	2.813"	1.303"	3/4"	0.467"	9/16"
A-FJX45-06-05	3/8"	1/2 x 20	0.375"	3.426"	1.926"	11/16"	0.394"	5/8"
A-FJX45-06-06	3/8"	9/16 x 18	0.375"	3.470"	1.970"	11/16"	0.433"	11/16"
A-FJX45-06-08	3/8"	3/4 x 16	0.375"	3.810"	2.310"	3/4"	0.591"	7/8"
A-FJX45-08-08	1/2"	3/4 x 16	0.500"	3.910"	2.410"	7/8"	0.590"	7/8"
A-FJX45-08-10	1/2"	7/8 x 14	0.500"	3.560"	2.060"	7/8"	0.630"	1"
A-FJX45-10-10	5/8"	7/8 x 14	0.625"	3.810"	2.310"	1-1/8"	0.630"	1"
A-FJX45-10-12	5/8"	1-1/16 x 12	0.625"	4.329"	2.450"	1-1/8"	1.118"	1-1/4"
A-FJX45-12-12	3/4"	1-1/16 x 12	0.750"	3.903"	2.559"	1-1/8"	0.827"	1-1/4"
A-FJX45-12-16	3/4"	1-5/16 x 12	0.750"	4.461"	2.691"	1-3/8"	1.146"	1-1/2"
A-FJX45-16-12	1"	1-1/16 x 12	1.000"	5.250"	3.130"	1-5/16"	1.150"	1-1/4"
A-FJX45-16-16	1"	1-5/16 x 12	1.000"	4.424"	2.820"	1-3/8"	0.950"	1-1/2"

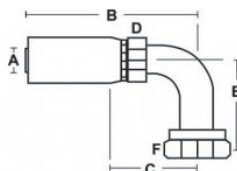

(HC-FJX90) Female JIC 37° - Swivel - 90° Elbow

PART	HOSE I.D.	THREAD SIZE	A	B	C	D	E	F
A-FJX90-04-04	1/4"	7/16 x 20	0.250"	3.035"	1.780"	5/8"	0.830"	9/16"
A-FJX90-04-05	1/4"	1/2 x 20	0.250"	3.065"	1.810"	5/8"	0.830"	5/8"
A-FJX90-04-06	1/4"	9/16 x 18	0.250"	3.165"	1.910"	5/8"	0.910"	11/16"
A-FJX90-06-04	3/8"	7/16 x 20	0.375"	2.563"	1.063"	3/4"	0.880"	9/16"
A-FJX90-06-06	3/8"	9/16 x 18	0.375"	3.380"	1.880"	3/4"	0.860"	11/16"
A-FJX90-06-08	3/8"	3/4 x 16	0.375"	3.630"	2.130"	3/4"	1.120"	7/8"
A-FJX90-08-06	1/2"	9/16 x 18	0.500"	2.870"	1.182"	7/8"	1.130"	11/16"
A-FJX90-08-08	1/2"	3/4 x 16	0.500"	3.750"	2.250"	7/8"	1.130"	7/8"
A-FJX90-08-10	1/2"	7/8 x 14	0.500"	3.250"	1.750"	7/8"	1.230"	1"
A-FJX90-08-12	1/2"	1-1/16 x 12	0.500"	3.938"	2.250"	1-1/8"	1.830"	1-1/4"
A-FJX90-10-10	5/8"	7/8 x 14	0.625"	3.350"	2.000"	1-1/16"	1.260"	1"
A-FJX90-10-12	5/8"	1-1/16 x 12	0.625"	3.943"	2.063"	1-1/8"	2.280"	1-1/4"
A-FJX90-12-10	3/4"	7/8 x 14	0.750"	3.484"	1.891"	1-1/8"	1.230"	1"
A-FJX90-12-12	3/4"	1-1/16 x 12	0.750"	3.761"	2.296"	1-1/8"	1.830"	1-1/4"
A-FJX90-12-16	3/4"	1-5/16 x 12	0.750"	4.193"	2.313"	1-3/8"	2.500"	1-1/2"
A-FJX90-16-16	1"	1-5/16 x 12	1.000"	4.424"	2.129"	1-3/8"	2.210"	1-1/2"

Parts are not Original Equipment parts and are not sponsored, affiliated or otherwise connected with any major brand.

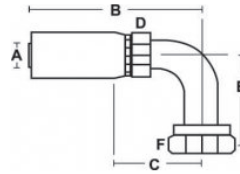

(HC-FJX90L) Female JIC 37° - Swivel - 90° Elbow Long

PART	HOSE I.D.	THREAD SIZE	A	B	C	D	E	F
A-FJX90L-04-04	1/4"	7/16 x 20	0.250"	1.810"	1.720"	5/8"	0.830"	9/16"
A-FJX90L-04-05	1/4"	1/2 x 20	0.250"	3.160"	1.810"	5/8"	1.770"	5/8"
A-FJX90L-04-06	1/4"	9/16 x 18	0.250"	2.443"	1.188"	5/8"	2.180"	11/16"
A-FJX90L-06-06	3/8"	9/16 x 18	0.375"	3.380"	1.188"	11/16"	2.126"	11/16"
A-FJX90L-06-08	3/8"	3/4 x 16	0.375"	3.630"	2.130"	3/4"	2.520"	7/8"
A-FJX90L-08-08	1/2"	3/4 x 16	0.500"	3.750"	2.250"	7/8"	2.520"	7/8"
A-FJX90L-08-10	1/2"	7/8 x 14	0.500"	3.500"	2.000"	7/8"	2.755"	1"
A-FJX90L-12-12	3/4"	1-1/16 x 12	0.750"	3.777"	2.420"	1-3/8"	4.330"	1-1/2"
A-FJX90L-16-16	1"	1-5/16 x 12	1.000"	4.170"	2.436"	1-3/8"	4.330"	1-1/2"

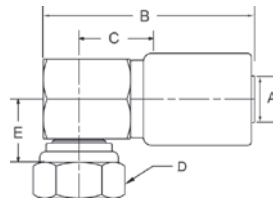

(HC-FJX90B) Female JIC 37° - Swivel - 90° Elbow Block

PART	HOSE I.D.	THREAD SIZE	A	B	C	D	E
A-FJX90B-06-06	3/8"	9/16 x 18	0.375"	3.010"	1.110"	11/16"	1.160"
A-FJX90B-08-08	1/2"	3/4 x 16	0.500"	2.640"	0.800"	7/8"	1.360"
A-FJX90B-08-10	1/2"	7/8 x 14	0.500"	2.640"	0.800"	1"	1.420"
A-FJX90B-12-12	3/4"	1-1/16 x 12	0.750"	4.300"	1.670"	1-1/4"	1.620"

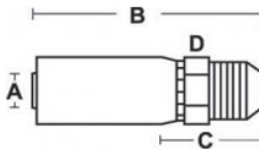

(HC-MS) Male SAE 45° - Rigid

PART	HOSE I.D.	THREAD SIZE	A	B	C	D
A-MS-06-06	3/8"	5/8 x 18	0.375"	2.725"	1.225"	3/4"
A-MS-12-12	3/4"	1-1/16 x 14	0.750"	3.354"	1.761"	1-1/8"

Parts are not Original Equipment parts and are not sponsored, affiliated or otherwise connected with any major brand.

HYDRAULICS

Fittings

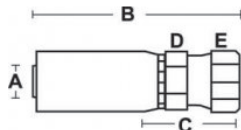

(HC-FSX) Female SAE 45° - Swivel - Straight

PART	HOSE I.D.	THREAD SIZE	A	B	C	D	E
A-FSX-04-06	1/4"	5/8 x 18	0.250"	2.595"	1.340"	11/16"	3/4"
A-FSX-06-06	3/8"	5/8 x 18	0.375"	2.856"	1.356"	11/16"	3/4"
A-FSX-12-12	3/4"	1-1/16 x 14	0.750"	3.251"	1.658"	1-1/8"	1-1/4"

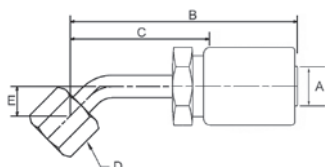

(HC-FSX45) Female SAE 45° - Swivel - 45° Elbow

PART	HOSE I.D.	THREAD SIZE	A	B	C	D	E
A-FSX45-06-05	3/8"	1/2 x 20	0.375"	3.426"	1.926"	5/8"	0.394"
A-FSX45-06-06	3/8"	5/8 x 18	0.375"	2.835"	1.970"	3/4"	0.430"
A-FSX45-12-12	3/4"	1-1/16 x 14	0.750"	4.329"	2.449"	1-1/4"	1.120"

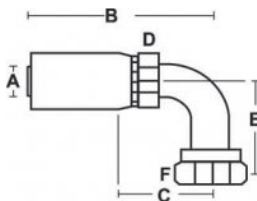

(HC-FSX90) Female SAE 45° - Swivel - 90° Elbow

PART	HOSE I.D.	THREAD SIZE	A	B	C	D	E
A-FSX90-06-06	3/4"	3/8"	0.375"	2.780"	1.880"	11/16"	0.906"
A-FSX90-10-12	1-1/4"	5/8"	0.625"	3.720"	2.500"	1-1/8"	1.830"
A-FSX90-12-12	1-1/4"	3/4"	0.750"	3.875"	1.980"	1-1/8"	2.310"

Parts are not Original Equipment parts and are not sponsored, affiliated or otherwise connected with any major brand.

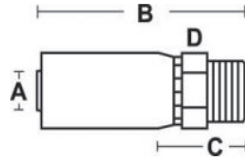

(HC-MT) Flareless Compression SAE J514

PART	HOSE I.D.	THREAD SIZE	A	B	C	D
A-MT-04-04	1/4"	7/16 x 20	0.250"	2.178"	0.923"	9/16"
A-MT-04-05	1/4"	1/2 x 20	0.250"	2.178"	0.923"	5/8"
A-MT-04-06	1/4"	9/16 x 18	0.250"	2.194"	0.393"	3/4"
A-MT-06-05	3/8"	1/2 x 20	0.375"	2.529"	1.029"	3/4"
A-MT-06-06	3/8"	9/16 x 18	0.375"	2.439"	0.955"	3/4"
A-MT-06-08	3/8"	3/4 x 16	0.375"	2.579"	1.079"	3/4"
A-MT-08-08	1/2"	3/4 x 16	0.500"	2.657"	1.157"	7/8"
A-MT-08-10	1/2"	7/8 x 14	0.500"	2.720"	1.220"	15/16"
A-MT-12-12	3/4"	1-1/16 x 16	0.750"	2.952"	1.359"	1-1/4"
A-MT-12-16	3/4"	1-5/16" x 12	0.750"	3.028"	1.435"	1-1/2"
A-MT-16-16	1"	1-5/16 x 12	1.000"	3.179"	1.445"	1-1/2"

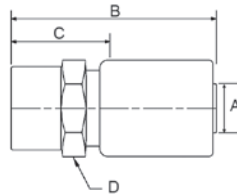

(HC-GT) Female Grease Connection - Rigid - Straight

PART	HOSE I.D.	THREAD SIZE	A	B	C	D
A-GT-04-08	1/4"	1/2 x 27	0.250"	2.340"	1.085"	3/4"

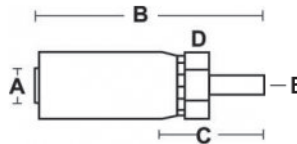

(HC-MW) Male Standpipe - Rigid - Straight

PART	HOSE I.D.	THREAD SIZE	A	B	C	D	E
A-MW-04-04	1/4"	N/A	0.250"	2.720"	1.465"	5/8"	1/4"
A-MW-04-06	1/4"	N/A	0.250"	2.910"	1.655"	5/8"	3/8"
A-MW-06-06	3/8"	N/A	0.375"	3.155"	1.671"	3/4"	3/8"
A-MW-06-08	3/8"	N/A	0.375"	3.420"	1.920"	3/4"	1/2"
A-MW-08-08	1/2"	N/A	0.500"	3.608"	2.039"	7/8"	1/2"
A-MW-08-10	1/2"	N/A	0.500"	3.821"	2.130"	7/8"	5/8"
A-MW-12-12	3/4"	N/A	0.750"	4.855"	2.975"	1-1/8"	3/4"
A-MW-16-16	1"	N/A	1.000"	5.365"	3.025"	1-3/8"	1"

Parts are not Original Equipment parts and are not sponsored, affiliated or otherwise connected with any major brand.

HYDRAULICS

Fittings

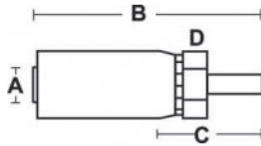

(HC-MMSP) Male Standpipe Metric S - Rigid - Straight

PART	HOSE I.D.	THREAD SIZE	A	B	C	D	E
A-MMSP-10-20	5/8"	N/A	0.625"	3.620"	2.220"	1-1/8"	20mm

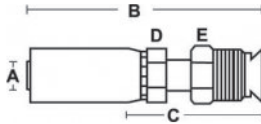

(HC-MIX) Male Inverted SAE 45° Swivel - Straight

PART	HOSE I.D.	THREAD SIZE	A	B	C	D	E
A-MIX-04-03	1/4"	3/8 x 24	0.250"	3.005"	1.750"	9/16"	3/8"
A-MIX-04-04	1/4"	7/16 x 24	0.250"	3.195"	1.959"	5/8"	7/16"
A-MIX-04-05	1/4"	1/2 x 20	0.250"	3.255"	2.000"	5/8"	1/2"
A-MIX-04-06	1/4"	5/8 x 18	0.250"	2.900"	1.650"	5/8"	5/8"
A-MIX-05-05	5/16"	1/2 x 20	0.312"	3.410"	2.060"	5/8"	1/2"
A-MIX-05-06	5/16"	5/8 x 18	0.312"	3.750"	2.285"	5/8"	5/8"
A-MIX-06-04	3/8"	7/16 x 24	0.375"	3.475"	1.975"	11/16"	7/16"
A-MIX-06-05	3/8"	1/2 x 20	0.375"	3.170"	1.810"	3/4"	1/2"
A-MIX-06-06	3/8"	5/8 x 18	0.375"	3.156"	2.323"	3/4"	5/8"
A-MIX-06-07	3/8"	11/16 x 18	0.375"	3.162"	1.665"	3/4"	11/16"
A-MIX-06-08	3/8"	3/4 x 16	0.375"	3.415"	1.915"	3/4"	3/4"
A-MIX-08-08	1/2"	3/4 x 18	0.500"	3.810"	2.310"	7/8"	3/4"

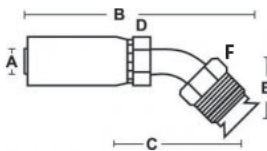

(HC-MIX45) Male Inv. SAE 45° - Swivel - 45° Elbow

PART	HOSE I.D.	THREAD SIZE	A	B	C	D	E	F
A-MIX45-04-03	1/4"	3/8 x 24	0.250"	2.945"	1.690"	9/16"	0.720"	3/8"
A-MIX45-04-04	1/4"	7/16 x 24	0.250"	2.728"	1.463"	5/8"	0.600"	7/16"
A-MIX45-04-05	1/4"	1/2 x 20	0.250"	2.862"	1.593"	5/8"	0.685"	1/2"
A-MIX45-06-05	3/8"	1/2 x 20	0.375"	3.170"	1.810"	3/4"	0.880"	1/2"
A-MIX45-06-06	3/8"	5/8 x 18	0.375"	3.156"	1.650"	3/4"	0.780"	5/8"
A-MIX45-06-08	3/8"	3/4 x 18	0.375"	3.415"	1.915"	3/4"	0.960"	3/4"
A-MIX45-08-08	1/2"	3/4 x 18	0.500"	3.592"	1.886"	7/8"	0.960"	3/4"

Parts are not Original Equipment parts and are not sponsored, affiliated or otherwise connected with any major brand.

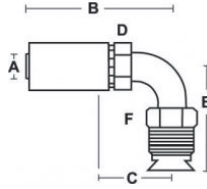

(HC-MIX90) Male Inv. SAE 45° - Swivel - 90° Elbow

PART	HOSE I.D.	THREAD SIZE	A	B	C	D	E	F
A-MIX90-04-03	1/4"	3/8 x 24	0.250"	3.005"	1.750"	9/16"	1.380"	3/8"
A-MIX90-04-04	1/4"	7/16 x 24	0.250"	3.280"	1.940"	5/8"	1.470"	7/16"
A-MIX90-04-05	1/4"	1/2 x 20	0.250"	3.520"	2.160"	5/8"	1.660"	1/2"
A-MIX90-06-04	3/8"	7/16 x 24	0.375"	2.630"	1.130"	11/16"	1.470"	7/16"
A-MIX90-06-05	3/8"	1/2 x 20	0.375"	3.175"	1.675"	3/4"	1.320"	1/2"
A-MIX90-06-06	3/8"	5/8 x 18	0.375"	4.19"	1.195"	3/4"	1.690"	5/8"
A-MIX90-06-07	3/8"	11/16 x 18	0.375"	2.760"	1.160"	3/4"	1.300"	11/16"
A-MIX90-06-08	3/8"	3/4 x 18	0.375"	2.905"	1.405"	3/4"	0.780"	3/4"
A-MIX90-08-08	1/2"	3/4 x 18	0.500"	3.100"	1.405"	7/8"	0.780"	3/4"

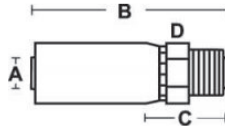

(HC-MF) Male Seal Lok - Rigid - Straight (w/ O-Ring)

PART	HOSE I.D.	THREAD SIZE	A	B	C	D
A-MF-04-04	1/4"	9/16 x 18	0.250"	2.338"	1.070"	5/8"
A-MF-04-06	1/4"	11/16 x 16	0.250"	2.190"	0.940"	11/16"
A-MF-06-06	3/8"	11/16 x 16	0.375"	2.452"	0.952"	11/16"
A-MF-06-08	3/8"	13/16 x 16	0.375"	2.520"	1.020"	7/8"
A-MF-08-08	1/2"	13/16 x 16	0.500"	2.593"	1.093"	7/8"
A-MF-08-10	1/2"	1 x 14	0.500"	2.590"	1.250"	1-1/16"
A-MF-08-12	1/2"	1-3/16 x 12	0.500"	2.915"	1.415"	1-1/4"
A-MF-10-10	5/8"	1 x 14	0.625"	2.870"	1.370"	1-1/16"
A-MF-10-12	5/8"	1-3/16 x 12	0.625"	2.930"	1.430"	1-1/4"
A-MF-12-16	3/4"	1-7/16 x 12	0.750"	3.040"	1.450"	1-1/2"
A-MF-16-16	1"	1-7/16 x 12	1.000"	3.199"	1.465"	1-1/2"

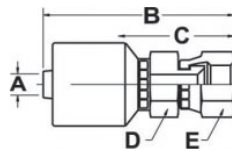

(HC-FFXT) Female Seal Lok - Swivel - Straight - Long

PART	HOSE I.D.	THREAD SIZE	A	B	C	D	E
A-FFXT-04-04	1/4"	9/16 x 18	0.250"	2.565"	1.310"	9/16"	11/16"
A-FFXT-06-06	3/8"	11/16 x 16	0.375"	2.798"	1.298"	11/16"	13/16"
A-FFXT-08-08	1/2"	13/16 x 16	0.500"	3.029"	1.529"	7/8"	15/16"
A-FFXT-12-12	3/4"	1-3/16 x 12	0.750"	3.663"	2.070"	1-1/8"	1-3/8"

Parts are not Original Equipment parts and are not sponsored, affiliated or otherwise connected with any major brand.

HYDRAULICS

Fittings

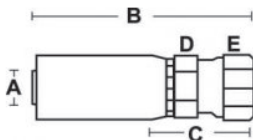

(HC-FFX) Female Seal Lok - Swivel - Straight - Short

PART	HOSE I.D.	THREAD SIZE	A	B	C	D	E
A-FFX-04-04	1/4"	9/16 x 18	0.250"	2.314"	1.059"	9/16"	11/16"
A-FFX-04-06	1/4"	11/16 x 16	0.250"	2.410"	1.200"	11/16"	13/16"
A-FFX-06-04	3/8"	9/16 x 18	0.375"	2.703"	1.203"	3/4"	11/16"
A-FFX-06-06	3/8"	11/16 x 16	0.375"	2.671"	1.145"	11/16"	13/16"
A-FFX-06-08	3/8"	13/16 x 16	0.375"	2.841"	0.700"	7/8"	15/16"
A-FFX-08-06	1/2"	11/16 x 16	0.500"	2.876"	1.425"	7/8"	13/16"
A-FFX-08-08	1/2"	13/16 x 16	0.500"	2.919"	1.904"	7/8"	15/16"
A-FFX-08-10	1/2"	1 x 14	0.500"	3.114"	1.602"	15/16"	1-1/8"
A-FFX-08-12	1/2"	1 x 14	0.500"	3.210"	1.170"	1-1/8"	1-3/8"
A-FFX-10-10	5/8"	1 x 14	0.625"	3.128"	1.628"	1-1/8"	1-1/8"
A-FFX-10-12	5/8"	1-3/16 x 12	0.625"	3.230"	1.730"	1-1/8"	1-3/8"
A-FFX-12-10	3/4"	1 x 14	0.750"	3.214"	1.621"	1-1/8"	1-1/8"
A-FFX-12-12	3/4"	1-3/16 x 12	0.750"	3.230"	1.730"	1-1/8"	1-3/8"
A-FFX-12-16	3/4"	1-7/16 x 12	0.750"	3.376"	1.783"	1-1/4"	1-5/8"
A-FFX-16-16	1"	1-7/16 x 12	1.000"	3.609"	1.901"	1-3/8"	1-5/8"
A-FFX-16-20	1"	1-11/16 x 12	1.000"	3.603"	1.869"	1-5/8"	1-7/8"

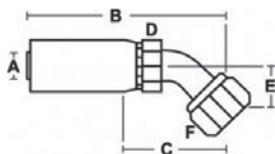

(HC-FFX45) Female Seal Lok - Swivel - 45° Elbow

PART	HOSE I.D.	THREAD SIZE	A	B	C	D	E	F
A-FFX45-04-04	1/4"	9/16 x 18	0.250"	3.135"	1.880"	5/8"	0.390"	11/16"
A-FFX45-04-06	1/4"	11/16 x 16	0.250"	3.225"	1.970"	5/8"	0.440"	13/16"
A-FFX45-06-06	3/8"	11/16 x 16	0.375"	3.470"	1.970"	3/4"	0.433"	13/16"
A-FFX45-06-08	3/8"	13/16 x 16	0.375"	3.427"	2.310"	3/4"	0.590"	15/16"
A-FFX45-08-06	1/2"	11/16 x 16	0.500"	3.578"	2.078"	7/8"	0.433"	13/16"
A-FFX45-08-08	1/2"	13/16 x 16	0.500"	3.500"	2.000"	7/8"	0.590"	15/16"
A-FFX45-08-10	1/2"	1 x 14	0.500"	3.720"	2.210"	7/8"	0.630"	1-1/8"
A-FFX45-10-10	5/8"	1 x 14	0.625"	3.848"	1.968"	1-1/16"	0.780"	1-1/8"
A-FFX45-10-12	5/8"	1-3/16 x 12	0.625"	4.329"	2.449"	1-1/8"	1.120"	1-3/8"
A-FFX45-12-10	3/4"	1 x 14	0.750"	3.950"	2.360"	1-1/8"	0.630"	1-1/8"
A-FFX45-12-12	3/4"	1-3/16 x 12	0.750"	4.033"	2.214"	1-1/8"	0.830"	1-3/8"
A-FFX45-12-16	3/4"	1-7/16 x 12	0.750"	4.540"	2.950"	1-1/8"	0.970"	1-5/8"
A-FFX45-16-16	1"	1-7/16 x 12	1.000"	3.090"	2.831"	1-3/8"	1.150"	1-5/8"
A-FFX45-16-20	1"	1-11/16 x 12	1.000"	5.519"	3.239"	1-3/8"	1.300"	1-7/8"

Parts are not Original Equipment parts and are not sponsored, affiliated or otherwise connected with any major brand.

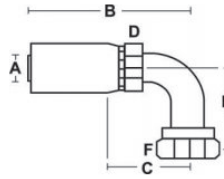

(HC-FFX90) Female Seal Lok - Swivel 90° Elbow

PART	HOSE I.D.	THREAD SIZE	A	B	C	D	E	F
A-FFX90-04-04	1/4"	9/16 x 18	0.250"	2.975"	1.720"	5/8"	0.820"	11/16"
A-FFX90-04-06	1/4"	11/16 x 16	0.250"	3.095"	1.869"	5/8"	0.906"	13/16"
A-FFX90-06-04	3/8"	9/16 x 18	0.375"	3.24"	1.736"	11/16"	0.820"	11/16"
A-FFX90-06-06	3/8"	11/16 x 16	0.375"	3.380"	1.880"	11/16"	0.905"	13/16"
A-FFX90-06-08	3/8"	13/16 x 16	0.375"	3.340"	1.840"	3/4"	1.141"	15/16"
A-FFX90-08-06	1/2"	11/16 x 16	0.500"	3.488"	1.988"	7/8"	0.910"	13/16"
A-FFX90-08-08	1/2"	13/16 x 16	0.500"	3.310"	1.810"	7/8"	1.140"	15/16"
A-FFX90-08-10	1/2"	1 x 14	0.500"	3.630"	2.214"	7/8"	1.260"	1-1/8"
A-FFX90-10-10	5/8"	1 x 14	0.625"	3.317"	1.437"	1-1/16"	1.260"	1-1/8"
A-FFX90-10-12	5/8"	1-3/16 x 12	0.625"	3.770"	1.897"	1-1/8"	1.880"	1-3/8"
A-FFX90-12-12	3/4"	1-3/16 x 12	0.750"	3.933"	2.340"	1-1/8"	1.890"	1-3/8"
A-FFX90-12-16	3/4"	1-7/16 x 12	0.750"	4.188"	2.418"	1-3/8"	2.630"	1-5/8"
A-FFX90-16-16	1"	1-7/16 x 12	1.000"	4.574"	2.439"	1-3/8"	2.210"	1-5/8"

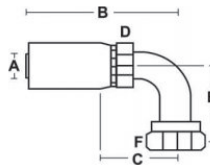

(HC-FFX90L) Female Seal Lok - Swivel - 90° Elbow Long

PART	HOSE I.D.	THREAD SIZE	A	B	C	D	E	F
A-FFX90L-04-04	1/4"	9/16 x 18	0.250"	2.323"	1.068"	5/8"	1.810"	11/16"
A-FFX90L-06-06	3/8"	11/16 x 16	0.375"	3.380"	1.880"	3/4"	2.130"	13/16"
A-FFX90L-06-08	3/8"	13/16 x 16	0.375"	3.677"	2.177"	3/4"	2.520"	15/16"
A-FFX90L-08-08	1/2"	13/16 x 16	0.500"	3.750"	2.250"	7/8"	2.520"	15/16"
A-FFX90L-08-10	1/2"	1 x 14	0.500"	3.709"	2.209"	7/8"	2.755"	1-1/8"
A-FFX90L-10-10	5/8"	1 x 14	0.625"	3.905"	2.025"	1-1/8"	2.770"	1-1/8"
A-FFX90L-10-12	5/8"	1-3/16 x 12	0.625"	3.716"	2.216"	1-1/8"	3.830"	1-3/8"
A-FFX90L-12-12	3/4"	1-3/16 x 12	0.750"	3.771"	2.000"	1-1/8"	3.790"	1-3/8"
A-FFX90L-16-16	1"	1-7/16 x 12	1.000"	4.648"	2.368"	1-3/8"	4.500"	1-5/8"

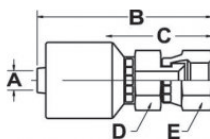

(HC-F-DINLX) DIN Light Universal Seat - Female - Swivel

PART	HOSE I.D.	THREAD SIZE	A	B	C	D	E
A-F-DINLX-06-18	M18 X 1.5		0.375"	2.730"	1.240"	.6875"	15/16"

Parts are not Original Equipment parts and are not sponsored, affiliated or otherwise connected with any major brand.

HYDRAULICS

Fittings

HYDRAULICS

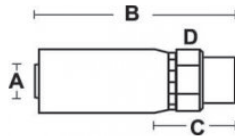

(HC-M-DINLX) DIN Light Universal Seat - Male - Rigid

PART	HOSE I.D.	THREAD SIZE	A	B	C	D
A-M-DINLX-04-14	1/4"	M14 x 1.5	0.250"	2.144"	0.889"	5/8"
A-M-DINLX-04-16	1/4"	M16 x 1.5	0.250"	2.338"	1.083"	11/16"
A-M-DINLX-06-16	3/8"	M16 x 1.5	0.375"	2.430"	1.060"	11/16"
A-M-DINLX-06-18	3/8"	M18 x 1.5	0.375"	2.599"	1.099"	3/4"
A-M-DINLX-08-22	1/2"	M22 x 1.5	0.500"	2.718"	1.216"	7/8"
A-M-DINLX-12-30	3/4"	M30 x 2.0	0.750"	2.904"	1.311"	1-1/4"

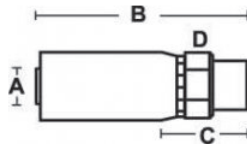

(HC-M-BSP) Male BSP Parallel Pipe - Rigid - Straight

PART	HOSE I.D.	THREAD SIZE	A	B	C	D
A-M-BSP-04-04	1/4"	1/4 x 19	0.250"	2.401"	1.146"	13/16"
A-M-BSP-04-06	1/4"	3/8 x 19	0.250"	2.456"	1.201"	7/8"
A-M-BSP-06-06	3/8"	3/8 x 19	0.375"	2.716"	1.216"	7/8"
A-M-BSP-06-08	3/8"	1/2 x 14	0.375"	2.832"	1.332"	1-1/16"
A-M-BSP-08-08	1/2"	1/2 x 14	0.500"	2.917"	1.415"	1-1/16"

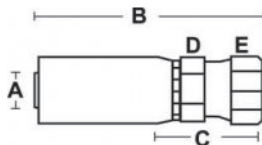

(HC-F-BSPX) Female BSP Parallel Pipe - Swivel - Straight

PART	HOSE I.D.	THREAD SIZE	A	B	C	D	E
A-F-BSPX-04-04	1/4"	1/4 x 19	0.250"	2.350"	1.095"	9/16"	3/4"
A-F-BSPX-04-06	1/4"	3/8 x 19	0.250"	2.534"	1.279"	11/16"	7/8"
A-F-BSPX-06-04	3/8"	1/4 x 19	0.375"	2.580"	1.250"	3/4"	3/4"
A-F-BSPX-06-06	3/8"	3/8 x 19	0.375"	2.795"	1.295"	11/16"	7/8"
A-F-BSPX-06-08	3/8"	1/2 x 14	0.375"	2.916"	1.416"	7/8"	1"
A-F-BSPX-08-06	1/2"	3/8 x 19	0.500"	2.904"	1.404"	7/8"	7/8"
A-F-BSPX-08-08	1/2"	1/2 x 14	0.500"	2.994"	1.494"	1"	1"
A-F-BSPX-08-10	1/2"	5/8 x 14	0.500"	2.850"	1.340"	7/8"	1-1/8"
A-F-BSPX-10-12	5/8"	3/4 x 14	0.625"	3.329"	1.829"	1-1/16"	1-1/4"
A-F-BSPX-12-12	3/4"	3/4 x 14	0.750"	3.392"	1.704"	1-1/8"	1-1/4"
A-F-BSPX-16-16	1"	1 x 11	1.000"	3.514"	1.780"	1-3/8"	1-1/2"

Parts are not Original Equipment parts and are not sponsored, affiliated or otherwise connected with any major brand.

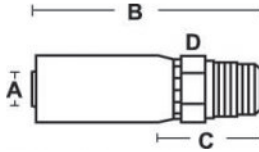

(HC-M-BSPT) Male BSP Taper Pipe - Rigid - Straight

PART	HOSE I.D.	THREAD SIZE	A	B	C	D
A-M-BSPT-04-04	1/4"	1/4 x 19	0.250"	2.315"	1.060"	11/16"
A-M-BSPT-04-06	1/4"	3/8 x 19	0.250"	2.404"	1.149"	11/16"
A-M-BSPT-06-06	3/8"	3/8 x 19	0.375"	2.665"	1.165"	3/4"
A-M-BSPT-06-08	3/8"	1/2 x 14	0.375"	2.917"	1.417"	7/8"
A-M-BSPT-08-08	1/2"	1/2 x 14	0.500"	2.995"	1.506"	7/8"
A-M-BSPT-12-12	3/4"	3/4 x 14	0.750"	3.104"	1.511"	1-1/8"

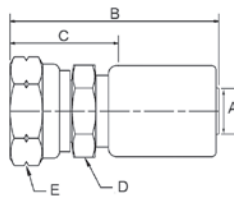

(HC-F-JISX) Female JIS 30° Seat - Swivel - Straight

PART	HOSE I.D.	THREAD SIZE	A	B	C	D	E
A-F-JISX-04-04	1/4"	1/4 x 19	0.250"	2.575"	1.220"	9/16"	3/4"
A-F-JISX-06-06	3/8"	3/8 x 19	0.375"	2.826"	1.326"	11/16"	7/8"
A-F-JISX-08-08	1/2"	1/2 x 14	0.500"	3.121"	1.619"	7/8"	1"
A-F-JISX-10-10	5/8"	5/8 x 14	0.625"	3.242"	1.743"	1-1/8"	1-1/4"

Parts are not Original Equipment parts and are not sponsored, affiliated or otherwise connected with any major brand.

HYDRAULICS

Fittings

HW SERIES

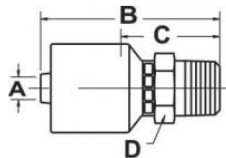

(HW-MP) Male NPTF Pipe - Rigid - Straight

PART	HOSE I.D.	THREAD SIZE	A	B	C	D
A-MP-04-02-W	1/4"	1/8 x 27	0.250"	1.854"	0.794"	9/16"
A-MP-04-04-W	1/4"	1/4 x 18	0.250"	2.030"	0.970"	9/16"
A-MP-04-06-W	1/4"	3/8 x 18	0.250"	2.125"	1.065"	11/16"
A-MP-04-08-W	1/4"	1/2 x 14	0.250"	2.305"	1.245"	7/8"
A-MP-06-04-W	3/8"	1/4 x 18	0.375"	2.454"	1.084"	11/16"
A-MP-06-06-W	3/8"	3/8 x 18	0.375"	2.220"	0.990"	3/4"
A-MP-06-08-W	3/8"	1/2 x 14	0.375"	2.490"	1.260"	7/8"
A-MP-08-06-W	1/2"	3/8 x 18	0.500"	2.390"	1.078"	7/8"
A-MP-08-08-W	1/2"	1/2 x 14	0.500"	2.640"	1.300"	7/8"
A-MP-08-12-W	1/2"	3/4 x 14	0.500"	2.710"	1.370"	1-1/16"
A-MP-10-08-W	5/8"	1/2 x 14	0.625"	3.320"	1.360"	7/8"
A-MP-10-12-W	5/8"	3/4 x 14	0.625"	3.190"	1.430"	1-1/16"
A-MP-12-08-W	3/4"	1/2 x 14	0.750"	3.295"	1.416"	1-1/8"
A-MP-12-12-W	3/4"	3/4 x 14	0.750"	3.190"	1.400"	1-1/16"
A-MP-12-16-W	3/4"	1 x 11-1/2	0.750"	3.390"	1.610"	1-3/8"
A-MP-16-12-W	1"	3/4 x 14	1.000"	3.514"	1.416"	1-3/8"
A-MP-16-16-W	1"	1 x 11-1/2	1.000"	3.730"	1.620"	1-3/8"
A-MP-20-20-W	1-1/4"	1-1/4 x 11-1/2	1.250"	4.230"	1.700"	1-11/16"

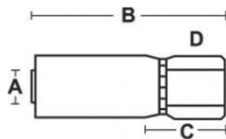

(HW-FP) Female NPTF Pipe - Rigid - Straight

PART	HOSE I.D.	THREAD SIZE	A	B	C	D
A-FP-04-04-W	1/4"	1/4 x 18	0.250"	2.064"	1.004"	11/16"
A-FP-04-06-W	1/4"	3/8 x 18	0.250"	2.158"	1.098"	7/8"
A-FP-06-04-W	3/8"	1/4 x 18	.375"	2.490"	1.120"	11/16"
A-FP-06-06-W	3/8"	3/8 x 18	0.375"	2.343"	1.114"	7/8"
A-FP-06-08-W	3/8"	1/2 x 14	0.375"	2.644"	1.274"	1"
A-FP-08-08-W	1/2"	1/2 x 14	0.500"	2.669"	1.329"	1"
A-FP-12-12-W	3/4"	3/4 x 14	0.750"	3.329"	1.450"	1-1/4"

Parts are not Original Equipment parts and are not sponsored, affiliated or otherwise connected with any major brand.

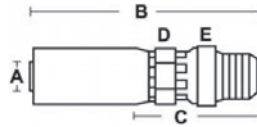

(HW-MPX) Male NPTF Pipe - Swivel - Straight

PART	HOSE I.D.	THREAD SIZE	A	B	C	D	E
A-MPX-04-02-W	1/4"	1/8 X 27	.250"	2.320"	1.260"	9/16"	1/2"
A-MPX-04-04-W	1/4"	1/4 x 18	0.250"	2.595"	1.535"	9/16"	11/16"
A-MPX-04-06-W	1/4"	3/8x18	0.250"	2.595"	1.535"	9/16"	3/4"
A-MPX-06-04-W	3/8"	1/4 x 18	0.375"	2.985"	1.615"	11/16"	11/16"
A-MPX-06-06-W	3/8"	3/8 x 18	0.375"	2.990"	1.620"	11/16"	3/4"
A-MPX-06-08-W	3/8"	1/2 x 14	0.375"	3.244"	1.874"	3/4"	15/16"
A-MPX-08-06-W	1/2"	3/8 x 18	0.500"	3.015"	1.675"	11/16"	3/4"
A-MPX-08-08-W	1/2"	1/2 x 14	0.500"	3.269"	1.929"	11/16"	7/8"
A-MPX-12-12-W	3/4"	3/4 x 14	0.750"	3.887"	2.008"	1-1/8"	1-1/8"
A-MPX-16-16-W	1"	1 x 11-1/2	1.000"	4.395"	2.270"	1-3/8"	1-1/2"

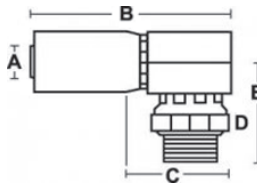

(HW-MPX90) Male NPTF Pipe - Swivel - 90° Elbow

PART	HOSE I.D.	THREAD SIZE	A	B	C	D	E
A-MPX90-04-04-W	1/4"	1/4 x 18	0.250"	2.032"	0.972"	11/16"	1.537"
A-MPX90-06-04-K2	3/8"	1/4 x 18	0.375"	3.010"	1.110"	11/16"	1.640"
A-MPX90-06-06-W	3/8"	3/8 x 18	0.375"	2.555"	1.185"	3/4"	1.720"
A-MPX90-06-08-W	3/8"	1/2 X 14	.375"	2.560"	.660"	7/8"	1.850"
A-MPX90-08-08-W	1/2"	1/2 x 14	0.500"	2.642"	1.327"	15/16"	1.924"
A-MPX90-12-12-W	3/4"	3/4 x 14	0.750"	4.300"	1.670"	1-1/8"	2.180"

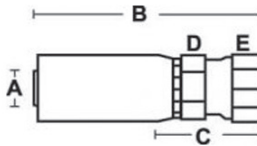

(HW-FPX) Female NPSM Pipe Swivel - Straight

PART	HOSE I.D.	THREAD SIZE	A	B	C	D	E
A-FPX-04-04-W	1/4"	1/4 x 18	0.250"	1.903"	1.004"	9/16"	3/4"
A-FPX-06-06-W	3/8"	3/8 x 18	0.375"	2.064"	1.004"	11/16"	7/8"
A-FPX-08-08-W	1/2"	1/2 x 14	0.500"	2.158"	1.098"	7/8"	1"
A-FPX-12-12-W	3/4"	3/4 x 14	0.750"	2.343"	1.114"	7/8"	1-1/4"

Parts are not Original Equipment parts and are not sponsored, affiliated or otherwise connected with any major brand.

HYDRAULICS

Fittings

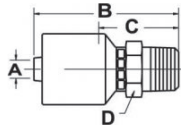

(HW-MB) Male Boss O-Ring - Rigid - Straight

PART	HOSE I.D.	THREAD SIZE	A	B	C	D
A-MB-04-04-W	1/4"	7/16 x 20	0.250"	1.830"	0.744"	5/8"
A-MB-04-05-W	1/4"	1/2 x 20	0.250"	1.810"	0.750"	5/8"
A-MB-04-06-W	1/4"	9/16 x 18	0.250"	1.946"	0.886"	11/16"
A-MB-06-06-W	3/8"	9/16 x 18	0.375"	2.120"	0.890"	3/4"
A-MB-06-08-W	3/8"	3/4 x 16	0.375"	2.170"	0.940"	7/8"
A-MB-06-10-W	3/8"	7/8 x 14	0.375"	2.456"	1.086"	1"
A-MB-08-06-W	1/2"	9/16 x 18	0.500"	2.301"	0.986"	11/16"
A-MB-08-08-W	1/2"	3/4 x 16	0.500"	2.350"	1.010"	7/8"
A-MB-08-10-W	1/2"	7/8 x 14	0.500"	2.481"	1.141"	1-1/16"
A-MB-08-12-W	1/2"	1-1/16 x 12	0.500"	2.564"	1.224"	1-1/4"
A-MB-12-12-W	3/4"	1-1/16 x 12	0.750"	2.050"	1.260"	1-1/4"
A-MB-16-16-W	1"	1-5/16 x 12	1.000"	3.380"	1.270"	1-1/2"

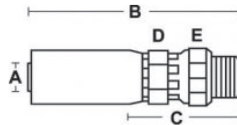

(HW-MBX) Male O-Ring Boss - Swivel

PART	HOSE I.D.	THREAD SIZE	A	B	C	D	E
A-MBX-04-04-W	1/4"	7/16 X 20	.250"	2.600"	1.540"	9/16"	11/16"
A-MBX-04-05-W	1/4"	1/2 X 20	.250"	2.480"	1.420"	9/16"	3/4"
A-MBX-04-06-W	1/4"	9/16 X 18	.250"	2.520"	1.460"	9/16"	3/4"
A-MBX-06-06-W	3/8"	9/16 x 18	0.375"	2.898"	1.528"	11/16"	3/4"
A-MBX-06-08-W	3/8"	3/4 x 16	0.375"	2.993"	1.623"	3/4"	15/16"
A-MBX-08-08-W	1/2"	3/4 x 16	0.500"	3.018"	1.703"	11/16"	15/16"
A-MBX-08-10-W	1/2"	7/8 x 14	0.500"	3.086"	1.771"	11/16"	1"
A-MBX-12-12-W	3/4"	1-1/16 x 12	0.750"	4.106"	2.227"	1-1/8"	1-1/4"

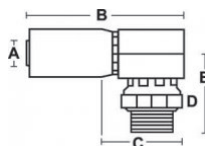

(HW-MBX90) Male Boss O-Ring - Swivel - 90° Elbow

PART	HOSE I.D.	THREAD SIZE	A	B	C	D	E
A-MBX90-06-06-W	3/8"	9/16 x 18	0.375"	2.555"	1.185"	3/4"	1.545"
A-MBX90-06-08-W	3/8"	3/4 x 16	0.375"	2.555"	1.185"	15/16"	1.632"
A-MBX90-06-10-W	3/8"	7/8 X 14	.375"	3.010"	1.110"	1"	1.710"
A-MBX90-08-08-W	1/2"	3/4 x 16	0.500"	2.642"	1.327"	15/16"	1.675"
A-MBX90-08-10-W	1/2"	7/8 x 14	0.500"	2.642"	1.327"	1"	1.740"
A-MBX90-12-12-W	3/4"	1-1/16 x 12	0.750"	-	-	1-1/4"	-

Parts are not Original Equipment parts and are not sponsored, affiliated or otherwise connected with any major brand.

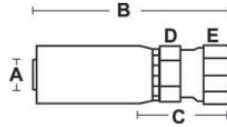

(HW-FJX) Female JIC 37° - Swivel - Straight

PART	HOSE I.D.	THREAD SIZE	A	B	C	D	E
A-FJX-04-03-W	1/4"	3/8 X 24	.250"	2.010"	.950"	9/16"	9/16"
A-FJX-04-04-W	1/4"	7/16 x 20	0.250"	2.075"	1.015"	9/16"	9/16"
A-FJX-04-05-W	1/4"	1/2 x 20	0.250"	2.220"	1.160"	9/16"	5/8"
A-FJX-04-06-W	1/4"	9/16 x 18	0.250"	2.169"	1.089"	9/16"	11/16"
A-FJX-06-04-W	3/8"	7/16 x 20	0.375"	2.405"	1.035"	11/16"	9/16"
A-FJX-06-05-W	3/8"	1/2 x 20	0.375"	2.405"	1.035"	11/16"	5/8"
A-FJX-06-06-W	3/8"	9/16 x 18	0.375"	2.500"	0.719"	3/4"	3/4"
A-FJX-06-08-W	3/8"	3/4 x 16	0.375"	2.470"	1.240"	3/4"	7/8"
A-FJX-06-10-W	3/8"	7/8 x 14	0.375"	2.800"	1.430"	7/8"	1"
A-FJX-08-06-W	1/2"	9/16 x 18	0.500"	2.524"	1.180"	11/16"	11/16"
A-FJX-08-08-W	1/2"	3/4 x 16	0.500"	2.640"	1.300"	7/8"	7/8"
A-FJX-08-10-W	1/2"	7/8 x 14	0.500"	2.800"	1.460"	7/8"	1-1/16"
A-FJX-08-12-W	1/2"	1-1/16 x 12	0.500"	2.898"	1.558"	1"	1-1/4"
A-FJX-10-10-W	5/8"	7/8 x 14	0.625"	3.380"	1.520"	7/8"	1-1/16"
A-FJX-10-12-W	5/8"	1-1/16 X 12	.625"	3.760"	1.660"	1-1/16"	1-1/4"
A-FJX-12-08-W	3/4"	3/4 x 16	0.750"	3.294"	1.415"	1"	7/8"
A-FJX-12-10-W	3/4"	7/8 x 14	0.750"	3.280"	1.490"	1-1/16"	1-1/16"
A-FJX-12-12-W	3/4"	1-1/16 x 12	0.750"	3.380"	1.590"	1-1/16"	1-1/4"
A-FJX-12-16-W	3/4"	1-5/16 x 12	0.750"	3.450"	1.660"	1-3/8"	1-1/2"
A-FJX-16-12-W	1"	1-1/16 x 12	1.000"	3.390"	1.600"	1-3/8"	1-1/4"
A-FJX-16-16-W	1"	1-5/16 x 12	1.000"	3.780"	1.670"	1-3/8"	1-1/2"

Parts are not Original Equipment parts and are not sponsored, affiliated or otherwise connected with any major brand.

HYDRAULICS

Fittings

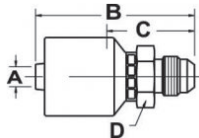

(HW-MJ) Male JIC 37° - Rigid - Straight

PART	HOSE I.D.	THREAD SIZE	A	B	C	D
A-MJ-04-04-W	1/4"	7/16 x 20	0.250"	2.020"	0.940"	9/16"
A-MJ-04-05-W	1/4"	1/2 x 20	0.250"	2.025"	0.915"	9/16"
A-MJ-04-06-W	1/4"	9/16 x 18	0.250"	2.031"	0.951"	9/16"
A-MJ-06-05-W	3/8"	1/2 x 20	0.375"	2.355"	0.985"	11/16"
A-MJ-06-06-W	3/8"	9/16 x 18	0.375"	2.120"	0.990"	3/4"
A-MJ-06-08-W	3/8"	3/4 x 16	0.375"	2.380"	1.150"	3/4"
A-MJ-06-10-W	3/8"	7/8 x 14	0.375"	2.724"	1.354"	1"
A-MJ-08-08-W	1/2"	3/4 x 16	0.500"	2.570"	1.230"	7/8"
A-MJ-08-10-W	1/2"	7/8 x 14	0.500"	2.720"	1.380"	1"
A-MJ-08-12-W	1/2"	1-1/16 x 12	0.500"	2.854"	1.514"	1-1/8"
A-MJ-10-10-W	5/8"	7/8 x 14	.625"	3.580"	1.480"	7/8"
A-MJ-10-12-W	5/8"	1-1/16 x 12	.625"	3.680"	1.580"	1-1/8"
A-MJ-12-12-W	3/4"	1-1/16 x 12	0.750"	3.340"	1.550"	1-1/8"
A-MJ-12-16-W	3/4"	1-5/16 x 12	0.750"	3.370"	1.580"	1-3/8"
A-MJ-16-16-W	1"	1-5/16 x 12	1.000"	3.930"	1.810"	1-3/8"

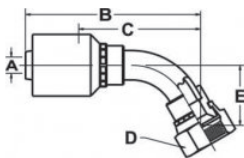

(HW-FJX45) Female JIC 37° - Swivel - 45° Elbow

PART	HOSE I.D.	THREAD SIZE	A	B	C	D	E
A-FJX45-04-04-W	1/4"	7/16 x 20	0.250"	2.855"	1.795"	9/16"	0.394"
A-FJX45-04-06-W	1/4"	9/16 x 18	0.250"	2.770"	1.710"	11/16"	0.390"
A-FJX45-06-06-W	3/8"	9/16 x 18	0.375"	2.640"	1.410"	11/16"	0.588"
A-FJX45-06-08-W	3/8"	3/4 x 16	0.375"	2.820"	1.590"	7/8"	0.713"
A-FJX45-08-08-W	1/2"	3/4 x 16	0.500"	2.990"	1.650"	7/8"	0.713"
A-FJX45-08-10-W	1/2"	7/8 x 14	0.500"	3.170"	1.830"	1"	0.839"
A-FJX45-10-10-W	5/8"	7/8 x 14	0.625"	3.750"	1.885"	1"	0.839"
A-FJX45-10-12-W	5/8"	1-1/16 x 12	0.625"	5.188"	3.088"	1-1/4"	1.149"
A-FJX45-12-12-W	3/4"	1-1/16 x 12	0.750"	4.820"	3.053"	1-1/4"	1.149"
A-FJX45-16-16-W	1"	1-5/16 x 12	1.000"	5.110"	3.027"	1-1/2"	1.227"

Parts are not Original Equipment parts and are not sponsored, affiliated or otherwise connected with any major brand.

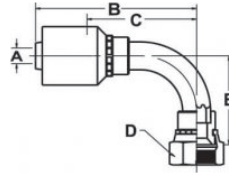

(HW-FJX90) Female JIC 37° - Swivel - 90° Elbow

PART	HOSE I.D.	THREAD SIZE	A	B	C	D	E
A-FJX90-04-04-W	1/4"	7/16 x 20	0.250"	2.695"	1.635"	9/16"	0.830"
A-FJX90-04-05-W	1/4"	1/2 x 20	0.250"	2.790"	1.730"	5/8"	0.830"
A-FJX90-04-06-W	1/4"	9/16 x 18	0.250"	2.670"	1.610"	11/16"	0.850"
A-FJX90-06-04-W	3/8"	7/16 x 20	0.375"	3.025"	1.655"	9/16"	0.830"
A-FJX90-06-06-W	3/8"	9/16 x 18	0.375"	2.340"	1.120"	11/16"	1.130"
A-FJX90-06-08-W	3/8"	3/4 x 16	0.375"	2.640"	1.300"	7/8"	1.380"
A-FJX90-08-06-W	1/2"	9/16x18	0.500"	2.640"	1.300"	7/8"	2.430"
A-FJX90-08-08-W	1/2"	3/4 x 16	0.500"	2.770"	1.430"	1"	1.630"
A-FJX90-08-10-W	1/2"	7/8 x 14	0.500"	4.820"	3.030"	1-1/4"	2.650"
A-FJX90-08-12-W	1/2"	1-1/16 x 12	0.500"	5.220"	3.110"	1-1/2"	2.770"
A-FJX90-10-10-W	5/8"	7/8 x 14	0.625"	5.220"	3.110"	2"	3.020"
A-FJX90-12-10-W	3/4"	7/8 X 14	.750"	3.620"	1.740"	1"	1.230"
A-FJX90-12-12-W	3/4"	1-1/16 x 12	0.750"	4.510"	2.725"	2-1/4"	2.574"
A-FJX90-12-16-W	3/4"	1-5/16 X 12	.750"	4.730"	2.940"	1-1/2"	2.780"
A-FJX90-16-16-W	1"	1-5/16 x 12	1.000"	8.260"	3.050"	2-7/8"	2.800"

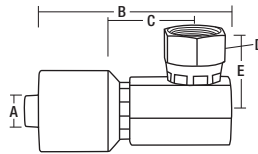

(HW-FJX90B) Female JIC 37° - Swivel - 90° Elbow Block

PART	HOSE I.D.	THREAD SIZE	A	B	C	D	E
A-FJX90B-08-08-W	1/2"	3/4 X 16	.500"	2.640"	.800"	7/8"	1.360"

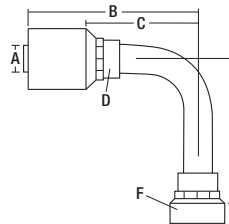

(HW-FJX90L) Female JIC 37° - Swivel - 90° Elbow - Long

PART	HOSE I.D.	THREAD SIZE	A	B	C	D	E	F
A-FJX90L-12-12-W	3/4"	1-1/16 X 12	.750"	4.580"	2.710"	1"	3.780"	1-1/4"

Parts are not Original Equipment parts and are not sponsored, affiliated or otherwise connected with any major brand.

HYDRAULICS

Fittings

HYDRAULICS

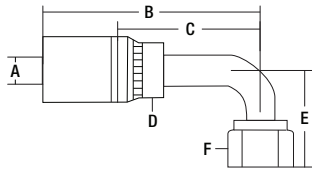

(HW-FJX90) Female JIC 37° - Swivel - 90° Elbow

PART	HOSE I.D.	THREAD SIZE	A	B	C	D	E	F
A-FJX90M-12-12-W	3/4"	1-1/16 X 12	.750"	3.89"	2.30"	1-1/8"	2.280"	1-1/4"

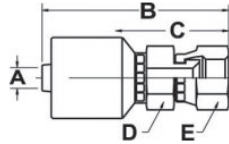

(HW-FSX) SAE 45° Swivel - Straight

PART	HOSE I.D.	THREAD SIZE	A	B	C	D	E
A-FSX-06-06-W	3/8"	5/8 x 18	0.375"	2.645"	1.275"	11/16"	3/4"

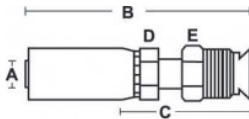

(HW-MIX) SAE Male Inverted - SAE 45° - Swivel - Straight

PART	HOSE I.D.	THREAD SIZE	A	B	C	D	E
A-MIX-06-05-W	3/8"	1/2 x 20	0.375"	3.370"	2.000"	3/4"	1/2"

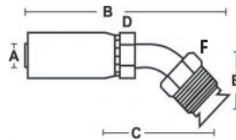

(HW-MIX45) SAE Male Inverted - SAE 45° - Swivel - 45° Elbow

PART	HOSE I.D.	THREAD SIZE	A	B	C	D	E	F
A-MIX45-04-04-W	1/4"	7/16 x 24	0.250"	2.675"	1.615"	5/8"	0.780"	7/16"
A-MIX45-06-06-W	3/8"	5/8 x 18	0.375"	3.771"	2.401"	3/4"	0.940"	5/8"

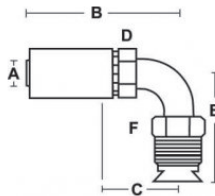

(HW-MIX90) Male Inverted Flare - SAE 45° - Swivel - 90° Elbow

PART	HOSE I.D.	THREAD SIZE	A	B	C	D	E	F
A-MIX90-06-04-W	3/8"	7/16 x 24	0.375"	2.420"	1.050"	11/16"	1.470"	7/16"
A-MIX90-08-08-W	1/2"	3/4 x 18	0.500"	3.486"	2.146"	7/8"	1.880"	3/4"

Parts are not Original Equipment parts and are not sponsored, affiliated or otherwise connected with any major brand.

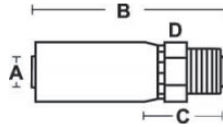

(HW-MF) Male "Seal-lok" - Rigid - Straight

PART	HOSE I.D.	THREAD SIZE	A	B	C	D
A-MF-04-04-W	1/4"	9/16 x 18	0.250"	2.045"	0.965"	5/8"
A-MF-04-06-W	1/4"	11/16 X 16	.250"	1.910"	.850"	11/16"
A-MF-06-06-W	3/8"	11/16 x 16	0.375"	2.241"	0.871"	11/16"
A-MF-06-08-W	3/8"	13/16 X 16	.375"	2.300"	.930"	7/8"
A-MF-08-08-W	1/2"	13/16 x 16	0.500"	2.329"	0.989"	7/8"
A-MF-08-10-W	1/2"	1 X 14	.500"	2.590"	1.250"	1-1/16"
A-MF-10-10-W	5/8"	1 X 14	.625"	3.420"	1.320"	1-1/16"
A-MF-10-12-W	5/8"	1-3/16 X 12	.625"	3.480"	1.380"	1-1/4"
A-MF-12-12-W	3/4"	1-3/16 x 12	0.750"	3.215"	1.336"	1-1/4"
A-MF-12-16-W	3/4"	1-7/16 X 12	.750"	3.230"	1.350"	1-1/2"

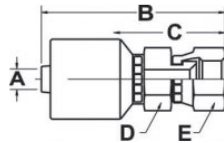

(HW-FFX) Female "Seal-lok" Swivel Straight

PART	HOSE I.D.	THREAD SIZE	A	B	C	D	E
A-FFX-04-04-W	1/4"	9/16 x 18	0.250"	2.180"	1.100"	9/16"	11/16"
A-FFX-04-06-W	1/4"	11/16 x 16	0.250"	2.140"	1.060"	11/16"	13/16"
A-FFX-04-08-W	1/4"	13/16 x 16	0.250"	2.280"	1.200"	3/4"	15/16"
A-FFX-06-04-W	3/8"	9/16 X 18	.375"	2.640"	1.270"	11/16"	11/16"
A-FFX-06-06-W	3/8"	11/16 x 16	0.375"	2.430"	1.200"	11/16"	7/8"
A-FFX-06-08-W	3/8"	13/16 x 16	0.375"	2.610"	1.240"	3/4"	15/16"
A-FFX-08-06-W	1/2"	11/16 x 16	0.500"	2.470"	1.130"	11/16"	11/16"
A-FFX-08-08-W	1/2"	13/16 x 16	0.500"	2.770"	1.430"	7/8"	1-1/16"
A-FFX-08-10-W	1/2"	1 x 14	0.500"	2.860"	1.520"	15/16"	1-1/8"
A-FFX-08-12-W	1/2"	1-3/16 x 12	0.500"	2.950"	1.610"	1-1/8"	1-3/8"
A-FFX-10-10-W	5/8"	1 x 14	0.625"	3.440"	1.580"	15/16"	1-1/8"
A-FFX-10-12-W	5/8"	1-3/16 X 12	.625"	3.780"	1.680"	1-1/8"	1-3/8"
A-FFX-12-10-W	3/4"	1 x 14	0.750"	3.390"	1.520"	1-1/8"	1-1/8"
A-FFX-12-12-W	3/4"	1-3/16 x 12	0.750"	3.640"	1.850"	1-1/8"	1-3/8"
A-FFX-12-16-W	3/4"	1-7/16 X 12	.750"	3.680"	1.810"	1-3/8"	1-5/8"
A-FFX-16-16-W	1"	1-7/16 x 12	1.000"	3.900"	1.790"	1-3/8"	1-5/8"
A-FFX-20-20-W	1-1/4"	1-11/16 x 12	1.250"	4.320"	1.780"	1-5/8"	2"

Parts are not Original Equipment parts and are not sponsored, affiliated or otherwise connected with any major brand.

HYDRAULICS

Fittings

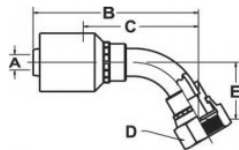

(HW-FFX45) Female "Seal-lok" Swivel 45° Elbow

PART	HOSE I.D.	THREAD SIZE	A	B	C	D	E
A-FFX45-04-04-W	1/4"	9/16 x 18	0.250"	2.855"	1.795"	11/16"	0.394"
A-FFX45-04-06-W	1/4"	11/16 x 16	0.250"	2.810"	1.750"	5/8"	0.430"
A-FFX45-06-06-W	3/8"	11/16 x 16	0.375"	2.490"	1.260"	13/16"	0.430"
A-FFX45-06-08-W	3/8"	13/16 x 16	0.375"	3.216"	1.846"	15/16"	0.590"
A-FFX45-08-08-W	1/2"	13/16 x 16	0.500"	3.030"	1.690"	15/16"	0.590"
A-FFX45-08-10-W	1/2"	1 x 14	.500"	3.460"	2.120"	1-1/8"	.630"
A-FFX45-10-10-W	5/8"	1 x 14	0.625"	3.750"	1.885"	1-1/8"	0.429"
A-FFX45-12-12-W	3/4"	1-3/16 x 12	0.750"	4.820"	2.717"	1-3/8"	0.807"
A-FFX45-16-16-W	1"	1-7/16 x 12	1.000"	5.110"	3.000"	1-5/8"	0.940"

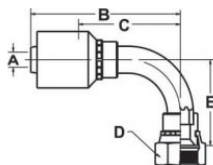

(HW-FFX90) Female Seal-lok Swivel 90° Elbow

PART	HOSE I.D.	THREAD SIZE	A	B	C	D	E
A-FFX90-04-04-W	1/4"	9/16 X 18	.250"	2.700"	1.640"	11/16"	.820"
A-FFX90-04-06-W	1/4"	11/16 x 16	0.250"	2.670"	1.610"	13/16"	0.900"
A-FFX90-06-06-W	3/8"	11/16 x 16	0.375"	2.400"	1.170"	13/16"	0.900"
A-FFX90-06-08-W	3/8"	13/16 x 16	0.375"	3.026"	1.656"	15/16"	1.142"
A-FFX90-08-06-W	1/2"	11/16 x 16	0.500"	3.190"	1.850"	13/16"	0.910"
A-FFX90-08-08-W	1/2"	13/16 x 16	0.500"	2.680"	1.350"	15/16"	1.150"
A-FFX90-08-10-W	1/2"	1 x 14	0.500"	2.770"	1.430"	1-1/8"	1.260"
A-FFX90-10-10-W	5/8"	1 x 14	0.625"	3.350"	1.430"	1-1/8"	1.260"
A-FFX90-10-12-W	5/8"	1-3/16 x 12	0.625"	4.703"	2.603"	1-3/8"	1.881"
A-FFX90-12-10-W	3/4"	1 x 14	0.750"	4.070"	2.200"	1-1/8"	1.260"
A-FFX90-12-12-W	3/4"	1-3/16 x 12	0.750"	4.360"	2.568"	1-3/8"	1.881"
A-FFX90-12-16-W	3/4"	1-7/16 X 12	.750"	4.360"	2.570"	1-5/8"	2.210"
A-FFX90-16-16-W	1"	1-7/16 x 12	1.000"	5.220"	2.940"	1-5/8"	2.210"

Parts are not Original Equipment parts and are not sponsored, affiliated or otherwise connected with any major brand.

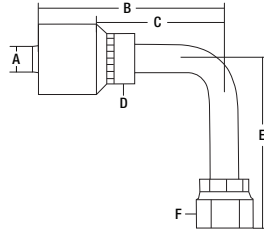

(HW-FFX90L) Female Seal Lok - Swivel - 90° Elbow Long

PART	HOSE I.D.	THREAD SIZE	A	B	C	D	E	F
A-FFX90L-08-08-W	1/2"	13/16 X 16	.500"	3.490"	2.150"	15/16"	2.520"	15/16"
A-FFX90L-10-12-W	5/8"	1-3/16 X 12	.625"	4.350"	2.250"	1"	3.830"	1-3/8"
A-FFX90L-12-12-W	3/4"	1-3/16 X 12	.750"	4.360"	2.570"	1-3/8"	3.780"	1-3/8"

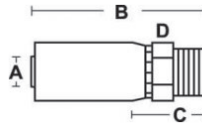

(HW-MT) SAE Flareless Compression w/ Sleeve & Nut - Rigid - Straight

PART	HOSE I.D.	THREAD SIZE	A	B	C	D
A-MT-06-05-W	3/8"	1/2 x 20	0.375"	2.228"	0.858"	11/16"
A-MT-06-06-W	3/8"	9/16 x 18	0.375"	2.083"	0.853"	3/4"
A-MT-06-08-W	3/8"	3/4 x 16	0.375"	2.579"	1.079"	3/4"
A-MT-08-08-W	1/2"	3/4 x 16	0.500"	2.393"	1.053"	7/8"

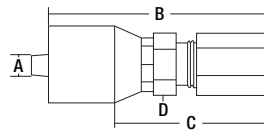

(HW-MT) Flareless Compression SAE J514

PART	HOSE I.D.	THREAD SIZE	A	B	C	D
A-MT-04-06-K2	1/4"	9/16 X 18	.250"	1.920"	.840"	5/8"

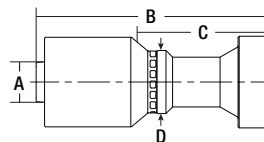

(HW-CAT) Caterpillar Flange Head - Straight

PART	HOSE I.D.	THREAD SIZE	A	B	C	D
A-CAT-12-12-W	3/4"		0.750"	4.140"	2.350"	1.120"
A-CAT-16-16-W	1"		1.000"	4.670"	2.540"	1.495"
A-CAT-20-20-W	1-1/4"		1.250"	5.440"	2.810"	1.790"

Parts are not Original Equipment parts and are not sponsored, affiliated or otherwise connected with any major brand.

HYDRAULICS

Fittings

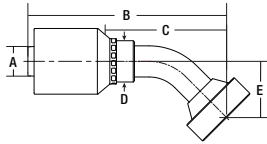

(HW-CAT) Caterpillar Flange Head - 45° Elbow

PART	HOSE I.D.	THREAD SIZE	A	B	C	D	E
A-CAT45-12-12-W	3/4"		0.750"	4.810"	2.940"	1.000"	1.360"
A-CAT45-16-16-W	1"		1.000"	5.200"	3.080"	1.310"	1.430"
A-CAT45-20-20-W	1-1/4"		1.250"	5.740"	3.200"	1.625"	1.460"

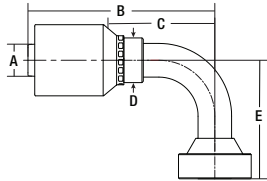

(HW-CAT) Caterpillar Flange Head - 90° Elbow

PART	HOSE I.D.	THREAD SIZE	A	B	C	D	E
A-CAT90-12-12-W	3/4"		0.750"	4.180"	2.390"	1"	2.650"
A-CAT90-16-16-W	1"		1.000"	4.640"	2.530"	1-3/8"	2.900"
A-CAT90-20-20-W	1"		1.250"	5.100"	2.560"	1-5/8"	3.020"

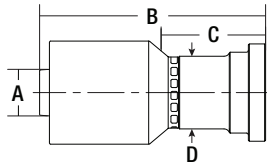

(HW-C61) Code 61 Flange Head - Straight

PART	HOSE I.D.	THREAD SIZE	A	B	C	D
A-C61-08-08-W	1/2"		.500"	3.180"	1.840"	1-3/16"
A-C61-08-12-W	1/2"		.500"	2.920"	1.580"	1-1/2"
A-C61-12-12-W	3/4"		0.750"	3.480"	1.610"	1.120"
A-C61-16-16-W	1"		1.000"	4.010"	1.910"	1.500"
A-C61-20-20-W	1-1/4"		1.250"	4.470"	1.950"	1.790"

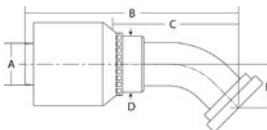

(HW-C61) Code 61 Flange Head - 45° Elbow

PART	HOSE I.D.	THREAD SIZE	A	B	C	D	E
A-C6145-08-08-W	1/2"		.500"	3.800"	2.460"	7/8"	.750"
A-C6145-08-12-W	1/2"		.500"	3.580"	2.240"	1"	.840"
A-C6145-12-12-W	3/4"		0.750"	4.620"	2.750"	1.000"	0.840"
A-C6145-16-16-W	1"		1.000"	4.820"	2.710"	1.375"	1.130"
A-C6145-20-20-W	1-1/4"		1.250"	6.190"	3.650"	1.625"	1.260"

Parts are not Original Equipment parts and are not sponsored, affiliated or otherwise connected with any major brand.

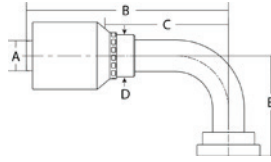

(HW-C61) Code 61 Flange Head - 90° Elbow

PART	HOSE I.D.	THREAD SIZE	A	B	C	D	E
A-C6190-08-08-W	1/2"		.500"	3.140"	1.800"	7/8"	1.630"
A-C6190-08-12-W	1/2"		.500"	3.490"	2.150"	1"	1.560"
A-C6190-12-12-W	3/4"		0.750"	4.810"	2.940"	1"	2.380"
A-C6190-16-16-W	1"		1.000"	5.190"	3.080"	1-3/8"	2.800"
A-C6190-20-20-W	1-1/4"		1.250"	6.250"	3.730"	1-5/8"	2.680"

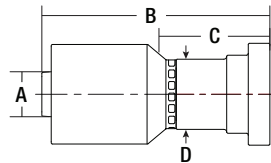

(HW-C62) Code 62 Flange Head - Straight

PART	HOSE I.D.	THREAD SIZE	A	B	C	D
A-C62-12-12-W	3/4"		0.750"	3.640"	1.770"	1.120"
A-C62-16-16-W	1"		1.000"	4.530"	2.400"	1.495"
A-C62-20-20-W	1-1/4"		1.250"	5.210"	2.810"	2.125"

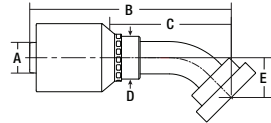

(HW-C62) Code 62 Flange Head - 45° Elbow

PART	HOSE I.D.	THREAD SIZE	A	B	C	D	E
A-C6245-12-12-W	3/4"		0.750"	4.710"	2.840"	1"	.930"
A-C6245-16-16-W	1"		1.000"	5.370"	3.260"	1-3/8"	1.250"
A-C6245-20-20-W	1-1/4"		1.250"	6.490"	3.950"	1-5/8"	1.480"

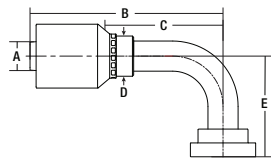

(HW-C62) Code 62 Flange Head - 90° Elbow

PART	HOSE I.D.	THREAD SIZE	A	B	C	D	E
A-C6290-12-12-W	3/4"		0.750"	4.800"	2.940"	1"	2.510"
A-C6290-16-16-W	1"		1.000"	4.800"	2.690"	1-3/8"	2.500"
A-C6290-20-20-W	1-1/4"		1.250"	6.250"	3.710"	1-5/8"	3.120"

Parts are not Original Equipment parts and are not sponsored, affiliated or otherwise connected with any major brand.

HYDRAULICS

Fittings

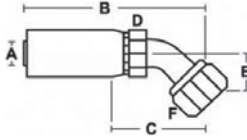

Din Light 24° Seat 45° Female Swivel O-Ring

PART	HOSE I.D.	THREAD SIZE	A	B	C	D	E	F
A-F-DL4506-12-18-W	M18 X 1.5		3/8"	3.82"	2.59"	3/4"	1.13"	15/16"

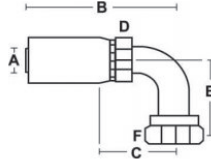

Din Light 24° Seat 90° Female Swivel O-Ring

PART	HOSE I.D.	THREAD SIZE	A	B	C	D	E	F
A-F-DL9006-10-16-W	M16 X 1.5		3/8"	3.17"	1.80"	11/16"	1.63"	7/8"

Parts are not Original Equipment parts and are not sponsored, affiliated or otherwise connected with any major brand.



D100SP

D160SP

D165M

Crimping Machines & Dies

PART	DESCRIPTION	PUMP	MAXIMUM CYLINDER FORCE	MAXIMUM HOSE DIAMETER	MAXIMUM HOSE DIAMETER
A-D100SP	D100 Crimper; Stand-A-Lone w/ Pneumatic Pump	10,000 PSI Pneumatic Valpower Pump	35 Ton	2 Wire= 1"	4 Wire= 3/4"
A-D160SP	D160 Crimper, Stand-A-Lone w/ Pneumatic Pump	Pneumatic Pump	60 Ton	2 Wire= 1-1/4"	4 Wire= 1-1/4"
A-D165M	D160 Crimper, Automatic Shut-Off	1 HP Fast Acting Hydraulic Pump	60 Ton	2 Wire= 1-1/4"	4 Wire= 1-1/4"

Crimping Machines & Dies

PART	DESCRIPTION
A-102213	Compression Ring; D165

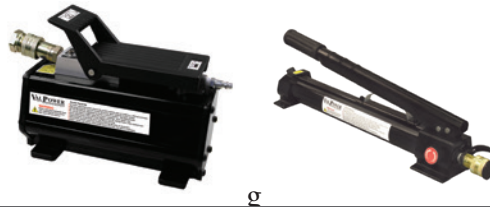

Crimping Machines & Dies

PART	DESCRIPTION	NOTE	PSI
A-VAP-10-100	Pneumatic Pump	Air Supply Required: 80 psi	10,000
A-VHP-10-43	Hand Pump		10,000

Parts are not Original Equipment parts and are not sponsored, affiliated or otherwise connected with any major brand.

HYDRAULICS

Crimping Machines & Dies - Bulk Hose

HYDRAULICS



Crimping Machines & Dies

PART	DESCRIPTION	NOTE
A-D100-15/RED	15MM Die Set; Red, For 1/4" Hose (HC/HW)	For 2 Wire Hose
A-D100-18/YELLOW	18MM Die Set; Yellow, For 3/8" Hose (HC/HW)	For 2 Wire Hose
A-D100-21/BLUE	21MM Die Set; Blue, For 1/2" Hose (HC/HW)	For 2 Wire Hose
A-D100-25/ORANGE	25MM Die Set; Orange, For 5/8" Hose (HC)	For 2 Wire Hose
A-D100-28/GREEN	28MM Die Set; Green, For 3/4" Hose (HC/HW) and 5/8" Hose (HW)	For 2 Wire Hose
A-D100-31/SILVER	31MM Die Set; Silver, For 3/4" Hose (HW)	For 4 Wire Hose
A-D100-37/BLACK	37MM Die Set; Black, For 1" Hose (HC/HW)	For 2 Wire Hose
A-D100-39/SILVER	39MM Die Set; Silver, For 1" Hose (HW)	For 4 Wire Hose
A-D100-49/SILVER	49MM Die Set; Silver, For 1-1/4" Hose (HW)	For 4 Wire Hose
A-101431	Die Rack	



Crimping Machines & Dies

PART	DESCRIPTION	NOTE	INCLUDES
A-HCM300	Hose Cutting Machine	3 HP 220 Volt Three Phase	Hose Guide
A-HCM3001	Hose Cutting Machine	3 HP 220 Volt Single Phase	Hose Guide
A-103187	Blade, Replacement for HCM300 & HCM3001	12" Serrated	



2 Wire Bulk Hose

PART	DESCRIPTION	BEND RADIUS	MINIMUM BURST PRESSURE	STANDARD REEL SIZE	WORKING PRESSURE	MAXIMUM OD
A-P100R16-4	1/4" - 2 Wire Compact Hyd Hose	2.0"	23,200 PSI	250'	5800 PSI	0.53"
A-P100R16-6	3/8" - 2 Wire Compact Hyd Hose	2.5"	19,200 PSI	250'	4800 PSI	0.67"
A-P100R16-8	1/2" - 2 Wire Compact Hyd Hose	3.5"	16,000 PSI	200'	4000 PSI	0.80"
A-P100R16-10	5/8" - 2 Wire Compact Hyd Hose	4.0"	14,400 PSI	250'	3600 PSI	0.97"
A-P100R16-10X100	5/8" - 2 Wire Compact Hyd Hose (100 Ft.)	4.0"	14,400 PSI	100'	3600 PSI	0.97"
A-P100R16-12	3/4" - 2 Wire Compact Hyd Hose	4.8"	12,400 PSI	200'	3100 PSI	1.08"
A-P100R16-12X50	3/4" - 2 Wire Compact Hyd Hose (50 Ft.)	4.8"	12,400 PSI	50'	3600 PSI	1.08"
A-P100R16-16	1" - 2 Wire Compact Hyd Hose	6.0"	9,600 PSI	100'	2400 PSI	1.40"
A-P100R16-16X50	1" - 2 Wire Compact Hyd Hose (50 Ft.)	6.0"	9600 PSI	50'	2400 PSI	1.40"

Parts are not Original Equipment parts and are not sponsored, affiliated or otherwise connected with any major brand.



4 Wire Bulk Hose

PART	DESCRIPTION	BEND RADIUS	MINIMUM BURST PRESSURE	STANDARD REEL SIZE	WORKING PRESSURE	MAXIMUM OD
A-38624SH-12	3/4" - 4 Wire Compact Hyd Hose (50')	4.70"	24,000 PSI	50'	6000 PSI	1.27"
A-38624SH-16	1" - 4 Wire Compact Hyd Hose (50')	5.90"	22,000 PSI	50'	5500 PSI	1.52"
A-38624SH-20	1-1/4" - 4 Wire Compact Hyd Hose (50')	9.00"	20,000 PSI	50'	5000 PSI	1.79"



Hose

PART	DESCRIPTION	BEND RADIUS	MINIMUM BURST PRESSURE	HOSE ID	OUTSIDE DIAMETER	WORKING PRESSURE
A-R4-12	SAE 100 R4 Suction Hose; 3/4" ID, (100 Ft.)	5.000"	1,200 PSI	3/4"	1.320"	300 PSI
A-R4-16	SAE 100 R4 Suction Hose; 1.000" ID (100 Ft.)	6.000"	1,000 PSI	1"	1.480"	250 PSI
A-R4-20	SAE 100 R4 Suction Hose; 1-1/4" ID (100 Ft.)	8.000"	800 PSI	1-1/4"	1.770"	200 PSI
A-R4-24	SAE 100 R4 Suction Hose; 1-1/2" ID (100 Ft.)	10.000"	600 PSI	1-1/2"	2.050"	150 PSI



Hose Menders

PART	DESCRIPTION	HOSE SIZE	TYPE
A-44SV	Splice, Crimp On	1/4"	
A-MENDER-6	Hose Mender; Rigid	3/8"	HC
A-MENDER-8	Hose Mender; Rigid	1/2"	HC
A-MENDER-12	Hose Mender; Rigid	3/4"	HC
A-MENDER-16	Hose Mender; Rigid	1"	HC

Parts are not Original Equipment parts and are not sponsored, affiliated or otherwise connected with any major brand.

HYDRAULICS

Hose Assemblies

1/4" Hydraulic Hose Assembly

Rigid x Rigid Male NPT Ends

2 Wire
 Bend Radius 2.00"
 Working Pressure 5,800 PSI
 Standard: SAE 100R16



PART	LENGTH
A-PHA2W1412	12"
A-PHA2W1418	18"
A-PHA2W1424	24"
A-PHA2W1430	30"
A-PHA2W1436	36"
A-PHA2W1448	48"

PART	LENGTH
A-PHA2W1460	60"
A-PHA2W1472	72"
A-PHA2W1484	84"
A-PHA2W1496	96"
A-PHA2W14108	108"
A-PHA2W14120	120"

PART	LENGTH
A-PHA2W14132	132"
A-PHA2W14144	144"
A-PHA2W14156	156"
A-PHA2W14168	168"
A-PHA2W14180	180"
A-PHA2W14192	192"

3/8" Hydraulic Hose Assembly

Rigid x Rigid Male NPT Ends

2 Wire
 Bend Radius 2.60"
 Working Pressure 4,800 PSI
 Standard: SAE 100R16



PART	LENGTH
A-PHA2W3812	12"
A-PHA2W3818	18"
A-PHA2W3824	24"
A-PHA2W3830	30"
A-PHA2W3836	36"
A-PHA2W3848	48"

PART	LENGTH
A-PHA2W3860	60"
A-PHA2W3872	72"
A-PHA2W3884	84"
A-PHA2W3896	96"
A-PHA2W38108	108"
A-PHA2W38120	120"

PART	LENGTH
A-PHA2W38132	132"
A-PHA2W38144	144"
A-PHA2W38156	156"
A-PHA2W38168	168"
A-PHA2W38180	180"
A-PHA2W38192	192"

3/8" Hydraulic Hose Assembly

Rigid x Swivel Male NPT Ends

2 Wire
 Bend Radius 2.60"
 Working Pressure 4,800 PSI
 Standard: SAE 100R16



PART	LENGTH
A-PHA2W3812S	12"
A-PHA2W3818S	18"
A-PHA2W3824S	24"
A-PHA2W3830S	30"
A-PHA2W3836S	30"
A-PHA2W3848S	48"

PART	LENGTH
A-PHA2W3860S	60"
A-PHA2W3872S	72"
A-PHA2W3884S	84"
A-PHA2W3896S	96"
A-PHA2W38108S	30"
A-PHA2W38120S	120"

PART	LENGTH
A-PHA2W38132S	132"
A-PHA2W38144S	144"
A-PHA2W38156S	156"
A-PHA2W38168S	168"
A-PHA2W38180S	180"
A-PHA2W38192S	192"

Parts are not Original Equipment parts and are not sponsored, affiliated or otherwise connected with any major brand.

1/2" Hydraulic Hose Assembly

Rigid x Rigid Male NPT Ends

2 Wire

Bend Radius 3.40"

Working Pressure 4,000 PSI

Standard: SAE 100R16



PART	LENGTH
A-PHA2W1212	12"
A-PHA2W1218	18"
A-PHA2W1224	24"
A-PHA2W1230	30"
A-PHA2W1236	36"
A-PHA2W1248	48"

PART	LENGTH
A-PHA2W1260	60"
A-PHA2W1272	72"
A-PHA2W1284	84"
A-PHA2W1296	96"
A-PHA2W12108	108"
A-PHA2W12120	120"

PART	LENGTH
A-PHA2W12132	132"
A-PHA2W12144	144"
A-PHA2W12156	156"
A-PHA2W12168	168"
A-PHA2W12180	180"
A-PHA2W12192	192"

1/2" Hydraulic Hose Assembly

Rigid x Swivel Male NPT Ends

2 Wire

Bend Radius 3.40"

Working Pressure 4,000 PSI

Standard: SAE 100R16



PART	LENGTH
A-PHA2W1212S	12"
A-PHA2W1218S	18"
A-PHA2W1224S	24"
A-PHA2W1230S	30"
A-PHA2W1236S	36"
A-PHA2W1248S	48"

PART	LENGTH
A-PHA2W1260S	60"
A-PHA2W1272S	72"
A-PHA2W1284S	84"
A-PHA2W1296S	96"
A-PHA2W12108S	108"
A-PHA2W12120S	120"

PART	LENGTH
A-PHA2W12132S	132"
A-PHA2W12144S	144"
A-PHA2W12156S	156"
A-PHA2W12168S	168"
A-PHA2W12180S	180"
A-PHA2W12192S	192"

Parts are not Original Equipment parts and are not sponsored, affiliated or otherwise connected with any major brand.

HYDRAULICS

Hose Sleeves & Straps

HYDRAULICS



Protective Slip-On Sleeve

PART	INSIDE DIAMETER	WIDTH	LENGTH	MINIMUM ORDER QTY
A-PS2079X50	0.79"	Flat 1.22"	50' Roll	50
A-PS2079X150	0.79"	Flat 1.22"	150' Roll	150
A-PS2106X50	1.06"	Flat 1.77"	50' Roll	50
A-PS2106X150	1.06"	Flat 1.77"	150' Roll	150
A-PS2122X50	1.22"	Flat 2.05"	50' Roll	50
A-PS2122X150	1.22"	Flat 2.05"	150' Roll	150
A-PS2157X50	1.57"	Flat 2.60"	50' Roll	50
A-PS2157X150	1.57"	Flat 2.60"	150' Roll	150
A-PS2185X50	1.85"	Flat 3.03"	50' Roll	50
A-PS2185X150	1.85"	Flat 3.03"	150' Roll	150
A-PS2236X50	2.36"	Flat 3.82"	50' Roll	50
A-PS2236X150	2.36"	Flat 3.82"	150' Roll	150

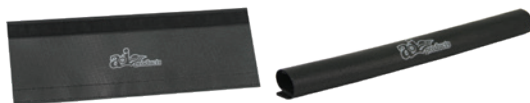

Protective Reusable Sleeve, Hook and Loop

PART	INSIDE DIAMETER	WIDTH	LENGTH	MINIMUM ORDER QTY
A-PS3100X50	1.00"	Flat 3.89"	50' Roll	50
A-PS3100X150	1.00"	Flat 3.89"	150' Roll	150
A-PS3150X50	1.50"	Flat 5.46"	50' Roll	50
A-PS3150X150	1.50"	Flat 5.46"	150' Roll	150
A-PS3200X50	2.00"	Flat 7.78"	50' Roll	50
A-PS3200X150	2.00"	Flat 7.78"	150' Roll	150
A-PS3400X50	4.00"	Flat 14.06"	50' Roll	50
A-PS3400X150	4.00"	Flat 14.06"	150' Roll	150



Cinch Strap, Hook and Loop

PART	DIAMETER	PROOF TEST LOAD	MINIMUM ORDER QTY
A-CS1719	Adjustable 1.7"-1.9"	100 lbs	10
A-CS2125	Adjustable 2.1"-2.5"	100 lbs	10
A-CS2838	Adjustable 2.8"-3.8"	100 lbs	10
A-CS3451	Adjustable 3.4"-5.1"	100 lbs	10

Parts are not Original Equipment parts and are not sponsored, affiliated or otherwise connected with any major brand.

Hose Sleeves & Straps - Dust Caps



Hanging Strap, Hook and Loop

PART	DIAMETER	PROOF TEST LOAD	TYPE	MINIMUM ORDER QTY
A-HS1719	Adjustable 1.7"-1.9"	100 lbs	Standard	10
A-HSHD1819	Adjustable 1.8"-1.9"	750 lbs	Heavy Duty	5
A-HS2125	Adjustable 2.1"-2.5"	100 lbs	Standard	10
A-HSHD2325	Adjustable 2.3"-2.5"	750 lbs	Heavy Duty	5
A-HS2838	Adjustable 2.8"-3.8"	100 lbs	Standard	10
A-HSHD3238	Adjustable 3.2"-3.8"	750 lbs	Heavy Duty	5
A-HS3451	Adjustable 3.4"-5.1"	100 lbs	Standard	10
A-HSHD3851	Adjustable 3.8"-5.1"	750 lbs	Heavy Duty	5



Coupling kit w/ 1/2" NPT, features: One-hand connect/disconnect w/ pressure on either or both halves, a new break-away clamp of unique design & two 8200-4MB, automatic couplings - qty 2 - 8010-4MB & qty 2 -8250-4MB

Coupler Kit

PART	DESCRIPTION
A-85004	Hyd Coupler Kit
A-8500-4-P	Hyd Coupler Kit



Dust Cap

PART	DESCRIPTION
A-1272196C1	Cap; Coupler Dust

Parts are not Original Equipment parts and are not sponsored, affiliated or otherwise connected with any major brand.

HYDRAULICS

HYDRAULICS

Dust Plugs & Caps

HYDRAULICS



Display includes rack w/ 10 of each 6 colors of both 3/8" & 1/2" plugs and caps.

Dust Plugs and Caps Display

PART	DESCRIPTION	NOTE	NOTE 2
A-D350032	Display, Dust Plug/Cap	Keeps Hyd. Systems Clean	Protects Hose Ends & Quick Couplings



Dust Caps & Plugs

COLOR	3/8" DUST PLUGS	3/8" DUST CAPS	1/2" DUST PLUGS	1/2" DUST CAPS
BLACK	A-P211309	A-C211315	A-P211009	A-C211015
GREEN	A-P211310	A-C211316	A-P211010	A-C211016
RED	A-P211311	A-C211317	A-P211011	A-C211017
YELLOW	A-P211312	A-C211318	A-P211012	A-C211018
ORANGE	A-P211313	A-C211319	A-P211013	A-C211019
BLUE	A-P211048	A-C211175	A-P211014	A-C211020

Dust Plugs

PART	DESCRIPTION	PKG QTY	FITS
A-5205-4M-GR-P	Green Dust Plug, 1/2" (10 pkg)	minimum order qty 10	4000 Series, 4200 Series, 5000 Series, 6600 Series, 8200 Series
A-5205-4M-YE-P	Yellow Dust Plug, 1/2" (10 pkg)	minimum order qty 10	4000 Series, 4200 Series, 5000 Series, 6600 Series, 8200 Series
A-5205-4M-BU-P	Blue Dust Plug, 1/2" (10pk)	minimum order qty 10	4000 Series, 4200 Series, 5000 Series, 6600 Series, 8200 Series

Dust Caps

PART	DESCRIPTION	PUMP	FITS
A-5209-4M-P	Black Dust Cap, 1/2" (2 pkg)	minimum order qty 10	6600 Series
A-5209-4M-GR-P	Green Dust Cap, 1/2" (10 pkg)	minimum order qty 10	6600 Series
A-5209-4M-RE-P	Red Dust Cap, 1/2" (10 pkg)	minimum order qty 10	6600 Series
A-5209-4M-YE-P	Yellow Dust Cap, 1/2" (10 pkg)	minimum order qty 10	6600 Series
A-5209-4M-BU-P	Blue Dust Cap, 1/2" (10 pkg)	minimum order qty 10	6600 Series

Parts are not Original Equipment parts and are not sponsored, affiliated or otherwise connected with any major brand.



4000 Series Quick Couplers

PART	DESCRIPTION	BODY SIZE	THREAD SIZE	STYLE
A-4000-2P	Complete Quick Coupler	1/4"	1/4-18 NPTF	poppet
A-4000-2P-P	Complete Quick Coupler	1/4"	1/4-18 NPTF	poppet
A-4050-2P	Female Coupler Body	1/4"	1/4-18 NPTF	poppet
A-4050-2P-P	Female Coupler Body	1/4"	1/4-18 NPTF	poppet
A-4010-2P	Male Tip	1/4"	1/4-18 NPTF	poppet
A-4010-2P-P	Male Tip	1/4"	1/4-18 NPTF	poppet
A-5205-2M	Dust Plug, 1/4" (2 pkg)	1/4"		
A-5205-2M-P	Dust Plug, 1/4" (2 pkg)	1/4"		
A-5209-2M	Dust Cap, 1/4" (2 pkg)	1/4"		
A-5209-2M-P	Dust Cap, 1/4" (2 pkg)	1/4"		
A-4000-3	Complete Quick Coupler	3/8"	3/8-18 NPTF	popit
A-4000-3P-P	Complete Quick Coupler	3/8"	3/8-18 NPTF	popit
A-4050-3	Female Coupler Body	3/8"	3/8-18 NPTF	ball
A-4050-3-P	Female Coupler Body	3/8"	3/8-18 NPTF	ball
A-4010-3P	Male Tip	3/8"	3/8-18 NPTF	poppet
A-4010-3P-P	Male Tip	3/8"	3/8-18 NPTF	poppet
A-5205-3	Dust Plug, 3/8" (2 pkg)	3/8"		
A-5209-3	Dust Cap w/Chain, 3/8" (2 pkg)	3/8"		
A-4000-4MB	Complete Quick Coupler	1/2"	1/2-14 NPTF	ball
A-4000-4MB-P	Complete Quick Coupler	1/2"	1/2-14 NPTF	ball
A-4050-4MB	Female Coupler Body	1/2"	1/2-14 NPTF	ball
A-4050-4MB-P	Female Coupler Body	1/2"	1/2-14 NPTF	ball
A-8010-4MB	Male Tip	1/2"	1/2-14 NPTF	ball
A-8010-4MB-P	Male Tip	1/2"	1/2-14 NPTF	ball
A-5205-4M	Dust Plug, 1/2" (2 pkg)	1/2"		
A-5209-4	Dust Cap w/Chain, 1/2" (2 pkg)	1/2"		
A-4000-4PMB	Complete Quick Coupler	1/2"	1/2-14 NPTF	poppet
A-4000-4PMB-P	Complete Quick Coupler	1/2"	1/2-14 NPTF	poppet
A-4050-4PMB	Female Coupler Body	1/2"	1/2-14 NPTF	poppet
A-4050-4PMB-P	Female Coupler Body	1/2"	1/2-14 NPTF	poppet
A-8010-4PMB	Male Tip	1/2"	1/2-14 NPTF	poppet
A-8010-4PMB-P	Male Tip	1/2"	1/2-14 NPTF	poppet
A-5205-4M	Dust Plug, 1/2" (2 pkg)	1/2"		
A-5209-4	Dust Cap w/Chain, 1/2" (2 pkg)	1/2"		

Parts are not Original Equipment parts and are not sponsored, affiliated or otherwise connected with any major brand.

HYDRAULICS

Quick Couplers



4000 Series Quick Couplers

PART	DESCRIPTION	BODY SIZE	THREAD SIZE	STYLE
A-4000-5	Complete Quick Coupler	1/2"	3/4-14 NPTF	ball
A-4000-5-P	Complete Quick Coupler	1/2"	3/4-14 NPTF	ball
A-4050-5	Female Coupler Body	1/2"	3/4-14 NPTF	ball
A-4050-5-P	Female Coupler Body	1/2"	3/4-14 NPTF	ball
A-8010-5MB	Male Tip	1/2"	3/4-14 NPTF	ball
A-8010-5MB-P	Male Tip	1/2"	3/4-14 NPTF	ball
A-5205-4M	Dust Plug, 1/2" (2 pkg)	1/2"		
A-5209-4	Dust Cap w/Chain, 1/2" (2 pkg)	1/2"		
A-4000-5P	Complete Quick Coupler	1/2"	3/4-14 NPTF	poppet
A-4000-5P-P	Complete Quick Coupler	1/2"	3/4-14 NPTF	poppet
A-8010-5MB	Male Tip	1/2"	3/4-14 NPTF	ball
A-8010-5MB-P	Male Tip	1/2"	3/4-14 NPTF	ball
A-5205-4M	Dust Plug, 1/2" (2 pkg)	1/2"		
A-5209-4	Dust Cap w/Chain, 1/2" (2 pkg)	1/2"		
A-4000-15	Complete Quick Coupler	1/2"	3/4-16 ORB	ball
A-4050-15	Female Coupler Body	1/2"	3/4-16 ORB	ball
A-4050-15-P	Female Coupler Body	1/2"	3/4-16 ORB	ball
A-8010-15	Male Tip	1/2"	3/4-16 ORB	ball
A-8010-15-P	Male Tip	1/2"	3/4-16 ORB	ball
A-5205-4M	Dust Plug, 1/2" (2 pkg)	1/2"		
A-5209-4	Dust Cap w/Chain, 1/2" (2 pkg)	1/2"		
A-4000-15P	Complete Quick Coupler	1/2"	3/4-16 ORB	poppet
A-4000-15P-P	Complete Quick Coupler	1/2"	3/4-16 ORB	poppet
A-4050-15P	Female Coupler Body	1/2"	3/4-16 ORB	poppet
A-4050-15P-P	Female Coupler Body	1/2"	3/4-16 ORB	poppet
A-8010-15P	Male Tip	1/2"	3/4-16 ORB	poppet
A-8010-15P-P	Male Tip	1/2"	3/4-16 ORB	poppet
A-5205-4M	Dust Plug, 1/2" (2 pkg)	1/2"		
A-5209-4	Dust Cap w/Chain, 1/2" (2 pkg)	1/2"		
A-4000-16	Complete Quick Coupler	1/2"	7/8-14 ORB	ball
A-4000-16-P	Complete Quick Coupler	1/2"	7/8-14 ORB	ball
A-4050-16	Female Coupler Body	1/2"	7/8-14 ORB	ball
A-4050-16-P	Female Coupler Body	1/2"	7/8-14 ORB	ball
A-8010-16	Male Tip	1/2"	7/8-14 ORB	ball
A-8010-16-P	Male Tip	1/2"	7/8-14 ORB	ball
A-5205-4M	Dust Plug, 1/2" (2 pkg)	1/2"		
A-5209-4	Dust Cap w/Chain, 1/2" (2 pkg)	1/2"		

Parts are not Original Equipment parts and are not sponsored, affiliated or otherwise connected with any major brand.



4000 Series Quick Couplers

PART	DESCRIPTION	BODY SIZE	THREAD SIZE	STYLE
A-4000-16P	Complete Quick Coupler	1/2"	7/8-14 ORB	poppet
A-4000-16P-P	Complete Quick Coupler	1/2"	7/8-14 ORB	poppet
A-4050-16P	Female Coupler Body	1/2"	7/8-14 ORB	poppet
A-4050-16P-P	Female Coupler Body	1/2"	7/8-14 ORB	poppet
A-8010-16P	Male Tip	1/2"	7/8-14 ORB	poppet
A-8010-16P-P	Male Tip	1/2"	7/8-14 ORB	poppet
A-5205-4M	Dust Plug, 1/2" (2 pkg)	1/2"		
A-5209-4	Dust Cap w/Chain, 1/2" (2 pkg)	1/2"		
A-4100-5	Complete Quick Coupler	3/4"	3/4-14 NPTF	ball
A-4100-5-P	Complete Quick Coupler	3/4"	3/4-14 NPTF	ball
A-4150-5	Female Coupler Body	3/4"	3/4-14 NPTF	ball
A-4150-5-P	Female Coupler Body	3/4"	3/4-14 NPTF	ball
A-4110-5	Male Tip	3/4"	3/4-14 NPTF	ball
A-4110-5-P	Male Tip	3/4"	3/4-14 NPTF	ball
A-5205-5	Dust Plug, 3/4" (2 pkg)	3/4"		
A-5209-5	Dust Cap, 3/4" (2 pkg)	3/4"		
A-5209-5M-P	Dust Cap, 3/4" (2 pkg)	3/4"		
A-4000-6P	Complete Quick Coupler	1"	1-11 1/2 NPTF	poppet
A-4000-6P-P	Complete Quick Coupler	1"	1-11 1/2 NPTF	poppet
A-4050-6P	Female Coupler Body	1"	1-11 1/2 NPTF	poppet
A-4050-6P-P	Female Coupler Body	1"	1-11 1/2 NPTF	poppet
A-4010-6P	Male Tip	1"	1-11 1/2 NPTF	poppet
A-4010-6P-P	Male Tip	1"	1-11 1/2 NPTF	poppet
A-5205-6	Dust Plug, 1" (2 pkg)	1"		
A-5209-6	Dust Cap, 1" (2 pkg)	1"		
A-5209-6M-P	Dust Cap, 1" (2 pkg)	1"		

Parts are not Original Equipment parts and are not sponsored, affiliated or otherwise connected with any major brand.

HYDRAULICS

Quick Couplers



Agricultural Quick Couplings feature: Double acting sleeve for one handed operation when coupler is clamped, poppet valves are available to prevent uncoupled leakage. Rated pressure is 3000 PSI.

4200 Series Quick Couplers

PART	DESCRIPTION	BODY SIZE	THREAD SIZE	STYLE
A-4200-3P	Complete Quick Coupler	3/8"	3/8-18 NPTF	poppet
A-4200-3P-P	Complete Quick Coupler	3/8"	3/8-18 NPTF	poppet
A-4250-3P	Female Coupler Body	3/8"	3/8-18 NPTF	poppet
A-4250-3P-P	Female Coupler Body	3/8"	3/8-18 NPTF	poppet
A-4010-3P	Male Tip	3/8"	3/8-18 NPTF	poppet
A-4010-3P-P	Male Tip	3/8"	3/8-18 NPTF	poppet
A-5205-3	Dust Plug, 2 pk	3/8"		
A-5209-3	Dust Cap w/Chain, 3/8" (2 pkg)	3/8"		
A-4200-4MB	Complete Quick Coupler	1/2"	1/2-14 NPTF	ball
A-4200-4MB-P	Complete Quick Coupler	1/2"	1/2-14 NPTF	ball
A-4250-4MB	Female Coupler Body	1/2"	1/2-14 NPTF	ball
A-4250-4MB-P	Female Coupler Body	1/2"	1/2-14 NPTF	ball
A-8010-4MB	Male Tip	1/2"	1/2-14 NPTF	ball
A-8010-4MB-P	Male Tip	1/2"	1/2-14 NPTF	ball
A-5205-4M	Dust Plug, 1/2" (2 pkg)	1/2"		
A-5209-4	Dust Cap w/Chain, 1/2" (2 pkg)	1/2"		
A-4200-4PMB	Complete Quick Coupler	1/2"	1/2-14 NPTF	poppet
A-4250-4PMB	Female Coupler Body	1/2"	1/2-14 NPTF	poppet
A-4250-4PMB-P	Female Coupler Body	1/2"	1/2-14 NPTF	poppet
A-8010-4PMB	Male Tip	1/2"	1/2-14 NPTF	poppet
A-8010-4PMB-P	Male Tip	1/2"	1/2-14 NPTF	poppet
A-5205-4M	Dust Plug, 1/2" (2 pkg)	1/2"		
A-5209-4	Dust Cap w/Chain, 1/2" (2 pkg)	1/2"		
A-4200-15	Complete Quick Coupler	1/2"	3/4-16 ORB	ball
A-4200-15-P	Complete Quick Coupler	1/2"	3/4-16 ORB	ball
A-4250-15	Female Coupler Body	1/2"	3/4-16 ORB	ball
A-4250-15-P	Female Coupler Body	1/2"	3/4-16 ORB	ball
A-8010-15	Male Tip	1/2"	3/4-16 ORB	ball
A-8010-15-P	Male Tip	1/2"	3/4-16 ORB	ball
A-5205-4M	Dust Plug, 1/2" (2 pkg)	1/2"		
A-5209-4	Dust Cap w/Chain, 1/2" (2 pkg)	1/2"		
A-4200-15P	Complete Quick Coupler	1/2"	3/4-16 ORB	poppet
A-4200-15P-P	Complete Quick Coupler	1/2"	3/4-16 ORB	poppet
A-4250-15P	Female Coupler Body	1/2"	3/4-16 ORB	poppet
A-4250-15P-P	Female Coupler Body	1/2"	3/4-16 ORB	poppet
A-8010-15P	Male Tip	1/2"	3/4-16 ORB	poppet
A-8010-15P-P	Male Tip	1/2"	3/4-16 ORB	poppet
A-5205-4M	Dust Plug, 1/2" (2 pkg)	1/2"		
A-5209-4	Dust Cap w/Chain, 1/2" (2 pkg)	1/2"		

Parts are not Original Equipment parts and are not sponsored, affiliated or otherwise connected with any major brand.



6600 series couplings are interchangeable with Aeroquip FD56, 5600, Series. Body cases are case hardened. 1/4" body is rated @ 5000 PSI, other sized @ 4000 PSI.

6600 Series Quick Couplers

PART	DESCRIPTION	BODY SIZE	THREAD SIZE	STYLE
A-6601-4-4	Female Coupler Body	1/4"	1/4-18 NPTF	poppet
A-6601-4-4-P	Female Coupler Body	1/4"	1/4-18 NPTF	
A-6602-4-4	Male Tip	1/4"	1/4-18 NPTF	poppet
A-6602-4-4-P	Male Tip	1/4"	1/4-18 NPTF	
A-H1-65M	Dust Plug, 1/4" (2 pkg)	1/4"		
A-6601-6-6	Female Coupler Body	3/8"	3/8-18 NPTF	ball
A-6601-6-6-P	Female Coupler Body	3/8"	3/8-18 NPTF	ball
A-6602-6-6	Male Tip	3/8"	3/8-18 NPTF	ball
A-6602-6-6-P	Male Tip	3/8"	3/8-18 NPTF	ball
A-6610-6-6	Male Tip	3/8"	9/16-18 ORB	Poppet
A-6610-6-6-P	Male Tip	3/8"	9/16-18 ORB	
A-6601-8-10	Female Coupler Body	1/2"	1/2-14 NPTF	ball
A-6601-8-10-P	Female Coupler Body	1/2"	1/2-14 NPTF	ball
A-6602-8-10	Male Tip	1/2"	1/2-14 NPTF	ball
A-6602-8-10-P	Male Tip	1/2"	1/2-14 NPTF	ball
A-5205-4M	Dust Plug, 1/2" (2 pkg)	1/2"		
A-5209-4M	Dust Cap, 1/2" (2 pkg)	1/2"		
A-5209-4M-P	Black Dust Cap, 1/2"	1/2"		
A-6601-12-10	Female Coupler Body	1/2"	3/4-16 NPTF	ball
A-6601-12-10-P	Female Coupler Body	1/2"	3/4-16 NPTF	ball
A-6602-12-10	Male Tip	1/2"	3/4-16 NPTF	poppet
A-6602-12-10-P	Male Tip	1/2"	3/4-16 NPTF	poppet
A-5205-4M	Dust Plug, 1/2" (2 pkg)	1/2"		
A-5209-4M	Dust Cap, 1/2" (2 pkg)	1/2"		
A-5209-4M-P	Black Dust Cap, 1/2"	1/2"		
A-6608-8-10	Female Coupler Body	1/2"	3/4-16 ORB	ball
A-6610-8-10	Male Tip	1/2"	3/4-16 ORB	ball
A-5205-4M	Dust Plug, 1/2" (2 pkg)	1/2"		
A-5209-4M	Dust Cap, 1/2" (2 pkg)	1/2"		
A-5209-4M-P	Black Dust Cap, 1/2"	1/2"		
A-6608-10-10	Female Coupler Body	1/2"	7/8-14 ORB	ball
A-6608-10-10-P	Female Coupler Body	1/2"	7/8-14 ORB	ball
A-6610-10-10	Male Tip	1/2"	7/8-14 ORB	ball
A-6610-10-10-P	Male Tip	1/2"	7/8-14 ORB	ball
A-5205-4M	Dust Plug, 1/2" (2 pkg)	1/2"		
A-5209-4M	Dust Cap, 1/2" (2 pkg)	1/2"		
A-5209-4M-P	Black Dust Cap, 1/2"	1/2"		

Parts are not Original Equipment parts and are not sponsored, affiliated or otherwise connected with any major brand.

HYDRAULICS

Quick Couplers



6600 series couplings are interchangeable with Aeroquip FD56, 5600, Series. Body cases are case hardened. 1/4" body is rated @ 5000 PSI, other sized @ 4000 PSI.

6600 Series Quick Couplers

PART	DESCRIPTION	BODY SIZE	THREAD SIZE	STYLE
A-6601-12-12	Female Coupler Body	3/4"	3/4-14 NPTF	ball
A-6601-12-12-P	Female Coupler Body	3/4"	3/4-14 NPTF	ball
A-6602-12-12	Male Tip	3/4"	3/4-14 NPTF	ball
A-6602-12-12-P	Male Tip	3/4"	3/4-14 NPTF	ball
A-6659-12M	Female Dust Plug, 2 pk	3/4"		
A-6608-12-12	Female Coupler Body	3/4"	1 1/16-12 ORB	ball
A-6610-12-12	Male Tip			
A-6610-12-12-P	Male Tip	3/4"	1 1/16-12 ORB	ball
A-6659-12M	Female Dust Plug, 2 pk	3/4"		
A-6601-16-16	Female Coupler Body	1"	1-11 1/2 NPTF	ball
A-6601-16-16-P	Female Coupler Body	1"	1-11 1/2 NPTF	ball
A-6602-16-16	Male Tip	1"	1-11 1/2 NPTF	ball
A-6602-16-16-P	Male Tip	1"	1-11 1/2 NPTF	ball

Parts are not Original Equipment parts and are not sponsored, affiliated or otherwise connected with any major brand.



Connect-Under-Pressure is permitted with the 8200 coupler. Double acting sleeve allows one handed operation. Rated pressure is 3000 PSI and 12 GPM rated flow.

8200 Series Quick Couplers

PART	DESCRIPTION	BODY SIZE	THREAD SIZE	STYLE
A-8200-4MB	Complete Quick Coupler	1/2"	1/2-14 NPTF	ball
A-8200-4MB-P	Complete Quick Coupler	1/2"	1/2-14 NPTF	ball
A-8250-4MB	Female Coupler Body	1/2"	1/2-14 NPTF	ball
A-8250-4MB-P	Female Coupler Body	1/2"	1/2-14 NPTF	ball
A-8010-4PMB	Male Tip	1/2"	1/2-14 NPTF	poppet
A-8010-4PMB-P	Male Tip	1/2"	1/2-14 NPTF	poppet
A-5205-4M	Dust Plug, 1/2" (2 pkg)	1/2"		
A-5209-4	Dust Cap w/Chain, 1/2" (2 pkg)	1/2"		
A-8200-15	Complete Quick Coupler	1/2"	3/4-16 ORB	ball
A-8200-15-P	Complete Quick Coupler	1/2"	3/4-16 ORB	ball
A-8250-15	Female Coupler Body	1/2"	3/4-16 ORB	ball
A-8250-15-P	Female Coupler Body	1/2"	3/4-16 ORB	ball
A-8010-15P	Male Tip	1/2"	3/4-16 ORB	poppet
A-8010-15P-P	Male Tip	1/2"	3/4-16 ORB	poppet
A-5205-4M	Dust Plug, 1/2" (2 pkg)	1/2"		
A-5209-4	Dust Cap w/Chain, 1/2" (2 pkg)	1/2"		
A-8200-16	Complete Quick Coupler	1/2"	7/8-14 ORB	ball
A-8200-16-P	Complete Quick Coupler	1/2"	7/8-14 ORB	ball
A-8250-16	Female Coupler Body	1/2"	7/8-14 ORB	ball
A-8250-16-P	Female Coupler Body	1/2"	7/8-14 ORB	ball
A-8010-16P	Male Tip	1/2"	7/8-14 ORB	poppet
A-8010-16P-P	Male Tip	1/2"	7/8-14 ORB	poppet
A-5205-4M	Dust Plug, 1/2" (2 pkg)	1/2"		
A-5209-4	Dust Cap w/Chain, 1/2" (2 pkg)	1/2"		

Parts are not Original Equipment parts and are not sponsored, affiliated or otherwise connected with any major brand.

HYDRAULICS

Quick Couplers



Connect-Under-Pressure is permitted with the 9200 lever operated coupler. Valves close automatically if coupling is accidentally disconnected. Rated pressure is 3000 PSI and 12 GPM rated flow.

9200 Series Quick Couplers

PART	DESCRIPTION	STYLE	BODY SIZE	THREAD SIZE
A-9250-4L	LH Female Coupler Body	Yellow Handle	1/2"	1/2-14 NPTF
A-9250-4L-P	LH Female Coupler Body	Yellow Handle	1/2"	1/2-14 NPTF
A-9250-4R	RH Female Coupler Body	Red Handle	1/2"	1/2-14 NPTF
A-9250-4R-P	RH Female Coupler Body	Red Handle	1/2"	1/2-14 NPTF
A-8010-4PMB	Male Tip	poppet	1/2"	1/2-14 NPTF
A-8010-4PMB-P	Male Tip	poppet	1/2"	1/2-14 NPTF
A-9507-4-1H	Female Automatic Dust Cap		1/2"	
A-5209-4	Dust Cap w/Chain, 1/2" (2 pkg)		1/2"	
A-9500-4	Complete Coupler Assy.	ball	1/2"	1/2-14 NPTF
A-9500-4-P	Complete Coupler Assy.	ball	1/2"	1/2-14 NPTF
A-9250-16L-YE	LH Female Coupler Body	Yellow Handle	1/2"	7/8-14 ORB
A-9250-16L-YE-P	LH Female Coupler Body	Yellow Handle	1/2"	7/8-14 ORB
A-9250-16R-RE	RH Female Coupler Body	Red Handle	1/2"	7/8-14 ORB
A-9250-16R-RE-P	RH Female Coupler Body	Red Handle	1/2"	7/8-14 ORB
A-8010-16P	Male Tip	poppet	1/2"	7/8-14 ORB
A-8010-16P-P	Male Tip	poppet	1/2"	7/8-14 ORB
A-9507-4-1H	Female Automatic Dust Cap		1/2"	
A-5209-4	Dust Cap w/Chain, 1/2" (2 pkg)		1/2"	

Parts are not Original Equipment parts and are not sponsored, affiliated or otherwise connected with any major brand.

HYDRAULICS

Breakaway Clamps - Ag Adapters



HYDRAULICS

Breakaway Couplers

PART	DESCRIPTION	NOTE
A-44A50014	Clamp, Single Breakaway	For couplers w/ 1-1/2" sleeves
A-5001-4-P	Clamp, Single Breakaway	For couplers w/ 1-1/2" sleeves
A-44A50064	Clamp, Double Breakaway	For couplers w/ 1-1/2" sleeves
A-5006-4-P	Clamp, Double Breakaway	For couplers w/ 1-1/2" sleeves
A-44A50054	Metal Dust Plug, 1/2"	2 per pkg
A-5005-4-P	Metal Dust Plug, 1/2"	2 per pkg



Ag Coupler Adapters

PART	Adapts This Male Tip	TO THIS FEMALE BODY
A-4060-4MB	Pioneer: 8010-4, 8010-15	JD: old style
A-4060-4MB-P	Pioneer: 8010-4, 8010-15	JD: old style
A-4065-4L	JD: AR93819 old style	JD: new style; Ford: ISO; Pioneer: 9250
A-4065-4L-P	JD: AR93819 old style	JD: new style; Ford: ISO; Pioneer: 9250
A-4065-4MB	JD: AR93819 old style	Pioneer: 4050, 4250, 6600, 8250, 8450, 9250
A-4065-4MB-P	JD: AR93819 old style	Pioneer: 4050, 4250, 6600, 8250, 8450, 9250
A-4067-4MB	JD: AR93819 old style	IH: old style
A-4067-4MB-P	JD: AR93819 old style	IH: old style
A-4068-4MB	JD: AR93819 old style	Case: old style
A-4070-4MB	Pioneer: 8010-4, 8010-15	IH: old style
A-4070-4MB-P	Pioneer: 8010-4, 8010-15	IH: old style
A-4075-4MB	IH: 1272770, 544787R91	Pioneer: 4050, 4250, 6600, 8250, 8450, 9250
A-4075-4MB-P	IH: 1272770, 544787R91	Pioneer: 4050, 4250, 6600, 8250, 8450, 9250
A-4076-4MB	IH: 1272770, 544787R91	JD: old style
A-4076-4-P	IH: 1272770, 544787R91	JD: old style
A-4080-4MB	Pioneer: 8010-4, 8010-15	Case: old style
A-4080-4MB-P	Pioneer: 8010-4, 8010-15	Case: old style

Parts are not Original Equipment parts and are not sponsored, affiliated or otherwise connected with any major brand.

HYDRAULICS

OEM Adapters



Converts 20, 30, and 40 Series JD To ISO Pioneer Style Couplers

Conversion Kit

PART	DESCRIPTION
A-RE206778	Conversion Kit, JD To ISO Coupler (Pioneer Styler)



OEM Coupler Adapters

PART	DESCRIPTION	THREAD SIZE	REPLACES	NOTES
A-5080-4	Pioneer Male Tip	1/2 NPTF	A160884	Connects with Case A28542 and similar female bodies.
A-5080-4-P	Pioneer Male Tip	1/2 NPTF	A160884	Connects with Case A28542 and similar female bodies.
A-8010-4MB	Male Tip	1/2"	242678M91	Connects w/ Ford and similar female bodies.
A-8010-4MB-P	Male Tip	1/2"	242678M91	Connects w/ Ford and similar female bodies.
A-5060-15	Pioneer Male Tip	3/4 ORB	AR30210, AR93819	Connects with JD AR47331 sleeve type female bodies.
A-5060-15-P	Pioneer Male Tip	3/4 ORB	AR30210, AR93819	Connects with JD AR47331 sleeve type female bodies.
A-4056-15	Female Body	3/4 ORB	AR47331, RE15361	Connects with John Deere AR30210 & Pioneer 5060-4 male tips.
A-4056-15-P	Female Body	3/4 ORB	AR47331, RE15361	Connects with John Deere AR30210 & Pioneer 5060-4 male tips.
A-8010-15P	Male Tip	1/2"	AR94522	Connect-Under-Pressure is permitted with the 9200 lever operated coupler. Valves close automatically if coupling is accidentally disconnected. Rated pressure is 3000 PSI and 12 GPM rated flow.
A-8010-15P-P	Male Tip	1/2"	AR94522	Connect-Under-Pressure is permitted with the 9200 lever operated coupler. Valves close automatically if coupling is accidentally disconnected. Rated pressure is 3000 PSI and 12 GPM rated flow.
A-5070-4	Pioneer Male Tip	1/2 NPTF	1272770	Connects with IH 544788R1 and Pioneer 4057-4 female bodies.
A-5070-16	Pioneer Male Tip	7/8 ORB	544787R1	Connects with IH 544788R1 and Pioneer 4057-4 female bodies.
A-4057-4MB	Pioneer Female Body	1/2 NPTF		Connects with IH 544787R91 & Pioneer 5070-4 male tips.
A-4057-4MB-P	Pioneer Female Body	1/2 NPTF		Connects with IH 544787R91 & Pioneer 5070-4 male tips.
A-8010-15	Male Tip	1/2"	1026700M91	Agricultural Quick Couplings feature: Double acting sleeve for one handed operation when coupler is clamped, poppet valves are available to prevent uncoupled leakage. Rated pressure is 3000 PSI.

Parts are not Original Equipment parts and are not sponsored, affiliated or otherwise connected with any major brand.

OEM Coupler Adapters

PART	DESCRIPTION	THREAD SIZE	REPLACES	NOTES
A-8010-15-P	Male Tip	1/2"	1026700M91	Agricultural Quick Couplings feature: Double acting sleeve for one handed operation when coupler is clamped, poppet valves are available to prevent uncoupled leakage. Rated pressure is 3000 PSI.
A-5077-16	Male Tip	7/8 ORB	395149R1	Connects with IH 395150R1 female body.
A-5077-16-P	Male Tip	7/8 ORB	395149R1	Connects with IH 395150R1 female body.
A-5077-4	Male Tip	1/2 NPTF	395151R1	Connects with IH 395150R1 female body.
A-5077-4-P	Male Tip	1/2 NPTF	395151R1	Connects with IH 395150R1 female body.
A-5060-4	Male Tip	1/2 NPTF	RE11447	Connects with JD AR47331 sleeve type female bodies.
A-5060-4-P	Male Tip	1/2 NPTF	RE11447	Connects with JD AR47331 sleeve type female bodies.
A-4056-4MB	Female Body	1/2 NPTF		Connects with JD AR30210 & Pioneer 5060-4 male tips.
A-4056-4MB-P	Female Body	1/2 NPTF		Connects with JD AR30210 & Pioneer 5060-4 male tips.
A-8010-4PMB	Male Tip	1/2"	D3NNB964A	Connect-Under-Pressure is permitted with the 9200 lever operated coupler. Valves close automatically if coupling is accidentally disconnected. Rated pressure is 3000 PSI and 12 GPM rated flow.
A-8010-4PMB-P	Male Tip	1/2"	D3NNB964A	Connect-Under-Pressure is permitted with the 9200 lever operated coupler. Valves close automatically if coupling is accidentally disconnected. Rated pressure is 3000 PSI and 12 GPM rated flow.

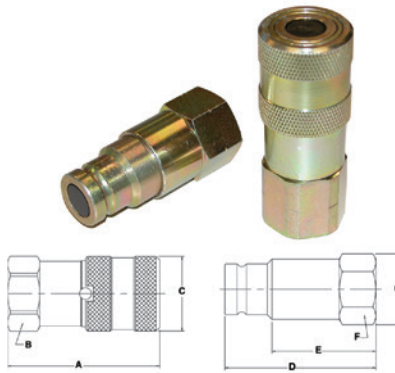
Flat Face Socket/Plug Set

PART	DESCRIPTION	A	B	C	D	E	F	G	H
A-FF2514FPS	Flat Face Hydraulic Coupler Socket & Plug Set (1/4" NPT) Notes: Set Consists Of FF2514FP-A Socket & FF2524FP-A Plug.	1.924"	1/4" NPT	1.141"	1.893"	1.418"	1/4" NPT	.865"	.636"
A-FF3718FPS	Flat Face Hydraulic Coupler Socket & Plug Set (3/8" NPT) Notes: Set Consists Of FF3718FP-A Socket & FF3728FP-A Plug	2.920"	3/8" NPT	1.183"	2.550"	1.890"	3/8" NPT	1.060"	0.775"
A-FF5018FPS	Flat Face Hydraulic Coupler Socket & Plug Set (1/2" NPT) Notes: Set Consists Of FF5018FP-A Socket & FF5028FP-A Plug	3.411"	1/2" NPT	1.500"	3.049"	2.250"	1/2" NPT	1.250"	

Parts are not Original Equipment parts and are not sponsored, affiliated or otherwise connected with any major brand.

HYDRAULICS



Flat Face Socket/Plug Set

PART	DESCRIPTION	A	B	C
A-FF3718FP-A	Flat Hydraulic Coupler Socket, Female, 3/8" NPT			
A-FF3728FP-A	Flat Hydraulic Coupler Plug, Male, 3/8" NPT			
A-FF5018FP-A	Flat Hydraulic Coupler Socket, Female, 1/2" NPT	3.411"	.500" NPT	1.500"
A-FF-501-8FP-P	Flat Hydraulic Coupler Socket, Female, 1/2" NPT	3.411"	.500" NPT	1.500"
A-FF5028FP-A	Flat Hydraulic Coupler Plug, Male, 1/2" NPT			
A-FF-502-8FP-P	Flat Hydraulic Coupler Plug, Male, 1/2" NPT			



Flush face design eliminates hydraulic spillage and air inclusion when connecting or disconnecting. Push to connect function for ease of use.

OEM Coupler Adapters

PART	DESCRIPTION	THREAD SIZE
A-FEM-371-6FP-NL	Coupler, Female Flat Face; FEM Series, ISO16028 Used On Many Skid Steer Attachments.	3/8"-18
A-FEM-372-6FP	Coupler, Male Flat Face; FEM Series, ISO16028 Used On Many Skid Steer Attachments.	3/8"-18 NPSF
A-FEM-501-8FP-NL	Coupler, Female Flat Face; FEM Series, ISO16028 Used On Many Skid Steer Attachments.	1/2"-14 NPSF
A-FEM-501-8FP-NL-P	Coupler, Female Flat Face; FEM Series, ISO16028 Used On Many Skid Steer Attachments.	1/2"-14 NPSF
A-FEM-502-8FP	Coupler, Male Flat Face; FEM Series, ISO 16028 Used On Many Skid Steer Attachments.	1/2"-14 NPSF
A-FEM-502-8FP-P	Coupler, Male Flat Face; FEM Series, ISO 16028 Used On Many Skid Steer Attachments.	1/2"-14 NPSF
A-FEM-501-10FO-NL	Coupler, Female Flat Face; FEM Series	7/8"-14 UNF Female
A-FEM-502-10FO	Nipple; Male, Flat Face, FEM Series	7/8" Female
A-FEM-501-12FO-NL	Coupler, Female Flat Face; FEM Series	1-1/16"-12 UNF Female
A-FEM-502-12FO	Nipple; Male, Flat Face, FEM Series	1-1/16"-12 Female

Parts are not Original Equipment parts and are not sponsored, affiliated or otherwise connected with any major brand.

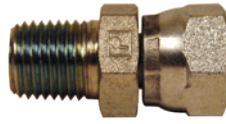

Straight Female NPT Swivel X Male NPT Adapter

PART	FEMALE NPT THREAD	MALE NPT THREAD
A-43D13	1/4 - 18	1/4 - 18
A-43D68	1/4 - 18	3/8 - 18
A-43D53	3/8 - 18	1/4 - 18
A-43D38	3/8 - 18	3/8 - 18
A-43D46	3/8 - 18	1/2 - 14
A-43D45	1/2 - 14	3/8 - 18
A-43D12	1/2 - 14	1/2 - 14
A-43D14	1/2 - 14	3/4 - 14
A-43D47	3/4 - 14	1/2 - 14
A-43D34	3/4 - 14	3/4 - 14
A-43D15	1 - 1/2-11	1 - 1/2-11



Straight Restrictor, Male NPT X Female NPSM Swivel Adapter

PART	FEMALE NPSM THREAD	MALE NPT THREAD	ORIFICE
A-43D54	3/8 - 18	3/8 - 18	1/32"
A-43D56	1/2 - 14	1/2 - 14	1/32"
A-43D57	1/2 - 14	1/2 - 14	1/16"



45° Female NPT Swivel X Male NPT Adapter

PART	FEMALE NPT THREAD	MALE NPT THREAD
A-43B13	1/4 - 18	1/4 - 18
A-43B11	1/2 - 14	1/2 - 14
A-43B12	1/2 - 14	3/4 - 14

Parts are not Original Equipment parts and are not sponsored, affiliated or otherwise connected with any major brand.



90° Female NPT Swivel X Male NPT Adapter

PART	FEMALE NPT THREAD	MALE NPT THREAD
A-43B15	1/8 - 27	1/8 - 27
A-43B14	1/4 - 18	1/4 - 18
A-43B20	3/8 - 18	3/8 - 18
A-43B22	3/8 - 18	1/2 - 14
A-43B21	1/2 - 14	3/8 - 18
A-43B23	1/2 - 14	1/2 - 14
A-43B24	1/2 - 14	3/4 - 14



90° Female NPT Swivel X Female NPT Adapter

PART	FEMALE NPT THREAD	FEMALE NPT THREAD
A-43E18	1/2 - 14	1/2 - 14



Straight Solid Male NPT X Male NPT Adapter

PART	MALE NPT THREAD	MALE NPT THREAD
A-43C43	3/8 - 18	3/8 - 18
A-43C42	1/2 - 14	1/2 - 14



Straight Female NPT Swivel X Female NPT Adapter

PART	FEMALE NPT THREAD	FEMALE NPT THREAD
A-43D16	1/4 - 18	1/4 - 18
A-43D52	3/8 - 18	3/8 - 18
A-43D50	1/2 - 14	1/2 - 14
A-43D19	3/4 - 14	3/4 - 14
A-43D20	1 - 11-1/2	1 - 11-1/2

Parts are not Original Equipment parts and are not sponsored, affiliated or otherwise connected with any major brand.



Male Pipe to Female Pipe Hex Bushing

PART	FEMALE NPT THREAD	MALE NPT THREAD
A-43G10	1/4 - 18	3/8 - 18
A-43A28	1/4 - 18	1/2 - 14
A-43A10	3/8 - 18	1/2 - 14
A-43A30	1/2 - 14	3/4 - 14



Female NPSM Swivel to Female NPSM Swivel X Male NPT Adapter

PART	FEMALE NPSM SWIVEL	MALE NPT THREAD
A-43B27	1/4 - 18 x 1/4 - 18	1/4 - 18



Female NPSM Swivel to Female NPSM Swivel X Female NPSM Swivel Adapter

PART	FEMALE NPSM SWIVEL	FEMALE NPSM SWIVEL	FEMALE NPSM SWIVEL
A-43B25	3/8 - 18	3/8 - 18	3/8 - 18
A-43B26	1/2 - 14	1/2 - 14	1/2 - 14



Female NPSM Swivel to Female NPSM Swivel X Female NPT Adapter

PART	FEMALE NPSM SWIVEL	FEMALE NPSM SWIVEL	FEMALE NPT THREAD
A-43B28	1/2 - 14	1/2 - 14	1/2 - 14
A-43B29	1/4 - 18	1/4 - 18	1/4 - 18
A-43B32	3/8 - 18	3/8 - 18	3/8 - 18

Parts are not Original Equipment parts and are not sponsored, affiliated or otherwise connected with any major brand.

HYDRAULICS

Adapters



Special Straight Solid Female ORB X Female ORB Adapter

PART	FEMALE ORB THREAD	FEMALE ORB THREAD
A-43C36	3/4 - 16	3/4 - 16
A-43C39	7/8 - 14	7/8 - 14



Special Straight Solid Female ORB X Female NPT Adapter

PART	FEMALE NPT THREAD	FEMALE ORB THREAD
A-43C37	1/2 - 14	3/4 - 16
A-43C40	1/2 - 14	7/8 - 14



Special Straight Solid Female NPT X Female NPT Adapter

PART	FEMALE NPT THREAD	FEMALE NPT THREAD
A-43C38	1/2 - 14	1/2 - 14



Straight Solid Male NPT X Female ORB Adapter

PART	MALE NPT THREAD	FEMALE ORB THREAD
A-43A11	3/8 - 18	3/4 - 16
A-43A13	1/2 - 14	3/4 - 16
A-43A19	1/2 - 14	7/8 - 14



Straight Solid Female NPT X Male ORB Adapter

PART	FEMALE NPT THREAD	MALE ORB THREAD
A-43A12	3/8 - 18	3/4 - 16
A-43A14	1/2 - 14	3/4 - 16
A-43A20	1/2 - 14	7/8 - 14

Parts are not Original Equipment parts and are not sponsored, affiliated or otherwise connected with any major brand.



Straight Solid Male ORB X Female ORB Adapter

PART	FEMALE ORB THREAD	MALE ORB THREAD
A-43A17	3/4 - 16	7/8 - 14
A-43A18	7/8 - 14	3/4 - 16
A-43A29	1 3/16"	1 5/16"



Female NPT Swivel X Male ORB Straight Adapter

PART	FEMALE NPT THREAD	MALE ORB THREAD
A-43D30	1/4 - 18	7/16 - 20
A-43D11	1/4 - 18	9/16 - 18
A-43D31	3/8 - 18	9/16 - 18
A-43D39	3/8 - 18	3/4 - 16
A-43D41	1/2 - 14	3/4 - 16
A-43D51	3/8 - 18	7/8 - 14
A-43D43	1/2 - 14	7/8 - 14
A-43D32	3/4 - 14	1-1/16 - 12



45° Female NPT Swivel X Male ORB Adapter

PART	FEMALE NPT THREAD	MALE ORB THREAD
A-43B30	1/2 - 14	3/4 - 16
A-43B31	1/2 - 14	7/8 - 14

Parts are not Original Equipment parts and are not sponsored, affiliated or otherwise connected with any major brand.



90° Female NPT Swivel X Male ORB Adapter

PART	FEMALE NPT THREAD	MALE ORB THREAD
A-43B40	1/4 - 18	7/16 - 20
A-6901-06-04-NWO	1/4" - 18	9/16" - 18
A-43B41	3/8 - 18	9/16 - 18
A-43B42	3/8 - 18	3/4 - 16
A-43B44	1/2 - 14	3/4 - 16
A-43B43	1/2 - 14	7/8 - 14
A-43B47	3/4 - 14	1-1/16 - 12



90° Female ORB X Male ORB Adapter

PART	FEMALE ORB THREAD	MALE ORB THREAD
A-43B45	3/4 - 16	3/4 - 16

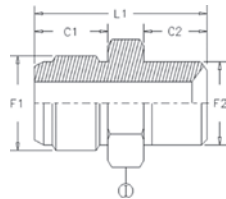

Straight Connector JIC-BSPT Male

PART	MALE BSPT	MALE JIC	L1	C1	C2	I
A-3404-06-06	3/8 - 19	9/16 - 18	33.5	14.0	12.0	19

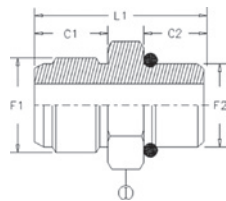

Straight Connector JIC Male-Metric Male + O-Ring

PART	MALE JIC	MALE ORB	L1	C1	C2	I
A-7400-05-12	1/2 - 20	M12 x 1.5	33.5	14.0	11.0	19
A-7400-05-14	1/2-20	M14x1.5	34.0	14.0	11.0	19
A-43C41	7/8 - 14	7/8 - 14				

Parts are not Original Equipment parts and are not sponsored, affiliated or otherwise connected with any major brand.

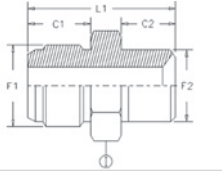

Straight Connector JIC Male-NPTF Male

PART	MALE JIC	MALE NPTF	L1	C1	C2	I
A-2404-04-04	7/16 - 20	1/4 - 18	35.5	14.0	14.5	16
A-43C28	9/16 - 18	1/4 - 18				
A-2404-06-06	9/16 - 18	9/16 - 18	19	36.0	14.0	3/8 - 18
A-43C21	3/4 - 16	3/8 - 18				
A-2404-08-08	3/4 - 16	3/4 - 16	24	15.5	17.0	1/2 - 14
A-43C23	7/8 - 14	1/2 - 14				
A-2404-08-08	3/4 - 16	1/2 - 14	15.5	17.0	19.0	24
A-2404-12-12	1-1/16 - 12	3/4 - 14	52.5	22.0	19.0	32



Male JIC 90° X Male NPT Adapter

PART	MALE JIC THREAD	MALE NPT THREAD
A-43F16	3/4 - 16	3/8 - 18
A-43F18	3/4 - 16	1/2 - 14



90° Male JIC X Male ORB

PART	MALE JIC THREAD	MALE ORB THREAD
A-VFA4023	3/4" - 16	3/4"-16



Straight Solid Male JIC X Female NPT Adapter

PART	FEMALE NPT THREAD	MALE JIC THREAD
A-43A23	3/8 - 18	3/4 - 16
A-43A24	1/2 - 14	3/4 - 16
A-43A25	1/2 - 14 NPT	7/8 - 14 JIC

Parts are not Original Equipment parts and are not sponsored, affiliated or otherwise connected with any major brand.

HYDRAULICS

Adapters



Female JIC Swivel X Female NPT Straight Adapter

PART	FEMALE JIC THREAD	FEMALE NPT THREAD
A-43D21	9/16 - 18	3/8 - 18
A-43D22	3/4 - 16	3/8 - 18
A-43D24	3/4 - 16	1/2 - 14
A-43D23	7/8 - 14	3/8 - 18
A-43D25	7/8 - 14	1/2 - 14



Straight Female JIC Swivel X Male NPT Adapter

PART	FEMALE JIC THREAD	MALE PIPE THREAD
A-43D40	3/4 - 16	3/8 - 18
A-43D42	3/4 - 16	1/2 - 14
A-43D44	7/8 - 14	1/2 - 14



Thread Tape

PART	DESCRIPTION	QUANTITY
A-47V2193	Thread Sealant Tape, 1/2"x520"	4

Parts are not Original Equipment parts and are not sponsored, affiliated or otherwise connected with any major brand.

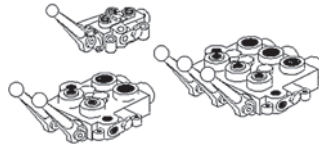

To convert open center systems to closed center systems order 1-A-1V0206 and 1- A-1R0035.

Control Valves

PART	DESCRIPTION	PRESSURE	CAPACITY	WORK PORTS	I/O PORTS	FEATURES	SYSTEM
A-SBA2	Single Spool	2500 adj	30 GPM	1/2" NPTF	3/4" NPTF	dbl act	open
A-SBA22	Double Spool	2500 adj	30 GPM	1/2" NPTF	3/4" NPTF	dbl act	open
A-SBA22CC	Double Spool	2500 adj	30 GPM	1/2" NPTF	3/4" NPTF	dbl act, no relief	closed
A-SBAF2	Double Spool	2500 adj	30 GPM	1/2" NPTF	3/4" NPTF	dbl act, float	open
A-SBAF2CC	Double Spool	2500 adj	30 GPM	1/2" NPTF	3/4" NPTF	dbl act, 1 float, no relief	closed
A-SBA222	Triple Spool	2500 adj	30 GPM	1/2" NPTF	3/4" NPTF	dbl act	open
A-SBAF22	Triple Spool Directional	2500 adj	30 GPM	1/2"	3/4" NPTF	1 float, directional	open
A-SBA333	Triple Spool	2500 adj	30 GPM	1/2" NPTF	3/4" NPTF	single acting, 2 float	open
A-SBA311	Triple Spool	2500	30 GPM	1/2" NPTF	3/4" NPTF	dbl on all 3	open
A-SCA1	Econo, 3 Position 4 Way	1500 non-adj	30 GPM	1/2" NPTF	3/4" NPTF	dbl act	open
A-SCV1	Single Spool Convertible Valve (double or single acting)	2000	25 GPM	1/2"	3/4" NPTF	spring centered	open

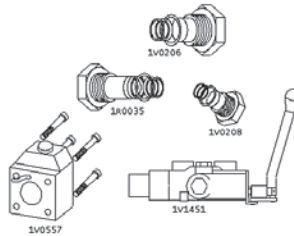

SBA Valves & Accessories

PART	DESCRIPTION	NOTE
A-1V0206	Closed Center Plug Kit for SBA Valve	Used to convert valve to closed center.
A-1R0035	No Relief Plug for SBA Valves	Used to convert valve to closed center.
A-1V0294	No Spring Detent Kit	The valve handle (and spool) remain stationary until moved by the operator. Used frequently for motor applications. Not recommended for logsplitters.
A-1V0208	Power Beyond Sleeve Kit	3/4 " NPTF, for SBA valve
A-1V0553	Handle Conn Link	
A-1V0557	Manual Detent Kit, 2 Position	spring center, for SBA valve

Parts are not Original Equipment parts and are not sponsored, affiliated or otherwise connected with any major brand.

HYDRAULICS

Valves & Accessories

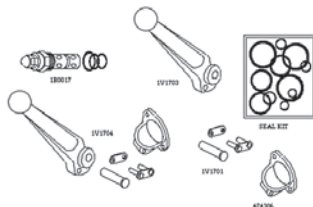

Valves & Accessories

PART	DESCRIPTION	NOTE
A-1R0017	Adjustable Relief Valve (1000-3000)	
A-1V1704	Handle w/ Pin Kit for SBA Valve	
A-1V1703	Handle Only For SBA Valve	
A-1V1701	Connector Link for Handle to Plunger	
A-4Z4306	Handle Bracket for SBA Valve	2 bolt mount
A-2V0008	Seal Kit for SBA2 One Spool Valve	
A-2V0009	Seal Kit for SBA22 & SBAF2 Two Spool Valve	
A-1V0575	Handle, Off Set	

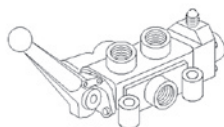

No detent in forward.

SCD2E Valve

PART	DESCRIPTION	PRESSURE	CAPACITY	WORK PORTS	I/O PORTS	FEATURES	SYSTEM
A-SCD2E	Woodsplitter Valve	2000 PSI Adjustable Pressure Relief Valve	30 GPM	1/2"	3/4" NPTF	Auto Kick-Out	Open



SRD Valve

PART	DESCRIPTION	PRESSURE	CAPACITY	I/O PORTS	FEATURES
A-SRDH	Relief Valve	1500-3000	30 GPM	3/4" NPTF	popet relief



SVS Valve

PART	DESCRIPTION	PRESSURE	CAPACITY	WORK PORTS	FEATURES
A-SVS2	Selector Valve	2500	20 GPM	1/2"	flow director

Parts are not Original Equipment parts and are not sponsored, affiliated or otherwise connected with any major brand.



Open center, spring return, inlet valve relief.

Hydraulic Control Valve

PART	DESCRIPTION	I/O PORTS	WORK PORTS	PORT	SYSTEM
A-VFG1003	Hydraulic Control Valve BSP, 2 spool	3/8" BSP	3/8" BSP	red caps=pressure, green caps=service, blue caps=tank	Open



Open Center

Hydraulic Control Valve

PART	DESCRIPTION
A-VFG1005	Hydraulic Control Valve 3/8" BSP, 3 spool



Open center, spring return, inlet valve relief.

Monoblock Control Valve

PART	DESCRIPTION	PORT
A-VFG1001	Monoblock Control Valve 3/8" BSP, single spool	red caps=pressure, green caps=service, blue caps=tank



Converts MF hydraulic to external service (valve has 3/8" BSP thread in pressure ports)

Valve & Accessories

PART	DESCRIPTION	PORT SIZE	NOTE	NOTE 2
A-VFD1104	Selector Valve	3/8" BSP	Provides a positive change over from tractor hyd. to external service.	Does away w/ need to fix the tractor lift arm in the lower position when external service is in use.
A-VFA4026	Male Plug ORB, 2 pack		3/4" Male ORB Thread	

Parts are not Original Equipment parts and are not sponsored, affiliated or otherwise connected with any major brand.

HYDRAULICS

Valves & Accessories



Replace MF cover plate, adds 2 ports. Services lift arms plus 2 external ports with return going back to valve. Ports can only be used 1 at a time.

Valve & Accessories

PART	DESCRIPTION	I/O PORTS	NOTES	NOTES 2
A-47S731	3 Way Selector Valve	3/8: NPT	Services lift arms plus two external ports w/ return going back to valve. Ports can only be used one at a time. I/O ports 3/8" NPTF.	Fits all MF tractors where 182373M1 lift cover is used.



Monoblock, double spool, double acting, 9 gallon/minute cap., STD. Handles, spring return, inlet relief valve, closed center plug & power beyond adapter available, pressure & return ports are 7/8" ORB thread, service ports are 3/4" ORB thread.

Valve & Accessories

PART	DESCRIPTION	WORK PORTS	CAPACITY	THREAD SIZE	NOTE	SYSTEM
A-VFG1009	Hydraulic Monoblock Spool Valve Sae w/Orb Fittings	3/4 - 16 RH Thread ORB	9 Gal/Min		Spring return, inlet relief valve	Open
A-220-915	Plug, Power Beyond			Male & female both 7/8-14 UNF RH Thread		
A-220-913	Plug, Closed Center			7/8-14 UNF RH Thread	Makes VFG1009 a closed center valve	
A-VFH1009	Joystick, Dual (For VFG1009 Mono Block Spool Valve)				Handle has 3 holes. 2 cables required.	
A-VFH1014	Knob, Joystick				Replacement Knob For A-VFH1009 Joystick Assembly.	
A-VFH1416	Assembly, Cable, 79.5" (For VFH1009 Joystick)				Fits all spool valves w/ A-VFH1429 fitting kit. 2 x VFH1431 fitting kits required.	
A-VLC2517	Switch, Push Bottom (For VFH1009 Joystick)					
A-VFH1429	Adapter, Cable (For VFG1001 & VFG1003 Valves)					
A-VFH1431	Joystick Cable Fitting Kit				fits VFG1005 & VFG1009 only.	

Parts are not Original Equipment parts and are not sponsored, affiliated or otherwise connected with any major brand.



Bracket

PART	DESCRIPTION	NOTE
A-1V1736	Bracket, Off Set Handle	2" Bolt Holes C-to-C



Handle Conversion Kit

PART	DESCRIPTION	NOTE
A-1V148501	Straight Handle Joystick, Direct Mount To Valve	Straight Handle. Converts 2 Spool SBA Valves to Single Joystick
A-1A9347	Ball Joint	
A-1V148502	Bent Handle Joystick, Direct Mount To Valve	Bent Handle. Converts 2 Spool SBA Valves to Single Joystick
A-1A9347	Ball Joint	
A-1V1730	Connector Link, Handle	



Adapter kit & cable must be ordered separately

Cross Control Valve Joystick Accessories

PART	DESCRIPTION	NOTE
A-VFH1421	Morse Joystick, 1 Spool	Hydraulic hose, fittings and adapters are not included.
A-VFH1424	Morse Joystick, 2 Spool	
A-VFH1110	Replacement, Rubber Handle (For VFH1421 & VFH1424)	
A-VFH1420	Mounting Kit, Control Lever (For VFH1421 & VFH1424)	

Parts are not Original Equipment parts and are not sponsored, affiliated or otherwise connected with any major brand.



Cable Assemblies

PART	DESCRIPTION
A-VFH1441	Assembly, Cable, 48" (For SBA Valves)
A-VFH1442	Assembly, Cable, 60" (For SBA Valves)
A-VFH1443	Assembly, Cable, 72" (For SBA Valves)

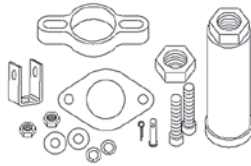

Valve Accessories

PART	DESCRIPTION
A-VFH1430	Adapter, Cable (For Cables to SBA Valves)



Remote Control Cables

PART	DESCRIPTION	OVERALL LENGTH
A-VFH1411	Assembly, Cable, 39" (For Kontak/Vapormatic Series Valves)	39.37"
A-VFH1413	Assembly, Cable, 78" (For Kontak/Vapormatic Series Valves)	78.75"
A-VFH1414	Assembly, Cable, 98" (For Kontak/Vapormatic Series Valves)	98.42"
A-VFH1415	Assembly, Cable, 118" (For Kontak/Vapormatic Series Valves)	118.11"



VFH1426



VFH1427



VFH1428

Kontak Valve Accessories

PART	DESCRIPTION	NOTE
A-VFH1426	Adapter, Cable (For Kontak/Vapormatic Series 10 Valves)	With either 3/8" or 1/2" BSP outlets. 1.8" bolt pattern.
A-VFH1427	Adapter, Cable (For Kontak/Vapormatic Series 18 Valves)	With 3/4" BSP outlets. 1.8" bolt pattern.
A-VFH1428	Adapter, Cable (For Kontak/Vapormatic Series 35 & 80 Valves)	1.46" bolt pattern Suitable for use with old type Series 35 and Series 80 valves

Parts are not Original Equipment parts and are not sponsored, affiliated or otherwise connected with any major brand.



Valve Accessories

PART	DESCRIPTION
A-VFH1116	Valve Lever Cover



Valve Accessories

PART	DESCRIPTION	NOTE
A-VFH1120	Switch & Handle Assy	Supplied complete with relay and wiring diagram. M10 thread.



Valve Accessories

PART	DESCRIPTION
A-VFH1000	Valve Handle



Valve Accessories

PART	DESCRIPTION	NOTE	NOTE 2
A-1V1702	Cross Handle Pin Kit	5/8" Between Pin Centers	For Valve Series SCV-1, SCD2E

Parts are not Original Equipment parts and are not sponsored, affiliated or otherwise connected with any major brand.

HYDRAULICS

Cylinders

HYDRAULICS



2500 PSI, Double Acting Hydraulic Cylinders

PART	BORE	STROKE	PORT SIZE	RETRACTED LENGTH	ROD DIAMETER	DEPTH CONTROL
A-208ASAE25	2"	8"	3/8"	20 1/4"	1"	
A-210-25	2"	10"	3/8"	20 1/4"	1"	
A-212-25	2"	12"	3/8"	22 1/4"	1"	
A-214-25	2"	14"		24 1/4"	1"	
A-2508ASAE25	2 1/2"	8"	3/8"	20 1/4"	1"	1"
A-2510-25	2 1/2"	10"	3/8"	20 1/4"	1"	
A-2512-25	2 1/2"	12"	3/8"	22 1/4"	1"	
A-308ASAE25	3"	8"	1/2"	20 1/4"	1 1/8"	
A-310-25	3"	10"	1/2"	20 1/4"	1 1/8"	
A-312-25	3"	12"	1/2"	22 1/4"	1 1/8"	
A-314-25	3"	14"	1/2"	24 1/4"	1 1/8"	
A-316ASAE25	3"	16"	1/2"	31 1/2"	1 1/4"	without
A-3508ASAE25	3 1/2"	8"	1/2"	20 1/4"	1 1/4"	
A-3510-25	3 1/2"	10"	1/2"	20 1/4"	1 1/4"	without
A-3516ASAE25	3 1/2"	16"	1/2"	31 1/2"	1 1/4"	without
A-408ASAE25	4"	8"	1/2"	20 1/4"	1 1/4"	
A-410-25	4"	10"	1/2"	20 1/4"	1 1/4"	
A-412-25	4"	12"	1/2"	22 1/4"	1 1/4"	
A-414-25	4"	14"	1/2"	24 5/8"	1 1/4"	without
A-416ASAE25	4"	16"	1/2"	31 1/2"	1 1/4"	without



3000 PSI, Double Acting Hydraulic Cylinders

PART	BORE	STROKE	PORT SIZE	RETRACTED LENGTH	ROD DIAMETER
A-208ASAE30	2"	8"	3/8"	20 1/4"	1 1/8"
A-2508ASAE30	2.5"	8"	3/8"	20 1/4"	1 1/8"
A-308ASAE30	3"	8"	1/2"	20 1/4"	1 1/4"
A-316ASAE30	3"	16"	1/2"	31 1/2"	1 1/4"
A-3508ASAE30	3.5"	8"	1/2"	20 1/4"	1 1/4"
A-3512-30	3.5"	12"	1/2"	22 1/4"	1 1/4"
A-3516ASAE30	3.5"	16"	1/2"	31 1/2"	1 1/4"
A-408ASAE30	4"	8"	1/2"	20 1/4"	1 1/4"
A-416ASAE30	4"	16"	1/2"	31 1/2"	1 1/4"

Parts are not Original Equipment parts and are not sponsored, affiliated or otherwise connected with any major brand.



Hydraulic Cylinder Pins

PART	DESCRIPTION	DIAMETER	USEABLE LENGTH
A-HCP04	Hyd Cylinder Pin	1"	2 1/8"
A-HCP05	Pin, Hydraulic Cylinder	1"	3"
A-HCP02	Pin, Hydraulic Cylinder	1"	3"
A-HCP03	Pin, Hydraulic Cylinder	1"	3 3/4"



Hydraulic Retainer Pins

PART	DESCRIPTION	LENGTH	WIRE SIZE	FITS
A-7M1018	Retainer Pin			
A-HPC20	Hair Pin Clip (10 pk)	100mm/3.94"	5.00mm/0.20"	Shaft 16mm-27mm/0.63"-1.06"



Hydraulic Breather Plugs

PART	DESCRIPTION	THREAD
A-1C9535	Breather Plug (2 pk)	1/4 NPT
A-1C2216	Breather Plug (2 pk)	3/8 NPT
A-1C1235	Breather Plug (2 pk)	1/2 NPT
A-2C2035	Breather Plug (2 pk)	3/4-16 ORB



Hydraulic Cylinder Depth Stops

PART	DESCRIPTION	ROD SIZE	WIDTHS
A-DP02	Stroke Control Stop Set of 4	1 1/8 - 1 1/4"	3/4", 1 1/2", 1 1/4", 1"
A-DP03	Stroke Control Stop Set of 3	1- 3/8" - 1-1/2"	3/4", 1", 1-1/4", 1- 1/2"
A-DP01	Stroke Control Stop Set of 4	1-3/8" -1 1/2"	1", 1.25", 1.5", 1.75"

Parts are not Original Equipment parts and are not sponsored, affiliated or otherwise connected with any major brand.

HYDRAULICS

O-Rings



HYDRAULICS

O-Rings

PART	WIDTH	INSIDE DIAMETER	OUTSIDE DIAMETER	STANDARD NUMBER	MIN ORDER QTY
A-44R006	1/16"	1/8"	1/4"	006	10
A-44R007	1/16"	5/32"	9/32"	007	10
A-44R008	1/16"	3/16"	5/16"	008	10
A-44R009	1/16"	7/32"	11/32"	009	10
A-44R010	1/16"	1/4"	3/8"	010	10
A-44R011	1/16	5/16	7/16	011	10
A-44R012	1/16	3/8	1/2	012	10
A-44R610012	1/16	7/16	9/16		25
A-44R014	1/16"	11/16"	13/16"	014	25
A-44R110	3/32	3/8	9/16	110	10
A-44R111	3/32	7/16	5/8	111	10
A-44R112	3/32	1/2	11/16	112	10
A-44R113	3/32	9/16	3/4	113	10
A-44R114	3/32	5/8	13/16	114	10
A-44R115	3/32	11/16	7/8	115	10
A-44R116	3/32	3/4	15/16	116	10
A-44R117S	3/32"	1/4"	7/16"	117S	10
A-44R123	3/32	1 1/4	1 3/8	123	5
A-44R210	1/8	3/4	1	210	10
A-44R211	1/8	13/16	1 1/16	211	10
A-44R212	1/8	7/8	1 1/8	212	10
A-44R213	1/8	15/16	1 3/16	213	10
A-2214BN70	1/8	1	1 1/4	214	
A-44R215	1/8	1 1/16	1 5/16	215	10
A-44R216	1/8	1 1/8	1 3/8	216	10
A-44R217	1/8	1 3/16	1 7/16	217	10
A-44R218	1/8	1 1/4	1 1/2	218	10
A-44R219	1/8	1 5/16	1 9/16	219	10
A-44R220	1/8	1 3/8	1 5/8	220	10
A-44R221	1/8	1 7/16	1 11/16	221	5
A-44R222		1 1/2	1 3/4	222	5
A-44R325	3/16	1 1/2	1 7/8	325	5
A-44R326	3/16	1 5/8	2	326	5
A-44R327	3/16	1 3/4	1 1/8	327	5
A-44R328	3/16	1 7/8	2 1/4	328	5
A-44R329	3/16	2	2 3/8	329	5
A-44R330	3/16	2 1/8	2 1/2	330	5
A-49886	5/64"	1/4"	3/8"		10

Parts are not Original Equipment parts and are not sponsored, affiliated or otherwise connected with any major brand.



O-Ring Kits

PART	DESCRIPTION	PUMP
A-B1SB12	Neoprene O-Ring Assortment	Contains: 225 o-rings of 18 most popular sizes.
A-VFE3905	O-Ring Kit, Metric	Contains: 420 metric o-rings in 32 sizes.
A-VFE3907	O-Ring Kit - Imperial	Contains: 420 Imperial o-rings in 32 sizes.

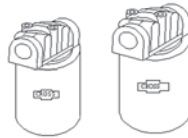

Filter Assemblies

PART	DESCRIPTION	FLOW RATE	PORT SIZE	WEIGHT	MICRON
A-SF110	Cross Filter Assy.	20 GPM	3/4" NPTF	2	10
A-1A9021	Hyd. Filter Only				
A-SF125	Cross Filter Assy.	20 GPM	3/4 NPTF	2	25
A-1051689M1	Hydraulic Filter Only				
A-SF210	Cross Filter Assy.	60 GPM	1 1/4 NPTF	6	10
A-1A9251	Hyd. Filter Only				
A-1A9253	Hyd. Filter Only				



Uses ISO/Pioneer style 4050-15P Female Coupler Body 3/4-16 ORB & 8010-15P Male Tip Thread Size 3/4-16 ORB Couplers

3 Circuit Hydraulic Multipliers

PART	DESCRIPTION
A-12369	Hyd. Multiplier, 3 Circuit w/ Command Control/Couplers, 12VDC
A-12370	Hyd. Multiplier, 3 Circuit w/ Switchbox / Couplers, 12VDC

Parts are not Original Equipment parts and are not sponsored, affiliated or otherwise connected with any major brand.

HYDRAULICS

Multipliers & Replacement Parts



Uses ISO/Pioneer style 4050-15P Female Coupler Body 3/4-16 ORB & 8010-15P Male Tip Thread Size 3/4-16 ORB Couplers

2 Circuit Hydraulic Multipliers

PART	DESCRIPTION	FLOW RATE
A-14789	Hyd. Multiplier, 2 Circuit w/ Command Control / Couplers, 12VDC	15 GPM @ 3000 PSI
A-14790	Hyd. Multiplier, 2 Circuit w/ Switchbox / Couplers, 12VDC	
A-14791	Hyd. Multiplier, 2 Circuit w/ Switchbox / JD Couplers, 12VDC	
A-18549	Hyd. Multiplier, 2 Circuit Command Control w/o Couplers, 12VDC	
A-18550	Hyd. Multiplier, 2 Circuit Switchbox w/o Couplers, 12VDC	



Command Control

PART	DESCRIPTION
A-306249	Command Control, Hydraulic 2 Circuit, Pushbutton
A-306294	Command Control, Hydraulic 3 Circuit, Pushbutton



Switchbox Control

PART	DESCRIPTION
A-306250	Switchbox Control, Hydraulic 2 Circuit
A-306295	Switchbox Control, Hydraulic 3 Circuit

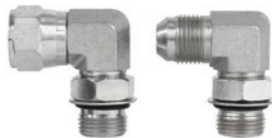

This kit allows hydraulic multipliers to be used on outlets with a center to center spacing of 1 1/4" to 8".

Multiplier Adapter Kit

PART	DESCRIPTION
A-14973	Adapter Kit, Hydraulic Multiplier

Parts are not Original Equipment parts and are not sponsored, affiliated or otherwise connected with any major brand.



Multipliers & Replacement Parts

PART	DESCRIPTION	FLOW RATE	PORT SIZE	OIL TEMP RANGE	POWER	RATED PRESSURE	SUPPLY VOLTAGE
A-VFD2500	6 Port Solenoid Diverter Valve 3/8" BSP	50 LPM	3/8"	68-158°F (20-70°C)	29W	210 Bar	12V
A-VFH1120	Switch & Handle Assy Supplied complete with relay and wiring diagram. M10 thread.						
A-VFD2501	6 Port Solenoid Diverter Valve 1/2" BSP	80 LPM	1/2"	68-158°F (20-70°C)	36 W	315 bar	12 V
A-VFH1120	Switch & Handle Assy Supplied complete with relay and wiring diagram. M10 thread.						



Solenoid Coils

PART	DESCRIPTION	INSIDE DIAMETER	OUTSIDE DIAMETER	TERMINALS	LENGTH
A-253012	Solenoid Coil, Hydraulic 12 VDC	0.647"	1.726"	Approx. 1/2" apart	2.015"
A-253026	Solenoid Coil, Hydraulic 24 VDC				



Cartridge Valve

PART	DESCRIPTION
A-273004	Cartridge Valve, Hydraulic

Seal Kits

PART	DESCRIPTION
A-274001	Seal Kit, Hydraulic (Included w/ Cartridge

Parts are not Original Equipment parts and are not sponsored, affiliated or otherwise connected with any major brand.

Chains/Sprockets/Pulleys/Hubs Contents

Chain Lube	75
EZ Chain Rack	81
Hubs	87-88
Idler Sprockets	84-86
Metric Roller Chains and Attachment Links	81-82
Pintle Chains	82
Pulleys	86
Roller Chains and Attachment Links	75-82
Roller Chain Breaker Tools	75
Round Baler Chains	82
Steel Detachable Chains	83-84
T-Rod/ T-Bar Chain	83
Upper Slat Chain	82

Click to go back to top 

CHAINS/SPROCKETS/PULLEYS/HUBS

Roller Chains & Attachment Links

CHAINS/SPROCKETS/PULLEYS/HUBS



Parts are not Original Equipment parts and are not sponsored, affiliated or otherwise connected with any major brand.

Chain Lube



PART	DESCRIPTION	Size	PKG QTY
A-CCL1112	Lube, Chain & Cable, Moly	11 oz Cans	min order qty 12

NOTE: Case Of 12 Cans, Priced Individually

Roller Chain Breaker Tools

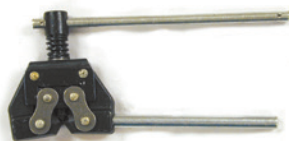

PART	DESCRIPTION	Size	PKG QTY
A-5A1	Roller Chain Breaker		

NOTE: For use on chain 25 thru 60

A-5A2	Roller Chain Breaker		
-------	----------------------	--	--

NOTE: For use on chain 60 thru 100

25 Roller Chains and Attachment Links

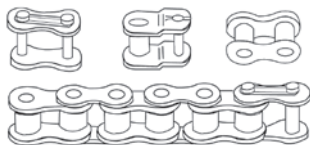

PART	DESCRIPTION	Links Per 10 Feet	Pitch Length	Width
A-OL25	25 Offset Link (USA)			

35 Roller Chains and Attachment Links

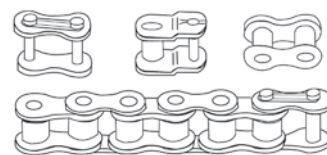

PART	DESCRIPTION	Links Per 10 Feet	Pitch Length	Width
A-RC35	35 Roller Chain, 10 ft (USA)	320	3/8"	3/16"
A-CL35	35 Connector Link (USA)			
A-OL35	35 Offset Link (USA)			
A-RL35	35 Roller Link (USA)		3/8"	
A-RC35IMP	35 Roller Chain, 10 ft (Import)	320	3/8"	3/16"
A-RC35X50IMP	35 Roller Chain, 50 ft (Import)		3/8"	3/16"
A-CL35IMP	35 Connector Link (Import)			
A-OL35IMP	35 Offset Link (Import)			

CHAINS/SPROCKETS/PULLEYS/HUBS

Roller Chains & Attachment Links

40 Roller Chains and Attachment Links



PART	DESCRIPTION	Links Per 10 Feet	Pitch Length	Width
A-RC40	40 Roller Chain, 10 ft (USA)	240	1/2"	5/16"
A-RC40X50	40 Roller Chain, 50 ft (USA)	240	1/2"	5/16"
A-CL40	40 Connector Link (USA)			
A-OL40	40 Offset Link (USA)			
A-RL40	40 Roller Link (USA)			
A-RC40IMP	40 Roller Chain, 10 ft (Import)	240	1/2"	5/16"
A-RC40X50IMP	40 Roller Chain, 50 ft (Import)	240	1/2"	5/16"
A-RC40X100IMP	40 Roller Chain, 100 ft (Import)	240	1/2"	5/16"
A-CL40IMP	40 Connector Link (Import)			
A-OL40IMP	40 Offset Link (Import)			

40 Double Roller Chains and Attachment Links

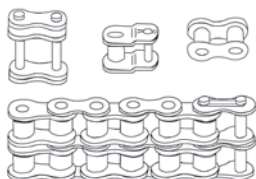

PART	DESCRIPTION	Links Per 10 Feet	Pitch Length	Width
A-CL40D	40 Double Connector Link (USA)			
A-OL40D	40 Double Offset Link (USA)			
A-RC40DIMP	40 Double Roller Chain, 10 ft (Import)	240	1/2"	5/16"
A-CL40DIMP	40 Double Connector Link (Import)			

41 Roller Chains and Attachment Links

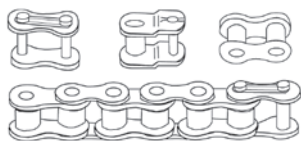

PART	DESCRIPTION	Links Per 10 Feet	Pitch Length	Width
A-RC41	41 Roller Chain, 10 ft (USA)	240	1/2"	1/4"
A-RC41X50	41 Roller Chain, 50 ft (USA)	240	1/2"	1/4"
A-CL41	41 Connector Link (USA)			

41 Roller Chains and Attachment Links

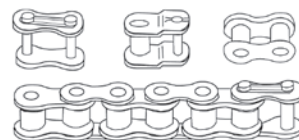

PART	DESCRIPTION	Links Per 10 Feet	Pitch Length	Width
A-OL41	41 Offset Link (USA)			
A-RC41IMP	41 Roller Chain, 10 ft (Import)	240	1/2"	1/4"
A-RC41X50IMP	41 Roller Chain, 50 ft (Import)	240	1/2"	1/4"
A-CL41IMP	41 Connecting Link (Import)			
A-OL41IMP	41 Offset Link (Import)			

50 Roller Chains and Attachment Links

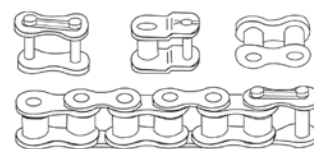

PART	DESCRIPTION	Links Per 10 Feet	Pitch Length	Width
A-RC50	50 Roller Chain, 10 ft (USA)	192	5/8"	3/8"
A-RC50X50	50 Roller Chain, 50 ft (USA)	192	5/8"	3/8"
A-CL50	50 Connector Link (USA)			
A-OL50	50 Offset Link (USA)			
A-RL50	50 Roller Link (USA)			
A-RC50IMP	50 Roller Chain, 10 ft (Import)	192	5/8"	3/8"
A-RC50X50IMP	50 Roller Chain, 50 ft (Import)	192	5/8"	3/8"
A-RC50X100IMP	50 Roller Chain, 100 ft (Import)	192	5/8"	3/8"
A-CL50IMP	50 Conn. Link (Import)			
A-OL50IMP	50 Offset Link (Import)			

50 Heavy Roller Chains and Attachment Links



PART	DESCRIPTION	Links Per 10 Feet	Pitch Length	Width
A-RC50HIMP	50 Heavy Roller Chain, 10 ft (Import)	192	5/8"	3/8"
A-CL50HIMP	50 Heavy Conn. Link (Import)			
A-OL50HIMP	50 Heavy Offset Link (Import)			

Parts are not Original Equipment parts and are not sponsored, affiliated or otherwise connected with any major brand.

50 Double Roller Chains and Attachment Links

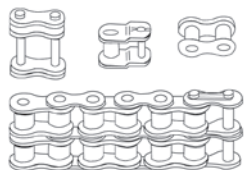

PART	DESCRIPTION	Links Per 10 Feet	Pitch Length	Width
A-RC50D	50 Double Roller Chain, 10 ft (USA)	192	5/8"	3/8"
A-RC50DX50	50 Double Roller Chain, 50 ft (USA)	192	5/8"	3/8"
A-RC50DX50IMP	50 Double Roller Chain, 50 ft (Import)	192	5/8"	3/8"
A-CL50D	50 Double Connector Link (USA)			
A-OL50D	50 Double Offset Link (USA)			
A-RC50DIMP	50 Double Roller Chain, 10 ft (Import)	192	5/8"	
A-CL50DIMP	50 Double Connector Link (Import)			
A-OL50DIMP	50 Double Offset Link (Import)			

60 Roller Chains and Attachment Links



PART	DESCRIPTION	Links Per 10 Feet	Pitch Length	Width
A-RC60	60 Roller Chain, 10 ft (USA)	160	3/4"	1/2"
A-RC60X50	60 Roller Chain, 50 ft (USA)	160	3/4"	1/2"
A-RC60X100	60 Roller Chain, 100 ft (USA)	160	3/4"	1/2"
A-CL60	60 Connector Link (USA)			
A-CL60HS	Connecting Link, 60H w/ Shepherd Hook Attachment			
A-OL60	60 Offset Link (USA)			
A-RL60	60 Roller Link (USA)			
A-RC60IMP	60 Roller Chain, 10 ft (Import)	160	3/4"	1/2"
A-RC60X50IMP	60 Roller Chain, 50 ft (Import)	160	3/4"	1/2"
A-RC60X100IMP	60 Roller Chain, 100 ft (Import)	160	3/4"	1/2"
A-CL60IMP	60 Conn. Link (Import)			
A-OL60IMP	60 Offset Link (Import)			

60 Heavy Roller Chains and Attachment Links

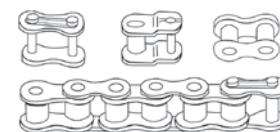

PART	DESCRIPTION	Links Per 10 Feet	Pitch Length	Width
A-RC60H	60 Heavy Roller Chain, 10 ft (USA)	160	3/4"	1/2"
A-RC60HX50	60 Heavy Roller Chain, 50 ft (USA)	160	3/4"	1/2"
A-CL60H	Link, Chain (USA)			
A-OL60H	Link, 60 Heavy Offset (USA)			
A-RL60H	60 Heavy Roller Link (USA)			
A-RC60HIMP	60 Heavy Roller Chain, 10 ft (Import)	160	3/4"	1/2"
A-RC60HX50IMP	60 Heavy Roller Chain, 50 ft (Import)	160	3/4"	1/2"
A-CL60HIMP	60 Heavy Conn. Link (Import)			
A-OL60HIMP	60 Heavy Offset Link (Import)			

60 Double Roller Chains and Attachment Links

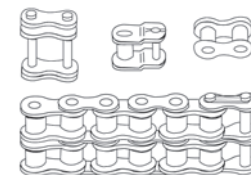

PART	DESCRIPTION	Links Per 10 Feet	Pitch Length	Width
A-RC60D	60 Double Roller Chain, 10 ft (USA)	160	3/4"	1/2"
A-CL60D	60 Double Connector Link (USA)			
A-OL60D	60 Double Offset Link (USA)			
A-RC60DIMP	60 Double Roller Chain, 10 ft (Import)	160	3/4"	1/2"
A-RC60DX50IMP	60 Double Roller Chain, 50 ft (Import)	160	3/4"	1/2"
A-CL60DIMP	60 Double Connector Link (Import)			
A-OL60DIMP	60 Double Offset Link (Import)			

Parts are not Original Equipment parts and are not sponsored, affiliated or otherwise connected with any major brand.

CHAINS/SPROCKETS/PULLEYS/HUBS

CHAINS/SPROCKETS/PULLEYS/HUBS

Roller Chains & Attachment Links

80 Roller Chains and Attachment Links



PART	DESCRIPTION	Links Per 10 Feet	Pitch Length	Width
A-RC80	80 Roller Chain, 10 ft (USA)	120	1"	5/8"
A-RC80X50	80 Roller Chain, 50 ft (USA)	120	1"	5/8"
A-CL80	80 Connector Link (USA)			
A-OL80	80 Offset Link (USA)			
A-RL80	80 Roller Link (USA)			
A-RC80IMP	80 Roller Chain, 10 ft (Import)	120	1"	5/8"
A-RC80X50IMP	80 Roller Chain, 50 ft (Import)	120	1"	5/8"
A-CL80IMP	80 Conn. Link (Import)			
A-OL80IMP	80 Offset Link (Import)			

80 Heavy Roller Chains and Attachment Links

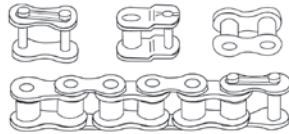

PART	DESCRIPTION	Links Per 10 Feet	Pitch Length	Width
A-RC80H	80 Heavy Roller Chain, 10 ft (USA)	120	1"	5/8"
A-RC80HX50	80 Hvy Roller Chain, 50 ft (USA)	120	1"	5/8"
A-RC80HX50IMP	80 Heavy Roller Chain, 50 ft (Import)	120	1"	5/8"
A-CL80H	80 Hvy Connector Link (USA)			
A-OL80H	80 Hvy Offset Link (USA)			
A-RC80HIMP	80 Hvy Roller Chain, 10 ft (Import)	120	1"	5/8"
A-CL80HIMP	80 Hvy Conn. Link (Import)			
A-OL80HIMP	80 Hvy Offset Link (Import)			

80 Double Roller Chains and Attachment Links

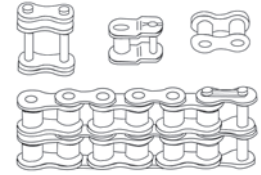

PART	DESCRIPTION	Links Per 10 Feet	Pitch Length	Width
A-RC80D	80 Double Roller Chain, 10 ft (USA)	120	1"	5/8"
A-CL80D	80 Double Connector Link (USA)			
A-CL80HS	Connecting Link, 80H w/ Shepherd Hook Attachment			
A-CL80S	Connecting Link, 80 w/ Shepherd Hook Attachment			
A-OL80D	80 Double Offset Link (USA)			
A-RC80DIMP	80 Double Roller Chain, 10 ft (Import)	120	1"	5/8"
A-CL80DIMP	80 Double Connector Link (Import)			
A-OL80DIMP	80 Double Offset Link (Import)			

100 Roller Chains and Attachment Links

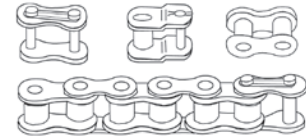

PART	DESCRIPTION	Links Per 10 Feet	Pitch Length	Width
A-RC100	100 Roller Chain, 10 ft (USA)	96	1-1/4"	3/4"
A-CL100	100 Connector Link (USA)			
A-OL100	100 Offset Link (USA)			
A-RL100	100 Roller Link (USA)			
A-RC100IMP	100 Roller Chain, 10 ft (Import)	96	1-1/4"	3/4"
A-RC100X50IMP	100 Roller Chain, 50 ft (Import)	96	1-1/4"	3/4"
A-CL100IMP	100 Connector Link (Import)			
A-OL100IMP	100 Offset Link (Import)			

Parts are not Original Equipment parts and are not sponsored, affiliated or otherwise connected with any major brand.

100 Heavy Roller Chains and Attachment Links

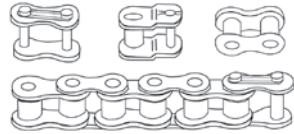

PART	DESCRIPTION	Links Per 10 Feet	Pitch Length	Width
A-RC100H	100 Heavy Roller Chain, 10 ft (USA)	96	1-1/4"	3/4"
A-CL100H	100 Hvy Connector Link (USA)			
A-OL100H	100 Hvy Offset Link (USA)			
A-RC100HIMP	100 Heavy Roller Chain/Ft (Import)	96	1-1/4"	3/4"

120 Roller Chains and Attachment Links

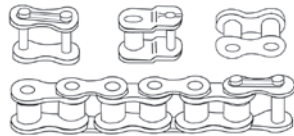

PART	DESCRIPTION	Pitch Length	Width
A-RC120	120 Roller Chain, 10 ft (USA)	1-1/2"	1"
A-CL120	120 Connector Link (USA)		
A-OL120	120 Offset Link (USA)		

120 Heavy Roller Chains and Attachment Links



PART	DESCRIPTION	Pitch Length	Width
A-RC120H	120 Heavy Roller Chain, 10 Ft.	1-1/2"	1"
A-CL120H	120H Connecting Link, USA		

140 Heavy Roller Chains and Attachment Links



PART	DESCRIPTION
A-RC140H	140 Heavy Roller Chain, 10 Ft.
A-CL140H	120H Connecting Link, USA
A-OL140H	140H Offset Link, USA

160 Heavy Roller Chain and Attachment Links

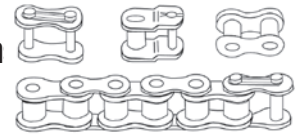

PART	DESCRIPTION	Pitch Length	Width
A-RC160H	160 Heavy Roller Chain, 10 ft (USA)	2"	1-1/4"
A-CL160	160 Connector Link (USA)		
A-CL160H	160 Connecting Link, USA		
A-OL160	160 Offset Link (USA)		

2040 Extended Pitch Roller Chains and Attachment Links

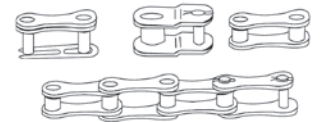

PART	DESCRIPTION	Links Per 10 Feet	Pitch Length	Width
A-RC2040	2040 Extended Pitch Roller Chain, 10 ft (USA)	120	1"	5/16"
A-RC2040X50	2040 Extended Pitch Roller Chain, 50 ft (USA)	120	1"	5/16"
A-CL2040	2040 Extended Pitch Connector Link (USA)			
A-OL2040	2040 Extended Pitch Offset Link (USA)			
A-RC2040IMP	2040 Extended Pitch Roller Chain, 10 ft (Import)	120	1"	5/16"
A-RC2040X50IMP	2040 Extended Pitch Roller Chain, 50 ft (Import)	120	1"	5/16"
A-CL2040IMP	2040 Extended Pitch Conn. Link (Import)			
A-OL2040IMP	2040 Extended Pitch Offset Link (Import)			

Parts are not Original Equipment parts and are not sponsored, affiliated or otherwise connected with any major brand.

CHAINS/SPROCKETS/PULLEYS/HUBS

Roller Chains & Attachment Links

CHAINS / SPROCKETS / PULLEYS / HUBS

2050 Extended Pitch Roller Chains and Attachment Links

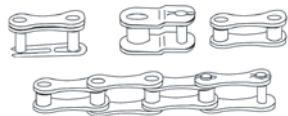

PART	DESCRIPTION	Links Per 10 Feet	Pitch Length	Width
A-RC2050	2050 Extended Pitch Roller Chain, 10 ft (USA)	96	1-1/4"	3/8"
A-RC2050X50	2050 Extended Pitch Roller Chain, 50 ft (USA)	96	1-1/4"	3/8"
A-CL2050	2050 Extended Pitch Connector Link (USA)			
A-OL2050	2050 Extended Pitch Offset Link (USA)			
A-RL2050	2050 Extended Pitch Roller Link (USA)			
A-RC2050IMP	2050 Extended Pitch Roller Chain, 10 ft (Import)	96	1-1/4"	3/8"
A-RC2050X50IMP	2050 Extended Pitch Roller Chain, 50 ft (Import)	96	1-1/4"	3/8"
A-CL2050IMP	2050 Extended Pitch Conn. Link (Import)			
A-OL2050IMP	2050 Extended Pitch Offset Link (Import)			

2060 Extended Pitch Roller Chains and Attachment Links

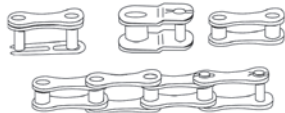

PART	DESCRIPTION	Links Per 10 Feet	Pitch Length	Width
A-RC2060	2060 Extended Pitch Roller Chain, 10ft (USA)	80	1-1/2"	1/2"
A-CL2060	2060 Extended Pitch Connector Link (USA)			
A-OL2060	2060 Extended Pitch Offset Link (USA)			
A-RC2060IMP	2060 Extended Pitch Roller Chain, 10 ft (Import)	80	1-1/2"	1/2"
A-RC2060X50IMP	2060 Extended Pitch Roller Chain, 50 ft (Import)	80	1-1/2"	1/2"
A-CL2060IMP	2060 Extended Pitch Conn. Link (Import)			
A-OL2060IMP	2060 Extended Pitch Offset Link (Import)			

A550 Roller Chains and Attachment Links



PART	DESCRIPTION
A-A550C	A550-C Connector Link
A-A550O	A550-O Offset Link

A620 Roller Chains and Attachment Links

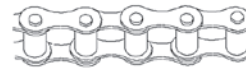

PART	DESCRIPTION
A-A620O	A620-O Offset Link

CA550 Roller Chains and Attachment Links



PART	DESCRIPTION	Pitch	Width
A-CA550	CA550 Conveyor Series Chain, 10 ft	1.630"	.797"
A-CA550C	Chain Repair Link, Connector, CA550		
A-CA550R	CA550-R Roller Link		
A-CA550O	CA550-O Offset Link		

CA550 Roller Chains and Attachment Links



PART	DESCRIPTION
A-CA555C	CA555-C Connector Link
A-CA555R	CA555-R Roller Link
A-CA555O	CA555-O Offset Link

CA557 Roller Chains and Attachment Links

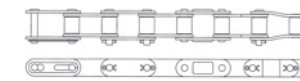

PART	DESCRIPTION
A-CA557C	Chain Repair Link, Connector, CA557
A-CA557R	CA557-R Roller Link
A-CA557O	CA557-O Offset Link
A-CA557CWN	Chain Repair Link, Connector, CA557 with Cap Nuts

Parts are not Original Equipment parts and are not sponsored, affiliated or otherwise connected with any major brand.

CA620 Roller Chains and Attachment Links

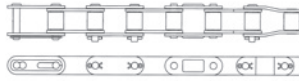

PART	DESCRIPTION	Pitch
A-CA620	CA620 Conveyor Series Chain, 10 ft	1.654"
A-CA620C	CA620-C Connector Link	
A-CA620R	CA620-R Roller Link	
A-CA620O	CA620-O Offset Link	

EZ Chain Rack



PART	DESCRIPTION
A-57480	EZ Chain Rack

NOTE: Makes storing and cutting roller chain easy using the versatile EZ Chain Rack.

Prevents chain from uncoiling with individual clutches on each station.

Holds up to two 50 ft. reels on each of its four stations.

Allows easy switching between chain sizes.

35 Metric Roller Chains and Attachment Links



PART	DESCRIPTION	Length	Pitch	Width
A-RC35M	Metric Roller Chain	16'	9.525 MM	5.72 MM
A-CL35M	Metric Connecting Link w/ Spring Clip		9.525 MM	5.72 MM
A-OL35M	Metric Offset Link w/ Cotter Pin		9.525 MM	5.72 MM

35 Metric Double Roller Chains and Attachment Links



PART	DESCRIPTION	Length
A-RC35MD	35 Metric Double Roller Chain, 10' roll	10'
A-CL35MD	35 Metric Double Connector Link	

40 Metric Roller Chains and Attachment Links



PART	DESCRIPTION	Length	Pitch	Width
A-RC40M	Metric Roller Chain	16'	12.7 MM	7.75 MM
A-CL40M	Metric Connecting Link w/ Spring Clip		12.7 MM	7.75 MM
A-OL40M	Metric Offset Link w/ Cotter Pin		12.7 MM	7.75 MM

50 Metric Roller Chains and Attachment Links



PART	DESCRIPTION	Length	Pitch	Width
A-RC50M	Metric Roller Chain	16'	15.875 MM	9.65 MM
A-CL50M	Metric Connecting Link w/ Spring Clip		15.875 MM	9.65 MM
A-OL50M	Metric Offset Link w/ Cotter Pin		15.875 MM	9.65 MM

60 Metric Roller Chains and Attachment Links



PART	DESCRIPTION	Length	Pitch	Width
A-RC60M	Metric Roller Chain	16'	19.05 MM	11.68 MM
A-CL60M	Metric Connecting Link w/ Spring Clip		19.05 MM	11.68 MM
A-OL60M	Metric Offset Link w/ Cotter Pin		19.05 MM	11.68 MM

80 Metric Roller Chains and Attachment Links



PART	DESCRIPTION	Length	Pitch	Width
A-RC80M	Metric Roller Chain	16'	25.4 MM	17.02 MM
A-CL80M	Metric Connecting Link w/ Spring Clip		25.4 MM	17.02 MM
A-OL80M	Metric Offset Link w/ Cotter Pin		25.4 MM	17.02 MM

100 Metric Roller Chains and Attachment Links



PART	DESCRIPTION	Length	Pitch	Width
A-RC100M	Metric Roller Chain	16'	31.75 MM	19.56 MM
A-CL100M	Metric Connecting Link w/ Spring Clip		31.75 MM	19.56 MM
A-OL100M	Metric Offset Link w/ Cotter Pin		31.75 MM	19.56 MM

Parts are not Original Equipment parts and are not sponsored, affiliated or otherwise connected with any major brand.

CHAINS/SPROCKETS/PULLEYS/HUBS

Roller Chains & Attachment Links

120 Metric Roller Chains and Attachment Links



PART	DESCRIPTION	Length	Pitch	Width
A-RC120M	Metric Roller Chain	16'	38.1 MM	25.4 MM
A-CL120M	Metric Connecting Link w/ Spring Clip		38.1 MM	25.4 MM
A-OL120M	Metric Offset Link w/ Cotter Pin		38.1 MM	25.4 MM

Pintle Chains

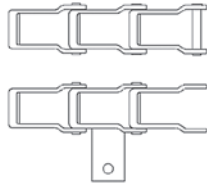

PART	DESCRIPTION			
A-AL662	AL662 Pintle Chain, 10 ft			
A-AL662CO	AL662-CO Connector Link			
A-AL667H	AL667H Pintle Chain, 10 ft			
A-AL667HCO	AL667H-CO Connector Link	1.5" ID wide end	1.125" ID narrow end	2.313" pitch
A-AL667HASCO	AL667H-AS-CO Attaching Link			
A-AL667X	AL667X Pintle Chain, 10 ft			
A-AL667XCO	AL667X-CO Connector Link	1.5" ID wide end	1.125" ID narrow end	2.313" pitch
A-AL667XASCO	AL667X-AS-CO Attaching Link			

Round Baler Chains



PART	DESCRIPTION	Fits	Attachment Links	Links
A-268766	Round Baler Lower Floor Chain	for New Holland models, 845	17	71
A-714619	Round Baler Lower Floor Chain	for New Holland models, 846, 847	15	61
A-710395	Round Baler Lower Floor Chain	for New Holland models, 850	19	78
A-718096	Round Baler Lower Floor Chain	for New Holland models, 851, 852	16	65

CA557 Upper Slat Chain

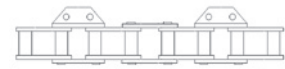

PART	DESCRIPTION	Fits	Attachment Links	Links
A-704545	Upper Slat Chain, CA557; Set of 2	for New Holland models, 845	60	180
A-634335	Upper Slat Chain Set, CA550	for New Holland models, 846, 847	64	192
A-795027	Upper Slat Chain (Set of 2), CA557	for New Holland models, 848 S/N <714628	76	228
A-855594	Upper Slat Chain (Set of 2), CA557	for New Holland models, 848 S/N 714629>	57	228
A-679768	Upper Slat Chain, CA557, Matched Set of 2	for New Holland models, 851, 852	78	234
A-850096	Upper Slat Chain, CA557 (Set of 2)	for New Holland models, 853	62	248

Round Baler Chains Repair Sections



PART	DESCRIPTION	Fits
A-262268	Repair Section	for New Holland models, 845, 846, 847 for chains: 268766, 714619
A-702378	Repair Section	for New Holland models, 850, 851, 852 for chains: 710395, 718096



A-634340	Chain Repair Kit CA550	for New Holland models for chains: 704545, 634335, 273260, 679768, 795027
A-639219	Repair Section, CA557	for New Holland models for chains: 704545, 273260, 679768, 795027

Parts are not Original Equipment parts and are not sponsored, affiliated or otherwise connected with any major brand.

CHAINS/SPROCKETS/PULLEYS/HUBS

Roller Chains & Attachment Links - Steel Detachable Chains

Steel Detachable Chains



PART	DESCRIPTION
A-AL67R	67 T-Rod Chain, 1 Link

The unique design of T-Rod Chain Links allows removing or adding links without tools. Just turn the link 45 degrees and with a slight twist a link can be disengaged.

T-Rod/ T-Bar Chain



PART	DESCRIPTION	Overall Length
A-AL67T	T-Bar Chain	3.375"
A-AL67TASR	T-Bar Link	5/16" Rivet Hole
A-AL67TASL	T-Bar Link	5/16" Rivet Hole
A-AL67TA2R	T-Bar Link	7/16" Rivet Hole
A-AL67TASL	T-Bar Link	5/16" Rivet Hole
A-AL67TASR	T-Bar Link	5/16" Rivet Hole
A-AL67TA2R	T-Bar Link	7/16" Rivet Hole

Steel Detachable Chains

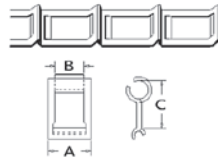

PART	DESCRIPTION	Dim A	Dim B	Dim C
A-25	25 Steel Detachable Chain (10 ft)	45/64	27/64	29/32
A-32	32 Steel Detachable Chain (10 ft)	15/16	19/32	1-5/32
A-32W	32W Steel Detachable Chain (10 ft)	1-1/16	19/32	1-5/32
A-33	33 Steel Detachable Chain (10 ft)	1-1/16	11/16	1-13/32
A-42	42 Steel Detachable Chain (10 ft)	1-7/32	25/32	1-3/8
A-50H	50H Steel Detachable Chain (10 ft)	1-9/32	25/32	1-3/8
A-51	51 Steel Detachable Chain (10 ft)	1-3/32	45/64	1-5/32
A-52	52 Steel Detachable Chain (10 ft)	1-13/32	27/32	1-1/2
A-55	55 Steel Detachable Chain; 10 ft, (USA)	1-9/32	51/64	1-5/8
A-62	62 Steel Detachable Chain (10 ft)	1-9/16	63/64	1-21/32
A-62A	62A Steel Detachable Chain (10 ft)	1-15/16	63/64	1-43/64
A-62H	62H Steel Detachable Chain (10 ft)	1-7/8	63/64	1-21/32
A-67H	67H Steel Detachable Chain (10 ft)	1-7/8	1-3/32	2-5/16
A-67XH	67XH Steel Detachable Chain (10 ft)	1-7/8	1-3/32	2-5/16
A-70	70 Steel Detachable Chain (10 ft)	1-15/16	1-3/32	2-1/64
A-7212A	71-1/2 Steel Detachable Chain (10 ft)	2	1-5/32	1-41/64

Steel Detachable Chains

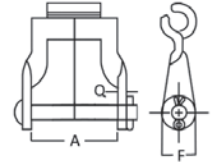

PART	DESCRIPTION	Dim A	Dim F	Dim Q
A-55CO	55CO Attachment Link	1-3/8	5/8	.125
A-62CO	62CO Attachment Link	1-39/64	5/8	.148

Steel Detachable Chains

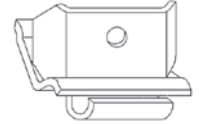

PART	DESCRIPTION
A-55C1	55C1 Attachment Link
A-62C1	62C1 Attachment Link

Steel Detachable Chains

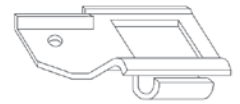

PART	DESCRIPTION
A-55A2L	55A2L Attachment Link
A-55A2R	55A2R Attachment Link

Steel Detachable Chains

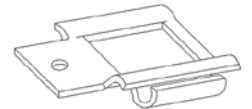

PART	DESCRIPTION
A-55A1L	55A1L Attachment Link
A-55A1R	55A1R Attachment Link

Steel Detachable Chains

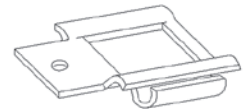

PART	DESCRIPTION
A-62A1L	62A1L Attachment Link
A-62A1R	62A1R Attachment Link

Steel Detachable Chains



PART	DESCRIPTION
A-55SH	55SH Attachment Link

Parts are not Original Equipment parts and are not sponsored, affiliated or otherwise connected with any major brand.

CHAINS/SPROCKETS/PULLEYS/HUBS

CHAINS/SPROCKETS/PULLEYS/HUBS

Steel Detachable Chains - Sprockets

CHAINS / SPROCKETS / PULLEYS / HUBS

Steel Detachable Chains

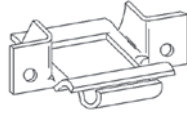

PART	DESCRIPTION
A-55SD	55SD Attachment Link
A-62SD	62SD Attachment Link

Steel Detachable Chains



PART	DESCRIPTION
A-55G27L	55G27L Attachment Link
A-55G27R	55G27R Attachment Link
A-62G27L	62G27L Attachment Link
A-62G27R	62G27R Attachment Link

Steel Detachable Chains

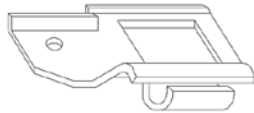

PART	DESCRIPTION
A-67HASL	67HASL Attachment Link
A-67HASR	67HASR Attachment Link
A-67XHASL	67XHASL Attachment Link
A-67XHASR	67XHASR Attachment Link

Sprockets



PART	Inside Diameter	Outside Diameter	Teeth	Hub Required
A-40V11	1 1/8"	2.004"	11	V
A-40V12	1 1/8"	2.166"	12	V
A-40V13	1 1/8"	2.329"	13	V
A-40V14	1 1/8"	2.491"	14	V
A-40V15	1 1/8"	2.653"	15	V
A-40W16	1 5/8"	2.814"	16	W
A-40W17	1 5/8"	2.975"	17	W
A-40W18	1 5/8"	3.136"	18	W
A-40W19	1 5/8"	3.297"	19	W
A-40X20	2"	3.457"	20	X
A-40X21	2"	3.618"	21	X
A-40X22	2"	3.778"	22	X
A-40X23	2"	3.938"	23	X
A-40X24	2"	4.098"	24	X
A-40X25	2"	4.258"	25	X
A-40X26	2"	4.418"	26	X
A-40X27	2"	4.578"	27	X
A-40X28	2"	4.738"	28	X
A-40X29	2"	4.898"	29	X
A-40X30	2"	5.057"	30	X
A-40X32	2"	5.377"	32	X
A-40X35	2"	5.856"	35	X
A-40X36	2"	6.015"	36	X
A-40X38	2"	6.334"	38	X
A-40X40	2"	6.653"	40	X
A-40X42	2"	6.972"	42	X
A-40X45	2"	7.451"	45	X
A-40X48	2"	7.927"	48	X
A-40X50	2"	8.25"	50	X
A-40X54	2"	8.885"	54	X
A-40X60	2"	9.841"	60	X
A-40X72	2"	11.752"	72	X
A-50V09	1 1/8"	2.092"	9	V
A-50V10	1 1/8"	2.299"	10	V
A-50V11	1 1/8"	2.504"	11	V

Parts are not Original Equipment parts and are not sponsored, affiliated or otherwise connected with any major brand.

Sprockets

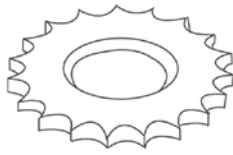

Sprockets

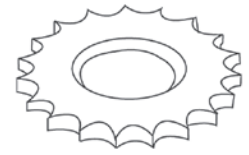

Parts are not Original Equipment parts and are not sponsored, affiliated or otherwise connected with any major brand.

PART	Inside Diameter	Outside Diameter	Teeth	Hub Required
A-50W12	1 5/8"	2.708"	12	W
A-50W13	1 5/8"	2.911"	13	W
A-50W14	1 5/8"	3.114"	14	W
A-50W15	1 5/8"	3.316"	15	W
A-50W16	1 5/8"	3.517"	16	W
A-50X17	2"	3.719"	17	X
A-50X18	2"	3.919"	18	X
A-50X19	2"	4.121"	19	X
A-50X20	2"	4.321"	20	X
A-50X21	2"	4.521"	21	X
A-50X22	2"	4.722"	22	X
A-50X23	2"	4.922"	23	X
A-50X24	2"	5.123"	24	X
A-50X25	2"	5.323"	25	X
A-50X26	2"	5.523"	26	X
A-50X27	2"	5.723"	27	X
A-50X28	2"	5.922"	28	X
A-50X29	2"	6.122"	29	X
A-50X30	2"	6.321"	30	X
A-50X31	2"	6.521"	31	X
A-50X32	2"	6.721"	32	X
A-50X33	2"	6.92"	33	X
A-50X34	2"	7.12"	34	X
A-50X35	2"	7.319"	35	X
A-50X36	2"	7.519"	36	X
A-50X37	2"	7.718"	37	X
A-50X38	2"	7.918"	38	X
A-50X39	2"	8.117"	39	X
A-50X40	2"	8.316"	40	X
A-50X41	2"	8.715"	41	X
A-50X42	2"	8.715"	42	X
A-50X43	2"	8.914"	43	X
A-50X44	2"	9.114"	44	X
A-50X45	2"	9.313"	45	X
A-50X48	2"	9.911"	48	X
A-50X50	2"	10.309"	50	X
A-50X54	2"	11.106"	54	X
A-50X60	2"	12.306"	60	X

PART	Inside Diameter	Outside Diameter	Teeth	Hub Required
A-60V09	1 1/8"	2.51"	9	V
A-60V10	1 1/8"	2.759"	10	V
A-60W11	1 5/8"	3.005"	11	W
A-60W12	1 5/8"	3.249"	12	W
A-60W13	1 5/8"	3.493"	13	W
A-60W14	1 5/8"	3.736"	14	W
A-60X15	2"	3.979"	15	X
A-60X16	2"	4.22"	16	X
A-60X17	2"	4.463"	17	X
A-60X18	2"	4.703"	18	X
A-60X19	2"	4.945"	19	X
A-60X20	2"	5.186"	20	X
A-60X21	2"	5.426"	21	X
A-60X22	2"	5.666"	22	X
A-60X23	2"	5.906"	23	X
A-60X24	2"	6.147"	24	X
A-60X25	2"	6.387"	25	X
A-60X26	2"	6.627"	26	X
A-60X27	2"	6.867"	27	X
A-60X28	2"	7.106"	28	X
A-60X29	2"	7.346"	29	X
A-60X30	2"	7.586"	30	X
A-60X31	2"	7.826"	31	X
A-60X32	2"	8.065"	32	X
A-60X33	2"	8.304"	33	X
A-60X34	2"	8.544"	34	X
A-60X35	2"	8.783"	35	X
A-60X36	2"	9.023"	36	X
A-60X38	2"	9.501"	38	X
A-60X39	2"	9.501"	39	X
A-60X40	2"	9.98"	40	X
A-60X42	2"	10.458"	42	X
A-60X45	2"	11.176"	45	X
A-60X48	2"	11.893"	48	X
A-60X50	2"	12.371"	50	X
A-60X54	2"	13.327"	54	X
A-60X60	2"	14.761"	60	X

CHAINS/SPROCKETS/PULLEYS/HUBS

Sprockets - Pulleys

CHAINS / SPROCKETS / PULLEYS / HUBS

Sprockets

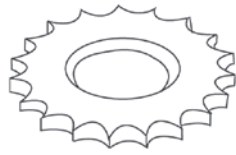

PART	Inside Diameter	Outside Diameter	Teeth	Hub Required
A-80W09	1 5/8"	3.347"	9	W
A-80W10	1 5/8"	3.678"	10	W
A-80W11	1 5/8"	4"	11	W
A-80X12	2.000"	4.332"	12	X
A-80X13	2"	4.657"	13	X
A-80X14	2.000"	4.982"	14	X
A-80X15	2"	5.305"	15	X
A-80X16	2"	5.627"	16	X
A-80X17	2"	5.95"	17	X
A-80X18	2"	6.271"	18	X
A-80X19	2"	6.593"	19	X
A-80X20	2"	6.914"	20	X
A-80X21	2"	7.235"	21	X
A-80X22	2"	7.555"	22	X
A-80X23	2"	7.875"	23	X
A-80X24	2"	8.196"	24	X
A-80X25	2"	8.516"	25	X
A-80X26	2"	8.836"	26	X
A-80X27	2"	9.156"	27	X
A-80X30	2"	10.114"	30	X
A-80X32	2"	10.753"	32	X
A-80X36	2"	12.03"	36	X
A-80X45	2"	14.901"	45	X

Idler Sprockets



PART	Chain Size	Teeth	Bore
A-IS401858	40	18	5/8" Bearing
A-IS401712	40	17	1/2" Bearing
A-IS501712	50	17	1/2" Bearing
A-IS501758	50	17	5/8" Bearing
A-IS601512	60	15	1/2" Bearing
A-IS601558	60	15	5/8" Bearing

Pulleys



Note: These pulleys can be used with either A or B width belts due to its dual groove / taper configuration.

PART	Outside Diameter	Hub Required
A-PLV2-12	2.5"	V
A-PLV3	3"	V
A-PLW3-12	3.5"	W
A-PLW4	4"	W
A-PLW4-12	4.5"	W
A-PLW5	5"	W
A-PLW5-12	5.5"	W
A-PLW6	6"	W
A-PLW6-12	6.5"	W
A-PLW7	7"	W
A-PLW8	8"	W
A-PLW9	9"	W
A-PLW10	10"	W
A-PLW11	11"	W
A-PLW12	12"	W
A-PLW14	14"	W
A-PLW16	16"	W

Parts are not Original Equipment parts and are not sponsored, affiliated or otherwise connected with any major brand.

Hubs

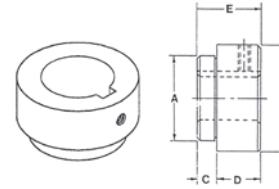

Parts are not Original Equipment parts and are not sponsored, affiliated or otherwise connected with any major brand.

PART	DESCRIPTION	Bore	Dim A	Dim B	Dim C	Dim D	Keyway
A-RBV12	V Hub	1/2" round	1-1/8"	1-7/16"	7/16"	3/4"	1/8" X 1/16"
A-RBV916	V Hub	9/16" round	1-1/8"	1-7/16"	7/16"	3/4"	1/8" X 1/16"
A-RBV58	V Hub	5/8" round	1-1/8"	1-7/16"	7/16"	3/4"	3/16" X 3-3/32"
A-RBV34	V Hub	3/4"	1-1/8"	1-7/16"	7/16"	3/4"	3/16" x 3-3/32"
A-RBV78	V Hub	7/8"	1-1/8"	1-7/16"	7/16"	3/4"	3/16" x 3-3/32"
A-RBV1316	V Hub	13/16" round	1-1/8"	1-7/16"	7/16"	3/4"	3/16" X 3-3/32"
A-RBW12	W Hub	1/2" round	1-5/8"	1-13/16"	7/16"	1"	1/8" X 1/16"
A-RBW916	W Hub	9/16" round	1-5/8"	1-13/16"	7/16"	1"	1/8" X 1/16"
A-RBW58	W Hub	5/8" round	1-5/8"	1-13/16"	7/16"	1"	3/16" X 3-3/32"
A-RBW1116	W Hub	11/16" round	1-5/8"	1-13/16"	7/16"	1"	3/16" X 3-3/32"
A-RBW34	W Hub	3/4" round	1-5/8"	1-13/16"	7/16"	1"	3/16" X 3-3/32"
A-RBW1316	W Hub	13/16 round	1-5/8"	1-13/16"	7/16"	1"	3/16" X 3-3/32"
A-RBW78	W Hub	7/8" round	1-5/8"	1-13/16"	7/16"	1"	3/16" X 3-3/32"
A-RBW1516	W Hub	15/16" round	1-5/8"	1-13/16"	7/16"	1"	1/4" X 1/8"
A-RBW1	W Hub	1" round	1-5/8"	1-13/16"	7/16"	1"	1/4" X 1/8"
A-RBW1-116	W Hub	1-1/16" round	1-5/8"	1-13/16"	7/16"	1"	1/4" X 1/8"
A-RBW1-18	W Hub	1-1/8"	1-5/8"	1-13/16"	7/16"	1"	1/4" x 1-1/4"
A-RBW1-316	W Hub	1-3/16" round	1-5/8"	1-13/16"	7/16"	1"	1/4" X 1/8"
A-RBW1-14	W Hub	1-1/4" round	1-5/8"	1-13/16"	7/16"	1"	1/4" X 1/8"
A-SBW1-38X6	W Hub	1 3/8" 6 Spline					
A-SBW1-18X6	W Hub	1 1/8" 6 Spline					
A-RBX58	X Hub	5/8" round	2"	2-1/2"	7/16"	1"	3/16" X 3-3/32"
A-RBX34	X Hub	3/4" round	2"	2-1/2"	7/16"	1"	3/16" X 3-3/32"
A-RBX1116	X Hub	11/16"	2"	2-1/2"	7/16"	1"	1/4" x 1/8"
A-RBX1316	X Hub	13/16" round	2"	2-1/2"	7/16"	1"	3/16" X 3-3/32"
A-RBX78	X Hub	7/8" round	2"	2-1/2"	7/16"	1"	3/16" X 3-3/32"
A-RBX1516	X Hub	15/16" round	2"	2-1/2"	7/16"	1"	1/4" X 1/8"
A-RBX1	X Hub	1" round	2"	2-1/2"	7/16"	1"	1/4" X 1/8"
A-RBX1-116	X Hub	1-1/16" round	2"	2-1/2"	7/16"	1"	1/4" X 1/8"
A-RBX1-18	X Hub	1-1/8" round	2"	2-1/2"	7/16"	1"	1/4" X 1/8"
A-RBX1-316	X Hub	1-3/16" round	2"	2-1/2"	7/16"	1"	1/4" X 1/8"
A-RBX1-14	X Hub	1-1/4" round	2"	2-1/2"	7/16"	1"	1/4" X 1/8"
A-RBX1-516	X Hub	1-5/16" round	2"	2-1/2"	7/16"	1"	5/16" X 5/32"
A-RBX1-38	X Hub	1-3/8" round	2"	2-1/2"	7/16"	1"	5/16" X 5/32"
A-RBX1-716	X Hub	1-7/16" round	2"	2-1/2"	7/16"	1"	3x8" X 3/16"
A-RBX1-12	X Hub	1-1/2" round	2"	2-1/2"	7/16"	1"	3X8" X 3/16"
A-SQW1	X Hub	1" square	1.625"	1.8125"	1.4375"		
A-SQX1	X Hub	1" square	2.000"	2.500"	1.4375"		
A-SQX1-14	X Hub	1-1/4" square					

Hubs

Hubs

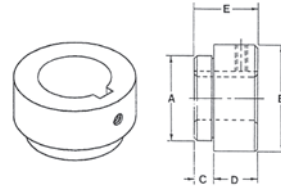

PART	DESCRIPTION	Bore	Dim A	Dim B	Dim C	Dim D	Keyway
A-SBX1-18X6	X Hub	1-1/8" 6 spline					
A-SBX1-38X6	X Hub	1-3/8" 6 spline					
A-SBX1-38X21	X Hub	1-3/8" 21 spline					
A-IHW58	W Hub, Idler Hub	5/8"					
A-IHX58	X Hub, Idler Hub	5/8"					

Hubs



PART	DESCRIPTION	Inside Diameter	Outside Diameter	Width	Hub
A-CH1582	Coupler Hub, W Series	1.625"	2.00"	1.00"	W Series
A-CH2212	Coupler Hub, X Series	2.000"	2.500"	1.00"	X Series

Parts are not Original Equipment parts and are not sponsored, affiliated or otherwise connected with any major brand.

Ignition & Electrical Contents

Battery Bolts & Nuts	91
Battery Cables & Terminals	90
Battery Terminals & Ground Straps	91-92
Booster Cables & Crimping Tools	92
Electrical Wire.	95-96
Pin Plugs and Sockets	93
Terminals & Connectors	94-95
Universal Switches	93-94

Click to go back to top



IGNITION & ELECTRICAL

Battery Cables & Terminals



A-26A101 Battery Cable Ends, Lead Reusable, (#6Ga. to 2Ga.)(5 Pk)

A-26A102 Battery Cable Ends, Brass Reusable, (#8Ga. to 1Ga.)(2 Pk)

A-26A5566 Battery Cable Ends, HD Lead Reusable (#1Ga. to 4/0Ga.)(2 Pk)



A-26A110 Cable, Battery to Starter, 10", 2 Ga.

A-26A112 Cable, Battery to Starter, 12", 1 Ga.

A-26A114 Cable, Battery to Starter, 14", 2 Ga.

A-26A117 Cable, Battery to Starter, 16", 2 Ga.

A-VLC1134 Cable, Battery to Starter, 17", 1 Ga.

A-BS19 Cable, Battery to Starter, 19", 2 Ga.

A-VLC1135 Cable, Battery to Starter, 21", 1 Ga.

A-26A124 Cable, Battery to Starter, 23", 2 Ga.

A-26A127 Cable, Battery to Starter, 27", 2 Ga.

A-AN31993 Cable, Battery to Starter, 31", 2 Ga.

A-VLC1136 Cable, Battery to Starter, 31", 1 Ga.

A-26A134 Cable, Battery to Starter, 34", 2 Ga.

A-26A138 Cable, Battery to Starter, 38", 2 Ga.

A-26A141 Cable, Battery to Starter, 42", 2 Ga.

A-VLC1137 Cable, Battery to Starter, 45", 1 Ga.

A-26A148 Cable, Battery to Starter, 48", 2 Ga.

A-26A158 Cable, Battery to Starter, 58", 2 Ga.

A-VLC1138 Cable, Battery to Starter, 64", 1 Ga.

A-26A164 Cable, Battery to Starter, 64", 2 Ga.

A-26A172 Cable, Battery to Starter, 75", 1/0 Ga.



A-26A209 Cable, Battery to Switch, 9", 2 Ga.

A-26A215 Cable, Battery to Switch, 16", 2 Ga.

A-26A238 Cable, Battery to Switch, 36", 2 Ga.

A-26A244 Cable, Battery to Switch, 49", 2 Ga.



A-26A104 Cable, Battery to Battery, 9 1/2", 1 Ga.

A-26A130 Cable, Battery to Battery, 30", 2/0 Ga.



A-26A108 Cable, Battery to Battery, 8" 90°, 1 Ga.

A-VLC1225 Cable, Battery to Battery, 10" 90°, 2/0 Ga.



A-26A800125 Battery Cable, Black, 1 Ga., 25 Ft. Roll

A-26A801025 Battery Cable, Black, 1/0 Ga., 25 Ft. Roll

A-26A802025 Battery Cable, Black, 2/0 Ga., 25 Ft. Roll

A-26A810125 Battery Cable, Red, 1 Ga., 25 Ft. Roll

A-26A811025 Battery Cable, Red, 1/0 Ga., 25 Ft. Roll

A-26A812025 Battery Cable, Red, 2/0 Ga., 25 Ft. Roll

A-8020100B Battery Cable, Black, 2/0 Ga., 100 Ft. Roll

A-26A8120100 Battery Cable, Red, 2/0 Ga., 100 Ft. Roll

Parts are not Original Equipment parts and are not sponsored, affiliated or otherwise connected with any major brand.

IGNITION & ELECTRICAL

Battery Bolts & Nuts, Ground Straps and Terminals



A-26A1-C Battery Bolts & Nuts, Square Head, 5/16" (4 Pk)
Tin Plated

A-26A1-B Battery Bolts & Nuts, Square Head, 5/16"
Sold in multiples of 50 bolts/50 nuts only.
PKG QTY: minimum order qty 50



A-26A305 Ground Strap, 5 1/2", 2 Ga.

A-26A307 Ground Strap, 7", 2 Ga.

A-26A309 Ground Strap, 9", 2 Ga.

A-26A311 Ground Strap, 11", 2 Ga.

A-26A314 Ground Strap, 13", 2 Ga.

A-26A317 Ground Strap, 16 1/2", 2 Ga.

A-26A319 Ground Strap, 19", 2 Ga.

A-26A322 Ground Strap, 24", 2 Ga.



A-26A9301 Battery Terminal Assortment, Crimp Copper, 1 Ga.

A-26A9320 Battery Terminal Assortment, Crimp Copper, 2/0 Ga.



A-5724005B Terminal Protectors, Black (5 Pk)
For 1/0 Ga. to 2/0 Ga.

A-5724005R Terminal Protectors, Red (5 Pk)
For 1/0 Ga. to 2/0 Ga.



A-4001005N-B Battery Terminal, Neg. Copper Crimp, 1 Ga. (5 Pk)
Straight Clamp

A-4001005P-B Battery Terminal, Pos. Copper Crimp, 1 Ga. (5 Pk)
Straight Clamp

A-4010005N-B Battery Terminal, Neg. Copper Crimp, 1/0 Ga. (5 Pk)
Straight Clamp

A-4010005P-B Battery Terminal, Pos. Copper Crimp, 1/0 Ga. (5 Pk)
Straight Clamp

A-4020005N-B Battery Terminal, Neg. Copper Crimp, 2/0 Ga. (5 Pk)
Straight Clamp

A-4020005P-B Battery Terminal, Pos. Copper Crimp, 2/0 Ga. (5 Pk)
Straight Clamp



A-4120005N-B Battery Terminal, Neg. Copper Crimp, 2/0 Ga. (5 Pk)
Right Elbow

A-4120005P-B Battery Terminal, Pos. Copper Crimp, 2/0 Ga. (5 Pk)
Right Elbow



A-4220005N-B Battery Terminal, Neg. Copper Crimp, 2/0 Ga. (5 Pk)
Left Elbow

A-4220005P-B Battery Terminal, Pos. Copper Crimp, 2/0 Ga. (5 Pk)
Left Elbow

Parts are not Original Equipment parts and are not sponsored, affiliated or otherwise connected with any major brand.

IGNITION & ELECTRICAL

IGNITION & ELECTRICAL

Terminals, Booster Cables & Tools



A-4301005N-B Battery Terminal, Neg. Copper Crimp, 1 Ga. (5 Pk)
Flag Terminal

A-4301005P-B Battery Terminal, Pos. Copper Crimp, 1 Ga. (5 Pk)
Flag Terminal

A-4320005N-B Battery Terminal, Neg. Copper Crimp, 2/0 Ga. (5 Pk)
Flag Terminal

A-4320005P-B Battery Terminal, Pos. Copper Crimp, 2/0 Ga. (5 Pk)
Flag Terminal



A-4801005F-B Battery Terminal, Copper Crimp, 1 Ga. (5 Pk)
Heavy Lug w/ 3/8" Hole

A-4801005H-B Battery Terminal, Copper Crimp, 1 Ga.
Heavy Lug w/ 1/2" Hole

A-4820005F-B Battery Terminal, Copper Crimp, 2/0 Ga. (5 Pk)
Heavy Lug w/ 3/8" Hole

A-4820005H-B Battery Terminal, Copper Crimp, 2/0 Ga. (5 Pk)
Heavy Lug w/ 1/2" Hole

A-4810005F-B Battery Terminal, Copper Crimp, 1/0 Ga. (5 Pk)
Heavy Lug w/ 3/8" Hole



A-26A6655 Splice, 2/0 Copper Butt (10 Pk)



A-26A5613 Shrink Tube, HT (3/4 XHD Black)
PKG QTY: minimum order qty 5

A-5614005R Shrink Tube, HT (3/4 XHD Red)
PKG QTY: minimum order qty 5
Length: 6.000"



A-VLC1140 Booster Cables, 16'
Gauge: 4



A-4266001 Crimping Tool, Hammer-Style
Can be used w/ hammer or vise. Crimps terminals 8 ga. to 6/0 ga.

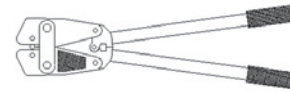

A-4255001 Crimping Tool, Lever-Style
With permanently attached, adjustable crimping dies. Crimps Terminals 8 ga. to 6/0 ga.



A-4275001 Cable Cutter
Heavy duty 9" long, made of forged steel, has insulated grips. Cuts 8 ga. to 3/0 ga.



A-26A4215 Wire Stripper



A-VLC2101 7 Pin Plug - Plastic
High Impact Moulded Plastic

Parts are not Original Equipment parts and are not sponsored, affiliated or otherwise connected with any major brand.



A-20A1739 Fuse Holder, w/ 20 Amp Fuse (4 Pk)



A-20A1701 Light Switch, Universal, Push/Pull Type
Fused
Amperage: 20
Position: 2
Terminal: 2
Thread: .500" Mounting Stem
Thread Length: .625" w/ Mounting Stem
Type: Push / Pull

A-VLC2105 7 Pin Socket - Metal



A-VLC2102 7 Pin Socket - Plastic



A-VLC2103 7 Pin Plug & Socket-Metal



A-5407S Socket, Implement Lights, 7 Pin (North America)
Metal Housing



A-L5031 Light Switch, Universal
Non-Fused
Position: 2
Terminal: 1
Thread: 3/8" Mounting Stem
Type: Push / Pull & On / Off



A-5407P Plug, Implement Lights, 7 Pin (North America)
Metal Housing



A-L5007 Light Switch, Universal, Heavy Duty
Amperage: 20
Position: 2
Terminal: 2
Thread: 3/8" Mounting Stem
Type: Push / Pull



A-20A1716 Light Switch, Universal, Push/Pull Type
Non-Fused
Amperage: 5
Position: 2
Terminal: 2
Thread: .500" Mounting Stem
Thread Length: .625" w/ Mounting Ste
Type: Push / Pull

Parts are not Original Equipment parts and are not sponsored, affiliated or otherwise connected with any major brand.

Universal Switches & Connectors



A-20A1747 Light Switch, Universal, Toggle
 Amperage: 20
 Position: 2
 Terminal: 2
 Thread: 7/16" Mounting Stem
 Type: Toggle



A-L55021 Switch, Universal, Toggle
 Position: 2 Momentary Centering
 Terminal: 3
 Thread: 7/16" Mounting Stem
 Type: Toggle



A-L5558 Switch, Universal, Toggle
 Amperage: 20
 Position: 2
 Terminal: 2
 Thread: 7/16" Mounting Stem
 Type: Toggle



A-VLC2531 Switch, Rocker; 20 Amp, 3 Terminal, On/Off (Illuminated)
 Terminals: 3
 Volt/Amperage: 12/20
 4 Color Discs & Various Symbols For Universal Applications
 Fitted w/ 12 Volt Bulb
 Requires 1.524" X .728" mounting hole and panel .150" thick

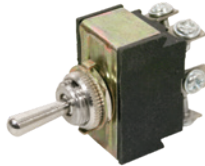

A-L5592 Switch, Universal, Toggle
 Position: 3
 Terminal: 6
 Thread: 7/16" Mounting Stem
 Type: Toggle



A-TCD176 Terminal & Connector Assortment
 176 pcs. vinyl insulated terminal & connector assortment in divided plastic case.



A-L5588 Switch, Universal, Toggle
 Position: 2
 Terminal: 4
 Thread: 7/16" Mounting Stem
 Type: Toggle



A-R21 Butt Connector, Wire Size 12-10, 10 Pk

A-R07 Butt Connector, Wire Size 16-14, 10 Pk

A-R01 Butt Connector, Wire Size 22-16, 10 Pk

Parts are not Original Equipment parts and are not sponsored, affiliated or otherwise connected with any major brand.

IGNITION & ELECTRICAL

Terminal Connectors & Electrical Wire



A-R17	Female Disconnects, Insulated, Wire Size 12-10, Tab Size .250, 10 Pk
A-R18	Female Disconnects, Insulated, Wire Size 16-14, Tab Size .250, 10 Pk
A-R18A	Female Disconnects, Insulated, Wire Size 22-16, Tab Size .250, 10 Pk



A-R20	Male Disconnects, Insulated, Wire Size 12-10, Tab Size .250, 10 Pk
A-R19	Male Disconnects, Insulated, Wire Size 16-14, Tab Size .250, 10 Pk
A-R16	Male Disconnects, Insulated, Wire Size 22-16, Tab Size .250, 10 Pk



A-R29	Spade Terminal, Insulated, Wire Size 12-10, Stud Size #10, 10 Pk
A-R25	Spade Terminal, Insulated, Wire Size 16-14, Stud Size #6, 10 Pk
A-R14	Spade Terminal, Insulated, Wire Size 16-14, Stud Size #8, 10 Pk
A-R15	Spade Terminal, Insulated, Wire Size 16-14, Stud Size #10, 10 Pk
A-R22	Spade Terminal, Insulated, Wire Size 22-16, Stud Size #6, 10 Pk



A-R08	Ring Terminal, Insulated, Wire Size 12-10, Stud Size 1/4", 10 Pk
A-R11	Ring Terminal, Insulated, Wire Size 12-10, Stud Size 3/8", 10 Pk
A-R23	Ring Terminal, Insulated, Wire Size 12-10, Stud Size #10, 10 Pk
A-R06	Ring Terminal, Insulated, Wire Size 16-14, Stud Size #6, 10 Pk
A-R09	Ring Terminal, Insulated, Wire Size 16-14, Stud Size #8, 10 Pk
A-R10	Ring Terminal, Insulated, Wire Size 16-14, Stud Size #10, 10 Pk
A-R05	Ring Terminal, Insulated, Wire Size 22-16, Stud Size 1/4", 10 Pk
A-R03	Ring Terminal, Insulated, Wire Size 22-16, Stud Size #6, 10 Pk
A-R04	Splice, 2/0 Copper Butt, 10 Pk #10 terminal 22-18 gauge

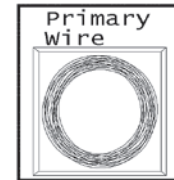

A-26A10	Coil Pack Primary Wire, 8', 10 Ga. (BLK)
A-26A12	Coil Pack Primary Wire, 12', 12 Ga. (YLW)
A-26A14	Coil Pack Primary Wire, 20', 14 Ga. (BLU)
A-26A16	Coil Pack Primary Wire, 30', 16 Ga. (RED)
A-26A18	Coil Pack Primary Wire, 40', 18 Ga. (WHT)

Parts are not Original Equipment parts and are not sponsored, affiliated or otherwise connected with any major brand.

IGNITION & ELECTRICAL

Electrical Wire



A-26A410 Primary Wire, 100', 10 Ga. (BLK)



A-26A412 Primary Wire, 100', 12 Ga. (YLW)



A-26A414 Primary Wire, 100', 14 Ga. (BLU)



A-26A416 Primary Wire, 100', 16 Ga. (RED)



A-26A418 Primary Wire, 100', 18 Ga. (WHT)

Parts are not Original Equipment parts and are not sponsored, affiliated or otherwise connected with any major brand.

Shop Supply Content

Cable Ties	102
Fuel Hose	114
Gauges	105-106
Grease	104
Grease Fittings	100-101
Hose Clamps	101
Jump Starters, Battery Chargers & Accessories	107-113
Machinery Bushings	99-100
Rodent Repellent & Insect Repellent	106-107
Roll Pins	102
Sealants/ Lubricant/ Anti-Seize	103-104
Set Collars	100
Shop Towels & Cloths	104-105
Snap Rings	101
Tire Gauges	105
Woodruff Keys	98

Click to go back to top





- A-WK01 **Woodruff Keys, 1/16 x 3/8**
PKG QTY: minimum order qty 20
- A-WK02 **Woodruff Keys, 1/16 x 1/2**
PKG QTY: minimum order qty 20
- A-WK03 **Woodruff Keys, 3/32 X 3/8**
PKG QTY: minimum order qty 20
- A-WK04 **Woodruff Keys, 3/32 X 1/2**
PKG QTY: minimum order qty 20
- A-WK05 **Woodruff Keys, 3/32 x 5/8**
PKG QTY: minimum order qty 20
- A-WK07 **Woodruff Keys, 1/8 x 1/2**
PKG QTY: minimum order qty 20
- A-WK08 **Woodruff Keys, 1/8 x 5/8**
PKG QTY: minimum order qty 20
- A-WK09 **Woodruff Keys, 1/8 x 3/4**
PKG QTY: minimum order qty 20
- A-WK10 **Woodruff Keys, 5/32 x 5/8**
PKG QTY: minimum order qty 20
- A-WK11 **Woodruff Keys, 5/32 x 3/4**
PKG QTY: minimum order qty 20
- A-WK12 **Woodruff Keys, 5/32 x 7/8**
PKG QTY: minimum order qty 20
- A-WK13 **Woodruff Keys, 3/16 x 5/8**
PKG QTY: minimum order qty 20
- A-WK14 **Woodruff Keys, 3/16 x 3/4**
PKG QTY: minimum order qty 20
- A-WK15 **Woodruff Keys, 3/16 x 7/8**
PKG QTY: minimum order qty 20
- A-WK16 **Woodruff Keys, 3/16 x 1**
PKG QTY: minimum order qty 10
- A-WK17 **Woodruff Keys, 3/16 x 1-1/8**
PKG QTY: minimum order qty 10
- A-WK18 **Woodruff Keys, 3/16 x 1-1/4**
PKG QTY: minimum order qty 10
- A-WK19 **Woodruff Keys, 3/16 x 2-1/8**
PKG QTY: minimum order qty 10
- A-WK20 **Woodruff Keys, 7/32 x 7/8**
PKG QTY: minimum order qty 10
- A-WK21 **Woodruff Keys, 7/32 x 1**
PKG QTY: minimum order qty 10
- A-WK22 **Woodruff Keys, 7/32 x 1-1/4**
PKG QTY: minimum order qty 10
- A-WK23 **Woodruff Keys, 1/4 x 3/4**
PKG QTY: minimum order qty 10
- A-WK24 **Woodruff Keys, 1/4 x 7/8**
PKG QTY: minimum order qty 10

- A-WK25 **Woodruff Keys, 1/4 x 1**
PKG QTY: minimum order qty 10
- A-WK26 **Woodruff Keys, 1/4 x 1-1/8**
PKG QTY: minimum order qty 10
- A-WK27 **Woodruff Keys, 1/4 x 1-1/4**
PKG QTY: minimum order qty 5
- A-WK28 **Woodruff Keys, 1/4 x 1-1/2**
PKG QTY: minimum order qty 5
- A-WK29 **Woodruff Keys, 1/4 x 2-1/8**
PKG QTY: minimum order qty 5
- A-WK30 **Woodruff Keys, 5/16 x 1**
PKG QTY: minimum order qty 5
- A-WK31 **Woodruff Keys, 5/16 x 1-1/8**
PKG QTY: minimum order qty 5
- A-WK32 **Woodruff Keys, 5/16 x 1-1/4**
PKG QTY: minimum order qty 5
- A-WK33 **Woodruff Keys, 5/16 x 1-3/8**
PKG QTY: minimum order qty 5
- A-WK34 **Woodruff Keys, 5/16 x 1-1/2**
PKG QTY: minimum order qty 5
- A-WK35 **Woodruff Keys, 5/16 x 2-1/8**
PKG QTY: minimum order qty 5
- A-WK36 **Woodruff Keys, 3/8 x 2-1/8**
PKG QTY: minimum order qty 5
- A-WK37 **Woodruff Keys, 3/8 x 1-1/4**
PKG QTY: minimum order qty 5
- A-WK38 **Woodruff Keys, 3/8 x 1-3/8**
PKG QTY: minimum order qty 5
- A-WK39 **Woodruff Keys, 3/8 x 1-1/2**
PKG QTY: minimum order qty 5
- A-WK40 **Woodruff Keys, 3/8 x 2-3/4**
PKG QTY: minimum order qty 5



- A-WK250 **Woodruff Key Assortment, 250 Pc.**
Contains: (10) A-WK01, (10) A-WK02, (20) A-WK03, (15) A-WK04, (10) A-WK05, (10) A-WK06 (15) A-WK07, (30) A-WK08, (20) A-WK09, (50) A-WK10 (10) A-WK11, (5) A-WK12, (5) A-WK13, (20) A-WK14, (5) A-WK15, (5) A-WK20, (5) A-WK23, (5) A-WK24

Parts are not Original Equipment parts and are not sponsored, affiliated or otherwise connected with any major brand.



14 Gauge = .0747" Thick

18 Gauge = .0474" Thick



14 Gauge = .0747" Thick

18 Gauge = .0474" Thick

Parts are not Original Equipment parts and are not sponsored, affiliated or otherwise connected with any major brand.

- A-MB01 Bushing, Machine 1/2" X 3/4" 14 Ga. (Narrow Rim)**
PKG QTY: minimum order qty 25
- A-MB02 Bushing, Machine 1/2" X 7/8" 18 Ga. (Narrow Rim)**
PKG QTY: minimum order qty 25
- A-MB03 Bushing, Machine 9/16" X 1" 18 Ga. (Narrow Rim)**
PKG QTY: minimum order qty 25
- A-MB48 Bushing, Machine 5/8" X 1" 14 Ga.**
PKG QTY: minimum order qty 25
- A-MB04 Bushing, Machine 5/8" X 1 1/8" 18 Ga. (Narrow Rim)**
PKG QTY: minimum order qty 25
- A-MB05 Bushing, Machine 3/4" X 1 1/4" 18 Ga. (Narrow Rim)**
PKG QTY: minimum order qty 25
- A-MB06 Bushing, Machine 3/4" X 1 1/4" 14 Ga. (Narrow Rim)**
PKG QTY: minimum order qty 25
- A-MB07 Bushing, Machine 7/8" X 1 3/8" 18 Ga. (Narrow Rim)**
PKG QTY: minimum order qty 25
- A-MB08 Bushing, Machine 7/8" X 1 3/8" 14 Ga. (Narrow Rim)**
PKG QTY: minimum order qty 25
- A-MB09 Bushing, Machine 1" X 1 1/2" 18 Ga. (Narrow Rim)**
PKG QTY: minimum order qty 25
- A-MB10 Bushing, Machine 1" X 1 1/2" 14 Ga. (Narrow Rim)**
PKG QTY: minimum order qty 25
- A-MB11 Bushing, Machine 1 1/8" X 1 3/4" 18 Ga. (Narrow Rim)**
PKG QTY: minimum order qty 25
- A-MB12 Bushing, Machine 1 1/8" X 1 3/4" 14 Ga. (Narrow Rim)**
PKG QTY: minimum order qty 25
- A-MB13 Bushing, Machine 1 1/4" X 1 7/8" 18 Ga. (Narrow Rim)**
PKG QTY: minimum order qty 25
- A-MB14 Bushing, Machine 1 1/4" X 1 7/8" 14 Ga. (Narrow Rim)**
PKG QTY: minimum order qty 25
- A-MB15 Bushing, Machine 1 3/8" X 2 1/8" 18 Ga. (Narrow Rim)**
PKG QTY: minimum order qty 25
- A-MB16 Bushing, Machine 1 3/8" X 2 1/8" 14 Ga. (Narrow Rim)**
PKG QTY: minimum order qty 25
- A-MB17 Bushing, Machine 1 1/2" X 2 1/4" 14 Ga. (Narrow Rim)**
PKG QTY: minimum order qty 25
- A-MB18 Bushing, Machine 1 5/8" X 2 3/8" 14 Ga. (Narrow Rim)**
PKG QTY: minimum order qty 25

- A-MB19 Bushing, Machine 1 3/4" X 2 1/2" 14 Ga. (Narrow Rim)**
PKG QTY: minimum order qty 25
- A-MB20 Bushing, Machine 1 3/4" X 2 1/2" 10 Ga. (Narrow Rim)**
PKG QTY: minimum order qty 25
- A-MB21 Bushing, Machine 1 7/8" X 2 7/8" 14 Ga. (Narrow Rim)**
PKG QTY: minimum order qty 25
- A-MB22 Bushing, Machine 2" X 3" 14 Ga. (Narrow Rim)**
PKG QTY: minimum order qty 25
- A-MB23 Bushing, Machine 2 1/8" X 3 1/8" 14 Ga. (Narrow Rim)**
PKG QTY: minimum order qty 25
- A-MB24 Bushing, Machine 2 1/4" X 3 1/4" 14 Ga. (Narrow Rim)**
PKG QTY: minimum order qty 25
- A-MB25 Bushing, Machine 2 3/8" X 3 3/8" 14 Ga. (Narrow Rim)**
PKG QTY: minimum order qty 25
- A-MB26 Bushing, Machine 2 1/2" X 3 1/2" 14 Ga. (Narrow Rim)**
PKG QTY: minimum order qty 25
- A-MB27 Bushing, Machine 3" X 4 1/4" 14 Ga. (Narrow Rim)**
PKG QTY: minimum order qty 25

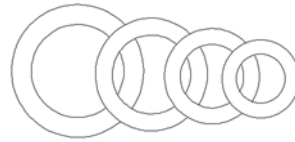

14 Gauge = .0747" Thick

18 Gauge = .0474" Thick

- A-MB28 Bushing, Machine 3/4" X 1 1/2" 18 Ga. (Wide Rim)**
PKG QTY: minimum order qty 25
- A-MB29 Bushing, Machine 7/8" X 1 3/4" 18 Ga. (Wide Rim)**
PKG QTY: minimum order qty 25
- A-MB30 Bushing, Machine 1" X 2" 18 Ga. (Wide Rim)**
PKG QTY: minimum order qty 25
- A-MB31 Bushing, Machine 1 1/8" X 2 1/8" 18 Ga. (Wide Rim)**
PKG QTY: minimum order qty 25
- A-MB32 Bushing, Machine 1 1/4" X 2 1/4" 18 Ga. (Wide Rim)**
PKG QTY: minimum order qty 25
- A-MB33 Bushing, Machine 1 3/8" X 2 1/2" 18 Ga. (Wide Rim)**
PKG QTY: minimum order qty 25
- A-MB34 Bushing, Machine 1 1/2" X 3" 18 Ga. (Wide Rim)**
PKG QTY: minimum order qty 25
- A-MB35 Bushing, Machine 1 3/4" X 3 1/4" 18 Ga. (Wide Rim)**
PKG QTY: minimum order qty 25
- A-MB36 Bushing, Machine 2" X 3 1/2" 18 Ga. (Wide Rim)**
PKG QTY: minimum order qty 25
- A-MB37 Bushing, Machine 2 1/8" X 3 5/8" 18 Ga. (Wide Rim)**
PKG QTY: minimum order qty 25
- A-MB38 Bushing, Machine 2 1/4" X 3 3/4" 18 Ga. (Wide Rim)**
PKG QTY: minimum order qty 25



A-MBDB01

Machinery Bushing Display

Display board comes complete w/ 22 angle screw hooks packed w/ 197 of the most popular size narrow rim and wide rim bushings, 9/16" thru 2-1/2".

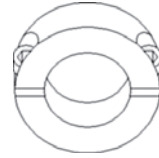

A-DSA11516

Collar, Double Split Shaft, 1 15/16"

Bore: 1 15/16"
Finish: Black Oxide
Outside Diameter: 3"
Thread: 5/16"-24

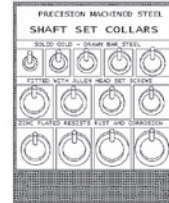

A-SCDB01

Set Collar Displays

Colorful, sturdy 1/4" masonite, 13" x 18" display board. Comes with hooks for 13 set collar sizes. Can be mounted on the wall or used as a detachable stand for counter displays.
Includes: 45 collars from 1/2" - 1 1/2"



A-SC516

Set Collar, 5/16" (2 pk)

A-SC38

Set Collar, 3/8" (2 pk)

A-SC716

Set Collar, 7/16" (2 pk)

A-SC12

Set Collar, 1/2" (2 pk)

A-SC58

Set Collar, 5/8" (2 pk)

A-SC916

Set Collar, 9/16" (2 pk)

A-SC34

Set Collar, 3/4" (2 pk)

A-SC78

Set Collar, 7/8" (2 pk)

A-SC1516

Set Collar, 15/16" (2 pk)

A-SC1

Set Collar, 1" (2 pk)

A-SC118

Set Collar, 1-1/8" (2 pk)

A-SC1316

Set Collar, 1-3/16" (2 pk)

A-SC114

Set Collar, 1-1/4" (2 pk)

A-SC138

Set Collar, 1-3/8" (2 pk)

A-SC1716

Set Collar, 1-7/16" (2 pk)

A-SC112

Set Collar, 1-1/2" (2 pk)



5A1610
1/8"



5A1627
1/4"



5A1629
1/4" - 65

A-GF18PT

1/8" - Pipe Thread Fitting, (20 pk)

A-GF1845PT

1/8" - 45° Pipe Thread Fitting, (20 pk)

A-GF1865PT

1/8" - 65° Pipe Thread Fitting, (20 pk)

A-GF1890PT

1/8" - 90° Pipe Thread Fitting, (20 pk)

A-GF14PT

1/4" - Pipe Thread Fitting, (10 pk)



5A1641B
1/4" - 28 THREAD



5A2172
1/4" - 45



5A2170A
1/4" - 90

A-GF1428TT

1/4" - 28° Taper Thread Fitting, (20 pk)

A-GF1445TT

1/4" - 45° Taper Thread Fitting, (20 pk)

A-GF1490TT

1/4" - 90° Taper Thread Fitting, (20 pk)

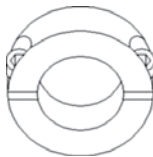

A-DSA38

Collar, Double Split Shaft, 3/8" (2 pk)

Bore: 3/8"
Finish: Black Oxide
Outside Diameter: 7/8"
Thread: 6-32

Parts are not Original Equipment parts and are not sponsored, affiliated or otherwise connected with any major brand.

Grease Fittings, Snap Rings & Hose Clamps

Parts are not Original Equipment parts and are not sponsored, affiliated or otherwise connected with any major brand.

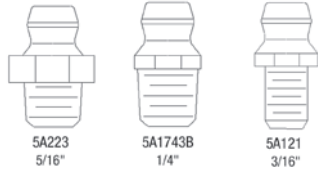

- A-GF516D 5/16" Drive Type Fitting, (20 pk)
- A-GF14D 1/4" Drive Type Fitting, (20 pk)
- A-GF316D 3/16" Drive Type Fitting, (20 pk)



- A-GF6M 6mm ST. Metric Grease Fitting, (20 pk)
- A-GF645M 6mm 45° Metric Grease Fitting, (20 pk)
- A-GF690M 6mm 90° Metric Grease Fitting, (20 pk)
- A-GF8M 8mm ST. Metric Grease Fitting, (20 pk)
- A-GF845M 8mm 45° Metric Grease Fitting, (10 pk)
- A-GF890M 8mm 90° Metric Grease Fitting, (10 pk)
- A-GF10M 10mm ST. Metric Grease Fitting, (20 pk)
- A-GF1045M 10mm 45° Metric Grease Fitting, (10 pk)
- A-GF1090M 10mm 90° Metric Grease Fitting, (10 pk)



- A-GFC1 Grease Fitting Cap, (25 pk)
Made of polyethylene. The 5A 8 grease cap snaps securely over fittings to seal out dirt & moisture. Integral retaining ring keeps cap in place during servicing.

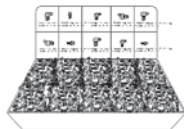

- A-GFA1 Standard Grease Fitting Assortment
Each Box Contains: (30) GF18PT, (30) GF1428TT, (10) GF1845PT, (10) GF1445TT, (10) GF1890PT, (10) GF1490TT



- A-GFCD1 Grease Fitting Counter Assortment
Contains: Pipethread 6-5A1888B, (6) A-GF1845PT, (6) A-GF1865PT, (6) A-GF1890PT, (8) A-GF18PT, (4) A-GF14PT, (4) A-GF1465PT, (10) A-GF1428TT, (8) A-GF1445TT, (8) A-GF1490TT, (15) A-GFC1.

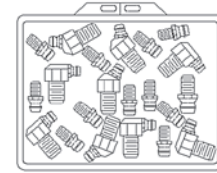

- A-MGFA1 Metric Grease Fitting Assortment
Metric grease fitting assortment contains 12 individual pkgs : (3) A-GF6M, (2) A-GF8M, (1) A-GF10M, (3) A-GF690M, (2) A-GF890M, (1) A-GF1090M.

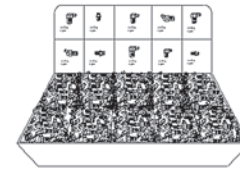

- A-MGFCD1 Metric Grease Fitting Counter Display
Contains: (10) A-GF6M, (10) A-GF690M, (10) A-GF845M, (6) A-GF10M, (6) A-GF1090M, (15) A-GFC1, (10) A-GFC45M, (10) A-GF8M, (10) A-GF890M, (6) A-GF1045M.



- A-B1SB7 Snap Ring Assortment (300 pieces)
300 piece external snap ring assortment. Includes these quantities & sizes - (5) 1 1/4" (10) 1" (20) 7/8" (10) 13/16" (35) 3/4" (30) 5/8" (20) 9/16" (20) 1/2" (50) 7/16" (50) 3/8" (20) 5/16" (30) 1/4"



- A-C4P 7/32"-5/8" Hose Clamps, (10 pk)
Fits 1/4" to 5/8" Hose
- A-C6P 7/16"-25/32" Hose Clamp, (10 pk)
Fits 7/16" to 25/32" Hose
- A-C8P 1/2"-29/32" Hose Clamp, (10 pk)
Fits 1/2" to 29/32" Hose
- A-C10P 9/16"-1-1/16" Hose Clamp, (10 pk)
Fits 9/16" to 1 1/16" Hose
- A-C12P 11/16"-1-1/4" Hose Clamp, (10 pk)
Fits 11/16" to 1 1/4" Hose
- A-C16P 13/16"-1 1/2" Hose Clamp, (10 pk)
Fits 3/4" to 1 1/2" Hose
- A-C20P 13/16"-1 3/4" Hose Clamp, (10 pk)
Fits 13/16" to 1 3/4" Hose

SHOP SUPPLY

Hose Clamps, Cable Ties & Roll Pins



- A-C24P** **1-1/16"-2" Hose Clamp, (10 pk)**
Fits 1 1/16" to 2" Hose
- A-C28P** **1-5/16"-2-1/4" Hose Clamp, (10 pk)**
Fits 1 5/16" to 2 1/4" Hose
- A-C32P** **1-9/16"-2-1/2" Hose Clamp, (10 pk)**
Fits 1 9/16" to 2 1/2" Hose
- A-C36P** **1-13/16"-2-3/4" Hose Clamp, (10 pk)**
Fits 1 13/16" to 2 3/4" Hose
- A-C40P** **2 1/16"- 3" Hose Clamp, (10 pk)**
Fits 2 1/16" to 3" Hose
- A-C44P** **2-5/16"-3-1/4" Hose Clamp, (10 pk)**
Fits 2 5/16" to 3 1/4" Hose
- A-C48P** **2-9/16"-3-1/2" Hose Clamp, (10 pk)**
Fits 2 9/16" to 3 1/2" Hose
- A-C56P** **3 1/16"-4" Hose Clamp, (10 pk)**
Fits 3 1/16" to 4" Hose

- A-14B506** **11-1/2" Self Locking Nylon Cable Ties**
Minimum Diameter: 1/16"
Maximum Diameter: 3"
PKG QTY: minimum order qty 100
- A-14B507** **14-1/2" Self Locking Nylon Cable Ties**
Minimum Diameter: 1/16"
Maximum Diameter: 4"
PKG QTY: minimum order qty 100
- A-14B510** **33" Self Locking Nylon Cable Ties**
Minimum Diameter: 3/16"
Maximum Diameter: 8"
PKG QTY: minimum order qty 25

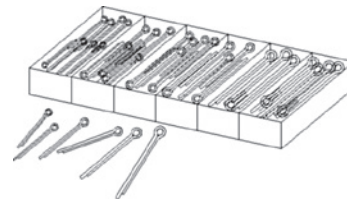

- A-VLF3602** **Cotter Pin Pack**
Contains 430 pins in sizes from 1/16 x 1" - 5/32 x 2-1/2"



- A-14B5401** **Hose Clamp Assortment**
Includes: 10-C20P, 30-C28P, 10-C36P, 20-C10P, 20-C4P, 20-C16P



- A-P4X30** **Roll Pin, 4 MM x 30 MM, 5 pack**
- A-P7X50** **Roll Pin, 7 MM x 50 MM, 5 pack**
- A-P7X55** **Roll Pin, 7 MM x 55 MM, 2 pack**
- A-P6X50** **Roll Pin, 6 MM x 50 MM, 5 pack**
- A-P6X60** **Roll Pin, 6 MM x 60 MM, 2 pack**
- A-P12X50** **Roll Pin, 12 MM X 50 MM, 5 pack**



- A-14B501** **4" Self Locking Nylon Cable Ties**
Minimum Diameter: 1/16"
Maximum Diameter: 3/4"
PKG QTY: minimum order qty 100
- A-14B502** **6" Self Locking Nylon Cable Ties**
Minimum Diameter: 1/16"
Maximum Diameter: 1-1/4"
PKG QTY: minimum order qty 100
- A-14B505** **8" Self Locking Nylon Cable Ties**
Minimum Diameter: 1/16"
Maximum Diameter: 2"
PKG QTY: minimum order qty 100

Parts are not Original Equipment parts and are not sponsored, affiliated or otherwise connected with any major brand.



A-B1AC403 Fluid Film Corrosion Control (11.75 oz)

- Its unique woolwax (lanolin) formula contains no solvents to evaporate.
- Always active, it will not become tacky, providing long-term protection to all metals and superior lubrication to all moving parts

PKG QTY: minimum order qty 12

A-B1AC404 Fluid Film Corrosion Control (gallon)

A-B1AC405 Fluid Film Corrosion Control (5.28 gallon)



A-CCL1112 Lube, Chain & Cable, Moly

- Case Of 12 Cans, Priced Individually
- 11 oz Cans

PKG QTY: minimum order qty 12



A-2417C Brake & Parts Cleaner 50-state 12 (13oz) cans

- Removes oil, grease, brake fluid and contaminants quickly and with no residue.
- For use on all ABS, disc and drum brakes.
- Formulated to meet VOC requirements in California.

PKG QTY: minimum order qty 12



A-6732 Starter Fluid - 50% ether blend 12 (7.2oz) cans

- Premium 50% ether blend.
- Helps start stubborn engines fast in cold weather.
- Contains upper cylinder lubricants.
- Performs to -65°F.
- Works great in passenger cars, diesel engines, lawn mowers, chainsaws, outboard motors, and fractional horsepower engines.
- This diesel fuel additive complies with federal low sulfur content requirements for use in diesel motor vehicles and non-road engines.

PKG QTY: minimum order qty 12



A-910-06R Glass Cleaner 6 (19oz) cans

PKG QTY: minimum order qty 6



A-4723 Chain & Cable Lube 12 (10 oz) cans

- A special blend of lubricants and solvents designed to keep chains and cables in peak operating condition
- Helps in preventing rust corrosion
- Can be used on low speed conveyors, drive chains, hoists, pulleys, rollers, garage doors, bushings, seals, o-rings and many other applications requiring lubrication.

PKG QTY: minimum order qty 12



A-4602 Multi-Purpose Penetrating Oil & Lube, 12 (12 oz) cans

- A lubricant and penetrant
- Special additives loosen rust and soak into subsurface areas.

PKG QTY: minimum order qty 12

Parts are not Original Equipment parts and are not sponsored, affiliated or otherwise connected with any major brand.



A-4641C

Carb & Choke Cleaner 12 (10 oz) cans

- Removes varnish, sludge, and other deposits from carburetor, linkage, PCV valves, automatic choke, and air intake
 - Formulated to meet VOC requirements in all 50 states.
- PKG QTY: minimum order qty 12



A-GRPOL

Grease, Multi-Purpose SD Polyurea

- Long-Lasting Grease for High Temperature and Extreme Pressure
 - Provides high temperature protection under heavy load for extended time
 - Protects against corrosion and oxidation
 - Applications: Fast moving bearings, pumps, pulleys, internal engine parts
- PKG QTY: minimum order qty 10



A-GRLIT

Grease, Multi-Purpose Lithium

- Used in general purpose applications where extreme pressure and high temperature are not required
 - Protects against corrosion and oxidation
 - Provides long-lasting lubricant film
 - Used on metal to metal contact
 - Applications: Hinges, CV Joints, Gears, Slow moving Bearings
- PKG QTY: minimum order qty 10



A-ST200

Shop Towel Bucket (sold in lots of 2)

- Each Bucket Contains 200 (10" X 12") Dry Towels.
- 1 Ply Disposable Towels
- Absorbs Fluid On Contact
- 400% More Absorbent Than Rental Towels
- Cost Less To Use Than Rental Towels
- Fiber Blended With No Thread Gap
- No Bleed, Colorfast Material



A-GRMOL

Grease, Special Purpose HD Moly

- Recommended for conditions of heavy shock loading
 - Excellent high temperature stability
 - Protects against corrosion and oxidation
 - Not recommended for high speed roller or ball bearings
 - Applications: Pins, fifth wheels, ball joints, chassis, chains, cables, conveyors
- PKG QTY: minimum order qty 10

A-ST200-R

Shop Towel Refill (sold in lots of 6)

- Each Refill Contains 200 (10" X 12") Dry Towels.
- 1 Ply Disposable Towels
- Absorbs Fluids On Contact
- 400% More Absorbent Than Rental Towels
- Cost Less To Use Than Rental Towels
- Fiber Blended With No Thread Gap
- No Bleed, Colorfast Material



A-ST200B-6

Shop Towel, 10" X 12"; Case Of 6, 200 Count Card Board Boxes
Case Of (6) ST200B

Parts are not Original Equipment parts and are not sponsored, affiliated or otherwise connected with any major brand.



A-AP22883

Eversoak® Light Duty Absorbent Pads (15" X 19")

- Absorbs Oil And Water As Well As Grease, Transmission Fluid, Coolants, Diesel Fuel And Many Other Fluids.

Qty: 100 Pads Per Box

Color: Gray

- Less Dust And Mess Than Floor Dry.
- Absorbs Up To 24 Gallons Of Oil Per Box.
- Made With 70% Recycled Cellulose Fibers.



A-S-928

Tire Gauge, 5 - 50 PSI

For Air/Water Filled Tires

5 - 50 PSI

Increments (LB): 1

kPA: 40 - 350

Increments (kPA): 10

Parts are not Original Equipment parts and are not sponsored, affiliated or otherwise connected with any major brand.



A-ETME150

Digital Caliper



A-S-976

Dual Chuck Head Tire Gauge, 10 - 160 PSI

10 - 160 PSI

Increments (LB): 2

80 - 1100 kPA

Increments (kPA): 20

- Nylon Indicator Bar w/ 2 Sides In PSI & 2 In kPA
- Hot Stamped Printed Indicator Bar



A-5D6

Water Adapter

Use to connect garden hose coupling to air liquid tractor valves. Includes bushings to fit both external & internal threads.



A-S-986

Straight Foot Dual Chuck Head Tire Gauge

10 - 160 PSI

Increments (LB): 2

80 - 1100 kPA

Increments (kPA): 20

- Nylon Indicator Bar w/ 2 Sides In PSI & 2 Sides In kPA
- Hot Stamped Printed Indicator Bar

A-S-690

Dual Head Air Chuck

1/4" FNPT Connection

Maximum Air Pressure: 150 PSI



A-S-693

Dual Head Straight Foot Air Chuck

- 1/4" FNPT
 - For Inner Duals
 - Both Ends Lock On Valve Core Threads
- Maximum Air Pressure: 150 PSI



A-GG60

Gauge, 60 Lb.; Glycerin Filled

- Glycerin filled to lubricate, help prevent point flutter and prevent corrosion of the movement.

Diameter: 2 1/2"

- Nickel silver movement, accurate to within 2% of full range reading.

- PSI / Bar Dial

Lens: Plexiglass Crystal

- 1/4" -18 NPT male fitting at bottom of gauge.

SHOP SUPPLY

Gauge & Rodent Repellent



A-GG600

Gauge, 600 Lb.; Glycerin Filled

- Glycerin filled to lubricate, help prevent point flutter and prevent corrosion of the movement.

Diameter: 2 1/2"

- Nickel silver movement, accurate to within 2% of full range reading.
- PSI / Bar Dial
- Lens: Plexiglass Crystal
- 1/4" - 18 NPT male fitting at bottom of gauge.



A-GG1000

Gauge, 1000 Lb.; Glycerin Filled

- Glycerin filled to lubricate, help prevent point flutter and prevent corrosion of the movement.

Diameter: 2 1/2"

- Nickel silver movement, accurate to within 2% of full range reading.
- PSI / Bar Dial
- Lens: Plexiglass Crystal
- 1/4" - 18 NPT male fitting at bottom of gauge.



A-B1PMFCS12 Fresh Cab Rodent Repellent

- Use for enclosed, uninhabited areas such as RV's, sheds, and attics.
 - Fast acting, plant powered essential oils
 - For rodent infestations. Place 1 pouch per 8 sq. ft. wherever you've seen rodent activity. Replace after 30 days or when scent diminishes.
 - For rodent prevention. Place 1 pouch per 125 sq. ft. Replace every 60 days or when scent diminishes.
 - Safe to use around children and pets.
- PKG QTY: minimum order qty 12



A-B1GPP106

Grandpa Gus's Rodent Repellent Pouches

- Repels Mice
 - Acts as an air freshener
 - Absorbs leftover odors
 - Made and tested by farmers, homeowners, and RVer's coast to coast
 - 10 filter pouches per sack with a minimum order of 6 sacks
 - This repellent is available in the US only.
- Quantity: 6 - 10 pk pouches



A-B1GMM415

Grandpa Gus's Rodent Repel Burlap Pouches

- Repels Mice and Rodents
 - Acts as an air freshener that is made using a unique candy cane blend of peppermint and cinnamon
 - Made and tested by farmers, homeowners, and RVer's coast to coast
 - 4 pouches per Sack with a minimum order of 15 Sacks
 - This repellent is available in the US only.
- PKG QTY: minimum order qty 15



A-B1GSB8A15

Grandpa Gus's Rodent Spray, 8 oz, USA Only

- 8oz's of DOUBLE-POTENCY FORMULA is tough on mice. Most spray repellents use only peppermint at less
 - Effective, meant for home use: Potent Mouse Repellent is a rodent deterrent that is meant for home use. The formula is irritating to mice only with its special blend.
 - Best transfer rate and no stains: With a water-based formula repelling formula spreads faster than non-scientific formulas. It also leaves NO STAINS.
 - Uses: Vehicle Cabs, Under the Hood of Vehicle and Equipment (wiring and vents), RVs, Garages, Crawl Spaces and Storage Lockers, Under Sinks, Garden Sheds, Around Plants, In Cabinets and Tool Boxes, and anywhere you have seen mice.
 - This repellent is available in the US only.
- PKG QTY: minimum order qty 15

Parts are not Original Equipment parts and are not sponsored, affiliated or otherwise connected with any major brand.

Rodent Repellent, Insect Repellent & Jump Starters



A-B1GSB14

Grandpa Gus's Rodent Spray, 1 Gal, USA Only

- 1 Gallon of DOUBLE-POTENCY FORMULA is tough on mice. Most spray repellents use only peppermint at less
 - Effective, meant for home use: Potent Mouse Repellent is a rodent deterrent that is meant for home use. The formula is irritating to mice only with its special blend.
 - Best transfer rate and no stains: With a water-based formula repelling formula spreads faster than non-scientific formulas. It also leaves NO STAINS.
 - Uses: Vehicle Cabs, Under the Hood of Vehicle and Equipment (wiring and vents), RVs, Garages, Crawl Spaces and Storage Lockers, Under Sinks, Garden Sheds, Around Plants, In Cabinets and Tool Boxes, and anywhere you have seen mice.
 - This repellent is available in the US only.
- PKG QTY: minimum order qty 4



A-B1GMQ420

Mosquito Repellent, 4 FL OZ

- 4oz ALL-NATURAL FORMULA prevents mosquitoes from biting by using natural plant oils that inhibit the mosquitoes senses. No Deet!
 - SMELLS LIKE LEMON and lasts for hours. Meant for use on bare skin and clothing.
 - EASY-TO-CARRY 4oz bottle fits in purses and backpacks, glove boxes and toolboxes. the perfect size for hiking and camping.
 - TO USE: spray on skin or clothing and let dry. No need to rub in, no sticky mess.
 - This repellent is available in the US only.
- PKG QTY: minimum order qty 20



A-B1GRG246

Grandpa Gus's Rat & Mouse Repellent Powder

- Repel Mice AND Rats: Grandpa Gus's special powder is lab-tested and proven to work on mice and rats.
 - Where to use: Your solution for outdoor spaces, such as shops and sheds, or around farm machinery, vehicles or RVs. (Can also be used indoors.)
 - How to use: sprinkle the powder around the perimeter area of the building or around stored equipment/vehicles, or place a mound on a paper plate and place in an area rodents travel. A perfect compliment to Gus's pouches and spray.
 - How it works: rodents contact the powder repellent, sense the area is unsafe through the powder's scent, texture and taste. Then they leave.
 - Lasts up to 30 days (or until wet)
 - This repellent is available in the US only.
- PKG QTY: minimum order qty 6



A-B1GTK420

Tick Repellent, 4 FL OZ

- 4oz ALL-NATURAL FORMULA prevents ticks from latching and biting by inhibiting ticks' sensory organs. No Deet!
 - Works on humans and dogs - will not burn or irritate skin on dogs. Enjoy exercise, hunting and working cattle with this spray.
 - Smells like cedar and lasts for hours.
 - Easy-to-use 4oz bottle fits in purses and backpacks, glove boxes and toolboxes. The perfect size for hiking and camping.
 - TO USE: spray on skin or clothing and let dry. No need to rub in, no sticky mess. For dogs, spray on fur and rub in. Then spray on top of fur and let dry.
 - This repellent is available in the US only.
- PKG QTY: minimum order qty 20



A-GB20

Sport 500A Lithium Jump Starter

- Jump Start up to 4L gas engines
 - Charge cell phones, tablets, and other devices via USB
 - Built-in tactical grade 100 lumen flashlight
- Size: 7.7" X 3.2" X 1.7"

Parts are not Original Equipment parts and are not sponsored, affiliated or otherwise connected with any major brand.

SHOP SUPPLY

Jump Starters



A-GB40

Plus 1000A Lithium Jump Starter

- Jump Start up to 6L gas engines and 3L diesel engines
- Up to 20 jumps per charge
- Built-in USB charge port and tactical grade 100 lumen flashlight

Size: 7.7" X 3.2" X 1.7"



A-GB250

Max 5250A 12 V Lithium Jump Starter

- 5250 Amp 12-Volt UltraSafe Portable Lithium Jump Starter
- Jump start gas and diesel engines up to 16-Liters
- Jump starts almost every type of vehicle and equipment, including semi-trucks (up to class 8), motorhomes, buses, construction, and more.
- Built-in USB charge port and tactical grade 600 lumen flashlight

Size: 12.4" X 6.1" X 3.7"



A-GB50

XL 1500A Lithium Jump Starter

- Jump Start up to 7L gas engines and 4.5L diesel engines
- Up to 30 jumps per charge
- Built-in USB charge port and tactical grade 200 lumen flashlight

Size: 8.6" X 3.4" X 2.0"



A-GB251

Max 3000A 24V Lithium Jump Starter

- 3000 Amp 24-Volt UltraSafe Portable Lithium Jump Starter
- Jump start gas and diesel engines up to 32-Liters
- Jump starts almost every type of vehicle and equipment, including semi-trucks (up to class 8), motorhomes, buses, construction, and more.
- Built-in USB charge port and tactical grade 600 lumen flashlight

Size: 12.4" X 6.1" X 3.7"



A-GB70

HD 2000A Lithium Jump Starter

- Jump Start up to 8L gas engines and 6L diesel engines
- Up to 40 jumps per charge
- Provides 12v accessory output to power air compressors, inverters, etc.
- Built-in USB charge port and tactical grade 400 lumen flashlight

Size: 8.3" X 3.9" X 2.8"



A-GB500

Max 20,000A Lithium Jump Starter

- Jump Start up to Class 8+ engines
- High-intensity 2,200 lumen work light
- Provides 12v accessory output to power air compressors, inverters, etc.
- 2 built-in USB charge ports for on the go power
- Comes with an over the shoulder carrying case

Size: 12.3" X 8.2" X 6.3"



A-GB150

Pro 3000A Lithium Jump Starter

- Jump Start up to 9L gas engines and 7L diesel engines
- Up to 80 jumps per charge
- Voltmeter built into the unit
- Provides 12v accessory output to power air compressors, inverters, ect.
- Built-in USB charge port and tactical grade 500 lumen flashlight

Size: 12.4" X 5" X 2.7"

Parts are not Original Equipment parts and are not sponsored, affiliated or otherwise connected with any major brand.



A-GENIUS1

1A Battery Charger

- 6V & 12V 1-Amp Smart Battery Charger
- Designed for 6V and 12V lead-acid automotive, marine and deep-cycle batteries, including flooded, gel, AGM and maintenance-free, plus lithium-ion batteries
- Charges dead batteries as low as 1V or use the all-new Force Mode that allows you to take control and manually begin charging dead batteries down to zero volts.
- An integrated thermal sensor detects the ambient temperature and alters the charge to eliminate over-charging in cold climates.
- Plug-in, connect to the battery, select a charge mode and start charging your battery. A fully-automatic, worry-free battery charger for year-round use.
- Charges batteries up to 30 amp hours.

Size: 3.5" X 2.3" X 1.3"



A-GENIUS5

5A Battery Charger

- 6V & 12V 5-Amp Smart Battery Charger
- Designed for 6V and 12V lead-acid automotive, marine and deep-cycle batteries, including flooded, gel, AGM and maintenance-free, plus lithium-ion batteries
- Charges dead batteries as low as 1V or use the all-new Force Mode that allows you to take control and manually begin charging dead batteries down to zero volts.
- An integrated thermal sensor detects the ambient temperature and alters the charge to eliminate over-charging in hot climates and under charging in cold climates.
- Plug-in, connect to the battery, select a charge mode and start charging your battery. A fully-automatic, worry-free battery charger for year-round use.
- Charges batteries up to 120 amp hours.

Size: 4.6" X 2.9" X 1.9"



A-GENIUS2

2A Battery Charger

- 6V & 12V 2-Amp Smart Battery Charger
- Designed for 6V and 12V lead-acid automotive, marine and deep-cycle batteries, including flooded, gel, AGM and maintenance-free, plus lithium-ion batteries
- Charges dead batteries as low as 1V or use the all-new Force Mode that allows you to take control and manually begin charging dead batteries down to zero volts.
- An integrated thermal sensor detects the ambient temperature and alters the charge to eliminate over-charging in hot climates and under charging in cold climates.
- Plug-in, connect to the battery, select a charge mode and start charging your battery. A fully-automatic, worry-free battery charger for year-round use.
- Charges batteries up to 40 amp hours.

Size: 3.7" X 2.4" X 1.7"



A-GENIUS10

10A Battery Charger

- 6V & 12V 10-Amp Smart Battery Charger
- Designed for 6V and 12V lead-acid automotive, marine and deep-cycle batteries, including flooded, gel, AGM and maintenance-free, plus lithium-ion batteries
- Charges dead batteries as low as 1V or use the all-new Force Mode that allows you to take control and manually begin charging dead batteries down to zero volts.
- An integrated thermal sensor detects the ambient temperature and alters the charge to eliminate over-charging in hot climates and under charging in cold climates.
- Plug-in, connect to the battery, select a charge mode and start charging your battery. A fully-automatic, worry-free battery charger for year-round use.
- Charges batteries up to 230 amp hours.

Size: 7.1" X 3.6" X 2.3"

Parts are not Original Equipment parts and are not sponsored, affiliated or otherwise connected with any major brand.



A-GENPRO25

25A Battery Charger

- 6V & 12V 25-Amp Smart Battery Charger
 - A multi-voltage charger - 6V (25A), 12V (25A), and 24V (12.5A) - for lead-acid automotive, marine and deep-cycle batteries, including flooded, gel, AGM and maintenance-free, plus lithium-ion batteries
 - Designed for pros who need absolute performance and uncompromising functionality. Featuring ultra-flexible silicone cabling - down to -40 degree F - with protective nylon braided shielding for maximum protection against abrasion.
 - A dual-voltage power supply - 12V (25A) and 24V (12.5A) - to maintain constant power delivery without unwanted ripple, noise and transient spikes during ECU flashing, reprogramming and diagnostic testing.
 - An integrated thermal sensor detects the ambient temperature and alters the charge to eliminate over-charging in hot climates and under-charging in cold climates to maximize battery life and enable fast charging.
 - Detects batteries as low as 1V or use the all-new Force Mode that allows you to manually begin charging dead batteries down to zero volts.
 - Automatically detects battery sulfation and acid stratification to restore lost battery performance for stronger engine starts and extended battery life. Plus, cutting edge battery repair modes for 6V, 12V and 24V batteries.
 - 6V/12V up to 1000A hours and 24V up to 500A hours.
- Size: 9.3" X 5.1" X 3.0"



A-GENPRO50

50A Battery Charger

- 6V & 12V 50-Amp Smart Battery Charger
 - A multi-voltage charger - 6V (50A), 12V (50A), and 24V (25A) - for lead-acid automotive, marine and deep-cycle batteries, including flooded, gel, AGM and maintenance-free, plus lithium-ion batteries
 - Designed for pros who need absolute performance and uncompromising functionality. Featuring ultra-flexible silicone cabling - down to -40 degree F - with protective nylon braided shielding for maximum protection against abrasion.
 - A dual-voltage power supply - 12V (50A) and 24V (25A) - to maintain constant power delivery without unwanted ripple, noise and transient spikes during ECU flashing, reprogramming and diagnostic testing.
 - An integrated thermal sensor detects the ambient temperature and alters the charge to eliminate over-charging in hot climates and under-charging in cold climates to maximize battery life and enable fast charging.
 - Detects batteries as low as 1V or use the all-new Force Mode that allows you to manually begin charging dead batteries down to zero volts.
 - Automatically detects battery sulfation and acid stratification to restore lost battery performance for stronger engine starts and extended battery life. Plus, cutting edge battery repair modes for 6V, 12V and 24V batteries.
 - 6V/12V up to 2000A hours and 24V up to 1000A hours.
- Size: 12.3" X 6.9" X 3.6"



A-GENIUS2X2

4A 2-Bank Battery Charger

- 6V & 12V 2-Bank, 4-Amp Smart Battery Charger
 - A two-bank battery charger maintainer rated a 4A - 2A per bank with a 40Ah capacity range - designed to charge and maintain multiple vehicles like cars, motorcycles, boats, ATVs and more.
 - Charges dead batteries as low as 1V or use the all-new Force Mode that allows you to take control and manually begin charging dead batteries down to zero volts.
 - An integrated thermal sensor detects the ambient temperature and alters the charge to eliminate over-charging in hot climates and under-charging in cold climates.
 - It's not just a trickle charger; it's an advanced battery maintainer. A fully automatic, worry-free battery charger for everyday use - 24/7 - with zero overcharge.
 - Charges batteries up to 40A hours
- Size: 4.4" X 5.2" X 1.9"

Parts are not Original Equipment parts and are not sponsored, affiliated or otherwise connected with any major brand.



A-GENIUS2X4 8A 4-Bank Battery Charger

- 6V & 12V 4-Bank, 8-Amp Smart Battery Charger
 - A four-bank battery charger maintainer rated a 8A - 2A per bank with a 40Ah capacity range - designed to charge and maintain multiple vehicles like cars, motorcycles, boats, ATVs, RVs, lawn mowers, trucks and more.
 - Charges dead batteries as low as 1V or use the all-new Force Mode that allows you to take control and manually begin charging dead batteries down to zero volts.
 - An integrated thermal sensor detects the ambient temperature and alters the charge to eliminate over-charging in hot climates and under-charging in cold climates.
 - It's not just a trickle charger; it's an advanced battery maintainer. A fully automatic, worry-free battery charger for everyday use - 24/7 - with zero overcharge.
 - Charges batteries up to 40A hours
- Size: 5.7" X 9.4" X 2.3"



A-GC002 Eyelet Terminal Connector

- X-Connect Eyelet Terminal allows a battery charger to connect quickly to any battery. Replace a lost connector or permanently mount one on your motorcycle, ATV, snowmobile, person watercraft, lawn mower and more for easy charging.
- Permanently mount a battery connection to any battery.
- Lie-flat design for seamless installations with M6 (1/4-inch) hole size.
- Built-in fuse protection for increased safety.
- More ways to charge with plug-n-play accessory changes.
- Rugged, watertight connector for extreme environments.
- For larger battery applications, use the GC008 XL Eyelet Connector with a M10 (3/8-inch) hole size.
- Compatible with All New Genius Chargers: Genius1, Genius2, Genius3, Genius5, Genius10, Genius2x2, Genius2x4.



A-GBC002 Boost Precision Clamps

- Needle-nose replacement battery clamps
- Removeable cables from clamps so you can install eyelets onto battery
- Compatible with the NOCO GB20, GB40 and GB50 Jump Starters



A-GC004 10" Extension Cable

- Extend the reach of your battery charger and accessories.
- Add an additional 10 feet of length to any connection.
- Ergonomically Designed; makes battery connecting and disconnecting effortless.
- More ways to charge with plug-n-play accessory changes.
- Rugged, watertight connector for extreme environments.
- X-Connect 10' Extension Cable, compatible with GENIUS2-GENIUS10 battery chargers.



A-GBC004 Boost Max 24-Inch Cable Clamps

- 24" long 2/0 AWG cables with HD Clamps
- Compatible with the NOCO GB500 Jump Starters



A-GBC005 Boost Max 72-Inch Cable Clamps

- 72" long 2/0 AWG cables with HD Clamps for longer reach
- Compatible with the NOCO GB500 Jump Starters

Parts are not Original Equipment parts and are not sponsored, affiliated or otherwise connected with any major brand.



A-GC008

XL Eyelet Terminal Connector, 22.5"

- XL Eyelet Terminal Connector; permanently mount to large batteries with 3/8 inch terminals.
- Lie-flat design for seamless installations with M10 (3/8-inch) hole size.
- Built-in fuse protection for increased safety.
- More ways to charge with plug-n-play accessory changes.
- Rugged, watertight connector for extreme environments.
- X-Connect 10' Extension Cable, compatible with GENIUS2-GENIUS10 battery chargers.



A-GPA001

HD 10' Extension Cable

- Maximize the reach of your battery charger and accessories.
- Add an additional 10 feet of length to any GENIUSPRO25 HD connection.
- 8-Gauge ultra flexible silicon cabling - for temperatures down to -40 degree F.
- Protective nylon braided shielding for maximum protection against abrasion.
- Compatible with NOCO GENIUSPRO25 Battery Charger and NOCO GPA002 Battery Clamps
- Compatible with GENPRO25 and GPA002.



A-GC014

XL Battery Clamp Connector, 25"

- Battery Clamps with M10 Eyelets; easily connect and disconnect from any battery.
- High-output battery clamps with molded strain relief.
- Built-in 20A fuse protection from increased safety.
- Built-in M10 eyelet connectors for mounting purposes.
- A wider 1.5-inch clamping span can accommodate larger terminals.
- Rugged, watertight connector for extreme environments.
- Compatible with GENIUS1 -GENIUS10 battery chargers.



A-GPA002

HD Battery Clamps with Eyelets

- Improved clamping range - Genius clamps are built with a needle-nose profile for smaller terminal applications.
- 8-Gauge ultra flexible silicon cabling down to -40 degree F.
- Protective nylon braided shielding for maximum protection against abrasion.
- Built-in 35A ANL fuse for increased safety and protection.
- Detachable integrated M10 eyelets for permanent battery-mounted solutions.
- Compatible with GENPRO25 and GPA001.



A-XGC4

56W XGC Power Adapter

- 56-Watt Rapid Charger for NOCO GB70, GB150 and GB500 Jump Starters
- Charges 5 times faster than traditional 2A wall chargers



A-GPA003

Pro 10' Extension Cable

- Maximize the reach of your battery charger and accessories
- Add an additional 10 feet of length to any GENIUS-PRO50 PRO connection.
- 5-Gauge ultra flexible silicon cabling - for temperatures down to -40 degree F.
- Protective nylon braided shielding for maximum protection against abrasion.
- Compatible with NOCO GENPRO50 Battery Charger and NOCO GPA004 Battery Clamps

Parts are not Original Equipment parts and are not sponsored, affiliated or otherwise connected with any major brand.



A-GPA004

Pro Battery Clamps with Eyelets

- Improved clamping range - Genius clamps are built with a needle-nose profile for smaller terminal applications.
- 5-Gauge ultra flexible silicon cabling down to -40 degree F.
- Protective nylon braided shielding for maximum protection against abrasion.
- Built-in 60A ANL fuse for increased safety and protection.
- Detachable integrated M10 eyelets for permanent battery-mounted solutions.
- Compatible with GENPRO50 and GPA003.



A-GBC015

Boost Pro EVA Protection Case

- Rubberized EVA Storage Case for the NOCO GB150 Jump Starters
- Equipped with zipper closure and reinforced handle for storage and carrying
- Protection from moisture, impact, dust and environmental factors



A-GBC013

Boost Sport/Plus EVA Protection Case

- Rubberized EVA Storage Case for the NOCO GB20 or GB40 Jump Starters
- Equipped with zipper closure and reinforced handle for storage and carrying
- Protection from moisture, impact, dust and environmental factors



A-GBC016

Boost Max EVA Protection Case

- Storage and Carrying Case for the NOCO GB500 Jump Starters
- Reinforced handle and shoulder carrying strap
- Lightweight, durable, custom exterior with interior pocket for more storage
- Protection from moisture, impact, dust and environmental factors



A-GBC014

Boost HD EVA Protection Case

- Rubberized EVA Storage Case for the NOCO GB70 Jump Starters
- Equipped with zipper closure and reinforced handle for storage and carrying
- Protection from moisture, impact, dust and environmental factors



A-GBC017

Boost XL EVA Protection Case

- Rubberized EVA Storage Case for the NOCO GB50 Jump Starters
- Equipped with zipper closure and reinforced handle for storage and carrying
- Protection from moisture, impact, dust and environmental factors

Parts are not Original Equipment parts and are not sponsored, affiliated or otherwise connected with any major brand.



A-FH316R **Hose, Fuel; 3/16", Rubber (65 Ft. Roll)**
 Priced per roll
 For gas & diesel applications
 Burst Pressure: 435
 Working Pressure: 145

A-FH316B **Hose, Fuel; 3/16", Braided Cover (52 Ft. Roll)**
 Priced per roll
 For gas & diesel applications
 Burst Pressure: 435
 Working Pressure: 145

A-FH14R **Hose, Fuel; 1/4", Rubber (32 Ft. Roll)**
 Priced per roll
 For gas & diesel applications
 Burst Pressure: 435
 Working Pressure: 145

A-FH14B **Hose, Fuel; 1/4", Braided Cover (49 Ft. Roll)**
 Priced per roll
 For gas & diesel applications
 Burst Pressure: 435
 Working Pressure: 145

A-FH516R **Hose, Fuel; 5/16", Rubber (32 Ft. Roll)**
 Priced per roll
 For gas & diesel applications
 Burst Pressure: 435
 Working Pressure: 145

A-FH516B **Hose, Fuel; 5/16", Braided Cover (32 Ft. Roll)**
 Priced per roll
 For gas & diesel applications
 Burst Pressure: 435
 Working Pressure: 145

A-FH38R **Hose, Fuel; 3/8", Rubber (19 Ft. Roll)**
 Priced per roll
 For gas & diesel applications
 Burst Pressure: 435
 Working Pressure: 145

A-FH38B **Hose, Fuel; 3/8", Braided Cover (22 Ft. Roll)**
 Priced per roll
 For gas & diesel applications
 Burst Pressure: 435
 Working Pressure: 145

A-FH12R **Hose, Fuel; 1/2", Rubber (49 Ft. Roll)**
 Priced per roll
 For gas & diesel applications
 Burst Pressure: 435
 Working Pressure: 145

A-FH12B **Hose, Fuel; 1/2", Braided (49 Ft. Roll)**
 Priced per roll
 For gas & diesel applications

A-FH58R **Hose, Fuel; 5/8", Rubber (32 Ft. Roll)**
 Priced per roll
 Notes 2: For gas & diesel applications

A-FH58B **Hose, Fuel; 5/8", Braided (32 Ft. Roll)**
 Priced per roll
 For gas & diesel applications

A-FH34R **Hose, Fuel; 3/4", Rubber (65 Ft. Roll)**
 Priced per roll
 For gas & diesel applications
 Burst Pressure: 435 PSI
 Working Pressure: 145 PSI

A-FH1B **Hose, Fuel; 1", Braided (16 Ft. Roll)**
 Priced per roll
 For gas & diesel applications

A-FH1R **Hose, Fuel; 1", Rubber (16 Ft. Roll)**
 Priced per roll
 For gas & diesel applications

Parts are not Original Equipment parts and are not sponsored, affiliated or otherwise connected with any major brand.

Accessories Content

Coolant Tank Heaters	116-117
Hitch Balls	119
SMV Signs & Parts	120
Steering Wheel Spinners	121
Tool Box	120
Trailer Jacks & Parts	117-118
Umbrellas, Buggy Tops & Parts	119-120

Click to go back to top



ACCESSORIES

Coolant Tank Heaters



A-5B850 Heater, Tank
 Volt/Amperage: 120/7
 Capacity: up to 18 qts
 Inlet: 5/8"
 Outlet: 5/8"
 Wattage: 850

A-5B1000 Heater, Tank
 Volt/Amperage: 120/8.3
 Capacity: 16-25 Qts
 Inlet: 5/8"
 Outlet: 5/8"
 Wattage: 1000

A-5B1500 Heater, Tank
 Thermostatically Controlled From 135 To 175 Degrees
 Die Cast Aluminum Design For Corrosion And Impact Resistance
 Volt/Amperage: 120/12.5
 Capacity: 26-40 Qts
 Inlet: 5/8"
 Outlet: 5/8"
 Wattage: 1500



A-5B671 Heater, Engine Block Frost Plug (2")
 Forged Brass Body
 Positive Locking Assembly
 O-Ring Seal
 Long Life
 Wattage: 600

A-5B681 Heater, Engine Block Frost Plug (2")
 Forged Brass Body
 Positive Locking Assembly
 O-Ring Seal
 Long Life
 Wattage: 1000



A-5B2163 Cord, Replacement for 400 Watt (3 Terminal)



A-5B357 Heater, Engine Block Frost Plug w/ 1/2" NPT

A-5B360 Heater, Engine Block Frost Plug w/ 3/4" NPT
 Wattage: 400

A-5B362 Heater, Engine Block Frost Plug w/ 1" NPT

A-5B611 Heater, Engine Block Frost Plug (1 1/2")
 Forged Brass Body
 Positive Locking Assembly
 O-Ring Seal
 Long Life
 Wattage: 600

A-5B631 Heater, Engine Block Frost Plug (1 5/8")
 Forged Brass Body
 Positive Locking Assembly
 O-Ring Seal
 Long Life
 Wattage: 600

A-5B641 Heater, Engine Block Frost Plug (1-3/4")
 Forged Brass Body
 Positive Locking Assembly
 O-Ring Seal
 Long Life
 Wattage: 600



A-5B125 Heater, Radiator Hose, Lower (1 1/4")
 Die Cast Aluminum Body
 Heavy Duty 3 Wire Cord
 Wattage: 600

A-5B15 Heater, Radiator Hose, Lower (1 1/2")
 Do not install on diesel engine w/o by-pass in water pump.
 Die Cast Aluminum Body
 Heavy Duty 3 Wire Cord
 Wattage: 600

A-5B17 Heater, Radiator Hose, Lower (1 3/4")
 Do not install on diesel engine w/o by-pass in water pump.
 Die Cast Aluminum Body
 Heavy Duty 3 Wire Cord
 Wattage: 600

A-5B20 Heater, Radiator Hose, Lower (2")
 Die Cast Aluminum Body
 Heavy Duty 3 Wire Cord
 Wattage: 600

Parts are not Original Equipment parts and are not sponsored, affiliated or otherwise connected with any major brand.

ACCESSORIES

Coolant Tank Heaters - Trailer Jacks & Parts

Parts are not Original Equipment parts and are not sponsored, affiliated or otherwise connected with any major brand.



A-5B1501 **Magnetic Heater (2-1/4" x 3-3/4")**
110v AC
Wattage: 200

A-5B1502 **Magnetic Heater (3" x 5")**
110v AC
Wattage: 300



A-5B201 **Heater, Dipstick (23")**



A-15A175 **Jack, Trailer & Imp., A-Frame Mount (5000 Lb.)**
12-1/2" Mounting Height, 14-3/4" Travel. Less Disc Foot

A-15A181 **Optional Detachable Foot For 15A175 Jack**



A-VLA2066 **Jack, Sidewind Trailer & Imp., Tube Mount (2000 Lb.)**
Includes weld-on mounting tube
Overall Height: 22"
Mounting Height: 14.5"
Travel: 15"

A-VLA2071 **Jack, Sidewind Trailer & Imp., Tube Mount (2000 Lb.)**
Includes weld-on mounting tube
Overall Height: 14.5"
Travel: 10"



A-15A158L **Jack, Trailer & Imp., Four Position Swivel Tube Mount (2000 Lb.)**



A-15A158S **Jack, Trailer & Imp., Four Position Swivel Tube Mount (2000 Lb.)**
Includes: 5/8" Pin



A-VLA2070 **Jack, Weld On Sidewind (7000 Lb.)**



A-VLA2057 **Detachable Caster**
1000 LB static load capacity
6"x2" reinforced poly wheel
zinc plated



A-VLA2056 **Detachable Foot**
8" Long
zinc plated



A-15A15273 **Tongue Mounting Bracket For 15A158L & 15A158S**
Outside Diameter: 2"

ACCESSORIES

Trailer Jacks & Parts



A-15A402 Pin & Chain For 15A158L & 15A158S
Pin Diameter: 9/16" x 3 1/2"

A-500231 Pin & Chain, Implement Jack
Length: 3.500"
Heading: Used With A-15A158L Implement Jack.
Diameter: .625"

A-15A400 Pin, Plunger for 15A151, 151 SW, 152 & 171



A-15A197 Handle w/ Pin For 15A151, 152, 158L, 158S, 171 & 175.



A-15A909 Mtg. Plate For 15A151, 151SW & 171



A-15A904 Snap Ring For 15A151, 151SW, 152 & 171



A-47V5000 Jack, Steel (48")
Steel Handle w/ Hardened Steel Pins
Lift Pins Made Of Hardened Steel
Lifting Knee Reinforced For Extra Protection
Large Foot Has 28 SQ. In Surface
All Pins & Bolts Plated For Protection Against Rust
Handle Latch Holds Handle In Upright Position



A-47V5011 Repair Kit For 47V5000



A-VLA2054 Jack, Top Wind (5000 Lb.)
20.25" Overall Height
15" Bracket Height
2" Tube Mounting Diameter
30" Max Working Height



A-15A151 Jack, Trailer & Imp., Weld-on Swivel Brkt (2000 Lb.)
9" Mounting Height, 10" Travel

A-15A171 Jack, Trailer & Imp., Weld-on Swivel Brkt (5000 Lb.)
9" Mounting Height, 10" Travel



A-15A151SW Jack, Trailer & Imp., Weld-on Swivel Brkt (2000 Lb.)
9" Mounting Height, 10" Travel

Parts are not Original Equipment parts and are not sponsored, affiliated or otherwise connected with any major brand.

ACCESSORIES

Hitch Balls - Umbrellas & Buggy Tops



Parts are not Original Equipment parts and are not sponsored, affiliated or otherwise connected with any major brand.

A-7A5301 **Ball, Cold Forged Hitch**
 2000 LB. Load Capacity
 1 3/4" Stud Length
 Chrome Plated
 Diameter: 1 7/8"
 Thread Size: 3/4"

A-7A5302 **Ball, Cold Forged Hitch**
 3000 Lb. Load Capacity
 1 3/4" Stud Length
 Chrome Plated
 Diameter: 2"
 Thread Size: 3/4"

A-7A5203 **Ball, Cold Forged Hitch**
 5000 LB Load Capacity
 1 3/4" Stud Length
 Chrome Plated
 Diameter: 2"
 Thread Size: 1"

A-7A5204 **Ball, Cold Forged Hitch**
 10,000 LB Load Capacity
 2 1/8" Stud Length
 Zinc Plated
 Diameter: 2 5/16"
 Thread Size: 1 1/4"



A-6A50 **Umbrella, White**

- Provides maximum space for standing operator.
- Tilts to any angle, forward, backward, or to either side.
- Folds to one side when not in use.
- Complete umbrella consists of cover, frame & universal mount bracket.
- Shafts constructed of 1 1/4" heavy-duty steel tubing.
- Rigid framework for cover, withstands farm and industrial use.

A-6A50C **Replacement Cover, White**

A-6A51 **Umbrella, Red**

- Provides maximum space for standing operator.
- Tilts to any angle, forward, backward, or to either side.
- Folds to one side when not in use.
- Complete umbrella consists of cover, frame & universal mount bracket.
- Shafts constructed of 1 1/4" heavy-duty steel tubing.
- Rigid framework for cover, withstands farm and industrial use.

A-6A51C **Replacement Cover, Red**

A-6A52 **Umbrella, Yellow**

- Provides maximum space for standing operator.
- Tilts to any angle, forward, backward, or to either side.
- Folds to one side when not in use.
- Complete umbrella consists of cover, frame & universal mount bracket.
- Shafts constructed of 1 1/4" heavy-duty steel tubing.
- Rigid framework for cover, withstands farm and industrial use.

A-6A52C **Replacement Cover, Yellow**

A-VLD5050 **Umbrella, Blue**

- Provides maximum space for standing operator.
- Tilts to any angle, forward, backward, or to either side.
- Folds to one side when not in use.
- Complete umbrella consists of cover, frame & universal mount bracket.
- Shafts constructed of 1 1/4" heavy-duty steel tubing.
- Rigid framework for cover, withstands farm and industrial use.

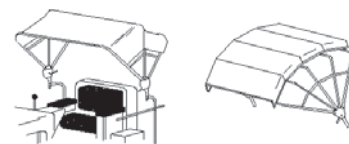

A-6A220 **Buggy Top, 3 Bow (40") White**
A-6A223 **Replacement Cover, 3 Bow (40") White**
A-6A230 **Buggy Top, 3 Bow (48") White**
A-6A233 **Replacement Cover, 3 Bow (48") White**

A-6A222 **Buggy Top, 3 Bow (40") Yellow**
A-6A225 **Replacement Cover, 3 Bow (40") Yellow**
A-6A232 **Buggy Top, 3 Bow (48") Yellow**
A-6A235 **Replacement Cover, 3 Bow (48") Yellow**

A-VLD5052 **Buggy Top, 3 Bow (40") Blue**
 Mounting bracket sold separately.

A-VLD5055 **Replacement Cover, 3 Bow (48") Blue**

ACCESSORIES

Umbrella & Buggy Top Parts - Tool Box & SMV Signs

A-6A224 Replacement Cover, 3 Bow (40") Red

A-6A234 Replacement Cover, 3 Bow (48") Red

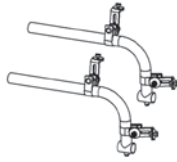

A-6A216 Bracket Set, Fender Mount (40" or 48")

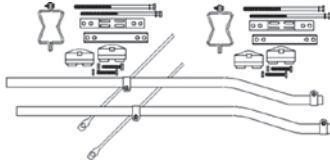

A-6A217 Bracket, Axle Mount (40" or 48")



A-VLD1532 Bonnet Catch,(2 Pack)



A-47V1535 Cable, T Handle Pull (82")



A-47V1534 Cable, Round Handle Pull (82")



A-5A3BL Tool Box, Black Metal
16 1/4" X 4 3/4" X 5"

A-5A3OR Tool Box, Orange Metal
16 1/4" X 4 3/4" X 5"

A-5A3BU Tool Box, Blue Metal
16 1/4" X 4 3/4" X 5"

A-5A3R Tool Box, Red
16 1/4" X 4 3/4" X 5"



A-6A60 **SMV Sign, New Style Metal**
Center yellow/orange triangle visible by day. Safety red border glows in headlight beams at night. Meets all state requirements, ASAE & SAE standards - S276.7.

A-6A61 **SMV Sign, Adhesive Decal**

A-6A68 **SMV Sign, New Style Plastic**



A-6A64 **SMV Sign Mount, Spade**
PKG QTY: minimum order qty 4



A-6A63 **SMV Sign Mount, Pole**
PKG QTY: minimum order qty 4



A-6A62 **SMV Sign Mounting Socket**
PKG QTY: minimum order qty 4

Parts are not Original Equipment parts and are not sponsored, affiliated or otherwise connected with any major brand.



- A-5A6 Spinner, Aluminum Steering Wheel (Polished Aluminum Knob)
 - A-5A6BL Spinner, Aluminum Steering Wheel (black plastic coated knob)
 - A-5A6YL Spinner, Aluminum Steering Wheel (yellow plastic coated knob)
 - A-5A6G Spinner, Aluminum Steering Wheel (green plastic coated knob)
 - A-5A6BU Spinner, Aluminum Steering Wheel (blue plastic coated knob)
 - A-5A6R Spinner, Aluminum Steering Wheel (red plastic coated knob)
-



- A-5A612 **Spinner Display**
Includes: 12 Weather Proof Aluminum Steel Ball Bearing Spinners w/ Display
-

Parts are not Original Equipment parts and are not sponsored, affiliated or otherwise connected with any major brand.

Wheel Rims / Hub & Spindle Assemblies Content

Hubs & Spindles and Related Parts	124-127
Wheel Rims, Bolts & Nuts	123

 Click to go back to top

WHEEL RIMS

Wheel Rims, Bolts & Nuts



WHEEL RIMS

Parts are not Original Equipment parts and are not sponsored, affiliated or otherwise connected with any major brand.

PART	DESCRIPTION	C to C Of Lugs Across Rim	Lugs
A-RW08244	Rim, Rear Wheel 8" x 24"	20"	4
A-RW09244	Rim, Rear Wheel 9" x 24"	20"	4
A-RW09286	Rim, Rear Wheel 9" x 28"	23.875"	6
A-RW10244	Rim, Rear Wheel 10" x 24"	20"	4
A-RW10286	Rim, Rear Wheel 10" x 28"	24"	6
A-RW1028B	Rim, Rear Wheel 10" x 28"	Blank Center	0
A-RW11286	Rim, Rear Wheel 11" x 28"	24"	6
A-RW12246	Rim, Rear Wheel 12" x 24"	20"	6
A-RW12286	Rim, Rear Wheel 12" x 28"	24"	6
A-RW12368	Rim, Rear Wheel 12" x 36"	32.25"	8
A-RW13288	Rim, Rear Wheel 13" x 28"	24.5"	8

PART	DESCRIPTION	Bolt Circle	Lugs	Pilot Hole	Size
A-RD28642	Disc, Rear Rim Wheel	6"	8	4.250"	28"
A-RD28606	Disc, Rear Rim Wheel	8"	8	6"	

PART	DESCRIPTION	Capacity	Lugs	Pilot Hole	Offset
A-98A1454 *	Rim, Front Wheel 5" x 14"	1250 lbs	4	3 5/8"	.250" Negative
A-98A1464 *	Rim, Front Wheel 6" x 14"	1250 lbs	4	3 5/8"	.125" Negative
A-98A1465 *	Rim, Front Wheel 6" x 14"	1800 lbs	5	4"	.125" Negative
A-98A1466 *	Rim, Front Wheel 6" x 14"	2800 lbs	6	4.625"	1.50" Positive
A-98A1544 *	Rim, Front Wheel 6" x 15"	1250 lbs	4	3.625"	.250" Negative
A-98A1565 *	Rim, Front Wheel 6" x 15"	1800 lbs	5	4"	.125" Negative
A-98A1566 *	Rim, Front Wheel 6" x 15"	3000 lbs	6	4.625"	1.375" Positive
A-98A1486 *	Rim, Front Wheel 8" x 14"	2800 lbs	6	4.625"	1.250" Positive
A-98A1585 *	Rim, Front Wheel 8" x 15"	1800 lbs	5	4"	.125" Negative
A-98A1586 *	Rim, Front Wheel 8" x 15"	3800 lbs	6	4.625"	1.50" Positive
A-98A1506 *	Rim, Front Wheel 10" x 15"	3800 lbs	6	4.625"	4.625" Positive
A-FW45166 *	Rim, Front Wheel 4.5" x 16"	2300 lbs	6	4.625"	1.50" Positive
A-FW55166 *	Rim, Front Wheel 5.5" x 16"	3500 lbs	6	4.625"	1.250" Positive
A-FW08166 *	Rim, Front Wheel 8" x 16"	3500 lbs	6	4.625"	1.250" Positive
A-99A44 *	Rim, Front Wheel 8L x 16"	3500 lbs	6	4.625"	.250" Positive
A-99A163 *	Rim, Front Wheel 8L x 16"	3500 lbs	6	4.625"	1.125" Positive
A-99A992 *	Rim, Front Wheel 10L x 16"	3500 lbs	6	4.625"	1.250" Negative
A-99A900 *	Rim, Front Wheel 10L x 16"	6000 lbs	8	6"	.50" Negative

PART	DESCRIPTION	Overall Length	Thread	Thread Length	PKG QTY
A-WB916	Bolt, Front Wheel	1.81"	9/16" - 18 UNF	1.12"	minimum order qty 10
A-98A569N	Stud Nut				
A-WB12	Bolt, Front Wheel	1.50"	1/2" - 20 UNF	1.00"	minimum order qty 10
A-SD12	Stud, Front Wheel	2.08"	1/2" - 20 UNF	1.52"	minimum order qty 10
A-NT12	Nut, Front Wheel	.63"	1/2" - 20 UNF	.63"	minimum order qty 10

*Capacity based on 20 MPH max speed.

*The offset is determined by the location & distance of the center disc in relation to the centerline of the rim. Ref. C shown in the drawing is an example of positive offset. See attributes for each item to identify the offset.

HUB & SPINDLE ASSEMBLIES

Hubs & Spindles and Related Parts

A-AN183318 Hub Assembly
Replaces: AN150825

10 Lbs.

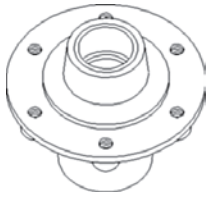

A-WBKJD25 Wheel Bearing Kit

1 Lbs.

For Models: John Deere (GRAIN DRILL: 730, 735, 737, 770, 1690, 1810, 1820, 1890, 1895, 1990, 1840), (PLOW, CHISEL: 610, 680, 685, 1610, 1650, 2400, 2410), (CULTIVATOR: 856, 875, 885, 886, 960, 980, 985, 1050, 1060, 2200, 2210), (HEAD, CUTTING PLATFORM: 930, 936D), (DISC HARROW: 620, 621, 627, 630, 635, 637, 640, 650, 670, 970), (RIPPER: 510, 512, 915, 955, 2100), (FLAIL MOWER: 100 SERIES, 200 SERIES, 520 SERIES), (MULCHER/FINISHER: 550, 714, 722, 724, 726, 2700), (OFFSET DISC: 355), (PLOW: 965, 995, 2810, 3710), (PLANTER: 610, 655, 665, 1700, 1720, 1730, 7300, 7340), (RIDING MOWER: 112), (SEEDBED FINISHER: 200), (SWATHER/WINDROWER: 4895, 4995)

A-HS125044 Hub & Spindle Assy. (4 Bolt)
4 Bolt On 4.00" Circle - (2.500" Hub Pilot)
Rated at 1250 lb capacity @ 55 mph.

9 Lbs.

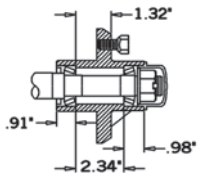

Dim/Info:

Inner Cup: L44610
Inner Cone: L44643
Outer Cup: L44610
Outer Cone: L44643
Hub Cap: HC105
Hub w/ Cups, Cones, Seal,
Lug Bolts, Spindle, Hdwe,
Dust Cap.

A-HS125044HK Hub Kit L/Spindle

6 Lbs.

A-H125044 Hub W/ Cups

5 Lbs.

A-SP12504 Spindle

2 Lbs.

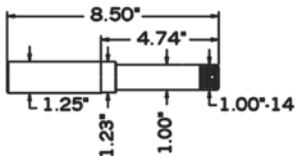

For Models: SEVERAL

A-HS125045 Hub & Spindle Assy. (4 Bolt)
4 Bolt On 5.00" Circle - (3.625" Hub Pilot)
Rated at 1250 lbs capacity @ 20 mph.

13 Lbs.

Replaces: French & Hecht - 104064

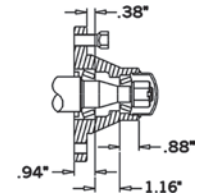

Dim/Info:

Inner Cup: LM67010
Inner Cone: LM67048
Outer Cup: LM11910
Outer Cone: LM11949
Hub Cap: HC101
Hub w/ Cups, Cones, Seal,
Lug Bolts, Spindle, Hdwe,
Dust Cap.

A-HS125045HK Hub Kit L/Spindle

7 Lbs.

A-H12504 Hub W/ Cups

6 Lbs.

A-SP1250 Spindle

5 Lbs.

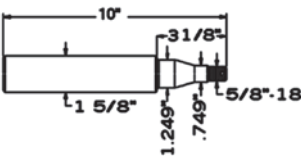

For Models: SEVERAL

A-HS130045 Hub & Spindle Assy. (4 Bolt)
4 Bolt On 5.00" Circle - (3.625" Hub Pilot)
Rated at 1300 lb capacity @ 20 mph.

7 Lbs.

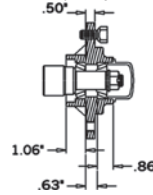

Dim/Info:

Inner Cup: L44610
Inner Cone: L44643
Outer Cup: L44610
Outer Cone: L44643
Bolts: WB12 (4)
Hub w/ Cups, Cones, Seal,
Lug Bolts, Spindle, Hdwe,
Dust Cap.

A-HS130045HK Hub Kit L/Spindle

6 Lbs.

A-H13004 Hub W/ Cups

5 Lbs.

A-SP1300 Spindle

1 Lbs.

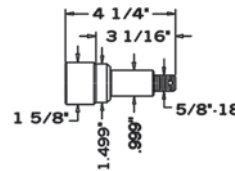

For Models: SEVERAL

A-HS150045 Hub & Spindle Assy. (4 Bolt)
4 Bolt On 5.00" Circle - (3.625" Hub Pilot)
Rated at 1500 lbs. capacity @ 20 mph

15 Lbs.

Replaces: Electric Wheel - Q633

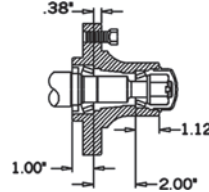

Dim/Info:

Inner Cup: LM67010
Inner Cone: LM67048
Outer Cup: LM11910
Outer Cone: LM11949
Hub Cap: HC103
Hub w/ Cups, Cones, Seal,
Lug Bolts, Spindle, Hdwe,
Dust Cap.

A-HS150045HK Hub Kit L/Spindle

10 Lbs.

A-H15004 Hub W/ Cups

8 Lbs.

A-SP1650 Spindle

5 Lbs.

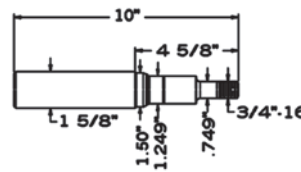

For Models: SEVERAL

A-HS16505S55 Hub & Spindle Assy. (5 Stud)
5 Studs On 5.500" Circle - (4.00" Hub Pilot)
Rated at 1650 lb capacity @ 20 mph.

15 Lbs.

Replaces: Electric Wheel - Q736

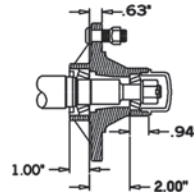

Dim/Info:

Inner Cup: LM67010
Inner Cone: LM67048
Outer Cup: LM11910
Outer Cone: LM11949
Studs: SD12 / Nuts: NT12
Hub Cap: HC101

A-HS16505S55HK Hub Kit L/Spindle

10 Lbs.

A-H16505 Hub

8 Lbs.

A-SP1650 Spindle

5 Lbs.

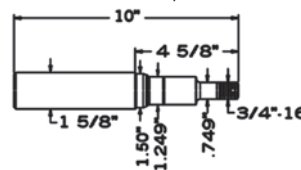

For Models: SEVERAL

Parts are not Original Equipment parts and are not sponsored, affiliated or otherwise connected with any major brand.

HUB & SPINDLE ASSEMBLIES

Hubs & Spindles and Related Parts

Parts are not Original Equipment parts and are not sponsored, affiliated or otherwise connected with any major brand.

A-HS1750545 Hub & Spindle Assy. (5 Bolt) 12 Lbs.

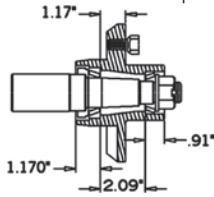

Dim/Info:
 Inner Cup: L68111
 Inner Cone: L68149
 Outer Cup: L44610
 Outer Cone: L44649
 Hub Cap: HC105
 Hub w/ Cups, Cones, Seal,
 Lug Bolts, Spindle, Hdwe,
 Dust Cap.

A-HS1750545HK Hub Kit L/Spindle 9 Lbs.

A-H17505 Hub W/ Cups 6 Lbs.

A-SP1750 Spindle 4 Lbs.

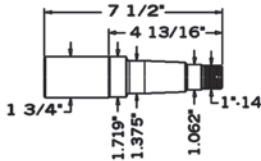

For Models: SEVERAL

A-HS20006S6 Hub & Spindle Assy. (6 Stud) 18 Lbs.

6 Stud On 6.00" Circle (4.625" Hub Pilot)
 Rated at 2500 lb capacity @ 20 mph.

Replaces: French & Hecht - 105480

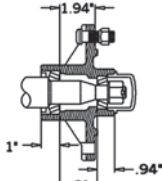

Dim/Info:
 Inner Cup: LM67010
 Inner Cone: LM67048
 Outer Cup: LM11910
 Outer Cone: LM11949
 Studs: SD12 / Nuts: NT12
 Hub Cap: HC101

A-HS20006S6HK Hub Kit L/Spindle 12 Lbs.

A-H20006 Hubs W/ Cups 10 Lbs.

A-SP2000 Spindle 4 Lbs.

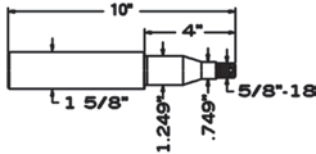

For Models: SEVERAL

A-HS2500555 Hub & Spindle Assy. (5 Bolt) 23 Lbs.

5 Bolt On 5.500" Circle - (4.00" Hub Pilot)
 Rated at 2500 lb capacity @ 20 mph.

Replaces: French & Hecht - 104683

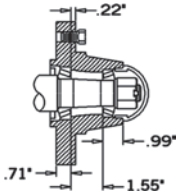

Dim/Info:
 Inner Cup: LM48510
 Inner Cone: LM48548
 Outer Cup: LM67010
 Outer Cone: LM67048
 Hub Cap: HC102
 Hub w/ Cups, Cones, Seal,
 Lug Bolts, Spindle, Hdwe,
 Dust Cap.

A-HS2500555HK Hub Kit L/Spindle 13 Lbs.

A-H25005B Hub W/ Cups 10 Lbs.

A-SP25005 Spindle 9 Lbs.

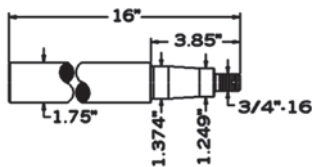

For Models: SEVERAL

A-HS25006S6 Hub & Spindle Assy. (6 Stud) 24 Lbs.

6 Stud On 6.00" Circle - (4.625" Hub Pilot)
 Rated at 2500 lb capacity @ 20 mph.

Replaces: French & Hecht - 106675

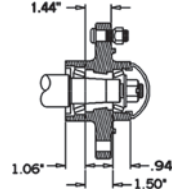

Dim/Info:
 Inner Cup: LM48510
 Inner Cone: LM48548
 Outer Cup: LM67010
 Outer Cone: LM67048
 Seal: CR17617
 Studs: SD12 / Nuts: NT12

A-HS25006S6HK Hub Kit L/Spindle 13 Lbs.

A-H25006 Hub W/ Cups 11 Lbs.

A-SP2500 Spindle 9 Lbs.

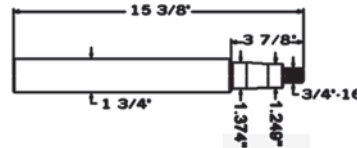

For Models: SEVERAL

A-HS27605S55 Hub & Spindle Assy. (5 Stud) 21 Lbs.

5 Stud On 5.500" Circle - (4.00" Hub Pilot)
 Rated at 2760 lb capacity @ 20 mph.

Replaces: Electric Wheel - Q719

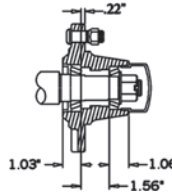

Dim/Info:
 Inner Cup: LM48510
 Inner Cone: LM48548
 Outer Cup: LM67010
 Outer Cone: LM67048
 Studs: SD12 / Nuts: NT12
 Hub Cap: HC102

A-HS27605S55HK Hub Kit L/Spindle 7 Lbs.

A-H27605 Hub W/ Cups 10 Lbs.

A-SP2760 Spindle 8 Lbs.

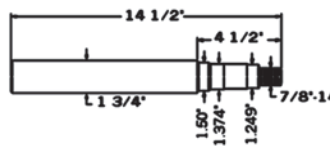

For Models: SEVERAL

A-HS276066 Hub & Spindle Assy. (6 Bolt) 22 Lbs.

6 Bolt On 6.00" Circle - (4.625" Hub Pilot)
 Rated at 2760 lb capacity @ 20 mph.

Replaces: Electric Wheel - Q709

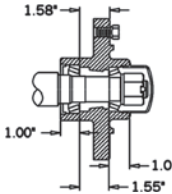

Dim/Info:
 Inner Cup: LM48510
 Inner Cone: LM48548
 Outer Cup: LM67010
 Outer Cone: LM67048
 Hub Cap: HC102
 Hub w/ Cups, Cones, Seal,
 Lug Bolts, Spindle, Hdwe,
 Dust Cap.

A-HS276066HK Hub Kit L/Spindle 12 Lbs.

A-H27606 Hub W/ Cups 11 Lbs.

A-SP2760 Spindle 8 Lbs.

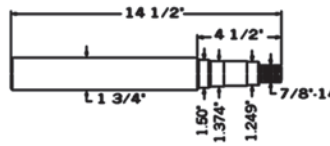

For Models: SEVERAL

HUB & SPINDLE ASSEMBLIES

Hubs & Spindles and Related Parts

A-HS30006S6 Hub & Spindle Assy. (6 Bolt) 24 Lbs.
 6 Bolt On 6.00" Circle - (4.625" Hub Pilot)
 Rated at 3000 lb capacity @ 20 mph.

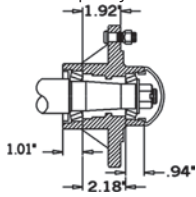

Dim/Info:
 Inner Cup: LM29710
 Inner Cone: LM29749
 Outer Cup: LM67010
 Outer Cone: LM67048
 Hub Cap: HC102
 Hub w/ Cups, Cones, Seal,
 Bolts, Spindle, Hdwe, Dust
 Cap.

A-HS450088 Hub & Spindle Assy. (8 Bolt) 41 Lbs.
 8 Bolt On 8.00" Circle - (6.00" Hub Pilot)
 Rated at 4500 lb capacity @ 20 mph.

Replaces: French & Hecht - 106799

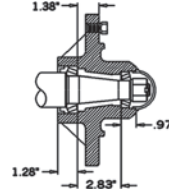

Dim/Info:
 Inner Cup: LM603011
 Inner Cone: LM603049
 Outer Cup: LM67010
 Outer Cone: LM67048
 Hub Cap: HC102
 Hub w/ Cups, Cones, Seal,
 Lug Bolts, Spindle, Hdwe,
 Dust Cap.

A-HS30006S6HK Hub Kit L/Spindle 13 Lbs.
A-H30006 Hub W/ Cups 11 Lbs.
A-SP3000 Spindle 7 Lbs.

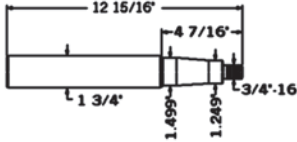

For Models: SEVERAL

A-HS350066 Hub & Spindle Assy. (6 Bolt) 29 Lbs.
 6 Bolt On 6.00" Circle - (4.625" Hub Pilot)
 Rated at 3500 lb capacity @ 20 mph.

Replaces: French & Hecht - 106164

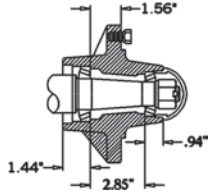

Dim/Info:
 Inner Cup: LM501310
 Inner Cone: LM501349
 Outer Cup: LM67010
 Outer Cone: LM67048
 Hub Cap: HC102
 Hub w/ Cups, Cones, Seal,
 Lug Bolts, Spindle, Hdwe,
 Dust Cap.

A-H45008 Hub W/ Cups 25 Lbs.
A-SP4500 Spindle 12 Lbs.

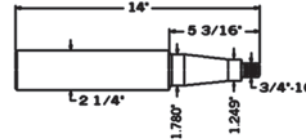

For Models: SEVERAL

A-HS457066 Hub & Spindle Assy. (6 Bolt) 30 Lbs.
 6 Bolt On 6.00" Circle - (4.625" Hub Pilot)
 Rated at 4570 lb capacity @ 20 mph.

Replaces: Electric Wheel - Q783

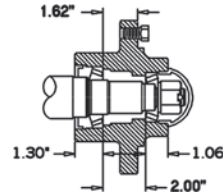

Dim/Info:
 Inner Cup: LM501310
 Inner Cone: LM501349
 Outer Cup: LM67010
 Outer Cone: LM67048
 Hub Cap: HC102
 Hub w/ Cups, Cones, Seal,
 Lug Bolts, Spindle, Hdwe,
 Dust Cap.

A-HS350066HK Hub Kit L/Spindle 17 Lbs.
A-H35006 Hub W/ Cups 15 Lbs.
A-SP3500 Spindle 10 Lbs.

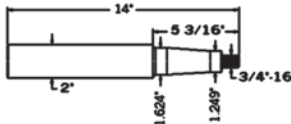

For Models: SEVERAL

A-HS356066 Hub & Spindle Assy. (6 Bolt) 24 Lbs.
 6 Bolt On 6.00" Circle - (4.625" Hub Pilot)
 Rated at 3560 lbs capacity @ 20 mph.

Replaces: Electric Wheel - Q888

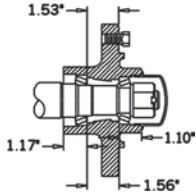

Dim/Info:
 Inner Cup: JL69310
 Inner Cone: JL69349
 Outer Cup: LM67010
 Outer Cone: LM67048
 Hub Cap: HC102
 Hub w/ Cups, Cones, Seal,
 Lug Bolts, Spindle, Hdwe,
 Dust Cap.

A-HS457066HK Hub Kit L/Spindle 18 Lbs.
A-H45706 Hub W/ Cups 17 Lbs.
A-SP4570 Spindle 9 Lbs.

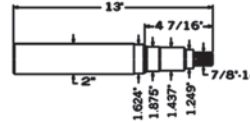

For Models: SEVERAL

A-HS491066 Hub & Spindle Assy. (6 Bolt) 36 Lbs.
 6 Bolt On 6.00" Circle - (4.625" Hub Pilot)
 Rated at 4910 lb capacity @ 20 mph.

Replaces: Electric Wheel - Q803

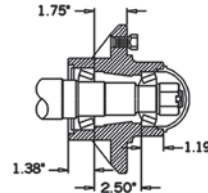

Dim/Info:
 Inner Cup: 25520
 Inner Cone: 25590
 Outer Cup: 25821
 Outer Cone: 25877
 Hub Cap: HC100
 Hub w/ Cups, Cones, Seal,
 Lug Bolts, Spindle, Hdwe,
 Dust Cap.

A-HS356066HK Hub Kit L/Spindle 13 Lbs.
A-H35606 Hub W/ Cups 11 Lbs.
A-SP3560 Spindle 9 Lbs.

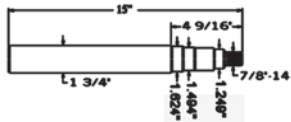

For Models: SEVERAL

A-HS491066HK Hub Kit L/Spindle 21 Lbs.
A-H49106 Hub W/ Cups 18 Lbs.
A-SP4910 Spindle 13 Lbs.

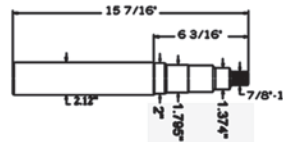

For Models: SEVERAL

Parts are not Original Equipment parts and are not sponsored, affiliated or otherwise connected with any major brand.

HUB & SPINDLE ASSEMBLIES

Hubs & Spindles and Related Parts

Parts are not Original Equipment parts and are not sponsored, affiliated or otherwise connected with any major brand.

A-HS491088 Hub & Spindle Assy. (8 Bolt)
8 Bolt On 8.00" Bolt Circle - (6.00" Hub Pilot)
Rated at 4910 lb capacity @ 20 mph.

46 Lbs.

Replaces: Electric Wheel - Q778

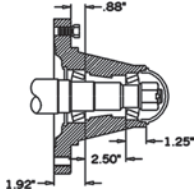

Dim/Info:

Inner Cup: 25520
Inner Cone: 25590
Outer Cup: 25821
Outer Cone: 25877
Hub Cap: HC100
Hub w/ Cups, Cones, Seal,
Lug Bolts, Spindle, Hdwe,
Dust Cap.

A-98A562

9/16" Stud

0 Lbs.

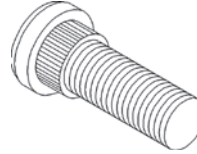

Dim/Info:

Knurl .609" Dia. .6875" Long
1.875" Bottom of head to end
of thread.
9/16"-18 Thread Size
minimum order qty 10

For Models: VARIOUS MODELS

A-HS491088HK Hub Kit L/Spindle

31 Lbs.

A-H49108 Hub W/ Cups

28 Lbs.

A-SP4910 Spindle

13 Lbs.

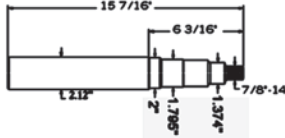

For Models: SEVERAL

A-HS579088 Hub & Spindle Assy. (8 Bolt)
8 Bolt On 8.00" Bolt Circle - (6.00" Hub Pilot)
Rated at 5790 lb capacity @ 20 mph.

54 Lbs.

Replaces: Electric Wheel - Q821

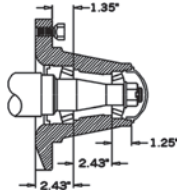

Dim/Info:

Inner Cup: 3720
Inner Cone: 3780
Outer Cup: 2720
Outer Cone: 2790
Hub Cap: HC100
Hub w/ Cups, Cones, Seal,
Lug Bolts, Spindle, Hdwe,
Dust Cap.

A-H57908 Hub W/ Cups

30 Lbs.

A-SP5790 Spindle

17 Lbs.

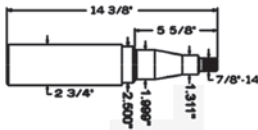

For Models: SEVERAL

A-HS60008S8 Hub & Spindle Assy. (8 Stud)
8 Stud On 8.00" Circle - (6.00" Hub Pilot)
Rated at 6000 lb capacity @ 20 mph.

55 Lbs.

Replaces: French & Hecht - 107009

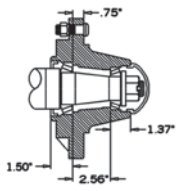

Dim/Info:

Inner Cup: JLM506810
Inner Cone: JLM506849
Outer Cup: LM501310
Outer Cone: LM501349
Studs: SD58 / Nuts: NT58
Hub Cap: HC104

A-HS60008S8HK Hub Kit L/Spindle

42 Lbs.

A-H60008 Hub W/ Cups

31 Lbs.

A-SP6000 Spindle

18 Lbs.

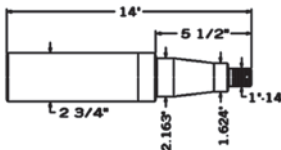

For Models: SEVERAL

Hitch & PTO Content

Ball Ends & Top Link Ball Sockets	138-139
Clevis & Pins	133-135
Drawbars	133
Grab Hooks & Chainbinders	143-144
Hair Pins Clips	132-133
Hitch Pins, Lynch Pins & Lock Pins	131-132
Leveling Box Assemblies & Parts, Bushings.	140-141
Lift Arm Pins	137-138
Lift Link Balls	141-142
PTO Couplers & Replacement Ends	129
Side Links & Lift Rods.	139-140
Side/Top Link Cylinders & Cylinder Pins	142-143
Stabilizers & Related Parts	135-137
Top Links, Top Link Pins, Center Links & Jacks	129-130

Click to go back to top

PTO Couplers, Replacement Ends & Top Links

Q. D. PIN KIT



A-48A120 Q. D. Pin Kit

Outside Diameter: .500"

A-48A23P Q. D. Pin Kit

Outside Diameter: .497"

QD OVERRUNNING COUPLER

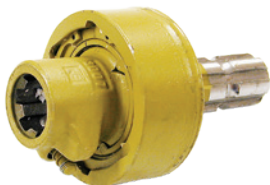

A-51A100 QD Overrunning Coupler

Female: ID 1.375" 6 Spline Male: OD 1.375" with 6 Spline
Maximum Horse Power: 75

A-51A110 QD Overrunning Coupler

Female: ID 1.125" 6 spline Male: OD 1.375" 6 Splines
Maximum Horse Power: 75

OVERRUNNING COUPLER



A-48A26 Overrunning Coupler

Female: 1.375" 6 Spline Male: 1.375" 6 Spline Maximum HP: 75

A-48A27 Overrunning Coupler

Female: 1.125" 6 Spline Male: 1.375" 6 Spline Maximum HP: 75

TOP LINK



A-49A1BLUE Top Link, Blue (Cat I)

Adjustable: 20.500"-29.00" Body Length: 16" Thread: 1.125"
Pin Hole: .75"

REPLACEMENT ENDS



A-RE001 Replacement End, Cat I

Hole Size: .750" Thread: Left Hand 1.125"

A-RE002 Replacement End, Cat I

Hole Size: .750" Thread: Right Hand 1.125"

A-RE003 Replacement End, Cat II

Hole Size: 1" Thread: Left Hand 1.125"

A-RE004 Replacement End, Cat II

Hole Size: 1" Thread: Right Hand 1.125"

A-RE005 Replacement End, Cat II

Hole Size: 1" Thread: Left Hand 1.250"

A-RE006 Replacement End, Cat II

Hole Size: 1" Thread: Right Hand 1.250"

A-RE007 Replacement End, Cat III

Hole Size: 1.270" Thread: Left Hand 1.375"

A-RE008 Replacement End, Cat III

Hole Size: 1.250" Thread: Right Hand 1.375"

TOP LINKS



A-ATL00 Top Link, Adj, Cat 0

Adjustable top link, heavy swedged center tube, forged ends, locking nut.

Adjustable: 13" - 20" Body Length: 9.750" Thread: .750"

Pin Hole: .625"

A-ATL01 Top Link, Adj, Cat 0

Adjustable: 10.750" - 16.375" Body Length: 7.500" Thread: .750"

Pin Hole: .625"

A-TL109 Top Link, Adj, Cat I

Adjustable: 14"-19.5" Body Length: 9" Thread: 1.125"

Pin Hole: .750"

A-ATL13 Top Link, Adj, Cat I

Adjustable: 15.750" - 23.375" Body Length: 11.125" Thread: 1.125"

Pin Hole: .750"

A-ATL14 Top Link, Adj, Cat I

Adjustable: 16" - 23.500" Body Length: 11.250" Thread: 1.125"

Pin Hole: .750"

A-ATL02 Top Link, Adj, Cat I

Adjustable: 17.500" - 26" Body Length: 13" Thread: 1.125"

Pin Hole: .750"

A-ATL03 Top Link, Adj, Cat I

Adjustable Top Link, Heavy Swedged Center Tube, Forged Ends, Locking Nut.

Adjustable: 20.500" - 29" Body Length: 16" Thread: 1.125"

Pin Hole: .750"

Parts are not Original Equipment parts and are not sponsored, affiliated or otherwise connected with any major brand.

HITCH & PTO PARTS

TOP LINKS

**A-TL04 Top Link, Adj, Cat I**

Adjustable: 24.500" - 33" Body Length: 20" Thread: 1.125"
Pin Hole: .750"

A-ATL04 Top Link, Adj, Cat I

Adjustable Top Link, Heavy Swedged Center Tube, Forged Ends, Locking Nut
Adjustable: 28.500" - 35" Body Length: 24" Thread: 1"
Pin Hole: .750"

A-ATL09 Top Link, Adj, Cat II

Adjustable Top Link, Heavy Swedged Center Tube, Forged Ends, Locking Nut.
Adjustable: 29.500" - 38.500" Body Length: 24" Thread: 1"
Pin Hole: 1"

A-ATL05 Top Link, Adj, Cat I & II

Adjustable: 20.750" - 31" Body Length: 16" Thread: 1.125"
Pin Hole: .750"/1"

A-ATL15 Top Link, Adj, Cat II

Adjustable O.E.M. Type
Adjustable: 24-30" Body Length: 18.750" Thread: 1.062"
Pin Hole: 1"

A-ATL06 Top Link, Adj, Cat I & II

Adjustable: 24.750" - 35" Body Length: 20" Thread: 1.125"
Pin Hole: .750"/1"

A-ATL07 Top Link, Adj, Cat II

Adjustable: 18" - 27.750" Body Length: 13" Thread: 1.125"
Pin Hole: 1"

A-ATL10 Top Link, Adj, Cat II

Heavy Swedged Center Tube And Forged Ends.
Adjustable: 20.5" - 31.5" Body Length: 15" Thread: 1.250"
Pin Hole: 1"

A-ATL08 Top Link, Adj, Cat II

Adjustable: 21" - 33" Body Length: 16" Thread: 1.125"
Pin Hole: 1"

A-ATL11 Top Link, Adj, Cat II

Heavy Swedged Center Tube And Forged Ends.
Adjustable: 24.500" - 35" Body Length: 19" Thread: 1.250"
Pin Hole: 1"

A-ATL16 Top Link, Adj, Cat II

Adjustable Top Link, Heavy Swedged Center Tube, Forged Ends, Locking Nut.
Adjustable: 25" - 37" Body Length: 20" Thread: 1.125"
Pin Hole: 1"

A-ATL12 Top Link, Adj, Cat III

Adjustable: 25.500" - 36.500" Body Length: 19" Thread: 1.375"
Pin Hole: 1.250"

A-P76-13 Top Link Adjusting Pin

Length: 8.00" Outside Diameter: .488"

TOP LINKS

**A-DONN576A Top Link, Adjustable, Cat II**

Adjustable: 24.500" - 31.250" Body Length: 16.750" Thread: 1.250"
Pin Hole: 1"

A-DONN576B Top Link Assembly, Cat I & II

Adjustable: 24.500" - 31.250" Body Length: 16 3/4" Thread: 1.250"
Pin Hole: .750"/1"

IMPLEMENT RATCHET JACK

**A-RJ1700 Jack, Implement Ratchet**

All steel construction. Pins & clips furnished w/ jack.
20" Closed X 28" Open, 1" Pin Dia. Pull: 15,000 lbs. Push: 10,000 lbs.

TOP LINK PINS

**A-TLP001 Pin, Top Link, Cat 0**

Diameter: .625" Overall Length: 4.437" Useable Length: 2.750"

A-TLP002 Pin, Top Link, Cat I

Diameter: .750" Overall Length: 4.500" Useable Length: 2.750"

A-TLP003 Pin, Top Link, Cat I

Diameter: .750" Overall Length: 5.500" Useable Length: 3.875"

A-TLP011 Pin, Top Link, Cat I

Diameter: .750" Overall Length: 5.187" Useable Length: 3"

A-TLP010 Pin, Top Link, Cat I

Diameter: .750" Overall Length: 6.187" Useable Length: 1"

A-TLP004 Pin, Top Link, Cat I

Diameter: .750" Overall Length: 6.375" Useable Length: 4.750"

A-TLP008 Pin, Top Link, Cat II

Diameter: 1" Overall Length: 4.938" Useable Length: 3"

A-TLP009 Pin, Top Link, Cat II

Diameter: 1" Overall Length: 5.500" Useable Length: 3.500"

A-TLP005 Pin, Top Link, Cat II

Diameter: 1" Overall Length: 7.125" Useable Length: 5.500"

A-TLP006 Pin, Top Link, Cat II

Diameter: 1" Overall Length: 5 3/4" Useable Length: 3.75"

A-TLP007 Pin, Top Link, Cat III

Diameter: 1.250" Overall Length: 6.500" Useable Length: 4.437"

Parts are not Original Equipment parts and are not sponsored, affiliated or otherwise connected with any major brand.

HITCH PIN



A-49B70231 Hitch Pin, Cat III
 Diameter: 1.425" Overall Length: 8.500" Useable Length: 6.250"

LYNCH PINS

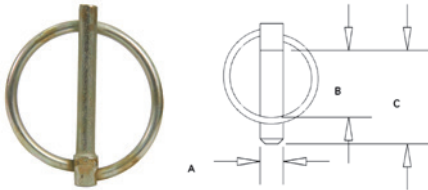

A-PN101 Lynch Pin, .187" (10 pk)
 A: .187" B: 1.125" C: 1.375"

A-PN101C Lynch Pin, w/ Chain .187" (5 pk)
 A: .187" B: 1.125" C: 1.375"

A-PN102 Lynch Pin, .250" (5 pk)
 A: .250" B: 1.437" C: 1.750"

A-PN102C Lynch Pin, w/ Chain .250" (5 pk)
 A: .250" B: 1.437" C: 1.750"

A-PN103 Lynch Pin, .312" (5 pk)
 A: .312" B: 1.437" C: 1.750"

A-PN103C Lynch Pin, w/ Chain .312" (5 pk)
 A: .312" B: 1.437" C: 1.750"

A-PN107 Lynch Pin, .437" (5 pk)
Used w/ 7A4902 stabilizer pin.

A: .437" B: 1.406" C: 1.750"

A-PN107C Lynch Pin, w/ Chain .437" (5 pk)
 A: .437" B: 1.406" C: 1.750"

A-PN110 Lynch Pin w/ HD Ring, .437" (5 pk)
 A: .413" B: 1.575" C: 2.00"

A-PN111 Lynch Pin, .437" (5 pk)
 A: .437" B: 1.750" C: 2"

ROUND & SQUARE LOCK PINS

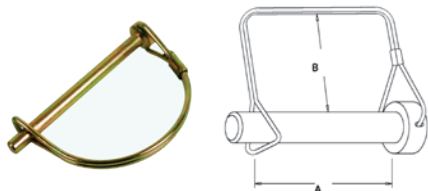

A-SPR101 Pin, 1/4" x 2-1/4", Round Lock (5 pk)
 A: 2.25" B: 1.500"

A-SPR102 Pin, 5/16" x 2-1/4", Square Lock, (5 pk)
 A: 2.250" B: 1.625"

A-SPR106 Pin, 5/16" x 2-1/4", Round Lock, (5 pk)
 A: 2.250" B: 1.500"

A-SPR104 Pin, 3/8" x 2-1/4", Round Lock, (5 pk)
 A: 2.250" B: 1.500"

ROUND & SQUARE LOCK PINS

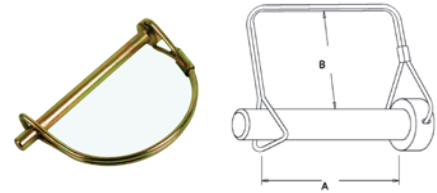

A-SPR105 Pin, 3/8" x 2-1/4", Square Lock, (5 pk)
 A: 2.25" B: 1.600"

HITCH PINS



A-HL17 Hitch Pin 1/4" X 1-3/8" (5 pk)

Pin Diameter: 1/4" Useable Length: 1-3/8" Wire: Round

A-HL16 Hitch Pin 1/4" X 1-5/8" (5 pk)

Pin Diameter: 1/4" Useable Length: 1-3/4" Wire: Round

A-HL20 Hitch Pin 5/16" X 2-1/2" (5 pk)

Pin Diameter: 5/16" Useable Length: 2-1/2" Wire: Round

A-HL22 Hitch Pin 3/8" X 1-1/2" (5 pk)

Pin Diameter: 3/8" Useable Length: 1-1/2" Wire: Round

A-HL23 Hitch Pin 3/8" X 1-3/4" (5 pk)

Pin Diameter: 3/8" Useable Length: 1-3/4" Wire: Round

A-HL24 Hitch Pin 3/8" X 2-1/2" (5 pk)

Pin Diameter: 3/8" Useable Length: 2-1/2" Wire: Round

A-HL18 Hitch Pin 1/4" X 2-1/4" (5 pk)

Pin Diameter: 1/4" Useable Length: 2-1/2" Wire: Square

A-HL19 Hitch Pin 1/4" X 2-1/2" (5 pk)

Pin Diameter: 1/4" Useable Length: 2-1/2" Wire: Square

A-HL21 Hitch Pin 5/16" X 2-1/2" (5 pk)

Pin Diameter: 5/16" Useable Length: 2-1/2" Wire: Square

A-HL25 Hitch Pin 3/8" X 2-1/2" (5 pk)

Pin Diameter: 3/8" Useable Length: 2-1/2" Wire: Square

A-HL26 Hitch Pin 3/8" X 3" (5 pk)

Pin Diameter: 3/8" Useable Length: 3" Wire: Square

A-HL11 Hitch Pin, Handle Lock, 1/2" x 4 1/4"

Diameter: .500" Useable Length: 4.250"

A-HL12 Hitch Pin, Handle Lock, 5/8" x 4 1/4"

Diameter: .625" Useable Length: 4.250"

A-HL14 Hitch Pin, Handle Lock, 3/4" x 6 1/4"

Diameter: .750" Useable Length: 6.250"

Parts are not Original Equipment parts and are not sponsored, affiliated or otherwise connected with any major brand.

HITCH & PTO

Hitch Pins & Hair Pin Clips

RED HANDLED HITCH PINS



1 pc. forged head w/ red plastic coating & hair pin.

A-HP101 Hitch Pin, Red Handled 1/2" x 3 5/8"

Length: 3.625" Diameter: .500"

A-HP102 Hitch Pin, Red Handled 5/8" x 4"

Length: 4" Diameter: .625"

A-HP103 Hitch Pin, Red Handled 5/8" x 5 1/2"

Length: 5.500" Diameter: .625"

A-HP104 Hitch Pin, Red Handled 3/4" x 4"

Length: 4" Diameter: .750"

A-HP105 Hitch Pin, Red Handled 3/4" x 6 1/2"

Length: 6.500" Diameter: .750"

A-HP106 Hitch Pin, Red Handled 7/8" x 6 1/2"

Length: 6.500" Diameter: .875"

A-HP107 Hitch Pin, Red Handled 1" x 7 1/2"

Length: 7.500" Diameter: 1"

A-HP108 Hitch Pin, Red Handled 1 1/8" x 8 1/2"

Length: 8.500" Diameter: 1.125"

A-HP109 Hitch Pin, Red Handled 1 1/4" x 8 1/2"

Length: 8.500" Diameter: 1.250"

A-HP110 Hitch Pin, Red Handled 1 1/2" x 8 1/2"

Length: 8.500" Diameter: 1.500"

MACHINED HITCH PINS



Hair pins are included w/ hitch pins

A-HPL100 Hitch Pin, Machined, 3/8" x 3"

Length: 3.5" Diameter: .375"

A-HPL101 Hitch Pin, Machined, 1/2" x 4 1/4"

Length: 4.250" Diameter: .500" Useable Length: 4.500"

A-HPL102 Hitch Pin, Machined, 5/8" x 4 1/4"

Length: 4.250" Diameter: .625"

A-HPL103 Hitch Pin, Machined, 5/8" x 6 1/4"

Length: 6.250" Diameter: .625"

A-HPL104 Hitch Pin, Machined, 3/4" x 4 1/4"

Length: 4.250" Diameter: .750"

A-HPL105 Hitch Pin, Machined, 3/4" x 6 1/4"

Length: 6.250" Diameter: .750"

A-HPL106 Hitch Pin, Machined, 7/8" x 4 1/4"

Length: 4.250" Diameter: .875"

A-HPL107 Hitch Pin, Machined, 7/8" x 6 1/4"

Length: 6.250" Diameter: .875"

MACHINED HITCH PINS



Hair pins are included w/ hitch pins

A-HPL108 Hitch Pin, Machined, 1" x 4 1/4"

Length: 4.250" Diameter: 1"

A-HPL109 Hitch Pin, Machined, 1" x 6 1/4"

Length: 6.250" Diameter: 1"

A-HPL110 Hitch Pin, Machined, 1 1/8" x 6 1/4"

Length: 6.250" Diameter: 1.125"

A-HPL111 Hitch Pin, Machined, 1 1/4" x 7 1/2"

Length: 7.500" Diameter: 1.250"

BENT HITCH PIN



A-HPB101 Hitch Pin, Bent, 1/2" x 3"

Diameter: .500"

A-HPB102 Hitch Pin, Bent, 5/8" x 3"

Diameter: .625"

A-HPB103 Hitch Pin, Bent, 3/4" x 3 1/2"

Diameter: .750"

A-HPB105 Hitch Pin, Bent, 1/2" x 5"

Diameter: .500"

HAIR PIN CLIPS



A-HPC08 Hair Pin Clip (10 pk)

Length: 42mm/1.65" Fits: Shaft 6mm-11mm/.24"-.43"
Wire Size: 2.00mm/.08"

A-HPC10 Hair Pin Clip (10 pk)

Length: 43mm/1.69" Fits: Shaft 8mm-12mm/.31"-.47"
Wire Size: 2.50mm/.10"

A-HPC12 Hair Pin Clip (10 pk)

Length: 64mm/2.52" Fits: Shaft 10mm-18mm/.39"-.71"
Wire Size: 3.00mm/.19"

A-HPC16 Hair Pin Clip (10 pk)

Length: 76mm/3" Fits: Shaft 12mm-22mm/.47"-.87"
Wire Size: 4.00mm/.16"

A-HPC18 Hair Pin Clip (10 pk)

Length: 105mm/4.13" Fits: Shaft 10mm-18mm/.40"-.71"
Wire Size: 4.50mm/.18"

A-HPC20 Hair Pin Clip (10 pk)

Length: 100mm/3.94" Fits: Shaft 16mm-27mm/0.63"-1.06"
Wire Size: 5.00mm/0.20"

Parts are not Original Equipment parts and are not sponsored, affiliated or otherwise connected with any major brand.

HAIR PIN CLIPS

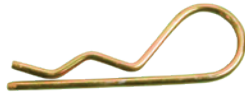

A-HPC20-B Hair Pin Clip (25 pk)

Length: 100mm/3.94" Wire Size: 5.00mm/.20"
 PKG QTY: minimum order qty 25

A-HPC24 Hair Pin Clip (10 pk)

Length: 113mm/4.45" Fits: Shaft 19mm-32mm/.75"-1.26"
 Wire Size: 6.00mm/.24"

A-HPC28 Hair Pin Clip (10 pk)

Length: 4.660" Fits: Shaft 25mm-28mm/.98"-1.10"
 Wire Size: .280"

HAIR PIN CLIP ASSORTMENT



A-HC200A Hair Pin Clip Assortment

A-7A1005 Hair Pin Clip Assortment

DRAWBARS



A-DB101 Drawbar, Cat I

Length: 20" Holes: 7 Pin Diameter: .842"
 Thickness: 1" Width: 2.500"

A-DB102 Drawbar, Cat I

Length: 26" Holes: 11 Pin Diameter: .860"
 Thickness: 1" Width: 2.500"

A-DB103 Drawbar, Cat II

Length: 26" Holes: 11 Pin Diameter: 1.125"
 Thickness: 1.250" Width: 3"

A-DB104 Drawbar, Cat II

Length: 32" Holes: 13 Pin Diameter: 1.125"
 Thickness: 1.250" Width: 3"

A-DB105 Drawbar, Cat III

Length: 38" Holes: 5 Pin Diameter: 1.437"
 Thickness: 1.750" Width: 3.500"

A-DB106 Drawbar, Cat I, BLU

Length: 26" Holes: 11 Pin Diameter: .875"
 Thickness: 1" Width: 2.500"

A-DB107 Drawbar, Cat I

Length: 26" Holes: 11 Pin Diameter: .875"
 Thickness: 1" Width: 2.500"

A-DB108 Drawbar, Cat I

Length: 26" Holes: 11 Pin Diameter: .875"
 Thickness: 1.125" Width: 2.500"

A-DB109 Drawbar, Cat 0

Length: 20" Holes: 7 Pin Diameter: .625"
 Thickness: .625" Width: 2"

DRAWBAR KIT - SWINGING



A-SDK01 Drawbar Kit - Swinging

Color: RED
 Thickness: 1.000" Width: 2.000" Long: 29.375"

LOCK, DRAWBAR, CAT I



A-DBL01 Lock, Drawbar, Cat I

For Cat I drawbars. Prevents drawbar from rotating.

ECONOMY DRAWBARS



A-184611M1 Economy Drawbar

Holes: 1.064" Thickness: 1.125" Width: 2.00" Long: 35-3/4"

A-VPL4434 Economy Drawbar

Holes: 1" Thickness: 1.250" Width: 2.00" Long: 28"

DRAWBAR, SWINGING



A-SBA370710110 Drawbar, Swinging

Long: 28.620"

A-SBA370710290 Drawbar, Swinging

Long: 25.370"

CLEVIS PIN



A-TCP03 Clevis Pin

Pin Size: 0.500"

A-TCP05 Clevis Pin

Pin Size: 0.625"

A-TCP04 Clevis Pin

Pin Size: 0.750"

A-TCP01 Clevis Pin

Pin Size: 0.875"

A-TCP02 Clevis Pin

Pin Size: 1.000"

Parts are not Original Equipment parts and are not sponsored, affiliated or otherwise connected with any major brand.

CLEVIS PIN ASST



- A-7A5112 Clevis Pin Asst**
 (3) .250" X 2" (3) .312" X 2" (2) .375" X 2.500" (2) .438" X 2"
 (1) .438" X 2" (1) .500" X 2"
- A-7A5160 Clevis Pin Asst**
 (10) .250" X 2" (10) .312" X 2" (10) .375" X 2" (10) .438" X 2" (10)
 .438" X 2.500" (10) .500" X 2"

CLEVIS, 8 HOLE PIN UNIVERSAL



- A-UCP04 Clevis, 8 Hole Pin Universal (10 pk)**
 Length: 2.00" Diameter: 0.250"
- A-UCP03 Clevis, 5 Hole Pin Universal (10 pk)**
 Length: 2.00" Diameter: 0.313"
- A-UCP06 Clevis, 7 Hole Pin Universal (5 pk)**
 Length: 2.00" Diameter: 0.375"
- A-UCP02 Clevis, 8 Hole Pin Universal (5 pk)**
 Length: 2.000" Diameter: 0.438"
- A-UCP01 Clevis, 8 Hole Pin Universal (5 pk)**
 Length: 2.500" Diameter: 0.438"
- A-UCP05 Clevis, 8 Hole Pin Universal (5 pk)**
 Length: 2.00" Diameter: 0.500"

CLEVIS, STRAIGHT

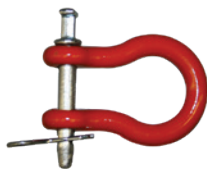

- A-SC101 Clevis, Straight**
 Pin Diameter: 0.500"
- A-SC103 Clevis, Straight**
 Pin Diameter: 0.625"
- A-SC105 Clevis, Straight**
 Pin Diameter: 0.750"
- A-SC107 Clevis, Straight**
 Pin Diameter: 15/16"
- A-SC109 Clevis, Straight**
 Pin Diameter: 1.00"

CLEVIS, TWISTED



- A-TC102 Clevis, Twisted**
 Pin Diameter: 0.500"
- A-TC104 Clevis, Twisted**
 Pin Diameter: 0.625"
- A-TC106 Clevis, Twisted**
 Pin Diameter: 0.750"
- A-TC108 Clevis, Twisted**
 Pin Diameter: 0.875"
- A-TC110 Clevis, Twisted**
 Pin Diameter: 1.00"

CLEVIS, UTILITY



- A-UC02 Clevis, Utility**
 Pin Size: 3/8"
- A-UC03 Clevis, Utility**
 Pin Size: 7/16"
- A-UC04 Clevis, Utility**
 Pin Size: 1/2"
- A-UC05 Clevis, Utility**
 Pin Size: 5/8"
- A-UC06 Clevis, Utility**
 Pin Size: 3/4"

CLEVIS, FARM



- A-UC14 Clevis, Farm**
 Pin Size: 0.3125"
- A-UC07 Clevis, Farm**
 Pin Size: 0.375"
- A-UC08 Clevis, Farm**
 Pin Size: 3/8" Clevis with 7/16" Pin
- A-UC09 Clevis, Farm**
 Pin Size: 0.500"
- A-UC10 Clevis, Farm**
 Pin Size: 0.625"
- A-UC13 Clevis, Farm**
 Pin Size: 0.750"

Parts are not Original Equipment parts and are not sponsored, affiliated or otherwise connected with any major brand.

Parts are not Original Equipment parts and are not sponsored, affiliated or otherwise connected with any major brand.

CLEVIS, FARM



A-UC17 Clevis, Farm

Pin Size: 0.875"

A-UC16 Clevis, Farm

Pin Size: 1.000"

A-UC15 Clevis, Farm

Pin Size: 1.125"

A-UC11 Clevis, Farm

Pin Size: 1.250"

A-UC12 Clevis, Farm

Pin Size: 1.375"

HEAVY DUTY STABILIZER KIT



A-HDSK02 Stabilizer Kit, Heavy Duty

Heavy duty arms & universal bracket. Linch pin length required: 1.750"
31 3/8" Center to Center

A-SAB01 Mounting Bracket, Stabilizer Arm

Thickness: .375" Long: 6.750"

STABILIZER ASSY



A-49A567 Stabilizer Assy

22" Collapsed 30" Extended

UNIVERSAL STABILIZER KIT



A-HDSK01 Stabilizer Kit, Universal

Extra heavy duty, check dimensions before ordering.

Painted Primer Red Adjustable: Closed - 19.500", Extended 25.250"

HITCH & PTO

Clevis & Stabilizers

COMPLETE STABILIZER ASSEMBLY

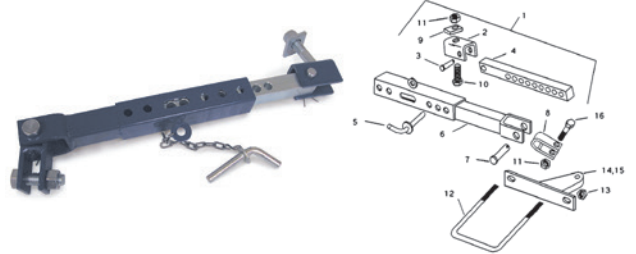

A-D9NNB856BB Complete Stabilizer Assembly

(#12). LH & RH Mounting Brackets also need to be ordered separately

A-D9NNR831AA Coupling- (Ref. 2)

A-D9NNN873BA Pin- (Ref. 3)

A-D9NNP999BA Bar Assembly- (Ref. 4)

A-D9NNP997AA Pin- (Ref. 5)

A-D9NNN873AA Pin- (Ref. 7)

A-D9NNR832BA Shackle- (Ref. 8)

A-D9NNA931BA Spacer- (Ref. 9)

A-34992S7 Nut- (Ref. 11)

A-304898S36 Bolt- (Ref. 16)

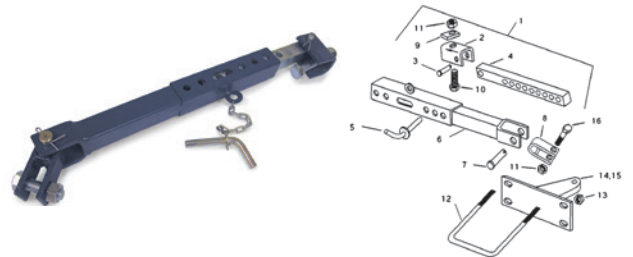

A-D9NNB856AA Assembly, Complete Stabilizer

22" Collapsed and 30" extended

A-D9NNR831AA Coupling- (Ref. 2)

A-D9NNN873BA Pin- (Ref. 3)

A-D9NNP999BA Bar Assembly- (Ref. 4)

A-D9NNP997AA Pin- (Ref. 5)

A-D9NNR833AA Tube Assembly- (Ref. 6)

A-D9NNN873AA Pin- (Ref. 7)

A-D9NNR832BA Shackle- (Ref. 8)

A-D9NNA931BA Spacer- (Ref. 9)

A-34992S7 Nut- (Ref. 11)

A-304898S36 Bolt- (Ref. 16)

STABILIZER ARM



A-SA001 Stabilizer Arm, Cat I

C to C: 31.562" Holes: .875" Overall Length: 33.500"

Thickness: .375" Width: 2.000"

HITCH & PTO Stabilizers & Related Parts

STABILIZER ARM



A-SA002 Stabilizer Arm, Cat I

C to C: 33.125" Holes: .875" Overall Length: 34.94"
Thickness: .375" Width: 2.000"

A-SA003 Stabilizer Arm, Cat I

C to C: 32.92" & 31.47" Holes: .906" Overall Length: 34.94"
Thickness: .375" Width: 1.750"

A-SA004 Stabilizer Arm, Adjustable, Cat I

Adjustable: 27.500" - 35" Body Length: 22.000" Holes: .875"



A-SA007 Stabilizer Arm, Universal Economy, Cat II (RH)

C to C: 31.500" Holes: .920" Overall Length: 33.500"
Thickness: .375" Width: 2.00"

A-SA006 Universal Economy Stabilizer Arm, Cat II (LH)

C to C: 31.500" Holes: .920" Overall Length: 33.500"
Thickness: .375" Width: 2.00"



A-C5NNN455C Stabilizer Arm, Cat. I (LH)

C to C: 32.500" Holes: .875" Overall Length: 33.5"
Thickness: .375" Width: 2.00"

A-C5NN454C Stabilizer Arm, Cat. I (RH)

C to C: 31.270" Holes: .875" Overall Length: 33.5"
Thickness: .375" Width: 2.00"



A-C5NN454B Stabilizer Arm, Cat II & III (RH)

Dual Category C to C: 31.500" & 32.00" Holes: .875" & 1.125"
Overall Length: 33.5" Thickness: .375" Width: 2.00"

A-C5NNN455B Stabilizer Arm, Cat II & III (LH)

Dual Category C to C: 31.500" & 32" Holes: .875" & 1.125"
Overall Length: 33.5" Thickness: .375" Width: 2"

A-SA008 Stabilizer Arm, Cat I & II

C to C Min: 26.187" C to C Max: 30.750" Inside Hole Diameter: .875"
Overall Length: 32.625" Thickness: .375" Width: 2.000"

STABILIZER ARM

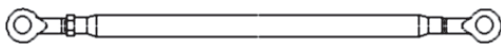

A-SA005 Stabilizer Arm

C to C: 29" Adjustable: Approx 15" Used w/ 7/8" Pins

STABILIZER PIN



A-PS01 Stabilizer Pin

Includes nut and lock washer.

Length: 2.625" Pin Diameter: .875" Thread: .625" - 18

A-PS02 Stabilizer Pin

Includes nut and lock washer. Used w/ A-49B58 & A-49B59 stabilizer brackets.

Length: 3.125" Pin Diameter: .875" Thread: .875" - 14

A-PS03 Stabilizer Pin

Used w/ A-47V60LH & A-47V60RH stabilizer brackets.

Length: 2.875" Pin Diameter: .750" Thread Length: 1 3/8"

A-PS04 Stabilizer Pin

Length: 3.125" Pin Diameter: .875" Thread: .625" - 18

ADJUSTABLE COMPACT STABILIZER LINK



A-VPL3232 Compact Stabilizer Link, Adjustable

Used for compact tractors.

Link side .79" Eyelet side .90" Adjustable: 15.500" - 19.500"

STABILIZER CHAIN



A-CBPN598A Stabilizer Chain

STABILIZER LINKS

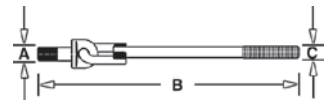

A-SBA370500911 Stabilizer Link, Rear

A: M16 x 1.5 RH B: 12.00" C: M14 x 2.0 RH

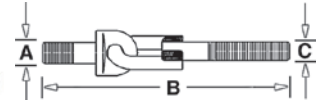

A-SBA370500950 Stabilizer Link, Rear

A: M16 x 1.5 RH B: 6.75" C: M14 x 2.0 RH

Parts are not Original Equipment parts and are not sponsored, affiliated or otherwise connected with any major brand.

Stabilizer Related Parts & Lift Arm Pins

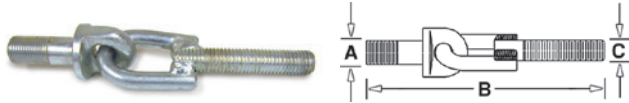

A-SBA370500490 Stabilizer Link, Rear
 A: M18 x 1.5 RH B: 6.00" C: M14 x 2.0 RH



A-SBA370500920 Stabilizer Link, Rear
 A: M16 x 2.0 RH B: 11.00"

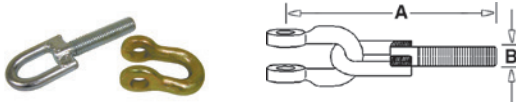

A-SBA370500500 Stabilizer Link, Tractor End
 A: 6.00" B: M14 x 2.0 LH

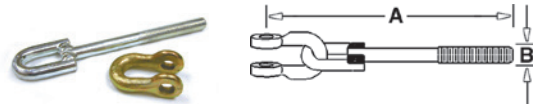

A-SBA370500510 Stabilizer Link, Front
 A: 9.312" B: M14 X 2.0 LH

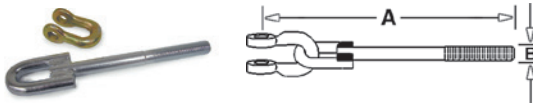

A-SBA370500530 Stabilizer Link, Tractor End
 A: 10.250" B: M16 x 2.0 LH



A-SBA370500930 Stabilizer Link, Tractor End
 A: 6.250" B: M16 x 2.0 LH

STABILIZER CHAIN ASSEMBLY



A-CFPND936B Stabilizer Chain Assembly
 Thread: 3/4" UNC

A-49A93 Stabilizer Chain, Set

STABILIZER EYEBOLT



A-SE01 Stabilizer Eyebolt
 Used to repair A-49A93 chain type adjustable stabilizer.
 Thread: Left Hand 3/4" - 10

CHECK CHAIN STABILIZER



A-159350 Check Chain Stabilizer
 Fits most compact tractors 15 HP to 40 HP.
 Adjustable: 11.750" - 13.500" Body Length: 3.500"
 Pin Diameter: 7/16" Thread: M14-1.5

A-159425 Check Chain Stabilizer
 Adjustable: 24" - 27" Body Length: 4.250"
 Pin Diameter: 7/16" Thread: 1/2-20

UNIVERSAL FRAME BRACKETS



A-FB01 Brackets, Universal Frame (Set of 2)
 Order 1 To Recieve 2
 Thickness: .500" Width: 2.500"

LIFT ARM PIN



A-LP001 Pin, Lift Arm, Adj, Cat 0
 Length: 4" Pin Diameter: .625" Thread: .625"

A-LP002 Pin, Lift Arm, Adj, Cat I
 Length: 5.312" Pin Diameter: .875" Thread: .875"

A-LP004 Pin, Lift Arm, Adj, Cat I
 Length: 6.250" Pin Diameter: .875" Thread: .875"

A-LP006 Pin, Lift Arm, Adj, Cat I & II
 Length: 5.187" Pin Diameter: 1.125" Thread: .875"

A-LP008 Pin, Lift Arm, Cat I & II
 Length: 6.312" Pin Diameter: 1.125" Thread: .875"

A-LP009 Pin, Lift Arm, Cat I & II
 Length: 5.750" Pin Diameter: .875" Thread: 1.125" Useable Length: 2"

A-LP011 Pin, Lift Arm, Adj, Cat II
 Length: 6.250" Pin Diameter: 1.125" Thread: 1.125"

Parts are not Original Equipment parts and are not sponsored, affiliated or otherwise connected with any major brand.

LIFT ARM PIN



A-LP003 Pin, Lift Arm, Forged, Cat. I
Length: 5.500" Pin Diameter: .875" Thread: .875"

A-LP005 Pin, Lift Arm, Forged, Cat I
Length: 6.500" Pin Diameter: .875" Thread: .875"

A-LP007 Pin, Lift Arm, Forged, Cat II
Length: 5.250" Pin Diameter: 1.125" Thread: .875"

A-LP012 Pin, Lift Arm, Forged, Cat II
Length: 6.250" Pin Diameter: 1.125" Thread: 1.125"

A-LP013 Pin, Lift Arm, Cat II & III
Length: 5.875" Pin Diameter: 1.437" Thread: 1.125"

A-LP014 Pin, Lift Arm, Cat III
Length: 5.875" Pin Diameter: 1.437" Thread: 1.375"



A-LP016 Pin, Lift Arm, Cat II
Length: 9.250" Pin Diameter: 1.125" Thread: - Useable Length: 7.500"

A-LP020 Pin, Lift Arm, Cat II
Length: 10.87" Pin Diameter: 1.125" Thread: - Useable Length: 9.00"

A-LP021 Pin, Lift Arm, Cat II
Length: 7.250" Pin Diameter: 1.125" Thread: - Useable Length: 5.50"



A-LP017 Pin, Lift Arm, Cat III
Length: 6.500" Pin Diameter: 1.437" Thread: - Useable Length: 4.500"



A-LP018 Pin, Lift Arm, Cat II & III
Length: 9.250" Pin Diameter: 1.125" & 1.437" Useable Length: 8.500"

LIFT ARM PIN



A-LP010 Pin, Lift Arm, Cat II
Length: 6.250" Pin Diameter: Cat I - .875", Cat II - 1.125"
Thread: 1.125" Useable Length: 2"

A-LP015 Pin, Lift Arm, Cat I
Length: 5.5" Pin Diameter: .875" Thread: M20 X 1.5
Useable Length: 1.750"

A-7A4990 Pin, Lift Arm, Cat I & II
Pin Diameter: Cat I - .875", Cat II - 1.125" Thread: .875"
Useable Length: 2"

BALL ENDS

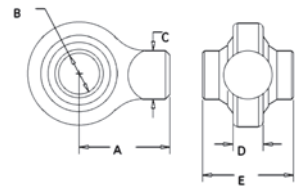

A-BE001 Ball End, Cat I
Top link round weld on area.
A: 2" B: .750" C: 1.250" D: .500" E: 1.750"

A-BE002 Ball End, Cat II
Top link round weld on area.
A: 2.375" B: 1" C: 1.125" D: .625" E: 2"

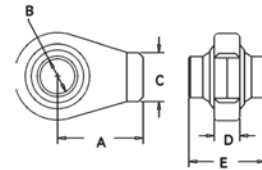

A-BE003 Ball End, Cat I
Top link, rectangular weld on area.
A: 2.156" B: .750" C: 1" D: .500" E: 1.750"

A-BE004 Ball End, Cat II
Top link, rectangular weld on area.
A: 2.375" B: 1" C: 1.187" D: .625" E: 2"

A-BE005 Ball End, Cat III
Top link, rectangular weld on area.
A: 3.343" B: 1.250" C: 1.406" D: .750" E: 2"

Parts are not Original Equipment parts and are not sponsored, affiliated or otherwise connected with any major brand.

Ball Ends, Top Link Ball Sockets & Side Links

BALL ENDS

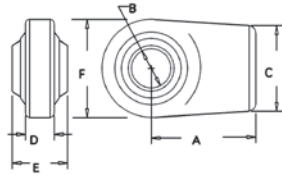

A-BE006 Ball End, Cat I

Lower link of most tractor brands.

A: 3" B: .875" C: 2.500" D: .625" E: 1.375" F: 2.675"

A-BE007 Ball End, Cat II

A: 3.250" B: 1" C: 2.750" D: .750" E: 1.500" F: 3.250"

A-BE008 Ball End, Cat II

Lower link of most tractor brands.

A: 3.125" B: 1.125" C: 2.750" D: .750" E: 1.750" F: 3.250"

WELD ON END FOR LIFT ARM

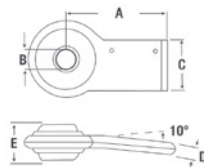

A-BE010 Weld On End For Lift Arm, Cat I (RH/LH)

A: 3.938" B: .875" C: 1.813" D: .625" E: 1.375"

A-BE012 Weld On End For Lift Arm, Cat I (RH)

A-BE011 Weld On End For Lift Arm, Cat I (LH)

A: 3.750" B: .875" C: 1.750" D: .625" E: 1.375"

A-BE014 Ball End, Cat III

A: 3.346" B: 1.437" C: 3.000" D: .750" E: 1.750" F: 3.500"

TOP LINK BALL SOCKET

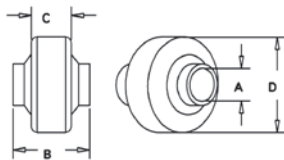

A-BS101 Socket, Ball; Top Link - Cat 0

A: .625" B: 1.00" C: .750" D: 2.00"

A-BS102 Socket, Ball; Top Link (Cat I)

A: .750" B: 1.625" C: .750" D: 2.000"

A-BS103 Socket, Ball; Top Link - Cat I

A: .750" B: 1.625" C: .875" D: 2.125"

A-BS104 Socket, Ball; Top Link - Cat II

A: 1.000" B: 1.750" C: .875" D: 2.375"

A-BS105 Socket, Ball; Top Link (Cat I)

A: 1.000" B: 1.750" C: .949" D: 2.750"

A-BS106 Socket, Ball; Top Link (Cat III)

A: 1.250" B: 1.750" C: 1.281" D: 3.125"

A-BS108 Socket, Ball; Top Link - Cat I & II

2 Way Ball

A: .750" & 1.00" B: 1.25" C: .500" D: 2.375"

A-BS109 Weld on Ball for Lift Arm (Cat I)

A: .875" B: 1.375" C: .850" D: 2.438"

TOP LINK BALL SOCKET

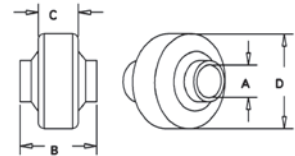

A-BS110 Weld on Ball for Lift Arm

2 way ball for .875" Cat I & 1.125" Cat II pins.

A: 1.140" B: 1.750" C: 1.250" D: 2.750"

A-BS113 Weld On Ball for Lift Arm (Cat II)

A: 1.1250" B: 1.30" C: 0.875" D: 2.4375"

A-BS115 Weld on Ball for Lift Arm (Cat III)

A: 1.437" B: 1.750" C: 1.425" D: 3.500"

UNIVERSAL ECONOMY LEVELING ASSEMBLY



A-ECONN577AB Universal Economy Leveling Assembly

Length: 19.250" Adjustable: 17.750" min / 25.500" max Pin Hole: .760"

SIDE LINK, ADJUSTABLE W/ PIN



A-15990 Link, Side, Adjustable w/ Pin, Cat 0

Fits most compact tractors 15 HP to 40 HP.

Length: 13.000" min / 19.500" max Body Length: 7.500"

Holes: (3) .563"



A-159750 Link, Side, Adjustable w/ Pin, Cat I

Fits most compact tractors 15 HP to 40 HP. Use w/ A-159975 non-adjustable side link.

Length: 7.500" min / 12.500" max Body Length: 7.500"

Holes: (3) .570"



A-159950 Link, Side, Adjustable w/ Pin, Cat I

Fits most compact tractor 15 HP to 40 HP. Use w/ A-1591150 non-adjustable side link.

.90" between forks 1" Ball End ID

Length: 15.500" min / 24.000" max Body Length: 9.500"

Holes: (3) .563"

Parts are not Original Equipment parts and are not sponsored, affiliated or otherwise connected with any major brand.

HITCH & PTO PARTS



A-1590115 Link, Side, Adjustable w/ Pin, Cat I
Fits most compact tractors 15 HP to 40 HP. Use w/ A-159155 non-adjustable side link.
 Length: 16.500" min / 27.500" max Body Length: 11.5"
 Holes: Ball End: .765"; Yoke End: (3) .525", 1" apart



A-259950 Link, Side, Adjustable, Cat II
Used w/ A-259155 LH side link.
 Length: 23.000" min / 33.500" max Body Length: - Holes: (3) .765"



A-259951 Link, Side, Adjustable, Cat II
Used w/ A-259156 LH side link.
 Length: 19.000" min / 29.500" max Body Length: - Holes: (3) .765"



A-259952 Link, Side (LH), Adjustable w/ Pin, Cat II
Used w/ A-259975 adj. side link.
 Length: 15.000" min / 25.500" max Body Length: - Holes: (3) .765"



A-159975 Link, Side (LH), Non-Adjustable
Fits most compact tractors 15 HP to 40 HP. Use w/ A-159750 adjustable side link.
 Length: 13", 14.5" & 16" Body Length: - Holes: (3) .563"



A-1591150 Link, Side (LH), Non-Adjustable w/ Pin, Cat I
Fits most compact tractors 15 HP to 40 HP. Use w/ A-159950 adjustable side link.
 Length: 16", 17" & 18" Body Length: - Holes: (3) .563"

LIFT RODS

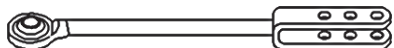

A-86402629 Lift Rod
Used on models TC25, TC25D, TC29, TC29D, TC33 & TC33D w/ standard hitch SN G021527> & deluxe hitch SN G023195> & between SNG021299-G021451.
 C to C: 15.62", 17.12", 18.62"

LIFT RODS

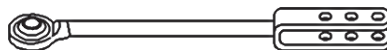

A-86526733 Lift Rod
On models TC25, TC25D, TC29, TC29D, TC33 & TC33D used on models w/ standard hitch SN <G021526 & deluxe hitch SN <G02198 & Between SN G021452 - G023194.
 C to C: 15.75", 17.25", 18.75"



A-SBA370200380 Lift Rod (LH)
 C to C: 14.62", 16.12", 17.62"

A-SBA370200220 Lift Rod (LH)
 C to C: 16.80", 18.30", 19.80"

A-SBA370201571 Lift Rod (LH)
 C to C: 15.50", 17.00", 18.50"

A-SBA370201400 Lift Rod (LH)
 C to C: 27.00", 28.50", 30.00"

A-SBA370201361 Lift Rod (LH)
 C to C: 18.50", 20.25", 22.00"

A-SBA370202391 Lift Rod (LH)
 C to C: 15.12", 16.62", 18.12"

LEVELING BOX ASSEMBLY & PARTS



A-1660373M92 Leveling Box Assembly w/ Fork (RH)
Adjustment is 19" to 24.5" center to center hole



A-193178M91 Leveling Box Assembly w/o Fork (RH)



A-1884376M1 Knuckle Assembly



A-376399X1 Pin



A-181346M1 Handle

Parts are not Original Equipment parts and are not sponsored, affiliated or otherwise connected with any major brand.

Leveling Box Parts, Bushings & Lift Link Balls

Parts are not Original Equipment parts and are not sponsored, affiliated or otherwise connected with any major brand.



A-826410M92 Yoke, .750" Rod (LH)



A-897659M1 Fork



A-8N577A Leveling Box Assembly w/ Fork (RH)
Adjustment is 18" to 21" center hole to center hole.



A-957E566 Knuckle



A-9N595 Pin



A-C5NN594E Handle



A-NCA577A Leveling Box Assembly w/o Fork (RH)



A-EC0N585A Fork

BUSHING



A-BUSH110 Bushing, Cat 0 (5 pk)
Length: 1.625" Inside Diameter: .625" Outside Diameter: .750"

BUSHING



A-BUSH111 Bushing, Cat I (2 pk)
Length: 1.375" Inside Diameter: .625" Outside Diameter: .875"

A-BUSH101 Bushing, Cat I & II (2 pk)
Length: 2" Inside Diameter: .750" Outside Diameter: 1"

A-BUSH102 Bushing, Cat I & II (2 pk)
Length: 1.625" Inside Diameter: .750" Outside Diameter: 1"

A-BUSH103 Bushing, Cat II & III (2 pk)
Length: 2" Inside Diameter: 1" Outside Diameter: 1.250"
Overall Diameter: 1.250"

A-BUSH104 Bushing, Cat I & II (2 pk)
Length: 1.750" Inside Diameter: .875" Outside Diameter: 1.125"

A-BUSH105 Bushing, Cat I & II (2 pk)
Length: 1.375" Inside Diameter: .875" Outside Diameter: 1.125"

A-BUSH106 Bushing, Cat II & III (2 pk)
Length: 1.750" Inside Diameter: 1.125" Outside Diameter: 1.437"

A-BUSH107 Bushing, Cat II & III (2 pk)
Length: 2.750" Inside Diameter: 1.125" Outside Diameter: 1.437"

A-BUSH108 Bushing, Cat II & III (2 pk)
Length: 3.250" Inside Diameter: 1.125" Outside Diameter: 1.437"

A-BUSH109 Bushing, Cat II & III (2 pk)
Length: 2.500" Inside Diameter: 1.125" Outside Diameter: 1.437"

A-BUSH112 Bushing, Cat II & III (2 pk)
Length: 4.250" Inside Diameter: 1.125" Outside Diameter: 1.437"

HITCH BUSHING



A-HB101 Bushing, Hitch, Cat II & III
Inside Diameter: 1.125" Outside Diameter: 1.437"

REPLACEMENT BALL



A-886428M1 Ball, Replacement, Cat I
Holes: .875" Outside Diameter: 2.250" Width: 1.375"

A-886429M1 Ball, Replacement, Cat II
Holes: 1.125" Outside Diameter: 2.250" Width: 1.760"

A-C5NN557B Ball, Replacement, Cat II
Holes: 1.125" Outside Diameter: 2.250" Width: 1.375"

A-RB001 Ball, Replacement, Cat I
Holes: .875" Outside Diameter: 2.250" Width: 1.375"

REPLACEMENT BALL



A-RB004 Ball, Replacement, Cat I

Used on JD & Oliver top link.

Holes: .750" Outside Diameter: 2" Width: 1.750"

A-RB002 Ball, Replacement, Cat II

Used on Ford lift arm.

Holes: 1.125" Outside Diameter: 2.234"

A-RB005 Ball, Replacement, Cat II

Used on JD & Oliver top link.

Holes: 1" Outside Diameter: 2" Width: 1.750"

A-RB006 Ball, Replacement, Cat II

Used on Oliver lift arm.

Holes: 1.125" Outside Diameter: 2" Width: 1.750"

A-RB008 Ball, Replacement, Cat II

Holes: 1.140" Outside Diameter: 2.520"

A-RB009 Ball, Replacement, Cat II

Holes: 1.125" Outside Diameter: 2.197" Width: 1.76"

A-RB003 Ball, Replacement, Cat III

Holes: 1.440" Outside Diameter: 2.520"

QUICK HITCH LOWER LINK BALL



A-VLE6121 Lower Link Ball, Quick Hitch, Cat III

Category: III Inside Diameter: 1.472" Outside Diameter: 2.520"

RETAINER SPRING

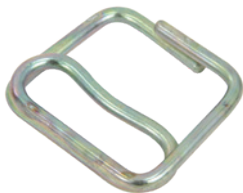

A-C5NNN557B Retainer Spring, Lift Link Ball

HYDRAULIC SIDE / TOP LINK CYLINDERS

NOTE APPLYS TO ALL: All ports .563"-18 ORB w/ two adapters .563"-18 ORBM X .250" NPTM 90° swivel.



A-SLH101 Hydraulic Side Link Cylinder, Cat 0 Base End w/ Clevis Rod End (2" Bore)

5.625" Clevis Depth, .875" Clevis Width, All Clevis Holes Drilled For .625" Pin
Barrel Length: 8.437" Base End Ball Inside Dia: .750"
Base End Width: 1.375" Base To Ball Center Lngth: 3.875"
Compressed Length: 15.500", 16.500" & 17.500"

A-SLH101RK Seal Kit



A-SLH102 Hydraulic Side Link Cylinder, Clevis Ends (3" Bore)

Barrel Length: 8.437" Base End Depth: 2" Base End Hole: .625"
Base End Width: 2" Compressed Length: 19.500", 21.500", 26" & 27.250"
Rod End Hole: .750" Upper, .625" Lower



A-SLH103 Hydraulic Side Link Cylinder, Cat I Base End/ Clevis Rod End (3" Bore)

.875", All Clevis Holes Drilled For .750" Pin Barrel Length: 8.438"
Base End Ball Inside Dia: .875" Base End Width: 1.750"
Base To Ball Center Lngth: 1.750"
Compressed Length: 20.500", 22.500", 26.875" & 28"

A-SLH103RK Seal Kit



A-SLH104 Hydraulic Side Link Cylinder, Clevis Ends (3" Bore)

Barrel Length: 8.438" Base End Depth: 3.375" Base End Hole: .750"
Base End Width: 2" Compressed Length: 23" Rod End Hole: .750"



A-TLH001 Hydraulic Top Link Cylinder (Cat I) (2" Bore)

Barrel Length: 12.438" Base End Ball Inside Dia: .750"
Base To Ball Center Lngth: 3.500" Compressed Length: 20"
Stroke: 8" PSI: 1450.377

A-TLH102RK Seal Kit

Parts are not Original Equipment parts and are not sponsored, affiliated or otherwise connected with any major brand.

Side/Top Link Cylinders, Cylinder Pins & Grab Hooks

HYDRAULIC SIDE / TOP LINK CYLINDERS



A-TLH002 Hydraulic Top Link Cylinder (Cat I) (2" Bore)

Barrel Length: 9" Base End Ball Inside Dia: .750"
 Base End Width: 1.563" Base To Ball Center Lngth: 3.813"
 Compressed Length: 15" Stroke: 5"

A-TLH102RK Seal Kit



A-TLH003 Hydraulic Top Link Cylinder (Cat I Rod/Cat II Base) (3" Bore)

Barrel Length: 12.438" Base End Ball Inside Dia: 1"
 Base To Ball Center Lngth: 3.500" Compressed Length: 20"
 Stroke: 8" PSI: 1450.377

A-TLH104RK Seal Kit



A-TLH004 Hydraulic Top Link Cylinder (Cat I Rod/Cat II Base) (3" Bore)

Barrel Length: 12.438" Base End Ball Inside Dia: 1"
 Base To Ball Center Lngth: 5.500" Compressed Length: 22"
 Stroke: 8" PSI: 1450.377

A-TLH104RK Seal Kit

A-TLH005 Hydraulic Top Link Cylinder (Cat II) (3" Bore)

Barrel Length: 12.438" Base To Ball Center Lngth: 5.500"
 Compressed Length: 26" Stroke: 8" PSI: 1450.377
 Working Pressure: 1450 lbs.

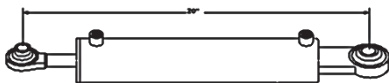

A-TLH006 Hydraulic Top Link Cylinder (Cat I) (2" Bore)

Barrel Length: 12.438" Base End Ball Inside Dia: .750"
 Base To Ball Center Lngth: 7.563" Compressed Length: 24.063"
 Stroke: 8" PSI: 1450.377

A-TLH007 Hydraulic Top Link Cylinder (Cat II) (3" Bore)

Part Sizes .750"-16 ORB
 Shaft Diameter: 28 mm Barrel Length: 12.438"
 Base End Ball Inside Dia: 1" Base To Ball Center Lngth: 2.500"
 Compressed Length: 21" Stroke: 8"

A-TLH104RK Seal Kit

A-TLH008 Hydraulic Top Link Cylinder (Cat I) (3" Bore)

Barrel Length: 12.438" Base End Ball Inside Dia: .750"
 Base To Ball Center Lngth: 3.500" Compressed Length: 20"
 Rod Diameter: 1.10" Stroke: 8"

HYDRAULIC CYLINDER PIN



A-HCP02 Pin, Hydraulic Cylinder

hair pin not included
 Used With Cylinder: w/ DC Diameter: 1"

A-HCP04 Pin, Hydraulic Cylinder

2 Reqd.
 Used With Cylinder: 2 1/8" Diameter: 1"

A-HCP05 Pin, Hydraulic Cylinder

Used With Cylinder: 2" to 4" Diameter: 1" Useable Length: 3"

HOOKS



A-7B804 Hook, Clevis Grab 1/4"

Chain Size: .250"

A-7B805 Hook, Clevis Grab 5/16"

Chain Size: .313" Grade: 30/43
 Material: Carbon Steel Working Load Limit: 2600 lbs.

A-7B806 Hook, Clevis Grab 3/8"

Chain Size: .375"

A-7B807 Hook, Clevis Grab 7/16"

Chain Size: .438"

A-7B810 Hook, Clevis Grab 5/8"

Chain Size: .625"



A-7B904 Hook, Slip, Shackle Type

Chain Size: .250"

A-7B905 Hook, Slip, Shackle Type

Chain Size: .313"

A-7B906 Hook, Slip, Shackle Type

Chain Size: .375"

A-7B907 Hook, Slip, Shackle Type

Chain Size: .438"

A-7B908 Hook, Slip, Shackle Type

Chain Size: .500"

Parts are not Original Equipment parts and are not sponsored, affiliated or otherwise connected with any major brand.

HITCH & PTO

Grab Hooks & Chainbinders



A-GH101 Hook, Grab, Drawbar
Fits drawbars up to 1.5" thick
Length: 7" Working Load Limit: 9500 lbs.



A-7B204 Hook, Grab, Eye Type
Chain Size: .250"

A-7B206 Hook, Grab, Eye Type
Chain Size: .375"



A-7B805T Hook, Grab, Clevis, Grade 70
Chain Size: .250" Hook Size: .313" Working Load Limit: 4700 lbs.

A-7B806T Hook, Grab, Clevis, Grade 70
Chain Size: .375" Hook Size: .375" Working Load Limit: 6600 lbs.



A-WH38 Hook, Weld On Chain, 3/8"
Chain Size: 3/8" Size: 3/8" G70 Working Load Limit: 6,600 Lbs.

A-WH516 Hook, Weld On Chain, 5/16"
Chain Size: 5/16" Working Load Limit: 1,900 Lbs.

Parts are not Original Equipment parts and are not sponsored, affiliated or otherwise connected with any major brand.

Tillage Contents

Miscellaneous Tillage Parts	153-157
Tiller Blades	146-152

Click to go back to top



TILLAGE

Tiller Blades

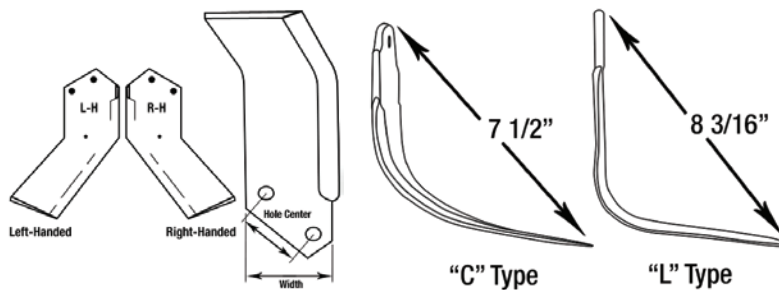

Agrator

PART	SHAPE	SIDE	THICKNESS	WIDTH	BOLT SIZE	HOLE CENTER
A-DO3-112	L Shape	LH	5/16"	3 1/8"	1/2"	2 1/4"
A-DO3-111	L Shape	RH	5/16"	3 1/8"	1/2"	2 1/4"
A-URO1354C	C Shape	LH	5/16"	3 1/8"	1/2"	2 1/4"
A-URO1355C	C Shape	RH	5/16"	3 1/8"	1/2"	2 1/4"
A-V042078	C Shape	RH	1/4"	2 5/16"	7/16"	1 3/8"
A-V042077	C Shape	LH	1/4"	2 5/16"	7/16"	1 3/8"

Agric

PART	SHAPE	SIDE	THICKNESS	WIDTH	BOLT SIZE	HOLE CENTER
A-TB013	L Shape	LH	1/4"	3 1/8"	7/16"	2 1/4"
A-TB014	L Shape	RH	1/4"	3 1/8"	7/16"	2 1/4"
A-TB088	C Shape	RH	1/4"	3 1/8"	7/16"	2 1/4"
A-TB089	C Shape	LH	1/4"	3 1/8"	7/16"	2 1/4"
A-36216L	L Shape	LH	5/16"	3 1/8"	1/2"	2 1/4"
A-36215R	L Shape	RH	5/16"	3 1/8"	1/2"	2 1/4"
A-TB019	C Shape	LH	5/16"	3 1/8"	1/2"	2 1/4"
A-TB020	C Shape	RH	5/16"	3 1/8"	1/2"	2 1/4"
A-TB072	C Shape	RH	1/4"	2 5/16"	7/16"	1 3/8"
A-TB073	C Shape	LH	1/4"	2 5/16"	7/16"	1 3/8"

Allis-Chalmers

PART	SHAPE	SIDE	THICKNESS	WIDTH	BOLT SIZE	HOLE CENTER
A-TB084	C Shape	LH	5/16"	1 9/16"	7/16"	4 1/2"
A-TB085	C Shape	RH	5/16"	1 9/16"	7/16"	4 1/2"

Befco

PART	SHAPE	SIDE	THICKNESS	WIDTH	BOLT SIZE	HOLE CENTER
A-TB009	L Shape	LH	5/16"	3 1/8"	1/2"	2 1/4"
A-TB010	L Shape	RH	5/16"	3 1/8"	1/2"	2 1/4"
A-TB019	C Shape	LH	5/16"	3 1/8"	1/2"	2 1/4"
A-TB020	C Shape	RH	5/16"	3 1/8"	1/2"	2 1/4"
A-277R	C Shape	RH	1/4"	2 1/4"	1/2"	1 9/16"
A-278L	C Shape	LH	1/4"	2 1/4"	1/2"	1 9/16"

Parts are not Original Equipment parts and are not sponsored, affiliated or otherwise connected with any major brand.

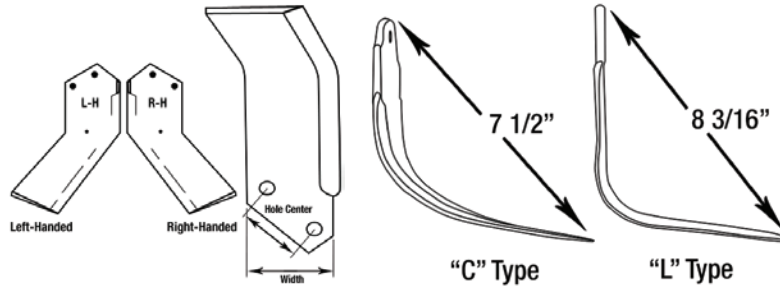

Parts are not Original Equipment parts and are not sponsored, affiliated or otherwise connected with any major brand.

Bush Hog

PART	SHAPE	SIDE	THICKNESS	WIDTH	BOLT SIZE	HOLE CENTER
A-TB080	C Shape	LH	5/16"	1 5/8"	12 MM	4 3/16"
A-TB081	C Shape	RH	5/16"	1 5/8"	12 MM	4 3/16"

Button Willow

PART	SHAPE	SIDE	THICKNESS	WIDTH	BOLT SIZE	HOLE CENTER
A-TB009	L Shape	LH	5/16"	3 1/8"	1/2"	2 1/4"
A-TB010	L Shape	RH	5/16"	3 1/8"	1/2"	2 1/4"

Caroni

PART	SHAPE	SIDE	THICKNESS	WIDTH	BOLT SIZE	HOLE CENTER
A-TB072	C Shape	RH	1/4"	2 5/16"	7/16"	1 3/8"
A-TB073	C Shape	LH	1/4"	2 5/16"	7/16"	1 3/8"

Celli

PART	SHAPE	SIDE	THICKNESS	WIDTH	BOLT SIZE	HOLE CENTER
A-TB120	C Shape	RH	1/4"	2 1/4"	1/2"	1 9/16"
A-TB121	C Shape	LH	1/4"	2 1/4"	1/2"	1 9/16"

Douglas

PART	SHAPE	SIDE	THICKNESS	WIDTH	BOLT SIZE	HOLE CENTER
A-TB009	L Shape	LH	5/16"	3 1/8"	1/2"	2 1/4"
A-TB010	L Shape	RH	5/16"	3 1/8"	1/2"	2 1/4"
A-TB019	C Shape	LH	5/16"	3 1/8"	1/2"	2 1/4"
A-TB020	C Shape	RH	5/16"	3 1/8"	1/2"	2 1/4"
A-TB120	C Shape	RH	1/4"	2 1/4"	1/2"	1 9/16"
A-TB121	C Shape	LH	1/4"	2 1/4"	1/2"	1 9/16"

Ford / New Holland

PART	SHAPE	SIDE	THICKNESS	WIDTH	BOLT SIZE	HOLE CENTER
A-9942	C Shape	LH	5/16"	1 9/16"	7/16"	4 1/2"
A-TB085	C Shape	RH	5/16"	1 9/16"	7/16"	4 1/2"
A-1400078	C Shape	LH	5/16"	1 5/8"	12 MM	4 3/16"
A-1400077	C Shape	RH	5/16"	1 5/8"	12 MM	4 3/16"

Honda

PART	SHAPE	SIDE	THICKNESS	WIDTH	BOLT SIZE	HOLE CENTER
A-1400082	C Shape	LH	5/16"	1 5/8"	12 MM	4 3/16"
A-1400081	C Shape	RH	5/16"	1 5/8"	12 MM	4 3/16"

TILLAGE

Tiller Blades

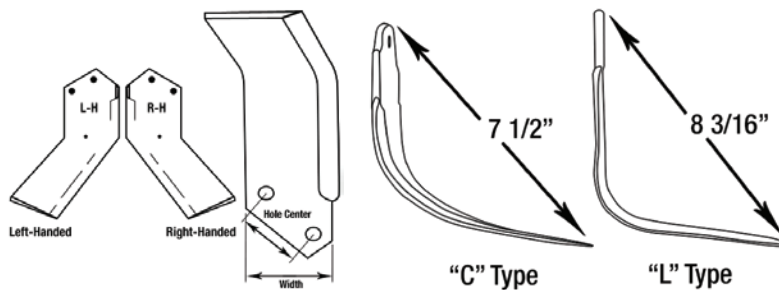

Howard

PART	SHAPE	SIDE	THICKNESS	WIDTH	BOLT SIZE	HOLE CENTER
A-635933900-9930	L Shape	LH	5/16"	3 1/8"	1/2"	2 1/4"
A-635923901-9931	L Shape	RH	5/16"	3 1/8"	1/2"	2 1/4"
A-9948	C Shape	LH	5/16"	3 1/8"	1/2"	2 1/4"
A-9949	C Shape	RH	5/16"	3 1/8"	1/2"	2 1/4"
A-9901	L Shape	LH	1/4"	3 1/8"	7/16"	2 1/4"
A-9900	L Shape	RH	1/4"	3 1/8"	7/16"	2 1/4"
A-9954	C Shape	RH	1/4"	3 1/8"	7/16"	2 1/4"
A-9953	C Shape	LH	1/4"	3 1/8"	7/16"	2 1/4"
A-9942	C Shape	LH	5/16"	1 9/16"	7/16"	4 1/2"
A-TB085	C Shape	RH	5/16"	1 9/16"	7/16"	4 1/2"
A-R661061	C Shape	RH	1/4"	2 1/4"	1/2"	1 9/16"
A-L661060	C Shape	LH	1/4"	2 1/4"	1/2"	1 9/16"
A-9862	L Shape	RH	3/8"	3 1/8"	5/8"	2"
A-9863	L Shape	LH	3/8"	3 1/8"	5/8"	2"
A-9950	C Shape	LH	3/8"	3 1/8"	5/8"	2"
A-9851	C Shape	RH	3/8"	3 1/8"	5/8"	2"

IMCO

PART	SHAPE	SIDE	THICKNESS	WIDTH	BOLT SIZE	HOLE CENTER
A-TB140	L Shape	LH	5/16"	1 3/4"	12 MM	4 3/4"
A-TB141	L Shape	RH	5/16"	1 3/4"	12 MM	4 3/4"

John Deere

PART	SHAPE	SIDE	THICKNESS	WIDTH	BOLT SIZE	HOLE CENTER
A-9942	C Shape	LH	5/16"	1 9/16"	7/16"	4 1/2"
A-TB085	C Shape	RH	5/16"	1 9/16"	7/16"	4 1/2"
A-PT8444	L Shape	LH	1/4"	3 1/8"	7/16"	2 1/4"
A-PT8445	L Shape	RH	1/4"	3 1/8"	7/16"	2 1/4"
A-TB088	C Shape	RH	1/4"	3 1/8"	7/16"	2 1/4"
A-TB089	C Shape	LH	1/4"	3 1/8"	7/16"	2 1/4"
A-TB009	L Shape	LH	5/16"	3 1/8"	1/2"	2 1/4"
A-TB010	L Shape	RH	5/16"	3 1/8"	1/2"	2 1/4"

KMC

PART	SHAPE	SIDE	THICKNESS	WIDTH	BOLT SIZE	HOLE CENTER
A-TB084	C Shape	LH	5/16"	1 9/16"	7/16"	4 1/2"
A-TB085	C Shape	RH	5/16"	1 9/16"	7/16"	4 1/2"

Parts are not Original Equipment parts and are not sponsored, affiliated or otherwise connected with any major brand.

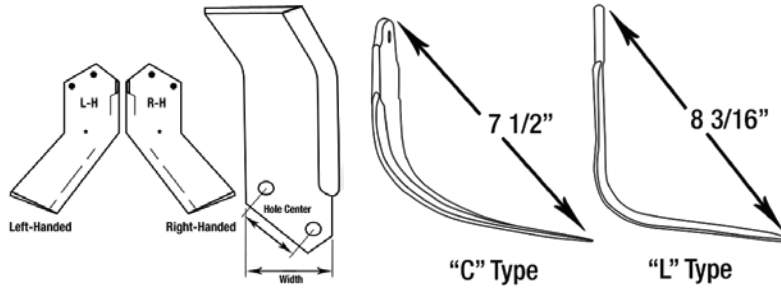

Parts are not Original Equipment parts and are not sponsored, affiliated or otherwise connected with any major brand.

Kronevator

PART	SHAPE	SIDE	THICKNESS	WIDTH	BOLT SIZE	HOLE CENTER
A-TB038	C Shape	RH	3/8"	3 1/8"	9/16"	2 1/4"
A-TB039	C Shape	LH	3/8"	3 1/8"	9/16"	2 1/4"
A-0340200L	L Shape	LH	5/16"	1 3/4"	12 MM	4 3/4"
A-0341090R	L Shape	RH	5/16"	1 3/4"	12 MM	4 3/4"

Kubota

PART	SHAPE	SIDE	THICKNESS	WIDTH	BOLT SIZE	HOLE CENTER
A-1400078	C Shape	LH	5/16"	1 5/8"	12 MM	4 3/16"
A-1400077	C Shape	RH	5/16"	1 5/8"	12 MM	4 3/16"
A-TB013	L Shape	LH	1/4"	3 1/8"	7/16"	2 1/4"
A-TB014	L Shape	RH	1/4"	3 1/8"	7/16"	2 1/4"
A-461R	C Shape	RH	1/4"	3 1/8"	7/16"	2 1/4"
A-461L	C Shape	LH	1/4"	3 1/8"	7/16"	2 1/4"
A-TB084	C Shape	LH	5/16"	1 9/16"	7/16"	4 1/2"
A-TB085	C Shape	RH	5/16"	1 9/16"	7/16"	4 1/2"

Kuhn

PART	SHAPE	SIDE	THICKNESS	WIDTH	BOLT SIZE	HOLE CENTER
A-TB080	C Shape	LH	5/16"	1 5/8"	12 MM	4 3/16"
A-TB081	C Shape	RH	5/16"	1 5/8"	12 MM	4 3/16"
A-52166400	L Shape	LH	1/4"	3 1/8"	7/16"	2 1/4"
A-52106300	L Shape	RH	1/4"	3 1/8"	7/16"	2 1/4"
A-51921500	L Shape	LH	5/16"	3 1/8"	1/2"	2 1/4"
A-51921600	L Shape	RH	5/16"	3 1/8"	1/2"	2 1/4"
A-TB038	C Shape	RH	3/8"	3 1/8"	9/16"	2 1/4"
A-TB039	C Shape	LH	3/8"	3 1/8"	9/16"	2 1/4"

Land Pride

PART	SHAPE	SIDE	THICKNESS	WIDTH	BOLT SIZE	HOLE CENTER
A-RALC	C Shape	RH	1/4"	2 3/8"	1/2"	1 3/4"
A-LALC	C Shape	LH	1/4"	2 3/8"	1/2"	1 3/4"
A-TB038	C Shape	RH	3/8"	3 1/8"	9/16"	2 1/4"
A-TB039	C Shape	LH	3/8"	3 1/8"	9/16"	2 1/4"
A-TB040	L Shape	RH	.310"	3 1/8"	9/16"	2 1/4"
A-TB041	L Shape	LH	.310"	3 1/8"	9/16"	2 1/4"
A-277R	C Shape	RH	1/4"	2 1/4"	1/2"	1 9/16"
A-278L	C Shape	LH	1/4"	2 1/4"	1/2"	1 9/16"

TILLAGE

Tiller Blades

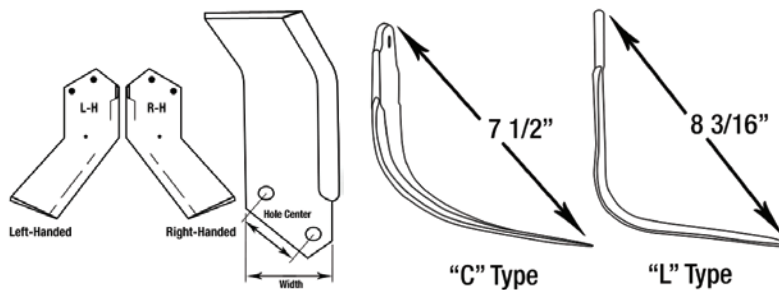

Maletti

PART	SHAPE	SIDE	THICKNESS	WIDTH	BOLT SIZE	HOLE CENTER
A-TB080	C Shape	LH	5/16"	1 5/8"	12 MM	4 3/16"
A-TB081	C Shape	RH	5/16"	1 5/8"	12 MM	4 3/16"

Marvin

PART	SHAPE	SIDE	THICKNESS	WIDTH	BOLT SIZE	HOLE CENTER
A-TB009	L Shape	LH	5/16"	3 1/8"	1/2"	2 1/4"
A-TB010	L Shape	RH	5/16"	3 1/8"	1/2"	2 1/4"

Maschio

PART	SHAPE	SIDE	THICKNESS	WIDTH	BOLT SIZE	HOLE CENTER
A-1110426	C Shape	RH	3/8"	3 1/8"	9/16"	2 1/4"
A-1110427	C Shape	LH	3/8"	3 1/8"	9/16"	2 1/4"
A-1110428	L Shape	RH	5/16"	3 1/8"	9/16"	2 1/4"
A-1110429	L Shape	LH	5/16"	3 1/8"	9/16"	2 1/4"
A-27100209	- Shape	LH	3/8"	3 9/16"	11/16"	2"
A-27100210	- Shape	RH	3/8"	3 9/16"	11/16"	2"
A-36100210	L Shape	RH	1/2"	3 15/16"	11/16"	2 3/8"
A-36100211	L Shape	LH	1/2"	3 15/16"	11/16"	2 3/8"
A-21100412	L Shape	RH	1/4"	2 3/8"	10 MM	2 3/16"
A-21100413	L Shape	LH	1/4"	2 3/8"	10 MM	2 3/16"
A-TB034	L Shape	LH	1/4"	2 3/4"	9/16"	2 1/4"
A-TB035	L Shape	RH	1/4"	2 3/4"	9/16"	2 1/4"
A-TB036	C Shape	RH	1/4"	3 3/16"	9/16"	2 1/4"
A-TB037	C Shape	LH	1/4"	3 3/16"	9/16"	2 1/4"
A-26100417	- Shape	RH	5/16"	3 1/8"	9/16"	1 3/4"
A-26100418	- Shape	LH	5/16"	3 1/8"	9/16"	1 3/4"
A-TB064	L Shape	LH	1/4"	3 3/16"	9/16"	1 7/8"
A-TB065	L Shape	RH	1/4"	3 3/16"	9/16"	1 7/8"

Massey Ferguson

PART	SHAPE	SIDE	THICKNESS	WIDTH	BOLT SIZE	HOLE CENTER
A-9942	C Shape	LH	5/16"	1 9/16"	7/16"	4 1/2"
A-TB085	C Shape	RH	5/16"	1 9/16"	7/16"	4 1/2"

Parts are not Original Equipment parts and are not sponsored, affiliated or otherwise connected with any major brand.

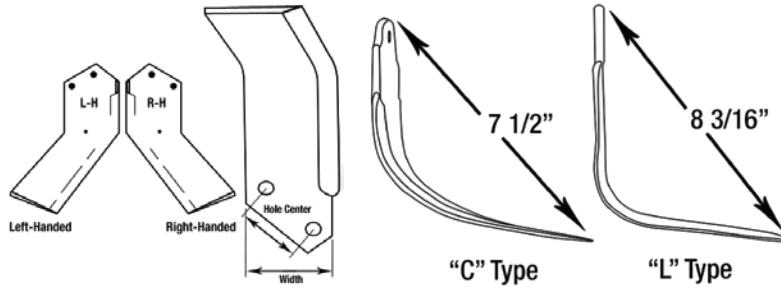

Parts are not Original Equipment parts and are not sponsored, affiliated or otherwise connected with any major brand.

Muratori						
PART	SHAPE	SIDE	THICKNESS	WIDTH	BOLT SIZE	HOLE CENTER
A-TB140	L Shape	LH	5/16"	1 3/4"	12 MM	4 3/4"
A-TB141	L Shape	RH	5/16"	1 3/4"	12 MM	4 3/4"
A-120002000	L Shape	RH	5/16"	2 3/4"	1/2"	1 13/16"
A-12002100	L Shape	LH	5/16"	2 3/4"	1/2"	1 13/16"
A-TB164	C Shape	RH	5/16"	2 3/4"	1/2"	1 13/16"
A-TB165	C Shape	LH	5/16"	2 3/4"	1/2"	1 13/16"

Ortlan						
PART	SHAPE	SIDE	THICKNESS	WIDTH	BOLT SIZE	HOLE CENTER
A-566103	C Shape	RH	1/4"	2 3/8"	12 MM	2 9/16"
A-566153	C Shape	LH	1/4"	2 3/8"	12 MM	2 9/16"

Panorama						
PART	SHAPE	SIDE	THICKNESS	WIDTH	BOLT SIZE	HOLE CENTER
A-TB080	C Shape	LH	5/16"	1 5/8"	12 MM	4 3/16"
A-TB081	C Shape	RH	5/16"	1 5/8"	12 MM	4 3/16"

Pasquali						
PART	SHAPE	SIDE	THICKNESS	WIDTH	BOLT SIZE	HOLE CENTER
A-TB164	C Shape	RH	5/16"	2 3/4"	1/2"	1 13/16"
A-TB165	C Shape	LH	5/16"	2 3/4"	1/2"	1 13/16"
A-TB163	LH, L-Shape	12 MM	1 13/16"			
A-TB162	RH, L-Shape	12 MM	1 13/16"			

Rome						
PART	SHAPE	SIDE	THICKNESS	WIDTH	BOLT SIZE	HOLE CENTER
A-TB009	L Shape	LH	5/16"	3 1/8"	1/2"	2 1/4"
A-TB010	L Shape	RH	5/16"	3 1/8"	1/2"	2 1/4"
A-TB019	C Shape	LH	5/16"	3 1/8"	1/2"	2 1/4"
A-TB020	C Shape	RH	5/16"	3 1/8"	1/2"	2 1/4"

Sovema						
PART	SHAPE	SIDE	THICKNESS	WIDTH	BOLT SIZE	HOLE CENTER
A-900111007	L Shape	RH	5/16"	2 3/4"	1/2"	1 13/16"
A-900111008	L Shape	LH	5/16"	2 3/4"	1/2"	1 13/16"
A-TB164	C Shape	RH	5/16"	2 3/4"	1/2"	1 13/16"
A-TB165	C Shape	LH	5/16"	2 3/4"	1/2"	1 13/16"
A-90011109	L Shape	RH	5/16"	2 3/4"	9/16"	1 13/16"

TILLAGE

Tiller Blades

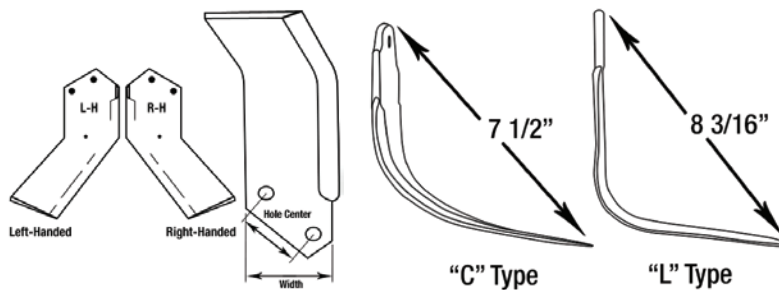

Terranova

PART	SHAPE	SIDE	THICKNESS	WIDTH	BOLT SIZE	HOLE CENTER
A-26100417	- Shape	RH	5/16"	3 1/8"	9/16"	1 3/4"
A-26100418	- Shape	LH	5/16"	3 1/8"	9/16"	1 3/4"
A-TB038	C Shape	RH	3/8"	3 1/8"	9/16"	2 1/4"
A-TB039	C Shape	LH	3/8"	3 1/8"	9/16"	2 1/4"
A-27100209	- Shape	LH	3/8"	3 9/16"	11/16"	2"
A-27100210	- Shape	RH	3/8"	3 9/16"	11/16"	2"
A-36100210	L Shape	RH	1/2"	3 15/16"	11/16"	2 3/8"
A-36100211	L Shape	LH	1/2"	3 15/16"	11/16"	2 3/8"
A-566103	C Shape	RH	1/4"	2 3/8"	12 MM	2 9/16"
A-566153	C Shape	LH	1/4"	2 3/8"	12 MM	2 9/16"

Yanmar

PART	SHAPE	SIDE	THICKNESS	WIDTH	BOLT SIZE	HOLE CENTER
A-412130R	C Shape	RH	1/4"	2 5/8"	12 MM	2 9/16"
A-412129L	C Shape	LH	1/4"	2 5/8"	12 MM	2 9/16"
A-9942	C Shape	LH	5/16"	1 9/16"	7/16"	4 1/2"
A-TB085	C Shape	RH	5/16"	1 9/16"	7/16"	4 1/2"

Parts are not Original Equipment parts and are not sponsored, affiliated or otherwise connected with any major brand.

Bush Hog



A-95120 Pulverizer Tooth
 PKG QTY: minimum order qty 10

For Models: (PULVERIZER: PVS600, PVS602, PVS660, PVS662, PVS720, PVS722, PVS840, PVS842)



A-95119 U-Bolt Kit, V-Bend, 7/16"
 PKG QTY: minimum order qty 10

For Models: (PULVERIZER: PVS600, PVS602, PVS660, PVS662, PVS720, PVS722, PVS840, PVS842)

Case-IH

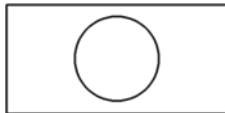

A-P34101 Lock Plate
 PKG QTY: minimum order qty 10

For Models: (DISC HARROW: 120, 120F, 122, 130, 132, 150, 330, 37, 370, 46, 470, 48, 60, 60F, 61)

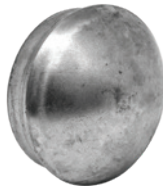

A-HC103 Hub Cap
 1.968" O.D.

For Models: (DISC HARROW: 475, 475DH, 480, 485, 490, 496, 500, 501), (FORAGE HARVESTER: 55, 550), (DISC HARROW: 596, 610), (FORAGE HARVESTER: 650), (DISC HARROW: 760, 770)

John Deere



A-8A324 Bearing Kit

For Models: (DISC HARROW: 1630, 1635, 1640, TW, TWA)



A-AB14028 Bearing Set

For Models: (DISC HARROW: 1630, 1635, 1640)

A-AA28186 Bearing

For Models: (DISC HARROW: 310, 315, 330, 331, 335, 340, 350, 355, 360, 370, 425, 635, 637, 640, 650, 670), (RIPPER: 510, 512)



A-AA28184 Heavy Disc Bearing, Round Bore, Relubable

Bore: 1.750"
 Lube Type: Relubable
 Bearing Type: 2
 Outside Diameter: 3.346"
 Bore Type: Round
 Inner Ring: 1.438"

For Models: (DISC HARROW: 210, 215, 220 SERIES, 230, 235, 621, 627, 630, 637), (MULCHER/FINISHER: 714, 722, 724, 726)



A-N405093 Scraper Blade; 5"

For Models: (DISC HARROW: 2620, 2623, 2625, 2630, 2633, 2635), (DISC RIPPER: 2720, 2730)

Kewanee



A-B1876 Seal

For Models: (DISC HARROW: (700, 900 ALL DISC HARROW))

Land Pride



A-820-049C Pulverizer Tooth

PKG QTY: minimum order qty 10

For Models: (PULVERIZER: SP1548, SP1556, SP1560, SP1572)

Parts are not Original Equipment parts and are not sponsored, affiliated or otherwise connected with any major brand.

TILLAGE

Miscellaneous Tillage Parts



A-806-041C U-Bolt Kit, 1/2" V-Bend
 PKG QTY: minimum order qty 10

For Models: (PULVERIZER: SP1548, SP1556, SP1560, SP1572)

Massey Ferguson



A-1037463M1 Sleeve, Wheel Wear

For Models: (PLOW, CHISEL: 129, 139), (CULTIVATOR: 259), (PLOW: 43, 59, 82, 345, 570, 880), (DISC HARROW: 30, 38, 40, 41, 520, 720, 730, 820)

White/ Oliver/ Mpl Moline



A-8013 Coultter Spindle
 Used To Repair Spindle On Coultter Arm. Instead Of Changing Arm, Cut Out Old Bearing Shaft, Install New Bearing Shaft And Weld In Place
 3/4" Thread

For Models: (PLOW: SEVERAL Except Very Early Models)

Woods



A-20A122 Pulverizer Tooth
 5/8" X 5/8" X 8"
 PKG QTY: minimum order qty 10

For Models: (PULVERIZER: 20A100, 20A130, 20A200, 20A230, 20A500, 20A5002, 20A600, 20A6002, SU100, SU130, SU140, SU200, SU230, SU240)



A-20A108 U-Bolt Kit, V-Bend, 7/16"
 PKG QTY: minimum order qty 10

For Models: (PULVERIZER: 20A100, 20A130, 20A200, 20A230, 20A500, 20A5002, 20A600, 20A6002, SU100, SU130, SU140, SU200, SU230, SU240)

Miscellaneous

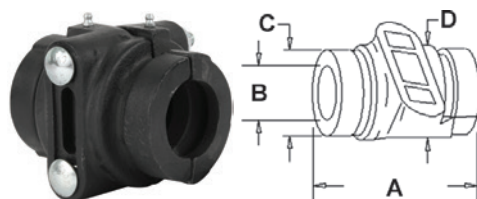

A-VLH6703 Bearing Cap w/ Grease Fitting (Set of 2 w/ Hardware)

Cast Iron, Painted Black (2 Included in Set)
 3.0625" Bolt Hole Spacing C-to-C
 A: 5.125"
 B: 1.062"
 C: 1.687"
 D: 2"



A-VLG2383 1/2"x5" Carriage Bolt



A-HD12NCNUT 1/2"-13 Hex Nut



A-HD12LW 1/2" Lockwasher (Plated)

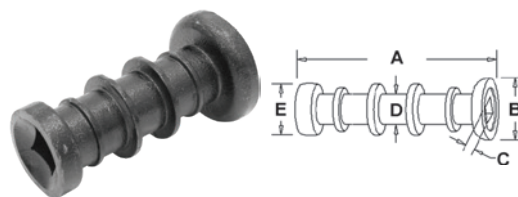

A-VLH6702 Rib Spool
 for 1" Axles
 A: 7.436"
 B: 4"
 C: 1.062"
 D: 2"
 E: 3"

Parts are not Original Equipment parts and are not sponsored, affiliated or otherwise connected with any major brand.



A-VLH6710 Cap & Spool Kit
For 1" Axles
2 Grease Zerks

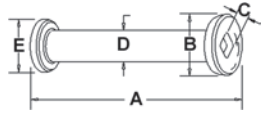

A-VLH6707 Plain Spool 9"
For 1" Axles, Cast Iron, Painted Black
A: 9"
B: 4"
C: 1.062"
D: 2"
E: 3"

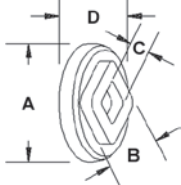

A-VLH6705 Washer, Small
For 1" Axles, Cast Iron, Painted Black
A: 3.562"
B: 1.875"
C: 1.062"
D: 1.312"

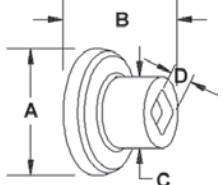

A-VLH6708 Spool Spacer 2-3/8"
For 1" Axle, Cast Iron, Painted Black
A: 4"
B: 2.375"
C: 2.250"
D: 1.125"

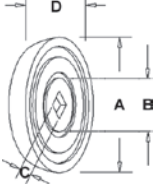

A-VLH6706 Washer, Large
For 1" Axles, Cast Iron, Painted Black
A: 6.437"
B: 1.750"
C: 1.062"
D: 1.125"

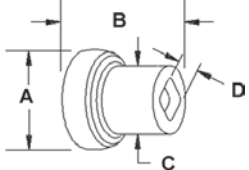

A-VLH6709 Spool Spacer 3-5/8"
For 1" Axle, Cast Iron, Painted Black
A: 3"
B: 3.312"
C: 2.250"
D: 1.000"

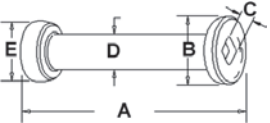

A-VLH6704 Plain Spool 7 1/2"
For 1" Axles, Cast Iron, Painted Black
A: 7.434"
B: 4"
C: 1.062"
D: 2"
E: 3"



A-HD1NCNUT Hub Axle Nut, 1"-8 HEX, Grade 5
Inside Diameter: 1"-8

Parts are not Original Equipment parts and are not sponsored, affiliated or otherwise connected with any major brand.

TILLAGE

Miscellaneous Tillage Parts



A-W210PP4-I Disc Bearing; Cylindrical, Square Bore, Pre-Lube
 For 3416 Housing
 Bore: 1.125"
 Lube Type: Pre-lubed
 Outside Diameter: 3.5433"
 Bore Type: Square
 Inner Ring: 1.188"
 Outer Ring: 1.188"

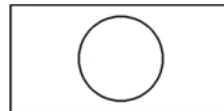

A-76N341 Lock Plate
 Sold in Multiples of 10
 Inside Diameter: 1.19"
 Thickness: .13"
 Width: 4.00"
 Height: 1.88"
 PKG QTY: minimum order qty 10



A-11078IMP Import Bearing for 3416 Housing

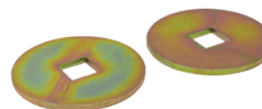

A-76N4512 Slack Washer (Set of 2)
 1.125" square hole, sold in multiples of 2
 Inside Diameter: .250"
 Outside Diameter: 5"
 PKG QTY: minimum order qty 2



A-J9554A Hipper Bearing
 repl. DC208TT5
 1-1/8" SQ. BORE



A-76N501 Drag Chain (2 pk)
 High efficiency, use w/ standard seed drill.
 Loop Dia: 2.5"
 Overall Length: 21"
 PKG QTY: minimum order qty 2



A-J9554AIMP Hipper Bearing, Import
 Repl. W208PP5
 1-1/8" Sq. Bore



A-VLH1004 2" Rev Point
 11" x 2" x 1/4"
 9/16" square bolt hole and 9/16" x 1-3/8" slotted ctr hole

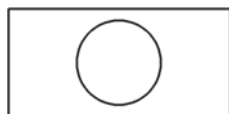

A-2116 Lock Plate
 Sold in Multiples of 10
 PKG QTY: minimum order qty 10

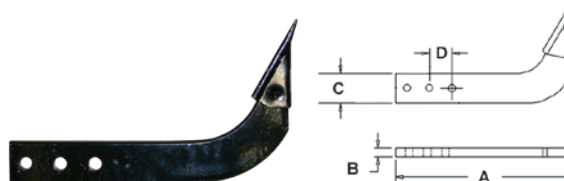

A-BSS2534C Box Scraper Shank w/ Point
 .687" holes in shanks center
 A: 16"
 B: .750"
 C: 2.5"
 D: 2"

Parts are not Original Equipment parts and are not sponsored, affiliated or otherwise connected with any major brand.

Miscellaneous Tillage Parts

Parts are not Original Equipment parts and are not sponsored, affiliated or otherwise connected with any major brand.

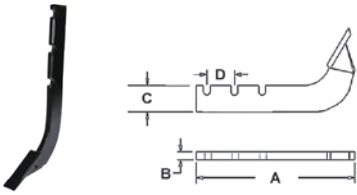

A-BSS2534N Box Scraper Shank w/ Point
 .625" notches in shanks front
 A: 17.5"
 B: .750"
 C: 2.375"
 D: 3.625"

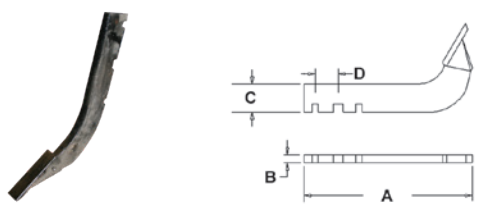

A-BSS2534BN Box Scraper Shank w/ Point
 .562" notches in shanks back
 A: 15.250"
 B: .750"
 C: 2.5"
 D: 3.625"

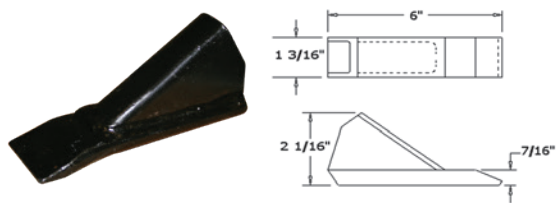

A-BSP8075 Box Scraper Point

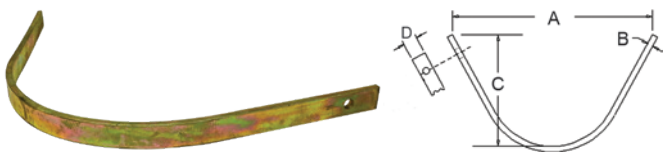

A-RRT1 Rock Rake Tooth
 .375" mounting hole
 A - 17"
 B - .315"
 C - 9 5/8"
 D - 1"

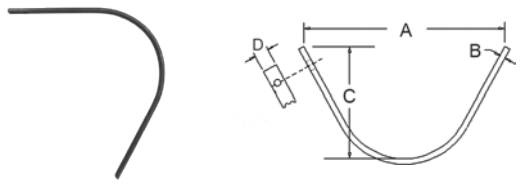

A-ELSR01 Woods Landscape Rake Tine
 A - 17 1/4"
 B - 0.325"
 C - 9"
 D - 1"

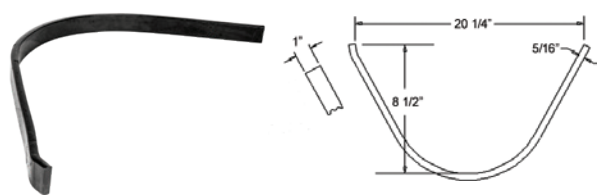

A-ELSR06 Landpride Landscape Rake Tine
 A - 20 1/4"
 B - 5/16"
 C - 8 1/2"
 D - 1"



A-EPT001 Pulverizer Tooth
 5/8" X 5/8" Square x 8" Long



A-EPT010 Pulverizer 7/16" V-Bend U-Bolt Kit



A-EPT011 Pulverizer 1/2" V-Bend U-Bolt Kit

QUIKSTEM

The Push-in Tire Valve Stem®

Introducing QuikStem, The Push-in Tire Valve Stem That Installs From The Outside.

QuikStem turns the huge hassle of a bad valve stem into a 30 second no big deal!

Don't come walking home with a tire under your arm. Fix it where you broke it and get back in the action!

Easily repair dry rotted, leaking, or broken stems
**WITHOUT REMOVING THE WHEEL
OR BREAKING THE BEAD.**

1/2 the cost of replacing a traditional stem and less than 1% of the work!

Rated to 200PSI. As strong or stronger than the stem you broke. QuikStem holds 3 US Patents.

GROMMET EXPANDS AND COMPRESSES TO COMPLETE THE SEAL

BEFORE TIGHTENING

AFTER TIGHTENING

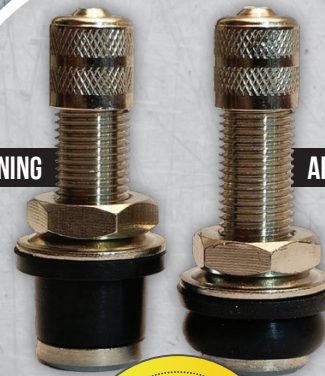

Part No.	Size	Stem Length
A-QS100	.453"	Short
A-QS430	.453"	Long
A-QS515	.625"	Short
A-QS500	.625"	Long

MULTI-APPLICATION



NOT RECOMMENDED FOR ON HIGHWAY VEHICLES

**VALVE STEMS BREAK. YOUR NERVES
AND BUDGET DON'T HAVE TO.**



WWW.AIPRODUCTS.COM PHONE: 1-800-657-4343 FAX: 1-800-511-0516



Easy 30 Second Install!

Find your size!

.453 (Most Tires)

ATVs, UTVs, Dirt Bikes,
Dune Buggies, Lawn Mowers,
Wheelbarrows, & Farm Equipment.

.625 (Large Tires)

Tractors, Ag Equipment, Loaders,
Heavy Equipment



VISIT QUIKSTEM ON YOUTUBE!



**EVERY MACHINE IN YOUR FLEET NEEDS ONE
IN THE TOOLBOX OR GLOVE COMPARTMENT**



WARRANTY LABOR SUPPLEMENT

Parts that are warrantable per the A&I Products warranty policy are eligible for labor compensation, with select exclusions noted below. This is a predetermined flat rate labor hours to perform the repair established by A&I Products independent of make, model, or brand. The hourly labor rate applied will be your published retail hourly shop rate. This shop rate must be supplied to A&I/Sunbelt to be eligible for warranty labor supplement. Additional compensation for service calls, trucking, mileage, shop fees, etc. will not be issued per warranty policy. This labor warranty supplement is extended only to direct customers of A&I Products. Over the counter sales, parts installed by third parties, or end-use customers do not qualify. To be eligible to receive the labor supplement, a copy of the original detailed work order showing installation of the failed part by an authorized A&I reseller must accompany the initial warranty submission.

ITEMS NOT COVERED BY LABOR SUPPLEMENT

1. Briggs & Stratton
2. Fleetguard
3. Mi-T-M
4. Industrial Belts
5. Hardware
6. Filters
7. Hydraulic Hose

SERVICES NOT COVERED BY LABOR SUPPLEMENT

1. Technician time and service vehicle travel cost between resellers business and worksite.
2. Transporting equipment to and from worksite.
3. Overtime labor premiums requested by the customer.

Warranty Labor Supplement mirrors the warranty period for the eligible parts listed in the chart on the previous page.

FREIGHT POLICIES

PRICES, TERMS, AND DISCOUNTS ARE ALWAYS SUBJECT TO CHANGE WITHOUT NOTICE.

FREIGHT

We reserve the right to use the carrier of our choice. Orders have a 3:30 pm local cutoff at all locations to ship same day if parcel, next day ship if LTL. Items shipped regionally from the Rock Valley, Iowa location via Speedee parcel are subject to a 2:30 pm cutoff for same day shipping. Orders received after cutoff will ship the next day.

AG & INDUSTRIAL FREIGHT DISCOUNT POLICY (Any order that includes Ag & Industrial Product)

A&I Products offers a freight policy that offers free freight on qualifying orders. As all policies do, this policy has guidelines that must be followed in order for a customer to take advantage of its benefits. The guidelines of our freight policy are as follows:

- 1) For standard, non-truck freight orders, the original product order must be \$350.00 USA funds or greater. For orders including truck freight items, the order must be \$1250 USA funds or greater. (THIS IS NOT INCLUDING FREIGHT COST OR CORE CHARGES. PARTS MUST BE SHIPPED TO A SINGLE LOCATION.)
- 2) Customer's account must be current in order to qualify for free freight program.
- 3) Freight discount will only be granted on standard, A&I prepaid ground and truck freight. No freight allowance is offered on shipments of premium rate, including Next Day Air and Second Day Air. Accounts set up with collect or third party billing do not qualify for free freight. On truck freight orders, any additional charges incurred due to residential, PO Box addresses, or special requirements are the responsibility of the customer. Only the normal truck freight charges qualify for the freight discount.
 - 3.1) Only shipments within the contiguous United States or contiguous Canadian Provinces are eligible. Shipments to Hawaii, Alaska, any other remote US or Canadian territory, and International shipments are not eligible for the freight discount policy.
- 4) No freight allowance is offered on special order products or orders drop shipped directly from vendor.
 - 4.1) Shipping method of drop shipped items may be subject to the discretion of the vendor.
- 5) Back orders on an original qualifying order will be allowed to take advantage of the freight policy.
- 6) A handling fee of \$4.50 is charged on all packages drop shipped from an A&I Products/Sunbelt warehouse.
- 7) Briggs & Stratton Engines are subject to handling fees in addition to any regular freight policies, if applicable. Handling fees are calculated based on the total invoiced dollars of engines per single order. Handling fees for Briggs & Stratton Engines are as follows:

DOLLAR VALUE OF B&S ENGINES ON SINGLE ORDER	HANDLING FEE
Up to \$150.00	\$0.00
\$150.01 - \$499.99	\$15.00
\$500.00 - \$1499.99	\$30.00
\$1500.00 - \$2499.99	\$45.00
\$2500.00+	\$0.00

TURF FREIGHT DISCOUNT POLICY (Any order that includes ONLY Turf Product & products categorized as turf-eligible product)

ORDER SIZE	FREIGHT
Less than \$199.99	Standard Freight Charges Apply
\$200+	Free Freight

Special Note: Engines, Decks, and Sprayer Tanks will be charged freight and handling fees. Briggs & Stratton Engines are subject to handling fees in addition to any regular freight policies, if applicable. Handling fees are calculated based on the total invoiced dollars of engines per single order. Handling fees for Briggs & Stratton Engines are listed under point (7) above.

The customer is responsible for any and all freight charges on factory direct shipments. Customer is also responsible for any freight charges for Air Freight shipments or special requests.

Damaged Shipments & Shortages on Carrier (Truck Freight) & Courier (UPS and other parcel companies)

Please refer to Terms & Conditions.

Any customers that do not follow these guidelines put themselves in danger of losing their privileges to this discount. Please take advantage of this discount but do not abuse the guidelines. If you have any questions, call 1-800-657-4343.

PRIVACY POLICY

We value the trust you place in A&I Products. We want to ensure you understand what information we gather, how we use it, and the safeguards we have in place to protect it.

In limited circumstances, we collect information necessary to process and complete your order. These include your name, address, phone number, e-mail address, and credit card information. This information may be stored and processed by A&I or by its parent company. A&I Products does not rent or sell customer information to third parties.

Visit and login to our website www.aiproductions.com or www.sunbeltparts.com to see our complete privacy and data collection policies.

Prices noted are in US dollars. Policies and Terms are subject to change, please refer to our website for the most up to date information.



WARNING: Cancer and Reproductive Harm - www.P65Warnings.ca.gov
AVERTISSEMENT: Cancer et Troubles de l'appareil reproducteur - www.P65Warnings.ca.gov
ADVERTENCIA: Cáncer y Daño Reproductivo - www.P65Warnings.ca.gov



POLICIES & PROCEDURES

A&I Products* | Sunbelt Outdoor Products, a Division of ATI Products Inc., is hereafter referred to as "A&I" or "Sunbelt." A&I and Sunbelt are collectively referred to as "we" or "us". Only authorized A&I or Sunbelt resellers ("Resellers") may place orders. To become a Reseller, A&I/Sunbelt require a completed and approved application, including a credit check and written business plan. To continue as a Reseller, Resellers must comply with these Terms and Conditions (including any future changes thereto) and have net order volume of at least \$2,000 USD each fiscal year (Nov 01-Oct 31). Other terms apply. For more information on becoming a Reseller, please call our Customer Service Department at 1-800-657-4343.

References to a manufacturer's name and/or part numbers are for identification purposes only. Unless otherwise noted, merchandise is not original equipment.

PRICE POLICY

ALL PRICES ARE SUBJECT TO CHANGE WITHOUT NOTICE. Current reseller & suggested list pricing is available on our B2B site. No trade or cash discounts are to be deducted from "your cost" prices.

PAYMENT TERMS

Terms of Payment are cash unless credit has been extended by the A&I / Sunbelt Credit Department. If credit has been extended, payment is due monthly on the 15th of the month following the month of shipment. Invoices from the 1st - 15th of the month are due and payment must be postmarked by the 15th of the month following shipment. Invoices from the 16th - end of month are due and payment must be postmarked by the 15th of the second month following shipment. Late charges will be assessed at the rate of 1.5% per month. C.O.D. orders are not accepted.

ORDERING

We encourage you to order A&I parts ONLINE at www.aiproducts.com and Sunbelt parts ONLINE at www.sunbeltparts.com. Orders may be submitted via phone with Customer Service or by fax at: 1-800-511-0516. We are not responsible for errors or delays in processing phone or fax orders. Once submitted, orders for in-stock products cannot be modified or cancelled.

BACK ORDERS

If a Reseller's account allows backorders, backordered products will be shipped as soon as merchandise is available. Our invoice will clearly indicate any items which have been backordered. Orders for backordered product may be cancelled online or by calling Customer Service.

WILL CALL ORDERS

Will-call orders will be accepted and approved only for machine down orders. Will-call orders must be prepaid or charged to a valid credit account; payment will not be accepted at the time of pickup. Allow 3 hours to process orders for pickup. Order cutoff for same-day pickup is 2:00 pm local time at all locations. Be prepared to present order numbers to warehouse personnel upon arrival.

Additionally:

- Will-call parts will be available for pickup only during business hours.
- We have no obligation to help load any merchandise.
- We reserve the right to refuse to load merchandise in any manner we deem to be unsafe.
- We will not load parts that require a forklift into any vehicle other than a truck.
- We will only deliver the parts on the order.
- If the customer questions or refuses any part we will instruct them to contact Customer Service to reorder or obtain a Return Authorization.
- If the party receiving the part(s) is an end use consumer, we will instruct them to contact their selling retailer.
- Warehouse personnel are not equipped to provide technical support or issue changes to an order. We will not load parts that require a forklift into any vehicle other than a truck.

MERCHANDISE RETURNS

We truly hope you are fully satisfied with the products that you purchase from our company. If it is not the case, we ask that you please contact our Sales Support team at 800-657-4343 to obtain a Returns Good Authorization (RGA) number. Returns sent by USPS or Canada Post are not accepted. All US returns should be sent freight prepaid, with the RGA number clearly marked on the outside of the package to our Rock Valley, IA warehouse. In Western Canada (MB, SK, AB, BC, YT, NT, NV) returns to A&I should be sent to the Regina, SK warehouse. In Eastern Canada (ON, NB, NS, PE, NL, QC) returns to A&I should be sent to the Grimsby, ON warehouse. Please see the return policy and requirements below and please keep all packing materials and packing slips when you receive your product. A copy of the original packing list or invoice must be included with your return in order to be considered for reimbursement. Inspect and review your shipment immediately upon receipt so that if there are any problems or discrepancies, we can help correct them promptly.

RETURNS POLICY

Returns are accepted up to 25 months from original date of purchase. Unless otherwise noted, a 15% restocking fee will be charged for all returns up to 15 months from original date of purchase. A 25% restocking fee will be charged for returns greater than 15 months and up to 25 months from original date of purchase. Accounts with a minimum \$25,000 in annual purchases the prior year (Nov-Oct) are eligible for 90 day returns at 0% restocking fee. Restocking fees will be waived only when: (1) the product is defective; or (2) the incorrect product was ordered and, within 30 days, the wrong product is returned and an order is placed for the correct product. A credit will be applied to the customer's account only after the merchandise has been received, inspected, and determined to meet all the requirements listed below.

REQUIREMENTS FOR RETURNS

- The customer is responsible for all shipping charges including any desired insurance.
- Product returns aggregating to more than 10% of a Reseller's annual sales volume in a 12-month period require prior approval.
- All returned product cost calculations (including restocking fees and yearly returns) will be based on the original purchased price.
- All returned products must include a copy of the A&I or Sunbelt packing slip or invoice.
- All returned products must be active selling products. We will not accept returns of inactive, substituted, or discontinued products, or products past their shelf life.
- All returned products must be in new, sellable condition. We cannot accept returns on products that are damaged (e.g., rusty or dented) or previously used or installed.

- All returned products must be in the original packaging (where applicable).
- All returns must be returned as ordered. Products that are incomplete or missing parts will not be accepted for return. Products that are in kits or packages must be returned in their entirety.
- Any return that does not meet the return requirements listed above will be scrapped at the customer's expense.

WARRANTY

Products not separately warranted by the manufacturer are warranted by A&I and Sunbelt to be free from defects in material and workmanship as described below. A&I and Sunbelt reserve the right to inspect any item prior to granting warranty coverage.

PRODUCT GROUP	WARRANTY TERM
<ul style="list-style-type: none"> ■ Remanufactured International Harvester, Massey, and White hydraulic pumps ■ Rebuilt injectors 	90 Days
<ul style="list-style-type: none"> ■ Remanufactured John Deere hydraulic pumps ■ New injectors 	6 Months
A&I air conditioning (A/C) compressors, but only when installed by licensed or certified A&I/Sunbelt reseller in accordance with applicable regulations and when the steps within Tech Bulletin TM0004 have been taken. The TM0004 A/C Compressor Warranty Sheet is available on the A&I Products website.	1 Year
Briggs & Stratton	Separately warranted by manufacturer. See http://www.briggsandstratton.com
Fleetguard	Separately warranted by manufacturer. See https://www.cumminsfiltration.com/html/en/about_us/vision_mission/real_world_warranty.html
Mi-T-M	Separately warranted by manufacturer. See http://www.mitm.com
Hydraulic Torque Amplifiers ("TAs"), Regular Duty TAs, and Mechanical TAs	Separately warranted; see TA warranty policy on the A&I Products website.
OEM turf parts branded by the manufacturer	Manufacturer's warranty term and conditions apply.
All other parts	1 Year

WHAT IS NOT WARRANTED – THIS WARRANTY DOES NOT COVER:

- A&I A/C compressors not installed by a licensed or certified A/C repair shop;
- Any equipment that has been altered or modified from factory specifications;
- Depreciation or damage caused by normal wear, lack of reasonable and proper maintenance, failure to follow operating instructions/recommendations, misuse, lack of proper protection during storage, vandalism, collision, or accident;
- Pistons, rings, or liners that are not ordered as parts of an overhaul kit;
- Components that have been disassembled or dismantled;
- Installation costs, any service calls, or other labor charges for products not installed by an authorized A&I/Sunbelt reseller.
- Transportation and/or freight costs associated with returning the product to the A&I or Sunbelt retailer's place of business;
- Any premium charged for overtime labor requested by the purchaser;
- Incidental or consequential damages or injuries, including, but not limited to, loss of crops, loss of profits, rental of substitute equipment, or other commercial loss;
- Statutory or implied warranties or conditions of merchantability or fitness.

To the extent allowed by law, implied or statutory warranties including warranties of merchantability or fitness for a particular purpose shall be limited in duration to the applicable warranty period. Some jurisdictions do not allow duration limitations on an implied warranty or on the exclusion or limitation of incidental or consequential damages. The warranty gives the purchaser other specific legal rights which may vary by jurisdiction.

Resellers have no authority to make any representation or promise on behalf of A&I or Sunbelt or to modify the terms or limitations of this warranty in any way.

TO OBTAIN WARRANTY SERVICE, the end customer must submit the warranty claim to the original A&I or Sunbelt reseller where the product was purchased within the warranty term. At the same time, the end customer must present the product and the original sales receipt showing date of purchase.

SHIPPING DISCREPANCIES OR DAMAGED GOODS

Overages, shortages, or incorrect parts must be reported within 30 days of shipment. Damages must be reported immediately. All external damages should be reported to the carrier and noted on the shipping document when signing the delivery receipt. If you receive a damaged package, please sign for product as damaged and accept the package. Please do not refuse a package and do not destroy packing until inspection has been made by the carrier or carrier's agent.

LIMITATIONS OF SELLER'S LIABILITY

A&I and Sunbelt shall not be liable hereunder for damages in excess of the purchase price of the item with respect to which damages are claimed, and in no event shall A&I or Sunbelt be liable for loss of profit or good will or for any other special, consequential or incidental damages.

ERRORS & OMISSIONS

The information contained in our catalogs or websites are correct to the best of our knowledge; however, we cannot be held responsible for typographical errors.

TERMS, CONDITIONS, AND PRICING ARE SUBJECT TO CHANGE WITHOUT PRIOR NOTICE. ANY PRICES NOTED ARE IN US DOLLARS UNLESS SPECIFICALLY IDENTIFIED

**In the U.S., A&I Products means A&I Products, Inc. In Canada, A&I Products means A&I Products Canada Inc.*

