



aluminium  
**BIFOLDING  
DOORS**



# BF73 BIFOLDING DOORS

Aluminium bifolding doors create a visually stunning addition to your home and can add huge value.

Class-leading design features set the BF73 Bifolding Door aside from the competition. Thermal performance and slim profile sections to minimise the visible framework and maximise the glass area, is key to their design.

Engineering grade hardware, allows for silky smooth opening and closing operation, without having to pay a premium price.

What's more, all our doors come with a 10-year manufacturers' guarantee for your complete peace of mind.

## Why choose Aluminium?

Aluminium is extremely durable and more hard-wearing than other materials. You'll be able to enjoy your aluminium doors for not only years but decades to come as they're incredibly resistant to the elements.

It is also an incredibly strong material, therefore providing a high level of security.

Aluminium doors are among the best-insulated on the market, thanks to advanced thermal break technology, which prevents cold transfer.

They require very little maintenance to ensure optimal performance and to keep them looking good as new.



Installed by Evergreen Living Spaces

Whether it's a single door, French door or bifolding door or window, they can all be fabricated from the same BF73 system. It's so **versatile** that it can cater for projects that call for shaped frames, fixed frames, sidelights, astragal bars, blinds in glass and can even be used as an entrance door with optional panel inserts.

All our BF73 products can be finished in several glazing options to create a style to suit any property. Single doors, French doors, bifolding doors or windows, or shaped and fixed frames glazing options:

- Double glazed
- Triple glazed
- Integral blinds
- Heritage look astragal bars
- Solid panel inserts

All BF73 sashes are available in 3 profile designs: **square**, **textured square\*** and **curved**.

Choose square for a classic look or textured square for a more contemporary alternative. And, if you're looking to complement your property's existing windows, then opt for our newest addition, the curved sash.

*\*textured square only available in 7016 anthracite grey*

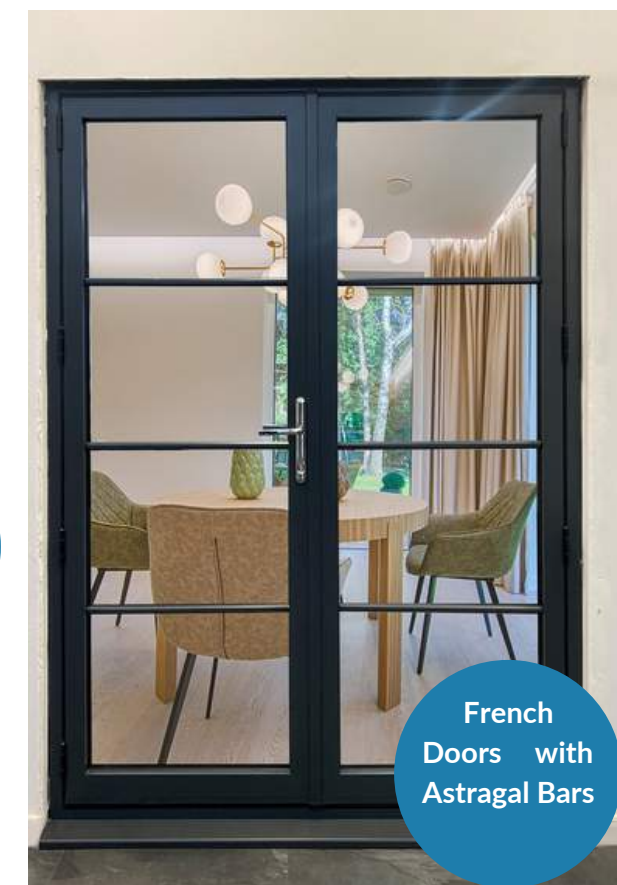
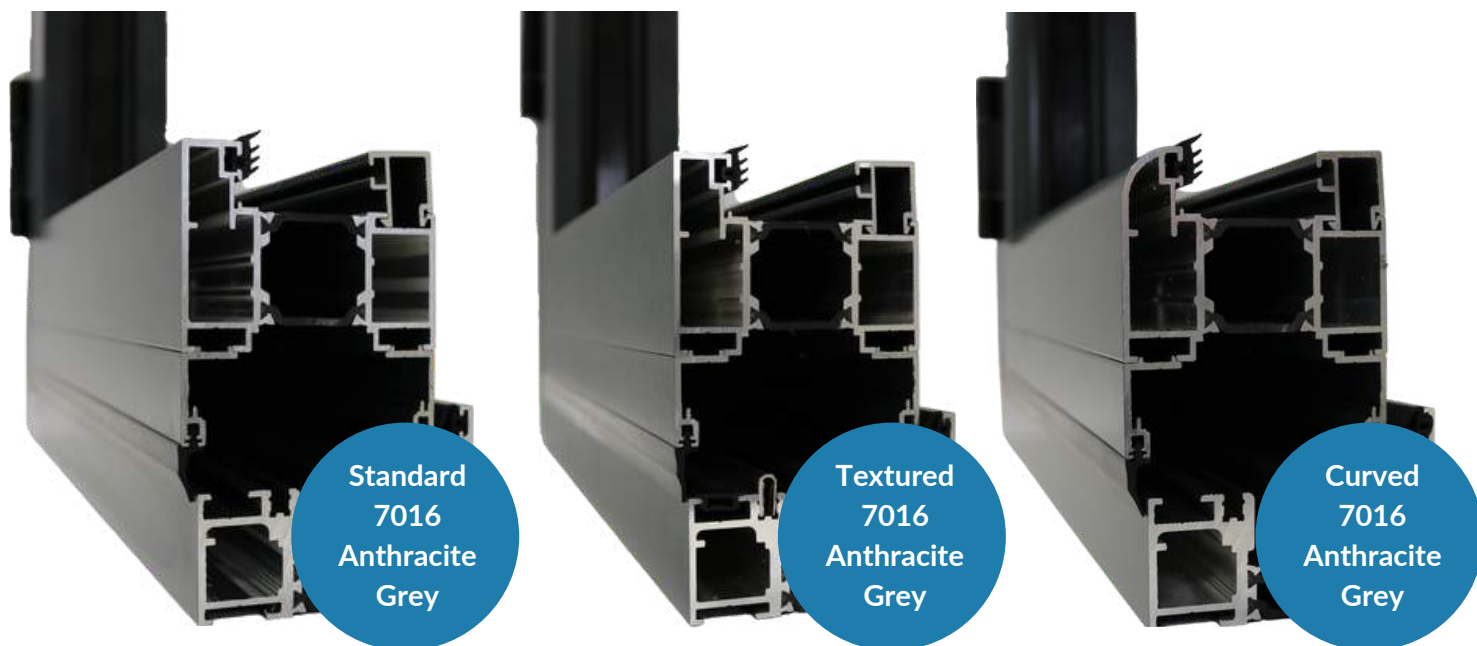

# ALULOCK

## LOCK, KEEP AND HANDLE

AluLock is the **ultimate security kit** that combines a euro profile cylinder as standard, with the option to upgrade to the Ultion 3-star barrel, with the Brisant Sweet Handle and an **exclusively** designed Duplex Double Hook Lock.

### Ultion Stays Locked

The **Ultion 3-star barrel** provides double the sacrificial protection, made from materials 25% denser than iron and with twice the number of pins than the average lock (including an antipick pin) and 20-point drill protection as standard. If att

acked, the barrel enters '**lockdown mode**', meaning the lock is practically impenetrable without heavy and noisy power tools.

Brisant are so confident of this that they will pay **£2000** direct to the homeowner should a burglary take place within 10 years from the point of installation and entry was achieved by snapping an Ultion lock.



BRING THE ULTION TECHNOLOGY TO LIFE>

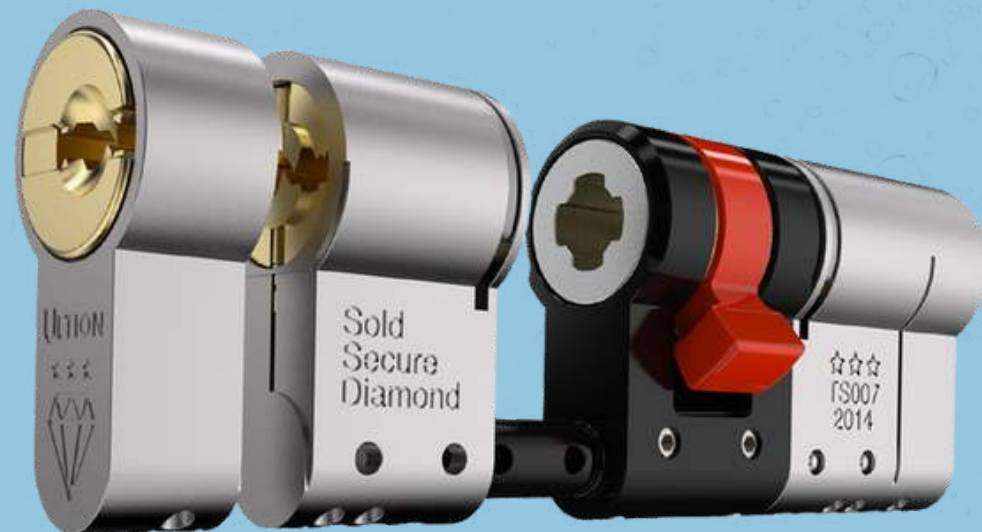

### Duplex Double Hook Lock

The **Duplex Double Hook Lock** has been designed by UK-based Ingenious' highly experienced and dynamic design team, providing a 6-point locking system instead of 3-hook, for additional **security**. It comes with a dual follower to allow twin spindle function, which prevents unauthorised entry when the lock is in a latched position.

### The Sweet Handle

The safe and stylish **Sweet Handle** is impressively **durable**, carrying multiple coatings of brass and nickel to ensure robust performance against the elements. Brisant also offers a 10-year direct to homeowner **anti-corrosion** guarantee for peace of mind.

The sleek curved design is not only pleasing to the eye but is an impressive **security** feature, stopping gripping tools designed to snap off handles during break ins. Available in a range of colours including; black, white, grey, chrome and stainless steel. Gold and rose gold also available.





**10**  
YEAR  
GUARANTEE

**PAS24**  
COMPLIANT

**ULTRA**  
**SLIM**  
SIGHTLINES

## Cills and Thresholds

Aluminium cills with pre-drilled screw ports and aluminium screw-in ends caps available in our standard stock colours. Cill sizes are 90mm, 150mm, 190mm and 230mm. Standard 150mm without pre-drilled screw ports in White and Black.

### Standard Threshold

Our **Standard Threshold (55mm)** or weathered threshold provides the utmost protection whilst still looking sleek. The standard threshold acts as a full weather break, keeping your home dry and warm regardless of outside elements. Hence, for external bifolding doors, the standard 55mm is recommended.

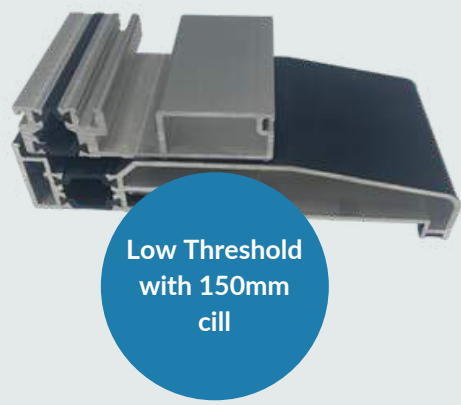
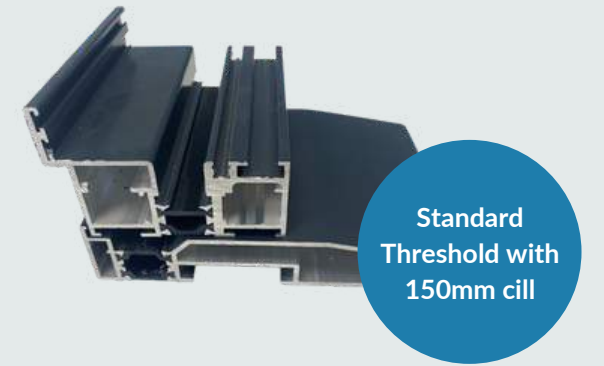

### Low Threshold

Our **Low Threshold (20mm)** doesn't offer as much weather protection but creates a seamless look. Lower thresholds are less of a trip hazard than higher ones so are more suited for those with mobility issues or small children. While the design may be more striking, we don't recommend this for external bifolds unless in sheltered areas.

### Low Threshold with Rebate

A 20mm rebate can be attached to our low threshold, making it only slightly higher at 40mm. The lip of the rebate gives extra weather protection against the elements.

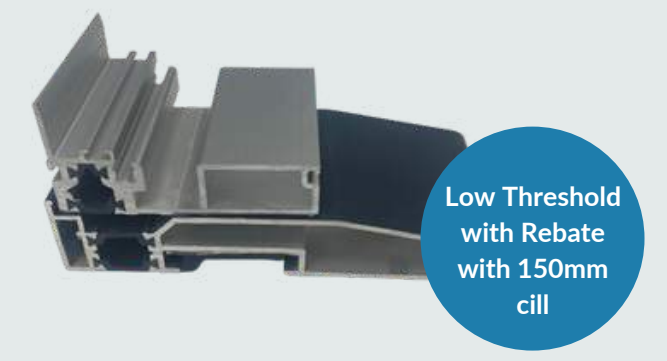

### Low Threshold with Ramps

When a threshold can't be sunk below floor level and accessibility is required, a ramp can be added either side of the low threshold.

This is an optional extra on the low threshold.

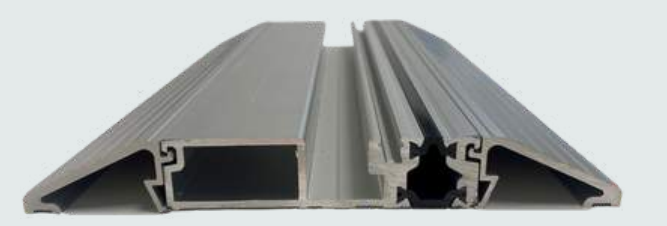

## Colours

Our doors are available in three standard colours, plus two dual colour options.

For projects requiring bespoke coloured doors, any RAL colour can be available upon request.

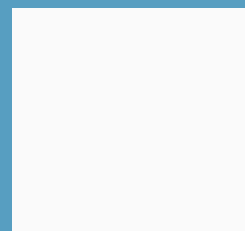

White  
RAL9016



Anthracite  
Grey RAL7016

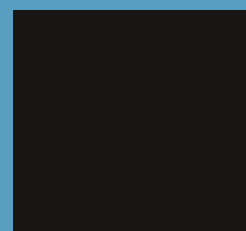

Black  
RAL9005



Grey Out/  
White In



Black Out/  
White In

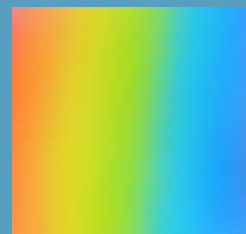

Bespoke RAL  
colour

## Thermal Efficiency

The BF73 system can achieve a U-values as low as **1.4 W/m<sup>2</sup>K**, when combined with highly energy efficient glass.

## Weather Resistance

Excellent weather sealing is achieved using specially designed **perimeter seals**, with the option of **weather piles** for lower thresholds. Weather-tightness tested to British standards.

## Low Maintenance

Our **low-maintenance** aluminium doors are strong, durable and highly **corrosion-resistant**. Unlike timber, they don't need painting or staining to keep them **weather-proof**, and they won't rust or corrode. They will also never rot, peel or flake.

## Maximum Vision

The Alutech BF73 Door System gives one of the largest sash sizes available, with up to 1200mm width and 3000mm height per pane. Paired with super slim sightlines of just 120mm, you'll get the best uninterrupted views.

## Floating Corner Post

The **floating corner post** option enables right-angled BF73 bifolding doors, including the return, to open out fully, with the option of a fixed corner, for the ultimate wow factor!  
(Structural support needs to be in place.)



DISCOVER MORE >  
Point your smart phone camera at this QR code and bring all the BF73 products to life!



Installed by RJ Day Plastering

# CREATE YOUR PERFECT BIFOLD



Installed by Luna Door & Window Design

## Door leaf configuration

BF73 doors are available in up to 7 leaves each way (14 total). The leaves are able to open either from the left or right of the opening, either opening towards the inside of the property or to the outside – the choice is yours.

## Adjustable Jamb (Optional)

The BF73 system has been designed to be quick and easy to manufacture and install. The system offers an optional adjustable jamb feature for maximum adjustability of +/- 4mm either side during installation and easily adjustable at a later date with an allen key.

## Technical details at a glance:

- Market-leading maximum sash size of 1200mm x 3000mm.
- Maximum vision – minimal sight lines of only 120mm or 133mm.
- Maximum security – PAS 24 compliant.
- Maximum insulation value – down to 1.4 U W/m2K.
- Maximum weather proofing – tested to BS6375 Part 1 : 2009.
- Single or dual colour. Factory powder coated to marine quality as per Qualicoat regulations.
- 120kg per door leaf providing for the openings.
- Engineering grade running rollers for a smooth and silky opening and closing operation.
- Trickle vents can be added.

## Open out configurations

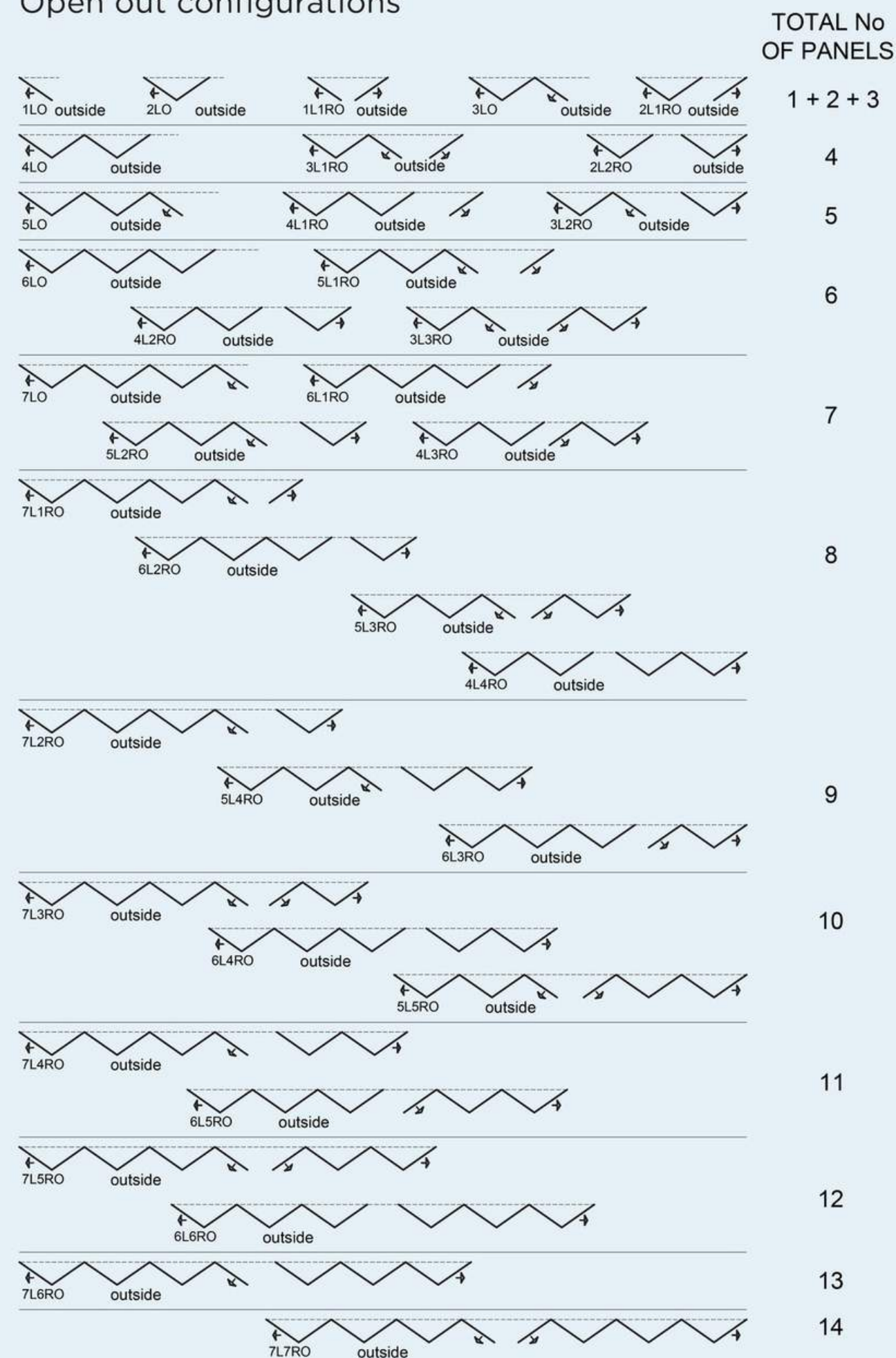

aluminium  
**BIFOLDING  
DOORS**



Phone: 01745 854042  
Email: [sales@alu-express.co.uk](mailto:sales@alu-express.co.uk)  
<http://alu-express.co.uk>

12/21 VI. The content of this document, photographic reproduction and technical details remain the sole property of Alutech Systems Ltd., all rights reserved. It cannot be reproduced, in whole or in part, without explicit permission. Terms and conditions of sale apply, a copy of which is available on request.



Installed by Rob Cook Carpentry





# Aluminium Sliding Doors



# Sliding Patio Doors

Aluminium Sliding Patio Doors create a visually stunning addition to your home and can add huge value to your property!

Thermal performance and slim profile sections to minimise the visible frame and maximise the glass area, is key to their design.

Engineering grade hardware allows for a silky smooth opening and closing operation!

All of our doors come with a 10 years manufacturers guarantee for your peace of mind.

## *Why choose Aluminium....*

- ✓ Aluminium is extremely durable and hard-wearing. You'll be able to enjoy your aluminium doors, not only years but decades as they're incredible resistant to elements!
- ✓ Aluminium is an incredibly strong material, providing one of the highest levels of security.
- ✓ Aluminium doors are among the best-insulated on the market, thanks to the advanced thermal break technology.
- ✓ Aluminium require little maintenance to ensure that optimal performance is kept, and to keep them looking as good as new!





Patio doors can help frame outdoor views, and create a light, bright space in your home. They effectively create a glazed wall, creating an open and accessible space between the indoors and outdoors.

We combine state of the art performance hardware and effortless sliding mechanisms.

They are designed for large spaces and offers both double and triple track options for a large range of opening configurations.

All our products can be finished in several glazing options to create a style to suit any property. Our patio door range is available with the following glazing options:

- Double glazed
- Triple glazed
- Integral blinds
- Laminated Glass
- ... and many more

10 Year  
Guarantee

Manufactured  
in the UK

Ultra Slim  
Sightlines



# TECHNICAL DETAILS

- Stainless steel running rail for smooth sliding.
- Straight line design.
- Operational lift & slide mechanisms.
- 28mm double, or triple glazing for better thermal and sound insulation.
- Rubber tubular gaskets providing great weather protection.
- Specially designed central interlock sections at only 25mm, for minimal sightlines.

**Cross Section Triple Track**

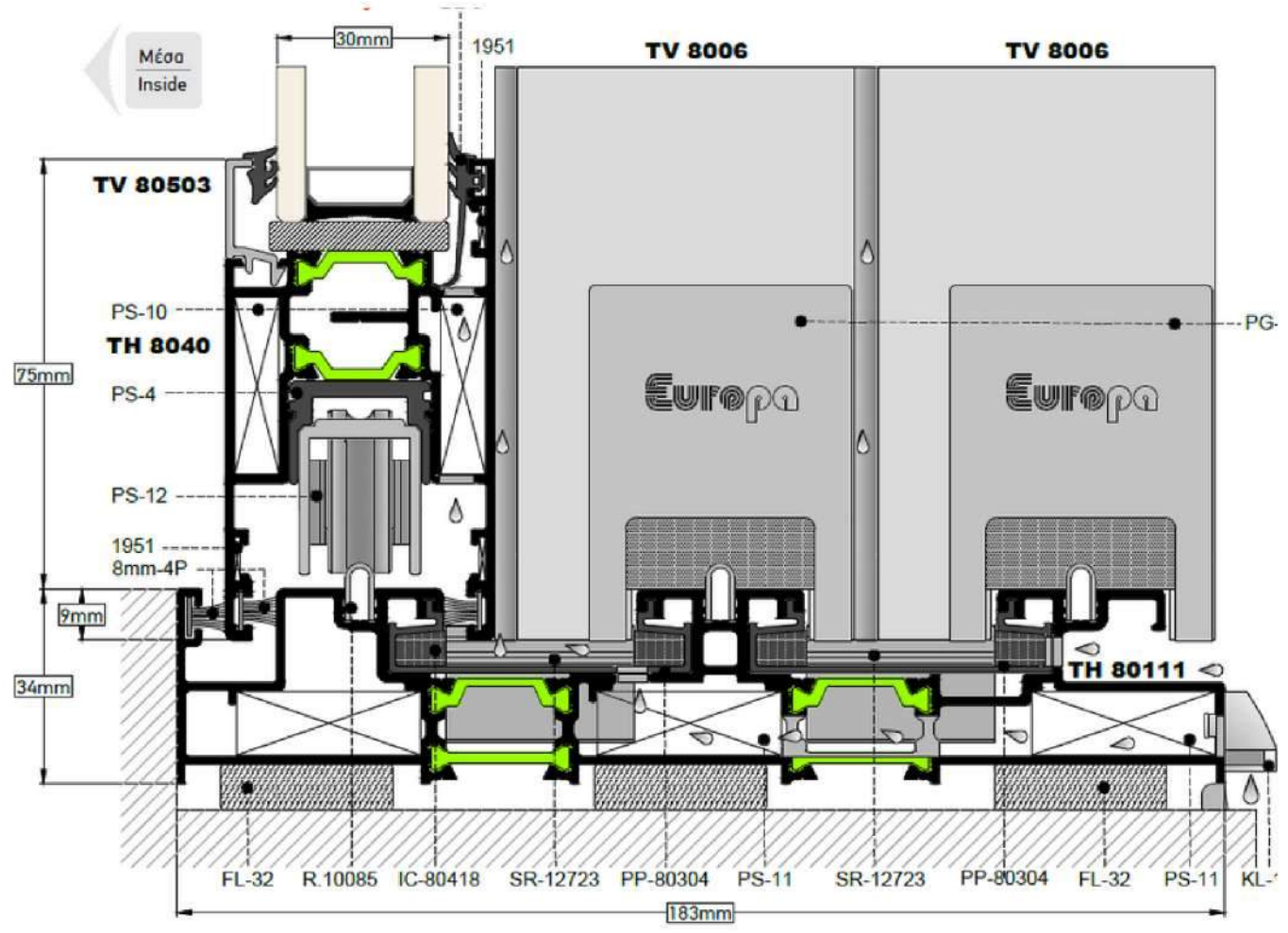
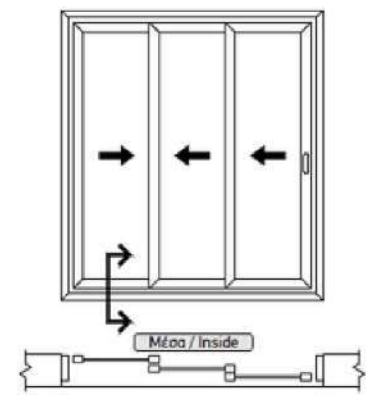

**Cross Section Double Track**

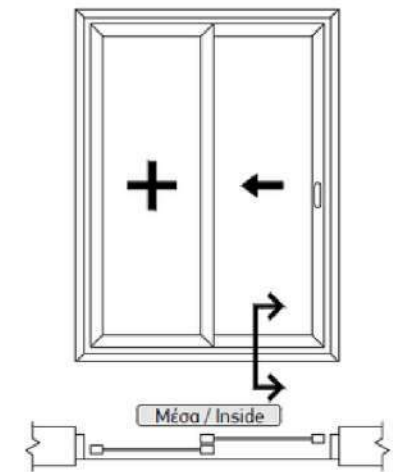

**Cross Section 4 Pane**

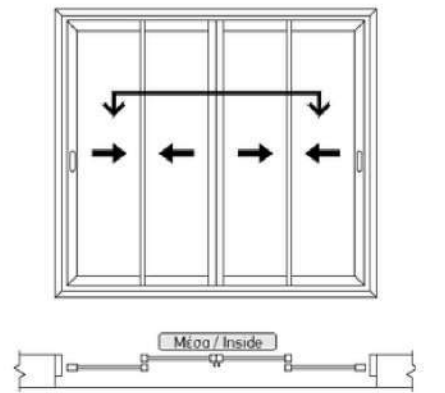
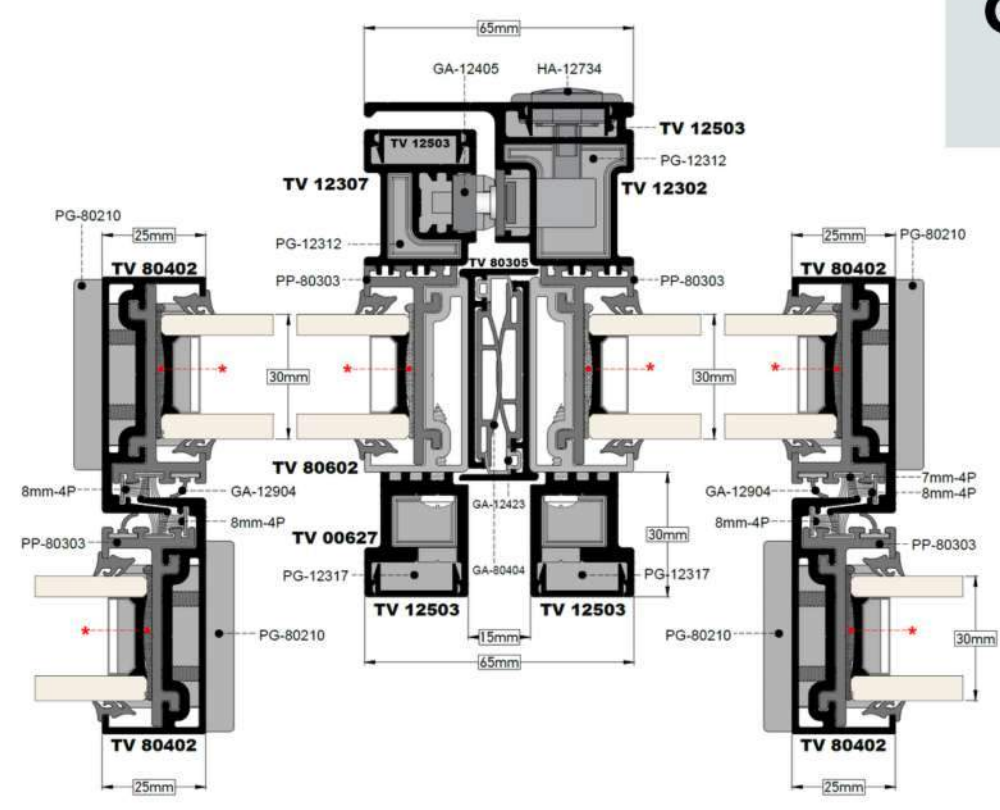

## TRIPLE TRACK

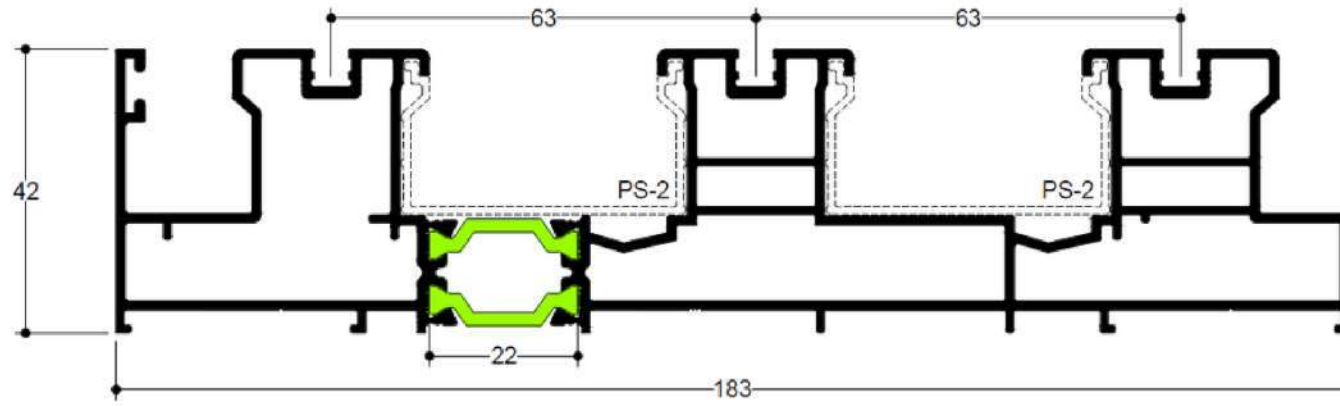

## DOUBLE TRACK

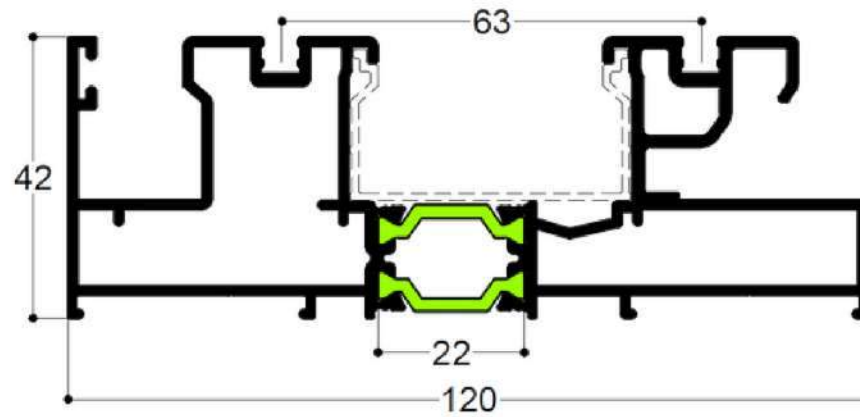

## SASH PROFILE

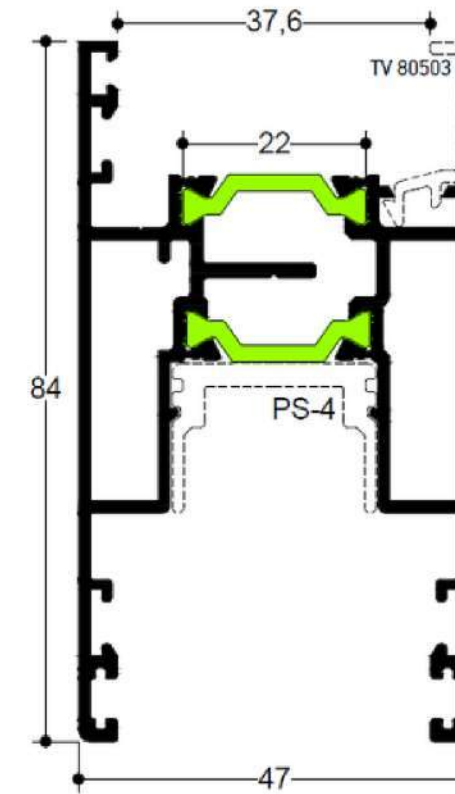

**Aluminium Alloy**

**EN AW 6060 T6**

Minimum Coating Thickness

75 Micron

**Profile Thickness**

**1.4mm**

Tolerance According To

EN 12020-02

**Width of Double Track**

**120mm**

Width of Sash

47mm

**Glazing Thickness**

**28mm**

Maximum Sash Dimensions

2500mm x 2700mm

**Maximum Sash Weight**

**250kg**

**SUPER  
SLIM  
INTERLOCK**

## Hardware & Security

The Super Slim Patio system comes with a range of sleek, complementary hardware available in black, Satin or White.

Combined with a high security multipoint locking system, for peace of mind in keeping your property safe.



## Configurations

Sliding patio systems have a variety of opening configurations, depending on how many panes you choose, and which panes you'd like sliding, or fixed!

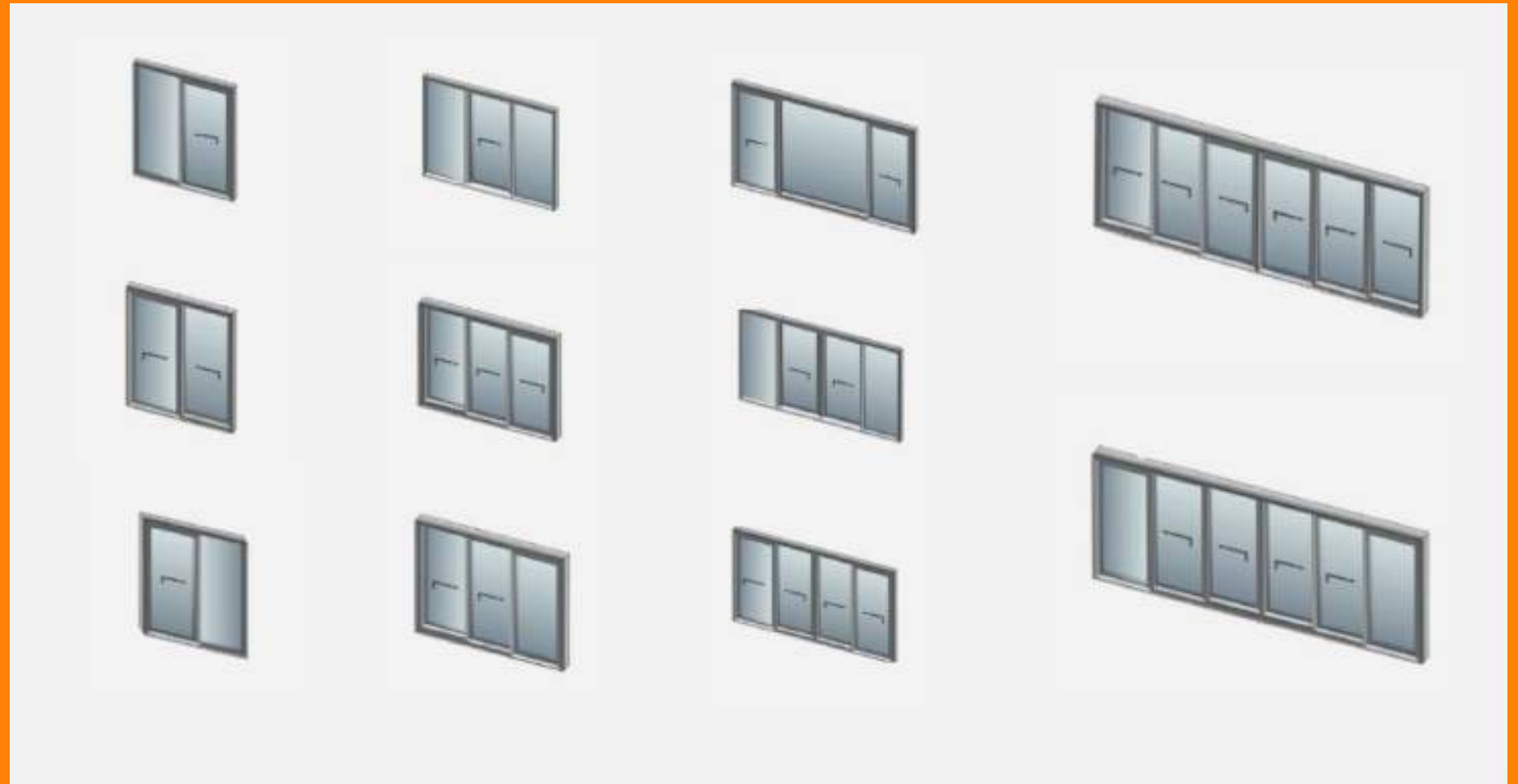

## Door Colours

Our doors, are available in three standard colours:



White  
RAL 9016



BLACK  
RAL 9005



Grey  
RAL 7016

## Technical details at a glance:

- Market-leading maximum sash size of 2500mm x 2700mm
- Maximum vision - minimal interlock sight lines of 25mm
- Maximum security - PAS 24 compliant
- Maximum insulation value - down to 1.4 U W/m<sup>2</sup>K.
- Track width of 120mm for double track, or 183mm for triple track
- Single or dual colour. Factory powder coated to marine quality as per Qualicoat regulations
- Up to 250kg weights per door leaf providing for the openings
- Engineering grade running rollers for a smooth and silky opening and closing operation
- Trickle vents can be added

Our aluminium products complement our range of aluminium doors and windows, which can be designed to coordinate with each other, for the perfect look!

They can also, be used on their own to make a unique, stand out statement!



Patio Doors & Window

# OTHER PRODUCTS

Our product offering doesn't end with patio doors. We have a full range of other aluminium home improvement products that cater for any project, any style, and any aperture.

Other products include:

- Windows
- Bifold Doors
- French Doors

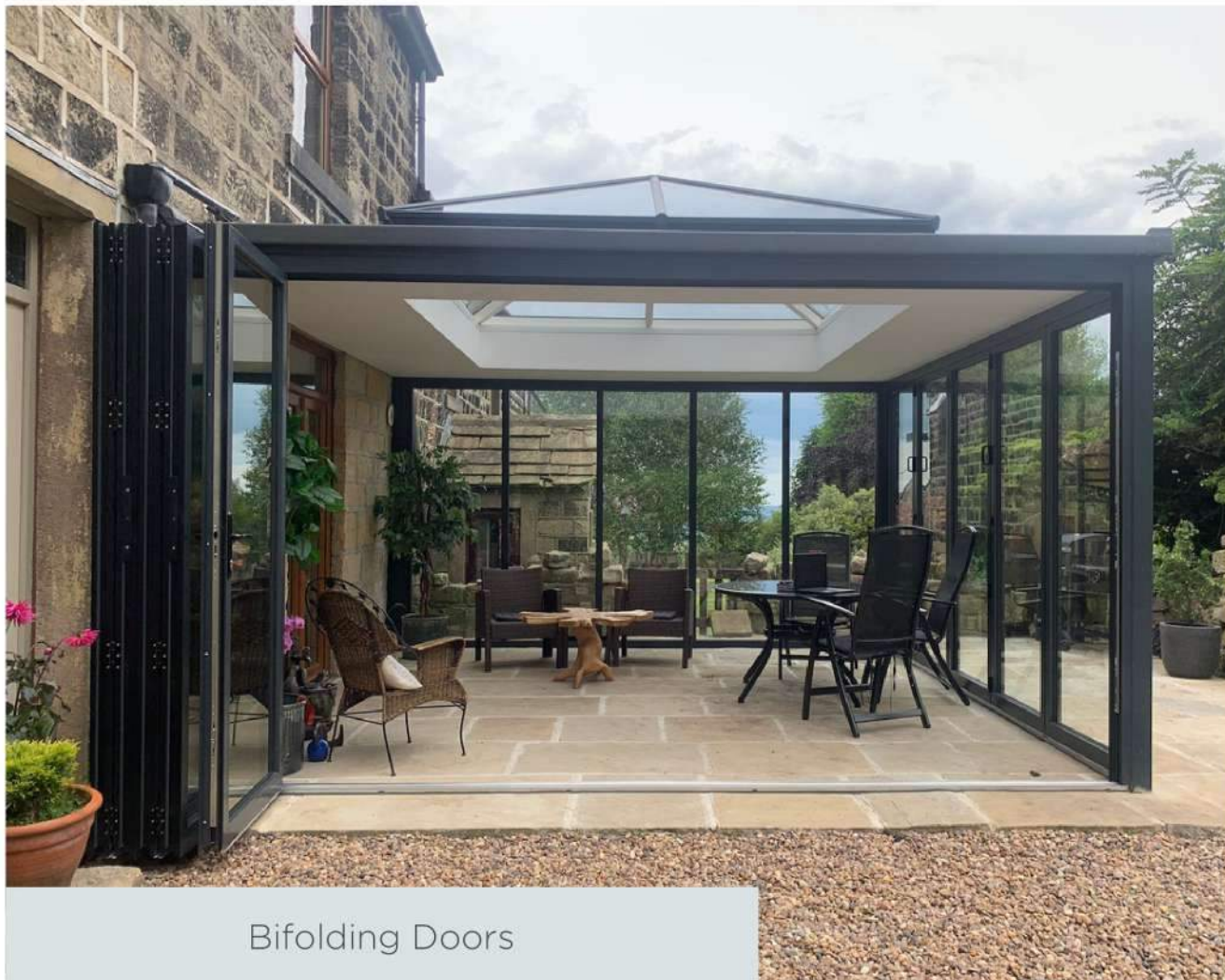

Bifolding Doors

Our Aluminium window system features:

- Matching 73mm frame, allowing easy connection to the bifold system if needed.
- Flush frame and sash gives amazing sight-lines.
- Document L compliant with all current regulations.
- Choice of 5 frame and handle colours.
- PAS 24 compliant.



Aluminium French Doors - Heritage Style

*Quality  
Aluminium Systems*



Tel: 01745 854042  
Email: [Sales@alu-express.co.uk](mailto:Sales@alu-express.co.uk)  
[www.alu-express.co.uk](http://www.alu-express.co.uk)



Visit our website to browse our range of products,  
design your bifolds and buy stock doors from our online shop!



aluminium  
**WINDOWS**



# SUPER SLIM ALUMINIUM CASEMENT WINDOWS

The ALUNA window's super slim sash offers minimal sightlines for optimal views. Secure to PAS24, the ALUNA window exceeds Part L compliance with WER rating A and new build requirement of 1.4 W/(m<sup>2</sup>k) is achieved when combined with highly energy efficient glass.

The ALUNA window can be used as a side light with openers that seamlessly couples with our ALUNA bifold door system and even shares some of the same components! It can even be glazed from the inside and the outside for simple, pain-free installation.

## Why choose Aluminium?

Aluminium is extremely durable and more hard-wearing than other materials on the market. You'll be able to enjoy your aluminium doors for not only years but decades to come as they're incredibly resistant to the elements.

It is also an incredibly strong material, therefore providing a high level of security and impact resistance.

Aluminium windows are among the best-insulated on the market, thanks to advanced thermal break technology, which prevents cold transfer.

They require very little maintenance to ensure optimal performance and keep them looking good as new.



The ALUNA window is available as a contemporary flush sash in our highly desirable super slim sash to complement the slim profile of modern bifold and patio doors.

With its elegant, contemporary design, the ALUNA window perfectly complements our other ALUNA systems, bringing you a cohesive range of products to complement one another. All configurations of the ALUNA window system can be finished in several glazing options to create a style that suits any property.

- 28-44mm glazing options
- Heritage/ flush & standard window options
- 1.4 U-Value
- Energy rating A
- Side hung / top hung / fixed light options available



The ALUNA window is available as a contemporary flush sash in our highly desirable super slim sash to complement the slim profile of modern bifold and patio doors.

With its elegant, contemporary design, the ALUNA window perfectly complements our other ALUNA systems, bringing you a cohesive range of products to complement one another.



# HARDWARE

## MILA HANDLES

The Mila handle is available in 5 suited finishes including; **Polished Gold, Polished Chrome, Smooth Satin Chrome, White, Black.**

Manufactured to be easy to operate, the modern design features an ergonomic lever contoured to the shape of your hand, and tear drop button which offers comfort during use. Complete with a **high-security locking system**, the handles are extremely reliable as they have been tested up to **50,000 cycles**. Additionally, the handles come with **10-year guarantee**, for extra peace of mind.



## COASTAL STAINLESS STEEL RANGE

The high-quality, contemporary window handles from Coastal offer a sleek, contemporary look with no compromise on security.

The **slim inline profile** ideally compliments the aluminium windows while the **lockable system** is ideal for those safety-conscious homeowners.

The sharp design is also incredibly durable due to its quality choice of materials and manufacturing. The handles are manufactured from solid **316 Marine Grade Stainless Steel**, which is also available in PVD Satin Black Finish.



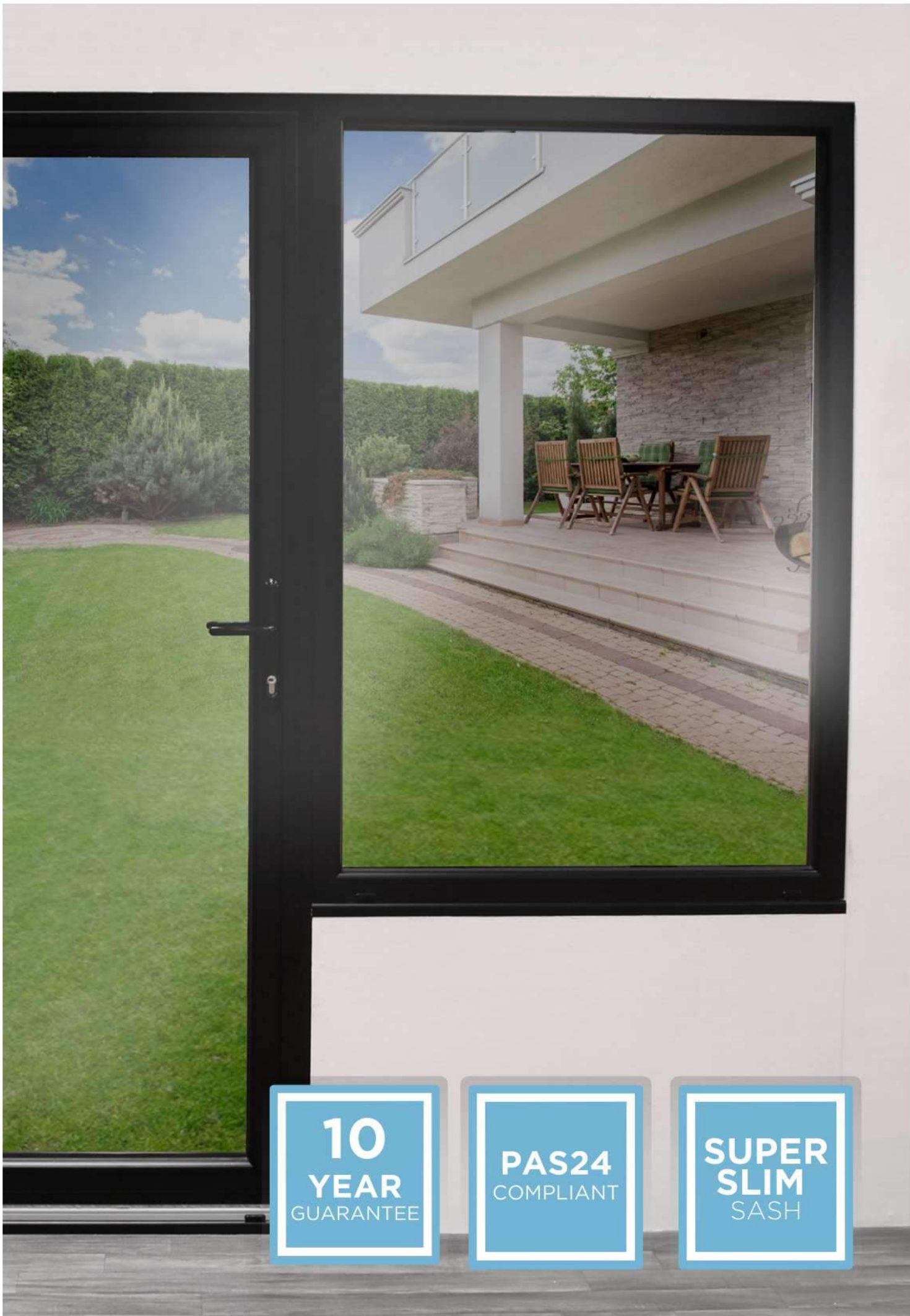

## Colours

Our windows are available in three standard colours, plus two dual colour options.

For projects requiring bespoke coloured doors, any RAL colour can be available upon request.



White  
RAL9016



Anthracite Grey  
RAL7016



Black  
RAL9005



Grey Out/  
White In



Black Out/  
White In



Bespoke RAL  
colour

## Universal Aluminium Cills

Our range of universal **aluminium cills with screw ports** are compatible with most other door and window systems, including our ACW81 window system. They are effective in directing water away from brickwork and also offer an additional design element to the aesthetics of the window.

Our aluminium cill is more robust than PVC alternatives and comes complete with plastic push-in colour matched end caps, in our standard stock colours, for a secure and sleek finish.

Cill sizes are **90mm, 150mm, 190mm** and **230mm**.

Available in Black, White, Anthracite Grey, textured Mill finish, and dual colours of White/Anthracite Grey and Black/White and can also be powder-coated in any RAL colour.

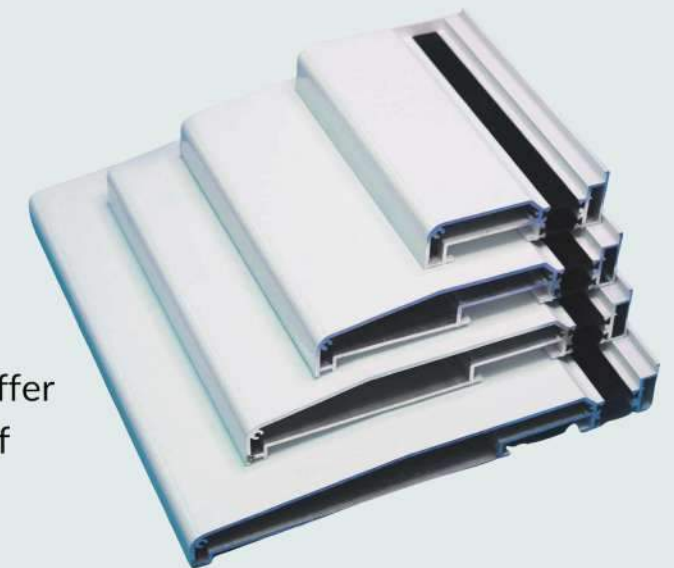

## Thermal Efficiency

The ACW81 system exceeds Part L compliance with WER rating A and new build requirement of 1.4 W/(m<sup>2</sup>k) is achieved when combined with highly energy efficient glass.

## Weather Resistance

Excellent weather sealing is achieved using specially designed **perimeter seals**, with the option of **weather piles** for lower thresholds. Weather-tightness tested to British standards.

## Low Maintenance

Our **low-maintenance** aluminium windows are strong, durable and highly **corrosion-resistant**. Unlike timber, they don't need painting or staining to keep them **weather-proof**, and they won't rot or corrode. They will also never rot, peel or flake.

## Maximum Vision

The **ACW81 Window** is designed to collaborate with all Alunet Systems products. The highly desirable **slim sashes** are a great option to complement the **slim profile** of our modern bifold and patio doors, to make the most of your stunning views.

## DISCOVER MORE

Scan the QR code below to find out more about the fantastic features and benefits that our ACW81 aluminium window system has to offer.



DISCOVER  
MORE >

point your smart phone  
camera at the QR code  
to explore our  
webpage!



# CREATE YOUR PERFECT WINDOW



## Technical details at a glance:

- Maximum sash sizes of 1500mm x 1500mm (top hung) or 900mm (side hung).
- Maximum vision – slim sash to complement other door systems.
- Window Energy Rating of A which complies to Part L Requirements.
- Maximum security – PAS24:2022 compliant.
- Maximum insulation value – down to 1.4 U W/m2K.
- Maximum weather proofing – weather tightness air permeability class 4 (600 Pa) & water tightness Class 8A (Side-hung) & Class E1500 (Top-hung).
- Single or dual colour. Factory powder coated to marine quality as per Qualicoat regulations, plus any RAL colour on request.
- Maximum sash weight- 50kg (top hung) & 40kg (side hung).
- Engineering grade hardware for a smooth opening and closing operation.

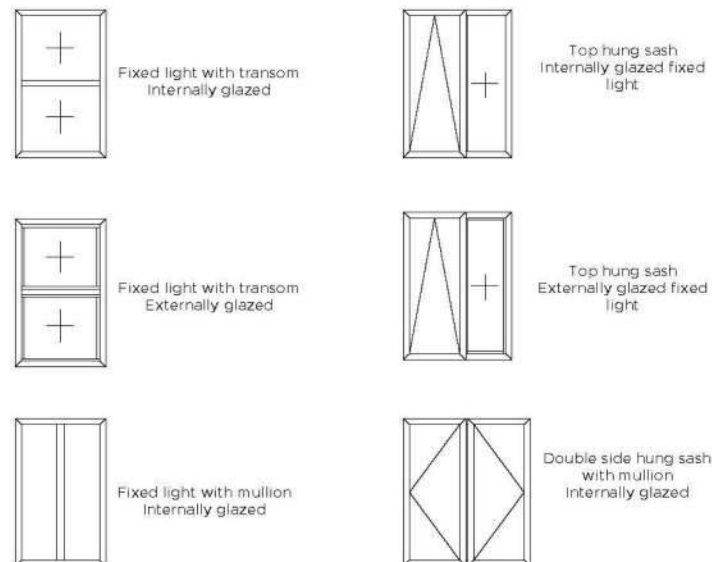

## Types of Glazing

The **ACW81 Window** has a variety of glazing options to choose from, with a maximum glazing thickness of **28-44mm** including:

- External Glazing
- Reverse Adapter
- Dummy Sash

## Typical Window Openings

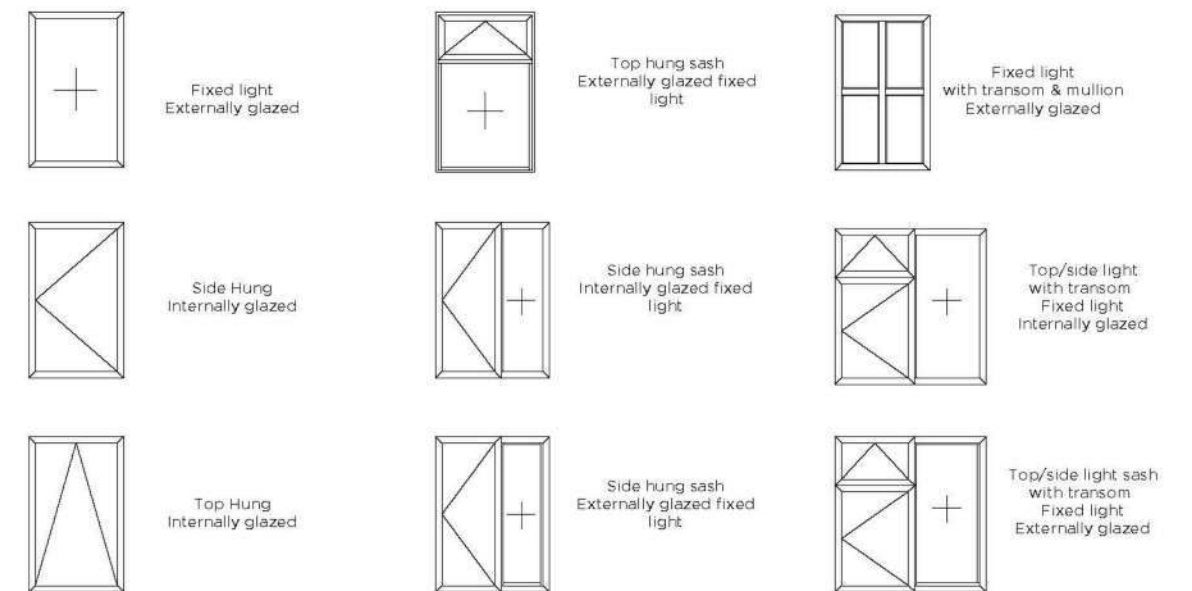

## Configurations

Some of the most popular applications that can be made from the ALUNA window system are listed below but there are many more besides. Please refer to the configuration diagram.

- Can be used as a side light with openers and easily couples to our ALUNA bifold door system.
- Side-hung opener next to a fixed frame.
- French casement window with double side-hung openers.
- Standard casement window – top opener over a fixed frame.
- Crucifix 4-pane window with 2 top openers over 2 fixed frames.

aluminium  
**WINDOWS**



Scan the QR code to find our social media channels for all the latest news and inspiring installations.



**Tel:** 01745 770707  
**Email:** sales@alu-express.co.uk  
**www.alu-express.co.uk**

