



PRODUCT SPECIFICATION GUIDE





**BEAUTIFUL
FUNCTIONAL
EASY TO INSTALL**

ECO-FRIENDLY

Sauder was founded on the principles of stewardship and servanthood. Three generations later, our family continues to honor these values with environmentally responsible processes that endeavor to preserve the future of our world. Sauder Cabinetry is no exception – manufactured in the US with integrity and craftsmanship.

Sauder Cabinetry
Product Specification Guide
Version: v1.3 // 2020



ANSI/KCMA A161.1



KITCHEN CABINET MANUFACTURERS ASSOCIATION.
ENVIRONMENTAL STEWARDSHIP PROGRAM (ESP).
ALL PRODUCTS IMPACT THE ENVIRONMENT
FOR ESP PROGRAM CRITERIA, VISIT KCMA.ORG



TABLE OF CONTENTS

04.	WHY CHOOSE SAUDER	31.	WALL CABINETS-CONT Oven Cabinet Microwave Wall
05.	GETTING STARTED How to Order	32.	LINEN CABINETS
06.	PRODUCT SPECIFICATIONS	33.	UTILITY CABINETS
08.	CONSTRUCTION	34.	VANITY CABINETS Vanity Base Vanity Drawer Base Vanity Sink Base / Vanity Sink Base Double Door Vanity Sink Drawer Base Combo Vanity Cabinets
10.	BASE CABINETS Base Base Double Door Base Full Height Door / Tray Base Base Full Height Double Door Drawer Base Sink Base / ADA Compliant Sink Base w/ RF Knee Base / Microwave Base Blind Corner Base Easy Reach Corner Base	40.	MOLDINGS
20.	WALL CABINETS Wall 12" High Wall 15" High Wall 18" High Wall 21" High Wall 24" High Wall 30" High Wall 30" High Double Door Wall 39" High Wall 39" High Double Door Blind Wall Wall Diagonal Cabinet	42.	ACCESSORIES
		47.	MODIFICATIONS
		48.	WARRANTY

WHY CHOOSE SAUDER?



ABOUT OUR COMPANY

For over 85 years, we've been making furniture with the same integrity, craftsmanship, and care. Sauder is a family owned (third-generation) company based in Archbold, Ohio. With some of the most technologically advanced equipment in the world, our facility (located on the same site pictured above circa 1937) features nearly 4 million square feet of manufacturing space, 1.2 million square feet of warehouse space, and employs about 2,000 workers. We pride ourselves on excellent customer service and fast turn-around time – only 7 day lead time on standard cabinets.

PRODUCT SPECS

- *Frameless, full access cabinets
- * 5/8" melamine laminate box construction
- * 6-way adjustable, soft close hinges

- * Fully assembled & ready to be installed
- * Color matched molding and trim available
- * KCMA Tested and Certified

CABINET DETAILS

CONSTRUCTION

5/8" furniture board glued and doweled construction, engineered to last

EXTERIOR

Color matched to door/drawer front color

SHELVES

3/4" particle board laminated in white melamine laminate and edge banded with white thermoplastic edge banding

FRONT EDGE

Thermoplastic edge banding color matched to door/drawer front

DRAWER

5-piece drawer box, 1/2" particle board sides & bottom, 360° wrapped in white melamine laminate, full extension ball bearing slides

Optional metabox full extension 100 lb. soft close upgrade

DOOR

5-piece shaker construction with standard soft close hinges

TOE KICK

Bottom of cabinet sealed from moisture with thermoplastic edge banding

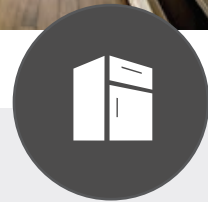
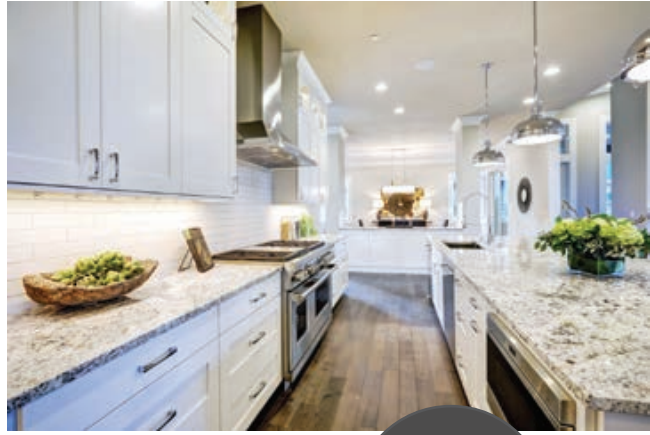

SHAKER DOOR OPTIONS



All doors feature 5-piece shaker construction and are made from MDI MDF substrate, making them moisture resistant and durable. Door and drawer fronts are 360° wrapped with melamine laminate.

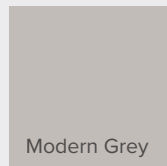
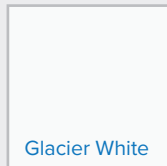

Standard Cabinet Dimensions

WALL CABINETS	12" Depth	12" / 15" / 21" / 30" / 39" Height *
BASE CABINETS	24" Depth	34 ½" Height
UTILITY CABINETS	24" Depth	84" / 93" Height
VANITY CABINETS	21" Depth	34 ½" Height
LINEN CABINETS	21" Depth	84" / 93" Height

*** 39 inch wall cabinets** eliminate the need for 36 and 42 inch heights (providing easier ordering and installation). They can be installed in rooms with 8 ft. ceilings and finished with one piece of trim or installed in rooms with 9 ft. ceilings leaving a 12 inch gap to the ceiling.

CONSTRUCTION

FRAMELESS CONSTRUCTION

All cabinets are frameless, with full access and full overlay styling. Panels and rail components are joined with engineered dowels, glue, screws or a combination of those components appropriate to the typical use of the cabinet. All frameless case construction is made from commercial grade furniture board with laminated, water resistant surfaces.

STANDARD DRAWER

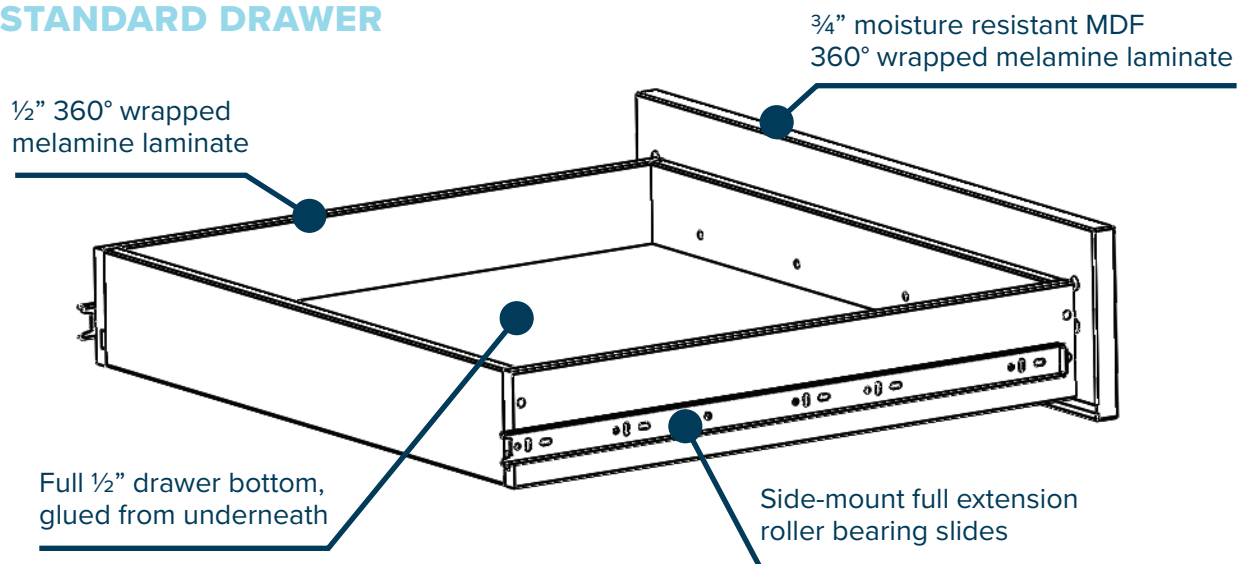

CARE & CLEANING

For normal spills, a damp cloth is sufficient. Remember to dry the surface immediately. 360° wrapped melamine laminate doors can be cleaned with most general purpose household kitchen or bath cleaners. Do not use strong acids or caustic agents and/or abrasive scrubbers. Nicks and dings can be repaired with touch-up kits. Cabinet interiors can be cleaned with a damp sponge, a cloth using soapy water, or most general purpose household cleaners. Do not let liquids stay on the surface for a long period of time.

METABOX DRAWER (UPGRADED)

Select an upgraded drawer for full adjustability, aluminum sides, and soft close slides.

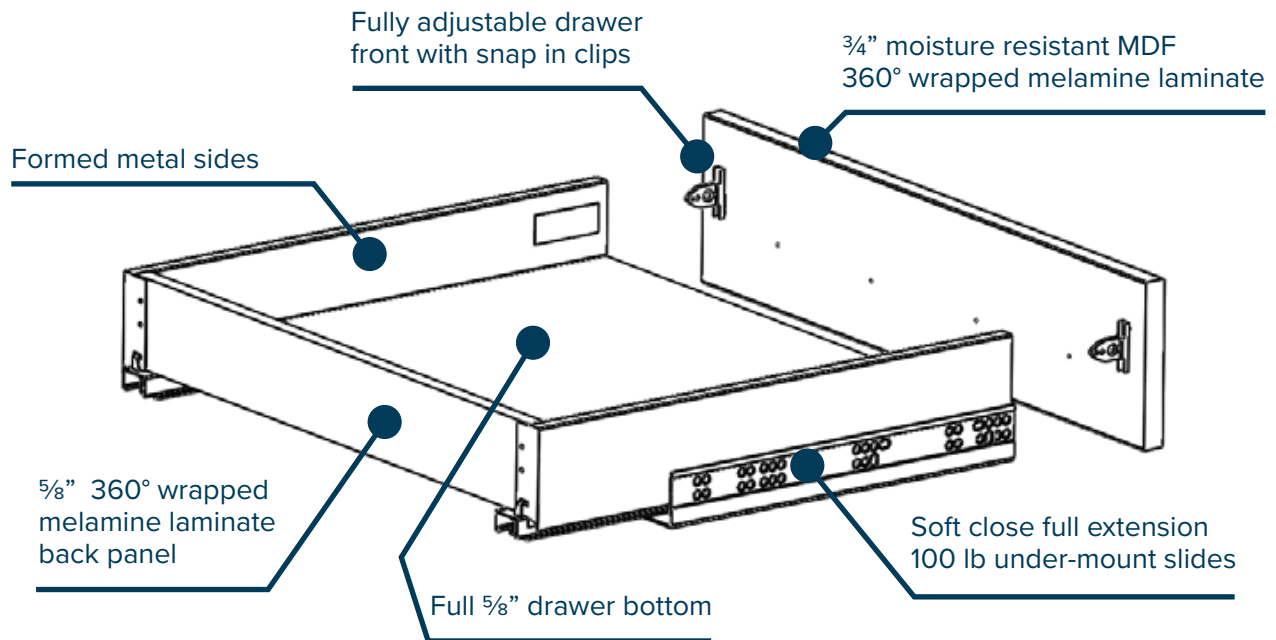

BASE

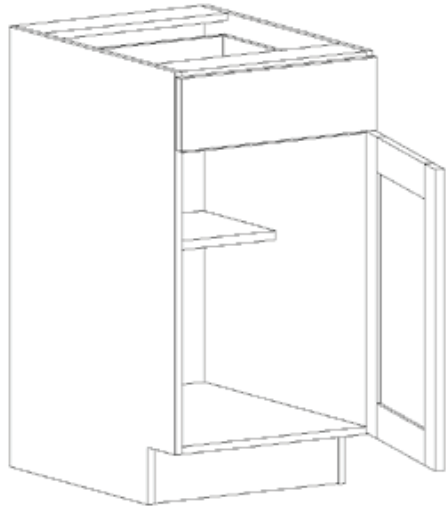

- Comes standard with one half-depth adjustable shelf
- Shipped with hinges on right, can be changed in the field

“UD” signifies upgraded drawer, “ADA” signifies ADA compliant height of 32½”

GRAY #	WHITE #	USER CODE	DESCRIPTION	FT ³	LIST PRICE
426514	426313	B12	Base Cabinet 12" Wide	6.5	\$219.00
426518	426314	B15	Base Cabinet 15" Wide	8.0	\$231.00
426522	426315	B18	Base Cabinet 18" Wide	9.6	\$245.00
426526	426316	B21	Base Cabinet 21" Wide	11.1	\$261.00
426517	426516	B12UD	Base Cabinet 12" Wide Upgraded Drawer	6.9	\$296.00
426521	426520	B15UD	Base Cabinet 15" Wide Upgraded Drawer	8.0	\$309.00
426525	426524	B18UD	Base Cabinet 18" Wide Upgraded Drawer	9.6	\$323.00
426529	426528	B21UD	Base Cabinet 21" Wide Upgraded Drawer	11.1	\$339.00
426751	426372	B12-ADA	Base Cabinet 12" Wide ADA height	6.0	\$216.00
426757	426756	B15-ADA	Base Cabinet 15" Wide ADA height	7.5	\$229.00
426763	426762	B18-ADA	Base Cabinet 18" Wide ADA height	9.0	\$243.00
426769	426768	B21-ADA	Base Cabinet 21" Wide ADA height	10.5	\$259.00
426755	426754	B12UD-ADA	Base Cabinet 12" Wide Upgraded Drawer ADA height	5.0	\$296.00
426761	426760	B15UD-ADA	Base Cabinet 15" Wide Upgraded Drawer ADA height	7.5	\$309.00
426767	426766	B18UD-ADA	Base Cabinet 18" Wide Upgraded Drawer ADA height	9.0	\$323.00
426773	426772	B21UD-ADA	Base Cabinet 21" Wide Upgraded Drawer ADA height	10.5	\$339.00

BLUE = Extended lead time

BASE DOUBLE DOOR

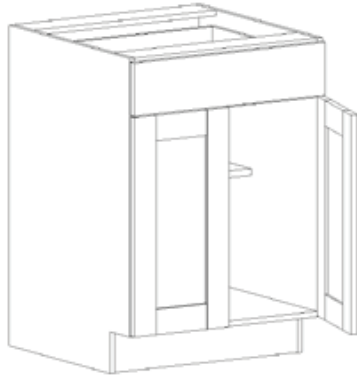

- Comes standard with one half-depth adjustable shelf

"UD" signifies upgraded drawer, "ADA" signifies ADA compliant height of 32½"

GRAY #	WHITE #	USER CODE	DESCRIPTION	FT ³	LIST PRICE
426530	426317	B24	Base Cabinet 24" Wide	12.7	\$318.00
426534	426318	B27	Base Cabinet 27" Wide	14.2	\$330.00
426538	426319	B30	Base Cabinet 30" Wide	15.8	\$342.00
426542	426320	B33	Base Cabinet 33" Wide	17.3	\$369.00
426546	426321	B36	Base Cabinet 36" Wide	18.9	\$377.00
426533	426532	B24UD	Base Cabinet 24" Wide Upgraded Drawer	13.9	\$395.00
426537	426536	B27UD	Base Cabinet 27" Wide Upgraded Drawer	14.2	\$407.00
426541	426540	B30UD	Base Cabinet 30" Wide Upgraded Drawer	15.8	\$419.00
426545	426544	B33UD	Base Cabinet 33" Wide Upgraded Drawer	17.3	\$446.00
426549	426548	B36UD	Base Cabinet 36" Wide Upgraded Drawer	18.9	\$454.00
426775	426774	B24-ADA	Base Cabinet 24" Wide ADA height	11.9	\$315.00
426782	426781	B27-ADA	Base Cabinet 27" Wide ADA height	13.4	\$327.00
426788	426787	B30-ADA	Base Cabinet 30" Wide ADA height	14.9	\$339.00
426794	426793	B33-ADA	Base Cabinet 33" Wide ADA height	16.3	\$366.00
426800	426799	B36-ADA	Base Cabinet 36" Wide ADA height	17.8	\$374.00
426779	426778	B24UD-ADA	Base Cabinet 24" Wide Upgraded Drawer ADA height	11.9	\$395.00
426786	426785	B27UD-ADA	Base Cabinet 27" Wide Upgraded Drawer ADA height	14.2	\$407.00
426792	426791	B30UD-ADA	Base Cabinet 30" Wide Upgraded Drawer ADA height	15.4	\$419.00
426798	426797	B33UD-ADA	Base Cabinet 33" Wide Upgraded Drawer ADA height	16.3	\$446.00
426804	426803	B36UD-ADA	Base Cabinet 36" Wide Upgraded Drawer ADA height	15.0	\$454.00

BLUE = Extended lead time

BASE FULL HEIGHT DOOR

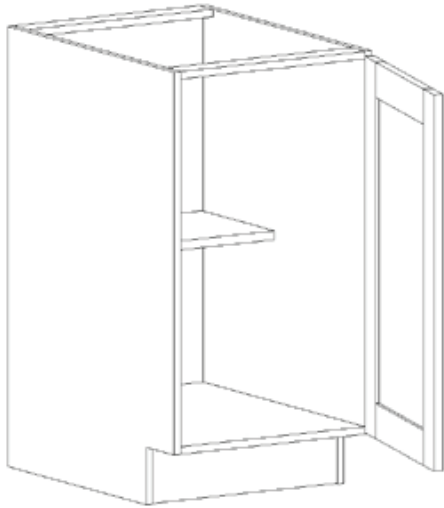

- Comes standard with one half-depth adjustable shelf
- Shipped with hinges on right, can be changed in the field

“ADA” signifies ADA compliant height of 32½”

GRAY #	WHITE #	USER CODE	DESCRIPTION	FT ³	LIST PRICE
426515	426322	B12FH	Full Height Door Base Cabinet 12" Wide	6.5	\$185.00
426519	426323	B15FH	Full Height Door Base Cabinet 15" Wide	8.0	\$199.00
426523	426324	B18FH	Full Height Door Base Cabinet 18" Wide	9.6	\$209.00
426527	426325	B21FH	Full Height Door Base Cabinet 21" Wide	11.1	\$221.00
426753	426752	B12FH-ADA	Full Height Door Base Cabinet 12" Wide ADA height	6.1	\$185.00
426759	426758	B15FH-ADA	Full Height Door Base Cabinet 15" Wide ADA height	7.5	\$199.00
426765	426764	B18FH-ADA	Full Height Door Base Cabinet 18" Wide ADA height	9.0	\$209.00
426771	426770	B21FH-ADA	Full Height Door Base Cabinet 21" Wide ADA height	10.5	\$221.00

BLUE = Extended lead time

TRAY BASE

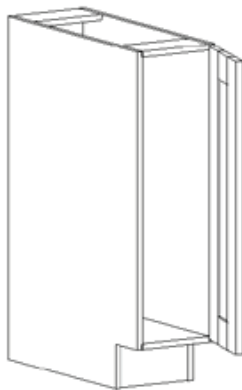

- No shelves
- Shipped with hinges on right, can be changed in the field

GRAY #	WHITE #	USER CODE	DESCRIPTION	FT ³	LIST PRICE
426575	426312	TB09	Full Height Door Base Cabinet 9" Wide	4.9	\$194.00

BASE FULL HEIGHT DOUBLE DOOR

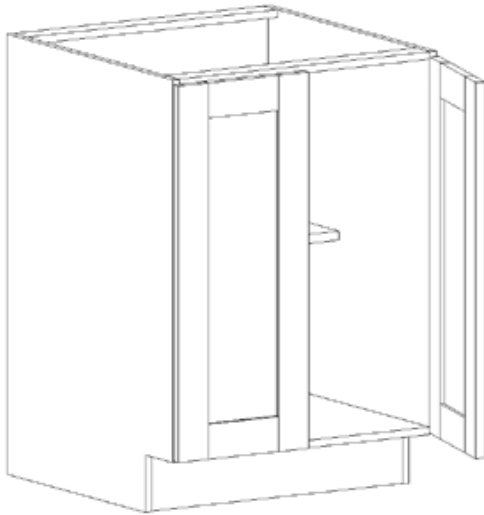

- Comes standard with one half-depth adjustable shelf

"ADA" signifies ADA compliant height of 32½"

GRAY #	WHITE #	USER CODE	DESCRIPTION	FT ³	LIST PRICE
426531	426326	B24FH	Full Height Door Base Cabinet 24" Wide	12.7	\$279.00
426535	426327	B27FH	Full Height Door Base Cabinet 27" Wide	14.2	\$284.00
426539	426328	B30FH	Full Height Door Base Cabinet 30" Wide	15.8	\$296.00
426543	426329	B33FH	Full Height Door Base Cabinet 33" Wide	17.3	\$308.00
426547	426330	B36FH	Full Height Door Base Cabinet 36" Wide	19.8	\$320.00
426777	426776	B24FH-ADA	Full Height Door Base Cabinet 24" Wide ADA height	11.9	\$279.00
426784	426783	B27FH-ADA	Full Height Door Base Cabinet 27" Wide ADA height	13.4	\$284.00
426790	426789	B30FH-ADA	Full Height Door Base Cabinet 30" Wide ADA height	14.9	\$296.00
426796	426795	B33FH-ADA	Full Height Door Base Cabinet 33" Wide ADA height	16.3	\$307.00
426802	426801	B36FH-ADA	Full Height Door Base Cabinet 36" Wide ADA height	17.8	\$319.00

BLUE = Extended lead time

DRAWER BASE



“UD” signifies upgraded drawer, “ADA” signifies ADA compliant height of 32½”

GRAY #	WHITE #	USER CODE	DESCRIPTION	FT ³	LIST PRICE
426552	426334	DB312	Drawer Base Cabinet 12" Wide	6.5	\$346.00
426555	426335	DB315	Drawer Base Cabinet 15" Wide	8.0	\$362.00
426558	426336	DB318	Drawer Base Cabinet 18" Wide	9.6	\$380.00
428760	428719	DB321	Drawer Base Cabinet 21" Wide	10.5	\$396.00
426561	426337	DB324	Drawer Base Cabinet 24" Wide	12.6	\$415.00
428764	428723	DB327	Drawer Base Cabinet 27" Wide	13.5	\$423.00
426564	426338	DB330	Drawer Base Cabinet 30" Wide	15.8	\$447.00
426554	426553	DB312UD	Drawer Base Cabinet 12" Wide Upgraded Drawer	6.5	\$584.00
426557	426556	DB315UD	Drawer Base Cabinet 15" Wide Upgraded Drawer	8.0	\$601.00
426560	426559	DB318UD	Drawer Base Cabinet 18" Wide Upgraded Drawer	9.5	\$619.00
428762	428721	DB321UD	Drawer Base Cabinet 21" Wide Upgraded Drawer	10.5	\$636.00
426563	426562	DB324UD	Drawer Base Cabinet 24" Wide Upgraded Drawer	12.7	\$654.00
428766	428732	DB327UD	Drawer Base Cabinet 27" Wide Upgraded Drawer	13.5	\$663.00
426566	426565	DB330UD	Drawer Base Cabinet 30" Wide Upgraded Drawer	15.8	\$687.00

DRAWER BASE



"ADA" signifies ADA compliant height of 32½"

GRAY #	WHITE #	USER CODE	DESCRIPTION	FT ³	LIST PRICE
426806	426805	DB312-ADA	Drawer Base Cabinet 12" Wide ADA height	6.1	\$344.00
426810	426809	DB315-ADA	Drawer Base Cabinet 15" Wide ADA height	7.5	\$361.00
426814	426813	DB318-ADA	Drawer Base Cabinet 18" Wide ADA height	9.0	\$379.00
428761	428720	DB321-ADA	Drawer Base Cabinet 21" Wide ADA height	10.0	\$396.00
426818	426817	DB324-ADA	Drawer Base Cabinet 24" Wide ADA height	12.0	\$414.00
428765	428731	DB327-ADA	Drawer Base Cabinet 27" Wide ADA height	12.7	\$423.00
426822	426821	DB330-ADA	Drawer Base Cabinet 30" Wide ADA height	15.0	\$447.00
426808	426807	DB312UD-ADA	Drawer Base Cabinet 12" Wide Upgraded Drawer ADA height	6.1	\$584.00
426812	426811	DB315UD-ADA	Drawer Base Cabinet 15" Wide Upgraded Drawer ADA height	7.5	\$601.00
426816	426815	DB318UD-ADA	Drawer Base Cabinet 18" Wide Upgraded Drawer ADA height	9.0	\$619.00
428763	428722	DB321UD-ADA	Drawer Base Cabinet 21" Wide Upgraded Drawer ADA height	10.0	\$636.00
426820	426819	DB324UD-ADA	Drawer Base Cabinet 24" Wide Upgraded Drawer ADA height	12.0	\$654.00
428767	428733	DB327UD-ADA	Drawer Base Cabinet 27" Wide Upgraded Drawer ADA height	12.7	\$663.00
426824	426823	DB330UD-ADA	Drawer Base Cabinet 30" Wide Upgraded Drawer ADA height	14.9	\$687.00

BLUE = Extended lead time

SINK BASE

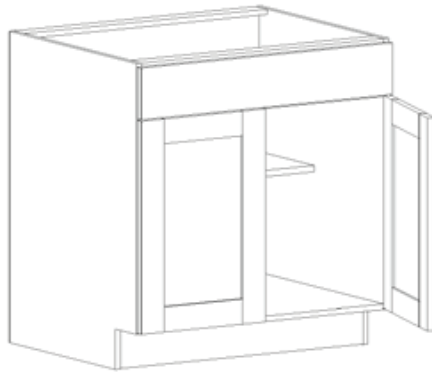

GRAY #	WHITE #	USER CODE	DESCRIPTION	FT ³	LIST PRICE
429074	429069	SB24	Sink Base Cabinet 24" Wide	14.0	\$290.00
428910	428909	SB27	Sink Base Cabinet 27" Wide	15.0	\$295.00
426572	426331	SB30	Sink Base Cabinet 30" Wide	15.8	\$318.00
426573	426332	SB33	Sink Base Cabinet 33" Wide	17.3	\$326.00
426574	426333	SB36	Sink Base Cabinet 36" Wide	18.9	\$350.00

ADA COMPLIANT SINK BASE W/ REMOVABLE FRONT

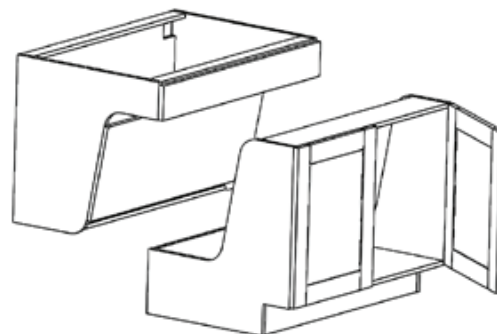
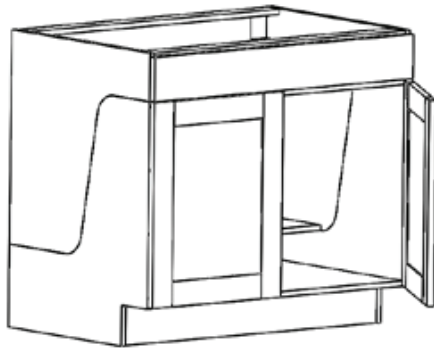

- Wall-mounted ADA compliant cabinet
- Removable front used when ADA compliance not needed

- Wall mount section cabinet available without removable front upon request (Price upon request)

GRAY #	WHITE #	USER CODE	DESCRIPTION	FT ³	LIST PRICE
427936	427935	SB30RF-ADA	Sink Base w/ Removable Front ADA Compliant 24" Depth 32.5" Height	14.1	\$863.00
427938	427937	SB33RF-ADA	Sink Base w/ Removable Front ADA Compliant 24" Depth 32.5" Height	15.5	\$871.00
426826	426825	SB36RF-ADA	Sink Base w/ Removable Front ADA Compliant 24" Depth 32.5" Height	16.9	\$884.00
427940	427939	VS30RF-ADA	Vanity Sink Base w/ Removable Front ADA Compliant 21" Depth 32.5" Height	12.4	\$863.00
427942	427941	VS33RF-ADA	Vanity Sink Base w/ Removable Front ADA Compliant 21" Depth 32.5" Height	13.7	\$871.00
427306	427305	VS36RF-ADA	Vanity Sink Base w/ Removable Front ADA Compliant 21" Depth 32.5" Height	14.9	\$884.00

BLUE = Extended lead time

KNEE BASE CABINET

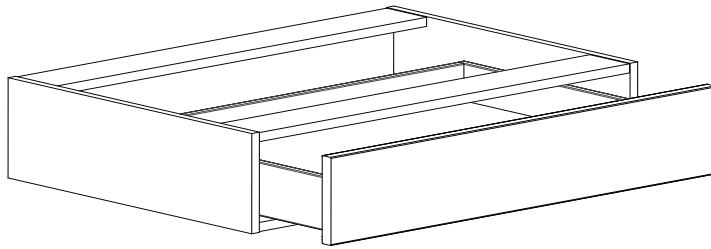

• Cabinets are 21" deep

"UD" signifies upgraded drawer

GRAY #	WHITE #	USER CODE	DESCRIPTION	FT ³	LIST PRICE
427670	427671	KSD30	Knee Base Drawer 30" wide	3.0	\$160.00
427674	427675	KSD36	Knee Base Drawer 36" wide	3.2	\$173.00
427672	427673	KSD30UD	Knee Base Drawer 30" wide Upgraded Drawer	2.7	\$240.00
427676	427677	KSD36UD	Knee Base Drawer 36" wide Upgraded Drawer	3.2	\$253.00

MICROWAVE BASE CABINET

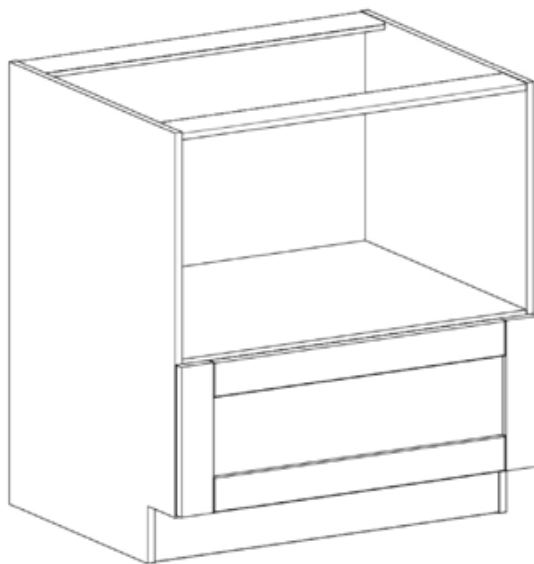

• Rough opening for microwave is 17" tall x 28.75" wide

"UD" signifies upgraded drawer

GRAY #	WHITE #	USER CODE	DESCRIPTION	FT ³	LIST PRICE
427944	427943	MBC30	Microwave Base Cabinet 30" Wide	15.5	\$435.00
427965	427964	MBC30UD	Microwave Base Cabinet 30" Wide Upgraded Drawer	15.5	\$515.00

BLIND CORNER BASE

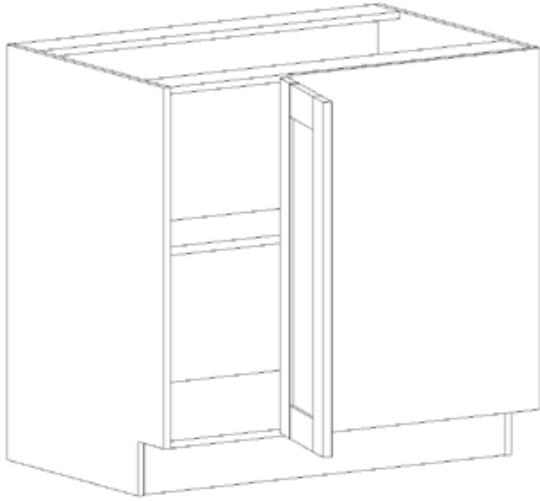

- Comes standard with one half-depth adjustable shelf
- Constructed with a solid, full coverage Blind Panel
- BB45 will accept a blind cabinet pull-out tray as an accessory. Holes are predrilled in cabinet. This item (#427319 BBTK) must be ordered separately.

GRAY #	WHITE #	USER CODE	DESCRIPTION	FT ³	LIST PRICE
426550	426340	BB39 R	Blind Base 39" Right Hand	18.9	\$450.00
426551	426341	BB42 R	Blind Base 42" Right Hand	20.4	\$465.00
427356	427355	BB45 R	Blind Base 45" Right Hand	21.0	\$480.00
426971	426970	BB39 L	Blind Base 39" Left Hand	18.8	\$450.00
426973	426972	BB42 L	Blind Base 42" Left Hand	20.4	\$465.00
427358	427357	BB45 L	Blind Base 45" Left Hand	21.0	\$480.00

SUGGESTED DIMENSIONS

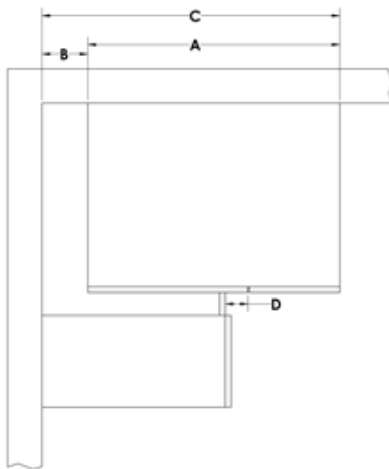

USER CODE	A - Case Width	Door Width	B1* - Pull (Wall Gap)	C - Installed Width	D - Blind Reveal	B2 - Min. Pull (Wall Gap)	B3 - Max. Pull (Wall Gap)
BB39 R/L	33"	12"	6"	39"	3"	4"	23"
BB42 R/L	36"	15"		42"			
BB45 R/L	39"	18"		45"			

*Must be installed using the "Suggested Pull B1" to achieve the stated size in the User Code. If installed using less than the "Suggested Pull B1," the "Blind Reveal" will be less than 3" and door swing clearance for adjacent items is restricted.

EASY REACH CORNER BASE

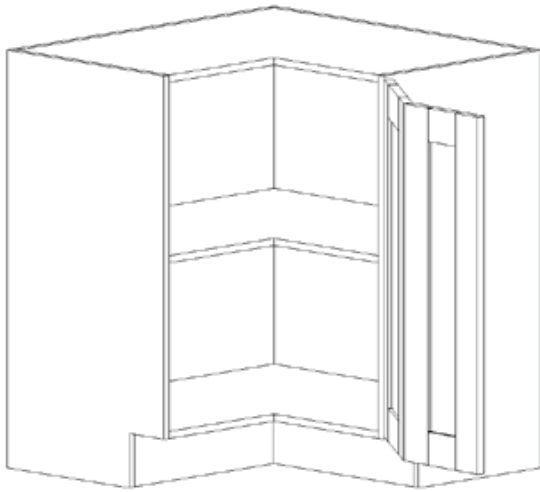

- BER36 comes standard with one adjustable shelf. Holes predrilled to accept Lazy Susan Tray Kit (LZSTK).
- If Lazy Susan is desired, you must purchase Easy Reach Corner Base (BER36) as well as the Lazy Susan Tray Kit (LZSTK).
- Lazy Susan Tray Kit (LZSTK) comes with one Lazy Susan tray; if two are desired, a quantity of two must be purchased.

GRAY #	WHITE #	USER CODE	DESCRIPTION	FT ³	LIST PRICE
426571	426339	BER36	BER36 Base Easy Reach Corner Cabinet	27.0	\$600.00
428971	428970	LS36	LS36 Lazy Susan Cabinet (Includes 2 Tray Kits)	27.0	\$840.00
n/a	427318	LZSTK	Lazy Susan Tray Kit (Includes 1 Tray)	2.5	\$100.00

DIMENSIONS

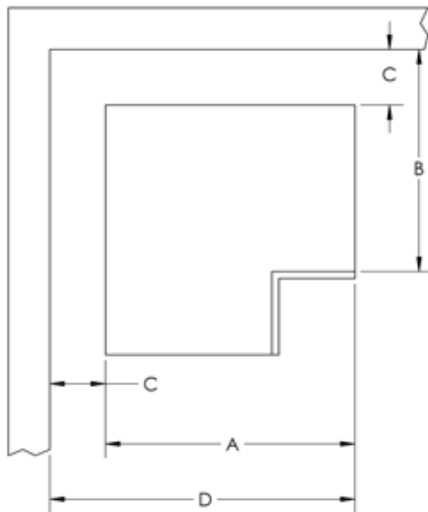

USER CODE	A - Case Width	B - Installed Depth	C - Wall Gap	D - Installed Width
BER36	30"	24"	6"	36"

WALL 12" HIGH

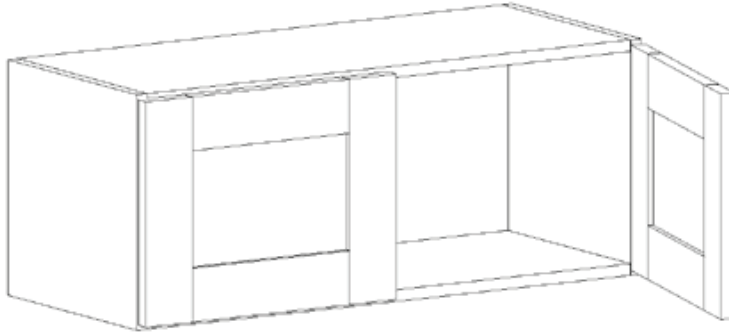

• No shelf included

"GD" signifies cabinet with glass doors

GRAY #	WHITE #	USER CODE	DESCRIPTION	FT ³	LIST PRICE
428784	428750	W2112	Wall Cabinet 21" Wide 12" High	2.0	\$123.00
427963	427962	W2412	Wall Cabinet 24" Wide 12" High	3.8	\$193.00
426660	426362	W3012	Wall Cabinet 30" Wide 12" High	3.0	\$172.00
426677	426363	W3312	Wall Cabinet 33" Wide 12" High	3.3	\$179.00
426692	426364	W3612	Wall Cabinet 36" Wide 12" High	3.6	\$183.00
426709	426365	W3912	Wall Cabinet 39" Wide 12" High	3.9	\$187.00
429118	429089	W3012/24	Wall Cabinet 30" Wide 12" High 24" Deep	2.7	\$203.00
429123	429094	W3312/24	Wall Cabinet 33" Wide 12" High 24" Deep	3.1	\$207.00
427269	427268	W3612/24	Wall Cabinet 36" Wide 12" High 24" Deep	6.3	\$210.00
426712	426366	W3912/24	Wall Cabinet 39" Wide 12" High 24" Deep	7.3	\$225.00
426662	426661	W3012GD	Wall Cabinet 30" Wide 12" High w/Glass Door	5.5	\$257.00
426679	426678	W3312GD	Wall Cabinet 33" Wide 12" High w/Glass Door	6.1	\$268.00
426694	426693	W3612GD	Wall Cabinet 36" Wide 12" High w/Glass Door	6.5	\$274.00
426711	426710	W3912GD	Wall Cabinet 39" Wide 12" High w/Glass Door	7.1	\$280.00

BLUE = Extended lead time

WALL 15" HIGH

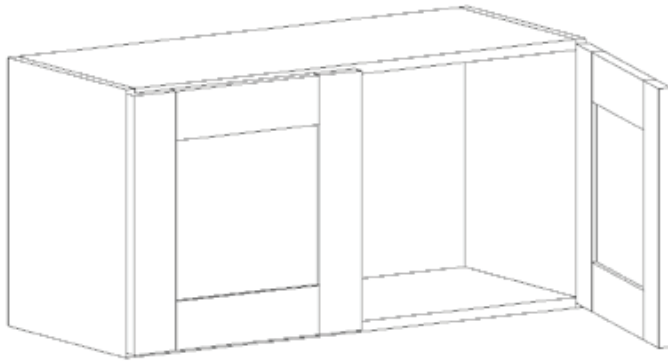

• No shelf included

"GD" signifies cabinet with glass doors

GRAY #	WHITE #	USER CODE	DESCRIPTION	FT ³	LIST PRICE
428785	428751	W2115	Wall Cabinet 21" Wide 15" High	2.6	\$128.00
426663	426367	W3015	Wall Cabinet 30" Wide 15" High	3.7	\$178.00
426680	426368	W3315	Wall Cabinet 33" Wide 15" High	4.1	\$187.00
426695	426369	W3615	Wall Cabinet 36" Wide 15" High	4.4	\$192.00
426715	426370	W3915	Wall Cabinet 39" Wide 15" High	4.8	\$195.00
429119	429090	W3015/24	Wall Cabinet 30" Wide 15" High 24" Deep	5.8	\$212.00
429124	429095	W3315/24	Wall Cabinet 33" Wide 15" High 24" Deep	6.5	\$217.00
427271	427270	W3615/24	Wall Cabinet 36" Wide 15" High 24" Deep	7.8	\$221.00
427275	427274	W3915/24	Wall Cabinet 39" Wide 15" High 24" Deep	8.5	\$230.00
426665	426664	W3015GD	Wall Cabinet 30" Wide 15" High w/Glass Door	6.8	\$266.00
426682	426681	W3315GD	Wall Cabinet 33" Wide 15" High w/Glass Door	7.5	\$280.00
426697	426696	W3615GD	Wall Cabinet 36" Wide 15" High w/Glass Door	4.4	\$288.00
426717	426716	W3915GD	Wall Cabinet 39" Wide 15" High w/Glass Door	4.8	\$292.00

BLUE = Extended lead time

WALL 18" HIGH

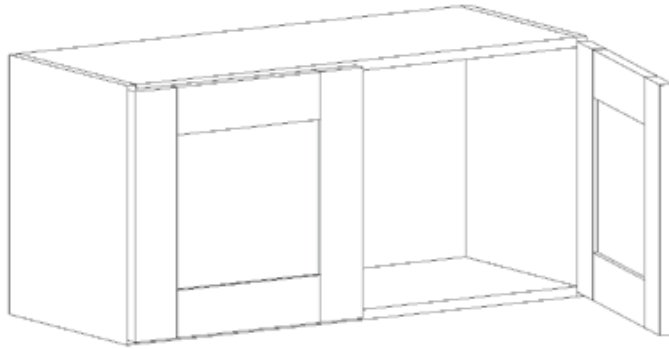

• No shelf included

GRAY #	WHITE #	USER CODE	DESCRIPTION	FT ³	LIST PRICE
428786	428752	W2118	Wall Cabinet 21" Wide 18" High	3.1	\$136.00
426647	426646	W2418	Wall Cabinet 24" Wide 18" High	3.5	\$173.00
428789	428755	W3018	Wall Cabinet 30" Wide 18" High	8.3	\$185.00
428790	428756	W3318	Wall Cabinet 33" Wide 18" High	9.1	\$197.00
428792	428758	W3618	Wall Cabinet 36" Wide 18" High	10.0	\$202.00
429120	429091	W3018/24	Wall Cabinet 30" Wide 18" High 24" Deep	8.3	\$222.00
429125	429096	W3318/24	Wall Cabinet 33" Wide 18" High 24" Deep	10.0	\$228.00
429128	429099	W3618/24	Wall Cabinet 36" Wide 18" High 24" Deep	10.9	\$234.00
429130	429101	W3918/24	Wall Cabinet 39" Wide 18" High 24" Deep	11.8	\$242.00

BLUE = Extended lead time

WALL 21" HIGH

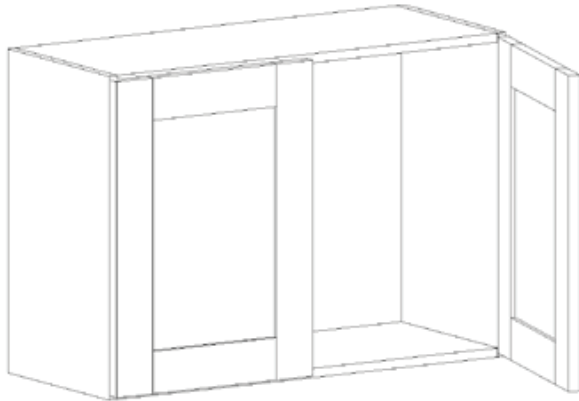

• No shelf included

"GD" signifies cabinet with glass doors

GRAY #	WHITE #	USER CODE	DESCRIPTION	FT ³	LIST PRICE
428787	428753	W2121	Wall Cabinet 21" Wide 21" High	4.0	\$143.00
426666	426371	W3021	Wall Cabinet 30" Wide 21" High	5.1	\$197.00
426683	426373	W3321	Wall Cabinet 33" Wide 21" High	5.6	\$205.00
426698	426374	W3621	Wall Cabinet 36" Wide 21" High	6.1	\$214.00
426718	426375	W3921	Wall Cabinet 39" Wide 21" High	6.6	\$219.00
429121	429092	W3021/24	Wall Cabinet 30" Wide 21" High 24" Deep	6.0	\$234.00
429126	429097	W3321/24	Wall Cabinet 33" Wide 21" High 24" Deep	7.0	\$240.00
427273	427272	W3621/24	Wall Cabinet 36" Wide 21" High 24" Deep	8.0	\$247.00
427277	427276	W3921/24	Wall Cabinet 39" Wide 21" High 24" Deep	9.0	\$257.00
426668	426667	W3021GD	Wall Cabinet 30" Wide 21" High w/Glass Door	9.5	\$295.00
426685	426684	W3321GD	Wall Cabinet 33" Wide 21" High w/Glass Door	10.4	\$324.00
426700	426699	W3621GD	Wall Cabinet 36" Wide 21" High w/Glass Door	11.7	\$306.00
426720	426719	W3921GD	Wall Cabinet 39" Wide 21" High w/Glass Door	12.3	\$320.00

BLUE = Extended lead time

WALL 24" HIGH

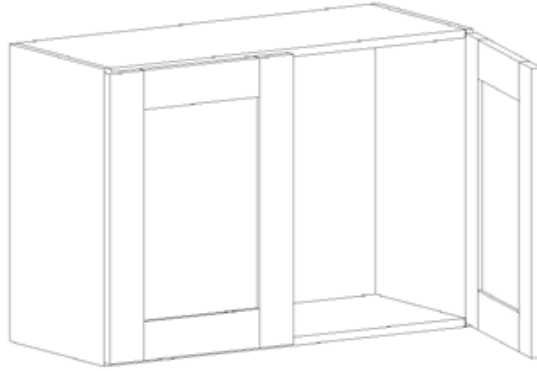

• Comes standard with one adjustable shelf

"GD" signifies cabinet with glass doors

GRAY #	WHITE #	USER CODE	DESCRIPTION	FT ³	LIST PRICE
428788	428754	W2124	Wall Cabinet 21" Wide 24" High	4.0	\$158.00
426670	426669	W3024	Wall Cabinet 30" Wide 24" High	5.8	\$216.00
428791	428757	W3324	Wall Cabinet 33" Wide 24" High	6.1	\$226.00
426702	426701	W3624	Wall Cabinet 36" Wide 24" High	7.0	\$232.00
426722	426721	W3924	Wall Cabinet 39" Wide 24" High	7.6	\$242.00
429122	429093	W3024/24	Wall Cabinet 30" Wide 24" High 24" Deep	7.8	\$252.00
429127	429098	W3324/24	Wall Cabinet 33" Wide 24" High 24" Deep	8.0	\$260.00
429129	429100	W3624/24	Wall Cabinet 36" Wide 24" High 24" Deep	9.0	\$268.00
429131	429102	W3924/24	Wall Cabinet 39" Wide 24" High 24" Deep	9.6	\$279.00

BLUE = Extended lead time

WALL 30" HIGH

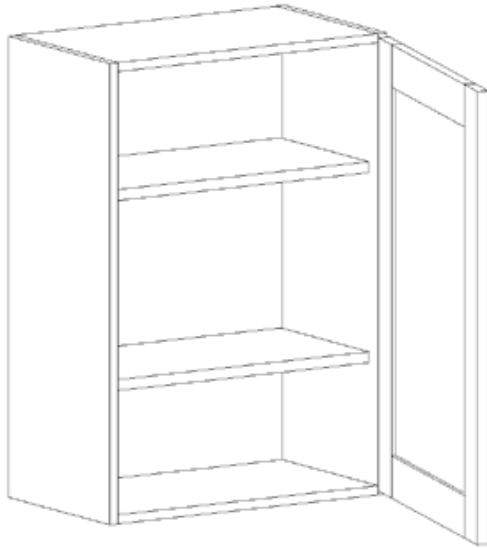

- Comes standard with two adjustable shelves
- Reversible for right hand & left hand by flipping upside down

"GD" signifies cabinet with glass doors

GRAY #	WHITE #	USER CODE	DESCRIPTION	FT ³	LIST PRICE
426723	426342	W930	Wall Cabinet 9" Wide 30" High	2.3	\$133.00
426610	426344	W1230	Wall Cabinet 12" Wide 30" High	3.0	\$144.00
426617	426346	W1530	Wall Cabinet 15" Wide 30" High	3.7	\$154.00
426623	426348	W1830	Wall Cabinet 18" Wide 30" High	4.4	\$165.00
426640	426350	W2130	Wall Cabinet 21" Wide 30" High	5.1	\$177.00
426725	426724	W930GD	Wall Cabinet 9" Wide 30" High w/Glass Door	9.4	\$195.00
426612	426611	W1230GD	Wall Cabinet 12" Wide 30" High w/Glass Door	3.0	\$212.00
426619	426618	W1530GD	Wall Cabinet 15" Wide 30" High w/Glass Door	6.8	\$227.00
426625	426624	W1830GD	Wall Cabinet 18" Wide 30" High w/Glass Door	7.1	\$243.00
426642	426641	W2130GD	Wall Cabinet 21" Wide 30" High w/Glass Door	8.7	\$265.00

BLUE = Extended lead time

WALL 30" HIGH DOUBLE DOOR

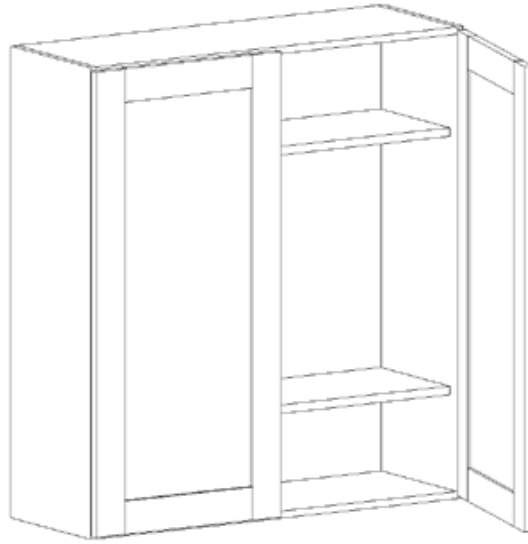

• Comes standard with two adjustable shelves

"GD" signifies cabinet with glass doors

GRAY #	WHITE #	USER CODE	DESCRIPTION	FT ³	LIST PRICE
426648	426352	W2430	Wall Cabinet 24" Wide 30" High	5.8	\$223.00
426654	426354	W2730	Wall Cabinet 27" Wide 30" High	6.6	\$233.00
426671	426356	W3030	Wall Cabinet 30" Wide 30" High	7.3	\$244.00
426686	426358	W3330	Wall Cabinet 33" Wide 30" High	8.0	\$254.00
426703	426360	W3630	Wall Cabinet 36" Wide 30" High	8.7	\$267.00
426650	426649	W2430GD	Wall Cabinet 24" Wide 30" High w/Glass Door	10.8	\$331.00
426656	426655	W2730GD	Wall Cabinet 27" Wide 30" High w/Glass Door	11.0	\$345.00
426673	426672	W3030GD	Wall Cabinet 30" Wide 30" High w/Glass Door	13.5	\$362.00
426688	426687	W3330GD	Wall Cabinet 33" Wide 30" High w/Glass Door	14.0	\$377.00
426705	426704	W3630GD	Wall Cabinet 36" Wide 30" High w/Glass Door	15.0	\$396.00

BLUE = Extended lead time

WALL 39" HIGH

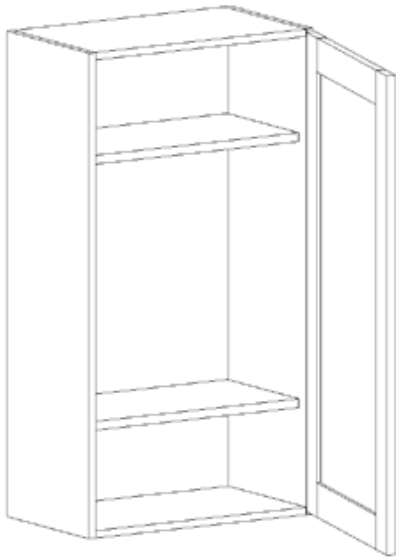

- Comes standard with two adjustable shelves
- Reversible for right hand & left hand by flipping upside down

"GD" signifies cabinet with glass doors

GRAY #	WHITE #	USER CODE	DESCRIPTION	FT ³	LIST PRICE
426726	426343	W939	Wall Cabinet 9" Wide 39" High	2.9	\$164.00
426613	426345	W1239	Wall Cabinet 12" Wide 39" High	3.9	\$175.00
426620	426347	W1539	Wall Cabinet 15" Wide 39" High	5.2	\$188.00
426637	426349	W1839	Wall Cabinet 18" Wide 39" High	5.7	\$204.00
426643	426351	W2139	Wall Cabinet 21" Wide 39" High	7.1	\$223.00
426728	426727	W939GD	Wall Cabinet 9" Wide 39" High w/Glass Door	2.8	\$246.00
426615	426614	W1239GD	Wall Cabinet 12" Wide 39" High w/Glass Door	7.1	\$262.00
426622	426621	W1539GD	Wall Cabinet 15" Wide 39" High w/Glass Door	8.9	\$281.00
426639	426638	W1839GD	Wall Cabinet 18" Wide 39" High w/Glass Door	10.8	\$305.00
426645	426644	W2139GD	Wall Cabinet 21" Wide 39" High w/Glass Door	12.3	\$335.00

BLUE = Extended lead time

WALL 39" HIGH DOUBLE DOOR

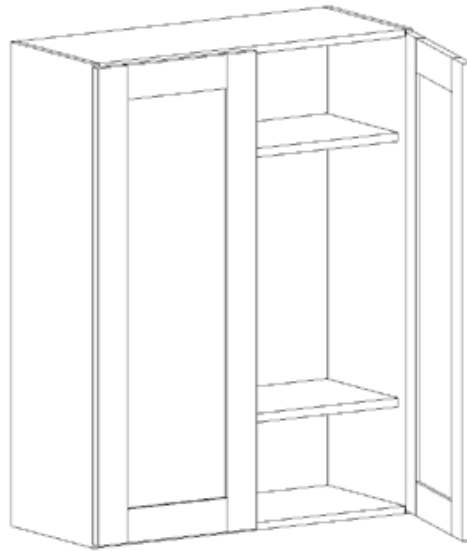

• Comes standard with two adjustable shelves

"GD" signifies cabinet with glass doors

GRAY #	WHITE #	USER CODE	DESCRIPTION	FT ³	LIST PRICE
426651	426353	W2439	Wall Cabinet 24" Wide 39" High	7.6	\$256.00
426657	426355	W2739	Wall Cabinet 27" Wide 39" High	8.5	\$264.00
426674	426357	W3039	Wall Cabinet 30" Wide 39" High	9.4	\$279.00
426689	426359	W3339	Wall Cabinet 33" Wide 39" High	10.3	\$298.00
426706	426361	W3639	Wall Cabinet 36" Wide 39" High	11.3	\$311.00
426653	426652	W2439GD	Wall Cabinet 24" Wide 39" High w/Glass Door	8.0	\$380.00
426659	426658	W2739GD	Wall Cabinet 27" Wide 39" High w/Glass Door	9.0	\$396.00
426676	426675	W3039GD	Wall Cabinet 30" Wide 39" High w/Glass Door	10.0	\$415.00
426691	426690	W3339GD	Wall Cabinet 33" Wide 39" High w/Glass Door	11.0	\$442.00
426708	426707	W3639GD	Wall Cabinet 36" Wide 39" High w/Glass Door	12.0	\$461.00

BLUE = Extended lead time

BLIND WALL



- Constructed with a solid, full coverage Blind Panel
- Comes standard with two adjustable shelves
- Reversible for right hand & left hand by flipping upside down

"GD" signifies cabinet with glass doors

GRAY #	WHITE #	USER CODE	DESCRIPTION	FT ³	LIST PRICE
426729	426379	WB3330 R/L	Wall Blind Cabinet 33" X 30" High Reversible R/L	7.3	\$373.00
426735	426380	WB3630 R/L	Wall Blind Cabinet 36" X 30" High Reversible R/L	8.0	\$402.00
426732	426381	WB3339 R/L	Wall Blind Cabinet 33" X 39" High Reversible R/L	9.4	\$408.00
426738	426382	WB3639 R/L	Wall Blind Cabinet 36" X 39" High Reversible R/L	10.3	\$426.00
426731	426730	WB3330GD R/L	Wall Blind Cabinet 33" X 30" High w/ Glass Door Reversible R/L	7.3	\$454.00
426737	426736	WB3630GD R/L	Wall Blind Cabinet 36" X 30" High w/ Glass Door Reversible R/L	8.0	\$490.00
426734	426733	WB3339GD R/L	Wall Blind Cabinet 33" X 39" High w/ Glass Door Reversible R/L	9.4	\$510.00
426740	426739	WB3639GD R/L	Wall Blind Cabinet 36" X 39" High w/ Glass Door Reversible R/L	10.3	\$537.00

BLUE = Extended lead time

SUGGESTED DIMENSIONS

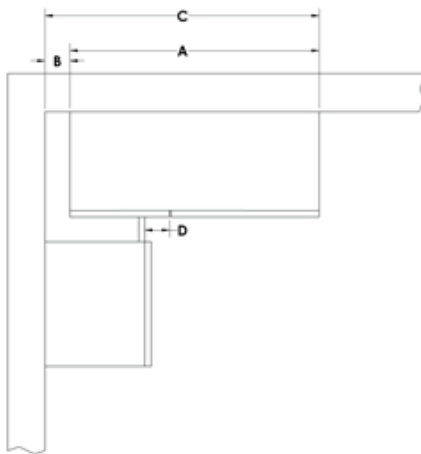

USER CODE	A - Case Width	Door Width	B1* - Pull (Wall Gap)	C - Installed Width	D - Blind Reveal	B2 - Min. Pull (Wall Gap)	B3 - Max. Pull (Wall Gap)
WB3330 R/L	30"	18"	3"	33"	3"	1"	11"
WB3630 R/L	33"	21"		36"			
WB3339 R/L	30"	18"		33"			
WB3639 R/L	33"	21"		36"			

* Must be installed using the "Suggested Pull B1" to achieve the stated size in the User Code. If installed using less than the "Suggested Pull B1," the "Blind Reveal" will be less than 3" and door swing clearance for adjacent items is restricted.

WALL DIAGONAL CABINET

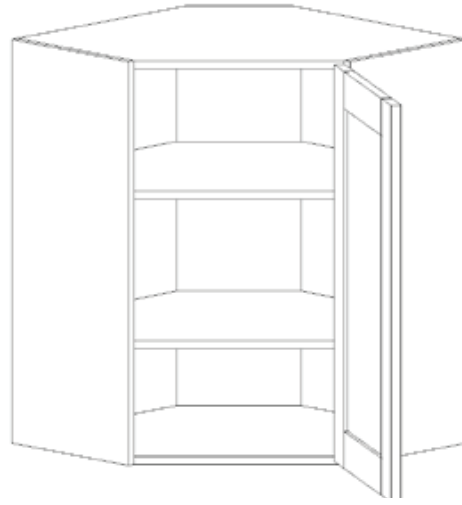

- Comes standard with two adjustable shelves
- 27" wide cabinets are bump-out cabinets that are 15" deep on each side

"GD" signifies cabinet with glass doors

GRAY #	WHITE #	USER CODE	DESCRIPTION	FT ³	LIST PRICE
426741	426376	WDC2430	Wall Diagonal Cabinet 24" Wide 30" High	10.6	\$386.00
426744	426377	WDC2439	Wall Diagonal Cabinet 24" Wide 39" High	13.7	\$415.00
426747	426378	WDC2739	Wall Diagonal Cabinet 27" Wide 39" High	17.3	\$440.00
426743	426742	WDC2430GD	Wall Diagonal Cabinet 24" Wide 30" High w/Glass Door	10.6	\$578.00
426746	426745	WDC2439GD	Wall Diagonal Cabinet 24" Wide 39" High w/Glass Door	13.7	\$618.00
426749	426748	WDC2739GD	Wall Diagonal Cabinet 27" Wide 39" High w/Glass Door	17.3	\$656.00

BLUE = Extended lead time

UNIVERSAL OVEN CABINET

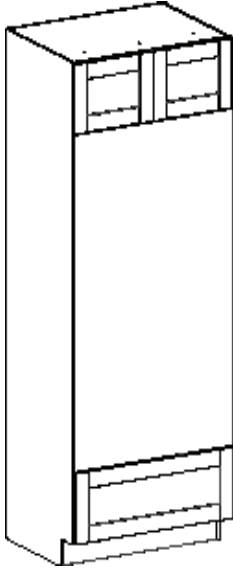

- Drawer front height is 11.73" for both 84" and 93" tall cabinets
- Door height is 12" on the 84" tall cabinet; 21" on the 93" tall cabinet

"UD" signifies upgraded drawer

GRAY #	WHITE #	USER CODE	DESCRIPTION	FT ³	LIST PRICE
429141	429115	UOC3384	Oven Cabinet 34" Wide 84" High	10.6	\$990.00
429142	429116	UOC3393	Oven Cabinet 33" Wide 93" High	13.7	\$1000.00
430063	430062	UOC3384UD	Oven Cabinet 34" Wide 84" High Upgraded Drawer	10.6	\$1070.00
430067	430066	UOC3393UD	Oven Cabinet 33" Wide 93" High Upgraded Drawer	13.7	\$1080.00

BLUE = Extended lead time

MICROWAVE WALL

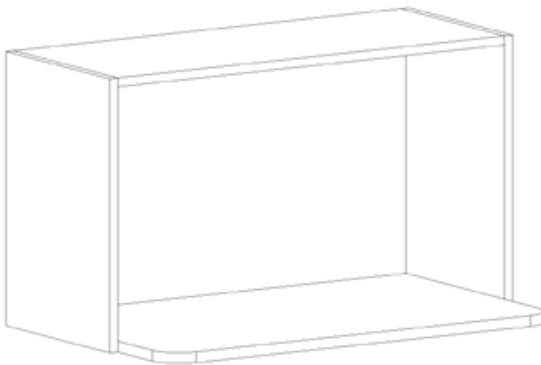

- Interior of cabinet matches kitchen door color
- Bottom shelf is 18" deep

GRAY #	WHITE #	USER CODE	DESCRIPTION	FT ³	LIST PRICE
426750	426383	WMC3018	Wall Microwave Cabinet 30" Wide 18" High	6.5	\$303.00

LINEN CABINETS



- Comes standard with four adjustable, full-depth shelves plus one fixed shelf
- Shipped with hinges on right, can be changed in the field
- Cabinet depth is 21"

GRAY #	WHITE #	USER CODE	DESCRIPTION	FT ³	LIST PRICE
429133	429107	LC1284	Linen Cabinet 12" Wide 84" High	17.1	\$566.00
426567	426388	LC1584	Linen Cabinet 15" Wide 84" High	17.1	\$570.00
427562	427561	LC1884	Linen Cabinet 18" Wide 84" High	19.3	\$595.00
429137	429111	LC2184	Linen Cabinet 21" Wide 84" High	19.3	\$643.00
429134	429108	LC1293	Linen Cabinet 12" Wide 93" High	18.9	\$579.00
426568	426389	LC1593	Linen Cabinet 15" Wide 93" High	18.9	\$596.00
427564	427563	LC1893	Linen Cabinet 18" Wide 93" High	21.3	\$623.00
429138	429112	LC2193	Linen Cabinet 21" Wide 93" High	21.3	\$658.00

LINEN 24" WIDE DOUBLE DOOR

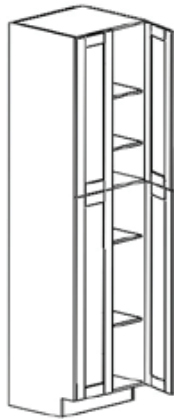

- Comes standard with four adjustable, full-depth shelves plus one fixed shelf
- Cabinet depth is 24"

GRAY #	WHITE #	USER CODE	DESCRIPTION	FT ³	LIST PRICE
426569	426390	LC2484	Linen Cabinet 24" Wide 84" High	30.0	\$715.00
426570	426391	LC2493	Linen Cabinet 24" Wide 93" High	29.8	\$756.00

UTILITY CABINETS

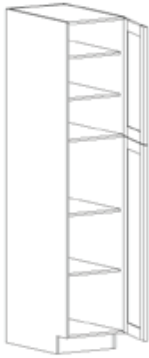

- Comes standard with four adjustable, full-depth shelves plus one fixed shelf
- Shipped with hinges on right, can be changed in the field
- Cabinet depth is 24"

GRAY #	WHITE #	USER CODE	DESCRIPTION	FT ³	LIST PRICE
429135	429109	UC1284	Utility Cabinet 12" Wide 84" High	19.3	\$568.00
426576	426384	UC1584	Utility Cabinet 15" Wide 84" High	19.3	\$592.00
427558	427557	UC1884	Utility Cabinet 18" Wide 84" High	21.9	\$616.00
429139	429113	UC2184	Utility Cabinet 21" Wide 84" High	21.9	\$645.00
429136	429110	UC1293	Utility Cabinet 12" Wide 93" High	21.4	\$582.00
426577	426385	UC1593	Utility Cabinet 15" Wide 93" High	21.4	\$617.00
427560	427559	UC1893	Utility Cabinet 18" Wide 93" High	24.2	\$641.00
429140	429114	UC2193	Utility Cabinet 21" Wide 93" High	24.2	\$680.00

UTILITY 24" WIDE DOUBLE DOOR

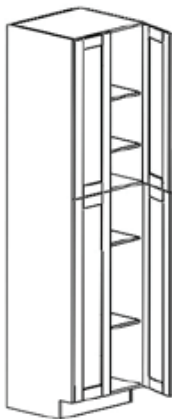

- Comes standard with four adjustable, full-depth shelves plus one fixed shelf
- Cabinet depth is 24"

GRAY #	WHITE #	USER CODE	DESCRIPTION	FT ³	LIST PRICE
426578	426386	UC2484	Utility Cabinet 24" Wide 84" High	30.6	\$749.00
426579	426387	UC2493	Utility Cabinet 24" Wide 93" High	33.8	\$789.00

VANITY BASE



- Comes standard with one half-depth adjustable shelf
- Shipped with hinges on right, can be changed in the field

“UD” signifies upgraded drawer, “ADA” signifies ADA compliant height of 32½”

GRAY #	WHITE #	USER CODE	DESCRIPTION	FT ³	LIST PRICE
426580	426397	VB12	Vanity Base Cabinet 12" Wide	6.5	\$211.00
426583	426398	VB15	Vanity Base Cabinet 15" Wide	7.5	\$223.00
426587	426399	VB18	Vanity Base Cabinet 18" Wide	9.6	\$235.00
428768	428734	VB21	Vanity Base Cabinet 21" Wide	11.0	\$254.00
428772	428738	VB24	Vanity Base Cabinet 24" Wide	13.0	\$286.00
426582	426581	VB12UD	Vanity Base Cabinet 12" Wide Upgraded Drawer	6.5	\$288.00
426585	426584	VB15UD	Vanity Base Cabinet 15" Wide Upgraded Drawer	8.0	\$300.00
426589	426588	VB18UD	Vanity Base Cabinet 18" Wide Upgraded Drawer	9.6	\$313.00
428770	428736	VB21UD	Vanity Base Cabinet 21" Wide Upgraded Drawer	11.0	\$334.00
428774	428740	VB24UD	Vanity Base Cabinet 24" Wide Upgraded Drawer	13.0	\$366.00
426828	426827	VB12-ADA	Vanity Base Cabinet 12" Wide ADA height	5.0	\$211.00
426832	426831	VB15-ADA	Vanity Base Cabinet 15" Wide ADA height	6.2	\$223.00
426836	426835	VB18-ADA	Vanity Base Cabinet 18" Wide ADA height	7.4	\$235.00
428769	428735	VB21-ADA	Vanity Base Cabinet 21" Wide ADA height	8.4	\$254.00
428773	428739	VB24-ADA	Vanity Base Cabinet 24" Wide ADA height	8.4	\$286.00
426830	426829	VB12UD-ADA	Vanity Base Cabinet 12" Wide Upgraded Drawer ADA height	5.0	\$288.00
426834	426833	VB15UD-ADA	Vanity Base Cabinet 15" Wide Upgraded Drawer ADA height	6.2	\$300.00
426838	426837	VB18UD-ADA	Vanity Base Cabinet 18" Wide Upgraded Drawer ADA height	7.4	\$313.00
428771	428737	VB21UD-ADA	Vanity Base Cabinet 21" Wide Upgraded Drawer ADA height	8.4	\$334.00
428775	428741	VB24UD-ADA	Vanity Base Cabinet 24" Wide Upgraded Drawer ADA height	8.4	\$366.00

BLUE = Extended lead time

VANITY DRAWER BASE

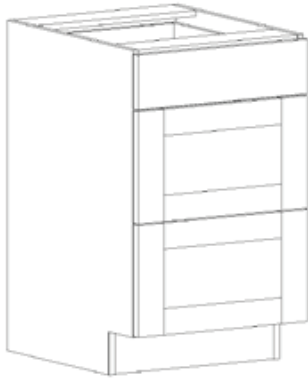

"UD" signifies upgraded drawer, "ADA" signifies ADA compliant height of 32½"

GRAY #	WHITE #	USER CODE	DESCRIPTION	FT ³	LIST PRICE
426590	426400	VDB312	Vanity Drawer Base Cabinet 12" Wide	2.0	\$339.00
426593	426401	VDB315	Vanity Drawer Base Cabinet 15" Wide	3.1	\$355.00
426596	426402	VDB318	Vanity Drawer Base Cabinet 18" Wide	4.5	\$373.00
428776	428742	VDB321	Vanity Drawer Base Cabinet 21" Wide	8.0	\$391.00
428780	428746	VDB324	Vanity Drawer Base Cabinet 24" Wide	8.5	\$402.00
426592	426591	VDB312UD	Vanity Drawer Base Cabinet 12" Wide Upgraded Drawer	5.7	\$578.00
426595	426594	VDB315UD	Vanity Drawer Base Cabinet 15" Wide Upgraded Drawer	7.1	\$594.00
426598	426597	VDB318UD	Vanity Drawer Base Cabinet 18" Wide Upgraded Drawer	8.4	\$612.00
428778	428744	VDB321UD	Vanity Drawer Base Cabinet 21" Wide Upgraded Drawer	8.0	\$631.00
428782	428748	VDB324UD	Vanity Drawer Base Cabinet 24" Wide Upgraded Drawer	8.5	\$642.00
426840	426839	VDB312-ADA	Vanity Drawer Base Cabinet 12" Wide ADA height	5.0	\$339.00
426844	426843	VDB315-ADA	Vanity Drawer Base Cabinet 15" Wide ADA height	6.2	\$355.00
426848	426847	VDB318-ADA	Vanity Drawer Base Cabinet 18" Wide ADA height	7.4	\$373.00
428777	428743	VDB321-ADA	Vanity Drawer Base Cabinet 21" Wide ADA height	8.4	\$391.00
428781	428747	VDB324-ADA	Vanity Drawer Base Cabinet 24" Wide ADA height	8.4	\$402.00
426842	426841	VDB312UD-ADA	Vanity Drawer Base Cabinet 12" Wide Upgraded Drawer ADA height	5.0	\$578.00
426846	426845	VDB315UD-ADA	Vanity Drawer Base Cabinet 15" Wide Upgraded Drawer ADA height	6.2	\$594.00
426850	426849	VDB318UD-ADA	Vanity Drawer Base Cabinet 18" Wide Upgraded Drawer ADA height	7.4	\$612.00
428779	428745	VDB321UD-ADA	Vanity Drawer Base Cabinet 21" Wide Upgraded Drawer ADA height	8.4	\$631.00
428783	428749	VDB324UD-ADA	Vanity Drawer Base Cabinet 24" Wide Upgraded Drawer ADAheight	8.4	\$642.00

BLUE = Extended lead time

VANITY SINK BASE

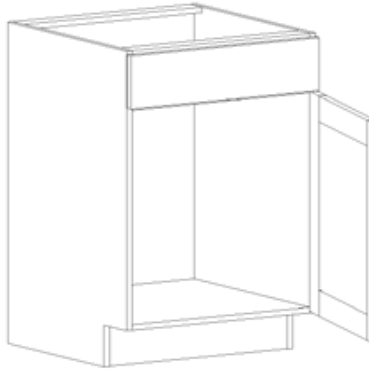

• Shipped with hinges on right, can be changed in the field

“ADA” signifies ADA compliant height of 32½”

GRAY #	WHITE #	USER CODE	DESCRIPTION	FT ³	LIST PRICE
426599	426392	VSB21	Vanity Sink Base 21" wide	6.4	\$229.00
426852	426851	VSB21-ADA	Vanity Sink Base 21" wide ADA height	6.4	\$229.00

VANITY SINK BASE DOUBLE DOOR

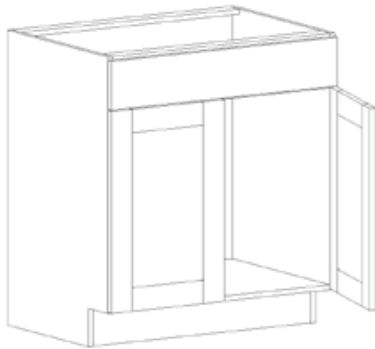

“ADA” signifies ADA compliant height of 32½”

GRAY #	WHITE #	USER CODE	DESCRIPTION	FT ³	LIST PRICE
426600	426393	VSB24	Vanity Sink Base 24" wide	11.2	\$282.00
426601	426394	VSB27	Vanity Sink Base 27" wide	12.5	\$290.00
426602	426395	VSB30	Vanity Sink Base 30" wide	13.9	\$300.00
429077	429072	VSB33	Vanity Sink Base 33" wide	14.0	\$319.00
426603	426396	VSB36	Vanity Sink Base 36" wide	17.3	\$329.00
426854	426853	VSB24-ADA	Vanity Sink Base 24" wide ADA height	9.9	\$282.00
426856	426855	VSB27-ADA	Vanity Sink Base 27" wide ADA height	11.2	\$290.00
426858	426857	VSB30-ADA	Vanity Sink Base 30" wide ADA height	13.0	\$300.00
429078	429073	VSB33-ADA	Vanity Sink Base 33" wide ADA height	13.5	\$319.00
426860	426859	VSB36-ADA	Vanity Sink Base 36" wide ADA height	15.0	\$329.00

BLUE = Extended lead time

VANITY SINK DRAWER BASE

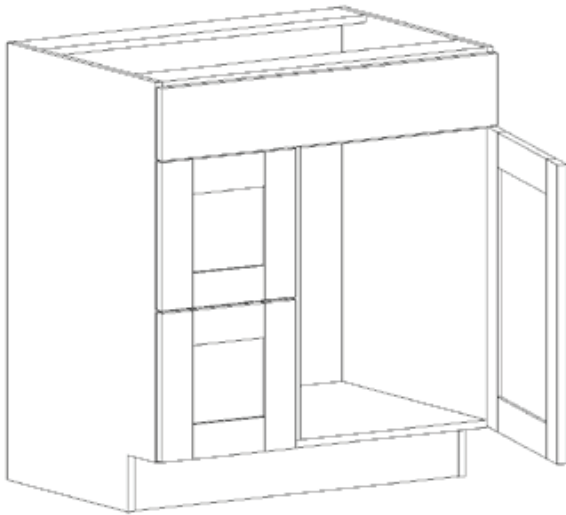

- Right hand / left hand must be specified
- 30" wide cabinet consists of two 12" wide drawers, one 18" door, and one false drawer front
- 36" wide cabinet consists of two 12" wide drawers, two 12" doors, and one false drawer front
- Picture shown illustrates left handed version of cabinet

"UD" signifies upgraded drawer

GRAY #	WHITE #	USER CODE	DESCRIPTION	FT ³	LIST PRICE
426604	426403	VSBD30 R	Vanity Sink Base Drawer Cabinet 30" Wide RH	14.0	\$532.00
426975	426974	VSBD30 L	Vanity Sink Base Drawer Cabinet 30" Wide LH	14.0	\$532.00
426607	426404	VSBD36 R	Vanity Sink Base Drawer Cabinet 36" Wide RH	16.6	\$601.00
426979	426978	VSBD36 L	Vanity Sink Base Drawer Cabinet 36" Wide LH	16.6	\$601.00
426606	426605	VSBD30UD R	Vanity Sink Base Drawer Cabinet 30" Wide Upgraded Drawer RH	14.0	\$691.00
426977	426976	VSBD30UD L	Vanity Sink Base Drawer Cabinet 30" Wide Upgraded Drawer LH	14.0	\$691.00
426609	426608	VSBD36UD R	Vanity Sink Base Drawer Cabinet 36" Wide Upgraded Drawer RH	16.6	\$761.00
426981	426980	VSBD36UD L	Vanity Sink Base Drawer Cabinet 36" Wide Upgraded Drawer LH	16.6	\$761.00

VANITY SINK DRAWER BASE

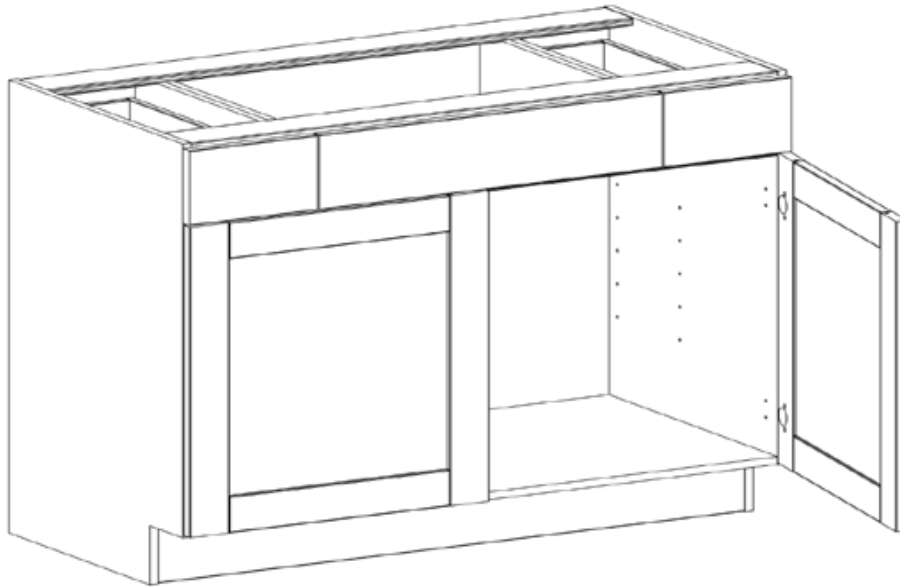

- Each drawer front uses a 9" drawer front.
- Inside dimension of drawer box is 5.75"

"UD" signifies upgraded drawer

GRAY #	WHITE #	USER CODE	DESCRIPTION	FT ³	LIST PRICE
429551	429550	VSBD36DD	Vanity Sink Base Drawer Cabinet 36" Wide w/2 Drawers	15.8	\$591.00
429605	429604	VSBD39DD	Vanity Sink Base Drawer Cabinet 39" Wide w/2 Drawers	15.8	\$600.00
429132	429117	VSBD42DD	Vanity Sink Base Drawer Cabinet 42" Wide w/2 Drawers	15.8	\$613.00
429591	429590	VSBD36DDUD	Vanity Sink Base Drawer Cabinet 36" Wide w/2 Upgraded Drawers	15.8	\$751.00
429607	429606	VSBD39DDUD	Vanity Sink Base Drawer Cabinet 39" Wide w/2 Upgraded Drawers	15.8	\$760.00
429587	429588	VSBD42DDUD	Vanity Sink Base Drawer Cabinet 42" Wide w/2 Upgraded Drawers	15.8	\$773.00

COMBO VANITY CABINETS

"UD" signifies upgraded drawer

GRAY #	WHITE #	USER CODE	DESCRIPTION	FT ³	LIST PRICE
429197	429178	VCDS60	VS ^B 24, VDB312, VS ^B 24 Combo 60" Wide 2 Bowl Vanity Base Cab	14.0	\$813.00
429204	429187	VCDS66	VS ^B 27, VDB312, VS ^B 27 Combo 66" Wide 2 Bowl Vanity Base Cab	14.0	\$828.00
429201	429185	VCDS72	VS ^B 30, VDB312, VS ^B 30 Combo 72" Wide 2 Bowl Vanity Base Cab	14.0	\$846.00
429206	429189	VCDS60UD	VS ^B 24, VDB312UD, VS ^B 24 Combo 60" Wide 2 Bowl Vanity Base Cab	14.0	\$1028.00
429212	429195	VCDS66UD	VS ^B 27, VDB312UD, VS ^B 27 Combo 66" Wide 2 Bowl Vanity Base Cab	14.0	\$1043.00
429210	429193	VCDS72UD	VS ^B 30, VDB312UD, VS ^B 30 Combo 72" Wide 2 Bowl Vanity Base Cab	14.0	\$1061.00
429200	429184	VCDDS48	VB12, VS ^B 24, VB12 Combo 48" Wide 1 Bowl Vanity Base Cab	14.0	\$634.00
429199	429183	VCDDS54	VB15, VS ^B 24, VB15 Combo 54" Wide 1 Bowl Vanity Base Cab	14.0	\$656.00
429198	429179	VCDDS60	VB12, VS ^B 36, VB12 Combo 60" Wide 1 Bowl Vanity Base Cab	14.0	\$676.00
429205	429188	VCDDS66	VB15, VS ^B 36, VB15 Combo 66" Wide 1 Bowl Vanity Base Cab	14.0	\$698.00
429203	429186	VCDDS72	VB18, VS ^B 36, VB18 Combo 72" Wide 1 Bowl Vanity Base Cab	14.0	\$720.00
429209	429192	VCDDS48UD	VB12UD, VS ^B 24, VB12UD Combo 48" Wide 1 Bowl Vanity Base Cab	14.0	\$773.00
429208	429191	VCDDS54UD	VB15UD, VS ^B 24, VB15UD Combo 54" Wide 1 Bowl Vanity Base Cab	14.0	\$794.00
429207	429190	VCDDS60UD	VB12UD, VS ^B 36, VB12UD Combo 60" Wide 1 Bowl Vanity Base Cab	14.0	\$815.00
429213	429196	VCDDS66UD	VB15UD, VS ^B 36, VB15UD Combo 66" Wide 1 Bowl Vanity Base Cab	14.0	\$837.00
429211	429194	VCDDS72UD	VB18UD, VS ^B 36, VB18UD Combo 72" Wide 1 Bowl Vanity Base Cab	14.0	\$860.00

MOLDINGS

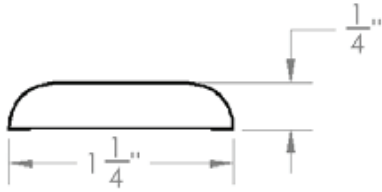

GRAY #	WHITE #	USER CODE	DESCRIPTION	FT ³	LIST PRICE EACH	LIST PRICE PER 10
426983	426982	BATTEN	Batten Scribe Molding	1.0	\$11.00	\$110.00

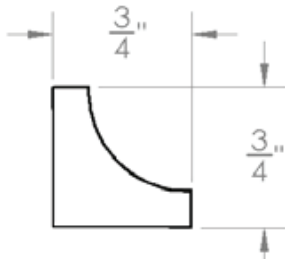

GRAY #	WHITE #	USER CODE	DESCRIPTION	FT ³	LIST PRICE EACH	LIST PRICE PER 10
426985	426984	ICM	Inside Corner Molding	1.0	\$15.00	\$150.00

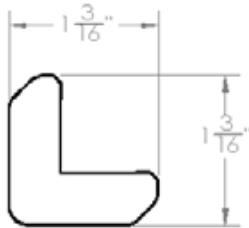

GRAY #	WHITE #	USER CODE	DESCRIPTION	FT ³	LIST PRICE EACH	LIST PRICE PER 10
426987	426986	OCM	Outside Corner Molding	1.0	\$19.00	\$190.00

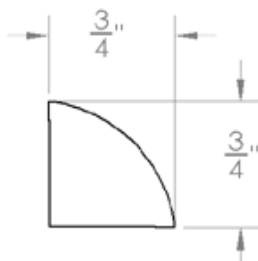

GRAY #	WHITE #	USER CODE	DESCRIPTION	FT ³	LIST PRICE EACH	LIST PRICE PER 10
426989	426988	QRM	Quarter Round Molding	1.0	\$16.00	\$160.00

MOLDINGS



GRAY #	WHITE #	USER CODE	DESCRIPTION	FT ³	LIST PRICE EACH	LIST PRICE PER 5
426998	426997	SCROWN	Shaker Crown Molding	1.0	\$74.00	\$370.00

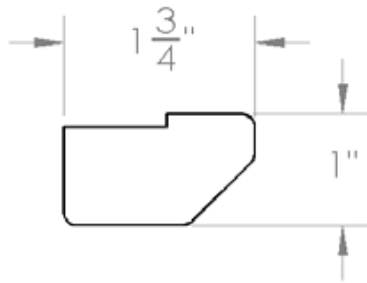

GRAY #	WHITE #	USER CODE	DESCRIPTION	FT ³	LIST PRICE EACH	LIST PRICE PER 5
427000	426999	SLRAIL	Shaker Light Rail Molding	1.0	\$35.00	\$175.00

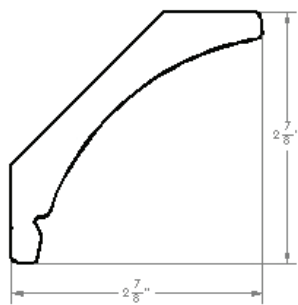

• Shaker Curved Crown Molding requires a starter strip

GRAY #	WHITE #	USER CODE	DESCRIPTION	FT ³	LIST PRICE EACH	LIST PRICE PER 5
427279	427278	SCCROWN	Shaker Curved Crown Molding	1.0	\$99.00	\$495.00

ACCESSORIES

GRAY #	WHITE #	USER CODE	DESCRIPTION	FT ³	LIST PRICE
--------	---------	-----------	-------------	-----------------	------------



427002	427001	TK96	Toekick 4" X 96"	1.0	\$20.00
--------	--------	------	------------------	-----	---------

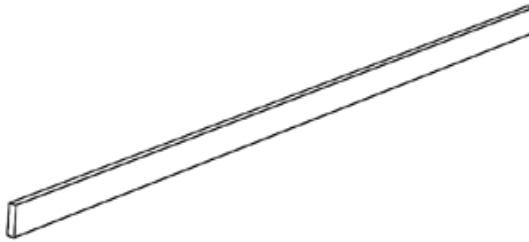

- Finished on two sides
- All edges are unfinished

427004	427003	UF396	Universal Filler 3" X 96"	1.0	\$38.00
427006	427005	UF696	Universal Filler 6" X 96"	1.0	\$55.00

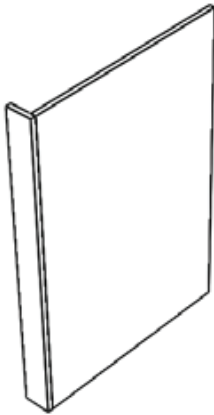

GRAY #	WHITE #	USER CODE	DESCRIPTION	FT ³	LIST PRICE EACH	LIST PRICE PER 2
427142	427141	DWEP3.0	Dishwasher End Panel 3.0"	1.0	\$130.00	\$260.00

ACCESSORIES

GRAY #	WHITE #	USER CODE	DESCRIPTION	FT ³	LIST PRICE
--------	---------	-----------	-------------	-----------------	------------



• All edges are unfinished



427144	427143	P4896-0.375	3/8" Panel 48" X 96"	1.0	\$212.00
428793	428759	P4896-0.75	3/4" Panel 48" X 96"	1.0	\$208.00



• Thermoplastic edge banding on all four edges

429144	429104	REP2484	Refrigerator End Panel 3/4" X 24" X 84"	1.0	\$197.00
429143	429103	REP2493	Refrigerator End Panel 3/4" X 24" X 93"	1.0	\$200.00
427148	427147	REP3084	Refrigerator End Panel 3/4" X 30" X 84"	1.0	\$237.00
427146	427145	REP3093	Refrigerator End Panel 3/4" X 30" X 93"	1.0	\$240.00

ACCESSORIES

GRAY #	WHITE #	USER CODE	DESCRIPTION	FT ³	LIST PRICE
 <ul style="list-style-type: none"> • Fits the BER36 cabinet which comes standard with predrilled holes to easily accept this accessory • Tray material = white plastic 					
n/a	427318	LZSTK	Lazy Susan Tray Kit (One Tray)	2.5	\$100.00
 <ul style="list-style-type: none"> • Fits the BB42 or BB45 cabinet • Tray material = white plastic • Comes with template and instructions to easily install this accessory. 					
n/a	427319	HMLZ42	Halfmoon Lazy Susan for BB42	2.0	\$668.00
n/a	427379	HMLZ45	Halfmoon Lazy Susan for BB45	2.0	\$700.00
 <ul style="list-style-type: none"> • Trash Pullout Kit is soft closed and fits the B18 or B18FH cabinets which comes standard with predrilled holes to easily accept this accessory • Does not mount to the door; the door remains hinged 					
n/a	427320	TPOK	Trash Pullout Kit	5.0	\$312.00
429493	429492	B18-TR	B18 Base Cabinet Drawer w/Trash Can Pullout	5.0	\$597.00
429496	429495	B18FH-TR	B18FH Base Cabinet Full Drawer w/Trash Can Pullout	5.0	\$561.00
429499	429498	B18UD-TR	B18UD Base Cabinet Upgraded Drw w/Trash Can Pullout	5.0	\$675.00

ACCESSORIES

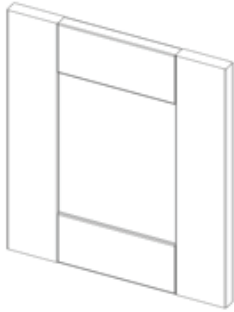
GRAY #	WHITE #	USER CODE	DESCRIPTION	FT ³	LIST PRICE
					
427384	427385	SSDOOR	Sample Shaker Door 10" X 11"		\$17.00

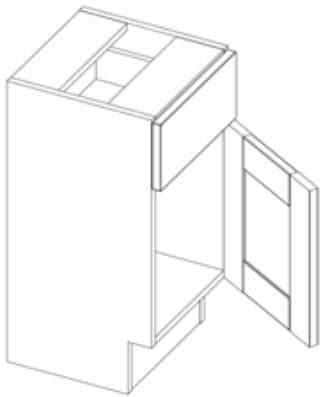
					
n/a	427381	MINIBASE	Minibase Cab BB Dwr 12" X 12" X 24"H	2.0	\$184.00
n/a	427383	MINIBASEUD	Minibase Sample Cab SC Dwr 12" X 12" X 24"H	2.4	\$224.00

ACCESSORIES

GRAY #	WHITE #	USER CODE	DESCRIPTION	FT ³	LIST PRICE
n/a	426990	ROD12	Rollout Drawer for 12" Wide Cabinet	1.0	Coming Soon
n/a	426991	ROD15	Rollout Drawer for 15" Wide Cabinet	1.0	Coming Soon
n/a	426992	ROD18	Rollout Drawer for 18" Wide Cabinet	1.0	Coming Soon
n/a	426993	ROD21	Rollout Drawer for 21" Wide Cabinet	1.0	Coming Soon
n/a	426994	ROD24	Rollout Drawer for 24" Wide Cabinet	1.0	Coming Soon
n/a	429105	ROD27	Rollout Drawer for 27" Wide Cabinet	1.0	Coming Soon
n/a	426995	ROD30	Rollout Drawer for 30" Wide Cabinet	1.0	Coming Soon
n/a	429106	ROD33	Rollout Drawer for 33" Wide Cabinet	1.0	Coming Soon
n/a	426996	ROD36	Rollout Drawer for 36" Wide Cabinet	1.0	Coming Soon

GRAY #	WHITE #	USER CODE	DESCRIPTION	FT ³	LIST PRICE
n/a	427316	TUKGW	Touch Up Kit	0.25	\$40.00
427317	n/a	TUKMG	Touch Up Kit	0.25	\$40.00
n/a	427387	MSC	MSC Molding Sample Chain (Not Color Specific)	0.1	\$16.00
n/a	428843	CSK	Sample Kit (Not Color Specific)	0.1	\$60.00
n/a	427556	WMS	Wall Mounting Screw (Box of 50)		\$18.50
n/a	429438	CBPS	Cabinet Binding Post and Screw (Box of 25)		\$114.00

MODIFICATIONS

USER CODE	DESCRIPTION	LIST PRICE
BDMOD12	Decrease Base Cabinet Depth to 12"	1.5 X List
BDMOD18	Decrease Base Cabinet Depth to 18"	1.5 X List
VDMOD18	Decrease Vanity Cabinet Depth to 18" (Only on Vanity Sink Base Cabinets - Single & Double Door)	1.5 X List
WDMOD15	Increase Wall Cabinet Depth to 15"	1.5 X List
WDMOD18	Increase Wall Cabinet Depth to 18"	1.75 X List
WDMOD21	Increase Wall Cabinet Depth to 21"	1.75 X List
WDMOD24	Increase Wall Cabinet Depth to 24"	2 X List
HMOD	Height Modification	2 X List
WMOD	Width Modification (Only available decreasing by 3" increments)	2 X List



WARRANTY

LIMITED 1-YEAR WARRANTY

-

Sauder Cabinetry warrants its products to the original purchaser to be free from all defects in material and workmanship under normal use for a period of one year from the original purchase date. Items included in this warranty are cabinet boxes, doors, drawers, shelves, and any accessories that are manufactured by Sauder Cabinetry. Any accessories and other products sold with or as part of any of the above-mentioned products that were not manufactured by Sauder Cabinetry are excluded from coverage by this limited warranty.

WARRANTY LIMITATIONS & EXCLUSIONS

-

This warranty does not cover any misuse, abuse, neglect, improper storage, exposure to moisture or extreme temperatures, improper installation, improper maintenance, or acts of God. The warranty does not apply to items that have been modified from their original form. In addition, this warranty does not cover any wear or deterioration resulting from natural aging, including expansion, contraction, hairline cracks or minor separation of seams. This warranty shall not apply in situations where loading or performance expectations exceed the Kitchen Cabinet Manufacturers Association testing and certification standards. In addition, this warranty does not cover products used in conjunction with Sauder Cabinetry cabinets, such as appliances, counter tops, or plumbing fixtures. No installer, retailer, distributor, or agent has the authority to alter the obligations or limitations in this warranty.

Sauder Cabinetry will not provide or pay for the cost of removal of defective product, transportation and shipping of defective, repaired or replaced product or installation of repaired or replaced product, regardless of whether the work is performed by a contractor, service company, or consumer. If the defective item is discontinued or not available, Sauder Cabinetry reserves the right to replace the item with the most similar item available at that time. Sauder Cabinetry may require, at its discretion, that the customer submit a clear photo, or that the installer, contractor, or service company view the item being claimed before honoring the warranty. Sauder Cabinetry must be notified in writing, within 90 days after discovering any defect in order to receive limited warranty coverage.

WARRANTY PERFORMANCE

-



saudercabinetry@sauder.com
419-446-3429



ANSI/KCMA A181.1



KITCHEN CABINETS MANUFACTURERS ASSOCIATION
INTERNATIONAL CONSUMER PRODUCT PROGRAM
ALL PRODUCTS MEET THE REQUIREMENTS
FOR GREEN PROGRAM CRITERIA. HELP US SAVE!

Sauder Cabinetry

502 Middle Street
Archbold, OH 43502

PHONE

419-446-3429

EMAIL

saudercabinetry@sauder.com