



Engineering-Scale Validation of Novel Algae CO₂ Capture and Bioproducts Technology

DE-FE0032103



PI - Fred Harrington, PhD
Helios-NRG, LLC

August 15, 2022



U.S. Department of Energy
National Energy Technology Laboratory
Carbon Management Project Review Meeting
August 15 - 19, 2022

Project Overview

Project Partners:

- **University of Buffalo-Lin/University of Buffalo-Bradley**
- **US Fish & Wildlife Service/USDA**
- **The Conservation Fund - Freshwater Institute**
- **Craft Nutrition Consulting**
- **Tresca Design**
- **National Carbon Capture Center**

DOE Federal Project Manager: Naomi O'Neil

Project Funding:

Total: \$2,499,030 Government: \$1,999,228 Cost Share: \$499,802

Project Period: 10/1/21 – 9/30/24

Overall Project Objectives

BP-1	BP-2
1. Develop technologies to increase algae productivity and reduce culturing costs	4. Implement & test integrated technologies to increase algae productivity and reduce cost in MSC system
2. Develop algae, refine processing and verify content for nutraceuticals	5. Identify marketable nutraceutical products and path to commercialize
3. Develop algae, incorporate into feed blends and conduct prelim tests	6. Validate algae feed blends and MSC capture technology in field tests
	7. Complete TEA and LCA

Commercial Schematic of Technology

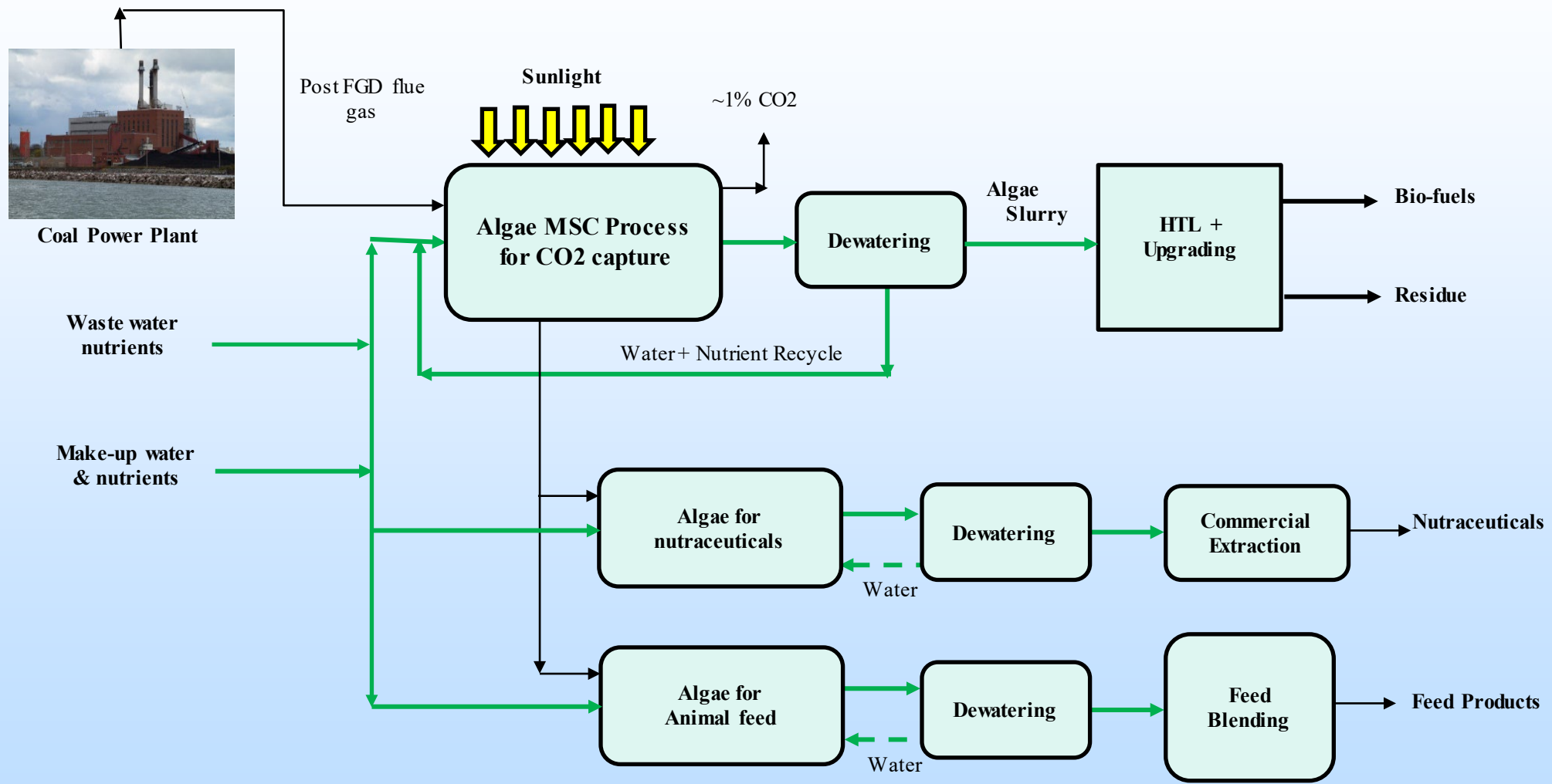

Project Strategy

- *For CO₂ capture to be economically viable, a revenue stream is required to offset cost of capture*
- **Develop scalable, multi-stage, algae technology for efficient CO₂ capture from fossil fuel power plants**
 - **Efficient upstream & downstream process integration**
 - **Controllable and predictable system with high capture efficiency & productivity**
- **Reduce capture cost via operational efficiency, credits and product revenue**
 - **Range of products**
 - **Low cost, efficient, high productivity operation**
 - **Negative cost wastewater nutrient inputs**

Technology Background - MSC

- Stable Multi-stage process
- Top lit closed system
- High productivity & capture efficiency
- Predictable, controllable operation
- Can be tailored to application
 - e.g. Natural gas power plants

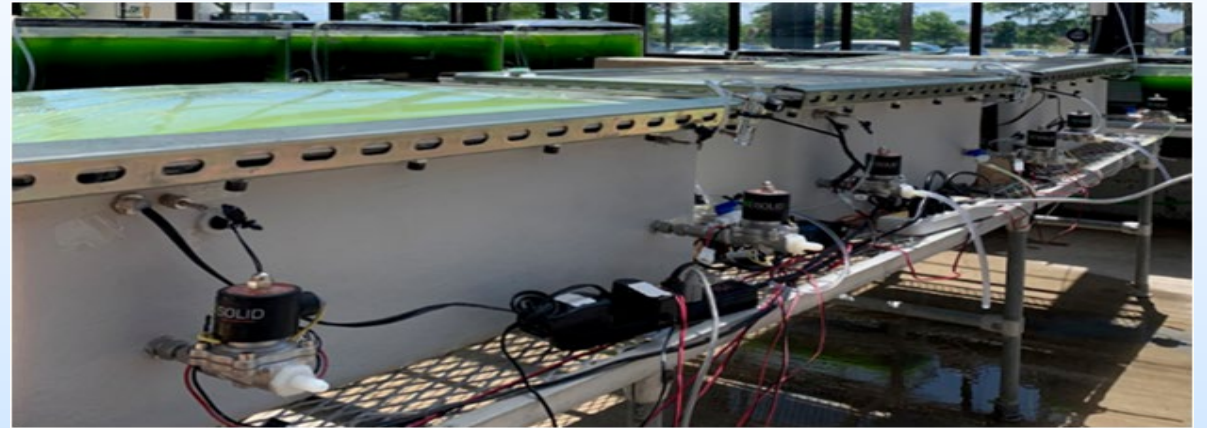

Integrated MSC test unit in greenhouse

MSC Evolution

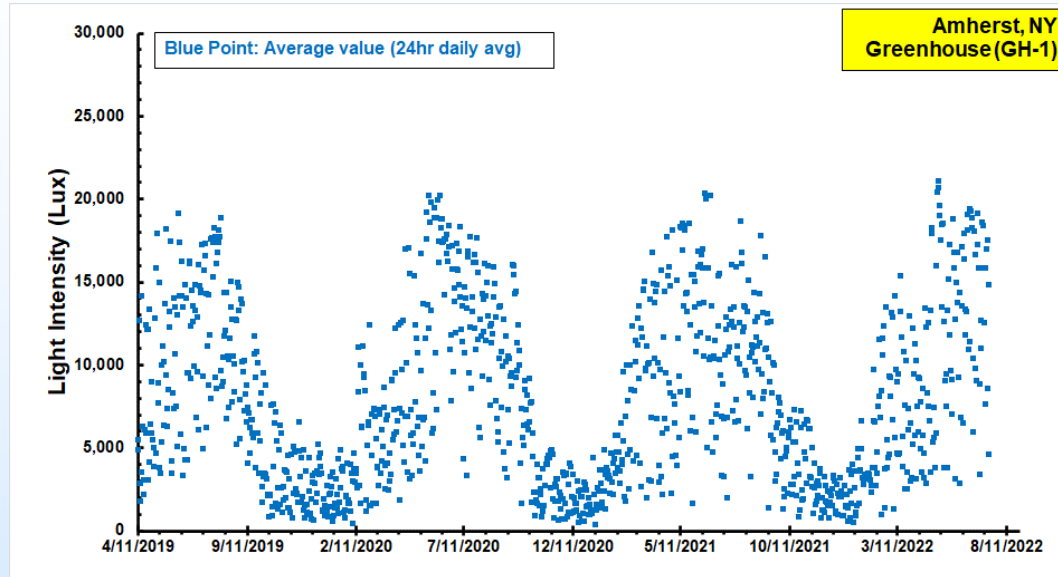

Evolution in MSC Development

MSC Type	Location	Sim. Flue Gas Contaminant	Nutr-WW Replacement	Normalized Algae Prod	Avg CO2 Capture
E	Lab	N/A	N/A	56%	54%
R	Lab	N/A	N/A	80%	80%
H	GH-1 Indoor	SOX/NOX + 5HM	N/A	85%	73%
H	GH-1 Indoor	SOX/NOX + 5HM	50%	92%	59%
C	GH-1 Indoor	SOX/NOX + 5HM	N/A	123%	74%
C	Outdoor	N/A	N/A	139%	81%
C	Outdoor	SOX/NOX + 5HM	80%	141%	76%
G	Outdoor	N/A	N/A	142%	77%
FE-0031710 Target		NCCC SSTU Flue Gas	N/A	100%	80%

- Six years of development
 - Concept validated in non-integrated lab tests - fixed light
 - Integrated system development in green house - sunlight
 - Integrated operation validated in outdoors tests - sunlight
- Algae must survive and grow in flue gas with contaminants
- MSC system design has evolved significantly leading to better performance

Advances in Project

- **3rd generation MSC design**
 - **New stage design incorporating advance**
 - **2nd generation dynamic control system**
 - **Improved gas-liquid mass transfer**
 - **Mitigate contamination**
 - **Waste water use**
- **Scaled outdoors operation & NC3 field test**
- **Expanded nutraceutical products; commercial strategies**
- **Advance feed production & validation**

Biocontamination Mitigation

- Identified changes in culture population dynamics over time via high through put DNA analysis and microscopy
- Developing potential mitigation strategies

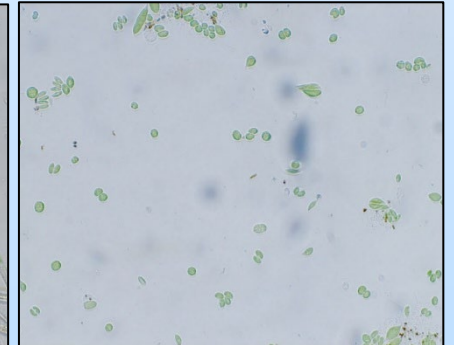
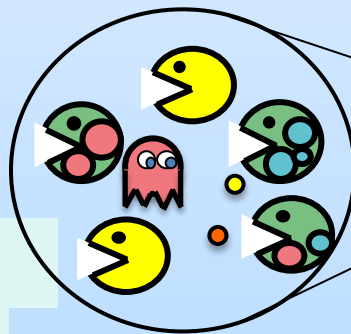
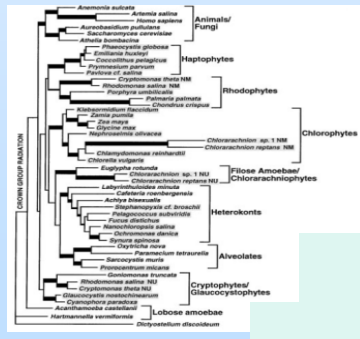
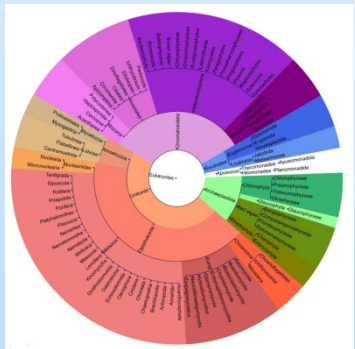

Gas/Liquid Mass Transfer

- Identified contactor with proper morphology
- Initial characterization underway
- New test stand for mass transfer measurement
- Identified potential coatings to improve function
- Incorporate biocontamination control to prevent fouling

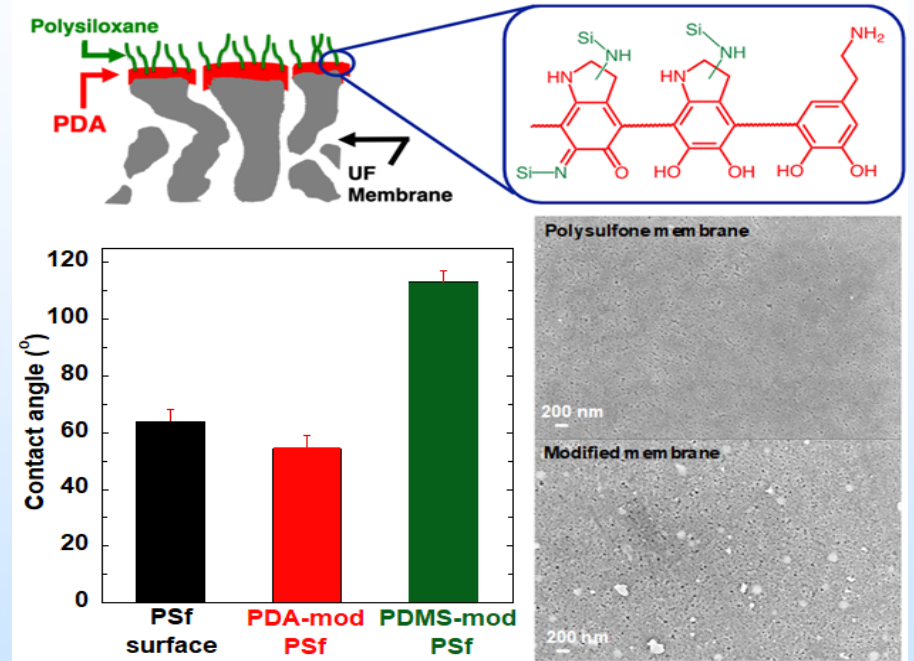

Feed Development and Testing

- Proximate, amino acids, fatty acid analyses of several algal candidates
- Advisement on method of preparation of algae as an ingredient
- Selected initial algae species for key commercial blend ingredient
- Helios running large scale cultures and harvesting algae for feed studies



Development of Nutraceuticals

- Developing improvements in culture scale, induction and extraction
- Multiple species of algae for nutraceutical products
- Improvements in sample preparation for product integrity
- Executed test matrix to measure quantities of a variety of products
- Studying ways to improve content, recovery and relevance to future marketing of algae ingredients

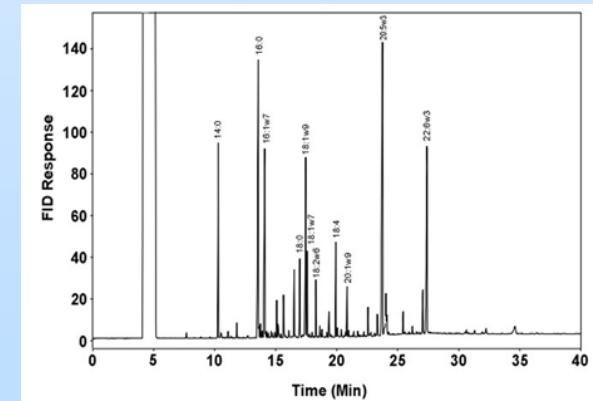

Future Work in Project

- Complete the design & fabricate 3rd Gen MSC system
- Validate operation in GH
- Outdoors operation
- MSC field test at NCCC
- Develop feed blends
- Validate feed blends in live studies
- Advance nutraceutical generation
 - Types of products, yield and blends for market needs
- LCA & TEA

Summary

- **Implementing major improvements to MSC**
- **Identified bio-contaminant population changes in cultures**
- **Operating larger cultures for algal supply for feed tests**
- **Improved dewatering/drying process of algae**
- **Testing advanced gas/liquid contactor**
- **Completed initial screen of multiple algal species for nutraceuticals**

Future Development and Commercialization

- Develop in-ground MSC system
- Design/validate building block for commercial MSC
- Integrate MSC with dewatering and municipal wastewater supply
- Optimize various products & confirm performance attributes
- Add commercial partners
- Validate capture in demonstration project
- Validate feed products in live studies & confirm price point
- Validate biofuel production; refinery use; performance; price point
- Develop & qualify slate of nutraceutical products; test market; verify price point



Acknowledgement



Acknowledgement

This material is based upon work supported by the Department of Energy under Award Number DE-FE0032103

Disclaimer

This report was prepared as an account of work sponsored by an agency of the United States Government. Neither the United States Government nor any agency thereof, nor any of their employees, makes any warranty, express or implied, or assumes any legal liability or responsibility for the accuracy, completeness, or usefulness of any information, apparatus, product, or process disclosed, or represents that its use would not infringe privately owned rights. Reference herein to any specific commercial product, process, or service by trade name, trademark, manufacturer, or otherwise does not necessarily constitute or imply its endorsement, recommendation, or favoring by the United States Government or any agency thereof. The views and opinions of authors expressed herein do not necessarily state or reflect those of the United States Government or any agency thereof.



FRESHWATER
INSTITUTE



THE
CONSERVATION FUND

