

PRODUCT

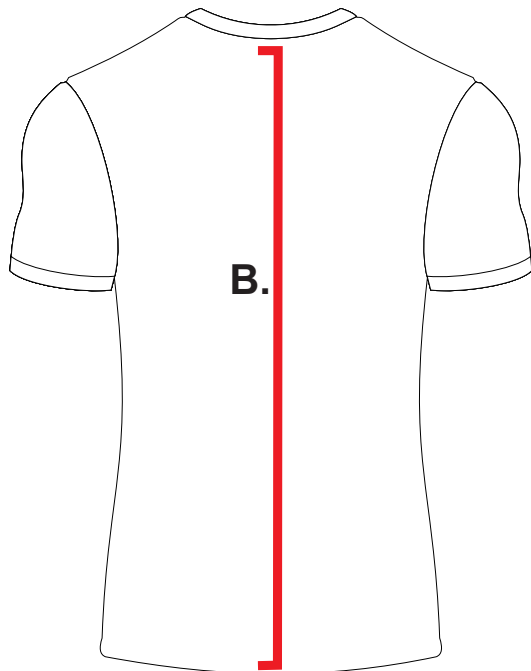
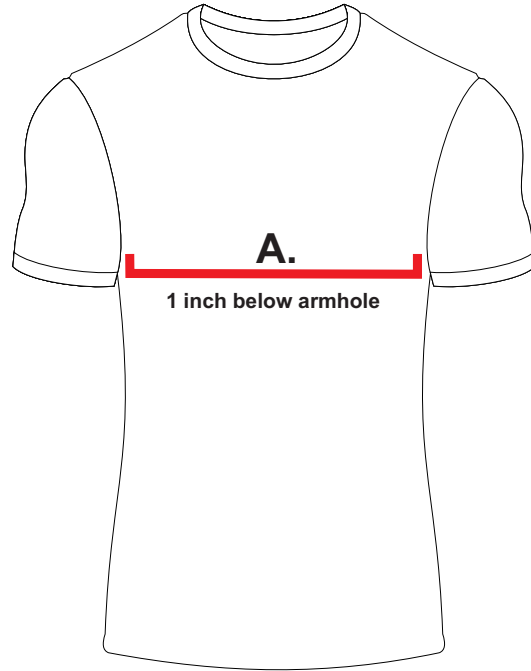

SHORT SLEEVE T-SHIRTS

MEN'S

	A.Chest (in)	B.Length (in)
MXS	20.25	27.5
MS	21	28.5
MM	21.75	30
ML	22.5	30.5
MXL	23.5	31.5
M2XL	24.25	32.5
M3XL	25	33.75
M4XL	26	35

WOMEN'S

	A.Chest (in)	B.Length (in)
WXS	17	22
WS	18	22.75
WM	19	23.5
WL	20	24.25
WXL	21	25
W2XL	22	25.75

YOUTH

	A.Chest (in)	B.Length (in)
YXS	17.25	20.75
YS	18	22.5
YM	18.75	23.5
YL	19.5	25.5
YXL	20.25	27

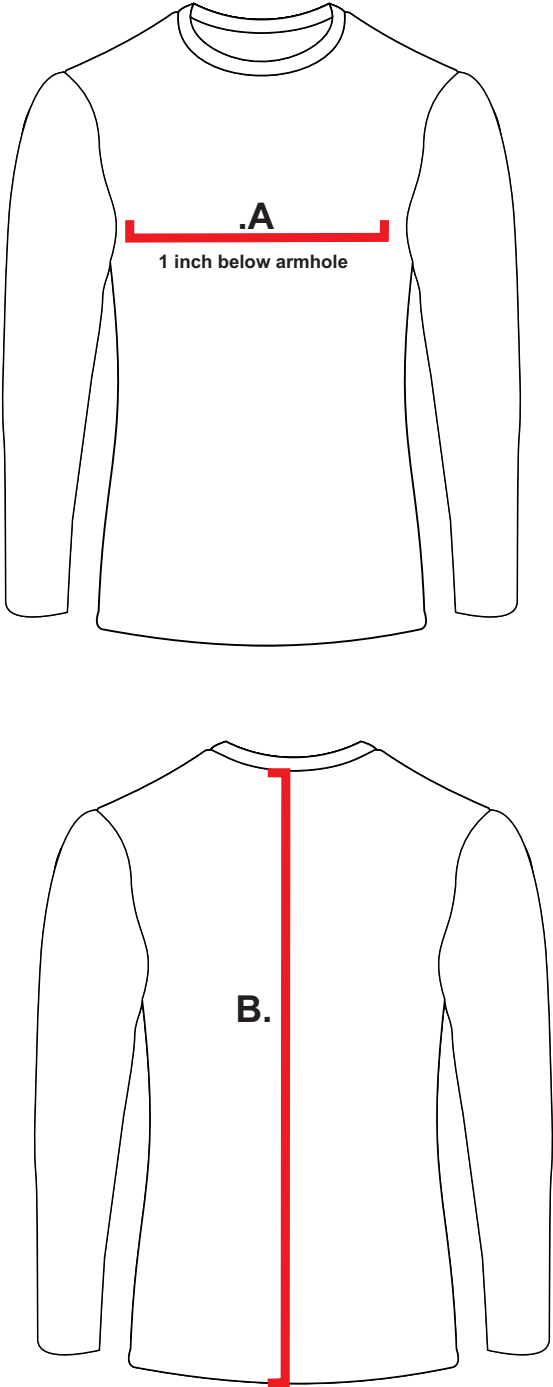
PRODUCT	LONG SLEEVE T-SHIRTS		
 <p>The diagram shows two views of a long-sleeved t-shirt. The top view shows the chest measurement 'A' with a red horizontal line across the chest, labeled '1 inch below armhole'. The bottom view shows the length measurement 'B' with a red vertical line from the top of the shoulder to the bottom hem.</p>	MEN'S		
		A.Chest (in)	B.Length (in)
	MXS	20.25	27.5
	MS	21	28.5
	MM	21.75	30
	ML	22.5	30.5
	MXL	23.5	31.5
	M2XL	24.25	32.5
	M3XL	25	33.75
	M4XL	26	35
	WOMEN'S		
		A.Chest (in)	B.Length (in)
	WXS	17	22
	WS	18	22.75
	WM	19	23.5
	WL	20	24.25
	WXL	21	25
	W2XL	22	25.75
	YOUTH		
		A.Chest (in)	B.Length (in)
YXS	17.25	20.75	
YS	18	22.5	
YM	18.75	23.5	
YL	19.5	25.5	
YXL	20.25	27	

PRODUCT

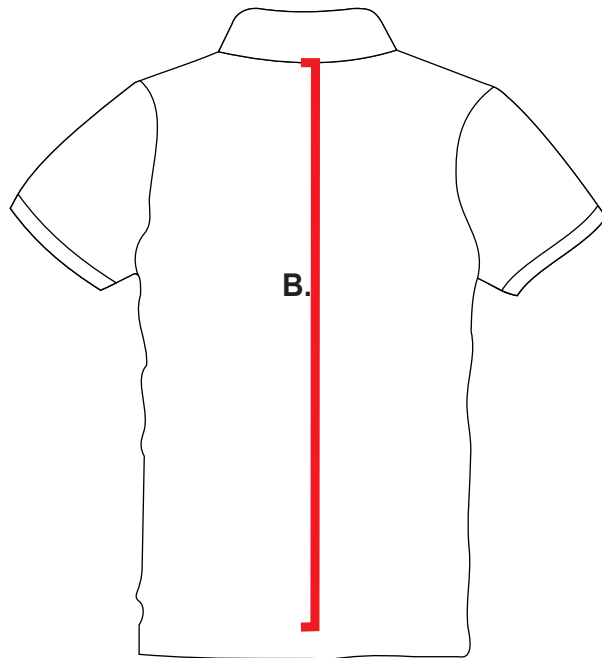
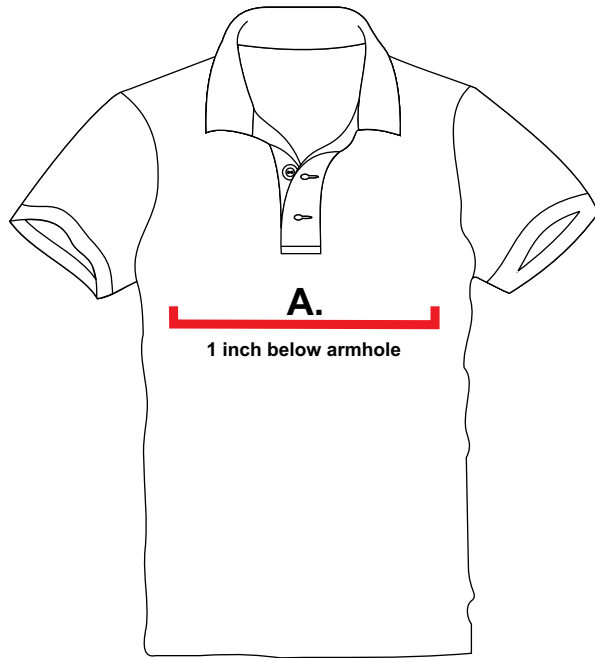

POLO SHIRTS

MEN'S

	A.Chest (in)	B.Length (in)
MXS	20.25	27.5
MS	21	28.5
MM	21.75	30
ML	22.5	30.5
MXL	23.5	31.5
M2XL	24.25	32.5
M3XL	25	33.75
M4XL	26	35

WOMEN'S

	A.Chest (in)	B.Length (in)
WXS	17	22
WS	18	22.75
WM	19	23.5
WL	20	24.25
WXL	21	25
W2XL	22	25.75

YOUTH

	A.Chest (in)	B.Length (in)
YXS	17.25	20.75
YS	18	22.5
YM	18.75	23.5
YL	19.5	25.5
YXL	20.25	27

PRODUCT

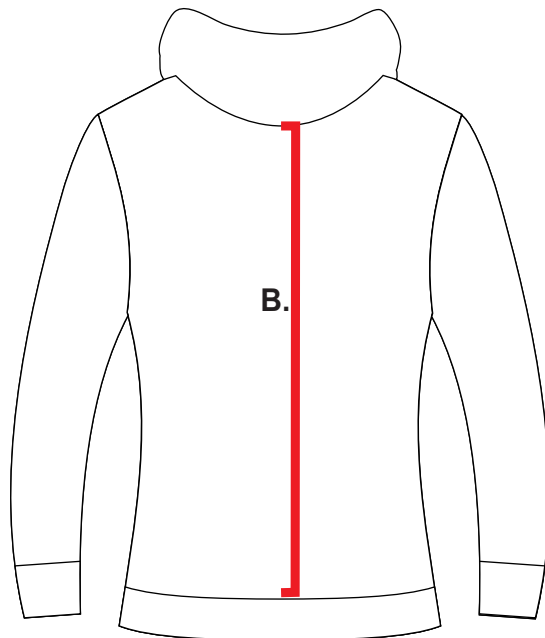
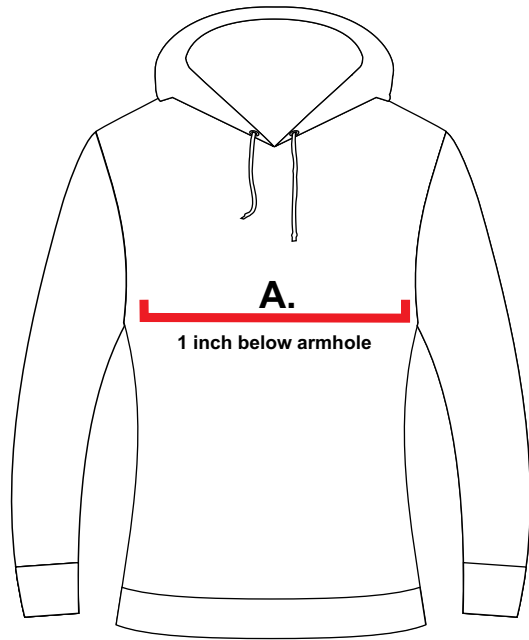

HOODIES

MEN'S

	A.Chest (in)	B.Length (in)
MXS	21	25.5
MS	22	26.5
MM	23	27.5
ML	24	28.5
MXL	25	29.5
M2XL	27.5	30.5
M3XL	29	31.5
M4XL	30.5	32.5

WOMEN'S

	A.Chest (in)	B.Length (in)
WXS	19.5	22
WS	20.5	23
WM	21.5	24
WL	22.5	25
WXL	23.5	26
W2XL	24.5	27

YOUTH

	A.Chest (in)	B.Length (in)
YXS	17	19
YS	18	20
YM	19	21
YL	20	22
YXL	21	23

PRODUCT

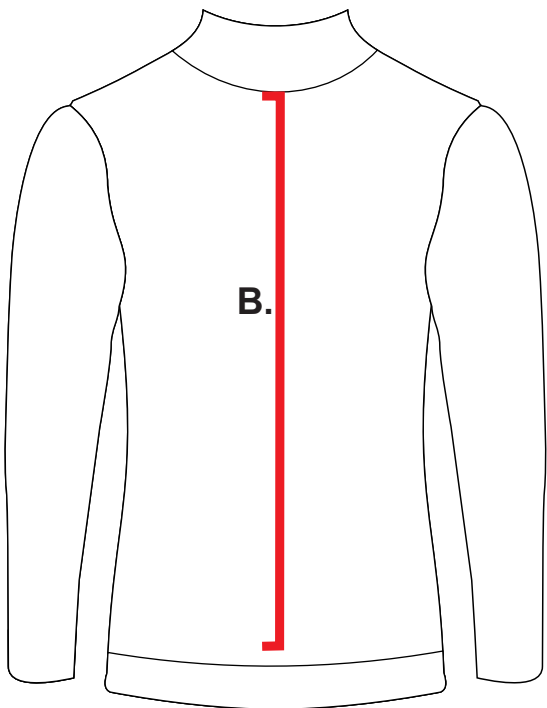
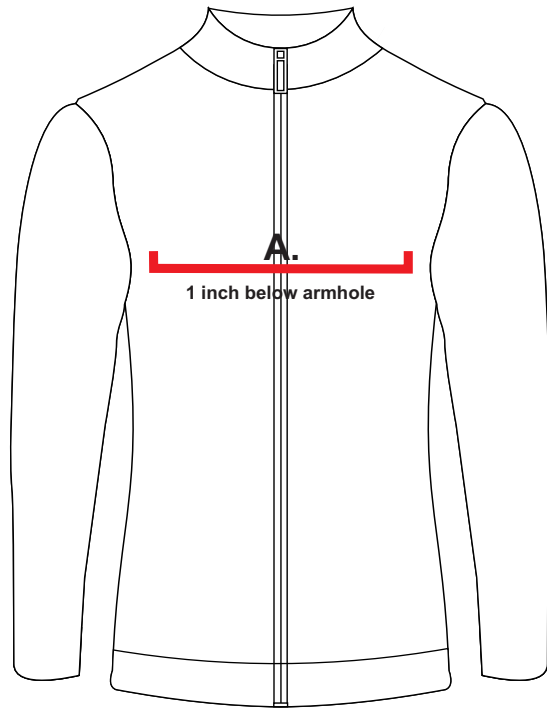

WARM-UP JACKETS

MEN'S

	A.Chest (in)	A.Length (in)
MXS	21	24.25
MS	22	25.25
MM	23	26.25
ML	24	27.25
MXL	25	28.25
M2XL	26	29.25
M3XL	27	30.25
M4XL	28	31.25

WOMEN'S

	A.Chest (in)	B.Length (in)
WXS	19.5	21
WS	20.5	22
WM	21.5	23
WL	22.5	24
WXL	23.5	25
W2XL	24.5	26

YOUTH

	A.Chest (in)	B.Length (in)
YXS	15.75	19.75
YS	16.75	20.75
YM	17.75	21.75
YL	18.75	22.75
YXL	19.75	23.75

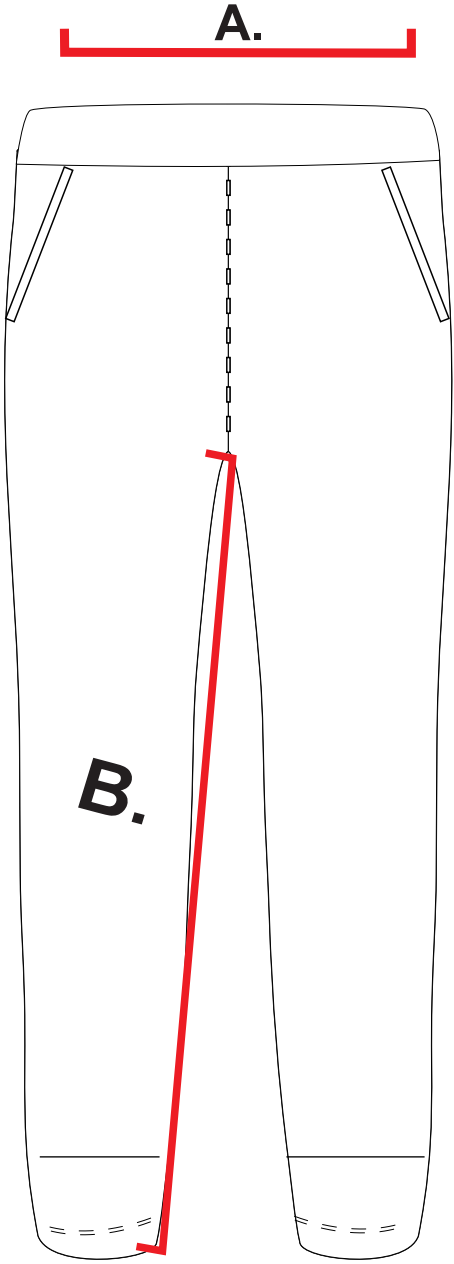
PRODUCT	WARM-UP PANTS		
 <p>The diagram shows a pair of warm-up pants with two measurement lines. Line A is a horizontal red line across the waistband. Line B is a vertical red line along the inner leg from the waistband to the hem.</p>	MEN'S		
		A. Waist (in)	A. Inseam (in)
	MXS	12	30
	MS	13	31
	MM	14	32
	ML	15	33
	MXL	16	34
	M2XL	17	35
	M3XL	18	36
	M4XL	19	37
	WOMEN'S		
		A. Waist (in)	B. Inseam (in)
	WXS	10.5	29
	WS	11.5	30
	WM	12.5	31
	WL	13.5	32
	WXL	14.5	33
	W2XL	15.5	34
	YOUTH		
		A. Waist (in)	B. Inseam (in)
	YXS	8.5	25.5
YS	9.5	26.5	
YM	10.5	27.5	
YL	11.5	28.5	
YXL	12.5	29.5	

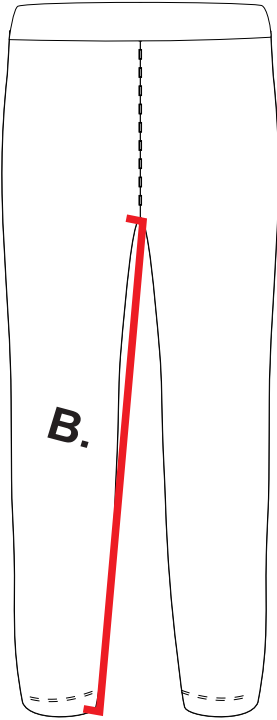
PRODUCT	PAJAMA PANTS		
<p style="text-align: center;">RELEXED A.</p>  <p style="text-align: center;">B.</p>	ADULT		
		A. Waist (in)	A. Inseam (in)
	XS	12	27.5
	S	13	28.5
	M	14	29.5
	L	15	30.5
	XL	16	31.5
	2XL	17	32.5
	YOUTH		
		A. Waist (in)	B. Inseam (in)
	YXS	8.5	23.5
	YS	9.5	24.5
	YM	10.5	25.5
YL	11.5	26.5	
YXL	12.5	27.5	

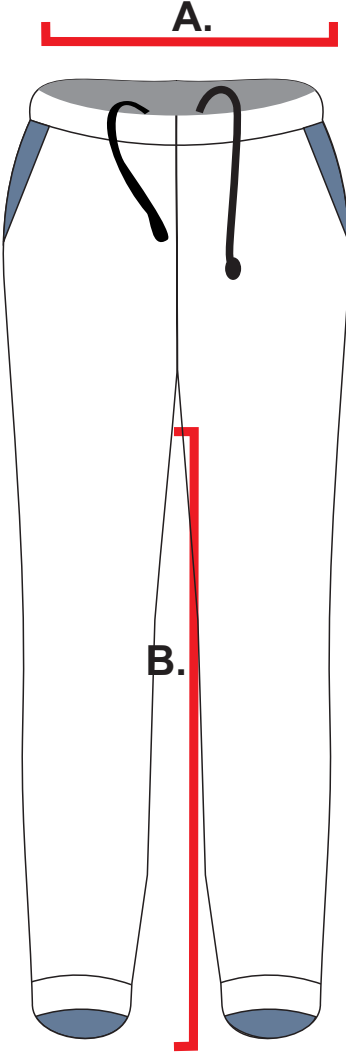
PRODUCT	JOGGERS		
	MEN'S		
		A. Waist (in)	B. Inseam (in)
	MXS	12	28
	MS	13	29
	MM	14	30
	ML	15	31
	MXL	16	32
	M2XL	17	33
	WOMEN'S		
		A. Waist (in)	B. Inseam (in)
	WXS	10.5	28
	WS	11.5	28.5
	WM	12.5	29
	WL	13.5	29.5
	WXL	14.5	30
	W2XL	15.5	30.5
	YOUTH		
		A. Waist (in)	B. Inseam (in)
	YXS	8.5	24
	YS	9.5	25
YM	10.5	26	
YL	11.5	27	
YXL	12.5	28	

PRODUCT

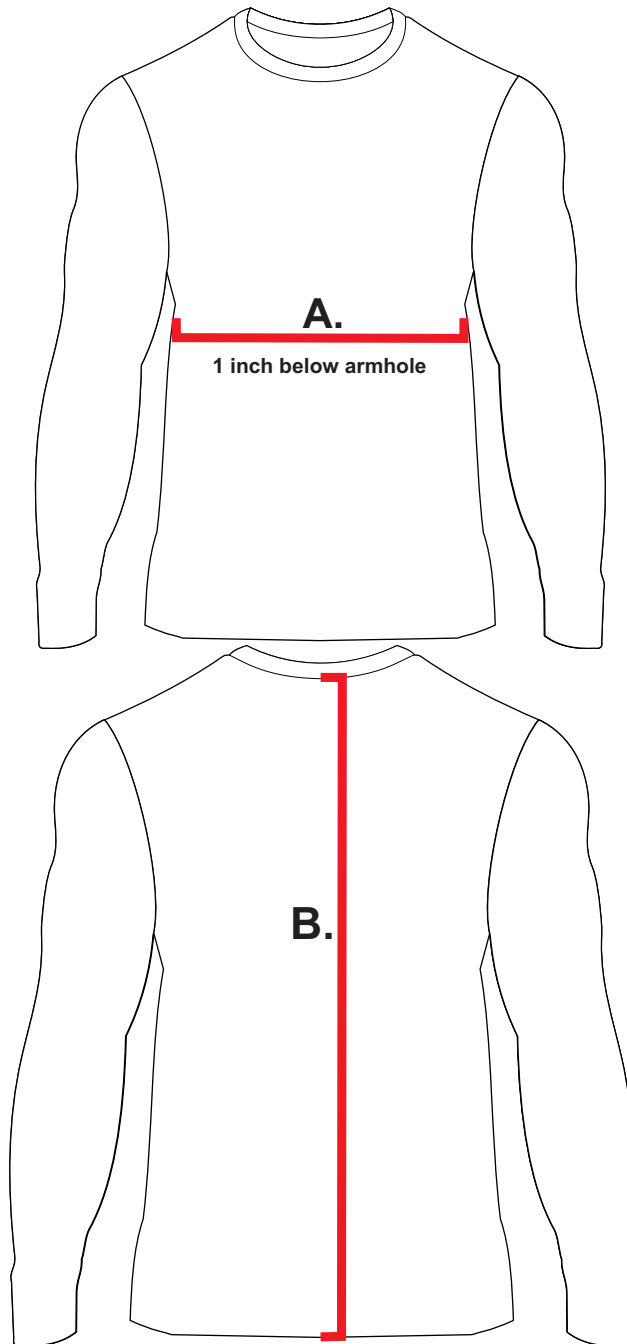

COMPRESSION SHIRTS

MEN'S

	A.Chest (in)	B.Length (in)
MXS	15.5	22
MS	16.25	22.75
MM	17	23.5
ML	17.75	24.25
MXL	18.5	25
M2XL	19.25	25.75
M3XL	20	26.5
M4XL	20.75	27.25

WOMEN'S

	A.Chest (in)	B.Length (in)
WXS	13.75	20
WS	14.5	20.75
WM	15.25	21.5
WL	16	22.25
WXL	16.75	23
W2XL	17.5	23.75

YOUTH

	A.Chest (in)	B.Length (in)
YXS	12.25	19
YS	13	19.75
YM	14.75	20.5
YL	14.5	21.25
YXL	15.25	22

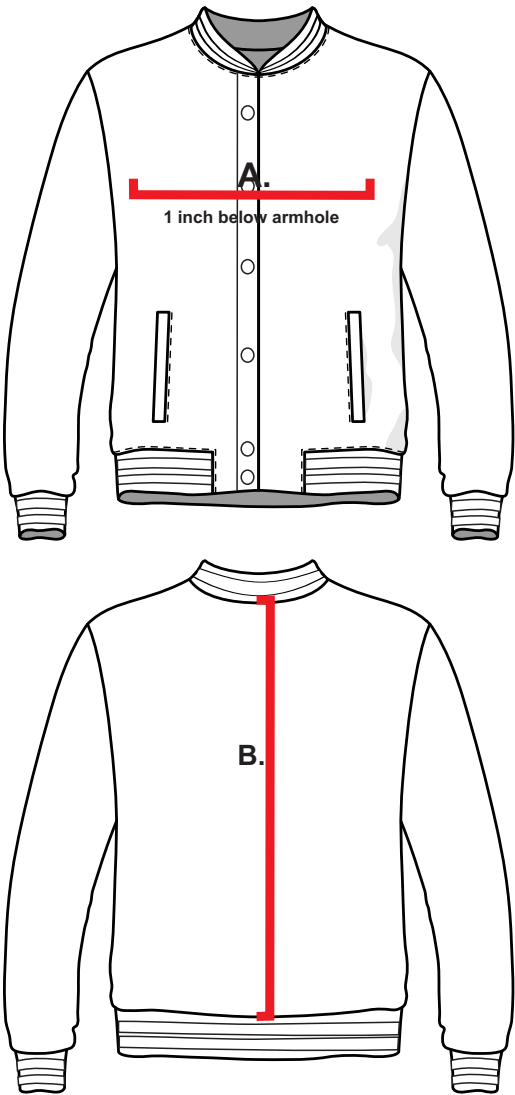
PRODUCT	VARSITY JACKETS		
 <p>The diagram shows two views of a varsity jacket. The top view is a front view with a red horizontal line labeled 'A.' across the chest, with the text '1 inch below armhole' below it. The bottom view is a back view with a red vertical line labeled 'B.' running down the center of the jacket.</p>	MEN'S		
		A.Chest (in)	B.Length (in)
	MS	24	27
	MM	25	27.5
	ML	26	28
	MXL	27	28.5
	WOMEN'S		
		A.Chest (in)	B.Length (in)
	WS	19	24.5
	WM	20	25
	WL	21	25.5
	WXL	22	26
	YOUTH		
	A .Chest (in)	B.Length (in)	
YS	17	21	
YM	18	21	
YL	19	22	
YXL	20	22.5	

PRODUCT

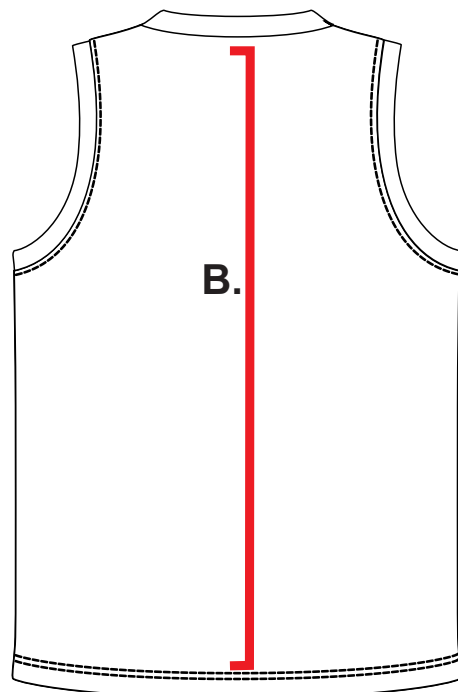
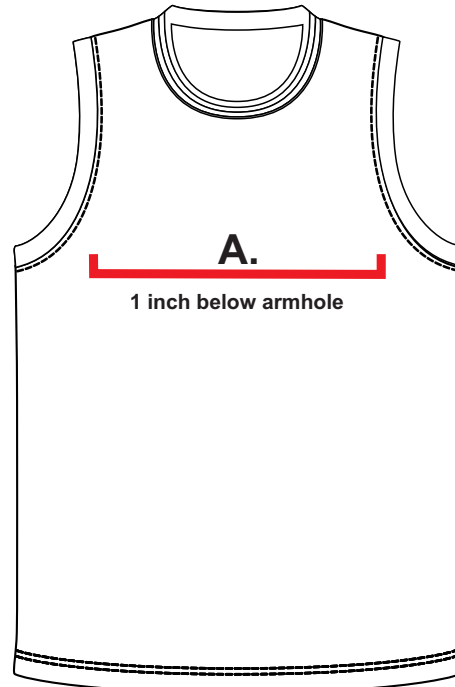

BASKETBALL JERSEYS

MEN'S

	A.Chest (in)	B.Length (in)
MXS	20	27
MS	21	28
MM	22	29
ML	23	30
MXL	24	31
M2XL	25	32
M3XL	26	33
M4XL	27	34

WOMEN'S

	A.Chest (in)	B.Length (in)
WXS	18.5	25
WS	19.5	26
WM	20.5	27
WL	21.5	28
WXL	22.5	29
W2XL	23.5	30

YOUTH

	A.Chest (in)	B.Length (in)
YXS	16	20
YS	17	22
YM	18	24
YL	19	26
YXL	20	28

PRODUCT

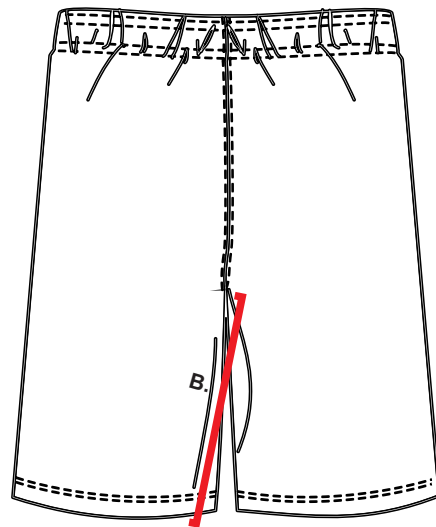

BASKETBALL SHORTS

MEN'S

	A. Waist (in)	B. Inseam (in)
MXS	12.5	10
MS	13.5	10.25
MM	14.5	10.5
ML	15.5	10.75
MXL	16.5	11
M2XL	16.5	11.25
M3XL	17.5	11.5
M4XL	18.5	11.75

WOMEN'S

	A. Waist (in)	B. Inseam (in)
WXS	11	7.75
WS	12	8
WM	13	8.25
WL	14	8.5
WXL	15	8.75
W2XL	16	9

YOUTH

	A. Waist (in)	B. Inseam (in)
YXS	8.5	6.5
YS	9.5	7
YM	10.5	7.5
YL	11.5	8
YXL	12.5	8.5

PRODUCT

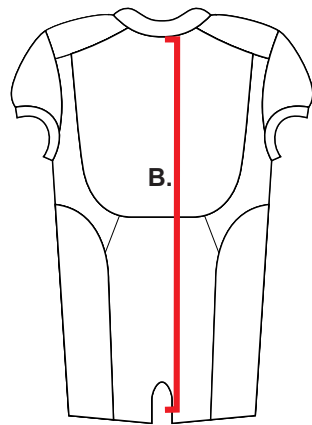
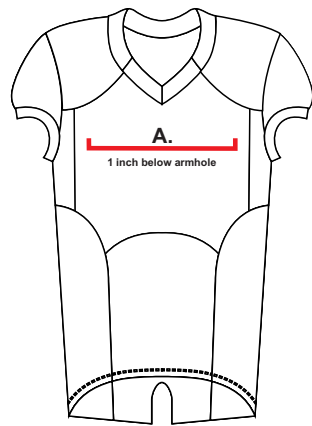

FOOTBALL JERSEYS

MEN'S

	A.Chest (in)	B.Length (in)
MXS	17	30
MS	18	31
MM	19	32
ML	20	33
MXL	21	34
M2XL	22	35
M3XL	23	36
M4XL	24	37

YOUTH

	A.Chest (in)	B.Length (in)
YXS	13.5	25
YS	14.5	26
YM	15.5	27
YL	16.5	28
YXL	17.5	29

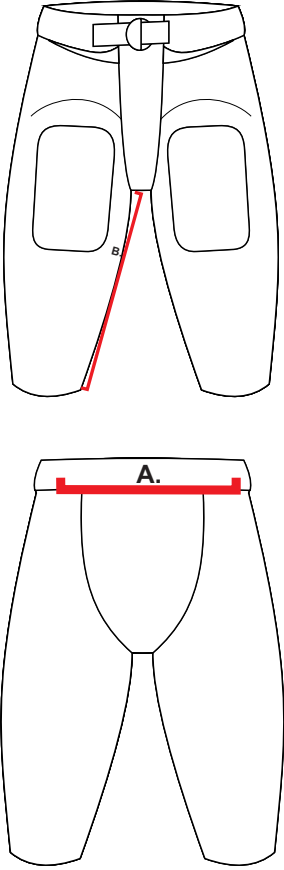
PRODUCT	FOOTBALL PANTS		
	MEN'S		
		A. Waist (in)	B. Inseam (in)
	MXS	13.5	13.5
	MS	14.5	14.5
	MM	15.5	15.5
	ML	16.5	16.5
	MXL	17.5	17.5
	M2XL	18.5	18.5
	M3XL	19.5	19.5
	M4XL	20.5	20.5
	YOUTH		
		A. Waist (in)	B. Inseam (in)
	YXS	10.5	11
	YS	11.5	12
YM	12.5	13	
YL	13.5	14	
YXL	14.5	15	

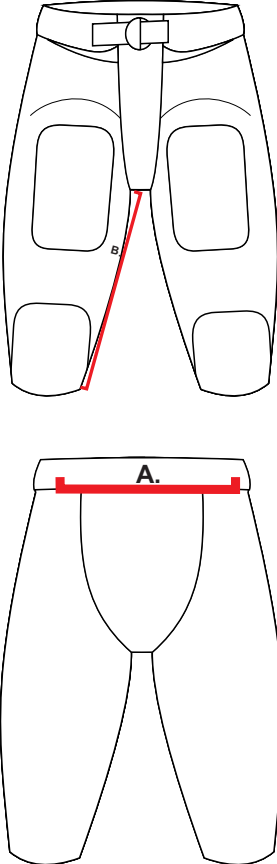
PRODUCT	INTEGRATED FOOTBALL PANTS		
	MEN'S		
		A. Waist (in)	B. Inseam (in)
	MXS	15	13
	MS	16	14
	MM	17	15
	ML	18	16
	MXL	19	17
	M2XL	20	18
	M3XL	21	19
	M4XL	22	20
	YOUTH		
		A. Waist (in)	B. Inseam (in)
	YXS	11.5	9
	YS	12.5	10
YM	13.5	11	
YL	14.5	12	
YXL	15.5	13	

PRODUCT

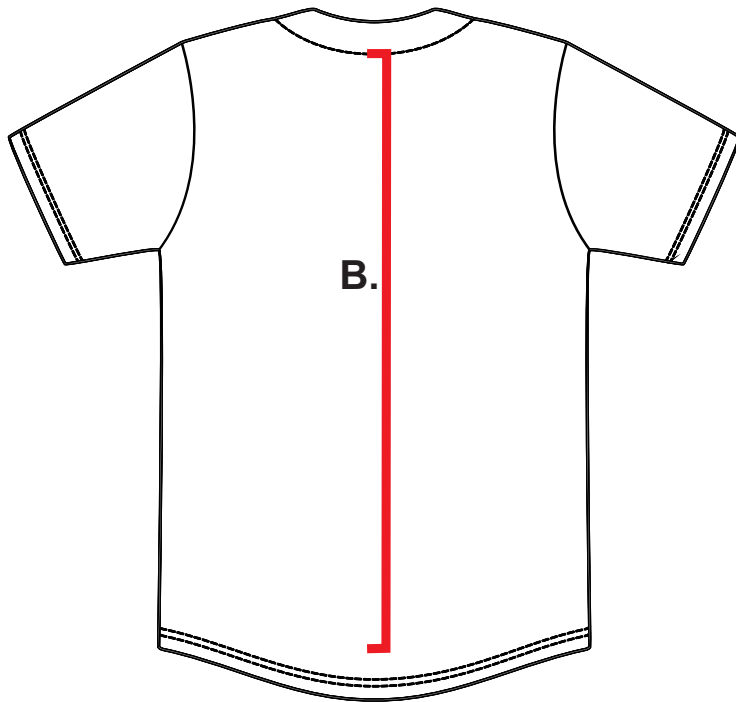
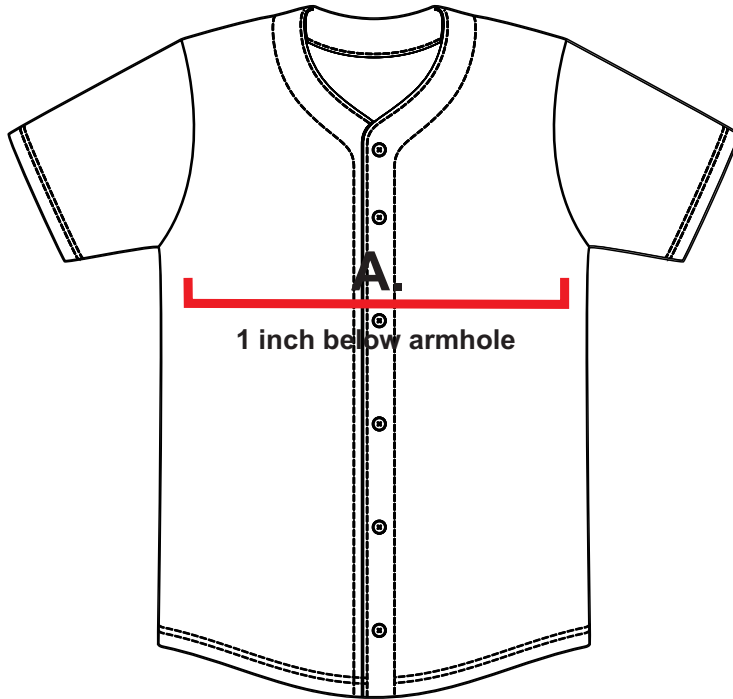

BASEBALL JERSEYS

MEN'S

	A.Chest (in)	B.Length (in)
MXS	21	28
MS	22	29
MM	23	30
ML	24	31
MXL	25	32
M2XL	26	33
M3XL	27	34
M4XL	28	35

WOMEN'S

	A.Chest (in)	B.Length (in)
WXS	18	25.5
WS	19	26.5
WM	20	27.5
WL	21	28.5
WXL	22	29.5
W2XL	23	30.5

YOUTH

	A.Chest (in)	B.Length (in)
YXS	16	23.5
YS	17	24.5
YM	18	25.5
YL	19	26.5
YXL	20	27.5

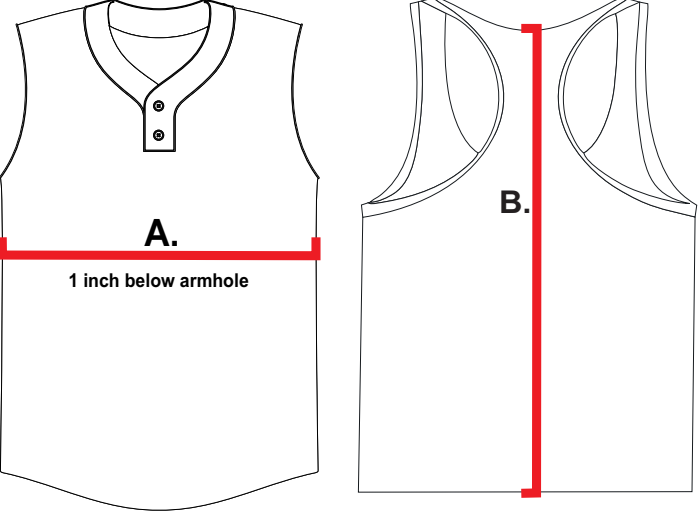
PRODUCT	RACERBACK BASEBALL JERSEYS		
	WOMEN'S		
		A.Chest (in)	B.Length (in)
	WXS	18	25.5
	WS	19	26.5
	WM	20	27.5
	WL	21	28.5
	WXL	22	29.5
	W2XL	23	30.5
	GIRLS		
		A.Chest (in)	B.Length (in)
	GXS	15	22.5
	GS	16	23.5
	GM	17	24.5
	GL	18	25.5
GXL	19	26.5	

PRODUCT

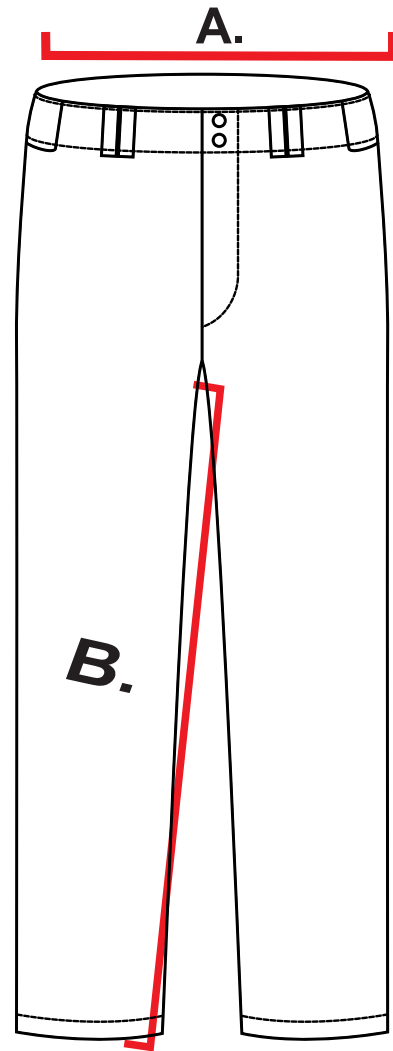

BASEBALL PANTS

MEN'S

	A. Waist (in)	B. Inseam (in)
MXS	14	31.5
MS	15	32.5
MM	16	33.5
ML	17	34.5
MXL	18	35.5
M2XL	19	36.5
M3XL	20	37.5
M4XL	21	38.5

WOMEN'S

	A. Waist (in)	B. Inseam (in)
WXS	13	28
WS	14	29
WM	15	30
WL	16	31
WXL	17	32
W2XL	18	33

YOUTH

	A. Waist (in)	B. Inseam (in)
YXS	10	25
YS	11	26
YM	12	27
YL	13	28
YXL	14	29

PRODUCT

BASEBALL KNICKERS

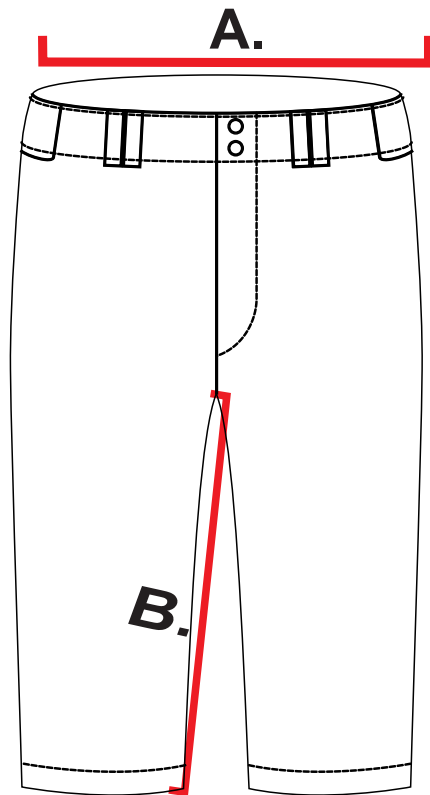

MEN'S

	A. Waist (in)	B. Inseam (in)
MXS	14	15
MS	15	15.75
MM	16	16.5
ML	17	17.25
MXL	18	18
M2XL	19	18.75
M3XL	20	19.5
M4XL	21	20.25

WOMEN'S

	A. Waist (in)	B. Inseam (in)
WXS	13	14
WS	14	14.5
WM	15	15
WL	16	15.5
WXL	17	16
W2XL	18	16.5

YOUTH

	A. Waist (in)	B. Inseam (in)
YXS	10	12
YS	11	12.5
YM	12	13
YL	13	13.5
YXL	14	14

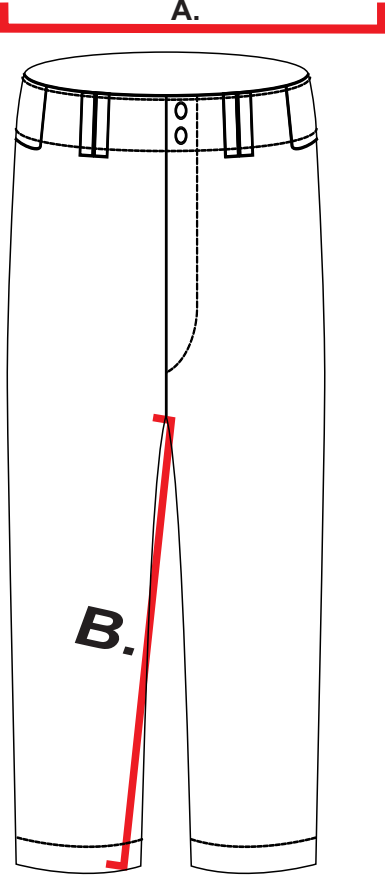
PRODUCT	3/4 LENGTH BASEBALL PANTS		
 <p>The diagram shows a pair of 3/4 length baseball pants. A red horizontal line labeled 'A.' spans the width of the waistband. A red vertical line labeled 'B.' runs down the center of the leg from the waistband to the hem, representing the inseam length.</p>	WOMEN'S		
		A. Waist (in)	B. Inseam (in)
	WXS	13	21
	WS	14	21.75
	WM	15	22.5
	WL	16	23.25
	WXL	17	24
	W2XL	18	24.75
	GIRLS		
		A. Waist (in)	B. Inseam (in)
GXS	10	18.5	
GS	11	19.25	
GM	12	20	
GL	13	20.75	
GXL	14	21.5	

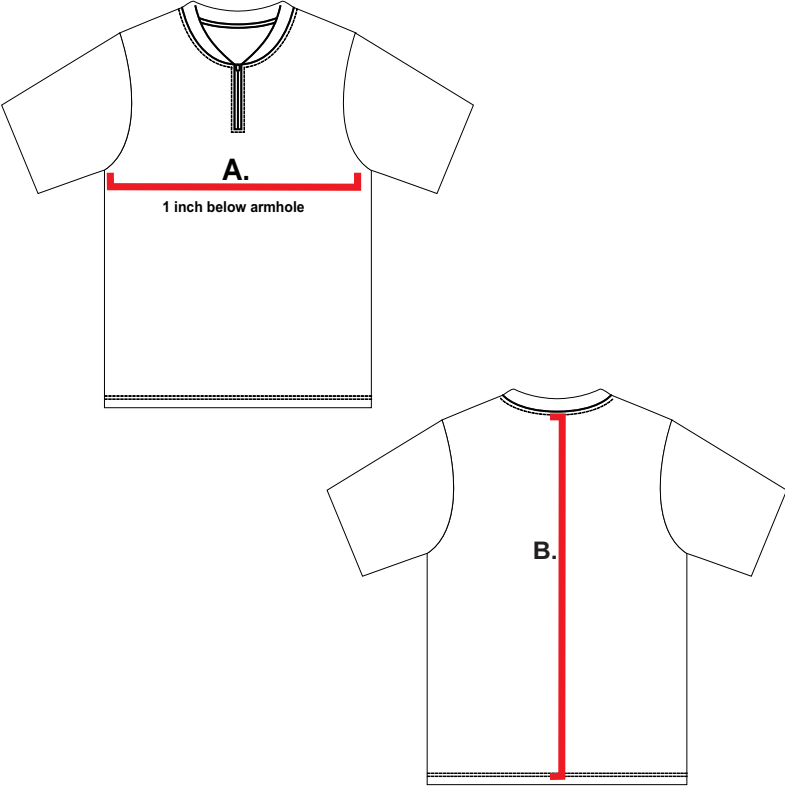
PRODUCT	CAGE JACKETS		
 <p>The diagram shows two views of a cage jacket. The top view shows the chest measurement 'A' taken 1 inch below the armhole. The bottom view shows the length measurement 'B' from the top of the collar to the bottom hem.</p>	ADULT		
		A.Chest (in)	B.Length (in)
	AXS	21	27
	AS	22	28
	AM	23	29
	AL	24	30
	AXL	25	31
	A2XL	26	32
	A3XL	27	33
	A4XL	28	34
	YOUTH		
		A.Chest (in)	B.Length (in)
	YXS	16	21
	YS	17	22
YM	18	23	
YL	19	24	
YXL	20	25	

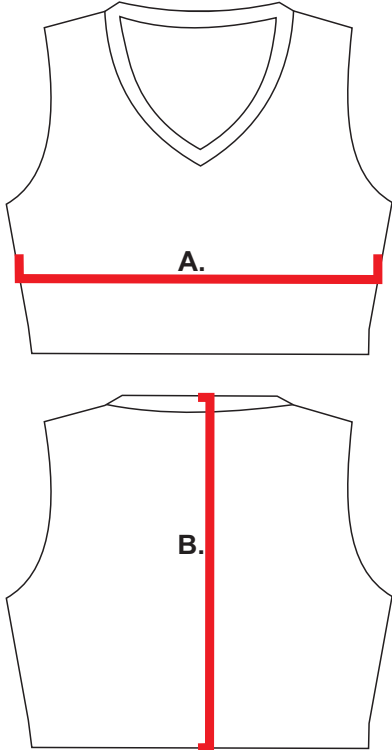
PRODUCT	CHEERLEADING CROP TOPS		
 <p>The diagram shows two views of a cheerleading crop top. The top view shows a V-neckline and a horizontal red line labeled 'A.' across the chest. The bottom view shows a vertical red line labeled 'B.' from the top edge to the bottom edge.</p>	WOMEN'S		
		A.Chest (in)	B.Length (in)
	WXS	15.5	12.5
	WS	16.5	13.5
	WM	17.5	14.5
	WL	18.5	15.5
	WXL	19.5	16.5
	W2XL	20.5	17.5
	GIRLS		
		A.Chest (in)	B.Length (in)
	GXS	11.5	9
	GS	12.5	10
	GM	13.5	11
	GL	14.5	12
GXL	15.5	13	

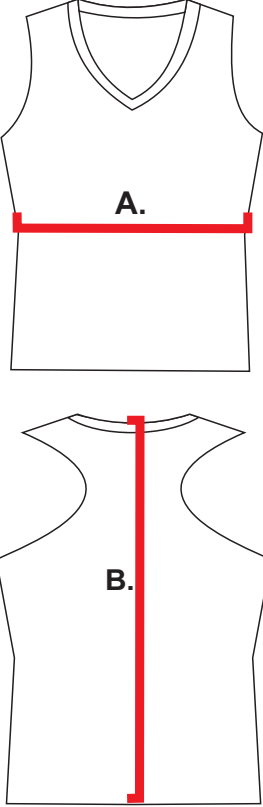
PRODUCT	RACERBACK CHEERLEADING SHELLS		
 <p>The diagram shows two views of a racerback cheerleading shell. The top view shows a V-neckline with a red horizontal line across the chest labeled 'A.'. The bottom view shows the back of the shell with a red vertical line from the neckline to the hem labeled 'B.'.</p>	WOMEN'S		
		A.Chest (in)	B.Length (in)
	WXS	13.5	19.5
	WS	14.5	20.5
	WM	15.5	21.5
	WL	16.5	22.5
	WXL	17.5	23.5
	W2XL	18.5	24.5
	GIRLS		
		A.Chest (in)	B.Length (in)
	GXS	9.5	15.5
	GS	10.5	16.5
	GM	11.5	17.5
	GL	12.5	18.5
GXL	13.5	19.5	

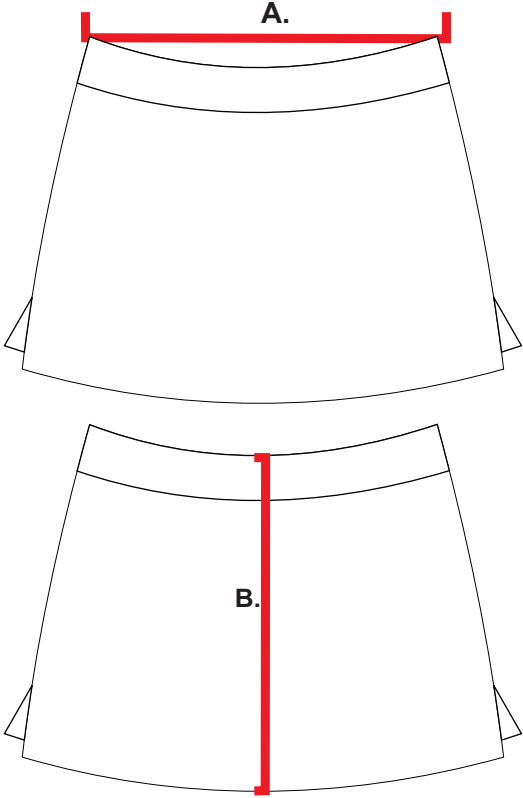
PRODUCT	CHEERLEADING SKIRTS/SKORTS		
 <p>The diagram shows two views of a cheerleading skirt. The top view shows the waistband with a red horizontal line labeled 'A.' indicating the waist measurement. The bottom view shows the side of the skirt with a red vertical line labeled 'B.' indicating the inseam measurement.</p>	WOMEN'S		
		A. Waist (in)	B. Inseam (in)
WXS	13	12	
WS	14	12.5	
WM	15	13	
WL	16	13.5	
WXL	17	14	
W2XL	18	14.5	
GIRLS			
	A. Waist (in)	B. Inseam (in)	
GXS	9.75	10	
GS	10.75	10.5	
GM	11.75	11	
GL	12.75	11.5	
GXL	13.75	12	

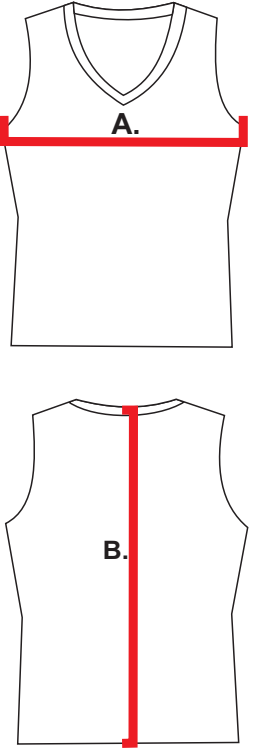
PRODUCT	CHEERLEADING SHELLS		
	WOMEN'S		
		A.Chest (in)	B.Length (in)
	WXS	15.5	19.5
	WS	16.5	20.5
	WM	17.5	21.5
	WL	18.5	22.5
	WXL	19.5	23.5
	W2XL	20.5	24.5
	GIRLS		
		A.Chest (in)	B.Length (in)
	GXS	11.5	15.5
	GS	12.5	16.5
	GM	13.5	17.5
	GL	14.5	18.5
GXL	15.5	19.5	

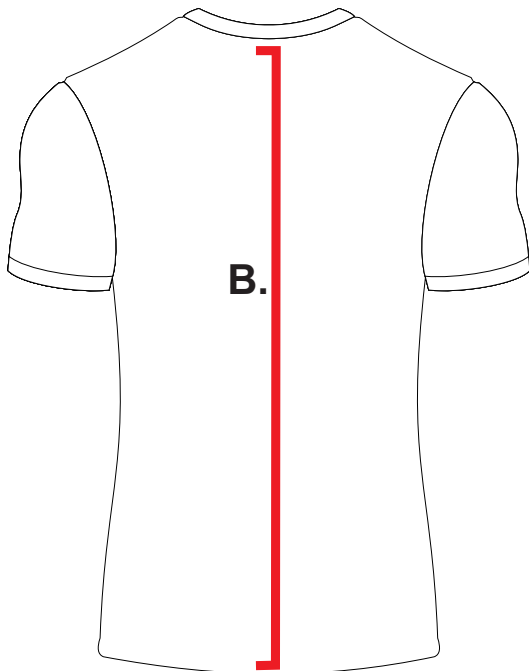
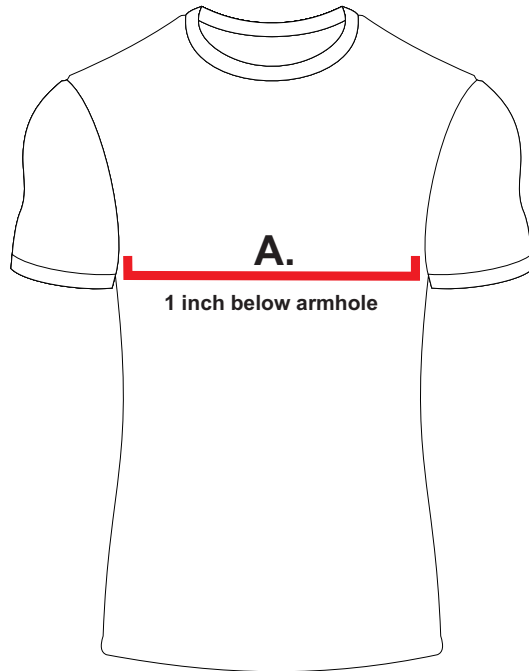
PRODUCT**SOCCER JERSEYS****MEN'S**

	A.Chest (in)	B.Length (in)
MXS	20.25	27.5
MS	21	28.5
MM	21.75	30
ML	22.5	30.5
MXL	23.5	31.5
M2XL	24.25	32.5
M3XL	25	33.75
M4XL	26	35

WOMEN'S

	A.Chest (in)	B.Length (in)
WXS	17	22
WS	18	22.75
WM	19	23.5
WL	20	24.25
WXL	21	25
W2XL	22	25.75

YOUTH

	A.Chest (in)	B.Length (in)
YXS	17.25	20.75
YS	18	22.5
YM	18.75	23.5
YL	19.5	25.5
YXL	20.25	27

PRODUCT

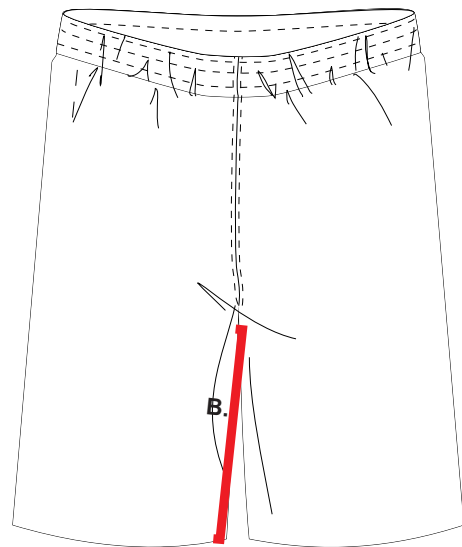
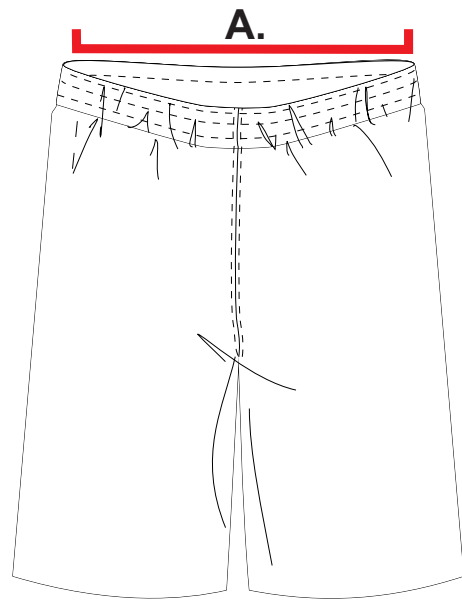

SOCCER SHORTS

MEN'S

	A. Waist (in)	B. Inseam (in)
MXS	12	6.5
MS	13	6.75
MM	14	7
ML	15	7.25
MXL	16	7.5
M2XL	17	7.75
M3XL	18	8
M4XL	19	8.25

WOMEN'S

	A. Waist (in)	B. Inseam (in)
WXS	11	6.5
WS	12	6.75
WM	13	7
WL	14	7.2
WXL	15	7.5
W2XL	16	7.75

YOUTH

	A. Waist (in)	B. Inseam (in)
YXS	8.5	6
YS	9.5	6.25
YM	10.5	6.5
YL	11.5	6.75
YXL	12.5	7

PRODUCT

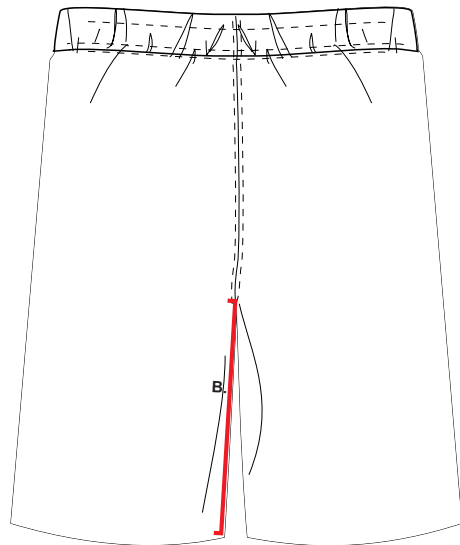
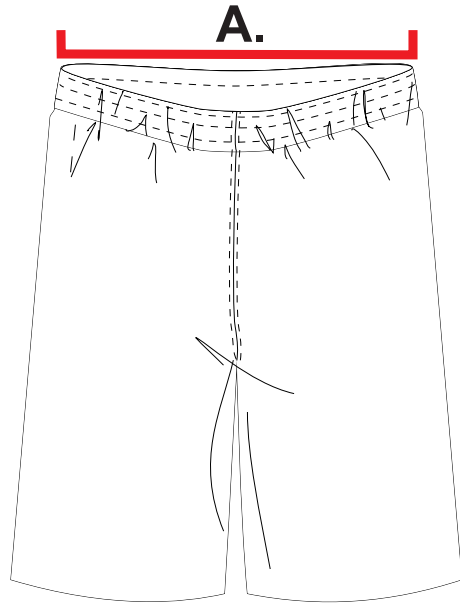

LACROSSE SHORTS

MEN'S

	A. Waist (in)	B. Inseam (in)
MXS	12	7.5
MS	13	8
MM	14	8.5
ML	15	9
MXL	16	9.5
M2XL	17	10

WOMEN'S

	A. Waist (in)	B. Inseam (in)
WXS	11	6.5
WS	12	6.75
WM	13	7
WL	14	7.25
WXL	15	7.5
W2XL	16	7.75

BOYS

	A. Waist (in)	B. Inseam (in)
BXS	8	6.5
BS	9	6.75
BM	10	7
BL	11	7.25
BXL	12	7.5

PRODUCT

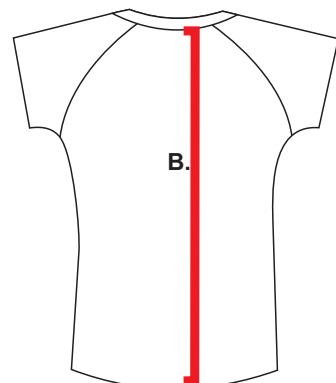
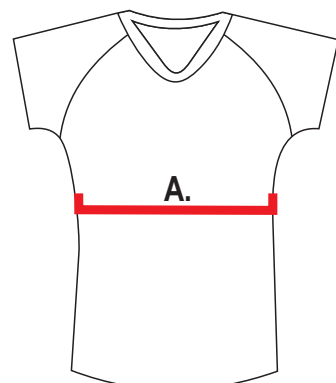
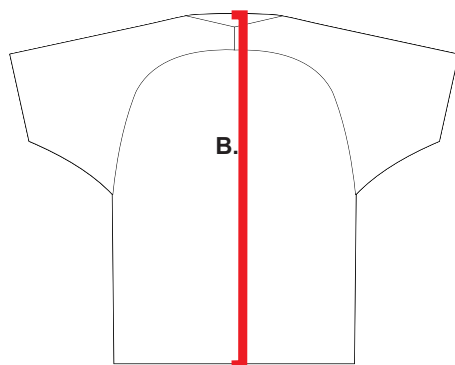
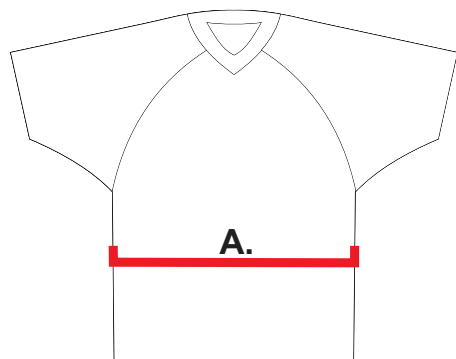

LACROSSE JERSEYS

MEN'S

	A.Chest (in)	B.Length (in)
MXS	21	24.5
MS	22	25.5
MM	23	26.5
ML	24	27.5
MXL	25	28.5
M2XL	26	29.5

BOYS

	A.Chest (in)	B.Length (in)
BXS	18	21
BS	19	22
BM	20	23
BL	21	24
BXL	22	25

WOMEN'S

	A.Chest (in)	B.Length (in)
WXS	17	23
WS	18	24
WM	19	25
WL	20	26
WXL	21	27
2WXL	22	28

GIRLS

	A.Chest (in)	B.Length (in)
GXS	14	22.5
GS	15	23.5
GM	16	24.5
GL	17	25.5
GXL	18	26.5

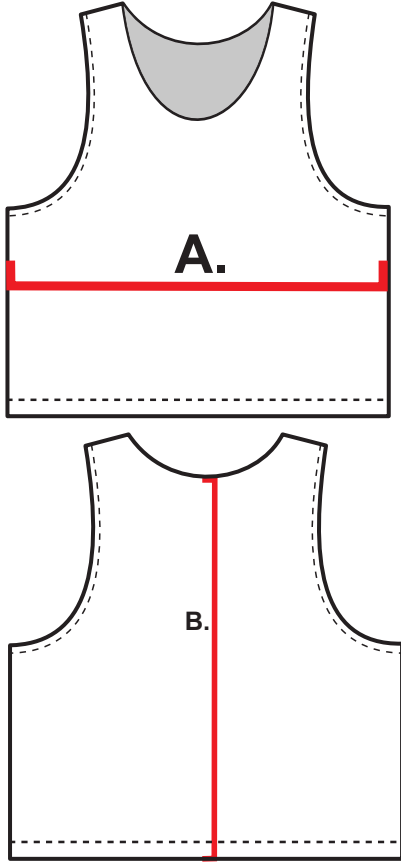
PRODUCT	LACROSSE PINNIES		
 <p>The diagram shows two views of a lacrosse pinnie. The top view shows a chest width measurement labeled 'A.' with a red horizontal line. The bottom view shows a length measurement labeled 'B.' with a red vertical line. The pinnie has a grey collar and dashed lines indicating the hem and seam locations.</p>	ADULT		
		A.Chest (in)	B.Length (in)
	AXS	22	23
	AS	23	24
	AM	24	25
	AL	25	26
	AXL	26	27
	A2XL	27	28
	YOUTH		
		A.Chest (in)	B.Length (in)
	YXS	19	20
	YS	20	21
YM	21	22	
YL	22	23	
YXL	23	24	

PRODUCT

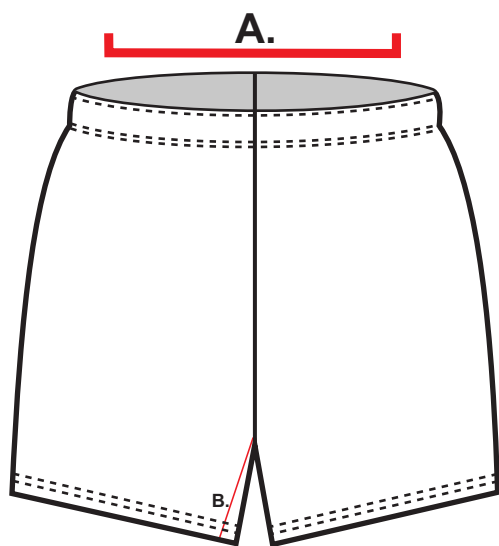

4" LACROSSE SHORTS

WOMEN'S

	A. Waist (in)	B. Inseam (in)
WXS	11	4
WS	12	4
WM	13	4
WL	14	4
WXL	15	4
W2XL	16	4

GIRLS

	A. Waist (in)	B. Inseam (in)
GXS	8	4
GS	9	4
GM	10	4
GL	11	4
GXL	12	4

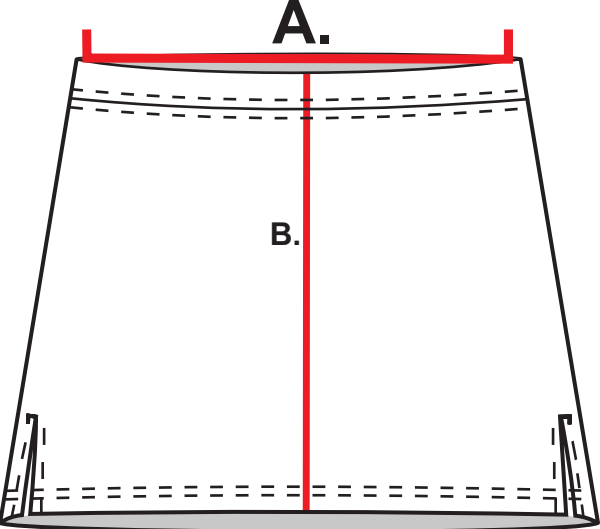
PRODUCT	LACROSSE SKIRTS		
 <p>The diagram shows a lacrosse skirt with two measurement lines. A horizontal red line at the top, labeled 'A.', indicates the waist measurement. A vertical red line from the waist to the bottom hem, labeled 'B.', indicates the inseam measurement. The skirt is shown in a perspective view with dashed lines for the back and bottom edges.</p>	WOMEN'S		
		A. Waist (in)	B. Inseam (in)
	WXS	13	13
	WS	14	13.5
	WM	15	14
	WL	16	14.5
	WXL	17	15
	W2XL	18	15.5
	GIRLS		
		A. Waist (in)	B. Inseam (in)
	GXS	8.5	10.5
	GS	9.5	11
	GM	10.5	11.5
	GL	11.5	12
GXL	12.5	12.5	

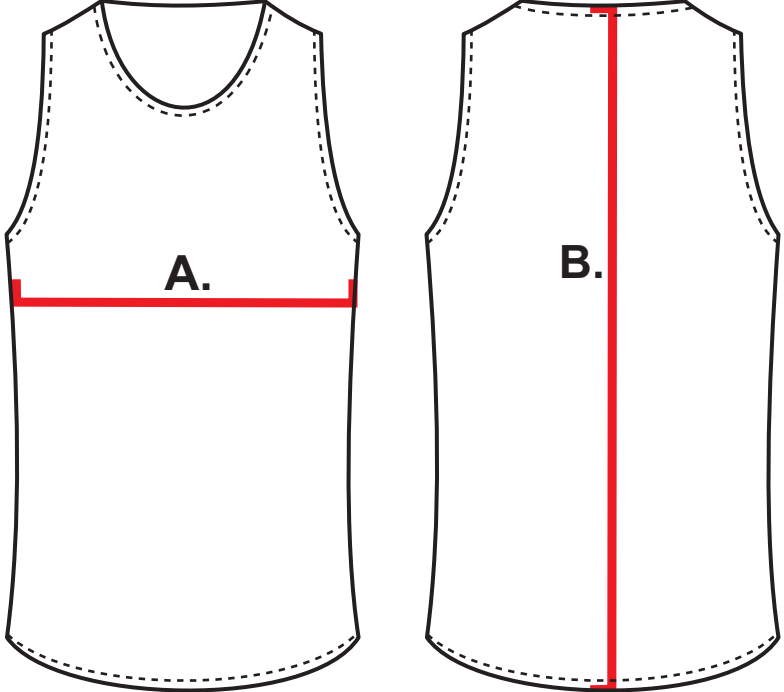
PRODUCT	TRACK TANK TOPS		
	MEN'S		
		A.Chest (in)	B.Length (in)
	MXS	18	24.5
	MS	19	25.5
	MM	20	26.5
	ML	21	27.5
	MXL	22	28.5
	M2XL	23	29.5
	WOMEN'S		
		A.Chest (in)	B.Length (in)
	WXS	15	23.75
	WS	16	24.75
	WM	17	25.75
	WL	18	26.75
	WXL	19	27.75
	W2XL	20	28.75
	YOUTH		
		A.Chest (in)	B.Length (in)
	YXS	14.5	20
	YS	15.5	21
	YM	16.5	22
YL	17.5	23	
YXL	18.5	24	

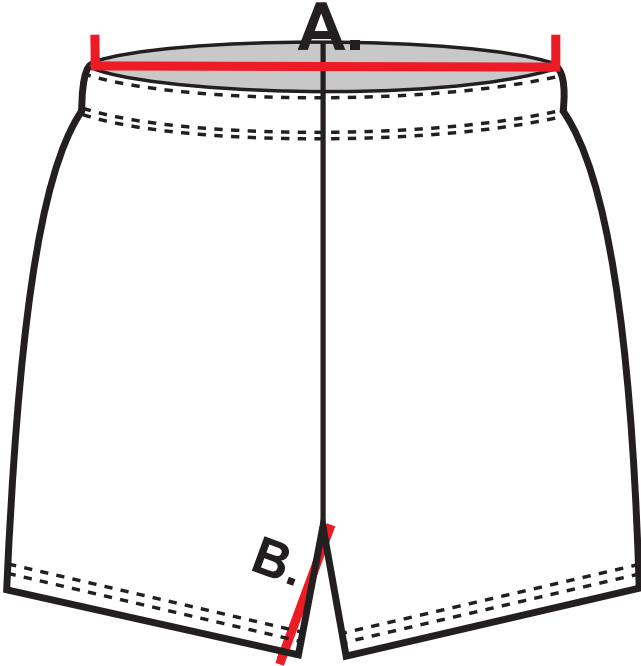
PRODUCT	TRACK SHORTS		
 <p>The diagram shows a pair of track shorts with a waistband and a fly. A red horizontal line labeled 'A.' spans the waistband. A red vertical line labeled 'B.' runs from the waistband down to the hem of the fly.</p>	MEN'S		
		A. Waist (in)	B. Inseam (in)
	MXS	12.5	5
	MS	13.5	5
	MM	14.5	5
	ML	15.5	5
	MXL	16.5	5
	M2XL	17.5	5
	WOMEN'S		
		A. Waist (in)	B. Inseam (in)
	WXS	12.5	3
	WS	13.5	3
	WM	14.5	3
	WL	15.5	3
	WXL	16.5	3
	W2XL	17.5	3
	YOUTH		
		A. Waist (in)	B. Inseam (in)
	YXS	8.5	5
	YS	9.5	5
	YM	10.5	5
YL	11.5	5	
YXL	12.5	5	

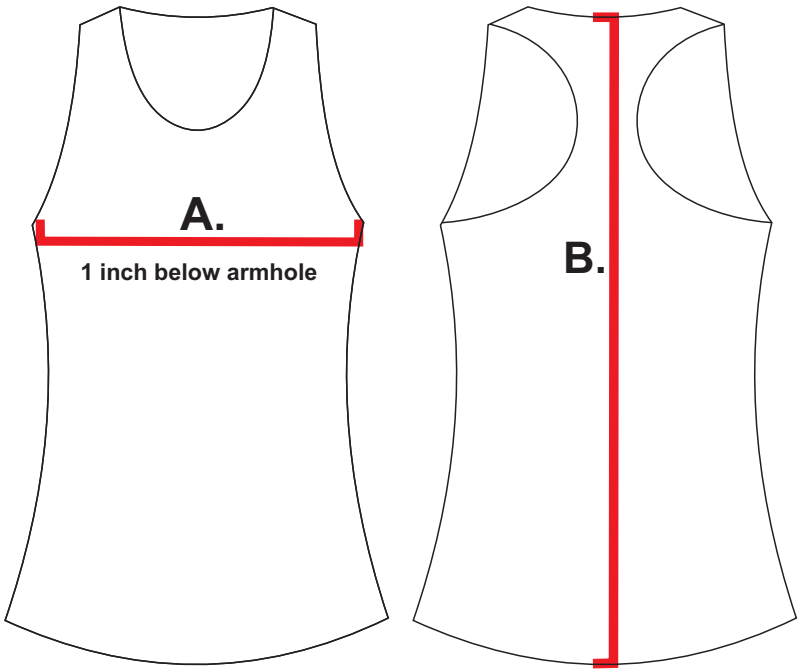
PRODUCT	TRACK RACERBACK TANK TOPS		
 <p>A. 1 inch below armhole</p> <p>B.</p>	WOMEN'S		
		A.Chest (in)	B.Length (in)
	WXS	15	23.75
	WS	16	24.75
	WM	17	25.75
	WL	18	26.75
	WXL	19	27.75
	W2XL	20	28.75
	GIRLS		
		A.Chest (in)	B.Length (in)
	GXS	13	21.5
	GS	13.75	22
	GM	14.5	22.5
	GL	15.25	23
GXL	16	23.5	

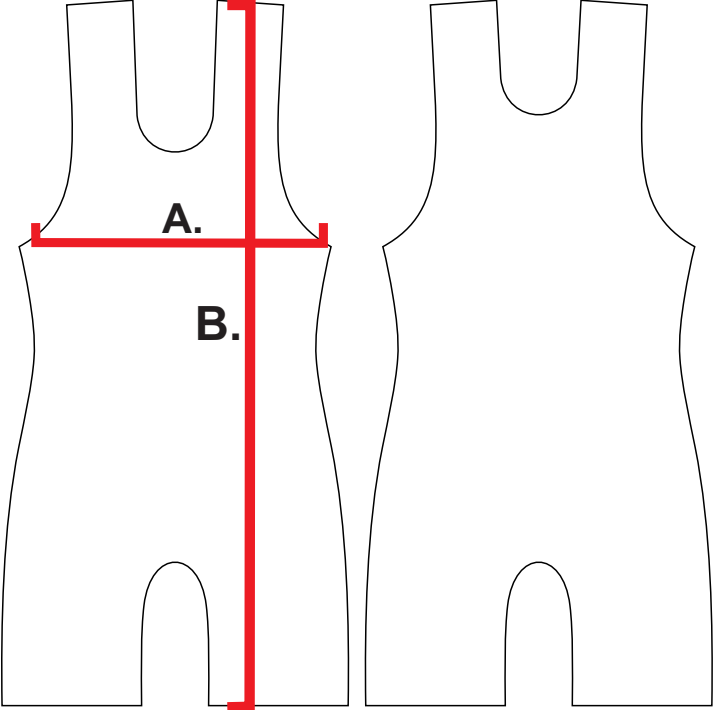
PRODUCT	WRESTLING SINGLETs		
 <p>The diagram shows two line drawings of a wrestling singlet. The left drawing is a front view with a red horizontal line across the chest labeled 'A.' and a red vertical line from the top center to the bottom center labeled 'B.'. The right drawing is a back view.</p>	MEN'S		
		A.Chest (in)	B.Length (in)
	MXS	12.5	28
	MS	13.5	29
	MM	14.5	30
	ML	15.5	31
	MXL	16.5	32
	M2XL	17.5	33
	M3XL	18.5	34
	M4XL	19.5	35
	BOYS		
		A.Chest (in)	B.Length (in)
	BXS	10	24
	BS	11	25
	BM	12	26
	BL	13	27
	BXL	14	28

PRODUCT

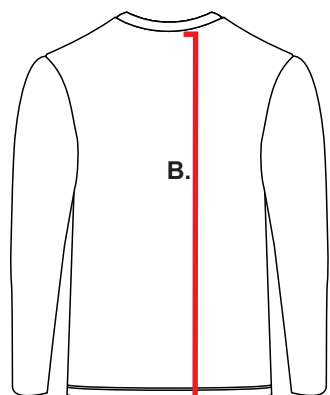
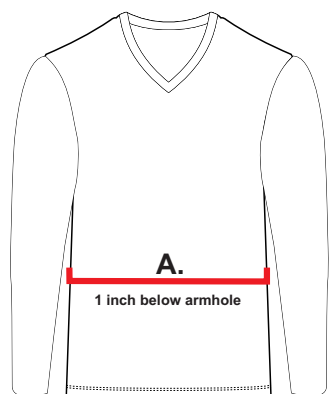
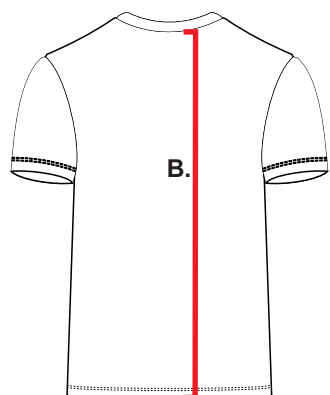
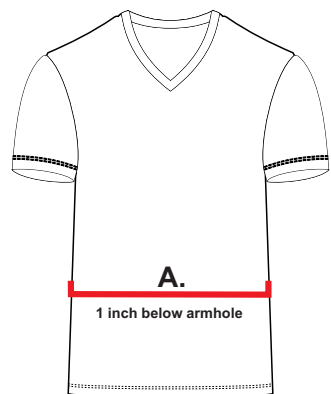

VOLLEYBALL JERSEYS

MEN'S

	A.Chest (in)	B.Length (in)
MXS	18	26
MS	19	27
MM	20	28
ML	21	29
MXL	22	30
M2XL	23	31

BOYS

	A.Chest (in)	B.Length (in)
BXS	14	21
BS	15	22
BM	16	23
BL	17	24
BXL	18	25

WOMEN'S

	A.Chest (in)	B.Length (in)
WXS	15.5	24.25
WS	16.5	25.25
WM	17.5	26.25
WL	18.5	27.25
WXL	19.5	28.25
2WXL	20.5	29.25

GIRLS

	A.Chest (in)	B.Length (in)
GXS	12	19.25
GS	13	20.25
GM	14	21.25
GL	15	22.25
GXL	16	23.25

PRODUCT

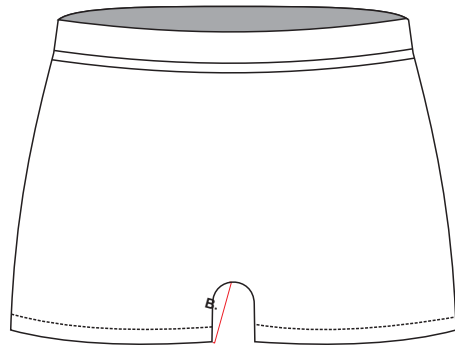
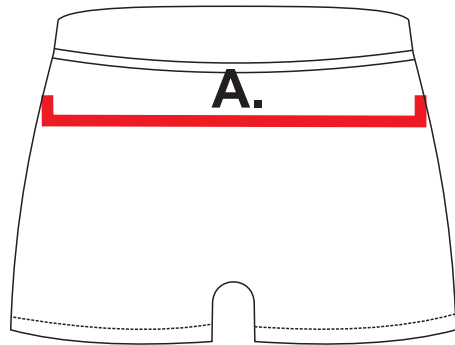
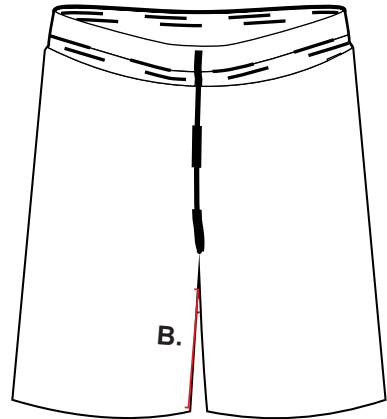
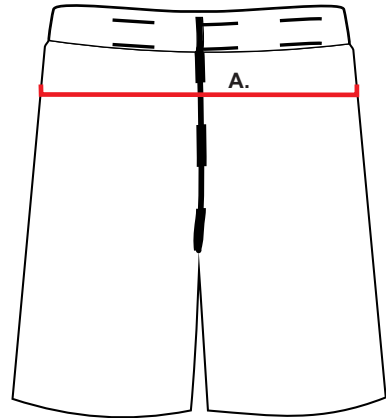

VOLLEYBALL SHORTS

MEN'S

	A. Waist (in)	B. Inseam (in)
MXS	12	6
MS	13	6.5
MM	14	7
ML	15	7.5
MXL	16	8
M2XL	17	8.5

BOYS

	A. Waist (in)	B. Inseam (in)
BXS	8.5	5.5
BS	9.5	6
BM	10.5	6.5
BL	11.5	7
BXL	12.5	7.5

WOMEN'S

	A. Waist (in)	B. Inseam (in)
WXS	11	3.5
WS	12	3.5
WM	13	3.5
WL	14	3.5
WXL	15	3.5
2WXL	16	3.5

GIRLS

	A. Waist (in)	B. Inseam (in)
GXS	8	3
GS	9	3
GM	10	3
GL	11	3
GXL	12	3

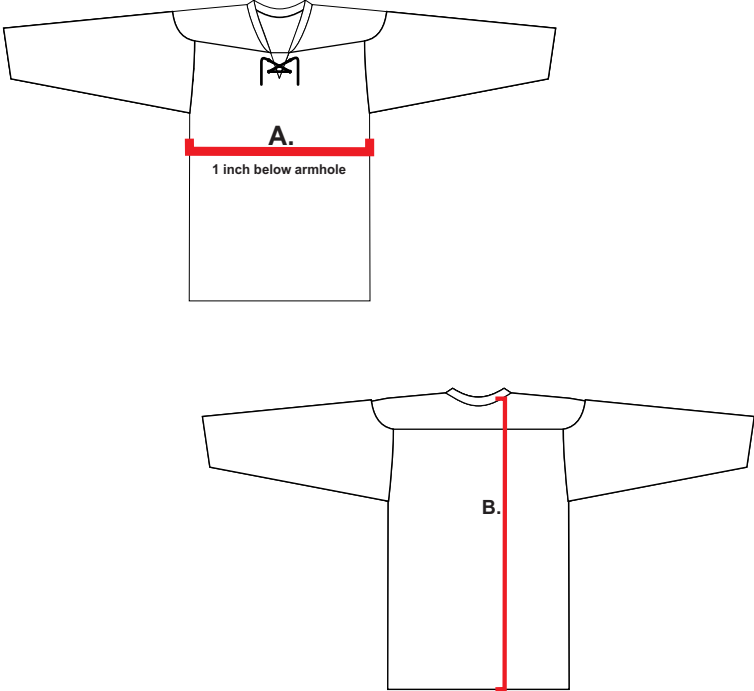
PRODUCT	ICE HOCKEY JERSEYS		
 <p>A. 1 inch below armhole</p> <p>B.</p>	MEN'S		
		A.Chest (in)	B.Length (in)
	MXS	23.5	29.5
	MS	24.5	30.5
	MM	25.5	31.5
	ML	26.5	32.5
	MXL	27.5	33.5
	M2XL	28.5	34.5
	YOUTH		
		A.Chest (in)	B.Length (in)
	YXS	18.5	25
	YS	19.5	26
	YM	20.5	27
	YL	21.5	28
YXL	22.5	29	

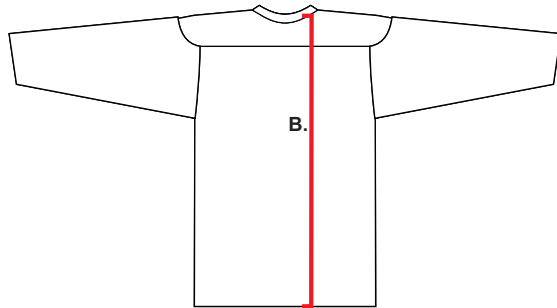
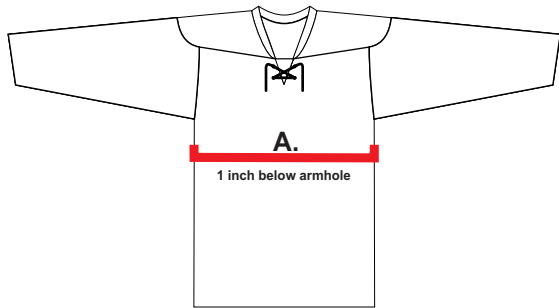
PRODUCT**ICE HOCKEY GOALIE JERSEYS****MEN'S**

	A.Chest (in)	B.Length (in)	C.Arm-Hole (in)
MXS	29	29.5	15.5
MS	30	30.5	16
MM	31	31.5	16.5
ML	32	32.5	17
MXL	33	33.5	17.5
M2XL	34	34.5	18

YOUTH

	A.Chest (in)	B.Length (in)	C.Arm-Hole (in)
YXS	22.5	25	11
YS	23.5	26	11.5
YM	24.5	27	12
YL	25.5	28	12.5
YXL	26.5	29	13

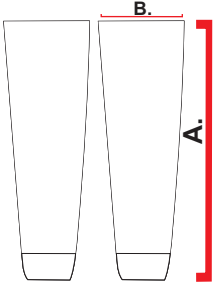
PRODUCT	ICE HOCKEY SOCKS		
		A. LENGTH (in)	B. 1/2 TOP OPENING (in)
	XS	18.5	9
	S	21.5	9.5
	M	25.5	11
	L	30	11.5

PRODUCT

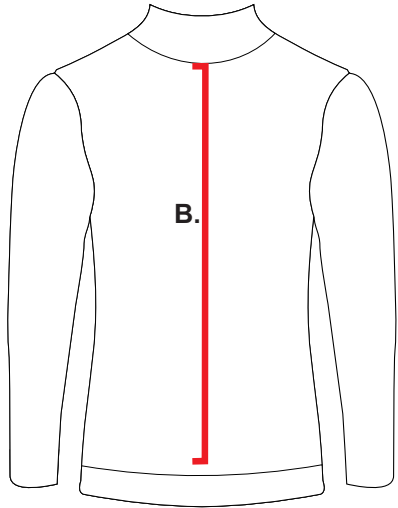
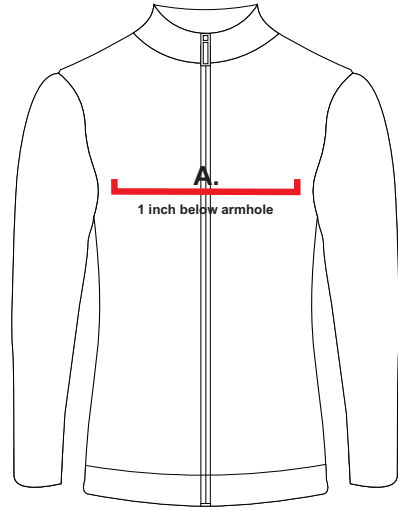

DANCE JACKETS

WOMEN'S

	A.Chest (in)	A.Length (in)
WS	18.5	26
WM	20	26.50
WL	21.25	26.75
WXL	22.75	27.5
W2XL	24.5	28

GIRLS

	A.Chest (in)	B.Length (in)
GXS	14.25	20
GS	15	20.75
GM	15.75	21.75
GL	16.50	22.50
GXL	17.25	23.25

MEN'S

	A.Chest (in)	A.Length (in)
MS	19.5	27
MM	21	27.50
ML	22.25	27.75
MXL	23.75	28.5
M2XL	25.5	29

BOYS

	A.Chest (in)	B.Length (in)
BXS	15.25	21
BS	16	21.75
BM	16.75	22.75
BL	17.50	23.50
BXL	18.25	24.25

PRODUCT	LEGGINGS		
<p>The diagram shows two line drawings of leggings. The left drawing shows the inseam measurement (B) as a vertical red line from the crotch to the hem. The right drawing shows the waist measurement (A) as a horizontal red line across the waistband.</p>	WOMEN'S		
		A. Waist (in)	B. Inseam (in)
	WXS	12.5	29
	WS	13	29
	WM	13.5	29
	WL	14.25	29
	WXL	15	29
	W2XL	16	29
	GIRLS		
		A. Waist (in)	B. Inseam (in)
	GXS	9.75	18
	GS	10.75	23
GM	11.25	26	
GL	11.75	28	
GXL	12.25	29	

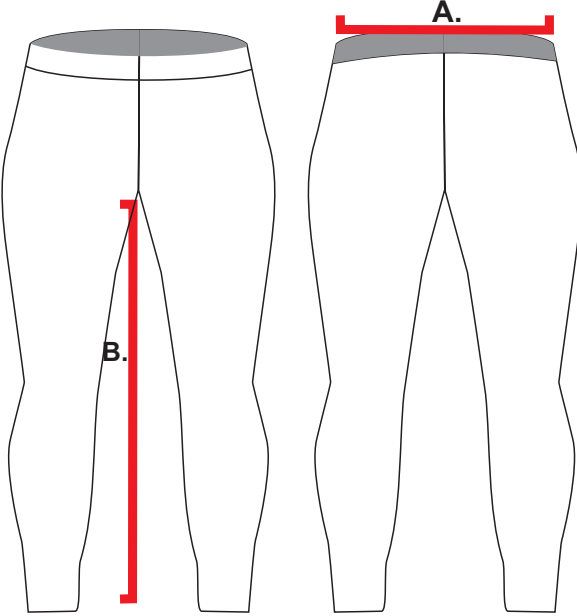
PRODUCT	3/4 LEGGINGS		
 <p>The diagram shows two line drawings of 3/4 leggings. The left drawing shows the inseam measurement 'B' as a vertical red line from the crotch to the hem. The right drawing shows the waist measurement 'A' as a horizontal red line across the waistband.</p>	WOMEN'S		
		A. Waist (in)	B. Inseam (in)
	WXS	12.5	23
	WS	13	23
	WM	13.5	23
	WL	14.25	23
	WXL	15	23
	W2XL	16	23
	GIRLS		
		A. Waist (in)	B. Inseam (in)
	GXS	9.75	12
	GS	10.75	17
GM	11.25	20	
GL	11.75	22	
GXL	12.25	23	