



# SAFETY SOLUTIONS CATALOG

YOU KNOW THE JOB.  
WE KNOW THE PROTECTION.





# TABLE OF CONTENTS

## RETAIL SOLUTIONS

### CARHARTT®

Billings®	17	Zumbro®	31
Carbondale®	14	VG10 Series	34
Carthage®	13	VG80 Series	33
Cayce™	16	VG90 Series	33
Displays	18	VG90 Youth Series	34
Easley™	16	VGBH90 Series	34
Ironside®	15		
Packaging	18		
Rockwood®	15		
Spokane®	17		
Toccoa™	13		

### VENTURE GEAR® TACTICAL

Drone®	23		
Howitzer™	21		
Loadout™	21		
Overwatch®	22		
Packaging	23		
Semtex 2.0™	23		
Stonewall®	22		

### VENTURE GEAR®

Amp BT™	32		
Atwater™	30		
Brevard®	26		
Clandestine™	32		
Displays	35		
Drop Zone®	31		
Ever-Lite® Range Kit	34		
Monteagle®	29		
Packaging	35		
Pagosa®	27		
Sentinel™	32		
Tensaw®	28		
Vallejo®	25		
Waverton™	30		

### DUCKS UNLIMITED®

DU80	38
DUCAB and DUCLAM1	37
DUCAB2 and DUCLAM2	38
Packaging	39
Shooting Eyewear	37
Shooting Kits	39

### PYRAMEX® RETAIL

Cappture™	41
Dielectric Earmuff	41
Disposable Earplugs	41
Intrepid II®	41
N95 Respirators	41
Onix®	41
PYS25 Combo Kits	41
Reusable Earplug	41
Venture 3®	41

## INDUSTRIAL SOLUTIONS

### HEADGEAR

Accessories	50
Adapters	50
Balaclava	54
Baseball Bump Caps	49
Face Shields	51
Kits	53
N95 Respirators	54
Ridgeline® Accessories	46
Ridgeline Bump Caps	47
Ridgeline Cap Style	46
Ridgeline Full Brim	47
Ridgeline Headgear	52
Ridgeline Hydro Dipped	47
SL Series Accessories	48
SL Series Cap Style	48
SL Series Full Brim	49
SL Series Sleek Shell	49

### EYEWEAR

Accessories	96
Accurist®	65
Achieva®	80
Alair®	80
Atoka®	82
Avanté®	76
Azera™	69
Cappture®	85
Capstone® 500	93
Capstone 600	93
Capstone Dual	92
Capstone RL	92
Capstone Shield	91
Cortez®	79
Defiant®	85
Displays	97
Emerge®	87
Emerge Plus	86
Endeavor® Plus	78
Ever-Lite®	70
Ever-Lite Readers	88
Exeter®	67
Fastrac®	82
Flex-Lyte™	70
Fortress®	77
Forum®	77
Furix®	66
Fyxate™	64
Goggles	94
Goliath®	66
Gravex®	77
GT 2000®	82
Highlander™	62
Highlander Plus	62
I-Force®	60
I-Force Slim	60
Integra®	76
Intrepid II®	79
Intruder®	83
Intruder and Mini	
Multi-Colors	83
Intruder Readers	89
Ionix®	75
Isotope™	61
Itek®	79
Mayan®	77
Mini Intruder	83
Mini Ztek	87
Monitor®	69
Neshoba™	81
Onix®	75
Onix Plus	75
OTS®	84
OTS XL	84
Outlander®	69
Pacifica®	77
Pathfinder™	69
PMXCEL®	62
PMXSLIM®	80
PMXTORQ®	77
PMXTREME®	72

PMXTREME LED	72
PMXTREME LED Readers	89
PMXTREME Readers	89
PMXTREME Rx	72
Provoq®	80
Proximity®	65
Reatta®	74
Rendezvous®	71
Sitecore™	71
Solara®	68
Solo®	84
Surveyor®	77
Torser™	61
Trifecta®	69
TruLock®	82
TruLock Multi-Colors	82
V2-Metal®	73
V2G®	63
V2G Readers	87
V2G-Plus®	90
V3T™	64
Velar™	67
Venture II®	73
Venture II Readers	88
Venture 3®	74
XS3® Plus	62
XSG®	63
XSG Kit	63
XSG Readers	87
Zone®	69
Zone II®	68
Ztek®	87
Ztek Readers	89

### WELDING

Auto-darkening	100
IR Products	102
Passive Helmet	102

### HEARING

Banded Earplug	111
Corded Earplugs	111
Passive Earmuffs	108
Electronic Earmuffs	108
Metal Detectable Earplugs	110
Push-in Earplugs	112
Uncorded Earplugs	112
Accessories	112

### HI-VIS WORK WEAR

Level 2 / Class 2	123
Non-Rated	126
Self-Extinguishing	118
Type R / Class 2	116
Type R / Class 3	120

### GLOVES

ArchonX™	132
CorXcel™	130
Poly-Torq™	133
Synthetic Leather	134

### COOLING

Bandanas	139
Hard Hat Pad	139
Neck Shade	138
Skull Caps	138
Towels	138
Vest	139

### ERGONOMICS

Back Support	142
Elbow Sleeve	142
Knee Pads	142
Wrist Wrap	142

# PERFORM AT YOUR PEAK

When a group of entrepreneurs founded Pyramex in 1991, it was rooted in a belief that the business could only grow if the customers were top priority. Nearly 30 years later, that level of intention has earned Pyramex more than 2,500 distributors in 65 countries. Your feedback ensures our product line is not only innovative and stylish, but upholds a high standard of workmanship that reflects your work ethic. Our founders knew that to serve our customers well meant to readily adapt to their business needs. That's why we're constantly evolving to make life easier for you. When you call Pyramex, you'll always talk with a specialist. The same goes for our new non-automated live web chat. We take pride in your safety so you can take pride in your work and Perform at Your Peak.

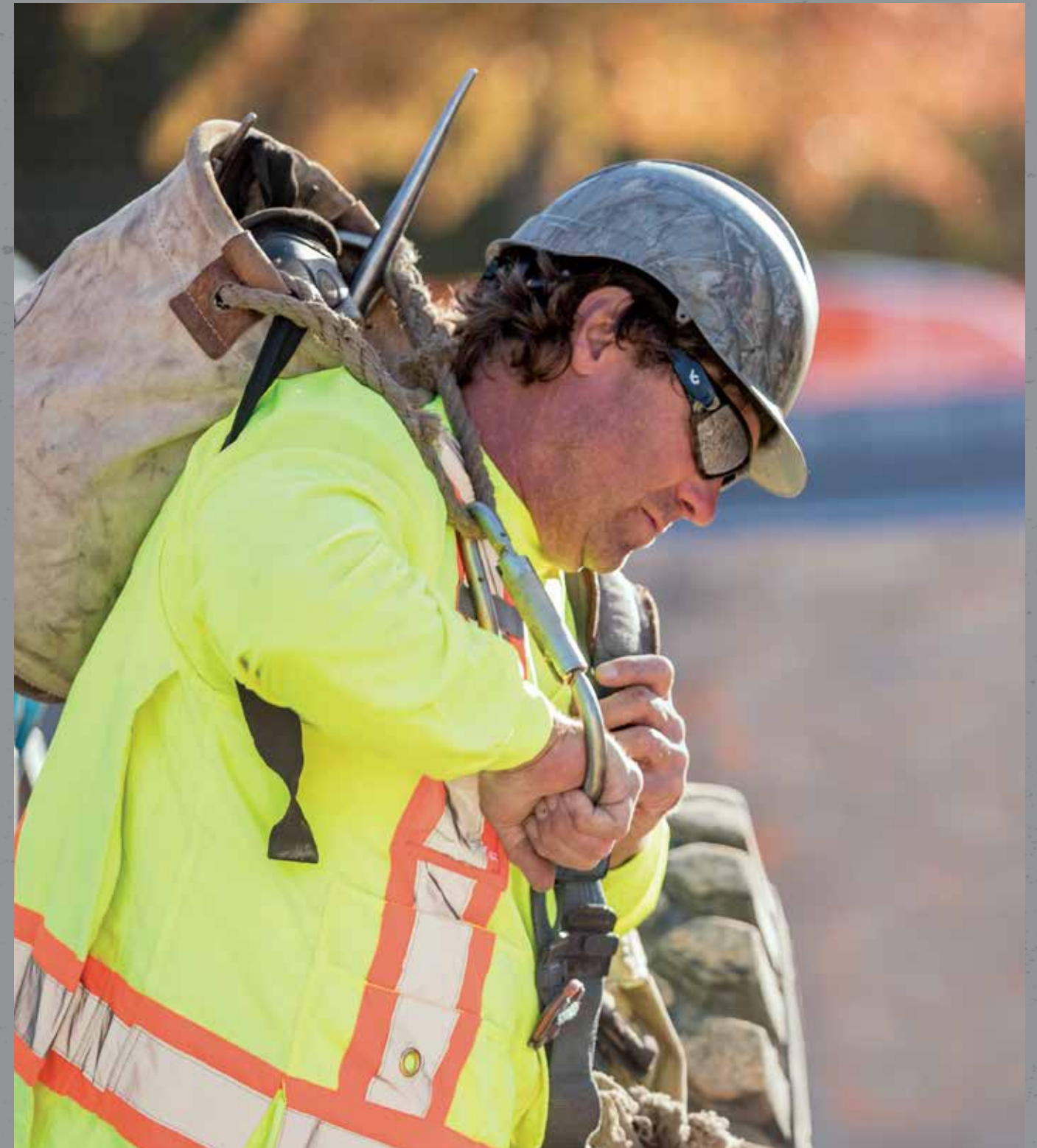

## How to Contact Us

📞 phone 800-736-8673 // fax 877-PYRAMEX

📍 305 Keough Drive, Piperton, TN 38017

✉️ help@pyramexsafety.com

🌐 [PyramexSafety.com](https://www.pyramexsafety.com)

💬 Live Web Chat available at [PyramexSafety.com](https://www.pyramexsafety.com)

📱 [PyramexSafety](https://www.pyramexsafety.com)

# NEW & NOTEWORTHY

## RETAIL 10 – 41



**Amp BT™**  
1 Variation  
Venture Gear® Bluetooth Earmuff  
See page 32



**Reusable Corded Earplug**  
1 Variation  
Pyramex® Packaged Earplugs  
See page 41



**Capture™**  
1 Variation  
Pyramex Packaged Eyewear  
See page 41

## HEADGEAR 44 – 55



**Ridgeline® CSA Cap Style**  
5 Variations  
Cap Style with side clips to meet  
CSA standards  
See page 46 - 47



**Ridgeline Full Brim**  
4 Variations  
Vented 4-Point Ratchet  
See page 47



**Ridgeline Full Brim**  
5 Variations  
6-Point Ratchet  
See page 47



**Hard Hat ID Sticker**  
1 Variation  
Sticker stores medical info and  
emergency contacts  
See page 50

## EYEWEAR 56 – 97



**Velar™**  
6 Variations  
Full Frame Eyewear  
See page 67



**Flex-Lyte™**  
10 Variations  
Half Frame Eyewear  
See page 70



**Capture™ with  
Rubber Gasket**  
2 Variations  
Over the Spectacle  
See page 85



**Ever-Lite® Readers**  
7 Variations  
Half Frame Readers  
See page 88



**IDBADGE**  
1 Variation  
Identification Badge Lanyard  
See page 96

## HEARING 106 – 113



**Amp BT™**  
1 Variation  
Venture Gear® Bluetooth Earmuff  
See page 108



**Reusable Corded Earplug**  
1 Variation  
Small holding case with Earplugs  
See page 111

## HI-VIS WORK WEAR 114 – 127



**RTS33 Series**  
2 Variations  
Type R | Class 3 Shirt  
See page 120



**RVZ35 Series**  
2 Variations  
Type R | Class 3 Vest  
See page 120



**RP31 Series**  
2 Variations  
Type R | Class 3 Parka  
See page 122



**RPB36 Series**  
1 Variation  
Type R | Class 3 Parka  
See page 122



**RSZH33 Series**  
2 Variations  
Type R | Class 3 Sweatshirt  
See page 122



**RC7P35 Series**  
1 Variation  
CSA – Level 2 | Class 2 Parka  
ANSI – Type R | Class 3 Parka  
See page 123



**RCJ32 Series**  
2 Variations  
CSA – Level 2 | Class 2 Jacket  
ANSI – Type R | Class 3 Jacket  
See page 123



**RCP32 Series**  
1 Variation  
CSA – Level 2 | Class 2 Parka  
ANSI – Type R | Class 3 Parka  
See page 123



**RCSZH33 Series**  
1 Variation  
CSA – Level 2 | Class 2 Sweatshirt  
ANSI – Type R | Class 3 Sweatshirt  
See page 124



**RCLTS31 Series**  
3 Variations  
CSA – Level 2 | Class 2 (1) Shirt  
ANSI – Type R (0) | Class 3 (1) Shirt  
See page 124

## GLOVES 128 – 135



**GL605 Series**  
1 Variation  
CorXcel™  
Polyester | Nitrile | Sandy & Smooth  
See page 130



**GL603DPC5 Series**  
1 Variation  
CorXcel™  
HPPE | Nitrile | Micro-Foam with  
Dotted Palm | Cut-Resistant  
See page 131



**GL601DP Series**  
1 Variation  
CorXcel™  
Nylon & Spandex | Nitrile |  
Micro-Foam With Dotted Palm  
See page 132



**GL502 Series**  
1 Variation  
ArchonX™  
Nylon | Latex | Sandy & Smooth  
See page 132

## COOLING 136 – 139



**CV100 Series**  
1 Variation  
Non-rated Cooling Vest  
See page 139



**CV200 Series**  
1 Variation  
Type R | Class 2 Cooling Vest  
See page 139

# RETAIL 10 – 41

CARHARTT® 12 – 19

VENTURE GEAR TACTICAL® 20 – 23

VENTURE GEAR® 24 – 35

DUCKS UNLIMITED® 36 – 39

PYRAMEX® 40 – 41



A



B

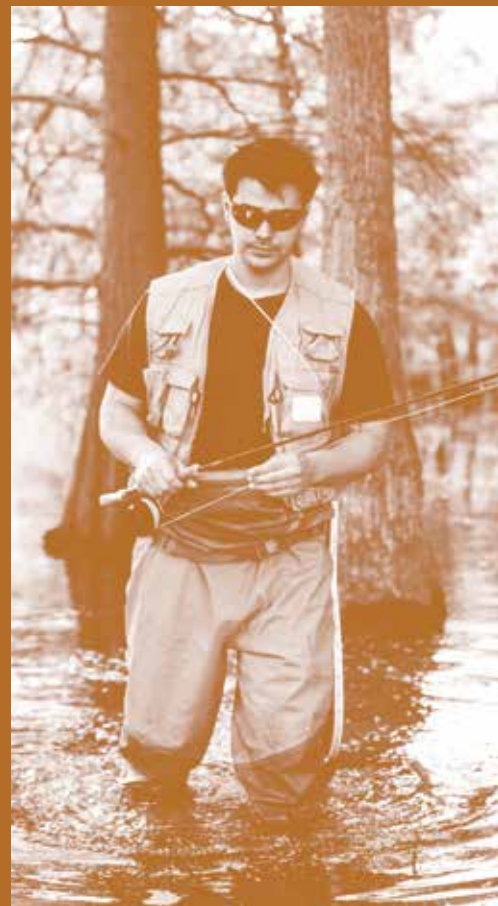

D



C

A – Carhartt / Rockwood®

B – Venture Gear Tactical / Overwatch® / Stonewall®

C – Ducks Unlimited

D – Venture Gear / Pagosa®

# WHAT YOU NEED TO KNOW

## Programs Customized For You

We customize our proven programs, presenting you with researched solutions to help maximize your keystone margins while making multiple turns on inventory. Pyramex strives to bolster our service, meeting our customers face to face at trade shows so we can understand what helps your business amplify its sales.

## Brands Your Customers Know

Our longstanding relationships with major distributors, buy groups, and co-ops allows us to offer competitive pricing for the most in-demand brands on the market, including Carhartt, Ducks Unlimited, Venture Gear, and Venture Gear Tactical.



## Merchandising Solutions

Removing an extra step of work for you, we offer customized planograms and retail-ready packaging. Our branded displays maximize floor space, so all you have to decide is what products best serve your business.

## Certifications

### Eyewear

Pyramex eyewear has been independently tested for various standards and certifications. Use the quick key (ANSI • CE • CSA • AS • Ballistic • ) on the following pages to reference product models that meet these standards and certifications. Use the dots next to each part number to reference which options meet the standards and certifications. See page 57 for more information on eyewear certifications.

### Hearing

Our hearing products have been independently tested for various standards and certifications. Use the quick key (ANSI • CE • ) on the following pages to reference product models that meet these standards and certifications. Use the dots next to each part number to reference which options meet the standards and certifications. See page 107 for more information on hearing certifications.



Billings®



Carhartt has a long history of providing honest workers with honest products. They know their consumers don't just "do" their job. They live it. They don't just work. They outwork. They never stop moving. Carhartt is known for making durable and long-lasting products that provide the dependability hard workers require. OUTWORK THEM ALL.

## Carthage®

Indirect vented foam padded carriage // Interchangeable temples and strap are included // Available in a Carhartt polybag



CHB410DTP •• (polybag)  
Clear Anti-fog Lens with  
Black and Tan Frame



CHB418DTP •• (polybag)  
Sandstone Bronze Anti-fog Lens with  
Black and Tan Frame



CHB420DTP •• (polybag)  
Gray Anti-fog Lens with  
Black and Tan Frame



CHRT410DTP •• (polybag)  
Clear Anti-fog Lens with  
Realtree Xtra® Camo Frame



CHRT420DTP •• (polybag)  
Gray Anti-fog Lens with  
Realtree Xtra® Camo Frame



## Toccoa™

Clip-on foam padded carriage // Slim temple design with detachable strap // Available in a Carhartt polybag



CHB1010DTP ••• (polybag)  
Clear H2MAX Anti-fog Lens with  
Black and Tan Frame



CHB1018DTP ••• (polybag)  
Sandstone Bronze H2MAX Anti-fog Lens with  
Black and Tan Frame



CHB1020DTP ••• (polybag)  
Gray H2MAX Anti-fog Lens with  
Black and Tan Frame



CHRT1010DTP ••• (polybag)  
Clear H2MAX Anti-fog Lens with  
Realtree Xtra® Camo Frame



CHRT1020DTP ••• (polybag)  
Gray H2MAX Anti-fog Lens with  
Realtree Xtra® Camo Frame





Carbondale®

## Carbondale®

Flexible rubber nosepiece // Co-injected temples // Available in a Carhartt capture clam or polybag



**CHB210DCC •• (capture clam)**  
Clear Lens with Black and Tan Frame

**CHB210DT •• (polybag)**  
Clear Anti-fog Lens with Black and Tan Frame

**CHB210D •• (polybag)**  
Clear Lens with Black and Tan Frame



**CHB218DCC •• (capture clam)**  
Sandstone Bronze Lens with Black and Tan Frame



**CHB220DCC •• (capture clam)**  
Gray Lens with Black and Tan Frame

**CHB218D •• (polybag)**  
Sandstone Bronze Lens with Black and Tan Frame

**CHB220D •• (polybag)**  
Gray Lens with Black and Tan Frame



**CHB220DT •• (polybag)**  
Gray Anti-fog Lens with Black and Tan Frame



**CHB290DCC •• (capture clam)**  
Antique Mirror Lens with Black and Tan Frame

**CHB290D •• (polybag)**  
Antique Mirror Lens with Black and Tan Frame



**CHRT218DCC •• (capture clam)**  
Sandstone Bronze Lens with Realtree Xtra® Camo Frame

**CHRT218D •• (polybag)**  
Sandstone Bronze Lens with Realtree Xtra® Camo Frame



**CHRT220DCC •• (capture clam)**  
Gray Lens with Realtree Xtra® Camo Frame

**CHRT220D •• (polybag)**  
Gray Lens with Realtree Xtra® Camo Frame



**CHRT290DCC •• (capture clam)**  
Antique Mirror Lens with Realtree Xtra® Camo Frame

**CHRT290D •• (polybag)**  
Antique Mirror Lens with Realtree Xtra® Camo Frame

## Ironside®

Rubber nosepiece and temple tips // Straight-back vented, flexible temples // Available in a Carhartt capture clam or polybag



**CHB618DTCC • (capture clam)**  
Sandstone Bronze Anti-fog Lens with Black and Tan Frame

**CHB618DT • (polybag)**  
Sandstone Bronze Anti-fog Lens with Black and Tan Frame



**CHB620DTCC • (capture clam)**  
Gray Anti-fog Lens with Black and Tan Frame

**CHB620DT • (polybag)**  
Gray Anti-fog Lens with Black and Tan Frame



**CHB690DTCC • (capture clam)**  
Antique Mirror Anti-fog Lens with Black and Tan Frame

**CHB690DT • (polybag)**  
Antique Mirror Anti-fog Lens with Black and Tan Frame



**CHRT618DTCC • (capture clam)**  
Sandstone Bronze Anti-fog Lens with Realtree Xtra® Camo Frame

**CHRT618DT • (polybag)**  
Sandstone Bronze Anti-fog Lens with Realtree Xtra® Camo Frame



**CHRT620DTCC • (capture clam)**  
Gray Anti-fog Lens with Realtree Xtra® Camo Frame

**CHRT620DT • (polybag)**  
Gray Anti-fog Lens with Realtree Xtra® Camo Frame



**CHRT690DTCC • (capture clam)**  
Antique Mirror Anti-fog Lens with Realtree Xtra® Camo Frame

**CHRT690DT • (polybag)**  
Antique Mirror Anti-fog Lens with Realtree Xtra® Camo Frame



## Rockwood®

Suspended anti-fog lens // Adjustable rubber nosepiece and co-injected temple tips // Available in a Carhartt capture clam or polybag



**CHB710DT • (polybag)**  
Clear Anti-fog Lens with Black and Tan Frame



**CHB718DTCC • (capture clam)**  
Sandstone Bronze Anti-fog Lens with Black and Tan Frame

**CHB718DT • (polybag)**  
Sandstone Bronze Anti-fog Lens with Black and Tan Frame



**CHB720DTCC • (capture clam)**  
Gray Anti-fog Lens with Black and Tan Frame

**CHB720DT • (polybag)**  
Gray Anti-fog Lens with Black and Tan Frame



## Easley™

Built-in browguard // Adjustable nosepiece  
// Ventilated temples // Available in a  
Carhartt polybag



CHB810ST ••• (polybag)  
Clear Anti-fog Lens with Black and Tan Frame



CHB818ST ••• (polybag)  
Sandstone Bronze Anti-fog Lens with  
Black and Tan Frame



CHB820ST ••• (polybag)  
Gray Anti-fog Lens with Black and Tan Frame

## Cayce™

Slim temple design // Adjustable rubber  
nosepiece // Wraparound coverage  
for superior protection // Available in a  
Carhartt polybag



CHB910ST ••• (polybag)  
Clear Anti-fog Lens with Black Frame



CHB918ST ••• (polybag)  
Sandstone Bronze Anti-fog Lens with Black Frame



CHB920ST ••• (polybag)  
Gray Anti-fog Lens with Black Frame

## Spokane®

Flexible rubber nosepiece // Co-injected  
straight-back temples // Unique half-frame  
design for the active lifestyle // Available in a  
Carhartt capture clam or polybag



CHB310DCC •• (capture clam)  
Clear Lens with Black Frame

CHB310D •• (polybag)  
Clear Lens with Black Frame



CHB318DCC •• (capture clam)  
Sandstone Bronze Lens with Black Frame

CHB318D •• (polybag)  
Sandstone Bronze Lens with Black Frame



CHB320DCC •• (capture clam)  
Gray Lens with Black Frame

CHB320D •• (polybag)  
Gray Lens with Black Frame

## Billings®

Lightweight, frameless design // Wraparound coverage for superior  
protection // Available in a Carhartt clamshell or polybag



CH110S •• (polybag)  
Clear Lens with Clear Temples

CH110STCS •• (clamshell)  
Clear Anti-fog Lens with Clear Temples

CH110ST •• (polybag)  
Clear Anti-fog Lens with Clear Temples



CH118S •• (polybag)  
Sandstone Bronze Lens with  
Sandstone Bronze Temples



CH120S •• (polybag)  
Gray Lens with Gray Temples



CH120STCS •• (clamshell)  
Gray Anti-fog Lens with Gray Temples

CH120ST •• (polybag)  
Gray Anti-fog Lens with Gray Temples

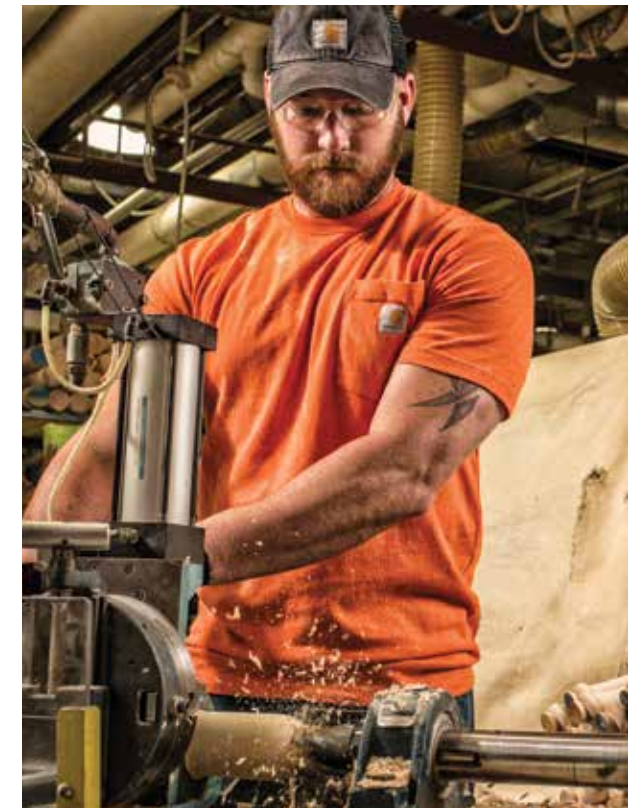

Billings

## Displays



CHBD144  
Carhartt Unit Bulk Display - holds up to 144 units  
(product sold separately)



CHCSD24  
Carhartt Unit Countertop Spinner Display - holds up to 24 units  
(product sold separately)



CHIC6  
Carhartt Stationary Display - holds up to 6 units  
(product sold separately)



CHSWD20  
Carhartt Slat Wall Display - holds up to 20 units  
(product sold separately)

## Packaging

Carhartt products come packaged in either a branded clamshell, capture clam, or polybag.



Clamshell



Capture Clam



Polybag for Display Box

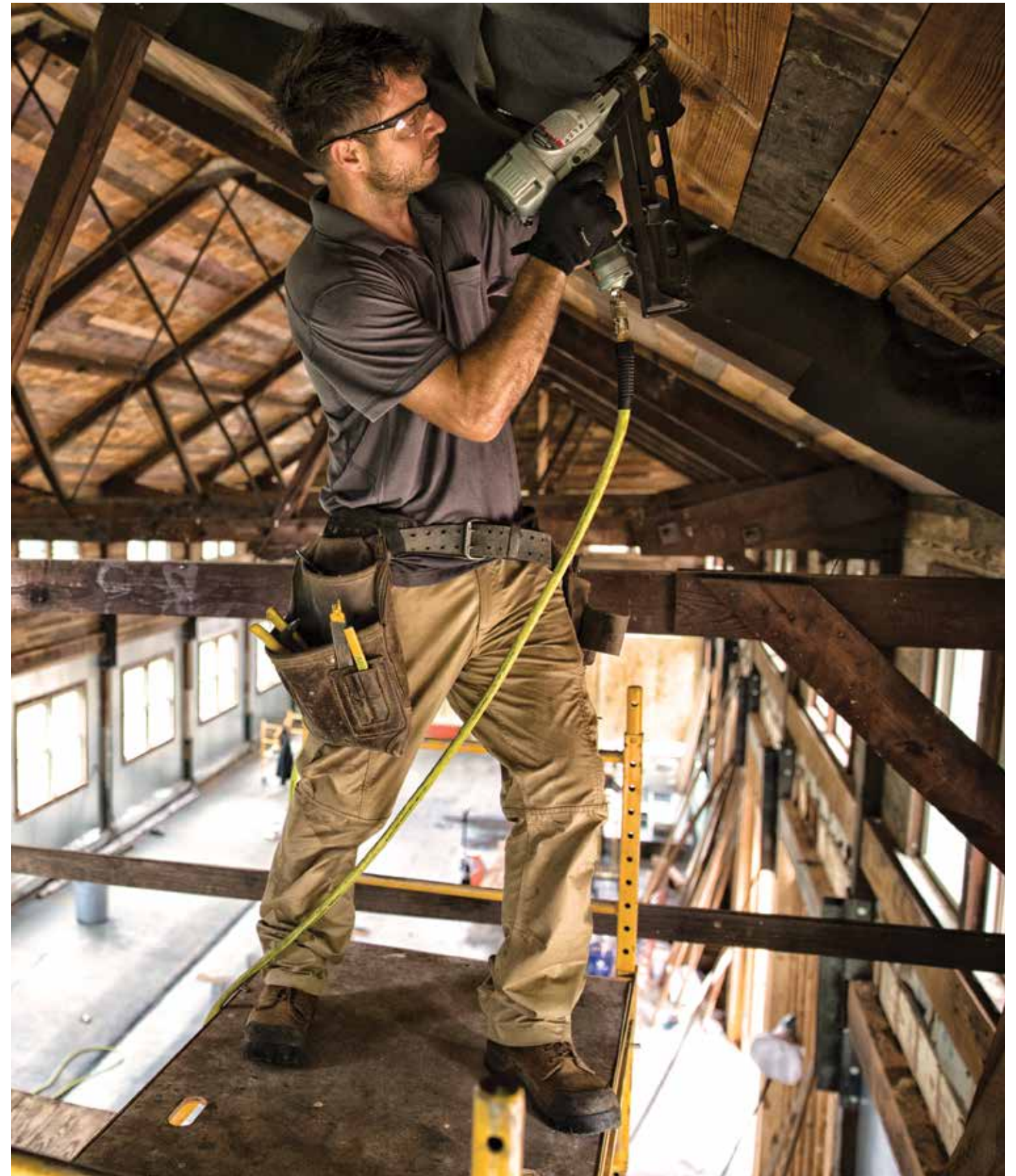

Rockwood®

**IF IT CARRIES THE NAME CARHARTT®  
ITS PERFORMANCE WILL BE LEGENDARY.**

*Hamilton Carhartt*



Loadout™



On the front lines, on patrol, or on the range, Venture Gear Tactical protects your eyes so you can accomplish your objective. All Venture Gear Tactical eyewear is built with the highest quality materials and pass Ballistic High Velocity Impact standards (MIL-PRF-32432), providing you with premium quality and protection. You can trust that your eyes are protected from even the harshest conditions when you choose Venture Gear Tactical. ACCOMPLISH YOUR OBJECTIVE.



### Loadout™

Vented frame helps fight fogging while filtering dust and small particles // Foam padded for added protection and comfort // Integrated sleeve protects lens when not in use // Passes D3: Droplet and Splash Test – provides protection from droplets and splashes // Passes D4: Dust Test – provides protection from dust particles // Passes Ballistic MIL-PRF-32432 High Velocity Impact standards // Available in a VGT box and includes canvas storage case with MOLLE compatible snap straps

VGGB1510STM ●●● (box)  
Clear H2MAX Anti-fog Lens with Black Body



Loadout ballistic goggle shot with 12 gauge shotgun and 2 3/4 inch steel #6 at 25 yards

### Howitzer™

Custom-fit rubber nosepiece // Non-slip, flexible, co-injected temples // Passes Ballistic MIL-PRF-32432 High Velocity Impact standards // Available in a VGT clamshell and includes microfiber cleaning bag



VGSB1310T ●●● (clamshell)  
Clear Anti-fog Lens with Black Frame



VGSB1318T ●●● (clamshell)  
Bronze Anti-fog Lens with Black Frame



VGSB1322T ●●● (clamshell)  
Forest Gray Anti-fog Lens with Black Frame



VGST1310T ●●● (clamshell)  
Clear Anti-fog Lens with Tan Frame



VGST1318T ●●● (clamshell)  
Bronze Anti-fog Lens with Tan Frame



VGST1322T ●●● (clamshell)  
Forest Gray Anti-fog Lens with Tan Frame



Overwatch



### Overwatch®

Soft nosepiece and rubber temple tips // Passes Ballistic MIL-PRF-32432 High Velocity Impact standards // Available in a VGT clamshell and includes microfiber cleaning bag



VGSB718T ●●● (clamshell)  
Bronze Anti-fog Lens with Black Frame



VGSB722T ●●● (clamshell)  
Forest Gray Anti-fog Lens with Black Frame



VGS6718T ●●● (clamshell)  
Bronze Anti-fog Lens with OD Green Frame



VGS6722T ●●● (clamshell)  
Forest Gray Anti-fog Lens with OD Green Frame



VGSUG710T ●●● (clamshell)  
Clear Anti-fog Lens with Urban Gray Frame



VGSUG722T ●●● (clamshell)  
Forest Gray Anti-fog Lens with Urban Gray Frame



### Stonewall®

Built-in rubber nosepiece // Durable, flexible nylon frame and straight-back temples // Passes Ballistic MIL-PRF-32432 High Velocity Impact standards // Available in a VGT clamshell and includes microfiber cleaning bag



VGSB418T ●●● (clamshell)  
Bronze Anti-fog Lens with Black Frame



VGSB422T ●●● (clamshell)  
Forest Gray Anti-fog Lens with Black Frame



VGSB465T ●●● (clamshell)  
Ice Blue Mirror Anti-fog Lens with Black Frame

### Semtex 2.0™

Adjustable custom-fit rubber nosepiece // Non-slip, flexible, co-injected temples // Passes Ballistic MIL-PRF-32432 High Velocity Impact standards // Available in a VGT clamshell and includes microfiber cleaning bag



VGSGM1410T ●●● (clamshell)  
Clear Anti-fog Lens with Gun Metal Frame



VGSGM1418T ●●● (clamshell)  
Bronze Anti-fog Lens with Gun Metal Frame



VGSGM1422T ●●● (clamshell)  
Forest Gray Anti-fog Lens with Gun Metal Frame



VGST1410T ●●● (clamshell)  
Clear Anti-fog Lens with Tan Frame



VGST1418T ●●● (clamshell)  
Bronze Anti-fog Lens with Tan Frame



VGST1422T ●●● (clamshell)  
Forest Gray Anti-fog Lens with Tan Frame



### Drone®

Adjustable rubber nosepiece // Non-slip, flexible, co-injected temples // Passes Ballistic MIL-PRF-32432 High Velocity Impact standards // Available in a VGT clamshell and includes microfiber cleaning bag



VGSB8310ST ●●● (clamshell)  
Clear Anti-fog Lens with Black Frame



VGSB8320ST ●●● (clamshell)  
Gray Anti-fog Lens with Black Frame



Box  
Includes canvas storage case with MOLLE compatible snap straps



Clamshell  
Includes microfiber cleaning bag



### Packaging

Venture Gear Tactical products come packaged in either a branded clamshell or box.



Ridgeline® / Tensaw® / CorXcel® / RSSH3210



Venture Gear products are designed for those with an active lifestyle. Whether that means recreational bike riding, building a tree house in the backyard, or working on the jobsite. Venture Gear products are designed to outperform at every level of activity—all while going above and beyond your expectations. DARE TO GO.



### Vallejo®

Built-in rubber nosepiece // Vented frame increases airflow to prevent fogging // Polarized options available // Available in a VG polybag



VGSB922T •• (polybag)  
Forest Gray Anti-fog Lens with Black Frame



VGSB931 •• (polybag)  
Polarized Green Mirror Lens with Black Frame



VGSB965T •• (polybag)  
Ice Blue Mirror Anti-fog Lens with Black Frame



VGSC965T •• (polybag)  
Ice Blue Mirror Anti-fog Lens with Clear Frame



VGST918T •• (polybag)  
Bronze Anti-fog Lens with Tortoise Frame



VGSW922T •• (polybag)  
Forest Gray Anti-fog Lens with White Frame



VGSW931 •• (polybag)  
Polarized Green Mirror Lens with White Frame



VGSW965T •• (polybag)  
Ice Blue Mirror Anti-fog Lens with White Frame



Brevard



**Brevard®**

Full wraparound lens provides excellent impact protection // Vented foam padded frame provides superior comfort with great airflow // Available in a VG polybag



VGSB1010DTB •• (polybag)  
Clear Anti-fog Lens with Shiny Black Frame



VGSB1026DTB •• (polybag)  
Forest Gray Anti-fog Lens with Shiny Black Frame



VGSB1057DTB •• (polybag)  
Green Mirror Anti-fog Lens with Shiny Black Frame



VGSCM1010DTB •• (polybag)  
Clear Anti-fog Lens with Camo Frame



VGSCM1018DTB •• (polybag)  
Bronze Anti-fog Lens with Camo Frame



VGSCM1026DTB •• (polybag)  
Forest Gray Anti-fog Lens with Camo Frame



Pagosa

**Pagosa®**

Wide straight-back temples // Soft rubber nosepiece // Polarized options available // Available in a VG box



VGSB518T • (box)  
Bronze Anti-fog Lens with Black Frame



VGSB522T • (box)  
Forest Gray Anti-fog Lens with Black Frame



VGSB523 • (box)  
Polarized Forest Gray Lens with Black Frame



VGSB565T • (box)  
Ice Blue Mirror Anti-fog Lens with Black Frame



VGSB570T • (box)  
Silver Mirror Anti-fog Lens with Black Frame



VGSW518T • (box)  
Bronze Anti-fog Lens with White Frame



VGSW522T • (box)  
Forest Gray Anti-fog Lens with White Frame



VGSW561 • (box)  
Polarized Ice Blue Mirror Lens with White Frame

VGSW565T • (box)  
Ice Blue Mirror Anti-fog Lens with White Frame

## Tensaw®

Adjustable rubber nosepiece // Co-injected temples for snug, secure fit // Half-frame high performance eyewear // Polarized options available // Available in a VG box



VGSB310T • (box)  
Clear Anti-fog Lens with Black and Gray Frame



VGSB318T • (box)  
Bronze Anti-fog Lens with Black and Gray Frame



VGSB322T • (box)  
Forest Gray Anti-fog Lens with Black and Gray Frame



VGSB323 • (box)  
Polarized Forest Gray Lens with Black and Gray Frame



VGSB327T • (box)  
Vermilion Anti-fog Lens with Black and Gray Frame



VGSB330T • (box)  
Yellow Anti-fog Lens with Black and Gray Frame



VGSB331 • (box)  
Polarized Green Mirror Lens with Black and Gray Frame



VGSB365T • (box)  
Ice Blue Mirror Anti-fog Lens with Black and Gray Frame



VGSB370T • (box)  
Silver Mirror Anti-fog Lens with Black and Gray Frame



VGSW365T • (box)  
Ice Blue Mirror Anti-fog Lens with White and Gray Frame



VGSWB365T • (box)  
Ice Blue Mirror Anti-fog Lens with White and Blue Frame



VGSWR351 • (box)  
Polarized Sky Red Mirror Lens with White and Red Frame

VGSWR355T • (box)  
Sky Red Mirror Anti-fog Lens with White and Red Frame



Monteagle



## Monteagle™

Adjustable rubber nosepiece // Co-injected temples for snug, secure fit // Available in a VG polybag



VGSC1620T • (polybag)  
Gray Anti-fog Lens with Clear and Blue Frame



VGSC1665T • (polybag)  
Ice Blue Mirror Anti-fog Lens with Clear and Blue Frame



VGSGM1618T • (polybag)  
Bronze Anti-fog Lens with Gun Metal and Black Frame



VGSGM1620T • (polybag)  
Gray Anti-fog Lens with Gun Metal and Black Frame



VGSGM1622T • (polybag)  
Forest Gray Anti-fog Lens with Gun Metal and Black Frame



VGSGM1665T • (polybag)  
Ice Blue Mirror Anti-fog Lens with Gun Metal and Black Frame



VGSGMV1620T • (polybag)  
Gray Anti-fog Lens with Gun Metal and Hi-vis Yellow Frame



VGSGMV1657T • (polybag)  
Ice Blue Mirror Anti-fog Lens with Gun Metal and Hi-vis Yellow Frame

## Waverton™

Flexible rubber nosepiece // Co-injected straight-back temples // Available in a VG polybag



VGSB1110DB • (polybag)  
Clear Lens with Black Frame



VGSB1126DB • (polybag)  
Forest Gray Lens with Black Frame



VGSB1165DB • (polybag)  
Ice Blue Mirror Lens with Black Frame



VGSB1170DB • (polybag)  
Silver Mirror Lens with Black Frame



VGSBR1118DB • (polybag)  
Bronze Lens with Brown Frame



VGSBR1156DB • (polybag)  
Multi-color Mirror Lens with Brown Frame

## Atwater™

Soft, rubber nosepiece // Wide straight-back temples // Available in a VG polybag



VGSB1226TB •• (polybag)  
Forest Gray H2X Anti-fog Lens with Black Frame



VGSB1265TB •• (polybag)  
Ice Blue Mirror Anti-fog Lens with Black Frame



VGSSB1226TB •• (polybag)  
Forest Gray H2X Anti-fog Lens with Black and Silver Frame



VGSSB1265TB •• (polybag)  
Ice Blue Mirror Anti-fog Lens with Black and Silver Frame



Ridgeline® / Atwater / C330 Towel / RTS2310

## Zumbro®

Soft, rubber nosepiece // Slim temple design includes soft rubber tips // Available in a VG box



VGSBR230T • (box)  
Yellow Anti-fog Lens with Bronze Frame



VGSBR210T • (box)  
Clear Anti-fog Lens with Bronze Frame



VGSBR218T • (box)  
Bronze Anti-fog Lens with Bronze Frame



VGSBR222T • (box)  
Forest Gray Anti-fog Lens with Bronze Frame



VGSBR227T • (box)  
Vermilion Anti-fog Lens with Bronze Frame

## Drop Zone®

Stylish contoured temples // High brow coverage // Rubber nosepiece // Easy to change replacement lenses // Passes Ballistic MIL-PRF-32432 High Velocity Impact standards // Includes: removable temples, crush-resistant neoprene storage case, microfiber cleaning cloth, and four interchangeable lenses // Available in a VG clamshell



VGSB88KIT ••• (clamshell)  
Clear H2X Anti-fog Lens, Forest Gray H2X Anti-fog Lens, Orange H2X Anti-fog Lens and Vermilion H2X Anti-fog Lens with Black Temples



Drop Zone





### Amp BT™

NRR 26dB



Electronic earmuff // Quad microphones // Bluetooth compatible // Noise suppression after 85db // Easy adjust volume and ambient noise controls // Auto shut-off after four hours // 3.5 mm AUX jack cord for use of MP3 and mobile devices // 2 AAA batteries are included // Available in a VG clamshell

VGPME30BT • (clamshell)  
Black Ear Cup with  
Black Headband



### Sentinel™

NRR 26dB



Electronic earmuff // Front facing microphone // Amplifies hearing while suppressing harmful sounds and reducing them to a safe level // Auto shut-off after four hours // 3.5 mm AUX jack cord for use of MP3 and mobile devices // 2 AAA batteries are included // Available in a VG clamshell

VGPME20 • (clamshell)  
Black Ear Cup with  
Black Headband

VGPME26 • (clamshell)  
Powder Blue Ear Cup with Black  
and Powder Blue Headband



### Clandestine™

NRR 24dB



Electronic earmuff // Omni directional microphone // Amplifies hearing while suppressing harmful sounds and reducing them to a safe level // External access for easy battery replacement // 2 AAA batteries are included // Available in a VG capture clam

VGPME10 • (capture clam)  
Black Ear Cup with  
Black Headband

VGPME17 • (capture clam)  
Black Graphite Pattern Ear Cup  
with Black Headband

### VG80 Series

NRR 36dB when worn with earplugs



Low-profile ear cup design // Height adjustment to fit all sizes // Fold-away padded headband // Earmuffs (NRR 26dB) are packaged with free disposable earplugs (NRR 32dB) // Available in a VG clamshell



VGPM8010C • (clamshell)  
Gray Ear Cup with Black Headband



VGPM8010PC • (clamshell)  
Pink Ear Cup with Black Headband



VGPM8011C • (clamshell)  
Black Ear Cup with Black Headband



VGPM8015C • (clamshell)  
Black Graphite Pattern Ear Cup  
with Black Headband



VGPM8031C • (clamshell)  
Hi-vis Lime Ear Cup with  
Black Headband



VGPM8041C • (clamshell)  
Hi-vis Orange Ear Cup with  
Black Headband



VGPM8063C • (clamshell)  
Teal Ear Cup with Black Headband



VGPM8065C • (clamshell)  
Purple Ear Cup with  
Black Headband

### VG90 Series

NRR 34dB when worn with earplugs



Low-profile ear cup design // Height adjustment to fit all sizes // Fold-away padded headband // Earmuffs (NRR 22dB) are packaged with free disposable earplugs (NRR 32dB) // Available in a VG clamshell



VGPM9010C • (clamshell)  
Gray Ear Cup with Black Headband



VGPM9010PC • (clamshell)  
Pink Ear Cup with Black Headband



VGPM9022C • (clamshell)  
OD Green Ear Cup with Black Headband



VGPM9026C • (clamshell)  
Powder Blue Ear Cup with Black Headband



### VG90 Youth Series

**NRR 19dB**

Low-profile ear cup design // Designed for a slimmer fit // Fold-away padded headband // Available in a VG clamshell

VGPM9011C • (clamshell)  
Blue Ear Cup with Black Headband



### VG10 Series

**NRR 25dB**

Dielectric // Soft padded ear cups // Rotatable nylon headband // Available in a VG clamshell

VGPM1010 • (polybag)  
Navy and Hi-vis Green Ear Cup with Black Headband

VGPM1010C • (clamshell)  
Navy and Hi-vis Green Ear Cup with Black Headband



### VGBH90 Series

**NRR 22dB**

Behind the head earmuffs // Adjustable and durable neckband // Earcups tilt for optimum comfort and efficiency // Available in a VG capture clam

VGBH9010C • (capture clam)  
Gray and Hi-vis Green Ear Cup with Black Neckband

## Ever-Lite® Range Kit

Eyewear meets ANSI Z87.1+, CE EN166 and CSA Z94.3 standards. All lenses are hard coated polycarbonate scratch-resistant and provide 99% protection from harmful UV rays. Earmuffs meet ANSI S3.19 standards.

### Earmuff **NRR 26dB**

Low-profile ear cup design // Height adjustment to fit all sizes // Fold-away padded headband

### Eyewear

Soft nosepiece for snug fit // Lightweight spectacle – 22 gm



VGCOMB08610 (clamshell)  
Clear Lens with Black Frame  
Gray Ear Cup with Black Headband



VGCOMB08617 (clamshell)  
Pink Lens with Black Frame  
Pink Ear Cup with Black Headband



VGCOMB08630 (clamshell)  
Amber Lens with Black Frame  
Gray Ear Cup with Black Headband

## Displays

Hardware included to mount display to slatwall, pegboard or gridwall.

VGDIS9  
Venture Gear Stationary Display - holds up to 9 units (product sold separately)

VGDIS16  
Venture Gear Stationary Display - holds up to 16 units (product sold separately)



## Packaging

Venture Gear products come packaged in either a branded clamshell, capture clam, box or polybag.



Capture Clam

Box

Clamshell

Polybag for Display Box

**i** Packaging design may vary.



Shooting Kit



For years, Ducks Unlimited has been one of the most respected private waterfowl and wetlands conservation organizations, raising over \$1.7 billion for conservation efforts since its inception. Ducks Unlimited applies that same level of dedication to their line of products and accessories. Whether you're hunting or simply out in the habitat, you can trust Ducks Unlimited has you covered. PROTECT OUR LAND.

## Shooting Eyewear

Adjustable rubber nosepiece // Passes Ballistic MIL-PRF-32432 High Velocity Impact standards // Includes microfiber storage bag // Available in a DU clamshell



DUSB6610D •• (clamshell)  
Clear Lens with  
OD Green Frame



DUSB6627D •• (clamshell)  
Vermilion Lens with  
OD Green Frame



DUSB6628D •• (clamshell)  
Forest Gray Lens with  
OD Green Frame

## DUCAB and DUCLAM1

Ventilated, adjustable nosepiece // Temples adjust to four different lengths // Ratcheting lens pitch adjustment // Passes Ballistic MIL-PRF-32432 High Velocity Impact standards // Includes: neoprene case with DU logo, microfiber cleaning bag with DU logo, and five interchangeable lenses // Available in a DU clamshell or box

DUCLAM1 •• (clamshell)  
Clear H2X Anti-fog Lens, Amber H2X Anti-fog Lens, Sun Block Bronze H2X Anti-fog Lens, Orange H2X Anti-fog Lens and Vermilion H2X Anti-fog Lens with Black Frame

DUCAB •• (box)  
Clear H2X Anti-fog Lens, Amber H2X Anti-fog Lens, Sun Block Bronze H2X Anti-fog Lens, Orange H2X Anti-fog Lens and Vermilion H2X Anti-fog Lens with Black Frame





### DUCAB2 and DUCLAM2

Soft nosepiece for snug fit // Semi-frame and slim co-injected temple design for lightweight spectacle – 22 gm // Offers a clear panoramic view without obstruction // Includes: neoprene case with DU logo, microfiber cleaning bag with DU logo, and four interchangeable lenses // Available in a DU clamshell or box

**DUCLAM2 • (clamshell)**  
Clear Lens, Forest Gray Lens, Amber Lens and Vermilion Lens with Black Frame

**DUCAB2 • (box)**  
Clear Lens, Forest Gray Lens, Amber Lens and Vermilion Lens with Black Frame



### DU80 Series

**NRR 26dB**

Low-profile ear cup design // Height adjustment to fit all sizes // Fold-away padded headband // Available in a DU clamshell

**DUPM8010 • (clamshell)**  
Gray Ear Cup with Black Headband

**DUPM8010P • (clamshell)**  
Pink Ear Cup with Black Headband

## Shooting Kits

Eyewear meets ANSI Z87.1+ and Canadian (CSA Z94.3) standards. All lenses are hard coated polycarbonate scratch-resistant and provide 99% protection from harmful UV rays. Earmuff meets ANSI S3.19 standards.

### Earmuff **NRR 26dB**

Low-profile ear cup design // Height adjustment to fit all sizes // Fold-away padded headband

### Eyewear

Ventilated nosepiece is soft and adjustable // Top of frame is ventilated allowing air to circulate // Soft dual-injected rubber temple tips combined with fully adjustable straight back temples reinforce the highest level of comfort and fit



**DUCOMB05710 (clamshell)**  
Clear Lens with Black Frame  
Gray Ear Cup with Black Headband

**DUCOMB05740 (clamshell)**  
Orange Lens with Black Frame  
Gray Ear Cup with Black Headband



Clamshell

## Packaging

Ducks Unlimited products come packaged in either a branded clamshell or box.



Box



Pyramex offers many popular industrial packaged products in a retail branded hang tag polybag, clamshell, polybag or blister card.

## Pyramex Retail Packaged Products

### Capture™ (clamshell)

For more information, see page 85.

PYS9910ST • Clear H2X AF Lens with Clear Temples



### Intrepid II® (clamshell)

For more information, see page 79.

PYSB8810S ••• Clear Lens with Black Temples  
 PYSB8826S ••• Smoke Green Lens with Black Temples  
 PYSB8827S ••• Vermilion Lens with Black Temples



### Onix® (clamshell)

For more information, see page 75.

PYSB4910S ••• Clear Lens with Black Frame  
 PYS4910S ••• Clear Lens with Black and Pink Frame



### Venture 3® (clamshell)

For more information, see page 74.

PYSB5710D •••• Clear Lens with Black Frame  
 PYSB5730D •••• Amber Lens with Black Frame



### PYS25 Combo Kits (polybag)

For more information, see page 81 (Ztek® and Mini Ztek) and 112 (DP1000).

**Ztek** NRR 32dB / SNR 38dB

PYS2510SDP Clear Lens with Clear Temples with Disposable Uncorded Earplugs

PYS2530SDP Amber Lens with Amber Temples with Disposable Uncorded Earplugs

**Mini Ztek** NRR 32dB / SNR 38dB

PYS2510SNDP Clear Lens with Clear Temples with Disposable Uncorded Earplugs

PYS2517SNDP Pink Lens with Pink Temples with Disposable Uncorded Earplugs

PYS2530SNDP Amber Lens with Amber Temples with Disposable Uncorded Earplugs



*Eyewear meets ANSI Z87.1+, European (EN166), and Canadian (CSA Z94.3) standards. All lenses are hard coated polycarbonate scratch-resistant and provide 99% protection from harmful UV rays. Disposable uncorded earplugs meet ANSI S3.19 and CE EN-352:2002 standards.*



### Disposable Uncorded Earplugs (blister card or bin)

For more information, see page 112.

PYDP1000 • 5 Pair of Disposable Uncorded Earplugs in Blister Card  
 PYDP1000BN • 100 Pair of Disposable Uncorded Earplugs in Bin  
 PYDP1000CS • 5 Pair of Disposable Uncorded Earplugs with case in Blister Card

NRR 32dB



### Reusable Corded Earplug (blister card)

For more information, see page 111.

PYRP3001 • Pair of Reusable Corded Earplugs

NRR 26dB



### Dielectric Earmuff (hang tag polybag)

For more information, see page 109.

PYPM2010 • Dielectric Earmuff

NRR 22dB



### N95 Respirators (clamshell)

For more information, see page 54.

PYRM10C 3 Pack of N95 Disposable Particulate Respirator  
 PYRM10VC 1 Pack of N95 Disposable Particulate Respirator with One Way Valve for Easy Exhalation

N10SH - N95



Blister card



Polybag



Clamshell

**i** Packaging design may vary.

# INDUSTRIAL 42 – 143

HEADGEAR 44 – 55

EYEWEAR 56 – 97

WELDING 98 – 105

HEARING 106 – 113

HI-VIS WORK WEAR 114 – 127

GLOVES 128 – 135

COOLING 136 – 139

ERGONOMICS 140 – 143



A



B



C



D

# WHAT YOU NEED TO KNOW

INDUSTRIAL SOLUTIONS

## Offering a full line of PPE

Your safety gear should be tough — deciding on it shouldn't be. When you work with Pyramex, we help you choose the perfect safety solutions for the job.

## Regularly Evolving Our Design

Pyramex was founded on the principle that customer feedback would always guide our product line. Research met with your knowledge places our cutting-edge safety products at the front of the industry.

## Customers Remaining Top Priority

Knowing our customers on a personal level allows us to anticipate your needs. We work to make finding the right safety solutions a painless process, regardless of where you are in the world. With Pyramex, not only can you customize your products, but we're also bringing imprinting in house to more feasibly accommodate your business. More so, when you call us, you'll always speak with a specialist who understands your goals. The same goes for our new non-automated live web chat. We thrive when you succeed.

## Certifications

### Headgear

Our headgear products have been independently tested for various standards and certifications. Use the quick key (ANSI • CSA •) to reference product models that meet these standards and certifications. Use the dots next to each part number to reference which options meet the standards and certifications. See page 45 for more information on headgear certifications.

### Eyewear

Our eyewear has been independently tested for various standards and certifications. Use the quick key (ANSI • CE • CSA • AS • Ballistic •) to reference product models that meet these standards and certifications. Use the dots next to each part number to reference which options meet the standards and certifications. See page 57 for more information on eyewear certifications.

### Welding

Welding products have been independently tested for various standards and certifications. Use the quick key (ANSI • CE • CSA •) to reference product models that meet these standards and certifications. Use the dots next to each part number to reference which options meet the standards and certifications. See page 99 for more information on welding certifications.

### Hearing

Our hearing products have been independently tested for various standards and certifications. Use the quick key (ANSI • CE •) to reference product models that meet these standards and certifications. Use the dots next to each part number to reference which options meet the standards and certifications. See page 107 for more information on hearing certifications.

### Hi-vis Work Wear

Our hi-vis work wear has been independently tested for various standards and certifications. Use the quick key (ANSI • CSA •) on the following pages to reference product models that meet these standards and certifications. Use the dots next to each part number to reference which options meet the standards and certifications. See page 115 for more information on hi-vis certifications.

### Gloves

Our gloves have been independently tested for various standards and certifications. Use the quick key (ANSI • CE •) on the following pages to reference product models that meet these standards and certifications. Use the dots next to each part number to reference which options meet the standards and certifications. See page 129 for more information on glove certifications.

## Our Trusted Brands



A – Ridgeline® / V2G®

B – Ridgeline® / Proximity® / BP3000 / RVZ2420SE / GL802CR

C – GL802CR

D – WHAM3030AE

# HEADGEAR 44 – 55

RIDGELINE® 46 – 47

SL SERIES 48 – 49

BASEBALL BUMP CAPS 49

ACCESSORIES 50

ADAPTERS 50 – 51

FACE SHIELDS 51 – 52

KITS 53

N95 RESPIRATORS 54

BALACLAVA 54



A



B



C

A – Ridgeline / Reflective Hard Hat Stickers / Highlander™ Plus / HPCSTRAP / RLTS3110

B – S1110 / HGBR

C – Ridgeline / Atwater™ / DP3000 / RVZ2110

# WHAT YOU NEED TO KNOW

## Headgear Certifications

Pyramex headgear products have been independently tested for various standards and certifications. Use the quick key (ANSI • CSA •) on the following pages to reference product models that meet these standards and certifications. Use the dots next to each part number to reference which options meet the standards and certifications.

- ANSI Z89.1 (hard hats) •
- ANSI Z87.1 (brackets and face shields) •
- ANSI Z87.1+ (polycarbonate face shields) •
- Cert. Mod. - CAN/CSA Z94.1-15 (third-party certification) •

## ANSI/ISEA Z89.1 & CSA Z94.1 - 2015

### TYPE 1 – TOP IMPACT

ANSI: Type I hard hat is designed to reduce the force of impact on top of the head.  
 CSA: Type I hard hat provides impact and penetration protection for the crown only.

### CLASS E – ELECTRICAL HIGH-VOLTAGE / NON-CONDUCTING

Class E hard hats are intended to protect against falling objects and reduce the risk of exposure to high-voltage electrical shocks and burns. Class E offers the highest protection with high-voltage shock and burn protection up to 20,000 volts.

### CLASS G – GENERAL LIMITED VOLTAGE / NON-CONDUCTING

Class G hard hats are intended to protect against falling objects and reduce the risk of exposure to low voltage electrical conductors. Class G offers impact and penetration resistance and protection from up to 2,200 volts.

### Class C – Conductive

Class C hard hats are not intended to protect against electrical danger.  
 Class C offers lightweight comfort and impact protection.

## Selection Chart

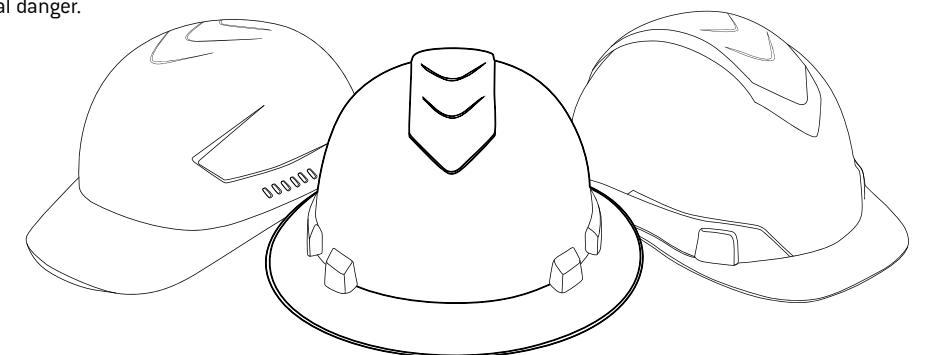
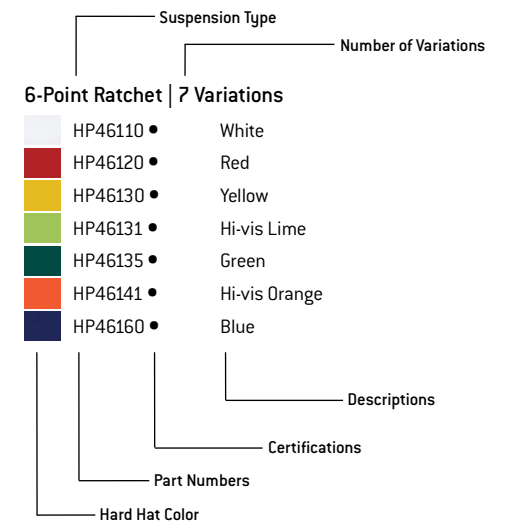



# HARD HATS & BUMP CAPS

Quality head protection is a staple in a number of work environments. Select a brand you can trust –Pyramex Safety Ridgeline®– for expertly designed, high-performing hard hats and bump caps. Find what you need for everything from general all-purpose work use to conductive fieldwork settings.



Ridgeline® / Torser™ / RJ3210 / CorXcel®



### 4-Point Ratchet | 15 Variations

- HP44110 • White
- HP44110C • White
- HP44112 • Gray
- HP44113 • Slate Gray
- HP44120 • Red
- HP44130 • Yellow
- HP44130C • Yellow
- HP44131 • Hi-vis Lime
- HP44131C • Hi-vis Lime
- HP44135 • Green
- HP44141 • Hi-vis Orange
- HP44160 • Blue
- HP44162 • Light Blue
- HP44165C • Dark Blue
- HP44170 • Hi-vis Pink

### Vented 4-Point Ratchet | 7 Variations

- HP44110V • White
- HP44112V • Gray
- HP44120V • Red
- HP44130V • Yellow
- HP44131V • Hi-vis Lime
- HP44141V • Hi-vis Orange
- HP44160V • Blue

### 6-Point Ratchet | 7 Variations

- HP46110 • White
- HP46120 • Red
- HP46130 • Yellow
- HP46131 • Hi-vis Lime
- HP46135 • Green
- HP46141 • Hi-vis Orange
- HP46160 • Blue



## Ridgeline® Full Brim ANSI • CSA •

ABS material // Ratchet suspension // 4-point ratchet suspension may be converted to 6-point ratchet suspension with optional strap [HP6PTSUS] // Replaceable ratchet suspensions available // Replaceable sweat band // Ridgeline full brim hard hats pass high temperature [HT] and low temperature [LT] // Non-vented options meet Class E, G, and C // Vented options meet Class C // Hi-vis colors have been tested for the HV mark // Custom imprinting available

### 4-Point Ratchet | 11 Variations

- HP54110 • White
- HP54111 • Black
- HP54112 • Gray
- HP54113 • Slate Gray
- HP54120 • Red
- HP54130 • Yellow
- HP54131 • Hi-vis Lime
- HP54135 • Green
- HP54141 • Hi-vis Orange
- HP54160 • Blue
- HP54170 • Hi-vis Pink

### Vented 4-Point Ratchet | 5 Variations

- HP54110V • White
- HP54113V • Slate Gray
- HP54130V • Yellow
- HP54141V • Hi-vis Orange
- HP54160V • Blue

### 6-Point Ratchet | 5 Variations

- HP56110 • White
- HP56120 • Red
- HP56130 • Yellow
- HP56135 • Green
- HP56160 • Blue



## Ridgeline Bump Caps NON-RATED

Polyethylene material // For applications where hard hats are not required, but some protection from minor bumps and scalp lacerations are needed // Available with 4-point glide lock suspension // Ventilation holes // Replaceable sweat band // Not designed to meet the safety standards for industrial head protection // Custom imprinting available

### 4-Point Glide Lock | 9 Variations

- HP40010 • White
- HP40011 • Black
- HP40012 • Gray
- HP40015 • Brown
- HP40020 • Red
- HP40030 • Yellow
- HP40035 • Green
- HP40040 • Orange
- HP40060 • Blue

## Ridgeline® Cap Style ANSI • CSA • [with clip only]

ABS material // Low profile design // Available with 4- and 6-point ratchet suspensions // Swinging hinge points // 4-position harness points // Easy to grasp knob adjusts the suspension from 6½ to 8 head size // Rear padded suspension // Replaceable ratchet suspensions available // Replaceable sweat band // Vented pressure pad // Universal accessory slots fit cap mounted earmuffs and accessories // Ridgeline cap style hard hats pass reverse orientation, high temperature [HT] and low temperature [LT] // Non-vented options meet Class E, G, and C // Vented options meet Class C // Hi-vis colors have been tested for the HV mark // Custom imprinting available



WATCH THE VIDEO  
Vimeo.com/Pyramex/Ridgeline



HP44110C | HP44117C | HP44130C | HP44131C | HP44165C  
Ridgeline Cap Style with side clips to meet CSA standards.



## Ridgeline Hydro Dipped ANSI • CSA •

### Cap Style 4-Point Ratchet | 9 Variations

- HP44116 • Matte White Graphite Pattern
- HP44116S • Shiny White Graphite Pattern
- HP44117 • Matte Black Graphite Pattern
- HP44117C • Matte Black Graphite Pattern
- HP44117S • Shiny Black Graphite Pattern
- HP44118 • Matte Copper Pattern
- HP44119 • Matte Camo Pattern
- HP44MIX • HP44116 [4], HP44117 [4], HP44118 [4] and HP44119 [4]
- HP44MIXS • HP44116S [8] and HP44117S [8]

### Full Brim 4-Point Ratchet | 8 Variations

- HP54116 • Matte White Graphite Pattern
- HP54116S • Shiny White Graphite Pattern
- HP54117 • Matte Black Graphite Pattern
- HP54117S • Shiny Black Graphite Pattern
- HP54118 • Matte Copper Pattern
- HP54119 • Matte Camo Pattern
- HP54MIX • HP54116 [3], HP54117 [3], HP54118 [3] and HP54119 [3]
- HP54MIXS • HP54116S [6] and HP54117S [6]

### Cap Style Vented 4-Point Ratchet | 2 Variations

- HP44116SV • Shiny White Graphite Pattern
- HP44117V • Matte Black Graphite Pattern

### Full Brim Vented 4-Point Ratchet | 1 Variation

- HP54117V • Matte Black Graphite Pattern

## Ridgeline Accessories



HPR441  
Cap Style 4-point Ratchet  
Replacement Suspension



HPR461  
Cap Style 6-point Ratchet  
Replacement Suspension



HPR541  
Full Brim 4-point Ratchet  
Replacement Suspension



HP6PTSUS  
6-point Ratchet Replacement Suspension Strap



HPRBANDR  
Ridgeline Cap Style and Full Brim Hard Hat Sweat Band



BPRBAND  
Bump Cap Sweat Band



# SL SERIES

## HARD HATS & BASEBALL BUMP CAPS

Whether you need head protection with classic safety features or style with a little added protection, you can find what you're looking for with SL Series hard hats. The ultra-customizable SL Series Cap Style has four different suspension and adjustment combinations to meet your specific needs, while the Sleek Shell provides protection for those who prefer safety features at face value with a mold designed to fit tight areas. Baseball Bump Cap's outer cap is fully washable for ultimate longevity.



SL Cap Style / Ztek® Readers

### SL Series Cap Style ANSI • CSA •

Low profile design // High density polyethylene materials // Rain trough // Universal accessory slots fit cap mounted earmuffs and accessories // Available with 4- and 6-point nylon suspensions – snap lock and ratchet styles // Replaceable ratchet suspensions available // Replaceable sweat band // SL Series cap style hard hats pass for reverse orientation and low temperature [LT] // Options meet Class E, G, and C // Hi-vis colors have been tested for the HV mark // Custom imprinting available



#### 4-Point Ratchet | 13 Variations

HP14110 ••	White
HP14111 ••	Black
HP14112 ••	Gray
HP14120 ••	Red
HP14130 ••	Yellow
HP14131 ••	Hi-vis Lime
HP14135 ••	Green
HP14140 ••	Orange
HP14141 ••	Hi-vis Orange
HP14160 ••	Blue
HP14162 ••	Light Blue
HP14165 ••	Dark Blue
HP14170 ••	Hi-vis Pink

#### 6-Point Ratchet | 7 Variations

HP16110 •	White
HP16120 •	Red
HP16130 •	Yellow
HP16135 •	Green
HP16140 •	Orange
HP16141 •	Hi-vis Orange
HP16160 •	Blue

#### 4-Point Snap Lock | 8 Variations

HP14010 •	White
HP14020 •	Red
HP14030 •	Yellow
HP14031 •	Hi-vis Lime
HP14035 •	Green
HP14040 •	Orange
HP14060 •	Blue
HP14062 •	Light Blue

#### 6-Point Snap Lock | 6 Variations

HP16010 •	White
HP16020 •	Red
HP16030 •	Yellow
HP16035 •	Green
HP16040 •	Orange
HP16060 •	Blue

### SL Series Accessories



HP141  
Cap Style 4-point  
Ratchet Replacement  
Suspension



HP161  
Cap Style 6-point  
Ratchet Replacement  
Suspension



HP241  
Full Brim 4-point  
Ratchet Replacement  
Suspension



HP261  
Full Brim 6-point  
Ratchet Replacement  
Suspension



HPCSTRAP  
Chin Strap



HHBAND  
SL Series Cap Style and Full  
Brim Hard Hat Sweat Band



HPTRBAN  
Universal Hard Hat Terry Cloth  
Sweat Band



### SL Series Full Brim ANSI • CSA •

High density polyethylene materials // Available with 4- and 6-point ratchet suspensions // Replaceable suspensions and headbands available // SL Series full brim hard hats pass low temperature [LT] // Options meet Class E, G, and C // Hi-vis colors have been tested for the HV mark // Custom imprinting available

#### 4-Point Ratchet | 9 Variations

HP24110 ••	White
HP24111 ••	Black
HP24120 ••	Red
HP24130 ••	Yellow
HP24131 ••	Hi-vis Lime
HP24135 ••	Green
HP24140 ••	Orange
HP24141 ••	Hi-vis Orange
HP24160 ••	Blue

#### 6-Point Ratchet | 6 Variations

HP26110 •	White
HP26120 •	Red
HP26130 •	Yellow
HP26135 •	Green
HP26140 •	Orange
HP26160 •	Blue



### Baseball Bump Caps NON-RATED

Bump cap and baseball cap in one // Reflective piping adds extra visibility // Soft inner foam cushion // Adjustable size // Polyethylene vented shell is removable and the outer cap is fully washable // Ventilation holes // Ideal for meter readers, food processors, and other industries that don't require full hard hat protection // Not designed to meet the safety standards for industrial head protection // Custom imprinting available

#### 4 Variations

HP50011	Black
HP50031	Hi-vis Lime
HP50041	Hi-vis Orange
HP50065	Navy



HP500REP  
Replacement Insert



### SL Series Sleek Shell ANSI •

Ideal for linemen // Polyethylene materials // Seamless low profile design // 4-point ratchet suspension // No rain trough // Soft brow pad // Options meet Class E, G, and C // Custom imprinting available

#### Cap Style

##### 4-Point Ratchet | 5 Variations

HPS14110 •	White
HPS14112 •	Gray
HPS14120 •	Red
HPS14130 •	Yellow
HPS14160 •	Blue

#### Full Brim

##### 4-Point Ratchet | 5 Variations

HPS24110 •	White
HPS24112 •	Gray
HPS24120 •	Red
HPS24130 •	Yellow
HPS24160 •	Blue

HPSSUS

Not shown – 4-point Replacement Suspension



Baseball Bump Caps / Itek® / BP3000

# HEADGEAR ACCESSORIES



## Hard Hat ID Sticker NON-RATED



Sticker stores medical info and emergency contacts // Fixes securely to hard hat // Tamper-proof seal // 3M Scotchlite™ reflective material // Water and weather resistant

HPID ID Sticker



## Reflective Hard Hat Stickers NON-RATED

Microprismatic vinyl stickers increase visibility // Self-adhesive back with a peel-off liner for easy application // 16 stickers per sheet // Shown with Ridgeline® hard hat – sold separately

	HVRSLM	Hi-vis Lime
	HVRSOR	Hi-vis Orange
	HVRSWH	White



## Headlamp NON-RATED

High power LED headlamp // Rotatable head // Waterproof // Screw fastener for safety precautions // Adjustable strap // High mode (200 lumens) and low mode (100 lumens) functions // Powered with three size AAA alkaline batteries – not included // Hex wrench is included for battery replacement // Shown with Ridgeline hard hat – sold separately

HL100 LED Headlamp  Headlamp is intrinsically safe for use in hazardous locations.



## Deluxe Aluminum Cap Style Adapter

ANSI •  
Constructed from light weight aluminum // Designed to fit more rounded cap style hard hats // Accommodates a variety of face shields – does not fit S1060

HHAD •



## Aluminum Full Brim Adapter

ANSI •  
Constructed from lightweight aluminum // Fits most full brim hard hats and accommodates a variety of face shields

HHAAW •



## Cap Style Adapter

ANSI •  
Constructed from durable nylon with plastic coated tension spring // Fits most cap style hard hats and accommodates a variety of face shields

HHAB •



## Dielectric Cap Style Adapter

ANSI •  
Dielectric // Constructed from 100% nylon material // Fits most cap style hard hats and accommodates a variety of face shields

HHAN •

# HEADGEAR ADAPTERS & FACE SHIELDS



## Ridgeline® Cap Style Adapter

ANSI •  
Fits Ridgeline cap style hard hats and accommodates a variety of face shields // Dielectric // Hard hat adapters fit into slots of cap style hard hats // Use with cap mounted earmuff (CM6010) // Adjustable while using cap mounted earmuff // Hard hat and earmuff sold separately

HHABCMR •



## SL Series Cap Style Adapter

ANSI •  
Fits SL Series cap style hard hats and accommodates a variety of face shields // Dielectric // Hard hat adapters fit into slots of cap style hard hats // Use with cap mounted earmuff (CM6010) // Adjustable while using cap mounted earmuff // Hard hat and earmuff sold separately

HHABCMS •



## Aluminum Cap Style Adapter

ANSI •  
Constructed from lightweight aluminum // Fits most cap style hard hats and accommodates a variety of face shields

HHAA •



## Dielectric Full Brim Adapter

ANSI •  
Dielectric // Constructed from high impact resistant ABS resin // Fits most full brim hard hats and accommodates a variety of face shields

HHABW •



## Polyethylene Face Shield

ANSI •  
Meets ANSI Z87.1 // 8" x 15" | .040" thick // Universal slots will accommodate a wide variety of headgear // Shown with HGBR - sold separately

S1010 •



## Aluminum Bound Polyethylene Face Shield

ANSI •  
Meets ANSI Z87.1 // 8" x 15" | .040" thick // Aluminum bound allows shield to bend into preferred shape // Universal slots will accommodate a wide variety of headgear // Shown with HGBR – sold separately

S1015 •



## Dark Green Tinted Polyethylene Face Shield

ANSI •  
Meets ANSI Z87.1 // 8" x 15" | .040" thick // Not IR resin – use for heat and glare // Universal slots will accommodate a wide variety of headgear // Shown with HGBR – sold separately

S1035 •



## Polycarbonate Face Shield

ANSI •  
Meets ANSI Z87.1+ // 8" x 15" | .040" thick // Provides 99% UVA/B/C protection // Universal slots will accommodate a wide variety of headgear // Shown with HGBR – sold separately

S1020 •



## Aluminum Bound Polycarbonate Face Shield

ANSI •  
Meets ANSI Z87.1+ // 8" x 15" | .040" thick // Aluminum bound allows shield to bend into preferred shape // Provides 99% UVA/B/C protection // Universal slots will accommodate a wide variety of headgear // Shown with HGBR – sold separately

S1040 •



## Tapered Polycarbonate Face Shield

ANSI •  
Meets ANSI Z87.1+ // 8" x 15" | .078" thick // Provides 99% UVA/B/C protection // Universal slots will accommodate a wide variety of headgear // Shown with HGBR – sold separately

S1110 •



## Cylinder Polycarbonate Face Shield

ANSI •  
Meets ANSI Z87.1+ // 8" x 15.5" | .078" thick // Provides 99% UVA/B/C protection // Universal slots will accommodate a wide variety of headgear // Shown with HGBR – sold separately

S1210 •

# HEADGEAR FACE SHIELDS & HEADGEAR



## Tapered IR5 Polycarbonate Face Shield

ANSI •  
Meets ANSI Z87.1+ // 8" x 15.5" | .078" thick // Provides 99% UVA/B/C protection // Universal slots will accommodate a wide variety of headgear // Shown with HGBR – sold separately

S1150 •



## Cylinder IR5 Polycarbonate Face Shield

ANSI •  
Meets ANSI Z87.1+ // 8" x 15.5" | .078" thick // Provides 99% UVA/B/C protection // Universal slots will accommodate a wide variety of headgear // Shown with HGBR – sold separately

S1250 •



## Steel Wire Mesh Face Shield

ANSI •  
Meets ANSI Z87.1+ for high impact only // 8" x 15.5" // Provides good airflow for comfort // Does not accommodate the HHAAD hard hat adapter // Shown with HGBR – sold separately

S1060 •



HGBR / S1110 / Intruder®



## Cylinder Polycarbonate Face Shield with slots for Chin Cup

ANSI •  
Meets ANSI Z87.1+ // 8" x 15.5" | .078" thick // Provides 99% UVA/B/C protection // Universal slots will accommodate a wide variety of headgear // Accessory slots on bottom accommodate CHICUP – sold separately

S1210CC •



## Chin Protector for S1210CC

NON-RATED  
8.46" x 2.74" | 0.09" thick // Accommodates S1210CC – sold separately

CHICUP



## Ridgeline® Ratchet Headgear

ANSI •  
Meets ANSI Z87.1+ // Constructed from durable nylon // Ratchet adjustment for easy fit // Pivoting action allows user to lift face shield while wearing // Adjustable pegs will accommodate a wide variety of face shields

HGBR •



## Face Shield & Ridgeline Ratchet Headgear Combo

ANSI •  
Aluminum Bound Polycarbonate Face Shield with Ridgeline® Ratchet Headgear in a packaged combo kit // See page 52 for HGBR features // See page 51 for S1040 features

HGBRKITCS •

**i** Face shields offer secondary protection and must be worn with spectacles or goggles.

# HEADGEAR KITS

## New Hire Kits

Intruder® – S4110S clear lens or S4120S gray lens // RVZ2110 lime or orange RVZ2120 Type R Class 2 vest // SL Series hard hat – HP14010 white cap style with 4-point snap lock suspension or HP24110 white full brim 4-point ratchet suspension // DP1001 disposable corded earplugs – NRR 32dB SNR 37dB // GL401L Poly-Torq™ polyurethane gloves – 13 gauge nylon liner



## SL Series Cap Style | 10 Variations

NHCM	HP14010 / S4110S / DP1001 / RVZ2110M / GL401L
NHCL	HP14010 / S4110S / DP1001 / RVZ2110L / GL401L
NHCXL	HP14010 / S4110S / DP1001 / RVZ2110XL / GL401L
NHCX2	HP14010 / S4110S / DP1001 / RVZ2110X2 / GL401L
NHGL	HP14010 / S4120S / DP1001 / RVZ2110L / GL401L
NHGXL	HP14010 / S4120S / DP1001 / RVZ2110XL / GL401L
NHGX2	HP14010 / S4120S / DP1001 / RVZ2110X2 / GL401L
NHCORM	HP14010 / S4110S / DP1001 / RVZ2120M / GL401L
NHCORL	HP14010 / S4110S / DP1001 / RVZ2120L / GL401L
NHCORXL	HP14010 / S4110S / DP1001 / RVZ2120XL / GL401L

## SL Series Full Brim | 4 Variations

NHCL	HP24110 / S4110S / DP1001 / RVZ2110L / GL401L
NHCXL	HP24110 / S4110S / DP1001 / RVZ2110XL / GL401L
NHGL	HP24110 / S4120S / DP1001 / RVZ2110L / GL401L
NHGXL	HP24110 / S4120S / DP1001 / RVZ2110XL / GL401L

Intruder meets ANSI Z87.1+, CE EN166, CSA Z94.3 and AS/NZS 1337 standards. All lenses are hard coated polycarbonate scratch-resistant and provide 99% protection from harmful UV rays. Hi-vis work wear meets ANSI/ISEA 107-2015 Type R Class 2 standards. SL series hard hats meet ANSI Z89.1, CSA Z94.1 - 2015, Type 1, Class C, G, and E for industrial head protection standards. Disposable corded earplugs meet ANSI S3.19 and CE EN-352:2002 standards. Gloves meet European EN388:2003 and EN388:2016 standards. Contents are subject to change.



## Ridgeline® Forestry Kits

HHABCMR Ridgeline ratchet headgear // HP44110 white Ridgeline cap style hard hat with 4-point ratchet suspension or HP44141 hi-vis orange Ridgeline cap style hard hat with 4-point ratchet suspension // CM6010 cap mounted earmuff – NRR 27dB // S1060 steel wire mesh face shield

## Ridgeline Cap Style | 2 Variations

FORKIT10	HP44110 / HHABCMR / S1060 / CM6010
FORKIT41	HP44141 / HHABCMR / S1060 / CM6010

Ridgeline headgear meets ANSI Z87.1 standards. Ridgeline hard hat meets ANSI Z89.1, Type 1, Class C, G, and E for industrial head protection standards. Cap mounted earmuff meets ANSI S3.19 standards. Face shield meets ANSI Z87.1 standards for wire mesh. Face shield offers secondary protection and must be worn with spectacles or goggles.



## SL Series Forestry Kits

HHABCMS SL series ratchet headgear // HP14110 white SL series cap style hard hat with 4-point ratchet suspension or HP14141 hi-vis orange SL series cap style hard hat with 4-point ratchet suspension // CM6010 cap mounted earmuff – NRR 27dB // S1060 steel wire mesh face shield

## SL Series Cap Style | 2 Variations

FORKIT10SL	HP14110 / HHABCMS / S1060 / CM6010
FORKIT41SL	HP14141 / HHABCMS / S1060 / CM6010

SL series headgear meets ANSI Z87.1 standards. SL series hard hats meet ANSI Z89.1, CSA Z94.1 - 2015, Type 1, Class C, G, and E for industrial head protection standards. Cap mounted earmuff meets ANSI S3.19 standards. Face shield meets ANSI Z87.1 standards for wire mesh. Face shield offers secondary protection and must be worn with spectacles or goggles.

# HEADGEAR N95 RESPIRATORS

## Disposable Particulate Respirators

N95 – 95% efficient respiratory protection in non-oil areas // Ultrasonically welded straps eliminate the need for staples // Straps are latex free // Shell is durable and keeps structure under heavy humidity // Soft, smooth outer and inner layer is comfortable on the skin // Inner foam strip reduces the potential for eyewear fogging // Outer aluminum adjustable nosepiece holds shape for proper fit

### N95 Particulate Respirator | 2 Variations

RM10 One Size Fits Most  
PYRM10C\* One Size Fits Most

### N95 Particulate Respirator with One Way Valve | 2 Variations

RM10V One Size Fits Most  
PYRM10VC\* One Size Fits Most

**i** N95 Respirators retail packaged products\* on page 41.



#### Use Against

NIOSH approved for protection against particulate aerosols free of oils. Pyramex recommends this respirator for use against particulates containing materials such as flour, iron ore, coal and minerals.

#### Do Not Use Against

Vapors, paint spray, oil-based aerosols, asbestos and sand blasting. Any contaminant whose concentration is unknown, or immediately dangerous to life. Concentrations of dust and mists which exceed the maximum use of concentration or 10 times contaminant's permissible exposure limit established by OSHA.



Disposable Respirators meet the NIOSH standard for N95 particulate respirators.

# HEADGEAR BALACLAVA



## Balaclava NON-RATED



Balaclava can be worn in a variety of ways from face mask to neck gaiter // Mesh breathing panels increase airflow while minimizing condensation on your eyewear // Self-extinguishing thermal fleece and mesh material

### 2 Variations

BL111 Black One Size Fits Most  
BL140 Hi-vis Orange



Ridgeline® / Atwater™ / RM10 / RTS2110B / GL102

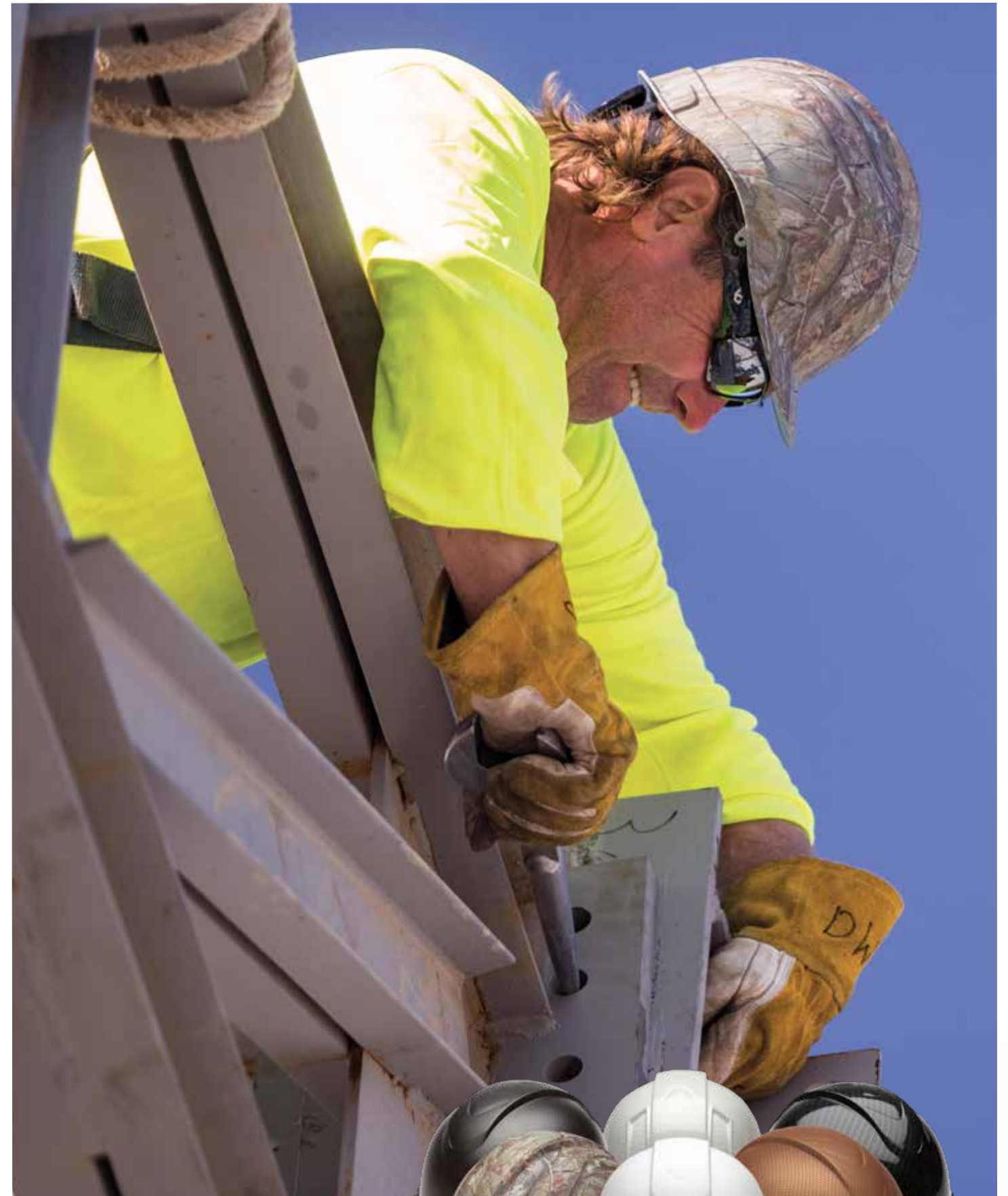

## HYDRO DIPPED HARD HATS

For more information, see page 46 and 47.

HP44117

HP44119

HP44116S HP44116

HP44118

HP44117S

# EYEWEAR 56 – 97

LENS TREATMENTS & COLORS 58 – 59

SEALED & FOAM PADDED 60 – 65

FULL FRAME 66 – 69

HALF FRAME 70 – 77

FRAMELESS 78 – 83

OVER THE SPECTACLE 84 – 85

READERS 86 – 89

GOGGLES 90 – 95

ACCESSORIES 96 – 97



A



B



C

# WHAT YOU NEED TO KNOW

## Eyewear Features

Use the icons below to quickly find some of the most requested features for safety eyewear.

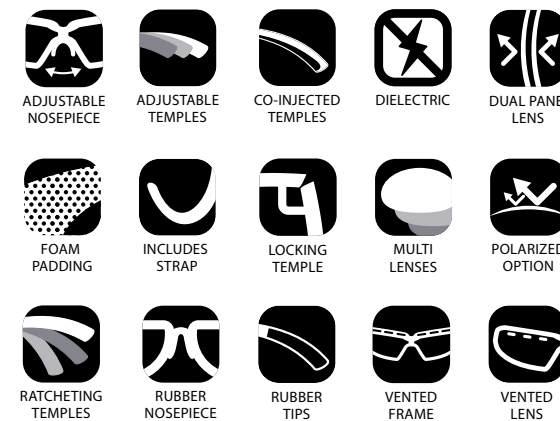

## Eyewear Certifications

Pyramex eyewear has been independently tested for various standards and certifications. Use the quick key (ANSI • CE • CSA • AS • Ballistic • ) on the following pages to reference product models that meet these standards and certifications. Use the dots next to each part number to reference which options meet the standards and certifications.

ANSI Z87.1+ High Impact	•
CE EN166	•
Cert. Mod. - CAN/CSA Z94.3-15  third-party certification	•
AS/NZS 1337	•
MIL-PRF-32432 High Velocity Impact Standards	•

## Selection Chart

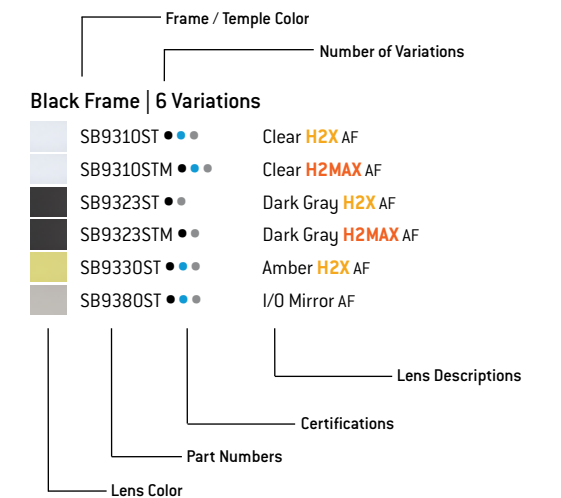

## Marking Confirmations

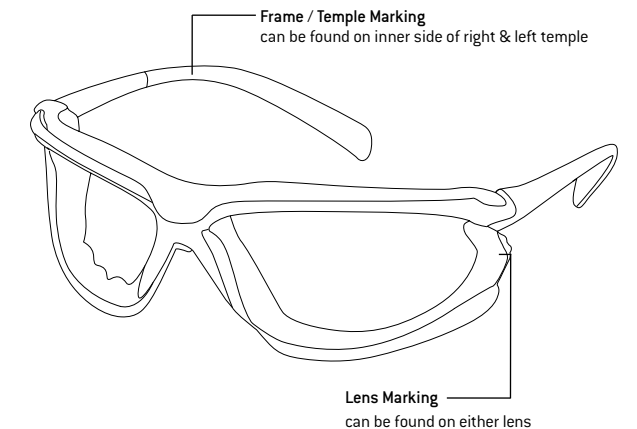

# EYEWEAR LENSES

## Lens Treatments

### H2MAX Anti-fog Coating

The innovative technology behind the H2MAX creates a high performing, superior anti-fog coating that is durable enough to withstand repeated cleanings without losing adhesion. Not only does this premium treatment ensure maximum clarity in the most extreme temperature and humid conditions, but it also adds a layer to the lens that is abrasion and chemical resistant. The H2MAX anti-fog coating is made from non-hazardous environmental components. Coating resists scratching from steel wool up to 100g weight. H2MAX passes ANSI Z87.1 standards, CE standards for N and K, and Canadian certification CAN/CSA Z94.3.

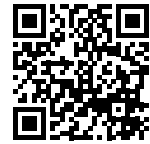

**i** H2MAX products can be cleaned with Pyramex lens cleaning towelettes. Do not use abrasive cleaning compounds, solvents, ammonia, or alkaline cleaners.

### WATCH THE VIDEO

Vimeo.com/Pyramex/H2MAX

### H2X Anti-fog Coating

H2X provides anti-fog, anti-scratch, and anti-static protection. Even after repeated cleanings, H2X will continue to be effective because, the coating is bonded to the lenses. The H2X anti-fog coating is made from non-hazardous environmental components. Coating is waterproof with excellent scratch resistance. H2X passes ANSI Z87.1 standards and Canadian certification CAN/CSA Z94.3.

## Lens Technology

### Polycarbonate

All Pyramex safety eyewear utilize polycarbonate lenses. Polycarbonate lenses are up to 10 times more impact-resistant than plastic or glass lenses and provide 99% protection from the sun's harmful UV rays. They are lightweight and include a scratch-resistant coating to prevent surface scratches.

### Polarized

Polarized lenses eliminate glare, increase visual clarity and enhance contrast all while reducing eye strain. We offer polarized options in forest gray, sky red mirror, green mirror, blue mirror and gray.

### Photochromic

Photochromic lenses change from clear to dark, after exposed to direct UV light. Changes from dark to clear, after removed from UV light.



Ridgeline® / Proximity® / RVHL2510BRD

## Lens Colors and VLT

When light passes through a lens, some of it is absorbed and some of it is reflected back. The amount of light that passes through is known as the visible light transmission (VLT) and is represented by a percentage. Lens colors with a higher percentage of VLT will be lighter and allow more light to pass through, while lens colors with a lower percentage of VLT will be darker, blocking more light from reaching your eyes.

94% Clear	51% I/O Mirror	20% Sun Block Bronze	11% Smoke Green Mirror
89% Amber	43% Purple Haze	18% Antique Mirror	10% Forest Gray
84% Photochromic	38% Vermilion	18% Blue Mirror	10% Ice Orange Mirror
82% Pink	27% Coffee	18% Gold Mirror	10% Smoke Green
71% Infinity Blue	27% Multi-color Mirror	18% Green Mirror	7% Dark Gray
66% 1.5 IR Filter	27% Sandstone Bronze	18% Silver Mirror	2% 5.0 IR Filter
64% Arc	27% Shooter's Amber	14% Sky Red Mirror	
61% Orange	23% Bronze	13% Ice Blue Mirror	
52% Light Gray	23% Gray	11% 3.0 IR Filter	

## Applications

Use our suggested lens color guide to help decide which lens is best for the task at hand.

### Outdoor Use

- Light Gray
- I/O Mirror
- Coffee
- Multi-color Mirror
- Sandstone Bronze
- Gray
- Sun Block Bronze
- Blue Mirror
- Gold Mirror
- Green Mirror
- Silver Mirror
- Sky Red Mirror
- Ice Blue Mirror
- Smoke Green Mirror
- Forest Gray
- Ice Orange Mirror
- Smoke Green
- Dark Gray
- Polarized Gray
- Polarized Blue Mirror
- Polarized Green Mirror
- Polarized Sky Red Mirror
- Polarized Forest Gray

### Excessive Glare

- Light Gray
- I/O Mirror
- Gray
- Blue Mirror
- Gold Mirror
- Green Mirror
- Silver Mirror
- Sky Red Mirror
- Ice Blue Mirror
- Forest Gray
- Ice Orange Mirror
- Dark Gray
- Polarized Gray
- Polarized Blue Mirror
- Polarized Green Mirror
- Polarized Sky Red Mirror
- Polarized Forest Gray

### Indoor Use

- Clear
- Amber
- Pink
- Infinity Blue
- Orange
- I/O Mirror
- Purple Haze

### Low Light

- Amber
- Pink
- Infinity Blue
- Orange
- Purple Haze
- Shooter's Amber
- Sun Block Bronze

### Enhance Contrast

- Amber
- Pink
- Infinity Blue
- Orange
- Purple Haze
- Vermilion
- Sandstone Bronze
- Shooter's Amber

### Welding

- 1.5 IR Filter
- Arc
- 3.0 IR Filter
- 5.0 IR Filter

**i** 1.5 IR is designed for peripheral personnel and visitors who are NOT exposed to direct IR radiation. Arc is great for use under the welding helmet – allowing welder to see work clearly without suffering "welder's flash burn" from surrounding welders.

# EYEWEAR SEALED & FOAM PADDED

Sealed and foam padded eyewear are often ideal options for dusty or windy work environments. Many of our sealed and foam padded eyewear products also come with features like sealed rubber gaskets, interchangeable temples, and goggle straps which make them easily customizable.



Ridgeline® / CM6010 / I-Force / RTS2110B / GL801

## I-Force® and I-Force Slim

ANSI • CE • CSA • AS • Ballistic •

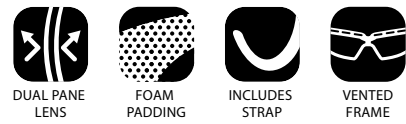

Dual pane lens // Outer polycarbonate lens protects against the environment, while inner acetate lens prevents fogging // Outside lens is coated with anti-fog treatment // Quick release interchangeable temples and strap // Removable vented flame resistant foam carriage // Passes Ballistic MIL-PRF-32432 High Velocity Impact standards

### I-Force Black Frame | 4 Variations

- SB7010SDT ••••• Clear Dual Pane **H2X** AF
- SB7020SDT ••••• Gray Dual Pane **H2X** AF
- SB7030SDT ••••• Amber Dual Pane **H2X** AF
- SB7080SDT ••••• I/O Mirror Dual Pane AF

### I-Force Slim Black Frame | 3 Variations

- SB7010SDNT ••••• Clear Dual Pane **H2X** AF
- SB7020SDNT ••••• Gray Dual Pane **H2X** AF
- SB7080SDNT ••••• I/O Mirror Dual Pane AF



148 mm



157 mm



**WATCH THE VIDEO**

Vimeo.com/Pyramex/I-Force

**i** I-Force Slim is about 6% smaller than the I-Force.



## Isotope™ ANSI • CE • CSA • Ballistic •



Dielectric // Interchangeable temples and neoprene strap // Temples adjust to three different lengths // Dual frame design features a rubber gasket // Passes Ballistic MIL-PRF-32432 High Velocity Impact standards when worn with strap // Passes D3: Droplet and Splash Test when worn with strap

### Black Frame | 4 Variations

- GB9410STM ••••• Clear **H2MAX** AF
- GB9420STM ••••• Gray **H2MAX** AF
- GB9430STM ••••• Amber **H2MAX** AF
- GB9480ST ••••• I/O Mirror AF



**WATCH THE VIDEO**

Vimeo.com/Pyramex/Isotope



Isotope / RP3001 / GL201

## Torser™ ANSI • CE • CSA •



DIELECTRIC

Dielectric // Flexible rubber gasket // Ratchet elastic headband with quick-fit retainer // Passes D3: Droplet and Splash Test – provides protection from droplets and splashes // Passes D4: Dust Test – provides protection from dust particles

### Black Body | 3 Variations

- GB10010TM ••••• Clear **H2MAX** AF
- GB10020TM ••••• Gray **H2MAX** AF
- GB10025TM ••••• Light Gray **H2MAX** AF



## Highlander™ ANSI • CE •



Removable soft foam carriage // Durable frame with detachable strap



SBL50

SBR50

SSB50

### Black Frame | 5 Variations

- SBB5010DT ••• Clear H2X AF
- SBB5020DT ••• Gray H2X AF
- SBB5055DT ••• Sky Red Mirror AF
- SBB5070DT ••• Silver Mirror AF
- SBB5080DT ••• I/O Mirror AF

### Black and Lime Frame | 1 Variation

- SBL5010DT ••• Clear H2X AF

### Black and Red Frame | 2 Variations

- SBR5010DT ••• Clear H2X AF
- SBR5020DT ••• Gray H2X AF

### Black and Silver Frame | 2 Variations

- SSB5020DT ••• Gray H2X AF
- SSB5065DT ••• Ice Blue Mirror AF

**i** Highlander is partially foam padded which allows for airflow.

## Highlander Plus™ ANSI • CE • CSA • Ballistic •



Removable indirect vented flame resistant foam carriage // Detachable strap // Passes Ballistic MIL-PRF-32432 High Velocity Impact standards

### Black and Gray Frame | 5 Variations

- SBG5010DT ••• Clear H2X AF
- SBG5020DT ••• Gray H2X AF
- SBG5030DT ••• Amber H2X AF
- SBG5055DT ••• Sky Red Mirror AF
- SBG5080DT ••• I/O Mirror AF

**i** Highlander Plus is partially foam padded which allows for airflow.



## XS3 PLUS® ANSI • CSA • AS •



### Black Frame | 3 Variations

- SB4610STP ••• Clear H2X AF
- SB4620STP ••• Gray H2X AF
- SB4680STP ••• I/O Mirror AF

Unique slim temple design with co-injected temple tips // Flame resistant foam padding

## PMXCEL® ANSI •



### Black Frame | 3 Variations

- SB7310DT ••• Clear AF
- SB7320DT ••• Gray AF
- SB7321DT ••• Polarized Gray AF

Flame resistant inner foam padding // Detachable strap



## V2G® ANSI • CE • CSA • AS • Ballistic •



Flame resistant foam padding // Vented lens and frame // Interchangeable temples and strap included // Strap and temples feature ratchet adjustment with quick-fit retainer // Passes Ballistic MIL-PRF-32432 High Velocity Impact standards

**i** V2G Readers on page 87.

### Black Frame | 8 Variations

- GB1810ST ••••• Clear H2X AF
- GB1810STM ••••• Clear H2MAX AF
- GB1820ST ••••• Gray H2X AF
- GB1820STM ••••• Gray H2MAX AF
- GB1830ST ••••• Amber H2X AF
- GB1850SFT ••••• 5.0 IR Filter H2X AF
- GB1860SFT ••••• 3.0 IR Filter H2X AF
- GB1880ST ••••• I/O Mirror AF



### V2G Rx Insert RX1800

Securely snaps into place above nosepiece // Includes micro-fiber storage case // Accommodates -3.0 to +3.0 prescription lenses // Take insert to local optometrist for Rx lens installation

## XSG® ANSI • CE • CSA •



Flame resistant foam padding // Strap has quick-fit retainer // Interchangeable temples and strap included

### Black Frame | 4 Variations

- GB4010ST ••••• Clear H2X AF
- GB4010STM ••••• Clear H2MAX AF
- GB4020ST ••••• Gray H2X AF
- GB4080ST ••••• I/O Mirror AF

**i** XSG Readers on page 87.



## XSG Kit™ ANSI • CE • Ballistic •



Interchangeable lenses, temples, and strap // Black nylon case for storage // Passes Ballistic MIL-PRF-32432 High Velocity Impact standards

### Black Frame | 3 Interchangeable Options

- GB4010KIT ••••• Clear H2X AF Gray H2X AF Amber H2X AF







### Fyxate™ ANSI • CSA •



Dielectric // Rubber temple tips and nosepiece // Single wraparound lens // Flame resistant foam padding available on select options // Quick release strap available on foam padded options only

#### Lens and Temples | 5 Variations

SB10210S ••	Clear
SB10210ST ••	Clear H2X AF
SB10220S ••	Gray
SB10220ST ••	Gray H2X AF
SB10280S ••	I/O Mirror

#### Foam Padded | 2 Variations

SB10210STMFP ••	Clear H2MAX AF
SB10220STMFP ••	Gray H2MAX AF



### V3T™ ANSI • CSA •



#### Black Frame | 4 Variations

SB10310ST ••	Clear AF
SB10320ST ••	Gray AF
SB10330ST ••	Amber AF
SB10380ST ••	I/O Mirror AF

Vented lens and frame // Quick release strap // Flame resistant foam padding



### Proximity® ANSI • CE • CSA •

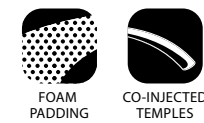

Removable flame resistant foam padding // Lightweight spectacle – 26.3gm // Slim co-injected temples

#### Black Frame | 6 Variations

SB9310ST •••	Clear H2X AF
SB9310STM •••	Clear H2MAX AF
SB9323ST ••	Dark Gray H2X AF
SB9323STM ••	Dark Gray H2MAX AF
SB9330ST •••	Amber H2X AF
SB9380ST •••	I/O Mirror AF



Ridgeline® / Proximity / RVZ4420B / CorXcel®



### Accurist® ANSI • CSA •



Flame resistant foam padding // Built-in rubber nosepiece // Co-injected temple tips

#### Black Frame | 4 Variations

SB8710DTP ••	Clear AF
SB8720DTP ••	Gray AF
SB8725DTP ••	Light Gray AF
SB8770DP ••	Silver Mirror

#### Black and Red Frame | 3 Variations

SBR8710DTP ••	Clear AF
SBR8720DTP ••	Gray AF
SBR8770DP ••	Silver Mirror

# EYEWEAR FULL FRAME

Full frame glasses feature lenses that are surrounded and held in place by a sturdy frame, making them perfect for a multitude of job applications or for leading an active lifestyle. They also tend to provide a closer fit than half frame or frameless options. We have an array of frame colors, patterns, and shapes to help you achieve the look that's right for you.



Goliath



## Goliath® ANSI • CE • CSA • AS •



Co-injected rubber temples

### Black Frame | 9 Variations

- SB5610D ••• Clear
- SB5610DT • Clear H2X AF
- SB5620D ••• Gray
- SB5620DT ••• Gray H2X AF
- SB5621D ••• Polarized Gray
- SB5645D ••• Ice Orange Mirror
- SB5665D ••• Ice Blue Mirror
- SB5670D ••• Silver Mirror
- SB5680D ••• I/O Mirror

### White Frame | 3 Variations

- SW5620D ••• Gray
- SW5655D ••• Sky Red Mirror
- SW5665D ••• Ice Blue Mirror



SW56

## Furix® ANSI • CE •

Lightweight contemporary frame // Straight back temples

### Black Frame | 4 Variations

- SB8510DT ••• Clear AF
- SB8515DT ••• Coffee AF
- SB8520DT ••• Gray AF
- SB8575DT ••• Blue Mirror AF



## Exeter® ANSI • CE • AS •



Built-in rubber nosepiece // Co-injected rubber temples

### Glossy Black Frame | 7 Variations

- SB5110DT ••• Clear H2X AF
- SB5120DT ••• Gray H2X AF
- SB5133DT ••• Shooter's Amber H2X AF
- SB5155DT ••• Sky Red Mirror AF
- SB5170DT ••• Silver Mirror AF
- SB5175DT ••• Blue Mirror AF
- SB5180DT ••• I/O Mirror AF



Velar

## Velar™ ANSI • CSA •



Built-in rubber nosepiece // Co-injected rubber temples

### Black Frame | 3 Variations

- SB10410D ••• Clear
- SB10420D ••• Gray
- SB10465D ••• Ice Blue Mirror

### Black and Red Frame | 1 Variation

- SBRF10445D ••• Ice Orange Mirror

### White and Blue Frame | 1 Variation

- SWBL10465D ••• Ice Blue Mirror

### White and Red Frame | 1 Variation

- SWR10455D ••• Sky Red Mirror



SBRF104



SWBL104



SWR104

## Zone II® ANSI • CE • AS •



Built-in rubber nosepiece // Rubber coated temple tips

### Matte Black Frame | 6 Variations

- SB3310E • Clear
- SB3320E • Gray
- SB3345E • Ice Orange Mirror
- SB3365E • Ice Blue Mirror
- SB3370E • Silver Mirror
- SB3380E • I/O Mirror

### Blue Wood Frame | 1 Variation

- SBW3320E • Gray

### Red Wood Frame | 2 Variations

- SRW3320E • Gray
- SRW3370E • Silver Mirror

### Silver Frame | 5 Variations

- SS3320E • Gray
- SS3345E • Ice Orange Mirror
- SS3365E • Ice Blue Mirror
- SS3370E • Silver Mirror
- SS3375E • Blue Mirror



## Solara® ANSI •



Straight back temples with rubber insert // Built-in rubber nosepiece // Extended lens

STG43

### Black Frame | 5 Variations

- SB4310D • Clear
- SB4320D • Gray
- SB4360D • Infinity Blue
- SB4375D • Blue Mirror
- SB4380D • I/O Mirror

### Translucent Gray Frame | 3 Variations

- STG4310D • Clear
- STG4320D • Gray
- STG4370D • Silver Mirror



Outlander®

## Outlander® ANSI •



Dual lens style with wide temples // Soft nosepiece

### Black Frame | 4 Variations

- SB8010D • Clear
- SB8020D • Gray
- SB8065D • Ice Blue Mirror
- SB8070D • Silver Mirror



## Trifecta® ANSI •

Punched steel lens // Provides excellent eye protection for work environments with high humidity that require impact protection

### Black Frame | 1 Variation

- SB76WMD • Black Punched Steel

**i** This product meets only high impact requirements.



## Azera® ANSI •



Straight back temples // Built-in rubber flange nosepiece

### Black Frame | 3 Variations

- SB4410D • Clear
- SB4420D • Gray
- SB4430D • Amber



## Monitor™ ANSI •

Conventional plastic frames offer wire core temple for easy adjustment

### Caramel Frame | 1 Variation

- SC210C • Clear



## Pathfinder™ ANSI •

Metal frame features traditional aviator style

### Gold Metal Frame | 1 Variation

- SG310A • Clear



## Zone® ANSI •

Lightweight nylon frame

### Black Frame | 2 Variations

- SB910E • Clear
- SB920E • Gray

# EYEWEAR HALF FRAME

Half frame glasses blend the breathability of a frameless design with the endurance provided by a full frame. Many of our half frame options come with an adjustable nosepiece feature allowing them to function and fit much like regular glasses. They are ideal for any application where both durability and an unobstructed line of vision are equally important.



Ridgeline® / Ever-Lite / RVZ2620

## Ever-Lite® ANSI • CE • CSA •

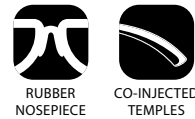

Soft nosepiece for snug fit // Slim co-injected temples // Lightweight spectacle – 22 gm



### Black Frame | 19 Variations

SB8610D ●●●	Clear	SB8624D ●●●	Photochromic	SB8665D ●●	Ice Blue Mirror
SB8610DT ●●●	Clear H2MAX AF	SB8625DTM ●●●	Light Gray H2MAX AF	SB8680D ●●●	I/O Mirror
SB8610DTM ●●●	Clear H2MAX AF	SB8630D ●●●	Amber	SB8680DT ●●●	I/O Mirror AF
SB8620D ●●●	Gray	SB8650SF ●●	5.0 IR Filter		
SB8620DT ●●●	Gray H2MAX AF	SB8660D ●●	Infinity Blue		
SB8620DTM ●●●	Gray H2MAX AF	SB8660DT ●●	Infinity Blue H2MAX AF		
SB8623D ●●	Dark Gray	SB8660DTM ●●●	Infinity Blue H2MAX AF		
SB8623DT ●●	Dark Gray H2MAX AF	SB8660SF ●●	3.0 IR Filter		

**i** Photochromic lens changes from clear to dark, after exposed to direct UV light. Changes from dark to clear, after removed from UV light. Ever-Lite Readers on page 88.

## Flex-Lyte™ ANSI • CE • CSA •

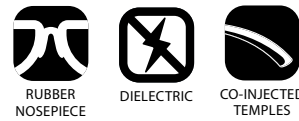

Soft nosepiece for snug fit // Special dielectric hinge design // Slim co-injected temples channel away sweat // Lightweight spectacle – 22 gm



SBL105

### Black and Gray Frame | 5 Variations

SBG10510 ●●●	Clear
SBG10510DTM ●●●	Clear H2MAX AF
SBG10520 ●●●	Gray
SBG10520DTM ●●●	Gray H2MAX AF
SBG10580 ●●●	I/O Mirror

### Black and Lime Frame | 5 Variations

SBL10510 ●●●	Clear
SBL10510DTM ●●●	Clear H2MAX AF
SBL10520 ●●●	Gray
SBL10520DTM ●●●	Gray H2MAX AF
SBL10580 ●●●	I/O Mirror

## Sitecore™ ANSI • CE • CSA •



Built-in rubber nosepiece // Flexible and ventilated temples // Ratcheting temples // Temples adjust to three different lengths



### Black and Gray Frame | 6 Variations

SBG10110D ●●●	Clear
SBG10110DTM ●●●	Clear H2MAX AF
SBG10120D ●●●	Gray
SBG10120DTM ●●●	Gray H2MAX AF
SBG10130D ●●●	Amber
SBG10180D ●●●	I/O Mirror

### Gray and Lime Frame | 5 Variations

SGL10110D ●●●	Clear
SGL10110DTM ●●●	Clear H2MAX AF
SGL10120D ●●●	Gray
SGL10120DTM ●●●	Gray H2MAX AF
SGL10180D ●●●	I/O Mirror



SGL101

## Rendezvous® ANSI • CE • Ballistic •



Adjustable nosepiece // Temples adjust to four different lengths // Lens angle aligns to proper position for work application with ratcheting lens pitch adjustment // Passes Ballistic MIL-PRF-32432 High Velocity Impact standards



### Black Frame | 11 Variations

SB2810S ●●●	Clear
SB2810ST ●●●	Clear H2MAX AF
SB2815S ●●●	Coffee
SB2820S ●●●	Gray
SB2820ST ●●●	Gray H2MAX AF
SB2830S ●●●	Amber
SB2840S ●●●	Orange
SB2860S ●●●	Infinity Blue
SB2860ST ●●●	Infinity Blue H2MAX AF
SB2870S ●●●	Silver Mirror
SB2880S ●●●	I/O Mirror

### Crystal Blue Frame | 1 Variation

SCB2810S ●●●	Clear
--------------	-------

### Crystal Clear Frame | 2 Variations

SCC2810S ●●●	Clear
SCC2810ST ●●●	Clear H2MAX AF

### Crystal Gray Frame | 1 Variation

SCG2810ST ●●●	Clear H2MAX AF
---------------	----------------



SCB28

SCC28

SCG28



## PMXTREME® ANSI • CE •



Built-in rubber nosepiece // Ventilated flexible temples with rubber temple tips // Includes black lanyard cord

### Black Frame with Cord | 11 Variations

- SB6310SP • Clear
- SB6310STP • Clear AF
- SB6320SP • Gray
- SB6320STP • Gray AF
- SB6330SP • Amber
- SB6345SP • Ice Orange Mirror
- SB6360SP • Infinity Blue
- SB6370SP • Silver Mirror
- SB6375SP • Blue Mirror
- SB6376SP • Smoke Green Mirror
- SB6380SP • I/O Mirror

### Camo Frame with Cord | 3 Variations

- SCM6310STP • Clear AF
- SCM6318STP • Sandstone Bronze AF
- SCM6320STP • Gray AF



SCM63



SR63

### Red Frame with Cord | 1 Variation

- SR6320SP • Gray

**i** PMXTREME Readers on page 89.



## PMXTREME LED ANSI • CE •

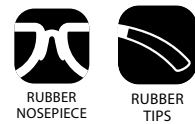

Super bright swiveling LED bulbs (three lumens per side) allows you to see in dark places while keeping your hands free // Built-in rubber nosepiece and rubber temples tips // The alkaline batteries provide up to 50 hours of use before replacing. Three L44 alkaline batteries per temples (six total) are included // Easy to use push button on/off switches are located at the top of each temple

### Black Frame | 2 Variations

- SB6310SPLED • Clear
- SB6310STPLED • Clear AF

**i** PMXTREME LED Readers on page 89.



## PMXTREME Rx ANSI •

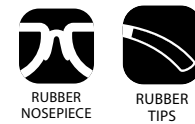

Includes RX insert which accommodates -3.0 to +3.0 prescription lenses // Take insert to local optometrist for Rx lens installation

### Black Frame | 2 Variations

- SB6310STRX • Clear AF
- SB6320STRX • Gray AF



## Venture II® ANSI • CE • CSA • Ballistic •

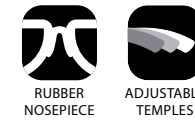

Temples adjust to four different lengths // Rubber nosepiece secures the glass and prevents slipping // Passes Ballistic MIL-PRF-32432 High Velocity Impact standards

### Black Frame | 15 Variations

- SB1810S • Clear
- SB1810ST • Clear H2X AF
- SB1820S • Gray
- SB1820ST • Gray H2X AF
- SB1830S • Amber
- SB1835S • Sun Block Bronze
- SB1840S • Orange
- SB1850SF • 5.0 IR Filter
- SB1860S • Infinity Blue
- SB1860SF • 3.0 IR Filter
- SB1870S • Silver Mirror
- SB1875S • Blue Mirror
- SB1880S • I/O Mirror
- SB1880ST • I/O Mirror AF
- SB1890S • Gold Mirror



SH18

**i** Venture II Readers on page 88.



SMB18



SMM18



SSG18

### Realtree Hardwoods HD® Frame | 3 Variations

- SH1810S • Clear
- SH1820S • Gray
- SH1830S • Amber

### Maroon Frame | 1 Variation

- SMM1810S • Clear

### Slate Gray Frame | 1 Variation

- SSG1810S • Clear

### Metallic Blue Frame | 3 Variations

- SMB1810S • Clear
- SMB1820S • Gray
- SMB1880S • I/O Mirror



## V2-Metal™ ANSI • CE • CSA •



Spring loaded temples allows for easy positioning // Contemporary metal frame and temples fit all facial sizes

### Gun Metal Frame | 3 Variations

- SGM1810S • Clear
- SGM1820S • Gray
- SGM1860S • Infinity Blue



Ridgeline® / PMXTREME®

## Venture 3® ANSI • CE • CSA • AS • Ballistic •



Soft, adjustable nosepiece // Ventilated frame // Adjustable co-injected rubber temples // Passes Ballistic MIL-PRF-32432 High Velocity Impact standards

### Black Frame | 13 Variations

SB5710D	Clear
PYSB5710D*	Clear
SB5710DT	Clear H2X AF
SB5710DTM	Clear H2MAX AF
SB5720D	Gray
SB5720DT	Gray H2X AF
SB5730D	Amber
PYSB5730D*	Amber
SB5750SFT	5.0 IR Filter H2X AF
SB5760D	Infinity Blue
SB5760SFT	3.0 IR Filter H2X AF
SB5770D	Silver Mirror
SB5780D	I/O Mirror

**i** Venture 3 retail packaged product\* on page 41.



Venture 3

## Reatta® ANSI •



Adjustable rubber nosepiece // Straight back flexible temples // Vented lens allows airflow to prevent fogging

### Charcoal Frame | 3 Variations

SCH4810D	Clear
SCH4810DT	Clear H2X AF
SCH4820D	Gray

### Charcoal and Blue Frame | 3 Variations

SNC4810D	Clear
SNC4820D	Gray
SNC4880D	I/O Mirror



SNC48

## Ionix® ANSI • CSA • Ballistic •



Built-in rubber nosepiece // Flexible and ventilated temples // Passes Ballistic MIL-PRF-32432 High Velocity Impact standards

### Black Frame | 7 Variations

SB8110D	Clear
SB8110DT	Clear AF
SB8116D	Sandstone Bronze
SB8120D	Gray
SB8120DT	Gray AF
SB8165D	Ice Blue Mirror
SB8170D	Silver Mirror



## Onix® ANSI • CE • AS • Ballistic •



Ratcheting co-injected temples // Adjustable rubber nosepiece // Passes Ballistic MIL-PRF-32432 High Velocity Impact standards

### Black Frame | 5 Variations

SB4910S	Clear
PYSB4910S*	Clear
SB4910ST	Clear H2X AF
SB4920S	Gray
SB4980S	I/O Mirror

### Black and Green Frame | 1 Variation

SGR4910ST	Clear H2X AF
-----------	--------------



**i** Onix retail packaged product\* on page 41.

### Black and Pink Frame | 2 Variations

SP4910S	Clear
PYSP4910S*	Clear



SGR49



SP49

## Onix Plus ANSI • CE • AS •



Co-injected temples // Adjustable rubber nosepiece // Unique 3-angle adjustable flip lens // Outer lens flips down for applications where tinted or IR lenses are needed

### Black Frame | 3 Variations

SB4920STP	Clear with Gray H2X AF
SB4950STP	Clear with 5.0 IR H2X AF
SB4960STP	Clear with 3.0 IR H2X AF



## Integra® ANSI • CE • CSA •



Adjustable temples ensure reliable performance

ADJUSTABLE TEMPLES



SM4



SN4



SNWR4



SR4

### Black Frame | 5 Variations

- SB410S • Clear
- SB410ST • Clear AF
- SB420S • Gray
- SB450SF • 5.0 IR Filter
- SB460SF • 3.0 IR Filter

### Black Ratchet Frame | 1 Variation

- SB410SR • Clear

### Mixed Blue Frame | 1 Variation

- SM410S • Clear

### Blue Frame | 1 Variation

- SN410S • Clear

### Red, White & Blue Frame | 1 Variation

- SNWR410S • Clear

### Red Frame | 1 Variation

- SR410S • Clear



## Avanté® ANSI •



Vented frame // Flexible temples // Built-in rubber nosepiece

VENTED FRAME

RUBBER NOSEPIECE

### Black Frame | 7 Variations

- SB4510D • Clear
- SB4520D • Gray
- SB4530D • Amber
- SB4560D • Infinity Blue
- SB4570D • Silver Mirror
- SB4575D • Blue Mirror
- SB4580D • I/O Mirror

### Gun Metal | 2 Variations

- SGM4510D • Clear
- SGM4520D • Gray

### Silver Frame | 5 Variations

- SS4510D • Clear
- SS4520D • Gray
- SS4545D • Ice Orange Mirror
- SS4580D • I/O Mirror
- SS4585D • Ice Blue Mirror

### Silver and Black Frame | 3 Variations

- SSB4510D • Clear
- SSB4520D • Gray
- SSB4570D • Silver Mirror



SGM45



SS45



SSB45



## Fortress® ANSI •



ADJUSTABLE NOSEPIECE

RUBBER NOSEPIECE

VENTED LENS

RUBBER TIPS

Adjustable rubber nosepiece // Straight-back rubber coated temple tips // Vented lens allows airflow to prevent fogging

### Black Frame | 7 Variations

- SB3710D • Clear
- SB3710DT • Clear AF
- SB3715D • Coffee
- SB3720D • Gray
- SB3760D • Infinity Blue
- SB3770D • Silver Mirror
- SB3780D • I/O Mirror

### Gray Frame | 1 Variation

- SG3710D • Clear

### Silver Frame | 3 Variations

- SS3710D • Clear
- SS3720D • Gray
- SS3770D • Silver Mirror



SG37



SS37



## Pacifica® ANSI •



VENTED FRAME

RATCHETING TEMPLES

ADJUSTABLE TEMPLES

Vented rubber frame // Brow guard // Adjustable ratchet temples

### Black Frame | 2 Variations

- SB3410S • Clear
- SB3420S • Gray



## PMXTORQ® ANSI •



Wide, straight back temples // Ventilated nosepiece

RUBBER NOSEPIECE

### Matte Black Frame | 2 Variations

- SB6910D • Clear
- SB6920D • Gray

## Mayan® ANSI • CE •



Integrated nosepiece // Sleek in-line ratchet temples

RATCHETING TEMPLES

### Black Frame | 2 Variations

- SB2610D • Clear
- SB2620D • Gray



### Black Frame | 4 Variations

- SB6610D • Clear
- SB6610DT • Clear H2X AF
- SB6620D • Gray
- SB6680D • I/O Mirror



## Forum® ANSI • Ballistic •



Adjustable rubber nosepiece // Passes Ballistic MIL-PRF-32432 High Velocity Impact standards

ADJUSTABLE NOSEPIECE

## Surveyor® ANSI •



Rubber comfort-fit temples // Soft nosepiece

RUBBER NOSEPIECE

CO-INJECTED TEMPLES

### Black Temples | 4 Variations

- SB6110ST • Clear AF
- SB6120S • Gray
- SB6145S • Ice Orange Mirror
- SB6170S • Silver Mirror



## Gravex® ANSI • CSA •

Built-in nosepiece

### Black Frame | 4 Variations

- SB8910S • Clear
- SB8910ST • Clear H2X AF
- SB8920S • Gray
- SB8980S • I/O Mirror



# EYEWEAR FRAMELESS

Frameless eyewear perfectly couples simplicity and style allowing them to work in applications and environments where a full field of vision is ideal, if not essential. Because they are lightweight and provide the wearer with an unobstructed view, they are excellent choices for those who are required to wear eye protection for long periods of time.



Ridgeline® / Endeavor Plus / RJ3210



## Endeavor® Plus ANSI • CSA •



Built-in brow guard // Special dielectric hinge design // Curved co-injected temples // One-piece wraparound lens // Soft adjustable nosepiece // Foam padding is available in select options

### Black and Gray Temples | 6 Variations

- SBG9610S •• Clear
- SBG9610ST •• Clear **H2X AF**
- SBG9620S •• Gray
- SBG9620ST •• Gray **H2X AF**
- SBG9630S •• Amber
- SBG9680S •• I/O Mirror

### Black and Gray Temples with Foam Padding | 2 Variations

- SBG9610STMFP •• Clear **H2MAX AF**
- SBG9620STMFP •• Gray **H2MAX AF**

### Black and Green Temples | 4 Variations

- SBGR9610S •• Clear
- SBGR9610ST •• Clear **H2X AF**
- SBGR9620S •• Gray
- SBGR9680S •• I/O Mirror

### Black and Green Temples with Foam Padding | 2 Variations

- SBGR9610STMFP •• Clear **H2MAX AF**
- SBGR9620STMFP •• Gray **H2MAX AF**

### Black and Pink Temples | 2 Variations

- SBP9610S •• Clear
- SBP9610ST •• Clear **H2X AF**



## Cortez® ANSI • CE •



Durable co-injected temples // Ribbed cushioned nosepiece

### Apple Temples | 1 Variation

- SA3610S •• Clear

### Black Temples | 4 Variations

- SB3610S •• Clear
- SB3610ST •• Clear **H2X AF**
- SB3620S •• Gray
- SB3680S •• I/O Mirror

### Gray Temples | 2 Variations

- SG3610S •• Clear
- SG3620S •• Gray



### Orange Temples | 2 Variations

- S03610S •• Clear
- S03620S •• Gray

### Navy Temples | 1 Variations

- SN3610S •• Clear



## Itek® ANSI • CE • CSA • AS • Ballistic •

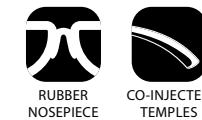

Integrated nosepiece with rubber posts // Soft co-injected rubber temple tips // Lens provides excellent side protection // Passes Ballistic MIL-PRF-32432 High Velocity Impact standards

### Lens and Temples | 10 Variations

- S5810S •••• Clear
- S5810ST •••• Clear **H2X AF**
- S5810STM •••• Clear **H2MAX AF**
- S5820S •••• Gray
- S5820ST •••• Gray **H2X AF**
- S5830S •••• Amber
- S5860S •••• Infinity Blue
- S5870S •••• Silver Mirror
- S5875S •••• Blue Mirror
- S5880S •••• I/O Mirror



## Intrepid® II ANSI • CE • CSA • Ballistic •



Nosepiece flange eliminates pressure on bridge of nose by evenly distributing weight of glass // Flexible rubber temples provide pressure-free fit behind the ear // Passes Ballistic MIL-PRF-32432 High Velocity Impact standards

### Black Temples | 8 Variations

- SB8810S •••• Clear
- PYSB8810S\* •••• Clear
- SB8820S •••• Gray
- PYSB8826S\* •••• Smoke Green
- PYSB8827S\* •••• Vermilion
- SB8830S •••• Amber
- SB8835S •••• Sun Block Bronze
- SB8880S •••• I/O Mirror



**i** Intrepid II retail packaged product\* on page 41.



## Provoq® ANSI • CSA •



Soft nosepiece // Rubber temples

### Black Temples | 11 Variations

S7210S	••	Clear
S7210ST	••	Clear AF
S7220S	••	Gray
S7220ST	••	Gray AF
S7230S	••	Amber
S7255S	••	Multi-Color Mirror
S7260S	••	Infinity Blue
S7270S	••	Silver Mirror
S7275S	••	Blue Mirror
S7280S	••	I/O Mirror
S7280ST	••	I/O Mirror AF

### Pink Temples | 1 Variation

SP7210ST	•	Clear AF
----------	---	----------



SP72



Ridgeline® / Ztek® / RVZ2610 / GL201



## PMXSLIM® ANSI • CE • AS •



Slim fit for smaller facial features // Soft adjustable nosepiece // Co-injected temple design includes soft rubber tips for a non-slip fit

### Black Temples | 6 Variations

SB7110S	••	Clear
SB7110ST	•••	Clear H2X AF
SB7120S	••	Gray
SB7120ST	•••	Gray H2X AF
SB7138S	••	Sandstone Bronze
SB7180S	••	I/O Mirror

## Achieva® ANSI •



SP65

Brow guard // Built-in rubber nosepiece // Unique rubber temple tips

### Gray Temples Tips | 3 Variations

SG6510S	•	Clear
SG6510ST	•	Clear H2X AF
SG6520S	•	Gray

### Pink Temples Tips | 1 Variation

SP6510S	•	Clear
---------	---	-------

## Alair® ANSI • CE •

Straight temples // Integrated nosepiece

### Lens and Temples | 7 Variations

S3210S	••	Clear
S3210ST	••	Clear H2X AF
S3220S	••	Gray
S3260S	••	Infinity Blue
S3270S	••	Silver Mirror
S3275S	••	Blue Mirror
S3280S	••	I/O Mirror

## Ztek® ANSI • CE • CSA •



Integrated nosepiece // Soft non-slip rubber temple tips provide non-binding fit

### Lens and Temples | 18 Variations

S2510S	•••	Clear
S2510ST	•••	Clear H2X AF
S2514S	•••	1.5 IR Filter
S2515S	•••	Coffee
S2520S	•••	Gray
S2520ST	••	Gray H2X AF
S2530S	•••	Amber
S2540S	•••	Orange
S2550SF	••	5.0 IR Filter
S2560S	•••	Infinity Blue
S2560SF	••	3.0 IR Filter
S2560ST	••	Infinity Blue H2X
S2565S	••	Purple Haze
S2570S	••	Silver Mirror
S2575S	••	Blue Mirror
S2580S	••	I/O Mirror
S2590S	••	Gold Mirror
S25ARCS	••	Arc



128 mm



137 mm

## Mini Ztek ANSI • CE • CSA •

Mini Ztek has all the great features of Ztek in a design better suited for slimmer facial sizes

### Lens and Temples | 8 Variations

S2510SN	•••	Clear
S2510SNT	••	Clear H2X AF
S2517SN	••	Pink
S2520SN	•••	Gray
S2530SN	•••	Amber
S2560SN	••	Infinity Blue
S2575SN	•••	Blue Mirror
S2580SN	•••	I/O Mirror

**i** Mini Ztek is about 6% smaller than the Ztek. S2514S is designed for peripheral personnel and visitors who are NOT exposed to direct IR radiation. S25ARCS is great for use under the welding helmet – allowing welder to see work clearly without suffering “welder’s flash burn” from surrounding welders. Ztek Readers on page 89.

## Neshoba™ ANSI • CE • CSA •

Frameless design with thin flexible temples // Ultra lightweight spectacle – 16 gm

### Black Temples | 8 Variations

S9710S	•••	Clear
S9710ST	•••	Clear H2X AF
S9720S	•••	Gray
S9720ST	•••	Gray H2X AF
S9730S	•••	Amber
S9760S	••	Infinity Blue
S9770S	••	Silver Mirror
S9780S	•••	I/O Mirror



## TruLock™ ANSI • CE • CSA •



Dielectric // Lightweight spectacle – 21 gm // Patented temples lock into place

### Black Temples | 8 Variations

SB9510S ●●●	Clear
SB9510ST ●●●	Clear H2X AF
SB9520S ●●●	Gray
SB9520ST ●●●	Gray H2X AF
SB9530S ●●●	Amber
SB9556S ●●●	Multi-color Mirror
SB9580S ●●●	I/O Mirror
SB9580ST ●●●	I/O Mirror AF



Ridgeline® / TruLock



## TruLock Multi-Colors

ANSI • CE • CSA •

Sold in dozen quantity only // Comes with six assorted temple colors: red, blue, green, purple, orange and black // Multi-pack includes two of each temple color with clear lenses // Perfect for work areas where color coding is necessary



**WATCH THE VIDEO**

Vimeo.com/Pyramex/TruLock

### Multi-Color Temples | 2 Variations

S9510SMP ●●●	Clear
S9520SMP ●●●	Gray



## Atoka® ANSI • CSA •



Integrated nosepiece // Soft non-slip rubber temple tips provide non-binding fit

### Lens and Temples | 8 Variations

S9110S ●●	Clear
S9110ST ●●	Clear AF
S9120S ●●	Gray
S9120ST ●●	Gray AF
S9130S ●●	Amber
S9160S ●●	Infinity Blue
S9180S ●●	I/O Mirror
S9180ST ●●	I/O Mirror AF

## Fastrac® ANSI •



Dielectric // Frame/lens combination provides maximum single lens protection

### Lens and Temples | 2 Variations

S1410S ●●	Clear
S1420S ●●	Gray

## GT 2000® ANSI •

Frameless lightweight design

### Black Temples | 2 Variations

SB2010S ●●	Clear
SB2020S ●●	Gray

## Intruder® ANSI • CE • CSA •



Integrated nosepiece // Lightweight frameless protection // Foam padding is available in select options



### Lens and Temples | 14 Variations

S4110S ●●●	Clear
S4110ST ●●●	Clear AF
S4110SUC ●●●	Uncoated Clear
S4120S ●●●	Gray
S4120ST ●●●	Gray AF
S4130S ●●●	Amber
S4160S ●●●	Infinity Blue
S4170S ●●●	Silver Mirror
S4175S ●●●	Blue Mirror
S4180S ●●●	I/O Mirror
S4180ST ●●●	I/O Mirror AF

### Foam Padded Frame | 3 Variations

S4110STFP ●●●	Clear AF
S4120STFP ●●●	Gray AF
S4180STFP ●●●	I/O Mirror AF

### Black Temples | 1 Variation

SB4110S ●●●	Clear
-------------	-------

### Blue Temples | 1 Variation

SN4110S ●●●	Clear
-------------	-------

### Red Temples | 1 Variation

SR4110S ●●●	Clear
-------------	-------



SB41



SN41



SR41

**i** Mini Intruder is about 8% smaller than the Intruder. Intruder Readers on page 89.

## Mini Intruder ANSI •

Mini Intruder has all the great features of Intruder in a design better suited for smaller facial size

### Lens and Temples | 5 Variations

S4110SN ●●●	Clear
S4110SNT ●●●	Clear AF
S4120SN ●●●	Gray
S4130SN ●●●	Amber
S4180SN ●●●	I/O Mirror



119 mm



129 mm



## Intruder and Mini Intruder Multi-Colors

ANSI • CE • CSA •

Sold in dozen quantity only // Comes with six assorted temple colors: red, blue, green, purple, orange and black // Multi-pack includes two of each temple color with clear lenses // Perfect for work areas where color coding is necessary

### Multi-Color Temples | 2 Variations

S4110SMP ●●●	Clear (Intruder)
S4110SNMP ●●●	Clear (Mini Intruder)

# EYEWEAR OVER THE SPECTACLE

Over the spectacle eyewear is intended for those who require additional protection over their prescription glasses. They are designed with channels built in to accommodate another pair of temples, meaning you never have to remove your prescription glasses to comfortably achieve the protection you need.



OTS / RP3001

## OTS® and OTS XL ANSI • CE • CSA • AS •



RATCHETING  
TEMPLES



ADJUSTABLE  
TEMPLES

Fits over prescription glasses // Lightweight nylon temples adjust for length and pitch



### OTS

#### Black Temples | 7 Variations

S3510SJ	Clear
S3510STJ	Clear H2X AF
S3520SJ	Gray
S3530SJ	Amber
S3550SFJ	5.0 IR Filter
S3560SFJ	3.0 IR Filter
S3580SJ	I/O Mirror

### OTS XL

#### Black Temples | 4 Variations

S7510SJ	Clear
S7510STJ	Clear H2X AF
S7520SJ	Gray
S7580SJ	I/O Mirror

**i** OTS XL is about 9% larger than the OTS. OTS fits over frames up to 137mm x 44mm. OTS XL fits over frames up to 151mm x 49mm.

## Solo® ANSI • CE • CSA •

Temples are vented to reduce fogging

### Lens and Temples | 4 Variations

S510S	Clear
S510SD	Clear Dispenser pack – 12 per box
S510SJ	Clear Jumbo
S520S	Gray

**i** S510SJ are designed to be used over prescription spectacles.



## Cappture™ ANSI • CE • CSA •



DIELECTRIC

Dielectric // Fits over prescription glasses // Temples extend from browbar to avoid interference with prescription frame's temples // Rubber gasket is available in select options

### Lens and Temples | 4 Variations

S9910ST	Clear H2X AF
PYS9910ST*	Clear H2X AF
S9920ST	Gray H2X AF
S9930ST	Amber H2X AF

### Rubber Gasket | 2 Variations

S9910STMGRG	Clear H2MAX AF
S9920STMGRG	Gray H2MAX AF

**i** Cappture retail packaged product\* on page 41.



Cappture

## Defiant® ANSI • CE •



RATCHETING  
TEMPLES



ADJUSTABLE  
TEMPLES

Tilt type adjustment allows optimum visibility // Temples adjust to four settings

### Black Temples | 2 Variations

SB1010S	Clear
SB1010SJ	Clear Jumbo

**i** SB1010SJ are designed to be used over prescription spectacles.



# EYEWEAR READERS

Readers are designed to better assist those who require both safety glasses and prescription lenses. Our readers come in two forms, glasses and inserts, with anywhere from a 1.0+ to a 3.0+ magnification. Many options will also accommodate a personal Rx prescription from an optometrist.



Emerge Plus / GL102



## Emerge® Plus ANSI • CSA •



Rubber temple tips // Soft nosepiece provides comfort for extended use

### Full Readers Translucent Gray Frame | 7 Variations

SG9810R15	••	Clear	+1.5 Mag
SG9810R20	••	Clear	+2.0 Mag
SG9810R25	••	Clear	+2.5 Mag
SG9810R30	••	Clear	+3.0 Mag
SG9820R15	••	Gray	+1.5 Mag
SG9820R20	••	Gray	+2.0 Mag
SG9820R25	••	Gray	+2.5 Mag

### Top Insert Readers Translucent Gray Frame | 3 Variations

SG9810TR15	••	Clear	+1.5 Mag
SG9810TR20	••	Clear	+2.0 Mag
SG9810TR25	••	Clear	+2.5 Mag

**i** The top insert reader for the EmERGE Plus is strategically placed for applications in which user is frequently looking up.



## Emerge® ANSI • CE • CSA •



Soft nosepiece provides comfort for extended use // RX options accommodate an Rx lens to the maximum of +3 to -3 diopters // Available with a full reader +1.5 or +2.0 lens or as a prescription lens // Dual lens design with full eye protection // Plano, prescription, and full reader lens adaptable

**i** Frame must be presented to your optometrist in order to be fitted with prescription lenses.

### Black Frame | 3 Variations

SB7910DRX	•••	Clear	
SB7910D15	••	Clear	+1.5 Mag
SB7910D20	••	Clear	+2.0 Mag

### Translucent Caramel Frame | 3 Variations

STC7910DRX	••	Clear	
STC7910D15	••	Clear	+1.5 Mag
STC7910D20	••	Clear	+2.0 Mag



### Translucent Gray Frame | 3 Variations

SG7910DRX	•••	Clear	
SG7910D15	••	Clear	+1.5 Mag
SG7910D20	••	Clear	+2.0 Mag



## V2G® Readers ANSI • CSA •

Flame resistant foam padding // Vented lens and frame // Interchangeable temples and strap included // Strap and temples feature ratchet adjustment with quick-fit retainer

### Black Frame | 3 Variations

GB1810STR15	••	Clear H2X AF	+1.5 Mag
GB1810STR20	••	Clear H2X AF	+2.0 Mag
GB1810STR25	••	Clear H2X AF	+2.5 Mag

**i** See more V2G options on page 63.



## XSG® Readers ANSI • CSA •

Flame resistant foam padding // Strap has quick-fit retainer // Interchangeable temples and strap included

### Black Frame | 3 Variations

GB4010STR15	••	Clear H2X AF	+1.5 Mag
GB4010STR20	••	Clear H2X AF	+2.0 Mag
GB4010STR25	••	Clear H2X AF	+2.5 Mag

**i** See more XSG options on page 63.

## Ever-Lite® Readers ANSI • CSA •

Soft nosepiece for snug fit // Slim co-injected temples // Lightweight spectacle – 22 gm

### Black Frame | 7 Variations

SB8610R15 ••	Clear	+1.5 Mag
SB8610R20 ••	Clear	+2.0 Mag
SB8610R25 ••	Clear	+2.5 Mag
SB8610R30 ••	Clear	+3.0 Mag
SB8620R15 ••	Gray	+1.5 Mag
SB8620R20 ••	Gray	+2.0 Mag
SB8620R25 ••	Gray	+2.5 Mag



**i** See more Ever-Lite options on page 70.

## Venture II® Readers ANSI • CE • CSA •

Temples adjust to four different lengths // Rubber nosepiece secures the glass and prevents slipping

### Black Frame | 18 Variations

SB1810R10 •••	Clear	+1.0 Mag
SB1810R15 •••	Clear	+1.5 Mag
SB1810R15T •••	Clear H2X AF	+1.5 Mag
SB1810R20 •••	Clear	+2.0 Mag
SB1810R20T •••	Clear H2X AF	+2.0 Mag
SB1810R25 •••	Clear	+2.5 Mag
SB1810R25T •••	Clear H2X AF	+2.5 Mag
SB1810R30 •••	Clear	+3.0 Mag
SB1820R15 ••	Gray	+1.5 Mag
SB1820R20 ••	Gray	+2.0 Mag
SB1820R25 ••	Gray	+2.5 Mag
SB1820R30 ••	Gray	+3.0 Mag
SB1830R15 •	Amber	+1.5 Mag
SB1830R20 •	Amber	+2.0 Mag
SB1830R25 •	Amber	+2.5 Mag
SB1880R15 ••	I/O Mirror	+1.5 Mag
SB1880R20 ••	I/O Mirror	+2.0 Mag
SB1880R25 ••	I/O Mirror	+2.5 Mag



Venture II Readers



**i** See more Venture II options on page 73.



## PMXTREME® Readers ANSI •

Built-in rubber nosepiece // Ventilated flexible temples with rubber temple tips // Includes black lanyard cord

### Black Frame with Cord | 3 Variations

SB6310SPR15 •	Clear	+1.5 Mag
SB6310SPR20 •	Clear	+2.0 Mag
SB6310SPR25 •	Clear	+2.5 Mag

**i** See more PMXTREME options on page 72.



## Ztek® Readers ANSI • CE • CSA •

Integrated nosepiece // Soft non-slip rubber temple tips provide non-binding fit

### Lens and Temples | 8 Variations

S2510R15 •••	Clear	+1.5 Mag
S2510R20 •••	Clear	+2.0 Mag
S2510R25 •••	Clear	+2.5 Mag
S2514R15 •	1.5 IR Filter	+1.5 Mag
S2514R20 •	1.5 IR Filter	+2.0 Mag
S2520R15 •	Gray	+1.5 Mag
S2520R20 •	Gray	+2.0 Mag
S2520R25 •	Gray	+2.5 Mag

**i** See more Ztek options on page 81. S2514S is designed for peripheral personnel and visitors who are NOT exposed to direct IR radiation.



## PMXTREME LED Readers ANSI •

Super bright swiveling LED bulbs (three lumens per side) allows you to see in dark places while keeping your hands free // Built-in rubber nosepiece and rubber temples tips // The alkaline batteries provide up to 50 hours of use before replacing. Three L44 alkaline batteries per temples (six total) are included // Easy to use push button on/off switches are located at the top of each temple

### Black Frame | 3 Variations

SB6310STPLEDR15 •	Clear AF	+1.5 Mag
SB6310STPLEDR20 •	Clear AF	+2.0 Mag
SB6310STPLEDR25 •	Clear AF	+2.5 Mag

**i** See more PMXTREME LED options on page 72.



## Intruder® Readers

Integrated nosepiece // Lightweight frameless protection

### Lens and Temples | 3 Variations

S4110R15 •	Clear	+1.5 Mag
S4110R20 •	Clear	+2.0 Mag
S4110R25 •	Clear	+2.5 Mag

**i** See more Intruder options on page 83.

# EYEWEAR GOGGLES

Goggles provide protection against a variety of different potential hazards, including things like chemical splash, flying particles, wind, sun glare, and dust. No matter what unique protection your application or environment requires, with features like thermo and anti-fog lenses, open and close ventilation systems, and removable face shields, we have goggles to meet your needs.



V2G-Plus



## V2G-Plus® ANSI • CE • CSA • AS • Ballistic •



Includes a wide adjustable elastic strap with quick release system for secure fit // TPU frame features excellent resistance to cold and heat // Thermo Lens System provides excellent resistance to fog caused by temperature differences in your environment // Special indirect ventilation system located at the top and bottom of frame allows airflow and heat release // Multi-functional goggle with 180° vision protects against chemical splash, sun glare, dust, flying particles, and wind // Outer polycarbonate lens protects against the environment while an inner acetate lens prevents fogging // Inner lens is separated by a thin spacer of air and sealed together with foam // Passes Ballistic MIL-PRF-32432 High Velocity Impact standards // Passes D3: Droplet and Splash Test – provides protection from droplets and splashes

### Black Body with Strap | 2 Variations

- GB6410SDT ••••• Clear Dual Pane H2X AF
- GB6420SDT ••••• Gray Dual Pane H2X AF



### V2G-Plus Rx Insert RX6400

Accommodates -3.0 to +3.0 prescription lenses // Securely snaps into place above nosepiece // Includes micro-fiber storage case // Take insert to local optometrist for Rx lens installation

## Capstone® Shield ANSI • CE • CSA •

Fully adjustable elastic band // Fits over prescription glasses // Lens is coated to prevent fogging // GG504DTSHIELD goggle has a dual pane lens // Soft vinyl goggle body conforms to facial contours // Goggles pass D3: Droplet and Splash Test – provides protection from droplets and splashes // Removable vent caps allow the user to remove when more ventilation is required or leave in place for unsurpassed chemical splash resistance // Goggle combined with removable shield provides full face protection // Four ventilation holes provide airflow // Ratchet shield allows user to open or close in three positions for adjustment // Polycarbonate shield conforms to the face offering increased impact and dust protection

### Lens and Shield | 5 Variations

- GG504TSHIELD ••••• Clear H2X AF
- GG504DTSHIELD ••••• Clear Dual Pane H2X AF
- GG504TSHIELDIR3 ••••• 3.0 IR Filter H2X AF
- GG504TSHIELDIR5 ••••• 5.0 IR Filter H2X AF
- GG524TSHIELD ••••• Gray H2X AF

**i** Fits over prescription glasses. Only the goggles for GG504TSHIELDIR3 and GG504TSHIELDIR5 contains IR dye. Due to the nature of the vented holes, the shield is only green tinted and does not contain the IR resin.



### Capstone Face Shield and Strap CAPSHIELD

Ratcheting shield includes strap and clips allowing the user to add to either of the Capstone 500 Series goggles // Sold as a replacement shield for GG504TSHIELD and GG504DTSHIELD



### Disposable Capstone Shield Visors VPACK6

Pack of 6 clear disposable, tear-off visors, suitable for high dust or muddy working environments

### CAPSTRAP

Not shown – strap to convert other Capstone goggles to hold VPACK6

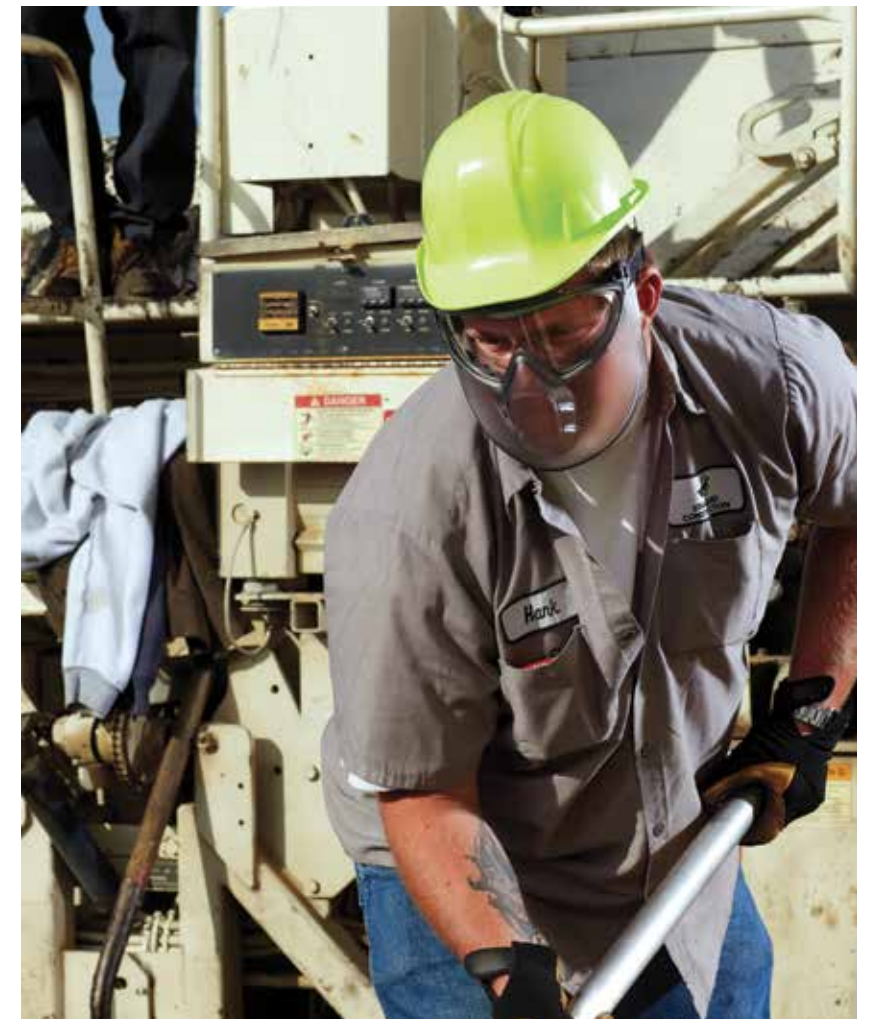

SL Series / Capstone Shield



## Capstone® Dual Lens ANSI • CE • CSA • AS • Ballistic •



Fully adjustable elastic strap // Fits over prescription glasses // Outer polycarbonate lens protects against the environment while an inner acetate lens prevents fogging // Soft vinyl goggle body conforms to facial contours // Provides protection against dust and chemical splash // Removable vent caps allow the user to remove when more ventilation is required or leave in place for unsurpassed chemical splash resistance // Passes D3: Droplet and Splash Test – provides protection from droplets and splashes // Passes Ballistic MIL-PRF-32432 High Velocity Impact standards

### Gray Body with Quick Release Strap | 1 Variation

G504DT ••••• Clear Dual Pane H2X AF

**i** Fits over prescription glasses.

## Capstone RL ANSI • CE • CSA •



Replaceable lens // Fits over prescription glasses // Indirect ventilation system prevents fogging // Co-material goggle provides superior protection against dust entry and chemical splash // Thermoplastic (TPE) body with universal nose bridge is flexible and conforms to facial contours // G804TRL passes D3: Droplet and Splash Test – provides protection from droplets and splashes

### Gray Body with Neoprene Strap | 2 Variations

G804TRL ••••• Clear H2X AF  
R804T ••••• Replacement Clear H2X AF

**i** Fits over prescription glasses.



Ridgeline® / CM6010 / Capstone RL / CBD12PKDC / RVHL2510BRD



## Capstone® 500 ANSI • CE • CSA • AS • Ballistic •

Fits over prescription glasses // Soft vinyl goggle body conforms to facial contours // Goggle provides protection against dust and chemical splash // Removable vent caps allow the user to remove when more ventilation is required or leave in place for unsurpassed chemical splash resistance // GG504T and GG504TM passes D3: Droplet and Splash Test – provides protection from droplets and splashes // GG504T passes Ballistic MIL-PRF-32432 High Velocity Impact standards



GC504TN

### Gray Body with Quick Release Strap | 2 Variations

GG504T ••••• Clear H2X AF  
GG504TM ••••• Clear H2MAX AF

### Chemical Green Body with Neoprene Strap | 1 Variation

GC504TN ••••• Clear H2X AF

**i** Fits over prescription glasses.



Ridgeline® / Capstone 600 / RSSH3210

## Capstone 600 ANSI • CE • CSA • AS • Ballistic •

Fits over prescription glasses // Indirect ventilation system prevents fogging // Includes interchangeable cloth and neoprene straps // Co-material goggle provides superior protection against dust entry and chemical splash // Thermoplastic (TPE) body with universal nose bridge is flexible and contours to the user's face // Passes D3: Droplet and Splash Test – provides protection from droplets and splashes // Passes D4: Dust Test – provides protection from dust particles // Passes Ballistic MIL-PRF-32432 High Velocity Impact standards

### Gray Body with Adjustable Strap | 1 Variation

G604T2 ••••• Clear H2X AF

**i** Fits over prescription glasses.

## Low-Profile Chemical Splash Goggle

ANSI • CE

Low-profile, modern sport design with anti-glare frame // Indirect ventilation prevents liquids from entering // Adjustable elastic band and soft PVC frame // Passes D3: Droplet and Splash Test – provides protection from droplets and splashes

### Gray Body with Black Strap | 2 Variations

- G704T • Clear AF
- G724T • Gray AF



## Wire Mesh Goggle ANSI

Single wire mesh lens with PVC frame // Ideal for: forestry, landscaping, and agriculture applications // For work environments with extreme heat and high humidity where impact protection is required // Low profile design with wide elastic strap provides secure fit // Soft rubber gasket seals out unwanted particles and is comfortable for all day wear // Meets ANSI Z87.1-2015 wire screen requirements

### Black Body with Adjustable Strap | 1 Variation

- G9WMG • Black Wire Mesh



## Chemical Splash Goggle ANSI

Indirect ventilation // Designed to be better suited for slimmer facial sizes // Frame is extremely soft, flexible and lightweight

### Blue Body with Adjustable Strap | 1 Variation

- GN904 • Clear

## Top Shelf Chemical Splash Goggle

ANSI • CE • CSA

Special one-way vent allows air in while keeping liquids out // Generously sized heavy duty body and lens // Fits over prescription spectacles // Tinted body helps reduce glare // G304TN comes with a neoprene strap // G304T and G304TN passes D3: Droplet and Splash Test – provides protection from droplets and splashes // G304T and G304TN passes D4: Dust Test – provides protection from dust particles

### Tinted Body with Black Strap | 2 Variations

- G304 • Clear
- G304T • Clear H2X AF

### Tinted Body with Neoprene Strap | 1 Variation

- G304TN • Clear H2X AF



## Top Shelf Chemical Splash Goggle with Foam Padding ANSI



Special one-way vent allows air to enter while keeping liquids out // Breakaway headband provides added protection and features quick-fit retainer // Fits over prescription spectacles // Tinted body helps reduce glare // Generously sized heavy duty body and lens with foam padding for comfort

### Tinted Body with Black Strap | 1 Variation

- G404T • Clear H2X AF



## Chemical Splash Goggle ANSI

ANSI

Vent caps restrict influx of liquids

### Clear Body with Black Strap | 2 Variations

- G204 • Clear
- G204T • Clear AF



## Perforated Goggle ANSI

Goggle provides excellent ventilation

### Clear Body with Black Strap | 2 Variations

- G201 • Clear
- G201T • Clear AF



## Ventless Goggle ANSI

Goggle provides protection against odor vapors

### Clear Body with Black Strap | 1 Variation

- G200T • Clear H2X AF



# EYEWEAR ACCESSORIES



CLIPCORDS Clip-On Cord



CORDS Lanyard Loop



CORDS1A Cotton Cord



CORDS7A Cord with Rubber Tips



CORDS8A Breakaway Cord



CORDS9A Bungee Cord



NEOCORD Neoprene Breakaway Cord



NEO1 Neoprene Cord



CA200B Zippered Case



CA500B Hard Case



NEOCASE Neoprene Case



PYRBAGS Cloth Drawstring Spectacle Bag (6.25" x 3.75")

PYRBAGLG Large Cloth Drawstring Spectacle Bag (9.50" x 5")



CLEANCLOTH Nylon Microfiber Cleaning Cloth



IDBADGE Identification Badge Lanyard



SS100 Pliable Slip on Side Shields

Meets ANSI Z87.1 High Impact Requirements Only



CRA003 60 Individually Packaged Fog Buster™ Towelettes



GALSOL Gallon of Lens Cleaning Solution



HCW100 100 Individually Packaged Alcohol Free Hygienic Wipes (5" x 8")

HCW100A 100 Individually Packaged Alcohol Hygienic Wipes (5" x 8")

HCW100XL 100 Individually Packaged Alcohol Free Hygienic Wipes (8" x 11")

**i** Safe and effective for cleaning respirators, hard hat suspensions and other personal protective equipment, but not to be used on disposable particulate respirators.



LCC100 Canister with 100 Lens Cleaning Wet Tissues

**i** Packaging for cleaning products may vary.



LCS10 8 oz. Lens Cleaning Station with 600 Tissues

LT300 Refill Tissues for LCS10 and LCS20

LT760 760 Pack of 5x8 Cleaning Tissues



LCS20 16 oz. Lens Cleaning Station with 1,200 Tissues

LCB16 16 oz. Cleaning Solution Replacement Bottle with Pump



LCT100 100 Individually Packaged 5x8 Cleaning Towelettes

LCTBULK 100 Individually Packaged 5x8 Cleaning Towelettes in a bag



DIS5 Silver Corrugated Stationary Display - holds up to 5 units



DIS9 Silver Corrugated Stationary Display - holds up to 9 units



DIS5BL Blue Stationary Display - holds up to 5 units



DIS5CF Stationary Display - holds up to 5 units



DIS9TR Stationary Display - holds up to 9 units



DISPLAY Rotating Display - holds up to 36 units

**i** Products shown with cases and displays are sold separately.

# WELDING 98 – 105

AUTO-DARKENING HELMETS 100 – 101

PASSIVE HELMET 102

IR FILTER PRODUCTS 102 – 104



A



B



C

# WHAT YOU NEED TO KNOW

## Welding Helmet Certifications

Pyramex welding products have been independently tested for various standards and certifications. Use the quick key (ANSI • CE • CSA •) on the following pages to reference product models that meet these standards and certifications. Use the dots next to each part number to reference which options meet the standards and certifications.

ANSI Z87.1 +	•
CE EN175: 1997 (shells)	
CE EN379: 2009-07 (filters)	•
CE EN166: 2001 (cover plates)	
Cert. Mod. - CAN/CSA Z94.3-15 	•

## IR Products Certifications

Pyramex eyewear has been independently tested for various standards and certifications. Use the quick key (ANSI • CE • CSA • AS •) on the following pages to reference product models that meet these standards and certifications. Use the dots next to each part number to reference which options meet the standards and certifications.

ANSI Z87.1+ High Impact	•
CE EN166	•
Cert. Mod. - CAN/CSA Z94.3-15 	•
AS/NZS 1337	•

## Selection Chart

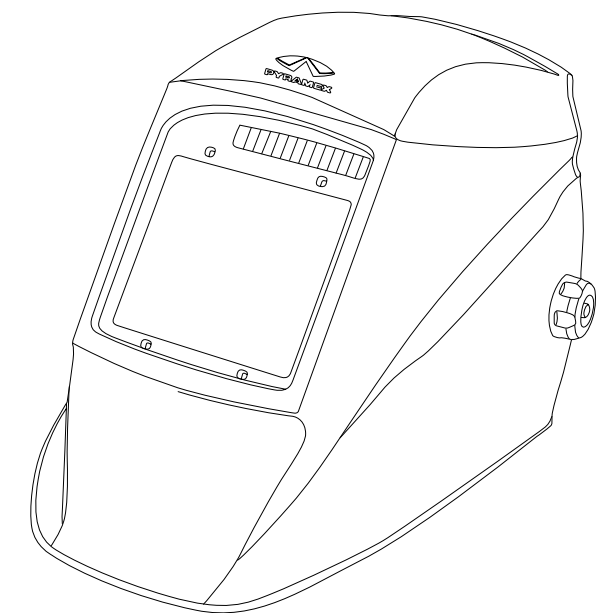
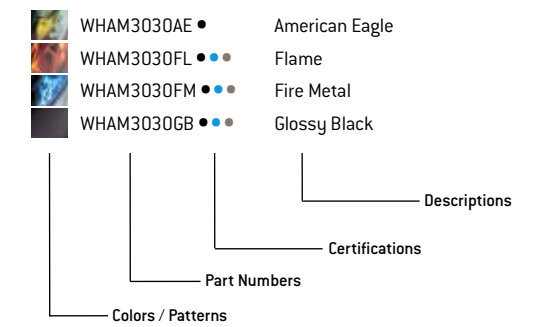

# LEADHEAD®

## AUTO-DARKENING HELMETS

Auto-darkening helmets are designed for maximum efficiency—and maximum safety. Designed to darken instantaneously at the light of a welding torch and clear up when the torch is turned off. The variable shade is intended to eliminate the process of lifting and lowering the helmet in order to see. Because an inactive lens often rests at either shade 3 or 4, seeing and starting the arc while still staying protected is easy. Auto-darkening helmets run off of solar power and batteries.



WHAD6030MB



WHAM3030AE





WHAM3030FL

WHAM3030FM

WHAM3030GB

### WHAM30 Series ANSI • CE • CSA

4 / 5-8 / 9-13 stepless variable shade // 3.858" x 3.425" (98 x 87 mm) view area // Manual internal controls // Four independent sensors in staggered design // Solar cells and replaceable lithium-battery // Cutting, grinding and welding modes // 1/30,000 second switch speed // 5 amps and below TIG rating // High-impact resistant nylon // Up to shade DIN16 at all times

-  WHAM3030AE • American Eagle
-  WHAM3030FL • Flame
-  WHAM3030FM • Fire Metal
-  WHAM3030GB • Glossy Black





**i** Auto-darkening helmets are suitable for all types of electro-weldings: covered electrodes, MIG/MAG, TIG/WIG, plasma welding, cutting and laser welding (only selected models with two shade ranges, i.e. 5-8 and 9-13), except for gas welding. Pyramex recommends Duracell® DL2450 replacement lithium-battery for WHAM30 and WHAD60 and Duracell® DL2032 for WHAM10.



WHAD6030GB

### WHAD60 Series ANSI

4 / 5-13 digital display // 3.937" x 2.362" (100 x 60 mm) view area // Digital internal controls // Four independent sensors in staggered design // Solar cells and replaceable lithium-battery // Cutting, grinding and welding modes // 1/30,000 second switch speed // 5 amps and below TIG rating // High-impact resistant nylon // Up to shade DIN16 at all times

-  WHAD6030GB • Glossy Black
-  WHAD6030MB • Metallic Blue



### WHAM10 Series ANSI • CE • CSA

4 / 9-13 stepless variable shade // 3.937" x 1.77" (100 x 45 mm) view area // Manual external/internal controls // Four independent sensors in staggered design // Solar cells and replaceable lithium-battery // Grinding and welding modes // 1/30,000 second switch speed // 5 amps and below TIG rating // High-impact resistant nylon // Up to shade DIN 16 at all times

-  WHAM1020MB • Matte Black

## Accessories and Replacement Parts

### Magnifying Inserts | 3 Variations

- WMAG1.5 +1.5 magnifying insert – fits all
- WMAG2.0 +2.0 magnifying insert – fits all
- WMAG2.5 +2.5 magnifying insert – fits all

**i** Auto-darkening helmets include a magnification lens holder.

### Replacement Filters | 3 Variations

- WRAM10 ••• Auto-darkening filter – WHAM10
- WRAM30 ••• Auto-darkening filter – WHAM30
- WRAD60 ••• Auto-darkening filter – WHAD60

### Replacement Front Cover Plates | 2 Variations

- ROWH10PK5 ••• Front cover plate 5 pack – WHAM10
- ROWH3060PK5 ••• Front cover plate 5 pack – WHAM30 & WHAD60

### Replacement Inside Cover Plates | 3 Variations

- RIWH10PK5 ••• Inside cover plate 5 pack – WHAM10
- RIWH30PK5 ••• Inside cover plate 5 pack – WHAM30
- RIWH60PK5 ••• Inside cover plate 5 pack – WHAD60

### Replacement Headgear | 1 Variation

- WHARS1 Headgear – fits all

### Replacement Sweatband | 1 Variation

- WHBAND2 Sweatband 2 pack – fits all

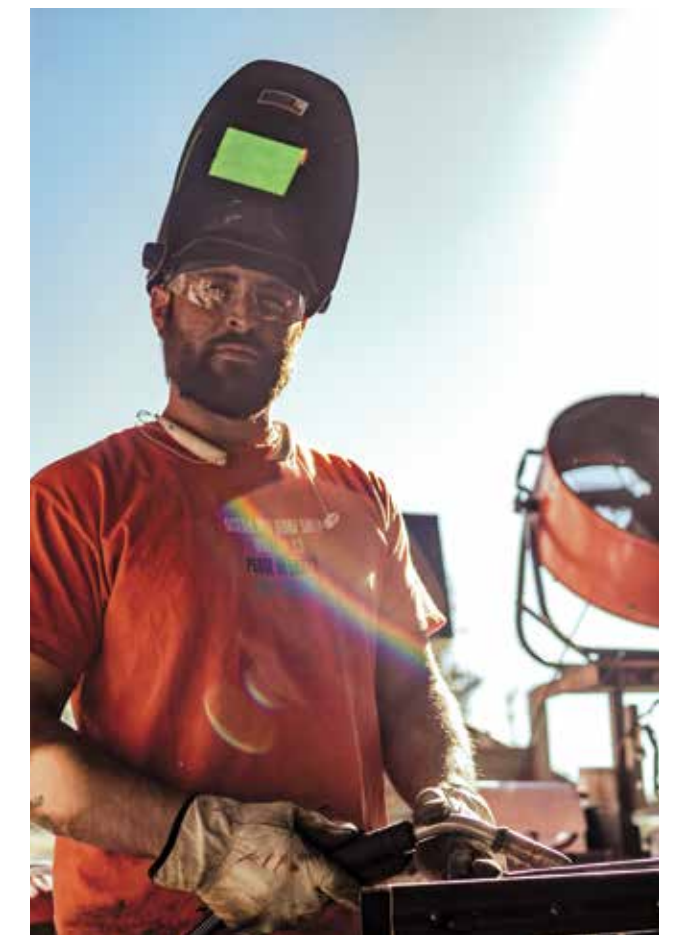

WHAD6030GB / Intruder®

# LEADHEAD®

## PASSIVE HELMET

Passive helmets are known for their reliability and maintainability, which have made them staples for many welders. Though they lack many of the bells and whistles of auto-darkening helmets, they often provide better optical clarity.

### WHP100 Series ANSI • CSA •

IR shade #10 welding filter // Lift front lens // 4.25" x 2" (107.95 x 50.8 mm) view area // Thermoplastic shell with nylon suspension // Optimally balanced "shake down" helmet minimizes carbon monoxide build up // Ample space for respirators

■ WHP100 •• Black



### Capstone® Shield

ANSI • CE •

Fully adjustable elastic band // Fits over prescription glasses // Lens is coated to prevent fogging // Soft vinyl goggle body conforms to facial contours // Goggles pass D3: Droplet and Splash Test – provides protection from droplets and splashes // Removable vent caps allow the user to remove when more ventilation is required or leave in place for unsurpassed chemical splash resistance // Goggle combined with removable shield provides full face protection

#### Lens and Shield | 2 Variations

- GG504TSHIELDIR3 •• 3.0 IR Filter H2X AF
- GG504TSHIELDIR5 •• 5.0 IR Filter H2X AF

**i** For more information about the Capstone Shield see page 91. Only the goggles for GG504TSHIELDIR3 and GG504TSHIELDIR5 contain IR dye. Due to the nature of the vented holes, the shield is only green tinted and does not contain the IR resin.



Venture II®

## IR FILTER PRODUCTS



HGBR / S1250



### Tapered IR5 Face Shield

ANSI •

Tapered polycarbonate face shield // Shown with HGBR – sold separately

■ S1150 • 5.0 IR Filter

**i** For more information about the S1150 see page 52.



### Cylinder IR5 Face Shield

ANSI •

Cylinder polycarbonate face shield // Shown with HGBR – sold separately

■ S1250 • 5.0 IR Filter

**i** For more information about the S1250 see page 52.



### V2G® ANSI • AS •

Flame resistant foam padding // Vented lens and frame // Interchangeable temples and strap included // Strap and temples feature ratchet adjustment with quick-fit retainer

#### Black Frame | 2 Variations

- GB1850SFT • 5.0 IR Filter H2X AF
- GB1860SFT • 3.0 IR Filter H2X AF

**i** For more information about the V2G see page 63. V2G Readers on page 87.



### Emerge® ANSI • CSA •

Soft nosepiece provides comfort for extended use

#### Black Frame | 2 Variations

- SB7950SF • 5.0 IR Filter
- SB7960SF • 3.0 IR Filter

**i** For more information about the Emerge see page 87.



### Ever-Lite® ANSI •

Soft nosepiece for snug fit // Slim co-injected temples // Lightweight spectacle – 22 gm

#### Black Frame | 2 Variations

- SB8650SF • 5.0 IR Filter
- SB8660SF • 3.0 IR Filter

**i** For more information about the Ever-Lite see page 70. Ever-Lite Readers on page 88.



### Venture II® ANSI • CE •

Temples adjust to four different lengths // Rubber nosepiece secures the glass and prevents slipping

#### Black Frame | 2 Variations

- SB1850SF •• 5.0 IR Filter
- SB1860SF •• 3.0 IR Filter

**i** For more information about the Venture II see page 73. Venture II Readers on page 88.



### Venture 3® ANSI •

Soft, adjustable nosepiece // Ventilated frame // Adjustable co-injected rubber temples

#### Black Frame | 2 Variations

- SB5750SFT • 5.0 IR Filter **H2X AF**
- SB5760SFT • 3.0 IR Filter **H2X AF**

**i** For more information about the Venture 3 see page 74.



### Integra® ANSI • CE •

Adjustable temples ensure reliable performance

#### Black Frame | 2 Variations

- SB450SF •• 5.0 IR Filter
- SB460SF •• 3.0 IR Filter

**i** For more information about the Integra see page 76.



### Onix® Plus ANSI • CE • AS •

Co-injected temples // Adjustable rubber nosepiece // Unique 3-angle adjustable flip lens // Outer lens flips down for applications where tinted or IR lenses are needed

#### Black Frame | 2 Variations

- SB4950STP •• Clear with 5.0 IR **H2X AF**
- SB4960STP •• Clear with 3.0 IR **H2X AF**

**i** For more information about the Onix Plus see page 75.



### OTS® ANSI •

Fits over prescription glasses // Lightweight nylon temples adjust for length and pitch

#### Black Temples | 2 Variations

- S3550SFJ • 5.0 IR Filter
- S3560SFJ • 3.0 IR Filter

**i** For more information about the OTS see page 84.



### Ztek® ANSI • CE • CSA •

Integrated nosepiece // Soft non-slip rubber temple tips provide non-binding fit

#### Lens and Temples | 6 Variations

- S2514S ••• 1.5 IR Filter
- S2514R15 • 1.5 IR Filter +1.5 Mag
- S2514R20 • 1.5 IR Filter +2.0 Mag
- S2550SF • 5.0 IR Filter
- S2560SF • 3.0 IR Filter
- S25ARCS •• Arc

**i** For more information about the Ztek see page 81. S2514S is designed for peripheral personnel and visitors who are NOT exposed to direct IR radiation. S25ARCS is great for use under the welding helmet – allowing welder to see work clearly without suffering “welder’s flash burn” from surrounding welders.



## LEADHEAD®

### AUTO-DARKENING HELMETS

For more information, see page 100 and 101.



WHAM3030GB

WHAM3030FM

WHAM3030FL

WHAM3030AE

# HEARING 106 – 113

ELECTRONIC EARMUFFS 108

PASSIVE EARMUFFS 108 – 109

METAL DETECTABLE EARPLUGS 110

EARPLUGS 111 – 112



# WHAT YOU NEED TO KNOW

## Hearing Features

Use the icons below to quickly find some of the most requested features for hearing protection.

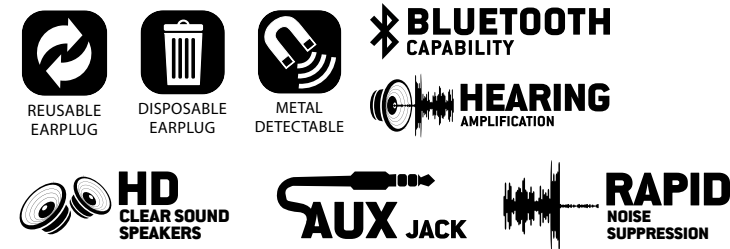

## Selection Chart

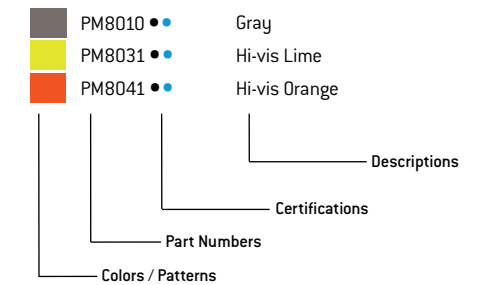

## Hearing Certifications

Our hearing products have been independently tested for various standards and certifications. Use the quick key (ANSI • CE •) on the following pages to reference product models that meet these standards and certifications. Use the dots next to each part number to reference which options meet the standards and certifications.

ANSI S3.19	•
CE EN 352:2002	•

### ANSI S3.19

**NRR**  
Noise Reduction Rating (NRR) is an estimated unit of measurement used to determine the amount of sound in decibels [dB] that a hearing device is capable of blocking out when properly worn.

### CE EN 352:2002

**SNR**  
Single Number Rating (SNR) is an estimated unit of measurement used to determine the amount of sound in decibels [dB] that a hearing device is capable of blocking out when properly worn. SNR also rates hearing protection by the noise environments in three categories: high-frequency [H], mid-frequency [M], and low-frequency [L].

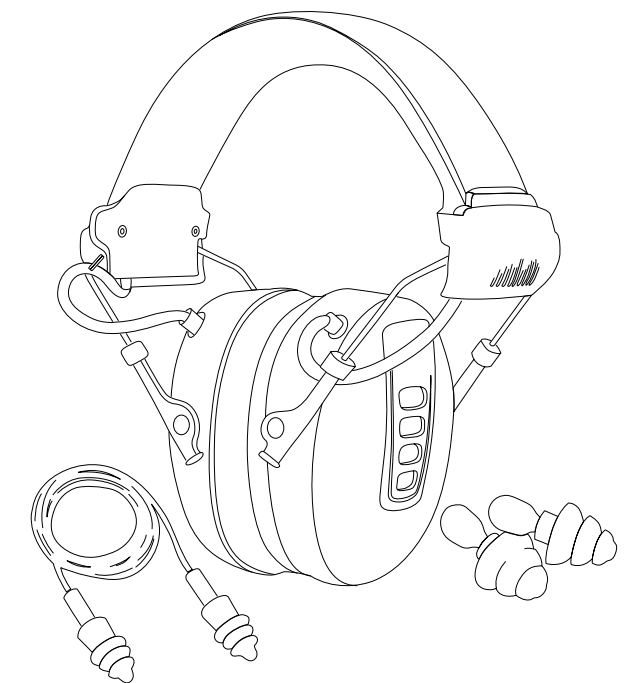

# VENTUREGEAR BY PYRAMEX ELECTRONIC EARMUFFS



**Amp BT™** ANSI •  
NRR 26dB



Quad microphones // Bluetooth compatible // Noise suppression after 85db // Easy adjust volume and ambient noise controls // Auto shut-off after four hours // 3.5 mm AUX jack cord for use of MP3 and mobile devices // 2 AAA batteries are included // Available in a VG clamshell

- VGPM30BT • Black



**Clandestine™** ANSI •  
NRR 24dB



Omni directional microphone // Amplifies hearing while suppressing harmful sounds and reducing them to a safe level // External access for easy battery replacement // 2 AAA batteries are included // Available in a VG capture clam

- VGPM10 • Black
- VGPM17 • Black Graphite



**Sentinel™** ANSI •  
NRR 26dB



Front facing microphone // Amplifies hearing while suppressing harmful sounds and reducing them to a safe level // Auto shut-off after four hours // 3.5 mm AUX jack cord for use of MP3 and mobile devices // 2 AAA batteries are included // Available in a VG clamshell

- VGPM20 • Black
- VGPM26 • Powder Blue

**i** Amp BT | Clandestine | Sentinel  
Electronic earmuffs are VG packaged products. See page 32 for more information.

## HEARING PASSIVE EARMUFFS



**PM80 Series** ANSI • CE •  
NRR 26dB SNR 30dB

Low-profile ear cup design // Height adjustment to fit all sizes // Fold-away padded headband

- PM8010 •• Gray
- PM8031 •• Hi-vis Lime
- PM8041 •• Hi-vis Orange



**PM90 Series** ANSI •  
NRR 22dB

Low-profile ear cup design // Height adjustment to fit all sizes // Fold-away padded headband

- PM9010 • Gray
- PM9010P • Pink



**PM9011 Series** ANSI •  
NRR 19dB

Smaller headband designed for slimmer fit // Height adjustment to fit all sizes // Fold-away padded headband

- PM9011 •



**BH90 Series** ANSI •  
NRR 22dB

Can be worn with hard hats, shields, and other PPE // Adjustable and durable neckband // Ear cups tilt for optimum comfort and efficiency

- BH9010 •



**CM60 Series** ANSI •  
NRR 27dB

Cap mounted earmuff – fits slotted hard hats // Dielectric // Easily accessible while working // Flip down over ears to use or flip up when not in use

- CM6010 •



**PM10 Series** ANSI •  
NRR 25dB

Dielectric // Detachable hook and loop strap allows for earmuff use with hard hat // Rotatable nylon headband

- PM1010 •



**PM20 Series** ANSI •  
NRR 22dB

Dielectric // Lightweight and comfortable // Durable nylon headband

- PM2010 •
- PYPM2010\* •

**i** PM2010 retail packaged product\* on page 41.



**PM30 Series** ANSI • CE •  
NRR 26dB SNR 28dB

Height adjustment to fit all sizes // Fold-away padded headband

- PM3010 ••

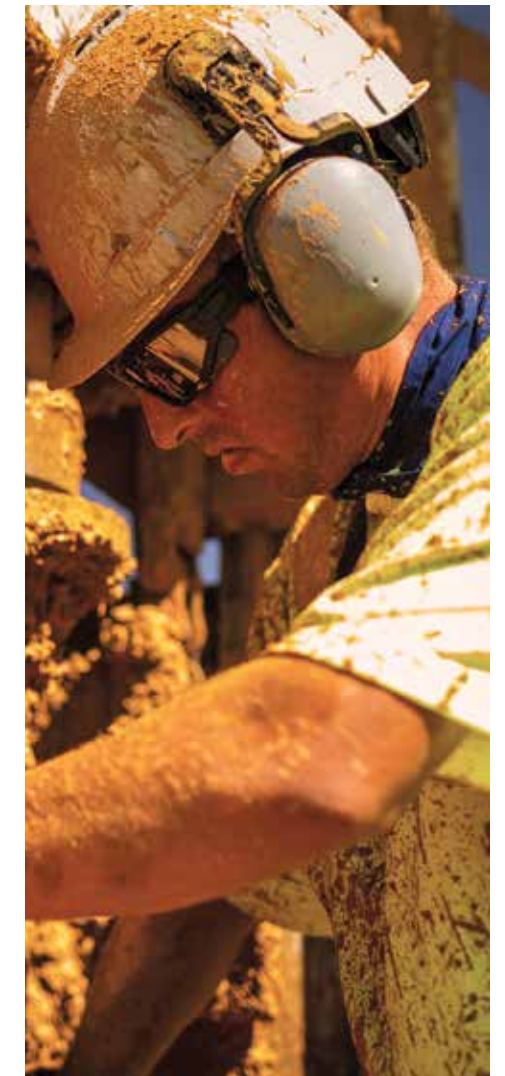

Ridgeline® / CM6010 / I-Force® / CBD12PK / RTS2110NS

# HEARING METAL DETECTABLE EARPLUGS



**RPD3001 Series** ANSI • CE •  
NRR 24dB SNR 30dB



Metal shavings embedded in the plug and cord for metal and magnetic detectability // Eye-catching blue color contrasts with most food products // Three flexible rubber flanges form a secure seal // Reusable earplugs can be cleaned with soap and water

RPD3001 ••



**RPD2001 Series** ANSI •  
NRR 27dB



Iron ball embedded in the plug for metal and magnetic detectability // Eye-catching blue color contrasts with most food products // Three rubber flanges form a secure seal // Reusable earplugs can be cleaned with soap and water

RPD2001 •



**DPD1001 Series** ANSI • CE •  
NRR 32dB SNR 37dB



Iron ball embedded in the plug for metal and magnetic detectability // Eye-catching blue color contrasts with most food products // Expands to fit ear canal // Closed cell foam earplugs are resistant to dirt build up

DPD1001 ••



**DPD1001MS Series** ANSI •  
NRR 32dB



Iron ball embedded in the plug and metal shavings embedded in cord for metal and magnetic detectability // Eye-catching blue color contrasts with most food products // Expands to fit ear canal // Closed cell foam earplugs are resistant to dirt build up

DPD1001MS •

**i** RPD3001 | RPD2001 | DPD1001 | DPD1001MS

Metal detectable earplugs are designed for those working in food manufacturing. Almost all food manufacturing facilities use some form of metal detection in order to test outgoing products, ensuring they are free from contaminants. The blue color is an important component of the earplug, too— it is a popular choice because it contrasts with most food color.

# HEARING EARPLUGS



**DP1001 Series** ANSI • CE •  
NRR 32dB SNR 37dB



Expands to fit ear canal // Closed cell foam earplugs are resistant to dirt build up

DP1001 ••



**RP2001 Series** ANSI •  
NRR 26dB



Three rubber flanges form a secure seal // Reusable earplugs can be cleaned with soap and water

RP2001 •



**RP3001 Series** ANSI • CE •  
NRR 24dB SNR 30dB



Three flexible rubber flanges form a secure seal // Reusable earplugs can be cleaned with soap and water

RP3001 ••  
RP3001PC • Small holding case with RP3001  
PYRP3001\* •

**i** RP3001 retail packaged product\* on page 41.



**BP3000 Series** ANSI •  
NRR 22dB



Designed for environments with intermittent noise hazards // Flexible band can rest around neck when not in use // Conical shaped earplugs that require no roll down

BP3000 •



PMXTREME® / BP3000





**RP4000 Series** ANSI •

NRR 25dB



Stem eliminates earplug contact with fingers // Three flexible rubber flanges form a secure seal // Reusable earplugs can be cleaned with soap and water

RP4000 •



**DP3000 Series** ANSI •

NRR 30dB



No earplug roll down required // Stem eliminates earplug contact with fingers // Expands to fit ear canal // Closed cell foam earplugs are resistant to dirt build up

DP3000 •



**DP1000 Series** ANSI • CE •

NRR 32dB SNR 38dB



Expands to fit ear canal // Closed cell foam earplugs are resistant to dirt build up

DP1000 ••

- PYDP1000\* • 5 Pair in Blister Card
- PYDP1000BN\* • 100 Pair in Bin
- PYDP1000CS\* • 5 Pair with case in Blister Card

**i** DP1000 retail packaged product\* on page 41.



Ridgeline® / Atwater™ / DP3000 / RVZ2110 / GL102



**PD500 Series**

Convenient dispenser with twist knob and catch basin holds 500 pair of disposable uncorded earplugs (included) // Can be wall mounted or used as freestanding display

- PD500 Earplug Dispenser with DP1000
- PD500R Replacement 500 pair of DP1000



**ELECTRONIC EARMUFFS**

For more information, see page 32 and 108.



Amp BT™

Clandestine™

Sentinel™

# HI-VIS WORK WEAR 114 – 127

TYPE R / CLASS 2 116 – 119

TYPE R / CLASS 3 120 – 122

TYPE R / CLASS 3  
LEVEL 2 / CLASS 2 123 – 124

TYPE R / CLASS 2  
LEVEL 2 / CLASS 2 124 – 125

TYPE O / CLASS 1  
LEVEL 2 / CLASS 1 124

NON-RATED 126



A – Ridgeline® / Isotope® / RTS2110B / GL102

B – Ridgeline® / Endeavor® Plus / DP1001 / RCZ2410

C – RH120 / Tensaw® / RJR3410

# WHAT YOU NEED TO KNOW

## Hi-vis Work Wear Certifications

Pyramex hi-vis work wear has been independently tested for various standards and certifications. Use the quick key (ANSI • CSA • ) on the following pages to reference product models that meet these standards and certifications. Use the dots next to each part number to reference which options meet the standards and certifications.

ANSI/ISEA 107-2015

Cert. Mod. - CAN/CSA Z96-15 • third-party certification

## ANSI/ISEA 107-2015

### TYPE R

Type R provides daytime and nighttime visual enhancement for workers in occupational environments, which include exposure to traffic from public access rights-of-way, roadway temporary traffic control (TTC) zones, or work vehicles and construction equipment within a roadway TTC zone.

### TYPE O

Type O provides moderate visibility, ideal for off-road workers.

### CLASS 1

Performance Class 1 offers low risk workers with good visibility. Class 1 is ideal for jobs in areas where traffic is traveling under 25 mph or where the work site is a safe distance from roadways.

### CLASS 2

Performance Class 2 uses additional high-visibility materials, which allow design opportunities to define the human form more effectively. Compared to Performance Class 1, Class 2 high-visibility safety apparel (HVSA) has the potential to provide detection and identification for longer distances.

### CLASS 3

Performance Class 3 can offer greater visibility through a full range of body movements in both complex and non-complex backgrounds by having retro-reflective and combined performance materials on sleeves.

## CAN/CSA Z96-15

### LEVEL 2

Level 2 is the highest retro-reflective performance material and is visible under dark conditions from a great distance. Retro-reflective material also reflects light produced by the headlights of oncoming traffic back to the vehicle operator.

### CLASS 1

Performance Class 1 offers good visibility with the lowest recognized coverage. Class 1 is ideal for jobs on or in parking areas, warehouses, sidewalks, shipping or receiving operations, etc.

### CLASS 2

Performance Class 2 provides moderate body coverage and superior visibility. To comply with CSA standard apparel has to fully cover the upper torso (front, back, sides and over the shoulders) with the reflective striping composed of retro-reflective or combined performance materials. X-back is used to distinguish whether a worker is facing toward or facing away from a hazard. X-back configuration is mandatory in Canada, but can be used for ANSI apparel.

## Hi-vis Work Wear Features

Use the icons below to quickly find some of the most requested features for hi-vis work wear.

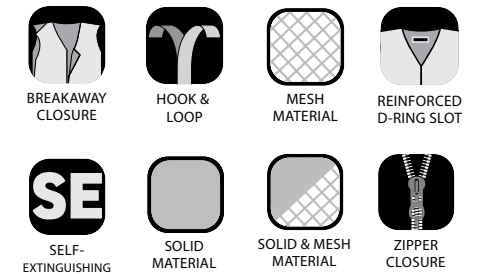

## Selection Chart

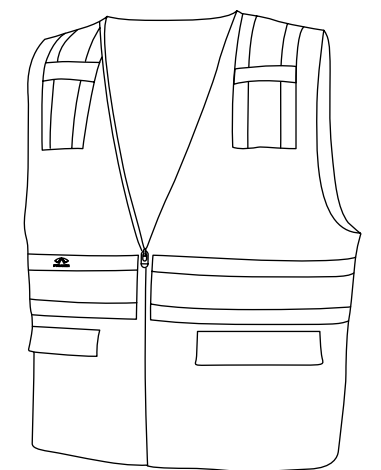
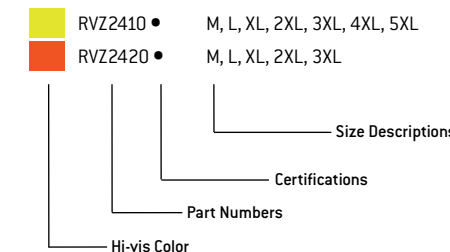



# HI-VIS TYPE R / CLASS 2



## RVZ21 Series ANSI •

TYPE R CLASS 2



MESH MATERIAL

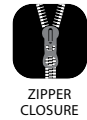

ZIPPER CLOSURE

POCKETS	
1 OUT	1 IN

Hi-vis lightweight polyester mesh material

- RVZ2110 • S, M, L, XL, 2XL, 3XL, 4XL, 5XL
- RVZ2120 • S, M, L, XL, 2XL, 3XL, 4XL, 5XL



## RVZ22 Series ANSI •

TYPE R CLASS 2



MESH MATERIAL

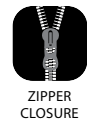

ZIPPER CLOSURE

POCKETS	
1 OUT	1 IN

Hi-vis lightweight polyester mesh material

- RVZ2210 • M, L, XL, 2XL, 3XL, 4XL, 5XL
- RVZ2220 • M, L, XL, 2XL, 3XL, 4XL, 5XL



## RVZ23 Series ANSI •

TYPE R CLASS 2



MESH MATERIAL

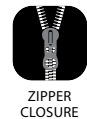

ZIPPER CLOSURE

POCKETS	
4 OUT	2 IN

Hi-vis lightweight polyester mesh material // Mic tabs

- RVZ2310 • S, M, L, XL, 2XL, 3XL, 4XL, 5XL
- RVZ2320 • S, M, L, XL, 2XL, 3XL, 4XL, 5XL



## RVZ24 Series ANSI •

TYPE R CLASS 2



SOLID & MESH MATERIAL

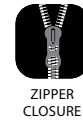

ZIPPER CLOSURE

POCKETS	
5 OUT	3 IN

Hi-vis lightweight polyester solid material on front, mesh material on back // Mic tabs

- RVZ2410 • S, M, L, XL, 2XL, 3XL, 4XL, 5XL
- RVZ2420 • S, M, L, XL, 2XL, 3XL, 4XL, 5XL



## RVZ26 Series ANSI •

TYPE R CLASS 2



MESH MATERIAL

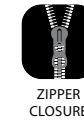

ZIPPER CLOSURE

POCKETS	
1 OUT	1 IN

Hi-vis lightweight polyester mesh material

- RVZ2610 • M, L, XL, 2XL, 3XL, 4XL, 5XL



## RVHL25 Series ANSI •

TYPE R CLASS 2



MESH MATERIAL



BREAKAWAY CLOSURE



REINFORCED D-RING SLOT

POCKETS	
1 OUT	1 IN

Hi-vis lightweight polyester mesh material // Breakaway hook and loop shoulders, sides, and front closure

- RVHL2510BRD • M, L, XL, 2XL, 3XL, 4XL, 5XL
- RVHL2520BRD • M, L, XL, 2XL, 3XL, 4XL, 5XL



## RVHL27 Series ANSI •

TYPE R CLASS 2



MESH MATERIAL



BREAKAWAY CLOSURE

POCKETS	
1 OUT	1 IN

Hi-vis lightweight polyester mesh material // Breakaway hook and loop shoulders, sides, and front closure // Clear chest pocket for badges with hook and loop closure

- RVHL2710BR • M, L, XL, 2XL, 3XL, 4XL, 5XL
- RVHL2720BR • M, L, XL, 2XL, 3XL, 4XL, 5XL



## RVHL29 Series ANSI •

TYPE R CLASS 2



SOLID MATERIAL



HOOK & LOOP

POCKETS	
0 OUT	0 IN

Hi-vis lightweight polyester solid material

- RVHL2910 • S, M, L, XL, 2XL, 3XL
- RVHL2920 • M, L, XL, 2XL, 3XL



## RVHLM29 Series ANSI •

TYPE R CLASS 2



MESH MATERIAL



HOOK & LOOP

POCKETS	
0 OUT	0 IN

Hi-vis lightweight polyester mesh material

- RVHLM2910 • S, M, L, XL, 2XL, 3XL



WHAM3030FL / RVZ2110SE



### RVZ28 Series ANSI •

TYPE R CLASS 2

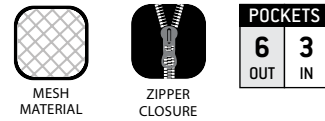

Hi-vis lightweight polyester mesh material with black trim // Clear chest pocket for badges with hook and loop closure // Reach-through pocket on back with zipper closures // Metal grommets on upper front collar trim // Mic tabs

- RVZ2810 • M, L, XL, 2XL, 3XL, 4XL, 5XL
- RVZ2820 • M, L, XL, 2XL, 3XL, 4XL, 5XL



### RVZ44B Series ANSI •

TYPE R CLASS 2

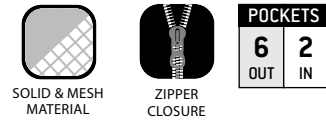

Hi-vis lightweight polyester mesh material with solid black front bottom // Clear chest pocket for badges with hook and loop closure // Reach-through pocket on back with zipper closures // Metal grommets on upper front collar and at waist // Padded collar and mic tabs

- RVZ4410B • M, L, XL, 2XL, 3XL, 4XL, 5XL
- RVZ4420B • M, L, XL, 2XL, 3XL, 4XL, 5XL



### RTS21 Series ANSI •

TYPE R CLASS 2

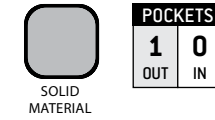

Hi-vis lightweight polyester moisture-wicking t-shirt // UPF30 protection

- RTS2110 • M, L, XL, 2XL, 3XL, 4XL, 5XL
- RTS2120 • M, L, XL, 2XL, 3XL, 4XL, 5XL



### RTS21B Series ANSI •

TYPE R CLASS 2

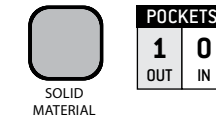

Hi-vis lightweight polyester moisture-wicking t-shirt with black bottom // UPF30 protection

- RTS2110B • M, L, XL, 2XL, 3XL, 4XL-5XL
- RTS2120B • M, L, XL, 2XL, 3XL, 4XL-5XL



### RTS21NP Series ANSI •

TYPE R CLASS 2

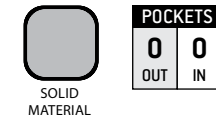

Hi-vis lightweight polyester moisture-wicking t-shirt // UPF30 protection

- RTS2110NP • M, L, XL, 2XL, 3XL, 4XL, 5XL



### RVZ21SE Series ANSI •

TYPE R CLASS 2 NOT FR



Hi-vis self-extinguishing lightweight polyester mesh material

- RVZ2110SE • M, L, XL, 2XL, 3XL, 4XL, 5XL
- RVZ2120SE • M, L, XL, 2XL, 3XL, 4XL, 5XL



### RVZ22SE Series ANSI •

TYPE R CLASS 2 NOT FR



Hi-vis self-extinguishing lightweight polyester mesh material

- RVZ2210SE • M, L, XL, 2XL, 3XL, 4XL, 5XL
- RVZ2220SE • M, L, XL, 2XL, 3XL, 4XL, 5XL



### RVZ24SE Series ANSI •

TYPE R CLASS 2 NOT FR

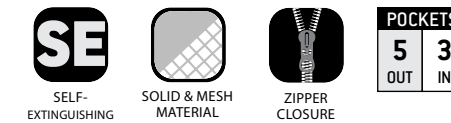

Hi-vis self-extinguishing lightweight polyester solid material on front, mesh material on back // Mic tabs

- RVZ2410SE • M, L, XL, 2XL, 3XL, 4XL, 5XL
- RVZ2420SE • M, L, XL, 2XL, 3XL, 4XL, 5XL



### RTS23 Series ANSI •

TYPE R CLASS 2

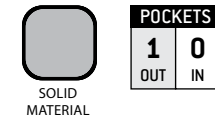

Hi-vis lightweight polyester moisture-wicking t-shirt with black side panels // Reflective material heat transferred in broken pattern for long lasting durability // UPF30 protection

- RTS2310 • M, L, XL, 2XL, 3XL, 4XL



Clandestine™ / Atwater™ / C330 / RTS2310 / GL102

**i** Vest with SE icon are not flame resistant as defined by ANSI/ISEA 107-2015 Section 10.5, but are chemically treated to be self-extinguishing.

# HI-VIS TYPE R / CLASS 3



## RLTS31 Series ANSI •

TYPE R CLASS 3

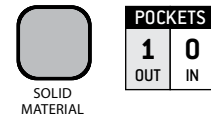

Hi-vis lightweight polyester moisture-wicking long sleeve t-shirt // UPF30 protection

RLTS3110 • M, L, XL, 2XL, 3XL, 4XL, 5XL



## RLTS31B Series ANSI •

TYPE R CLASS 3

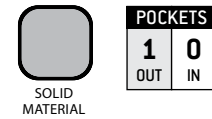

Hi-vis lightweight polyester moisture-wicking long sleeve t-shirt with black bottom // UPF30 protection

RLTS3110B • M, L, XL, 2XL, 3XL, 4XL, 5XL  
RLTS3120B • M, L, XL, 2XL, 3XL, 4XL, 5XL



## RTS33 Series ANSI •

TYPE R CLASS 3

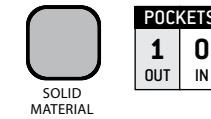

Hi-vis lightweight polyester moisture-wicking t-shirt // UPF30 protection

RTS3310 • M, L, XL, 2XL, 3XL, 4XL-5XL  
RTS3320 • M, L, XL, 2XL, 3XL, 4XL-5XL



## RVZ31 Series ANSI •

TYPE R CLASS 3



Hi-vis lightweight polyester mesh material

RVZ3110 • M, L, XL, 2XL, 3XL, 4XL, 5XL  
RVZ3120 • M, L, XL, 2XL, 3XL, 4XL, 5XL



## RVZ34 Series ANSI •

TYPE R CLASS 3

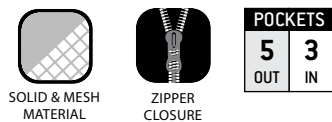

Hi-vis lightweight polyester solid material on front, mesh material on back // Mic tabs

RVZ3410 • S, M, L, XL, 2XL, 3XL, 4XL, 5XL  
RVZ3420 • S, M, L, XL, 2XL, 3XL, 4XL, 5XL



## RVZ35 Series ANSI •

TYPE R CLASS 3

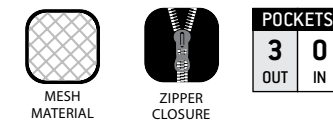

Hi-vis lightweight elastic mesh material // Zipper front closure // Mic tabs

RVZ3510 • M, L, XL, 2XL, 3XL, 4XL, 5XL, 6XL  
RVZ3520 • M, L, XL, 2XL, 3XL, 4XL, 5XL



## RJ31 Series ANSI •

TYPE R CLASS 3

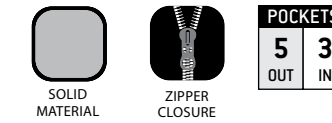

Weatherproof polyester shell with zip-out polar fleece liner // Weatherproof elastic band at the waist and wrists // Concealed detachable hood // Cell phone/radio chest pocket with clear panel on outside shell // Mic tabs and pencil pocket

RJ3110 • M, L, XL, 2XL, 3XL, 4XL, 5XL  
RJ3120 • M, L, XL, 2XL, 3XL, 4XL, 5XL



## RJ32 Series ANSI •

TYPE R CLASS 3

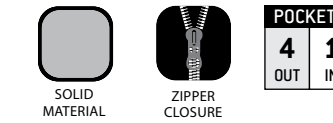

Weatherproof polyester shell with quilted lining // Weatherproof elastic band at the waist and wrists // Concealed hood // Cell phone/radio chest pocket with clear panel on outside shell // Mic tabs and pencil pocket

RJ3210 • M, L, XL, 2XL, 3XL, 4XL, 5XL, 6XL



RH110 / Avanté® / RJ3210



## RJR33 Series ANSI •

TYPE R CLASS 3

with sleeves hi-vis side only without sleeves hi-vis side only

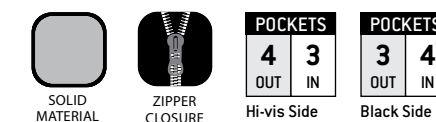

Water repellant 4-in-1 reversible quilted polyfil jacket // Removable, zip-out sleeves - converts Class 3 jacket to Class 2 vest // Reverses from hi-vis lime/black bottom to all black // Silver reflective tape on hi-vis side

RJR3310 • M, L, XL, 2XL, 3XL, 4XL, 5XL



## RJR34 Series ANSI •

TYPE R CLASS 3

with sleeves hi-vis side only without sleeves hi-vis side only

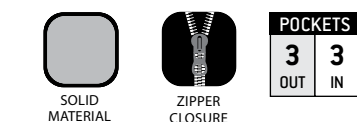

Water resistant 4-in-1 reversible windbreaker polyester jacket // Weatherproof elastic band at wrists // Removable, zip-out sleeves - converts Class 3 jacket to Class 2 vest // Reverses from hi-vis lime to gray/black // Silver reflective tape on hi-vis side // Hi-vis reflective piping on gray/black side // Bottom hem adjustment - bungee cord/toggle pull // Mic tab on hi-vis side

RJR3410 • M, L, XL, 2XL, 3XL, 4XL, 5XL



### RP31 Series ANSI •

TYPE R CLASS 3

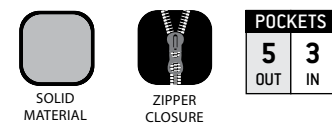

Weatherproof hi-vis parka // Polyester shell with zip out polar fleece liner // Elastic band at the wrists // Concealed detachable hood with drawstring // Zipper front closure // Interior access zipper for print customization // Cell phone/radio chest pocket with clear panel and 2 mic tabs // Drawstring around bottom

- RP3110 • M, L, XL, 2XL, 3XL, 4XL, 5XL
- RP3120 • M, L, XL, 2XL, 3XL, 4XL, 5XL



### RPB36 Series ANSI •

TYPE R CLASS 3



#### Outer Parka

Weatherproof hi-vis parka // Rip-stop polyester shell with quilted lining — Teflon™ treated // Elastic band at wrists // Concealed detachable hood with drawstring and slack adjustment // Interior access zipper for print customization // Dual zipper front closure with hook and loop storm flap // Badge lanyard, d-ring hook, and 2 mic tabs // Heat sealed seams // Drawstring around bottom

#### Inner Jacket

Hi-vis lime polyester fleece // Elastic band at wrists // Drawstring around bottom

- RPB3610 • M, L, XL, 2XL, 3XL, 4XL, 5XL



### RSSH32 Series ANSI •

TYPE R CLASS 3

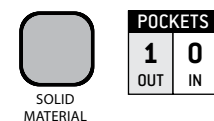

Hi-vis polyester fleece material // Elastic knit at wrists and waist // Pull over type sweat shirt with hood // Mesh lined hood with adjustable pull cord // 1 large front pocket

- RSSH3210 • M, L, XL, 2XL, 3XL, 4XL, 5XL



### RSZH32 Series ANSI •

TYPE R CLASS 3

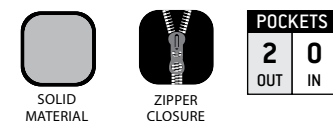

Hi-vis polyester fleece material // Elastic knit at wrists and waist // Mesh lined hood with adjustable pull cord // 2 outside pockets

- RSZH3210 • M, L, XL, 2XL, 3XL, 4XL, 5XL



### RSZH33 Series

TYPE R CLASS 3

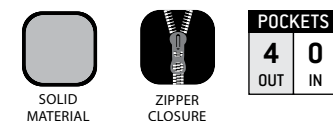

Weatherproof hi-vis polyester material — Teflon™ treated // Elastic band at the waist and wrists // Chest pocket with clear panel and hook and loop closure // 2 mic tabs // Drawstring hood // Zipper front closure

- RSZH3310 • M, L, XL, 2XL, 3XL, 4XL, 5XL
- RSZH3320 • M, L, XL, 2XL, 3XL, 4XL, 5XL

# HI-VIS TYPE R / CLASS 3 LEVEL 2 / CLASS 2



### RC7P35 Series ANSI • CSA •

CSA (LEVEL 2) CLASS 2 ANSI (TYPE R) CLASS 3

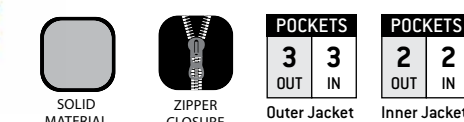

#### Outer Parka

Waterproof hi-vis parka // Polyester shell with quilted lining and black material on bottom and at storm cuffs // Heavy duty zipper front closure with snap storm flaps // Side zippers for greater range of motion // Concealed detachable hood with drawstring // Interior access zipper for print customization // Snaps to hold inner jacket in place // Inner and outer cell phone pocket, 2 storm flap snap pockets, and 2 mic tabs

#### Inner Jacket

Waterproof hi-vis orange polyester material with black on bottom and at cuffs— reverses from hi-vis orange to black // Heavy duty zipper front closure // Converts to vest with removable, zip-out elastic sleeves // Knit stand-up collar // Heat sealed seams // 2 storm flap snap pockets and 2 mic tabs

- RC7P3520 •• M, L, XL, 2XL, 3XL, 4XL, 5XL

**i** Inner jacket is non-rated when reversed and ANSI / ISEA Type R Class 2 when worn without sleeves.



### RCJ32 Series ANSI • CSA •

CSA (LEVEL 2) CLASS 2 ANSI (TYPE R) CLASS 3

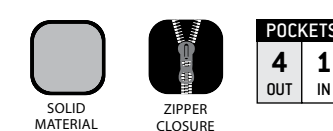

Weatherproof hi-vis polyester shell with quilted lining // Elastic band at the waist and wrists // Cell phone/radio chest pocket with clear panel, mic tabs and pencil pocket // Concealed hood // Zipper front closure

- RCJ3210 •• M, L, XL, 2XL, 3XL, 4XL, 5XL
- RCJ3220 •• M, L, XL, 2XL, 3XL, 4XL, 5XL



### RCP32 Series ANSI • CSA •

CSA (LEVEL 2) CLASS 2 ANSI (TYPE R) CLASS 3

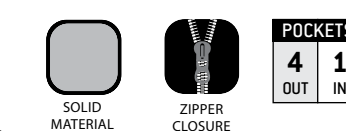

Weatherproof hi-vis parka // Polyester shell with quilted lining // Elastic band at the wrists // Cell phone/radio chest pocket with clear panel, mic tabs and pencil pocket // 2 storm flap snap pockets // Concealed hood // Zipper front closure

- RCP3220 •• M, L, XL, 2XL, 3XL, 4XL, 5XL



### RCSZH33 Series ANSI • CSA •

CSA LEVEL 2 CLASS 2 ANSI TYPE R CLASS 3

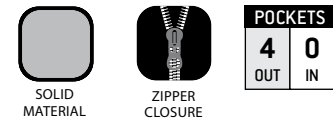

Weatherproof hi-vis polyester material — Teflon™ treated // Elastic band at the waist and wrists // Chest pocket with clear panel and hook and loop closure // 2 mic tabs // Drawstring hood // Zipper front closure

RCSZH3310 •• M, L, XL, 2XL, 3XL, 4XL, 5XL



### RCLTS31 Series ANSI • CSA •

CSA LEVEL 2 CLASS 2 ANSI TYPE R CLASS 3

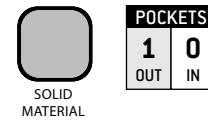

Lightweight hi-vis polyester moisture-wicking long sleeve t-shirt // Chest pocket // UPF30 protection

RCLTS3110 •• M, L, XL, 2XL, 3XL, 4XL, 5XL  
 RCLTS3111 •• M, L, XL, 2XL, 3XL, 4XL, 5XL  
 RCLTS3120 •• M, L, XL, 2XL, 3XL, 4XL, 5XL

**i** Black shirt is rated CAN/CSA Z96-15 Level 2 Class 1 and ANSI / ISEA Type 0 Class 1

## HI-VIS TYPE R / CLASS 2 LEVEL 2 / CLASS 2



### RCTS21 Series ANSI • CSA •

CSA LEVEL 2 CLASS 2 ANSI TYPE R CLASS 2

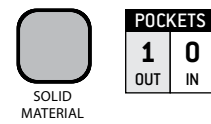

Hi-vis lightweight polyester moisture-wicking t-shirt // UPF30 protection

RCTS2110 •• M, L, XL, 2XL, 3XL, 4XL, 5XL



### RCZ21 Series ANSI • CSA •

CSA LEVEL 2 CLASS 2 ANSI TYPE R CLASS 2

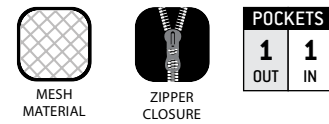

Hi-vis lightweight polyester mesh material

RCZ2110 •• M, L, XL, 2XL, 3XL, 4XL, 5XL  
 RCZ2120 •• M, L, XL, 2XL, 3XL, 4XL, 5XL



### RCZ24 Series ANSI • CSA •

CSA LEVEL 2 CLASS 2 ANSI TYPE R CLASS 2

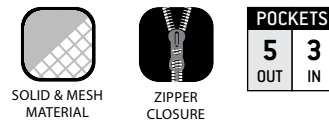

Hi-vis lightweight polyester solid material on front, mesh material on back // Mic tabs

RCZ2410 •• M, L, XL, 2XL, 3XL, 4XL, 5XL  
 RCZ2420 •• M, L, XL, 2XL, 3XL, 4XL, 5XL



### RCA25 Series ANSI • CSA •

CSA LEVEL 2 CLASS 2 ANSI TYPE R CLASS 2

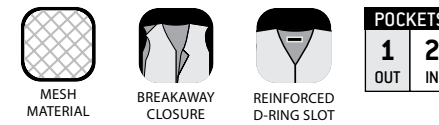

Hi-vis lightweight polyester mesh material // Breakaway hook and loop shoulders, sides and front closure // Adjustable waist band

RCA2510M •• Medium adjusts to XL  
 RCA2510X2 •• 2XL adjusts to 5XL  
 RCA2520M •• Medium adjusts to XL  
 RCA2520X2 •• 2XL adjusts to 5XL



### RCA27 Series ANSI • CSA •

CSA LEVEL 2 CLASS 2 ANSI TYPE R CLASS 2

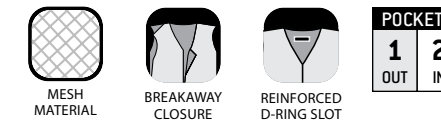

Hi-vis lightweight polyester mesh material // Breakaway hook and loop shoulders, sides and front closure // Adjustable waist band

RCA2710M •• Medium adjusts to XL  
 RCA2710X2 •• 2XL adjusts to 5XL  
 RCA2720M •• Medium adjusts to XL  
 RCA2720X2 •• 2XL adjusts to 5XL



### RCMS28 Series ANSI • CSA •

CSA LEVEL 2 CLASS 2 ANSI TYPE R CLASS 2



Hi-vis solid polyester // Metal snap front closure // Metal grommets on upper front collar trim // Reach-through pocket on back with zipper closures // Flashlight pocket // Mic tabs

RCMS2810 •• M, L, XL, 2XL, 3XL, 4XL, 5XL



### RCA25SE Series ANSI • CSA •

CSA LEVEL 2 CLASS 2 ANSI TYPE R CLASS 2 NOT FR



Hi-vis self-extinguishing lightweight polyester mesh material // Breakaway hook and loop shoulders, sides and front closure // Adjustable waist band

RCA2510SEM •• Medium adjusts to XL  
 RCA2510SEX2 •• 2XL adjusts to 5XL  
 RCA2520SEM •• Medium adjusts to XL  
 RCA2520SEX2 •• 2XL adjusts to 5XL



### RCA27SE Series ANSI • CSA •

CSA LEVEL 2 CLASS 2 ANSI TYPE R CLASS 2 NOT FR



Hi-vis self-extinguishing lightweight polyester mesh material // Breakaway hook and loop shoulders, sides and front closure // Adjustable waist band

RCA2710SEM •• Medium adjusts to XL  
 RCA2710SEX2 •• 2XL adjusts to 5XL  
 RCA2720SEM •• Medium adjusts to XL  
 RCA2720SEX2 •• 2XL adjusts to 5XL



### RCMS28SE Series ANSI • CSA •

CSA LEVEL 2 CLASS 2 ANSI TYPE R CLASS 2 NOT FR



Hi-vis self-extinguishing solid polyester // Metal snap front closure // Metal grommets on upper front collar trim // Reach-through pocket on back with zipper closures // Flashlight pocket // Mic tabs

RCMS2810SE •• M, L, XL, 2XL, 3XL, 4XL, 5XL

**i** Vest with SE icon are not flame resistant as defined by ANSI/ISEA 107-2015 Section 10.5, but are chemically treated to be self-extinguishing.

# HI-VIS NON-RATED



## RTS21NS Series NON-RATED

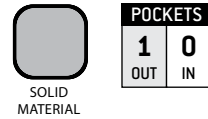

Hi-vis lightweight polyester moisture wicking t-shirt // UPF30 protection

RTS2110NS M, L, XL, 2XL, 3XL, 4XL, 5XL



## RLTS31NS Series NON-RATED

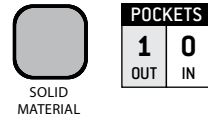

Hi-vis lightweight polyester moisture wicking long sleeve t-shirt // UPF30 protection

RLTS3110NS M, L, XL, 2XL, 3XL, 4XL, 5XL



Ridgeline® / PMXTREME® / CBD12PK / RTS2110NS



## RV1 Series NON-RATED



Hi-vis lightweight polyester mesh material // Elastic side straps

RV110 One Size Fits Most  
RV120 One Size Fits Most



## RV1NS Series NON-RATED



Hi-vis lightweight polyester mesh material // Elastic side straps

RV110NS One Size Fits Most  
RV120NS One Size Fits Most



## RH1 Series NON-RATED

100% acrylic knit cap // Reflective stripe

RH110 One Size Fits Most  
RH120 One Size Fits Most



1 Outer Parka



2 Outer Parka & Inner Jacket



3 Outer Parka & Inner Jacket without Sleeves



4 Inner Jacket



5 Inner Jacket Reversed



6 Inner Jacket without Sleeves



7 Inner Jacket without Sleeves Reversed



## 7-IN-1 PARKA

For more information, see page 123.



# GLOVES 128 – 135

CORXCEL™ 130 – 132

ARCHONX™ 132 – 133

POLY-TORQ™ 133

IMPACT-HEAVY DUTY 134 – 135

MEDIUM DUTY 135

LIGHT DUTY 135



A



B



C

A – GL402C5  
B – GL802CR  
C – GL604C5

# WHAT YOU NEED TO KNOW

## Glove Certifications

Pyramex work gloves have been independently tested for various standards and certifications. Use the quick key (ANSI • CE • ) on the following pages to reference product models that meet these standards and certifications. Use the dots next to each part number to reference which options meet the standards and certifications.

ANSI/ISEA 105-2016 •  
EN388:2003 •  
EN388:2016 •

## ANSI/ISEA 105-2016

ANSI standard features cut ratings that range from A1 through A9. Cut ratings are based on the grams of weight needed to cut through the material. Our ANSI cut level glove options include A2 (500-999 grams to cut), A3 (1,000-1,499 grams to cut) and A4 (1,500-2,199 grams to cut).

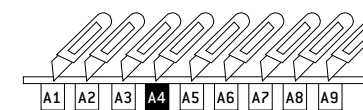

## CE EN388:2003

CE EN388 standard features abrasion, cut, tear and puncture ratings. Abrasion ratings are based on the number of cycles required to abrade through the sample glove. Cut ratings are based on the number of cycles required to cut through the sample at a constant speed. Tear ratings are based on the amount of force required to tear the sample. Puncture ratings are based on the amount of force required to pierce the sample with a standard-sized point.

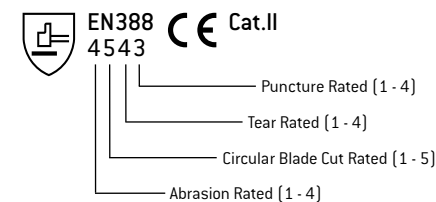

## CE EN388:2016

The TDM-100 Test is an additional cut test. This test is done after the first 60 rotations of the Coup test to assess the durability of a glove more accurately. Levels include A (200-508 grams), B (509-1019 grams), C (1020-1529 grams), D (1530-2242 grams), E (2243-3058 grams) and F (3059+ grams). The new standard also features an Impact Protection Test. This test is only for gloves that are intended to provide impact protection. The Impact rating is based on the amount of impact energy (5 joules) dropped on the surface of the glove. Ratings include P (pass), F (failed), and X (not tested).

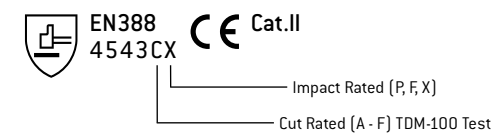

**i** Pyramex gloves that comply with the EN388:2003 standard can still be sold. As we move forward, we will start testing to the current 2016 standards.

## Dipped Glove Sizing

The color of the binding around the cuff indicates the glove size.



## Selection Chart

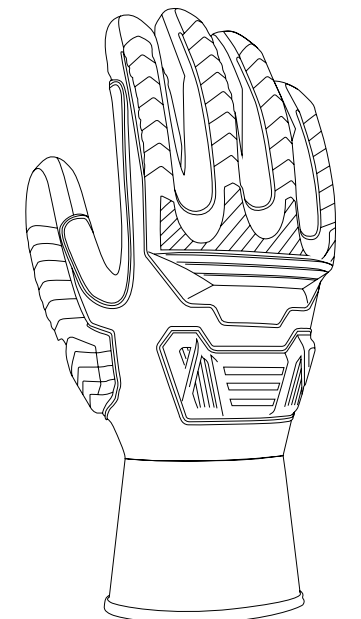
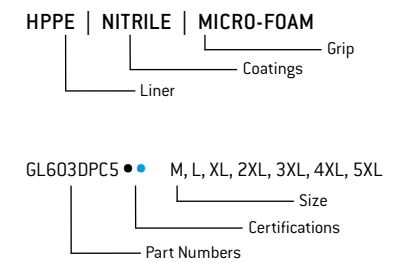

# GLOVES DIPPED



Ridgeline® / PMXTREME® LED / GL602C3

## WHY NITRILE?

LATEX ALTERNATIVE // ABSORBS OIL // OUTSTANDING GRIP



SANDY & SMOOTH



SANDY



MICRO-FOAM



MICRO-FOAM WITH DOTTED PALM



## WATCH THE VIDEO

Vimeo.com/Pyramex/DippedGloves

## CorXcel™



### GL605 Series CE •

EN388:2016 4131X CE Cat.II

POLYESTER | NITRILE | SANDY & SMOOTH

15 gauge polyester liner // Full dipped smooth nitrile for liquid protection // Sandy nitrile palm gives outstanding grip in dry, wet and oily conditions // Tear and abrasion resistant

GL605 • S, M, L, XL, 2XL



### GL604C5 Series ANSI • CE •

EN388:2003 4543 EN388:2016 4X43D CE Cat.II

HPPE | NITRILE | SANDY

13 gauge cut-resistant HPPE liner // Sandy coating gives outstanding grip in dry, wet and oily conditions // Tear and abrasion resistant

GL604C5 • S, M, L, XL, 2XL



### GL603DPC5 Series ANSI • CE •

ANSI CUT LEVEL A4 EN388:2016 4X43D CE Cat.II

HPPE | NITRILE | MICRO-FOAM WITH DOTTED PALM

13 gauge cut-resistant HPPE liner // Dotted palm // Reinforced thumb // Tear and abrasion resistant // Black color does not show dirt or grime // Foam nitrile absorbs oil to increase grip // Additional foam coating acts like a sponge, helps increase gripping power

GL603DPC5 • S, M, L, XL, 2XL



### GL603C5 Series ANSI • CE •

ANSI CUT LEVEL A4 EN388:2003 4543 EN388:2016 4X43D CE Cat.II

HPPE | NITRILE | MICRO-FOAM

13 gauge cut-resistant HPPE liner // Tear and abrasion resistant // Black color does not show dirt or grime // Foam nitrile absorbs oil to increase grip // Additional foam coating acts like a sponge, helps increase gripping power

GL603C5 • S, M, L, XL, 2XL



### GL602C3 Series ANSI • CE •

ANSI CUT LEVEL A2 EN388:2003 4342 EN388:2016 4X42B CE Cat.II

HPPE | NITRILE | MICRO-FOAM

13 gauge cut-resistant HPPE liner // Tear and abrasion resistant // Foam nitrile absorbs oil to increase grip // Additional foam coating acts like a sponge, helps increase gripping power

GL602C3 • S, M, L, XL, 2XL



GL603C5

## CorXcel™



### GL601DP Series CE •

EN388:2016 4131X CE Cat.II

NYLON & SPANDEX | NITRILE | MICRO-FOAM WITH DOTTED PALM

15 gauge nylon and spandex liner (silicone free) // Dotted palm // Reinforced thumb // Tear and abrasion resistant // Foam nitrile absorbs oil to increase grip // Additional foam coating acts like a sponge, helps increase gripping power // Offers tactile sensitivity and dexterity

GL601DP • S, M, L, XL, 2XL



### GL601 Series CE •

EN388:2003 4131 EN388:2016 4131X CE Cat.II

NYLON & SPANDEX | NITRILE | MICRO-FOAM

15 gauge nylon and spandex liner (silicone free) // Tear and abrasion resistant // Foam nitrile absorbs oil to increase grip // Additional foam coating acts like a sponge, helps increase gripping power // Offers tactile sensitivity and dexterity

GL601 • S, M, L, XL, 2XL

## ArchonX™



### GL501C5 Series ANSI • CE •

ANSI CUT LEVEL A4 EN388:2003 3542 EN388:2016 3X42D CE Cat.II

HPPE | LATEX | CRINKLE

13 gauge cut-resistant HPPE liner // Tear and abrasion resistant // High elasticity and grip // Crinkle latex palm suited for wet and dry conditions // Flexible and durable over a wide range of temperatures

GL501C5 • S, M, L, XL, 2XL



GL402C5



RSSH3210 / GL501C5

## ArchonX™



### GL502 Series CE •

EN388:2016 3131X CE Cat.II

NYLON | LATEX | SANDY & SMOOTH

13 gauge nylon liner // Waterproof // Tear and abrasion resistant // High elasticity and grip // Full dipped smooth latex for liquid protection // Sandy latex palm suited for wet and dry conditions // Flexible and durable over a wide range of temperatures

GL502 • S, M, L, XL, 2XL

## Poly-Torq™



### GL402C5 Series ANSI • CE •

ANSI CUT LEVEL A4 EN388:2003 4543 EN388:2016 4X43D CE Cat.II

HPPE | POLYURETHANE | SMOOTH

13 gauge cut-resistant HPPE liner // Tear and abrasion resistant // Low particulate shed // Grips well without being sticky // Offers tactile sensitivity and dexterity

GL402C5 • S, M, L, XL, 2XL



### GL401 Series CE •

EN388:2003 4131 EN388:2016 4131X CE Cat.II

NYLON | POLYURETHANE | SMOOTH

13 gauge nylon liner // Tear and abrasion resistant // Low particulate shed // Grips well without being sticky // Offers tactile sensitivity and dexterity

GL401 • S, M, L, XL, 2XL

**WHY POLYURETHANE?**  
EXCELLENT VALUE WORK GLOVE // LOW PARTICULATE SHED // TACTILE SENSITIVITY AND DEXTERITY

SMOOTH

## WHY LATEX?

FLEXIBILITY IN EXTREME TEMPERATURES // TEAR RESISTANT // SUITED FOR WET AND DRY CONDITIONS

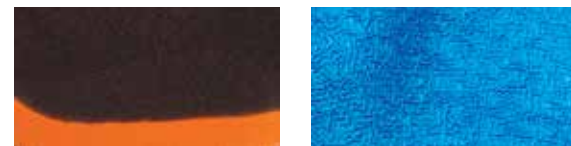

SANDY & SMOOTH

CRINKLE

# GLOVES SYNTHETIC LEATHER



Ridgeline® / V2G Plus® / RP3001 / RVHL2510BRD / GL802CR



## GL802CR Series ANSI • CE •

ANSI CUT LEVEL A3 EN388:2003 3541 CE Cat.II

### ULTRA IMPACT — HEAVY DUTY — CUT-RESISTANT

Cut-resistant inner liner // Two layers of stretchable spandex on back for added comfort // TPR impact protection on back of fingers and knuckles // Rough PVC palm for high abrasion protection and good grip // High visibility colors // Longer neoprene cuff to cover shirt/coverall cuffs

GL802CR • S, M, L, XL, 2XL

## Glove Clips

Keeps gloves handy by clipping to your belt loop or tool belt // Breakaway feature for safety

GLC100  
GLC120



## WHY SYNTHETIC LEATHER?

RESISTANT TO ABRASION // LONGER-LASTING DURABILITY



TPR IMPACT PROTECTION



PVC PALM



## GL801 Series CE •

EN388:2003 3141 CE Cat.II

### ULTRA IMPACT — HEAVY DUTY

TPR impact protection on back of fingers and knuckles // Two layers of stretchable spandex on back for added comfort // Rough PVC palm for high abrasion protection and good grip // High visibility colors // Longer neoprene cuff to cover shirt/coverall cuffs

GL801 • S, M, L, XL, 2XL



Ridgeline® / Accurist® / RVHL2510BRD / GL801



## GL201 Series CE •

EN388:2003 2121 CE Cat.II

### IMPACT — MEDIUM DUTY

Two layers of stretchable spandex on back for added comfort // TPR on three fingers for impact protection // EVA on index finger back for anti-shock protection // PVC patches with EVA padding on palm for good abrasion and vibration resistance // Soft terry cloth on the back of the thumb for brow-wiping

GL201 • S, M, L, XL, 2XL



## GL102 Series CE •

EN388:2003 3241 CE Cat.II

### MATERIAL HANDLING — LIGHT DUTY

Two layers of stretchable spandex plus mesh fabric on back for comfort and breathability // Touch screen function on two fingers and thumb // Silicone patch on palm for anti-slip and better grip // Thick embossed neoprene on knuckle for added protection // Synthetic leather patches on palm for added protection and comfort

GL102 • S, M, L, XL, 2XL

# COOLING

136 – 139

MOISTURE-WICKING 138

EVAPORATIVE 138 – 139



A



B



C

# WHAT YOU NEED TO KNOW

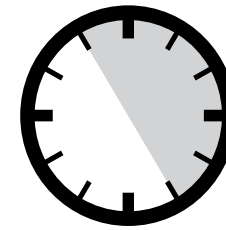

## The Hours Matter

The most dangerous heat hours are between 11 am – 5pm. Schedule frequent rest breaks to ensure you will not overheat.

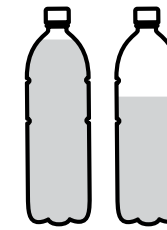

## Drink More Water

Drink about 1 cup of water every 15 to 20 minutes to prevent heat related stress or injury. Drink water before becoming thirsty.

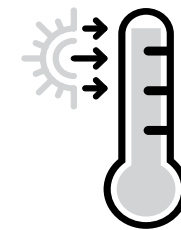

## Know The Symptoms

Be aware of the signs and symptoms of heat-induced illnesses. Heat causes more deaths than any other weather-related hazards.



## The Right Clothing

Wear clothing that is breathable, lightweight, and loose-fitting. Cooling products work as an additional relief from the heat.

## Selection Chart

	CBD12PKBLU	
	CBD12PKDC	One size fits most
	CBD12PKLIME	
	CBD12PKSTAR	

Size

Part Numbers

Colors / Patterns

A – GL801 / CBD12PK / I-Force® / RTS2110NS

B – Ridgeline® / CNS1 / RCA2720

C – C330 / Atwater® / DP3000 / RTS2310

Source: OSHA Occupational Heat Exposure

# COOLING MOISTURE-WICKING



## C330 Series NON-RATED

Moisture-wicking towel // Microfiber material // Hi-vis material for greater visibility // Provides hours of cooling relief by regulating core body temperature // Reusable – simply soak in cool water // Machine washable



 C330 11.5 x 33 inches



American Flag Pattern

## CSK1 Series NON-RATED



Skull cap // Moisture-wicking soft material // Traps sweat, keeping it out of your eyes // Fits under hard hats // Machine washable

 CSK111  
 CSK1FLG One size fits most



## CSKT2 Series NON-RATED

Skull cap with ties // Moisture-wicking soft material // Traps & absorbs sweat, keeping it out of your eyes // Designed for easy tying // Machine washable

 CSKT212  
 CSKT260 One size fits most







American Flag Pattern

Digital Camo Pattern

## CBD12PK Series NON-RATED

Cooling bandanas // Evaporative advanced PVA material liner provides hours of heat stress relief // Conveniently ties around neck or head // To activate, simply soak in cool water // Reusable – just reactivate // Machine washable

 CBD12PKBLU  
 CBD12PKDC  
 CBD12PKLIME  
 CBD12PKSTAR One size fits most



## CPH160 Series NON-RATED

Cooling hard hat pad // Evaporative cooling material provides hours of heat stress relief // Fits on the suspension of cap style and full brim hard hats with hook and loop closures // To activate, soak in cool water // Reusable – just reactivate // Shown with Ridgeline® hard hat – sold separately

 CPH160 One size fits most



## CNS1 Series NON-RATED

Cooling hard hat pad and neck shade // Soft evaporative quilted cooling material keeps your head cool and blocks sun from your neck // Hi-vis material for greater visibility // Fits on the suspension of cap style and full brim hard hats with hook and loop closures // To activate, soak in cool water // Reusable – just reactivate // Shown with Ridgeline hard hat – sold separately

 CNS130  
 CNS140 One size fits most

# COOLING EVAPORATIVE



## HPSHADE Series NON-RATED

Hard hat brim with neck shade // Soft lightweight material // Hi-vis material for greater visibility // Blocks sun from your face and neck on job sites lacking other forms of shade // Fits on the outside of cap style and full brim hard hats // Shown with Ridgeline® hard hat – sold separately

 HPSHADE30 One size fits most



## C160 Series NON-RATED

Cooling towel // Evaporative advanced PVA material holds water without feeling heavy // Anti-microbial treated to help prevent mold build-up and unwanted odors // To activate, simply soak in cool water // Reusable – just reactivate // Machine washable

 C160 26 x 17 inches



## C260 Series NON-RATED



Cooling towel wrap // Evaporative advanced PVA material holds water without feeling heavy // Anti-microbial treated to help prevent mold build-up and unwanted odors // Use as a neck wrap by pulling end of wrap through slit // To activate, simply soak in cool water // Reusable – just reactivate // Machine washable

 C260 26 x 8.5 inches



## CV100 Series NON-RATED

Cooling vest // Evaporative PVA panels keep you cool for up to 8 hours // Quilted outer shell is made from soft polyester // Zipper front closure // Adjustable waist band // Reusable and washable // Submerge in cool water 1-2 minutes before wearing to activate



 CV100M Medium adjusts to XL  
 CV100X2 2XL adjusts to 5XL



## CV200 Series ANSI •

TYPE R CLASS 2

Cooling vest // Evaporative PVA panels keep you cool for up to 8 hours // 2" silver reflective material // Quilted outer shell is made from soft polyester // Zipper front closure // Adjustable waist band // Reusable and washable // Submerge in cool water 1-2 minutes before wearing to activate

 CV200M • Medium adjusts to XL  
 CV200X2 • 2XL adjusts to 5XL

 CV200 meets ANSI/ISEA 107-2015. See page 115 for more information.



Ridgeline® / CM6010 / CNS1 / RTS2110

# ERGONOMICS 140 – 143

BACK SUPPORT 142

ELBOW SLEEVE 142

KNEE PADS 143

WRIST WRAP 143



A



B



C

# WHAT YOU NEED TO KNOW

## Why Ergonomics?

According to the Bureau of Labor Statistics, sprains, strains or tears are the most common type of injury involving days off work. The back is the body part most frequently affected followed by hand injuries. Leading causes of work-related injuries includes: misuse of equipment, overexertion, and slips, trips and falls.

## Back Support

Stabilizes the spine, supports the abdomen and lower back, and prompts proper lifting.

## Wrist Wrap

Helps immobilize the joint and provides heat and compression to the wrist, bones, and joints.

## Elbow Sleeve

Helps the blood circulate better and reduces recovery time from injury.

## Knee Pads

Helps protect injury from falls and provides padding for extended kneeling.

## Selection Chart

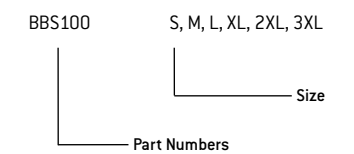

## Lift Like You Should

### Bend Your Knees

Keep your back straight and use back support. Let your legs do the lifting.

### Prevent Injuries

Avoid twisting at the waist. Make sure your feet, knees, and torso are pointed in the same direction when lifting.

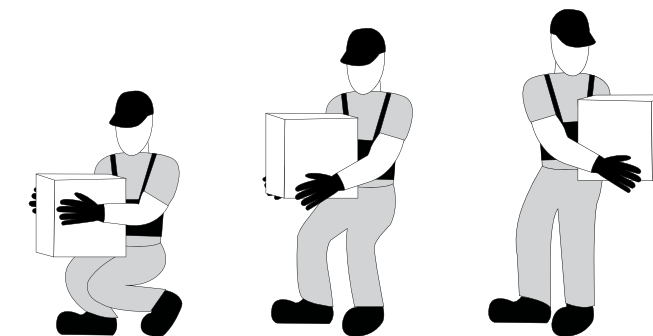

### Good Grip

Keep the weight of the object close as you straighten to a standing position.

A – Back support

B – BKP200

C – RH110 / Fyxate™ / GL102 / RSSH3210 / BKP100



## ERGONOMICS BACK SUPPORT



### BBS100 Series NON-RATED

General use back support – economy weight // Constructed from lightweight, durable material // Plastic support stays // Features breakaway suspenders // 2 overlap style adjustable panels // Contoured shape allows flexibility and complete freedom of movement // Washable and shrink resistant

BBS100 S, M, L, XL, 2XL, 3XL

## ERGONOMICS KNEE PADS



### BKP100 Series NON-RATED

Economy light duty knee pads // Wide and long for wraparound comfort // Durable 600D polyester fabric cover // 15mm closed cell foam padding // Injection plastic button/clip strap connectors provide easy adjustment and secure fit // Washable and shrink resistant

BKP100 One Size Fits Most



### BKP200 Series NON-RATED

Hard cap knee pads // Smooth hard cap attached with nickel plated grommets easily slides over various surfaces // Durable 600D polyester fabric // 15mm EVA foam padding // Anti-bacterial treatment // Injection plastic button/clip strap connectors provide easy adjustment and secure fit // Washable and shrink resistant

BKP200 One Size Fits Most

## ERGONOMICS ELBOW SLEEVE



### BES500 Series NON-RATED

Ambidextrous elbow sleeve with strap // Buckle with hook and loop closure and adjustable cinch strap // Neoprene four-way stretch fabric provides uniform support and warmth // Binding and pre-curve design with spandex mesh behind the elbow // Washable and shrink resistant

BES500 S, M, L, XL, 2XL

## ERGONOMICS WRIST WRAP



### BWS500 Series NON-RATED

Wrist wrap with thumb restrainer // Ambidextrous, neoprene four-way stretch fabric provides uniform support and warmth // Straps are made from durable woven elastic for support and comfort // Hook and loop closure // Washable and shrink resistant

BWS500 S, M, L, XL





# THE PYRAMEX PROMISE

At Pyramex, our promise to our customers is to provide the best possible products, the best possible service, and most importantly, an attitude of making our customers' lives easier on a day-to-day basis. Our values challenge us toward a commitment to truth and to deliver what we promise.





THERE'S MORE TO SEE AT  
**PYRAMEXSAFETY.COM**