

# ALNÔBAÔDWADA ABENAKI LANGUAGE RESOURCE

Alatstak awighigan (a coloring book)



**Alnôbaôdwa nspiwi nia!**

Speak Abenaki with me!

# AGIZOWÔGANAK

2023  
AMBLI  
WLÔMKIHLA

## NUMBERS

**1**

PAZEKW

**2**

NIS

**3**

NAS

**4**

IAW

**5**

NÔLAN

**6**

NGWEDÔZ

**7**

TÔBAWÔZ

**8**

NSÔSEK

**9**

NOLIWI

**10**

MDALA

**11**

NGWEDONKAW

**12**

NISÔNKAW

**13**

NSÔNKAW

**14**

IAWÔNKAW

**15**

NÔNNÔNKAW

**16**

NGWEDÔZ  
KASÔNKAW

**17**

TÔBAWÔZ  
KASÔNKAW

**18**

NSÔSEK  
KASÔNKAW

**19**

NOLIWI  
KASÔNKAW

**20**

NISINSKA

# AGIMA NA COUNT NA ONES

pazgo  
kwat



niswak  
wôkwsesak



nhloak  
chegwalak

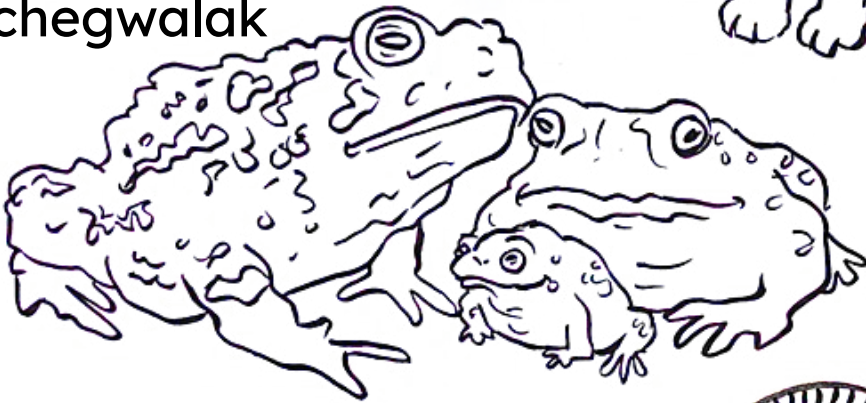

iawak  
pakholigana

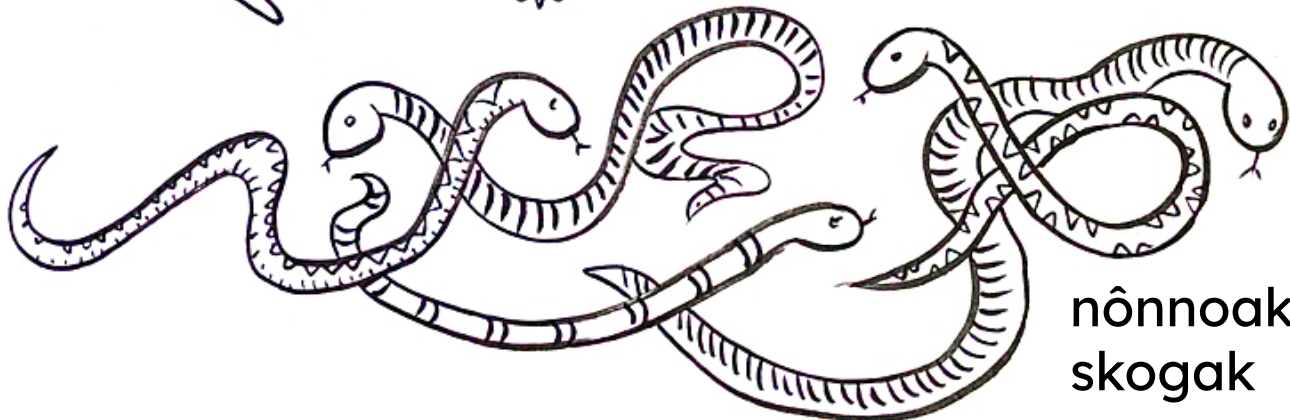
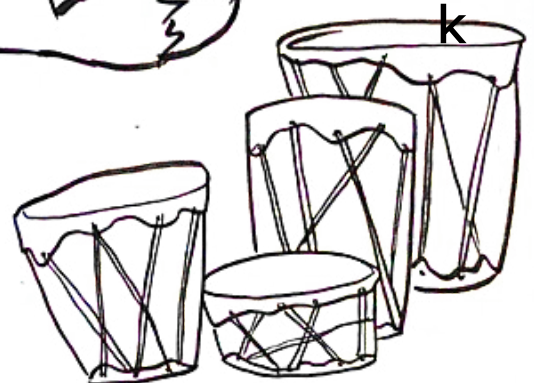

nônnoak  
skogak

# AGIDA NI COUNT NI THINGS

pazgwen  
sen

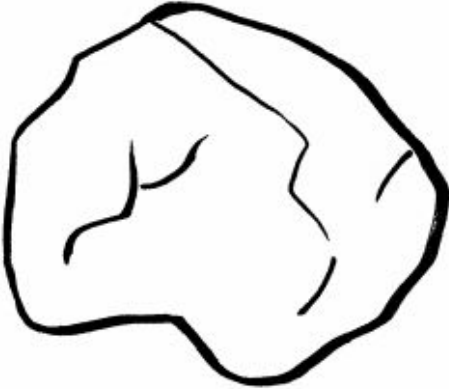

nisnol  
satal



iawnol  
mozôbial

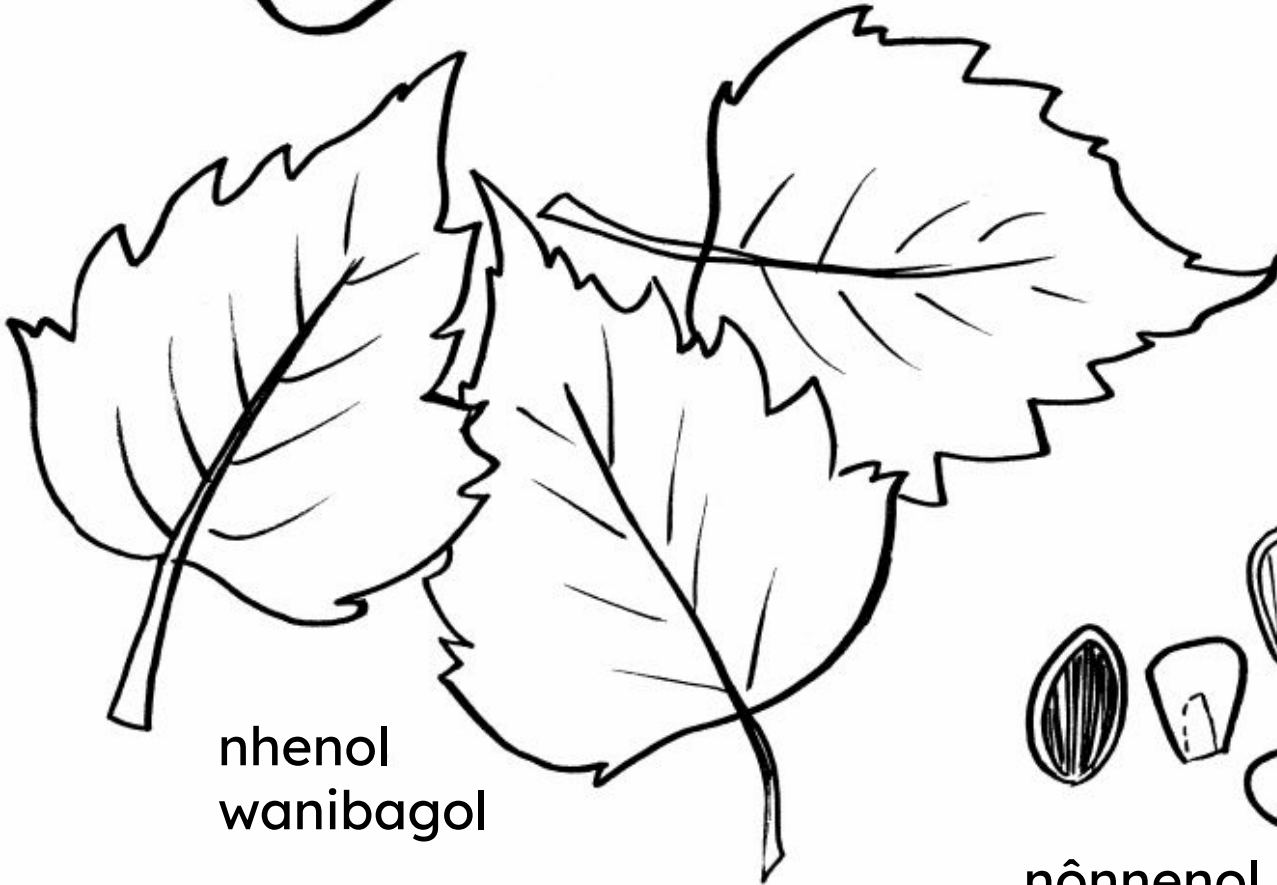

nhenol  
wanibagol



nônnenol  
wskimenal

# ACHIGANAL COLORS

MKWIGO  
TAHÔLAWI NA  
MSKIKOIMIN



RED  
LIKE THAT  
STRAWBERRY

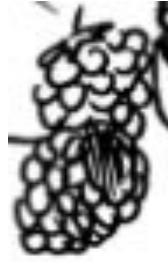

MINÔBOWIGOAK  
TAHÔLAWI NIGIK  
PSAGWDAMENAK

PURPLE  
LIKE THOSE  
BLACKBERRIES

WIZÔWIGO  
TAHÔLAWI NA  
MOLSEM

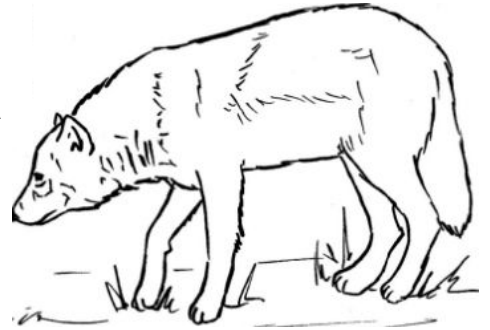

GREY  
LIKE THAT  
WOLF

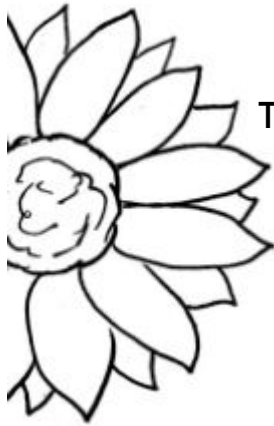

WIZÔWIGEN  
TAHÔLAWI NI  
KIZOSÔGAN

YELLOW  
LIKE THAT  
SUNFLOWER

ASKASKWIGEN  
TAHÔLAWI NI  
WANIBAKW



GREEN  
LIKE THAT  
LEAF

WÔBIGEN  
TAHÔLAWI NI  
PILASKW

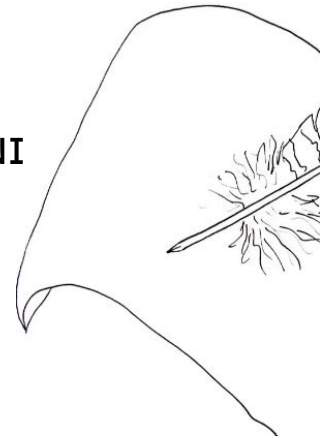

WHITE  
LIKE THAT  
PAPER

PEGWIGEN  
TAHÔLAWI NI  
ABAZI



BROWN  
LIKE THAT  
STICK

WLÔWIGENAL  
TAHÔLAWI NILIL  
SATAL



BLUE  
LIKE THOSE  
BLUEBERRIES

MKAZAWIGO  
TAHÔLAWI NA  
ALIKWS

BLACK  
LIKE THAT  
ANT



# TOLBA SPIWI KIZOSAK TURTLE WITH MONTHS

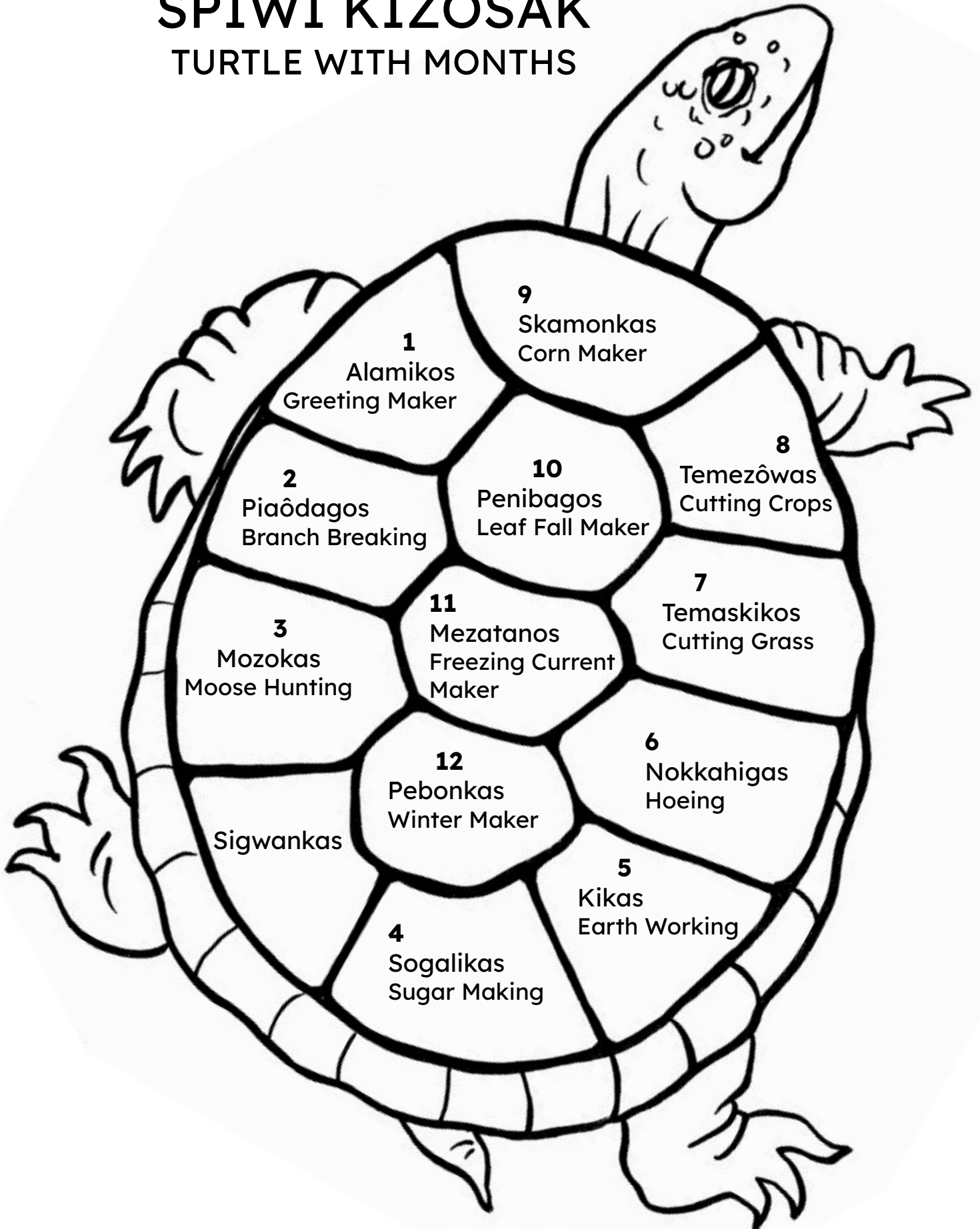

# Kizokol

## Days of the week

ngwedsanda

Sanda	Sunday
Kizsanda	Monday (after Sunday)
Nisda alokan	Tuesday (2nd work day)
Nseda alokan	Wednesday (3rd work day)
Iawda alokan	Thursday (4th work day)
Skawatekwigisgat	Friday (Day of the Cross)
Kadawsanda	Saturday (before Sunday)

wlôgwa



yesterday



pamkisgat

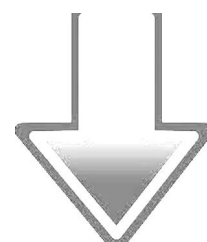

today



saba

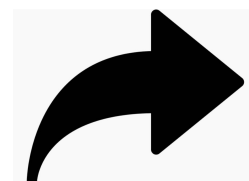

tomorrow

**kizokw**  
day

kizgadawi  
during day



spôzowiwi  
morning

wlôgwiwi  
evening

wôban  
daybreak



nakihlôt  
kizos  
sunset



nanipôsat  
moon

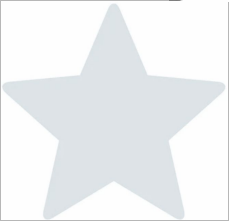

alakws  
star

nibôwiwi  
during night

**tebokw**  
night



# SIBSAK NIGIK

## THOSE ARE BIRDS

KWIKWESKAS NA  
THAT IS A ROBIN

TAGWÔGWIHLAS NA  
THAT IS A GROSBEAK



CHIGSIS NA  
THAT IS A GOLDFINCH

KESILOWIS NA  
THAT IS A SPARROW

SPIGWÔLOASIS  
NA  
THAT IS A WREN

# **MINA SIBSAK NIGIK**

THOSE ARE MORE BIRDS

**KASKALJAS NA**  
THAT IS A SPARROW

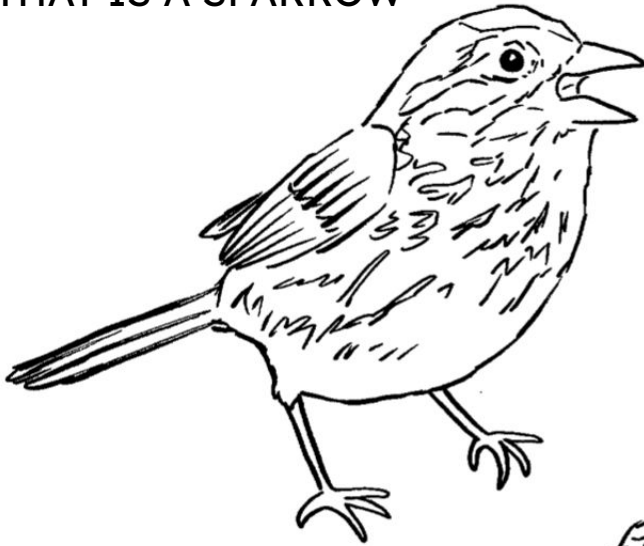

**WLÔGOWIHLAS NA**  
THAT IS A NIGHTENGALE

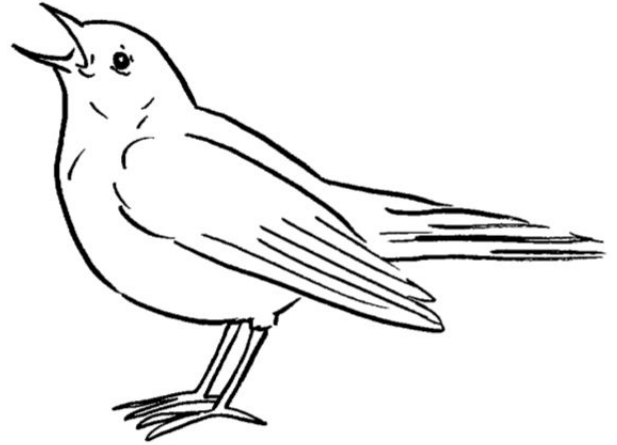

**PAKESSO NA**  
THAT IS A PARTRIDGE

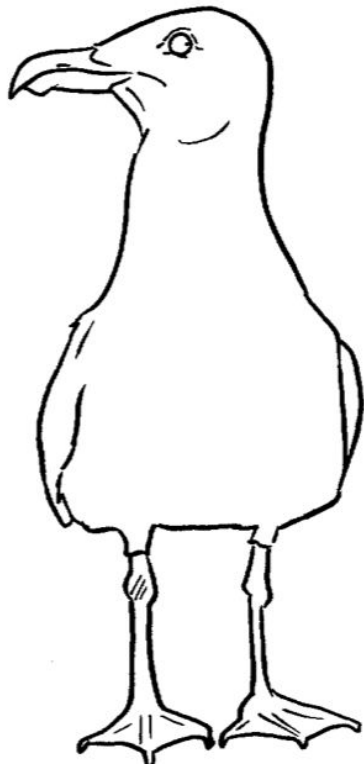
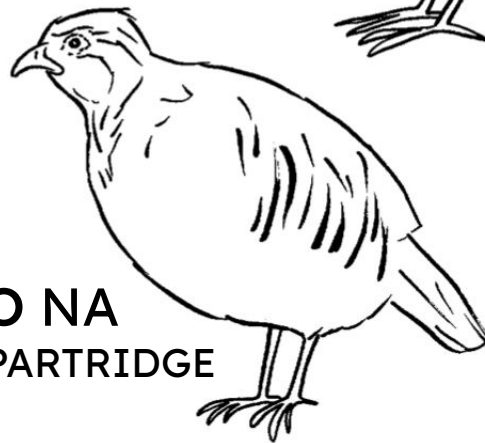

**KAAKW NA**  
THAT IS A SEAGULL

**MKAZAS NA**  
THAT IS A CROW

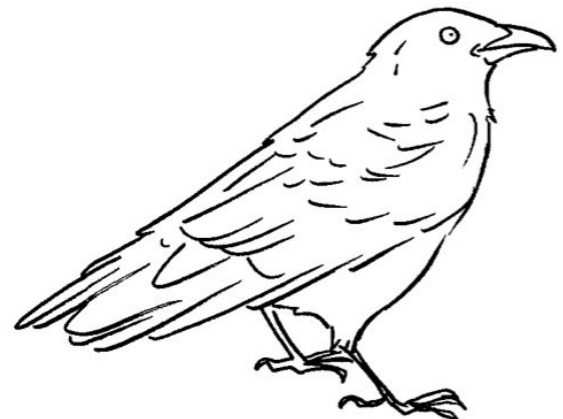

**MADAGENIHLAS NA**  
THAT IS A BAT



**KOKOKHASAK NIGIK**  
THOSE ARE OWLS



**MASKWAMOSI NA**  
**THAT IS A BIRCH TREE**

**MASKWAMOSIAK NIGIK**  
**THOSE ARE BIRCH TREES**



**NAHAMA NA**  
**THAT'S A TURKEY**

**WANIBAGOL NILIL**  
**THOSE ARE LEAVES**

**ABAZI NI**  
**THAT IS A BRANCH**

**SIBOSIS NI**  
THAT IS A STREAM

**MEDAWIHLA NA**  
THAT IS A LOON

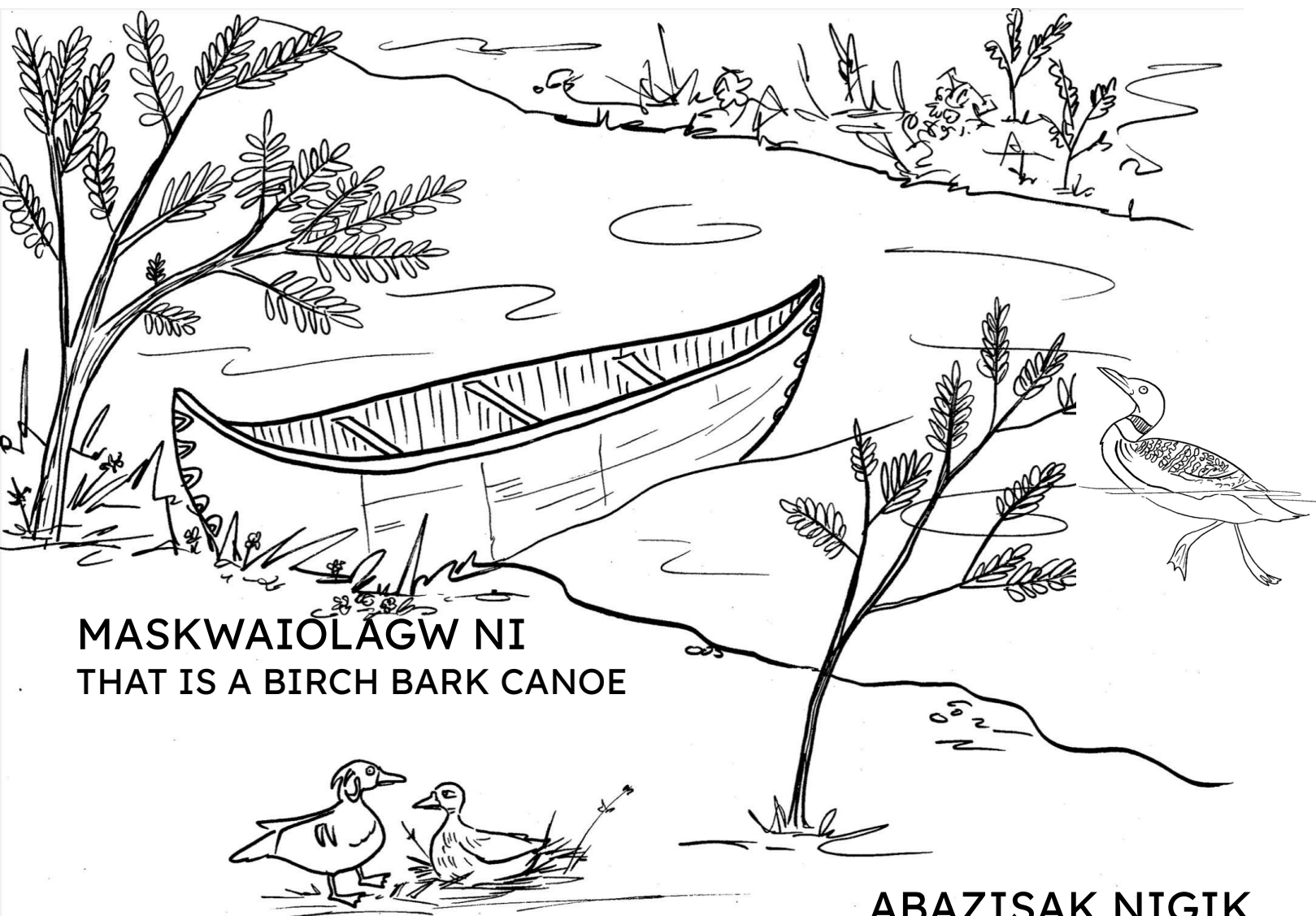

**MASKWAIOLAGW NI**  
THAT IS A BIRCH BARK CANOE

**KWIGWIGEMOK NIGIK**  
THOSE ARE BLACK DUCKS

**ALÔNTEGWILHAK  
NIGIK**  
THOSE ARE WOOD DUCKS

**ABAZISAK NIGIK**  
THOSE ARE SHRUBS

**ABAZISAL NILIL**  
THOSE ARE LITTLE  
STICKS

**SIGWANIHLA NA**  
THAT IS A HAWK

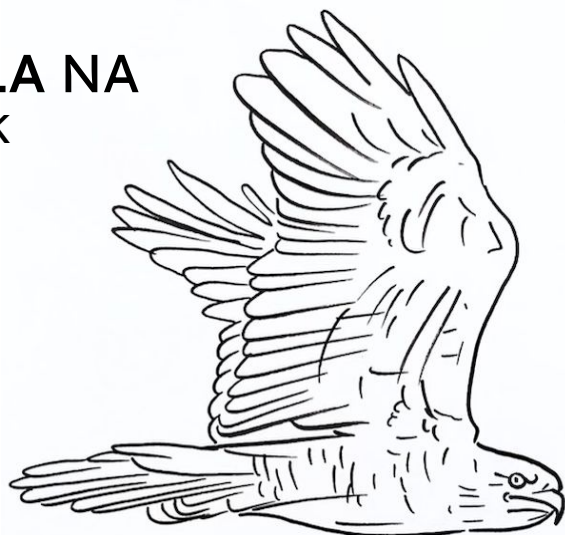

**WAJO NI**  
THAT IS A MOUNTAIN

**MEGESO MAMASAGÔDEBA NA**  
THAT IS AN EAGLE BALD-HEADED

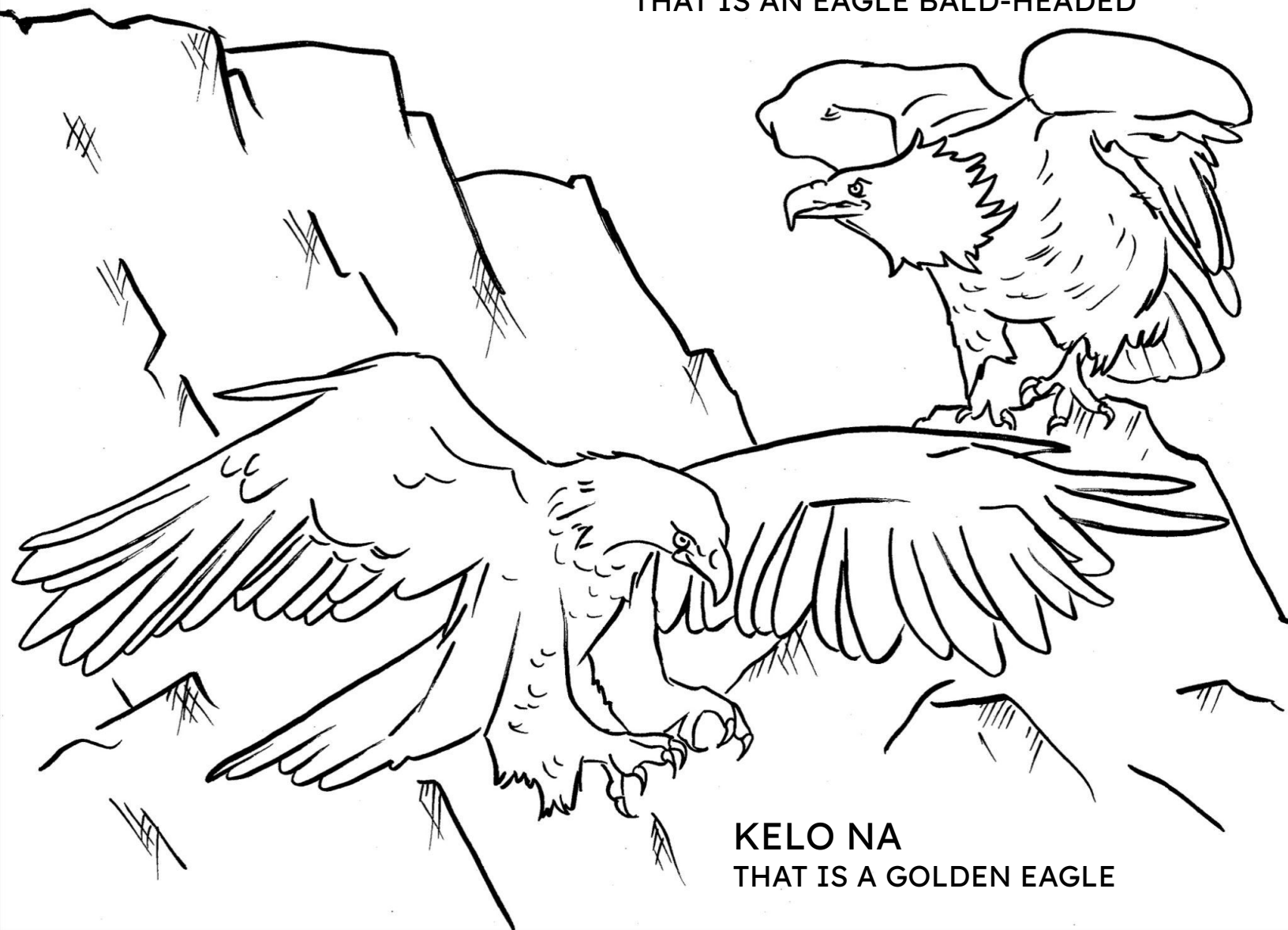

**KELO NA**  
THAT IS A GOLDEN EAGLE

**AWASOS NA**  
THAT IS A BEAR



**WÔBTEGWA NA**  
THAT IS A GOOSE

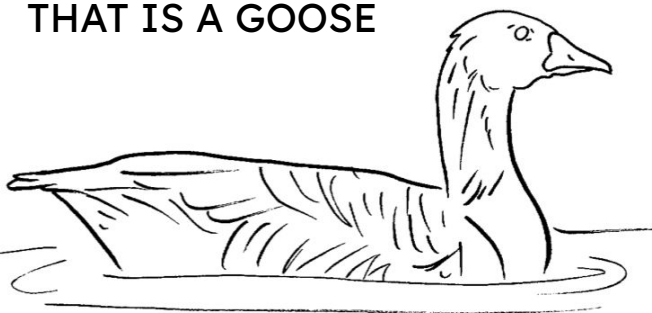

**MKWAMAGW NA (NAMAS)**  
THAT IS A SALMON (FISH)

**TMAKWA NA**  
THAT IS A BEAVER

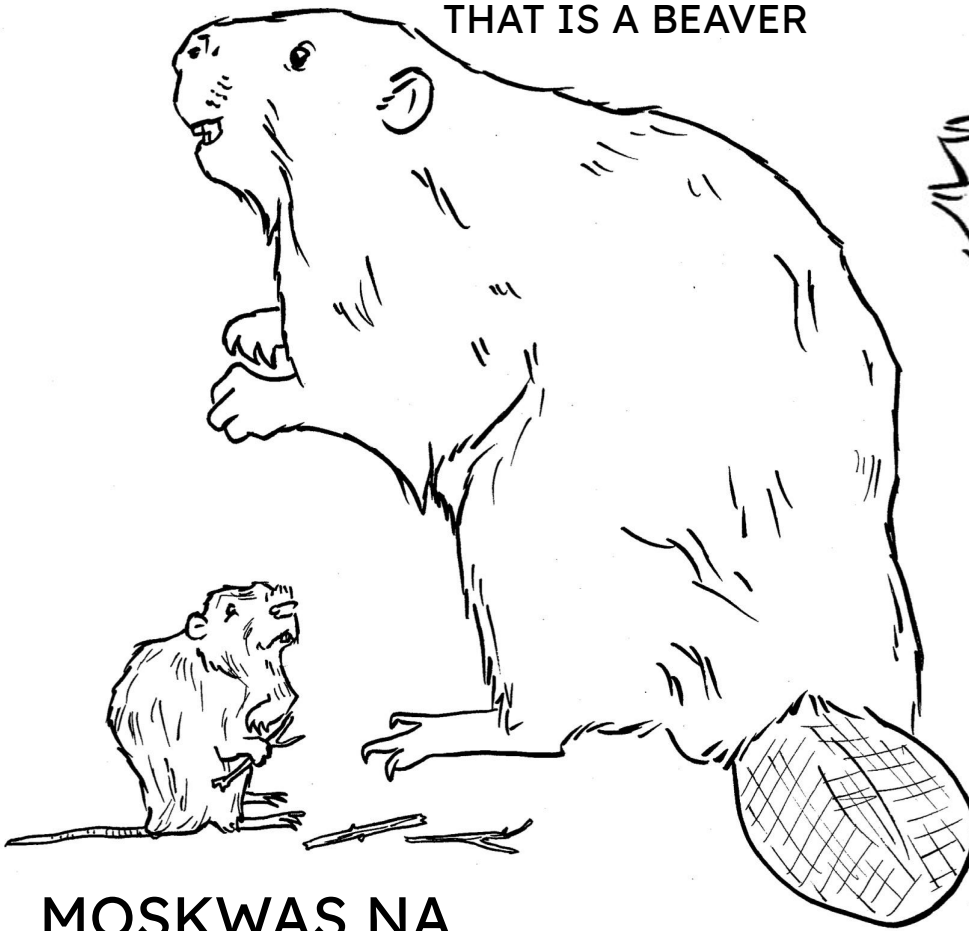

**SKÔKW NA**  
THAT IS A SKUNK



**MOSKWAS NA**  
THAT IS A MUSKRAT

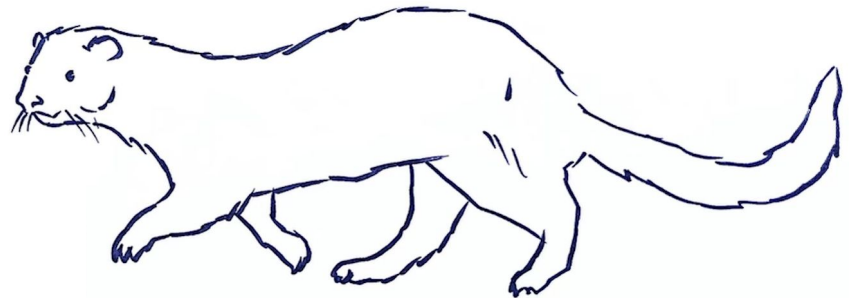

**ALASKANA NA**  
THAT IS A WOLVERINE



**MOSBAS NA**  
THAT IS A MINK



**WÔKWSSES NA**  
THAT IS A FOX

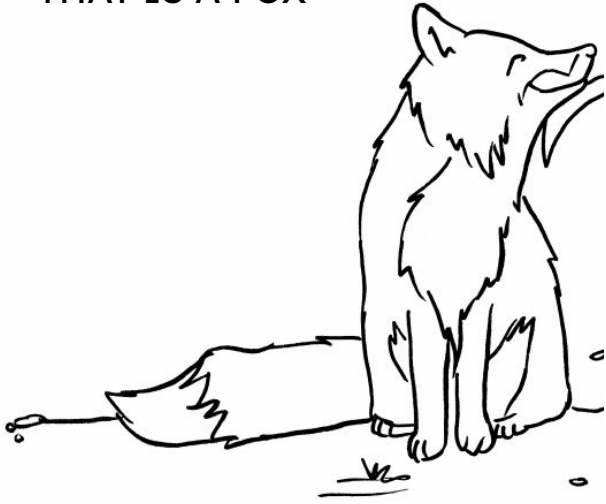

**SKAMON NI**  
THAT THING IS CORN



**WSKIGEK**  
THAT IS A NEW PLANT

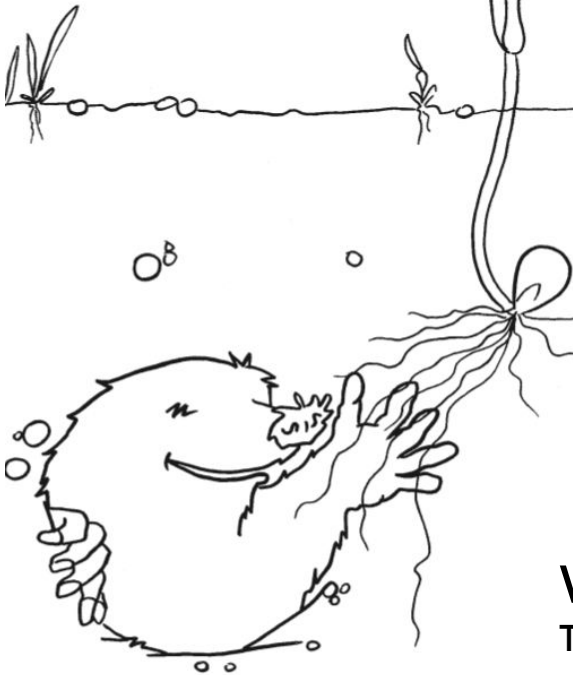

**AZBAN NA**  
THAT IS A RACCOON

**WSKIMEN NI**  
THAT THING IS A SEED

**ALMÔNSKA NA**  
THAT IS A MOLE

**WAJAPKWISAL  
NILIL**  
THOSE ARE SMALL ROOTS

**PITÔLO NA**  
THAT IS A COUGAR

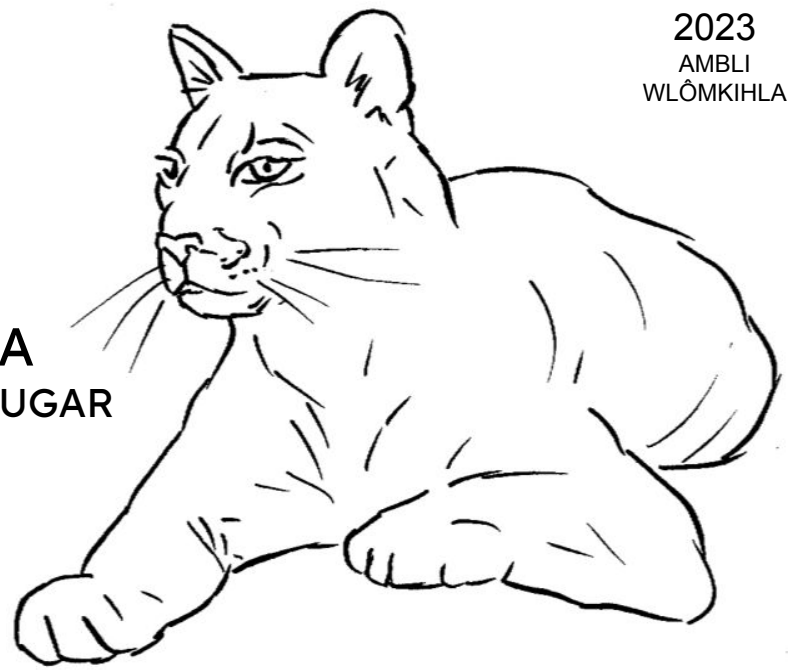

**PEZO NA**  
THAT IS A BOBCAT



**ABAZI NI**  
THAT IS A LOG

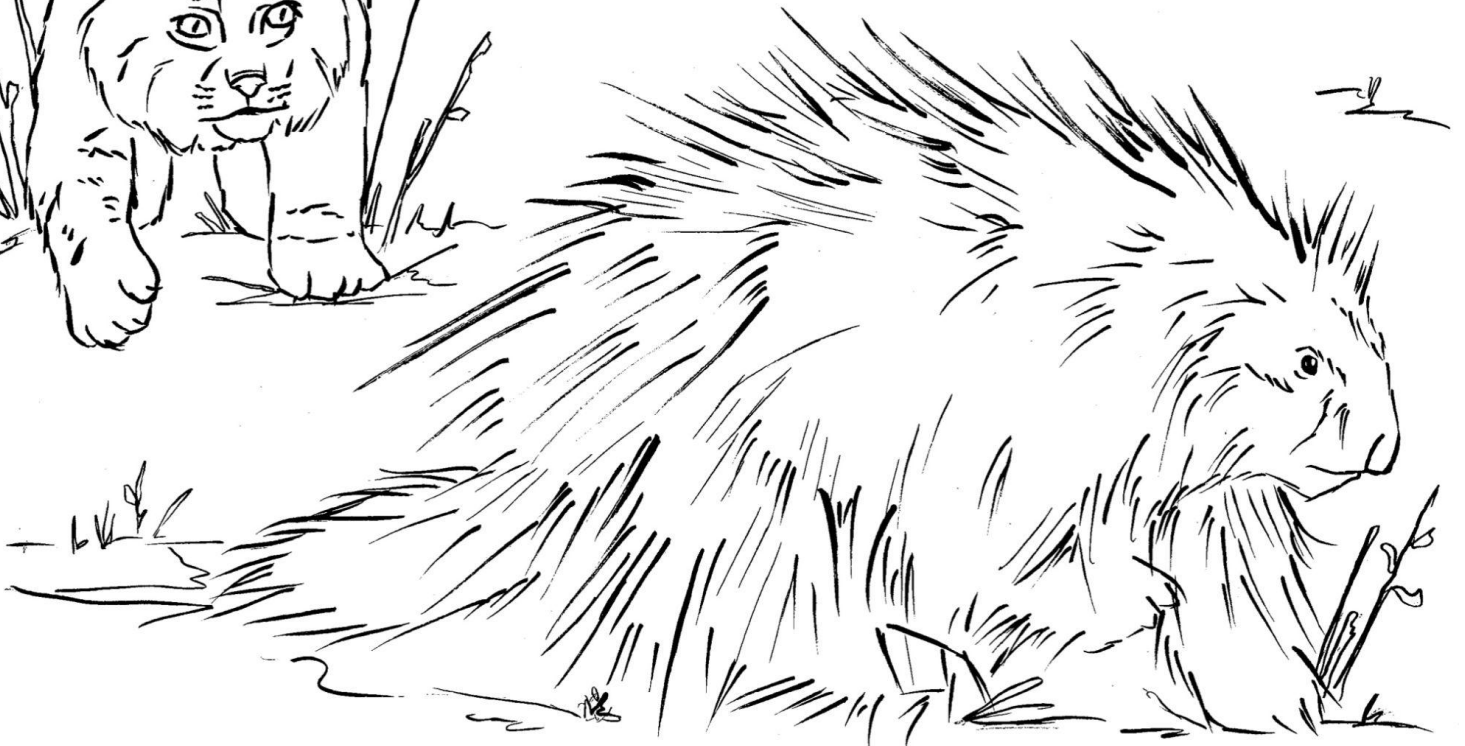

**KÔGW NA**  
THAT IS A PORCUPINE

**KPIWI**  
**THE FOREST**

**PASAAKOK NA**  
**THAT IS A RED PINE**

**KOA NA**  
**THAT IS A WHITE PINE**

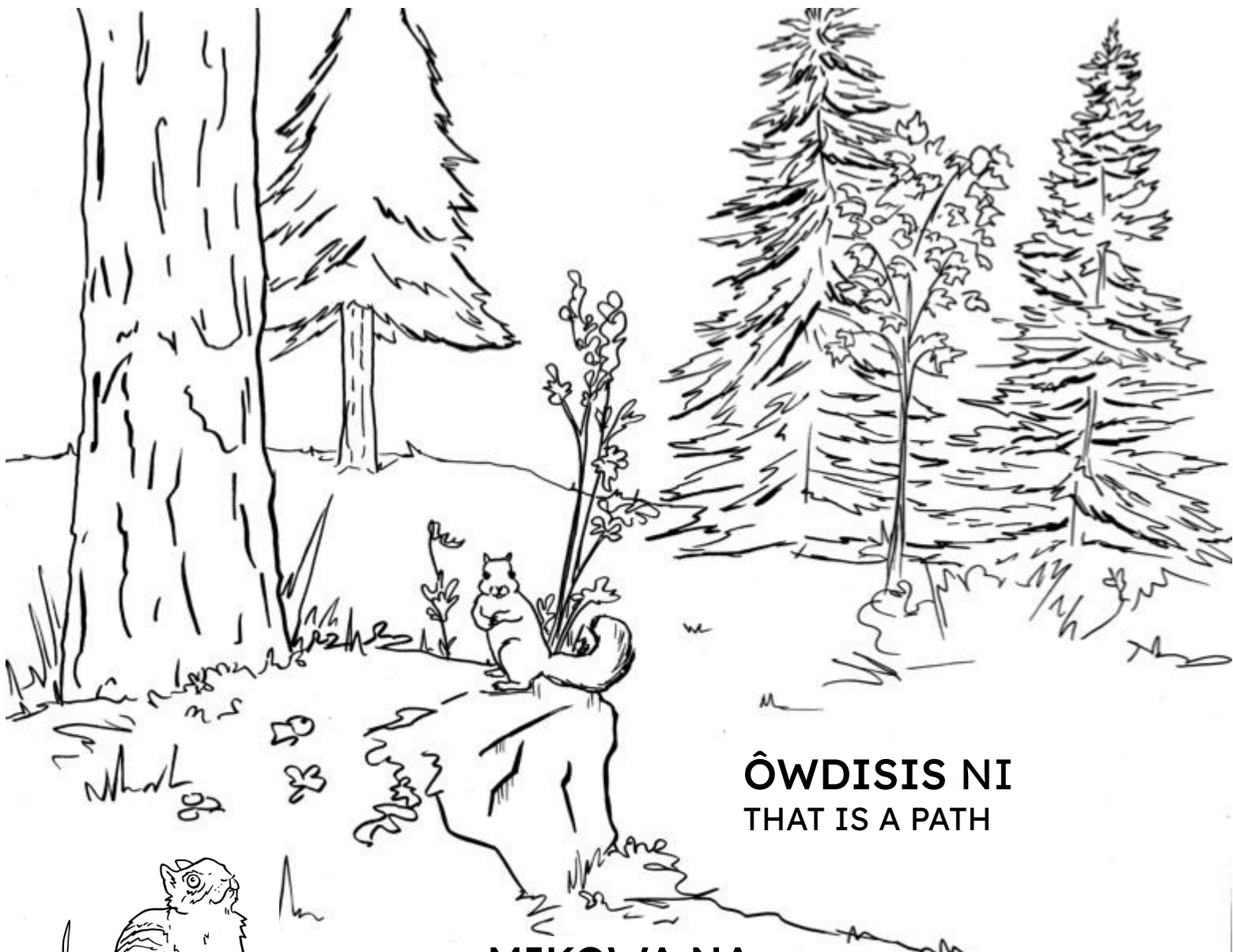

**ÔWDISIS NI**  
**THAT IS A PATH**

**MIKOWA NA**  
**THAT IS A SQUIRREL**

**ANIKWSES NA**  
**THAT IS A CHIPMUNK**

**KWENIBAKW NA**  
**THAT IS A PINE**  
**NEEDLE**

SÔKWKWAHIGANIPSWASAWÔNAL  
NILIL

THOSE ARE BELL FLOWERS

NANATASO NA  
THAT IS A HUMMINGBIRD

PSKWASAWÔNAL NILIL  
THOSE ARE FLOWERS

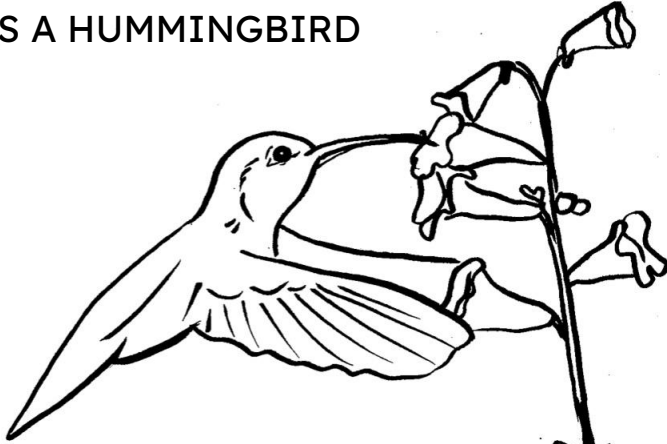

WAKWÔDES NA  
THAT IS A SNAIL

CHEGWAL NA  
THAT IS A FROG

SENIS NI  
THAT IS A PEBBLE

MSKIKO NI  
THAT IS GRASS

# ASKANAK NIGIK THOSE ARE ANTLERS

**MOZ NA**  
THAT IS A MOOSE

**WÔBOZ NA**  
THAT IS AN ELK

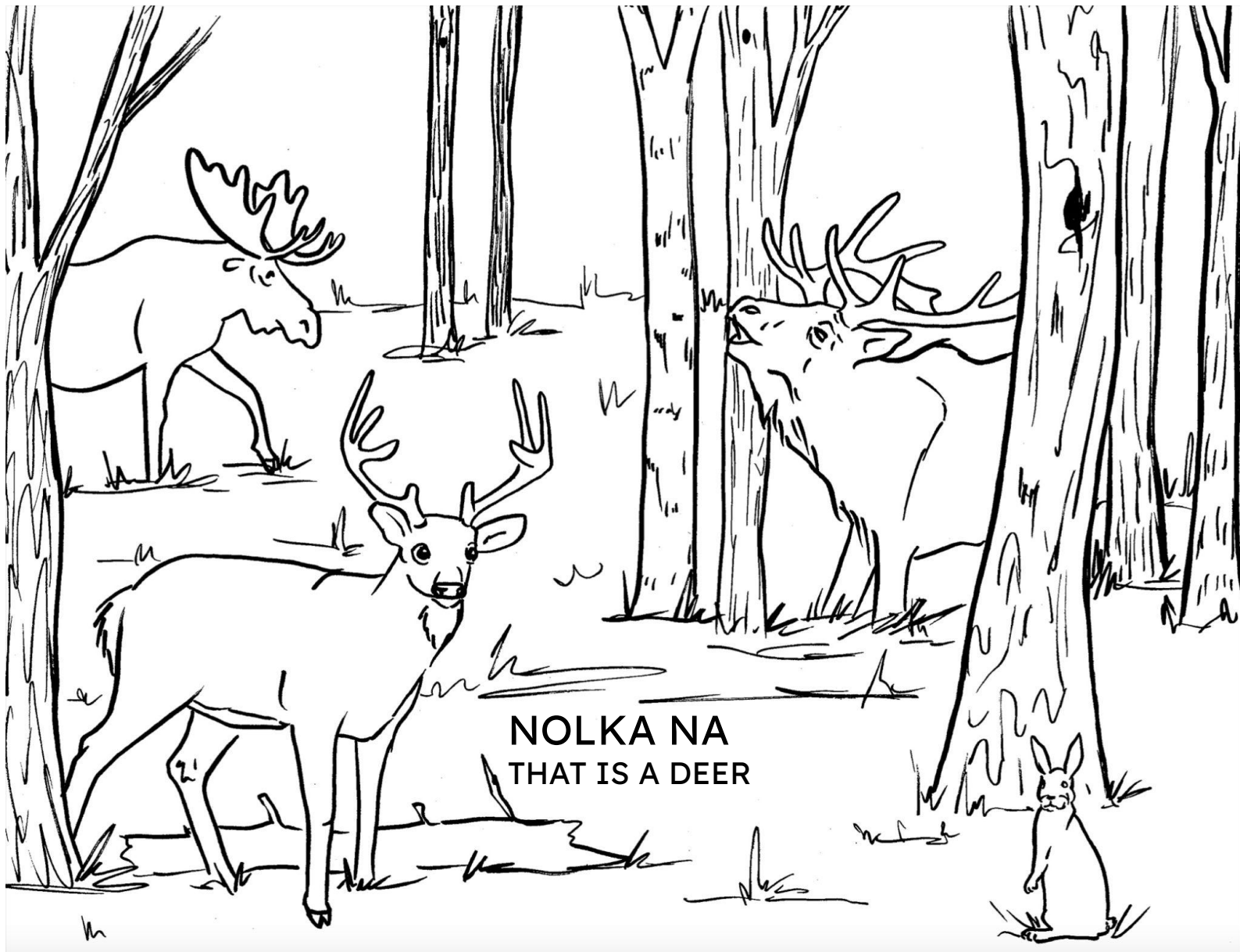

**NOLKA NA**  
THAT IS A DEER

**ABAZI NI**  
THAT IS A STICK

**MATEGWAS NA**  
THAT IS A RABBIT

**ABAZIAK NIGIK**  
THOSE ARE TREES

MAGÔLIBO NA  
THAT IS A CARIBOU

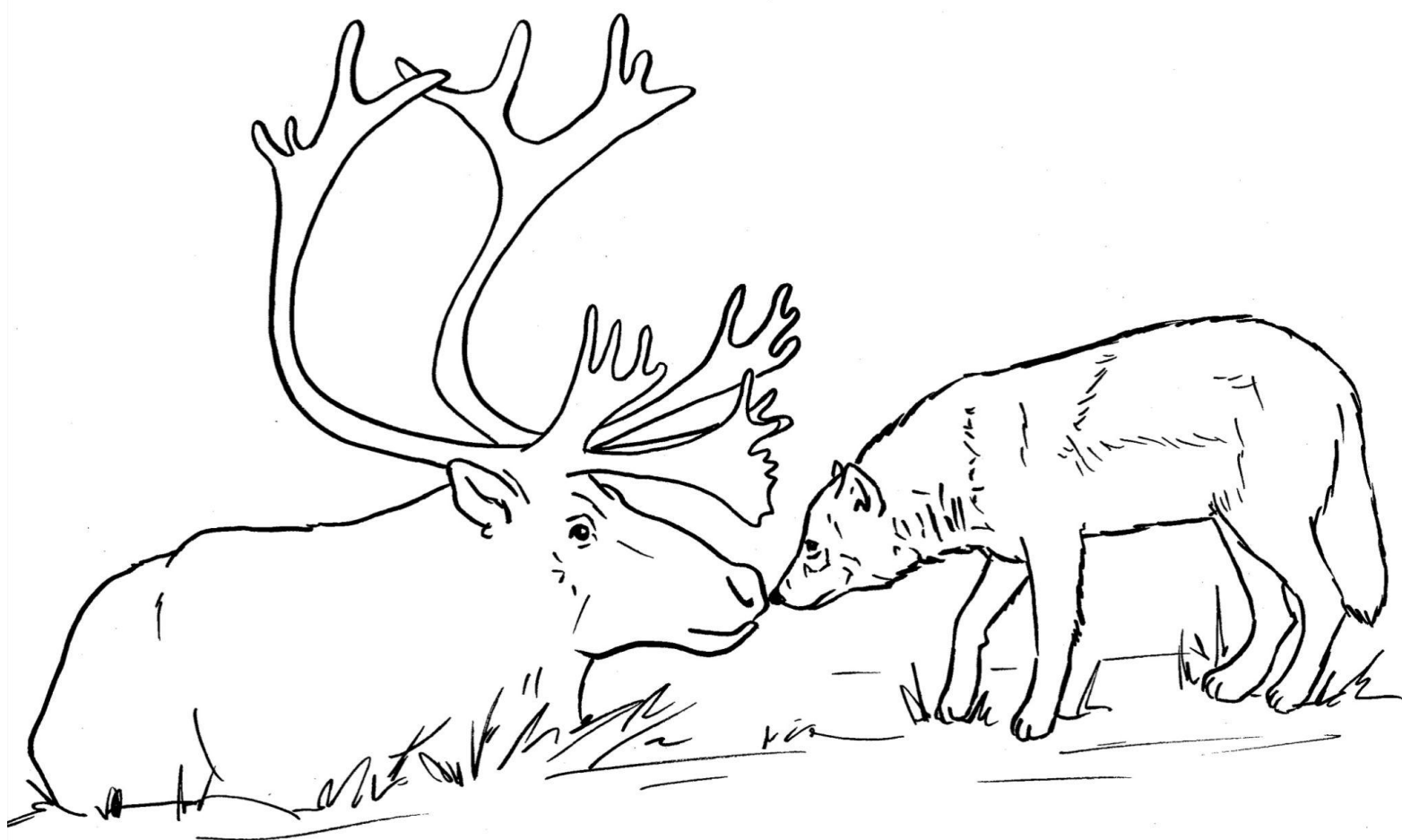

MÔLSEM NA  
THAT IS A WOLF

KESKEJAGWAK NIGIK  
THOSE ARE CANADA JAY OR  
MOOSE BIRDS

PSIKO NA  
THAT IS A BISON

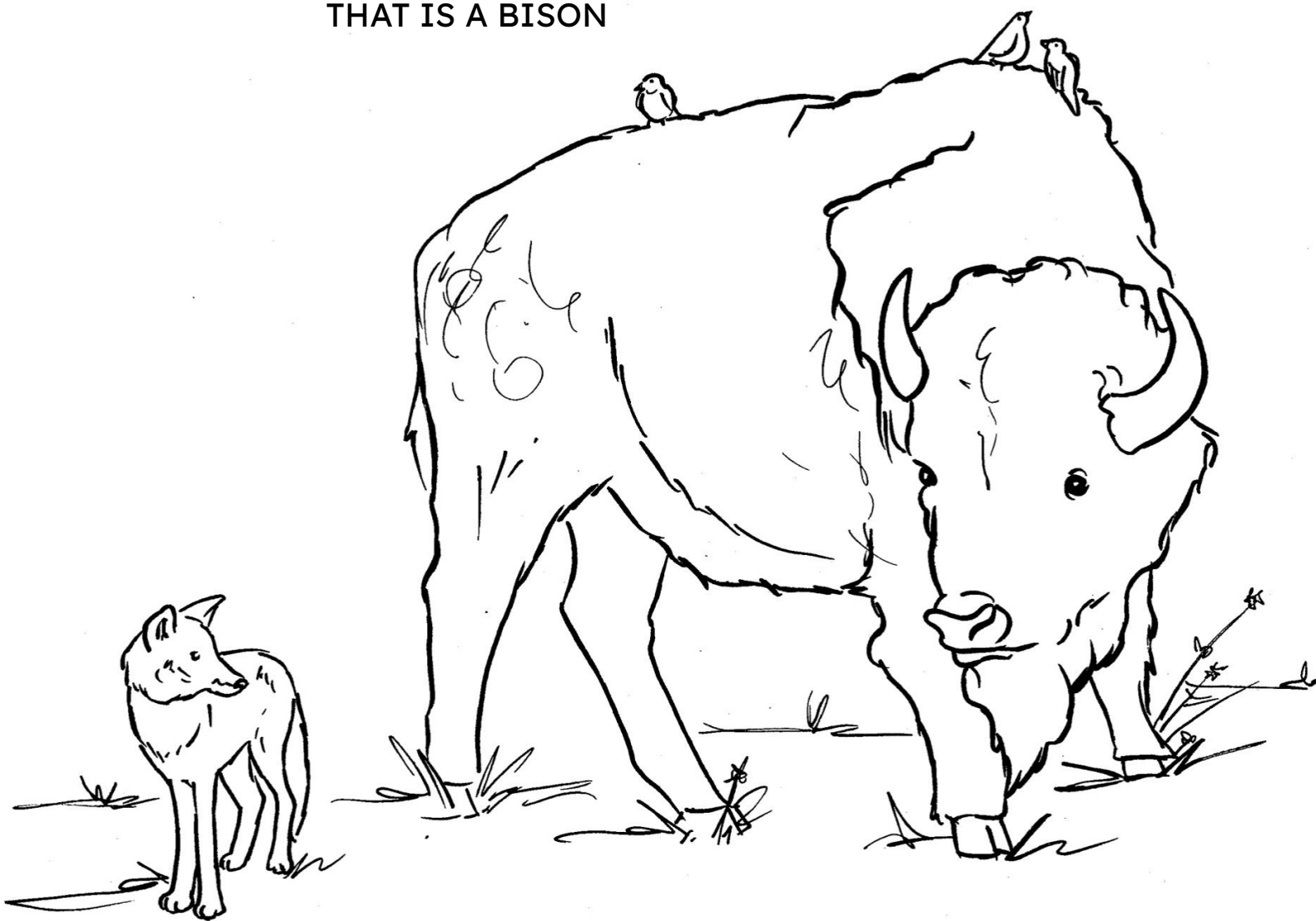

MÔLSEMSIS NA  
THAT IS A COYOTE

# KIKÔNEK IN THE GARDEN

KIZOSÔGAN NI  
THAT IS A SUNFLOWER

MSKIKOIMINAK NIGIK  
THOSE ARE STRAWBERRIES



MAMIJÔLA NA  
THAT IS A BUTTERFLY

WAWILÔMWA NA  
THAT IS A BEE

ASKITAMEG NI  
THAT IS A CUCUMBER

MAMSAHLAPIKA NA  
THAT IS A SPIDER

ALIKWSAK NIGIK  
THOSE ARE ANTS

PISAL NILIL  
THOSE THINGS ARE PEAS



# WJI NEBIZONKIKÔN FROM THE GARDEN

LENÔGAN NI  
THAT IS A HANDLE

ABAZNODA NI  
THAT IS A BASKET

WINOS NA  
THAT IS AN ONION

WASAWAL  
NILIL  
THOSE ARE SOME  
SQUASH

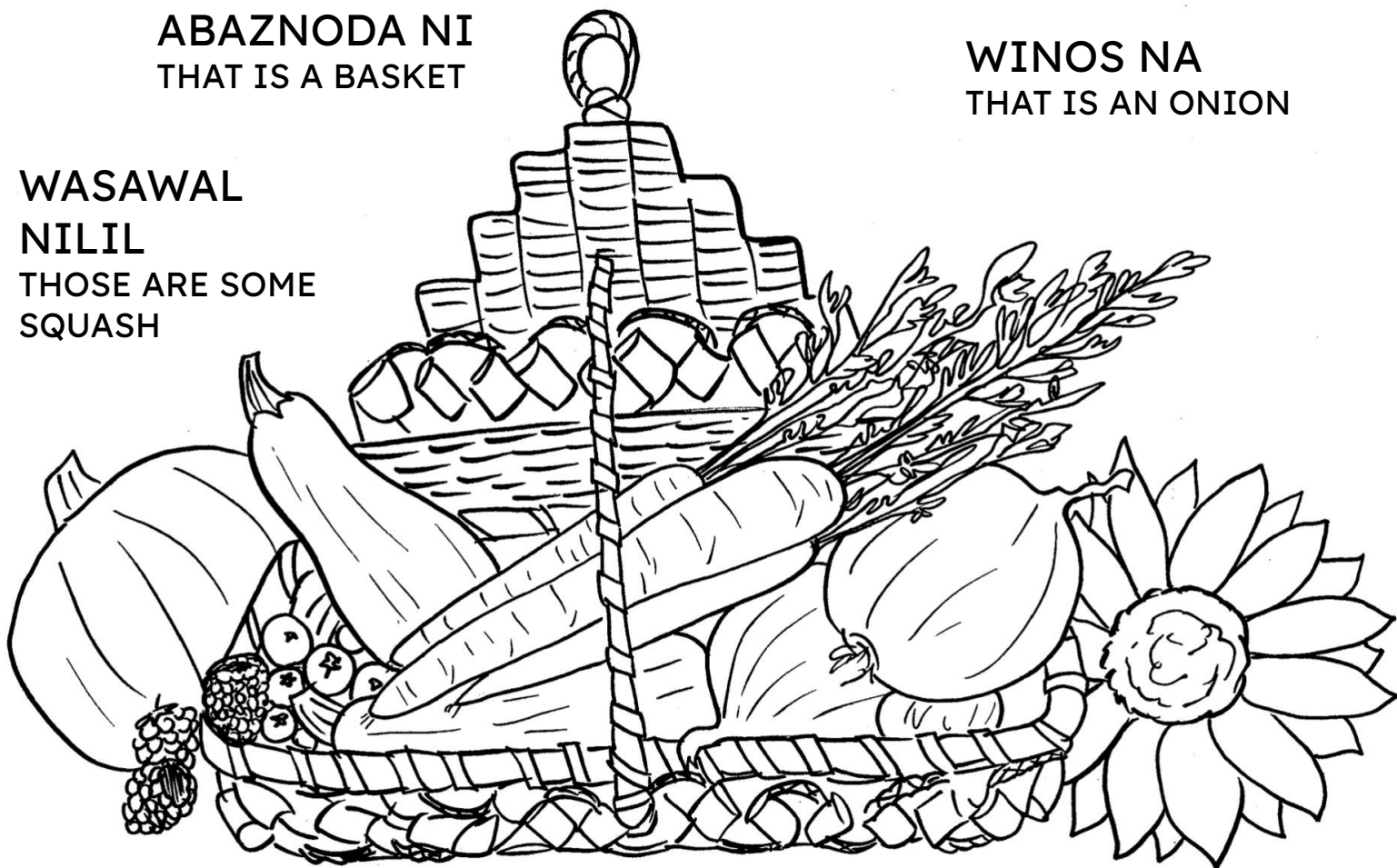

SATAL NILIL  
THOSE ARE  
BLUEBERRIES

WAWISÔWAGWZIJIK NIGIK  
THOSE ARE CARROTS

KIZOSÔGAN NI  
THAT IS A SUNFLOWER

SEGWESKIMENAK NIGIK  
THOSE ARE RASPBERRIES

PSAGWDAMENAK NIGIK  
THOSE ARE BLACKBERRIES

# NEBIZON KIPÔGWAZEK MEDICINE PLANTS

Mskikois (sweetgrass)



Asôbakw (sage)



Ôdamô (tobacco)



Kôksk (white cedar) ala  
Medwisagezo (red  
cedar)

**PAKHOLIGANAK NIGIK**  
THOSE ONES ARE DRUMS

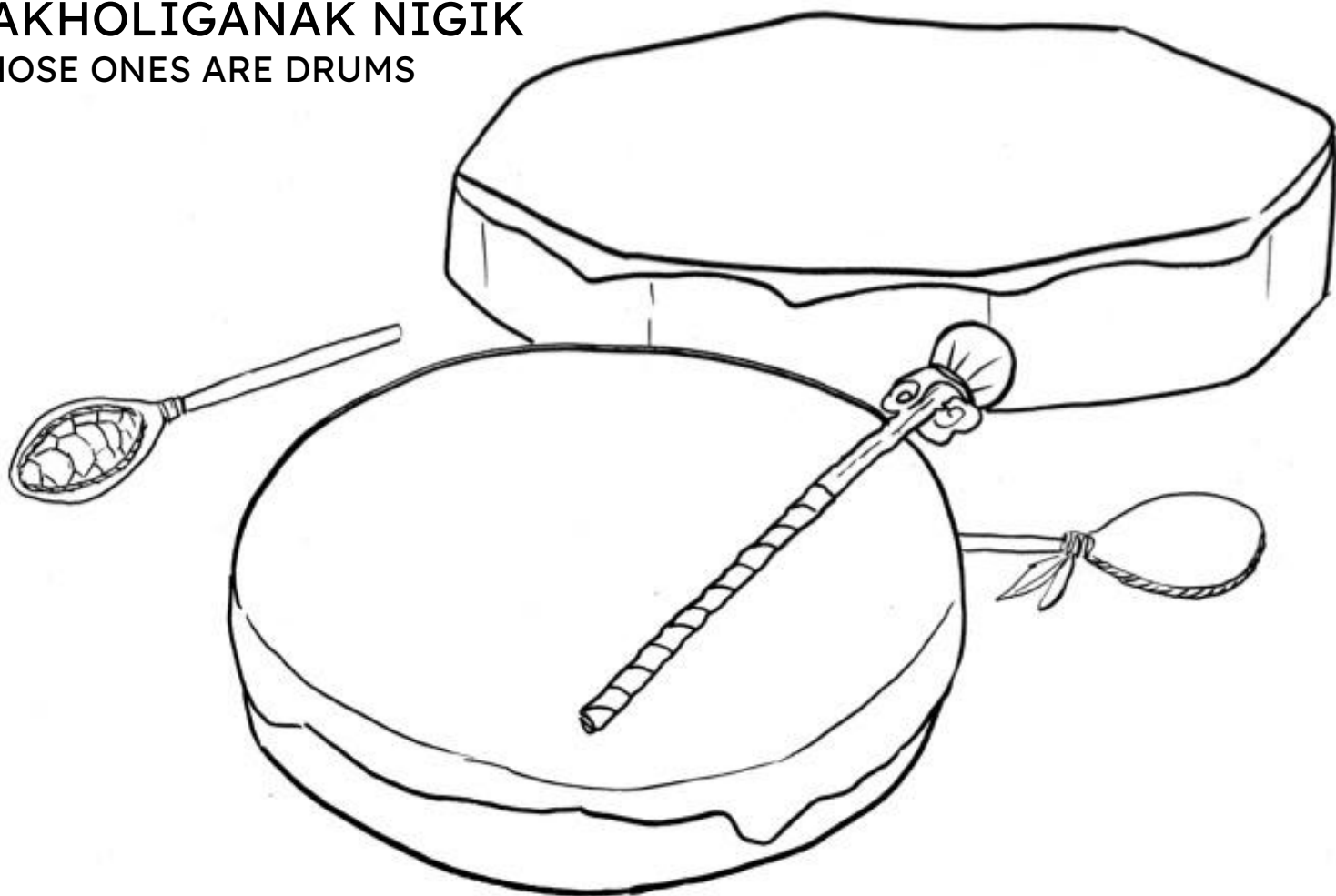

**MIKINAKW NI SISIWAN**  
THAT IS A TURTLE SHELL RATTLE

**PAKHOLIGANIGAN NI**  
THAT THING IS A DRUMSTICK

**SISIWANAL NILIL**  
THOSE THINGS ARE RATTLES

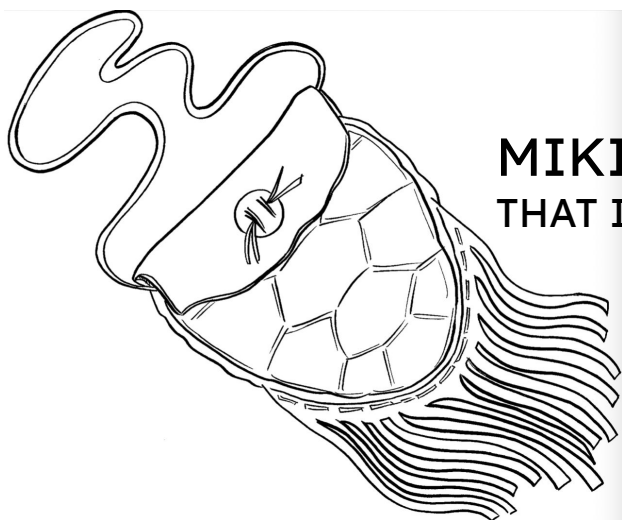

**MIKINAKWIPIDÔGAN NI**  
THAT IS A TURTLESHELL BAG

**AWIGHIGANIGAN NI**  
THAT IS A PENCIL

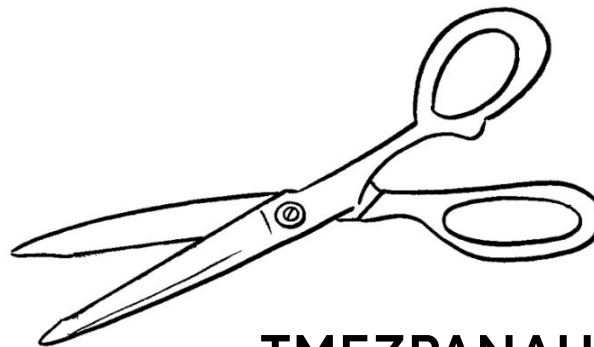
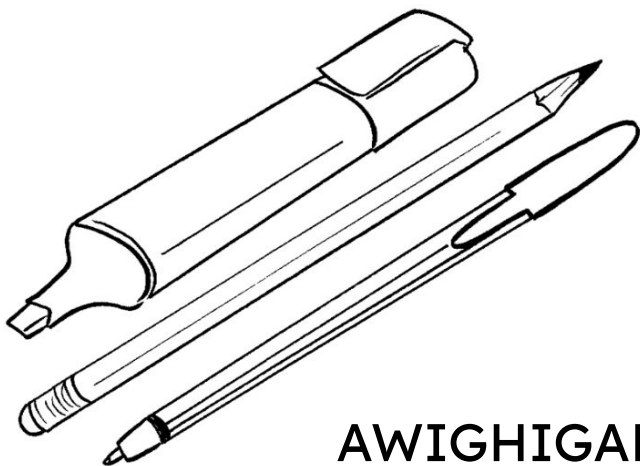

**TMEZPANAHON NA**  
THAT ONE IS SCISSORS

**AWIGHIGANAL NILIL**  
THOSE THINGS ARE BOOKS

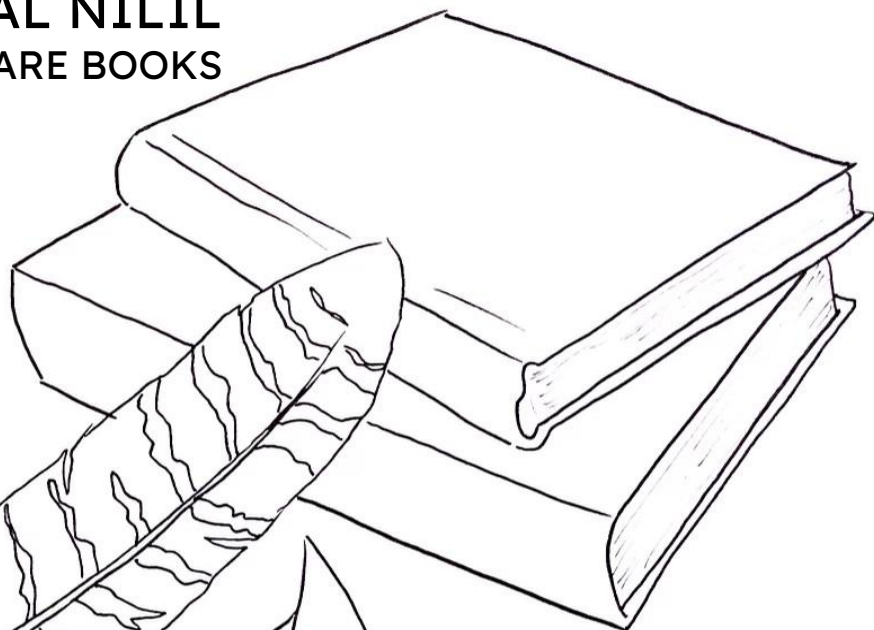

**PILASKW NI**  
THAT THING IS PAPER

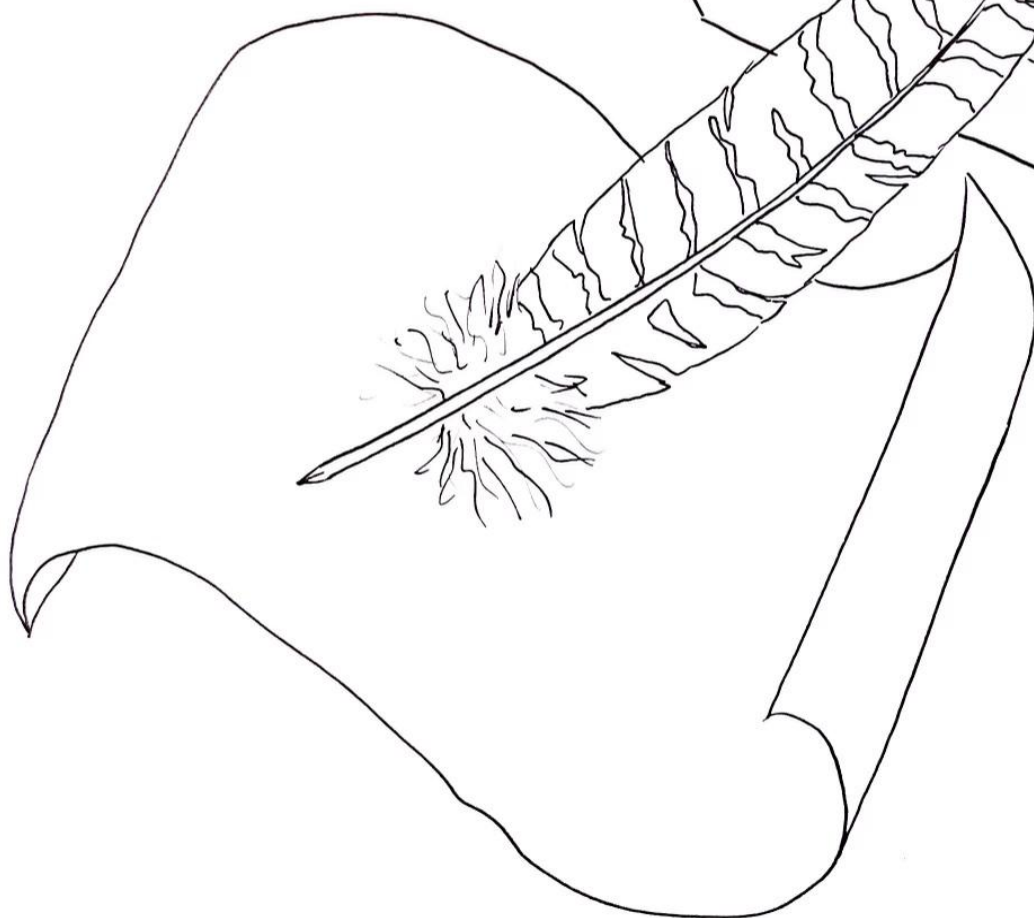

**MIGWEN NA**  
THAT ONE IS A FEATHER / PEN

**TAWIPODI NI**  
THAT THING IS A TABLE

**TASAKWABON**  
THAT THING IS A CHAIR

**KLÔGAN NI**  
THAT THING IS A DOOR

**WLOKAN NI**  
THAT THING IS A PLATE

**ABÔN NA**  
THAT ONE IS BREAD

**MIJOWÔGAN NI**  
THAT THING IS FOOD

**KWAT NA**  
THAT ONE IS A CUP OR BOWL

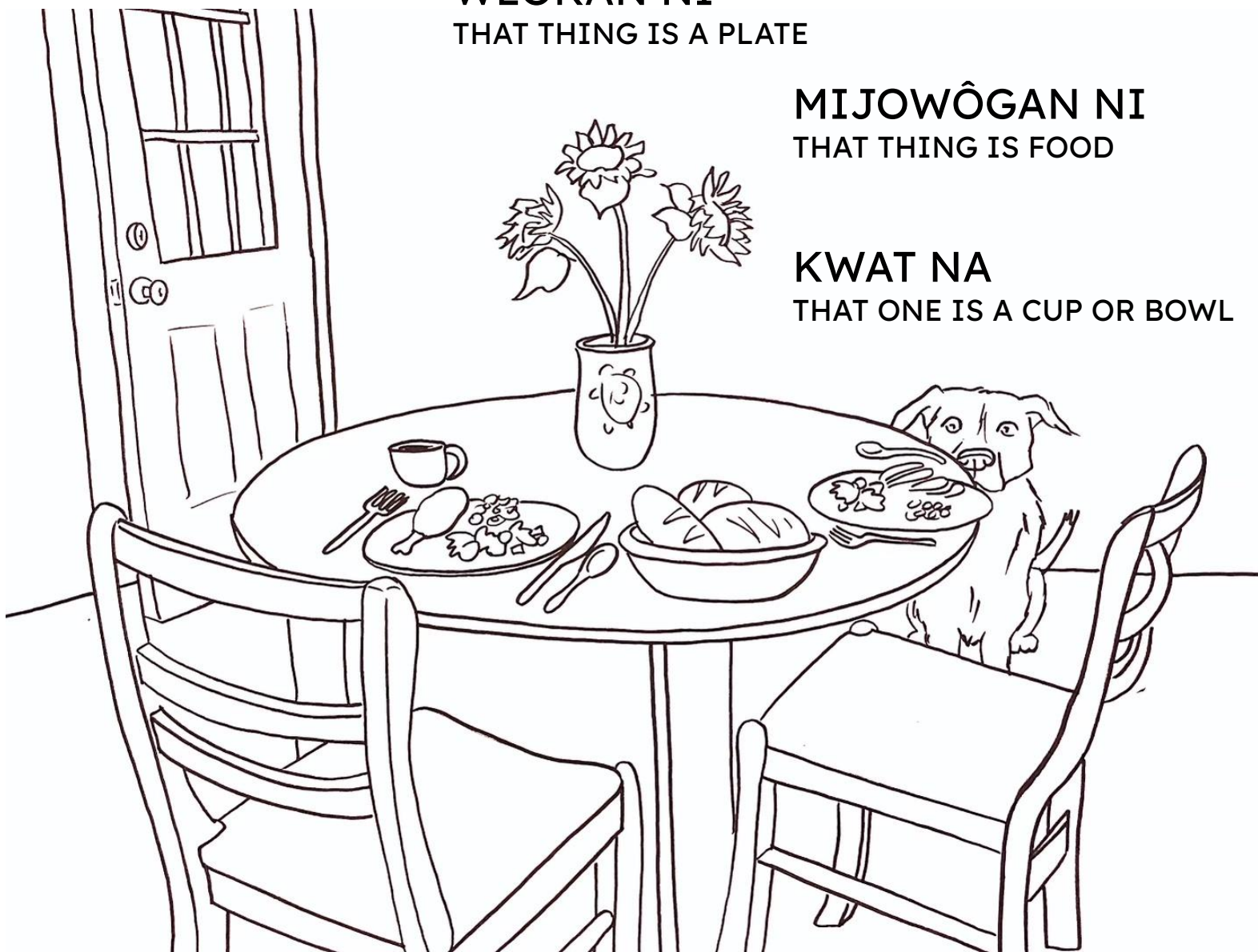

**NIMATEGWAHIGAN NI**  
THAT THING IS A FORK

**AMKWÔN NA**  
THAT ONE IS A SPOON

**CHAKWAKW NI**  
THAT THING IS A KNIFE

**ALMOS NA**  
THAT ONE IS A DOG

**ABON NA**  
THAT ONE IS A BED

**TAWZÔGAN NI**  
THAT THING IS A  
WINDOW

**WÔBAKS NA**  
THAT ONE IS A SHIRT

**MAKSA NI**  
THAT THING IS A BLANKET

**PITKÔZON NI**  
THAT THING IS A COAT

**AHIMAL NILIL**  
THOSE ARE CLOTHES

**APKWASIMON NA**  
THAT ONE IS A PILLOW

**KADAWIKHÔGAN NI**  
THAT IS A PHOTO

**TASAKWABON NI**  
THAT THING IS A CHAIR

**TASTIGAN NI**  
THAT THING IS A SHELF

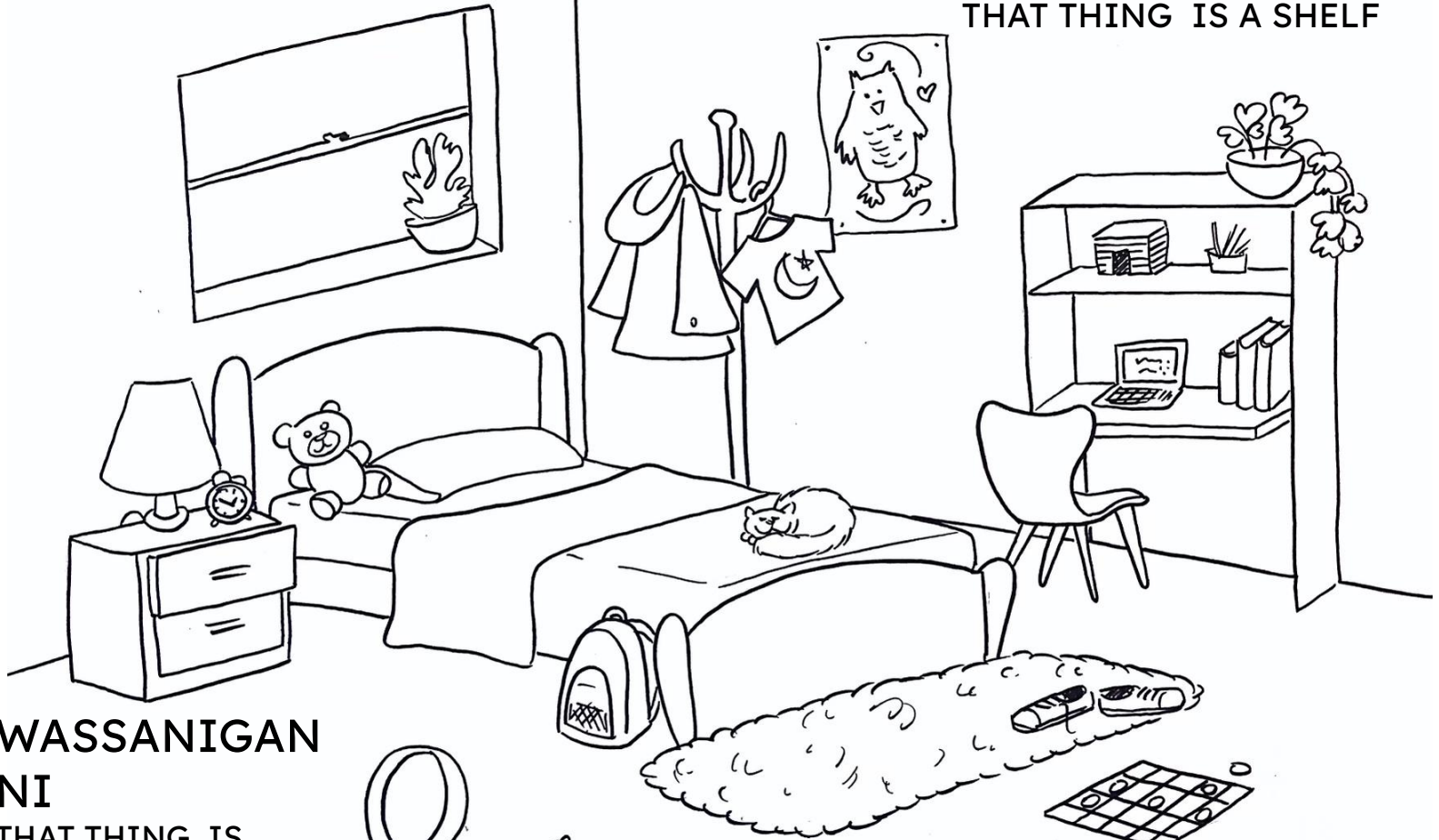

**WASSANIGAN NI**  
THAT THING IS  
A LAMP

**PAPOWÔGAN NI**  
THAT THING IS A GAME

**PAPIDOKÔGAN NI**  
THAT THING IS A TOY

**ÔNKAWÔJMOWIK NI**  
THAT IS A COMPUTER

**PAPIZOKWAZIK NI**  
THAT THING IS A CLOCK

**MINOWIS / PEZOIS NA**  
THAT ONE IS A CAT

**MAKEZENAL NILIL**  
THOSE THINGS ARE SHOES

**SKASAKW NI WIAZON NI**  
THAT THING IS A DRESSER    THAT THING IS A BACKPACK

**ANAKÔGAN NI**  
THAT THING IS A RUG

# MHAGA ONE'S BODY

N'... - MY  
K'... - YOUR  
W'... - THEIR  
M... - ONE'S

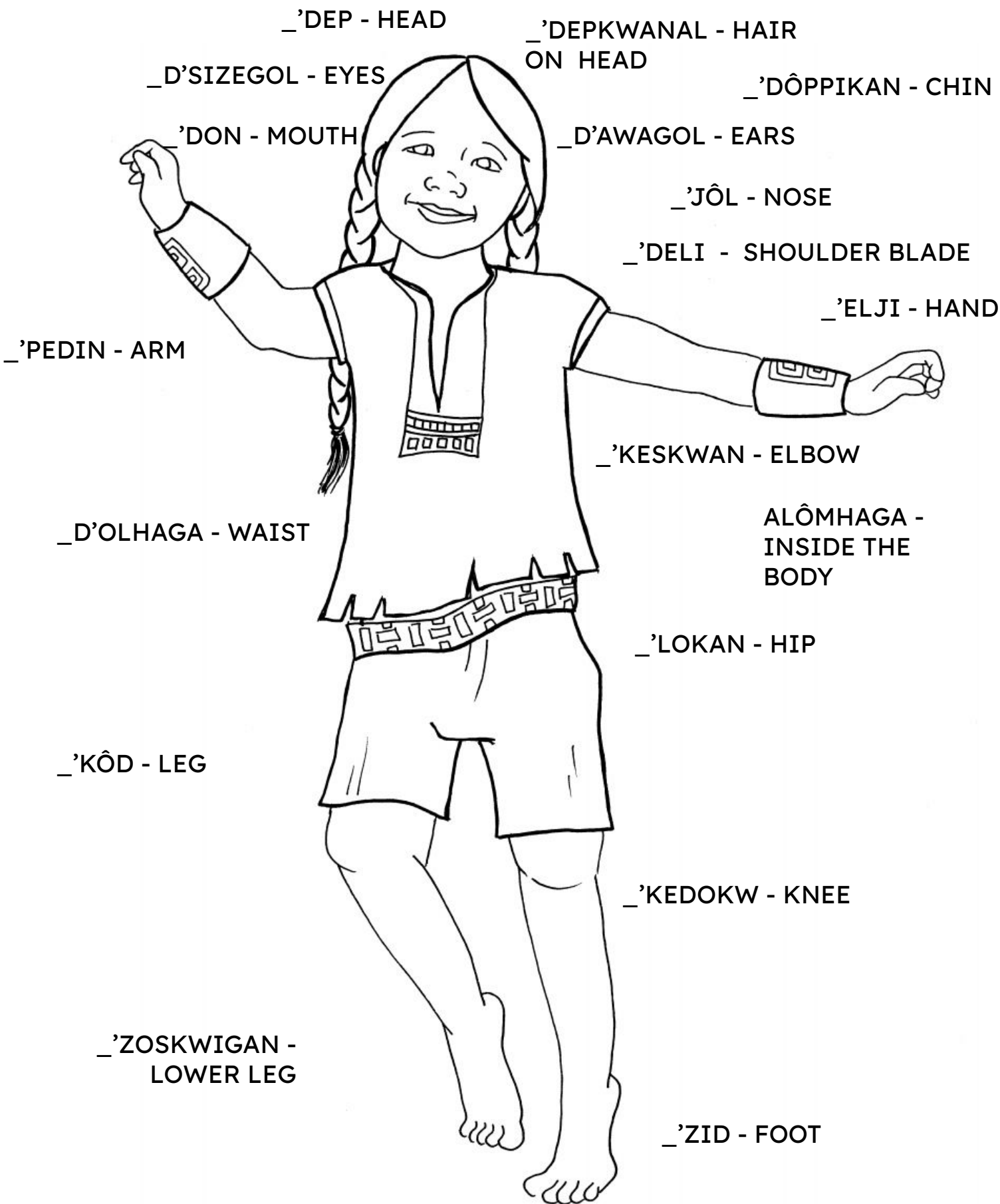

# ALNITA PITA LINTOWÔGAN

## VERY SILLY SONG

by Annette Urbschat, dedicated to Zoe Beach

Alnita pita, alnita pita, alnita pita, tmakwa  
Kchi k' wizô-, kchi k'wizô-, kchi k'wizôwôbidô.  
You are so silly beaver with your big yellow teeth.

Alnita pita, alnita pita, alnita pita, mikoa  
Kchi k'mik-, kchi k'mik, kchi k'mikoaôlo.  
You are so silly squirrel with your great big tail.

Alnita pita, alnita pita, alnita pita,  
kokokhas,  
Wigwaskoit -, wigwaskoit -, wigwaskoit  
k'depskokwa.  
You are so silly owl with your flexible neck.

Alnita pita, alnita pita, alnita pita,  
nidôba.  
Kchi kd'ô-, kchi kd'ô-, kchi kd'  
ôbdalmowôgan!  
You are so silly my friend -  
laugh out loud!

