



HV610

High performance vector control inverter

Contents

Basic Specification

Feature

Industry-specific

Model and specifications

Industry-specific design

Core Algorithm

Control of multiple types of motors

High Performance Vector Control



Basic specifications

Voltage	Single phase AC220V
	Three phase AC220V
	Three phase AC380V~480V
Power	0.75kw~2.2kw
	0.75kw~220kw
	0.75kw~630kw

Based on listening and understanding of customers' requirement, Hv610 supports full range of input voltage, complete functions for different countries and applications.

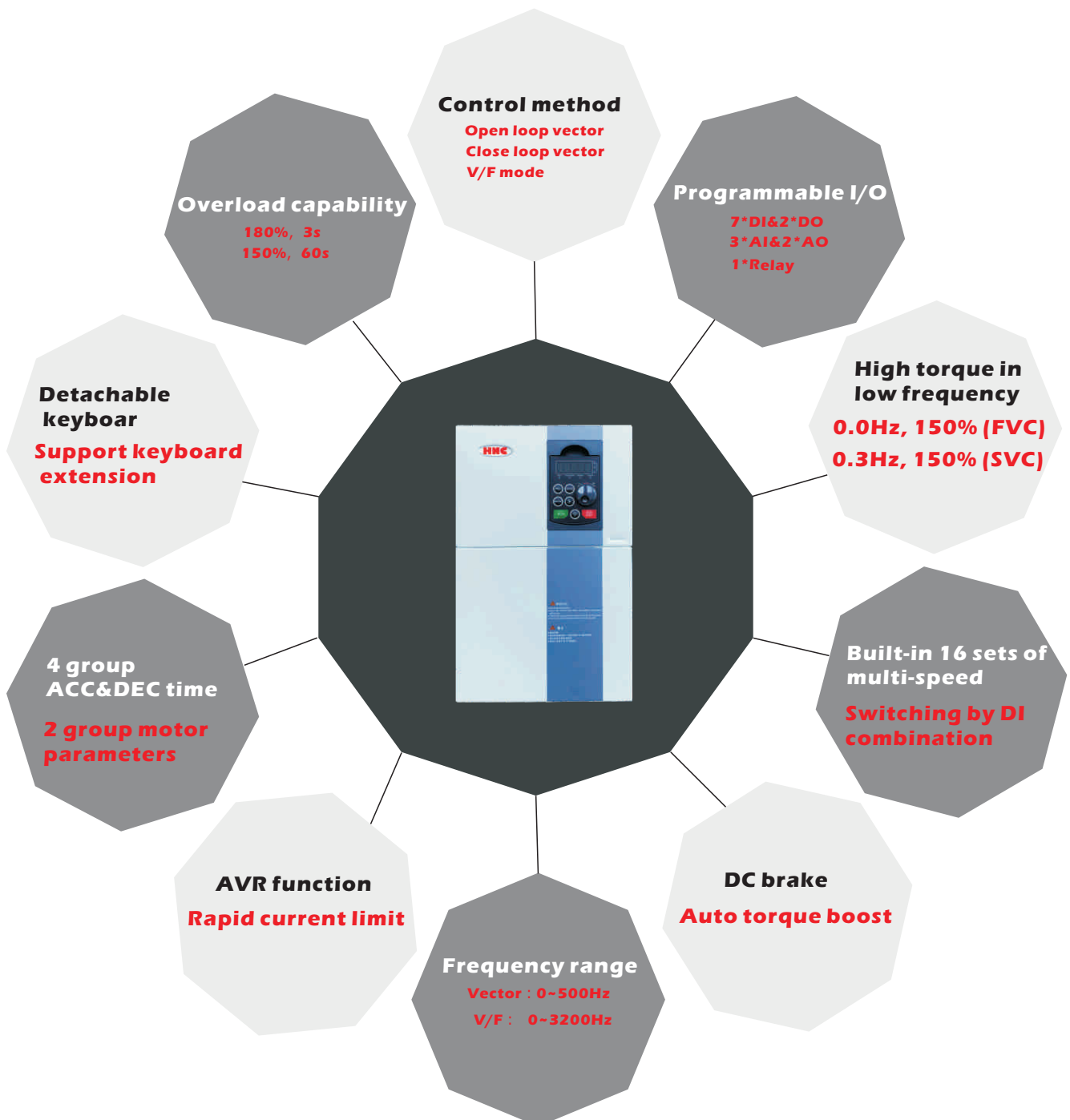

High performance vector control inverter

Product advantages

Commissioning software on PC

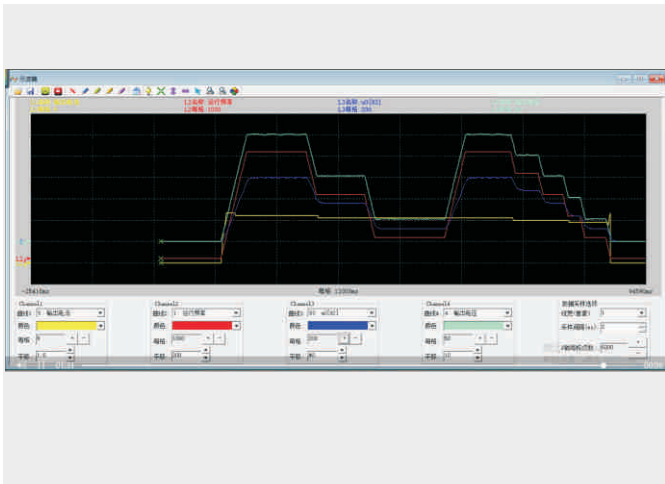

Monitor operating status via PC, optimize, modify, back up and copy data parameters

Control of multi-types of motors



Open/Closed loop of Synchronous/Asynchronous/DC motors

Copy parameter by LCD Keyboard



Easy copy of parameters between devices

Multiple communication control methods as options



Can be matched with various mainstream control systems

Product advantages

Multi-pump control



One inverter can control up to 4 pumps with extension relay card

Supports of multiple encoders

HV610-PG-UVW	HV610 encoder card, 5V, Differential input encoder, multi-output encoder signal
HV610-PG-DIF	HV610 encoder card, 5V, Differential encoder, 1:1 output encoder signal
HV610-PG-OC	HV610 encoder card, 15V, Open collector encoder
HV610-PG-RB	HV610 resolver card

Supports multiple encoder interfaces such as collector signals, differential signals, resolver signals, etc. Convenient for closed-loop vector control

Long-life design

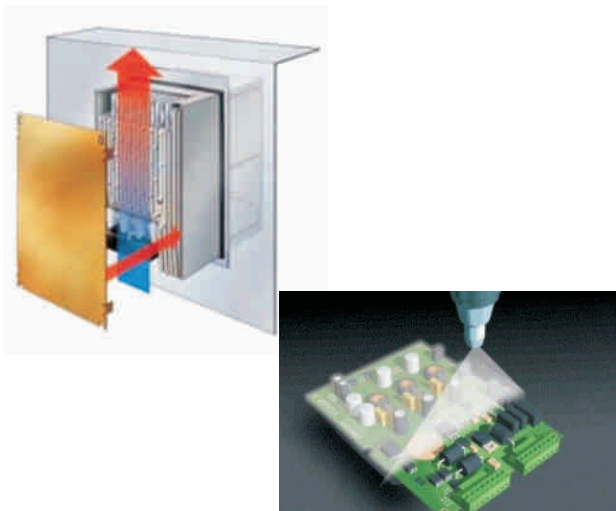

The independent air duct design and three layers of protective paint ensure that the product can run stably for a long time in harsh environments

Multiple EMC solutions

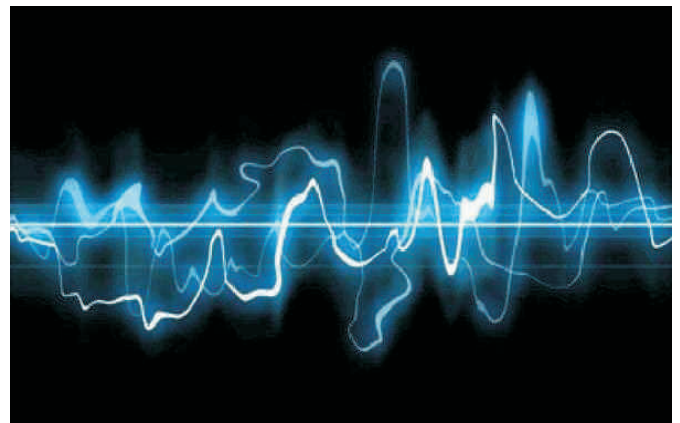

We offer complete EMC solutions including:
Built-in EMC filter, External filter and reactor
Built-in filter capacitor
External input / output reactor, input / output filter, harmonic filter, sine filter, etc.

High performance vector control inverter

Special Mode

Injection molding machine servo HV610I

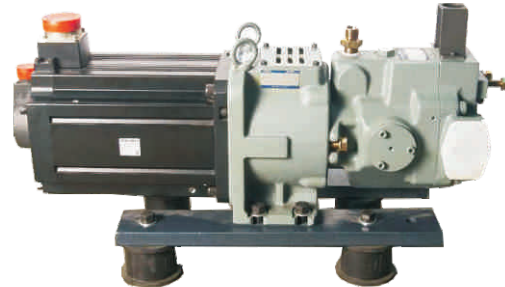

Built-in hydraulic PID control algorithm for precise pressure, flow and position control in hydraulic servo applications

Built-in multi-pump merge, multi-pump split flexible combination control

Crane model HV610C



Built-in control macro for quick selection of lifting and panning Intelligent brake control logic to prevents slipping

Support closed-loop vector, suitable for occasions with high lifting accuracy

Synchronous motors model HV610S



Support open&closed loop vector mode Optimized control algorithm with high synchronization control accuracy

Spindle model HV610Z



Developed specifically for machine tool spindle applications

Built-in spindle orientation, zero speed locking, rigid tapping, etc

Model Definition

HV610 - 7R5 G 3					
①		②		③ ④	
① HV 610 Series Inverter			③ Code Inverter Type		
			G General Purpose		
			P Fan / Pump		
② Code		④ Code Inverter Type			
R75		1 Single phase 220V			
7R5		2 Three phase 220V			
011		3 Three phase 380V-440V			
018		4 Three phase 460V-480V			
110					
400					
Motor					
0.75kW					
7.5kW					
11kW					
18.5kW					
110kW					
400kW					

HV610 series inverter specifications

Frequency inverter model	Power supply capacity (V)	Input current (A)	Output current (A)	Adaptive motor (KW)	Adaptive motor (HP)
G1 input voltage range: Single-phase AC220V±15%, 50 / 60 Hz					
HV610-R75G1	3.0	11.0	4.0	0.75	1
HV610-1R5G1	4.8	18.0	7.0	1.5	2
HV610-2R2G1	7.1	27.0	9.6	2.2	3
G2 input voltage range: Three-phase AC220V±15%, 50 / 60 Hz					
HV610-R75G2	3	5	3.8	0.75	1
HV610-1R5G2	4.0	5.8	5.1	1.5	2
HV610-2R2G2	5.9	10.5	9.0	2.2	3
HV610-004G2	8.9	14.6	13.0	3.7	5
HV610-5R5G2	17	26	25	5.5	7.5
HV610-7R5G2	21	35	32	7.5	10
HV610-011G2	30	46.5	45	11	15
HV590-015G2	40	62	60	15	20
HV610-018G2	57	76	75	18	25
HV610-022G2	69	92	91	22	30
HV610-030G2	85	113	112	30	40
HV610-037G2	114	157	150	37	50
HV610-045G2	134	180	176	45	60
HV610-055G2	160	214	210	55	75
HV610-075G2	231	307	304	75	100
HV610-093G2	250	385	377	90	125
HV610-110G2	280	430	426	110	150
HV610-132G2	396	525	520	132	175
HV610-160G2	500	665	650	160	220
HV610-185G2	560	735	725	185	245
HV610-200G2	630	835	820	200	270
HV610-220G2	700	925	910	220	300

High performance vector control inverter

HV610 series inverter specifications

Frequency inverter model	Power supply capacity (V)	Input current (A)	Output current (A)	Adaptive motor (KW)	
G3 input voltage range: Three-phase AC 380~440 (-15%~+10%), 50 / 60 Hz					
HV610-R75G3	1.5	3.4	2.1	0.75	1
HV610-1R5G3	3.0	5.0	3.8	1.5	2
HV610-2R2G3	4.0	5.8	5.1	2.2	3
HV610-004G3	5.9	10.5	9.0	4.0	5
HV610-5R5G3	8.9	14.6	13.0	5.5	7.5
HV610-7R5G3	11	20.5	17.0	7.5	10
HV610-011G3	17	26	25	11	15
HV590-015G2	21	35	32	15	20
HV610-018G3	45	42	37	18.5	25
HV610-022G3	54	50	45	22	30
HV610-030G3	60	68	60	30	40
HV610-037G3	63	83	75	37	50
HV610-045G3	81	102	91	45	60
HV610-055G3	97	124	112	55	75
HV610-075G3	127	169	150	75	100
HV610-093G3	150	203	176	90	125
HV610-110G3	179	248	210	110	150
HV610-132G3	192	256	253	132	175
HV610-160G3	231	307	304	160	220
HV610-185G3	242	350	340	185	245
HV610-200G3	250	385	377	200	270
HV610-220G3	280	430	426	220	300
HV610-250G3	355	468	465	250	340
HV610-280G3	396	525	520	280	380
HV610-315G3	445	590	585	315	430
HV610-355G3	500	665	650	355	420
HV610-400G3	565	785	725	400	530
HV610-450G3	630	883	820	450	600
HV610-550G3	720	954	920	500	670
HV610-560G3	780	1085	1030	560	750
HV610-630G3	800	1184	1100	630	840

HV610 series inverter specifications

Frequency inverter model	Power supply capacity (V)	Input current (A)	Output current (A)	Adaptive motor	
G4 input voltage range: Three-phase AC 460~480 (-15%~+10%), 50 / 60 Hz					
HV610-R75G4	1.5	3.4	2.1	0.75	1
HV610-1R5G4	3.0	5.0	3.8	1.5	2
HV610-2R2G4	4.0	5.8	5.1	2.2	3
HV610-004G4	5.9	10.5	9.0	4.0	5
HV610-5R5G4	8.9	14.6	13.0	5.5	7.5
HV610-7R5G4	11	20.5	17.0	7.5	10
HV610-011G4	17	26	25	11	15
HV590-015G4	21	35	32	15	20
HV610-018G4	45	42	37	18.5	25
HV610-022G4	54	50	45	22	30
HV610-030G4	60	68	60	30	40
HV610-037G4	63	83	75	37	50
HV610-045G4	81	102	91	45	60
HV610-055G4	97	124	112	55	75
HV610-075G4	127	169	150	75	100
HV610-093G4	150	203	176	90	125
HV610-110G4	179	248	210	110	150
HV610-132G4	192	256	253	132	175
HV610-160G4	231	307	304	160	220
HV610-185G4	242	350	340	185	245
HV610-200G4	250	385	377	200	270
HV610-220G4	280	430	426	220	300
HV610-250G4	355	468	465	250	340
HV610-280G4	396	525	520	280	380
HV610-315G4	445	590	585	315	430
HV610-355G4	500	665	650	355	420
HV610-400G4	565	785	725	400	530
HV610-450G4	630	883	820	450	600
HV610-550G4	720	954	920	500	670
HV610-560G4	780	1085	1030	560	750
HV610-630G4	800	1184	1100	630	840

High performance vector control inverter

Specificalton

Items	Description	
Basic function	Highest frequency	Vector control: 0 ~ 500 Hz V/F control: 0 : 3200Hz
	Carrier frequency	0.5kHz~16kHz The carrier frequency can be automatically adjusted according to the load characteristics
	Input frequency resolution	Digital setting: 0.01 Hz analog setting: highest frequency * 0.025 %
	Control mode	1: Open loop vector control 2: Closed loop vector control 3: V/F control
	Start torque	G type: 0.5 Hz / 150 % P type: 0.5 Hz / 100 %
	Speed control range	1:100
	Speed stabilization accuracy	±0.5%
	Torque control accuracy	±5%
	Overload capacity	Model G machine: 150 % rated current 60s; 180 % rated current 3s
	Torque increase	Automatic torque increase; The manual torque is increased by 0.1 % - 30.0 %
	V/F curve	Three ways: linear; Multipoint type; N - power V/F curve (power 1.2, power 1.4, power 1.6, power 1.8, power 2)
	V/F separation	Two methods: full separation and half separation
	Acceleration and deceleration curve	Straight line or S curve acceleration and deceleration mode. Four kinds of acceleration and deceleration times, The acceleration and deceleration time range is 0.0 to 6500.0 S.
	DC brake	DC braking frequency: 0.00 Hz ~ maximum frequency Braking time: 0.0s ~ 36.0s Brake action current value: 0.0 % - 100.0 %
	Inching	Inching frequency range: 0.00 Hz ~ 50.00 Hz. Inching acceleration and deceleration time 0.0s ~ 6500.0 s
	Simple PLC, multi-stage speed operation	Up to 16 - speed operation via built-in PLC or control terminal
	Built - in PID	Closed-loop control system capable of conveniently realize process control
	Automatic voltage regulation (AVR)	When the grid voltage changes, the output voltage can be automatically kept constant
	Over voltage and over-loss rate control	Automatically limit the current and voltage during operation to prevent frequent over current and over voltage trips.
	Fast current limiting function	Minimize over-current faults and protect the normal operation of the frequency inverter
Torque limitation and control	The " excavator" feature automatically limits the torque during operation to prevent frequent over current trips; Open loop vector mode can realize torque control	

		Specification
Items	Description	
Individualized performance	Outstanding performance	Using high performance current vector control technology to realize asynchronous motor control
	Stop at once	When the instantaneous power failure occurs, the load feedback energy compensates for the voltage drop and the frequency inverter will continue to operate for a short period of time
	Fast current limiting	Avoiding frequent over current faults of the frequency inverter
	Timing control	Timing control function: set the time range from 0.0 min to 6500.0 min
	Switch between two motors	Two sets of motor parameters can realize switching control of two motors
	Bus support	Supports a variety of Fieldbus: RS - 485, PROFIBUS
Running	Command source	Operation panel setting, control terminal setting, serial communication port setting. Can be switched in various ways
	Frequency source	Multiple frequency sources: digital setting, analog voltage setting, analog current setting, pulse setting, serial port setting. Can be switched in various ways
	Auxiliary frequency source	Various auxiliary frequency sources. Can flexibly realize auxiliary frequency fine tuning and frequency synthesis
	Input terminal	Standard 7 digital input terminals, of which 1 supports high-speed pulse input of up to 100 khz; Three analog input terminals, one supporting only 0 ~ 10v voltage input, one supporting 0 ~ 10v voltage input or 4 ~ 20mA current input, 1 analog input terminal, supporting - 10 ~ 10v voltage input
	Output terminals	1 high-speed pulse output terminal (optional open collector type), supporting square wave signal output of 0 ~ 100 khz 1 digital output terminal 1 relay output terminal 2 analog output terminals to support 0 ~ 20ma current output or 0 ~ 10v voltage output
Environme	Place of use	Dust - free, metal dust, corrosive gases, flammable gases, oil fog, salt fog, water vapor, dripping direct sunlight - free indoor
	Altitude	Below 1,000 meters
	Ambient temperature	-10℃ ~ 40℃
	Humidity	Less than 90 % RH without condensation
	Vibration	Less than 0.5g
	Storage temperature	-25℃ ~ 65℃
	Protection grade	Ip20

High performance vector control inverter

Dimensions and mounting dimensions

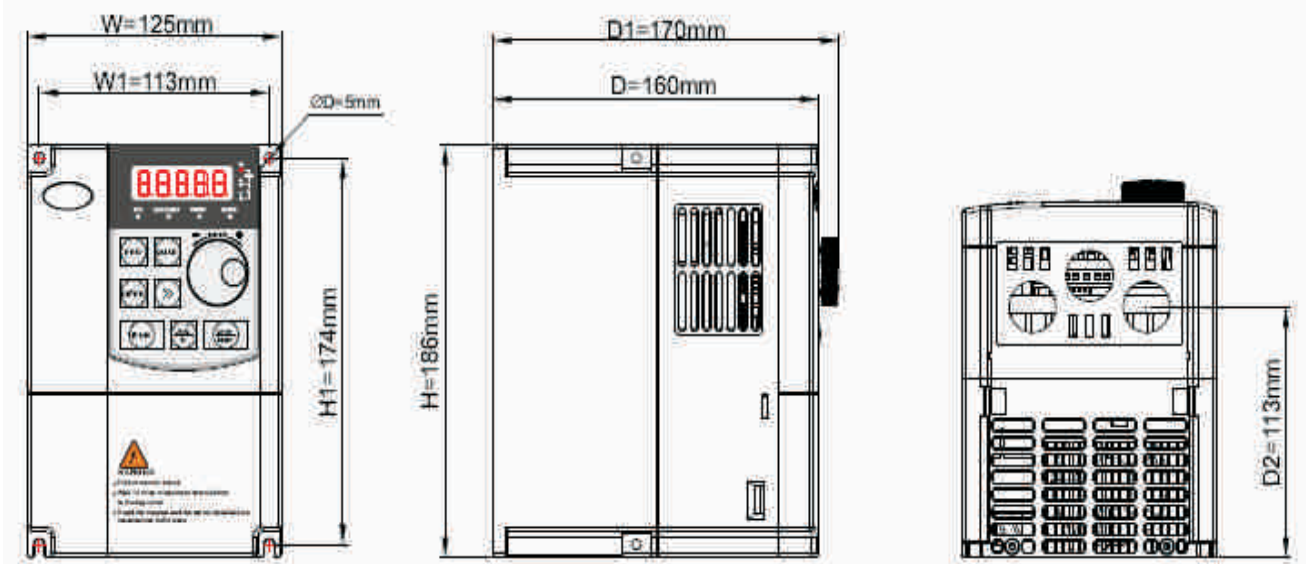

Fig 1(0.75G-2.2G)

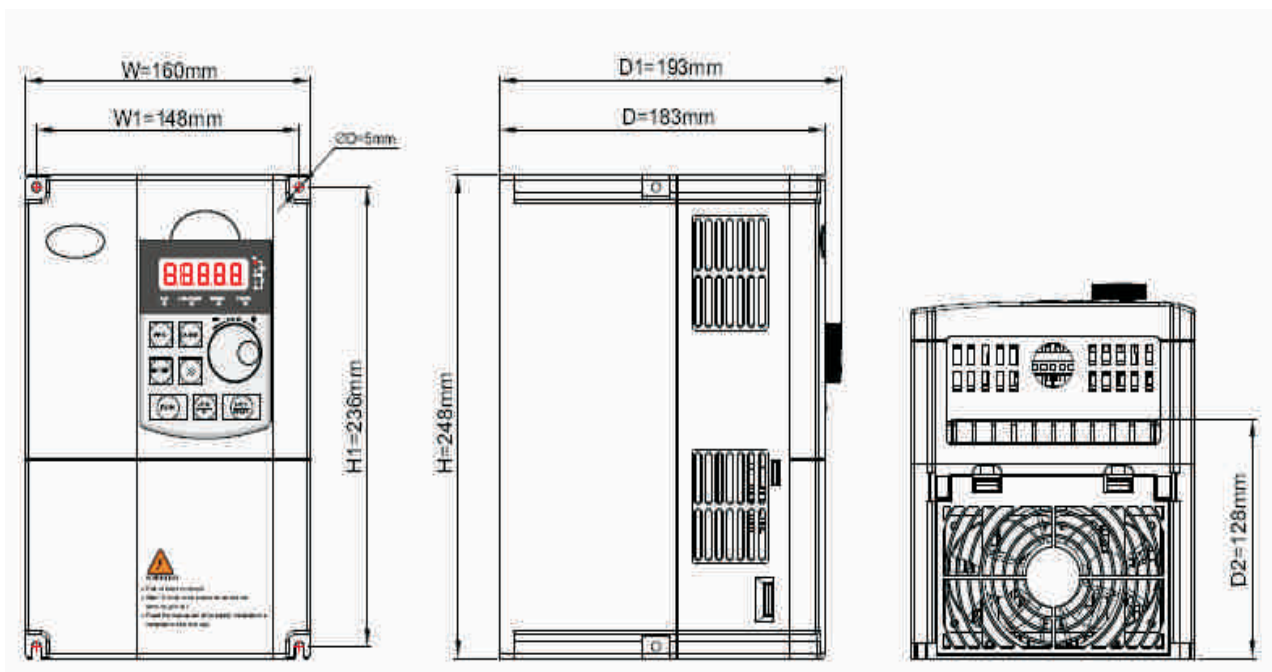

Fig 2(4.0G-7.5G)

Dimensions and mounting dimensions

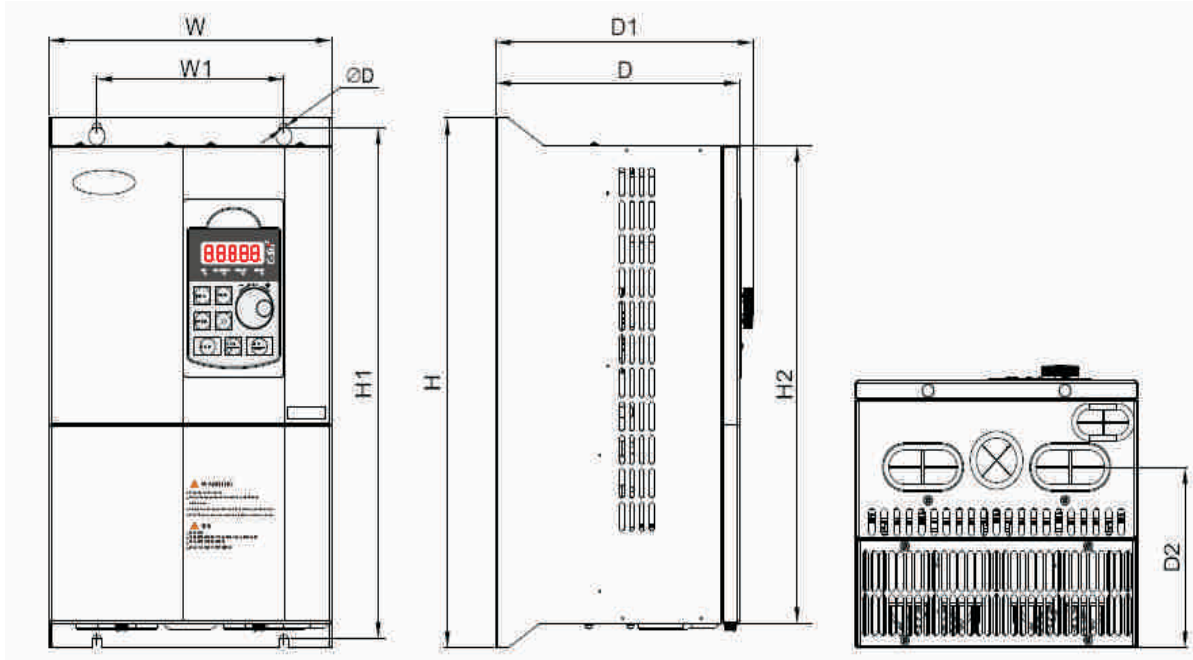

Fig 3(11G-200G)

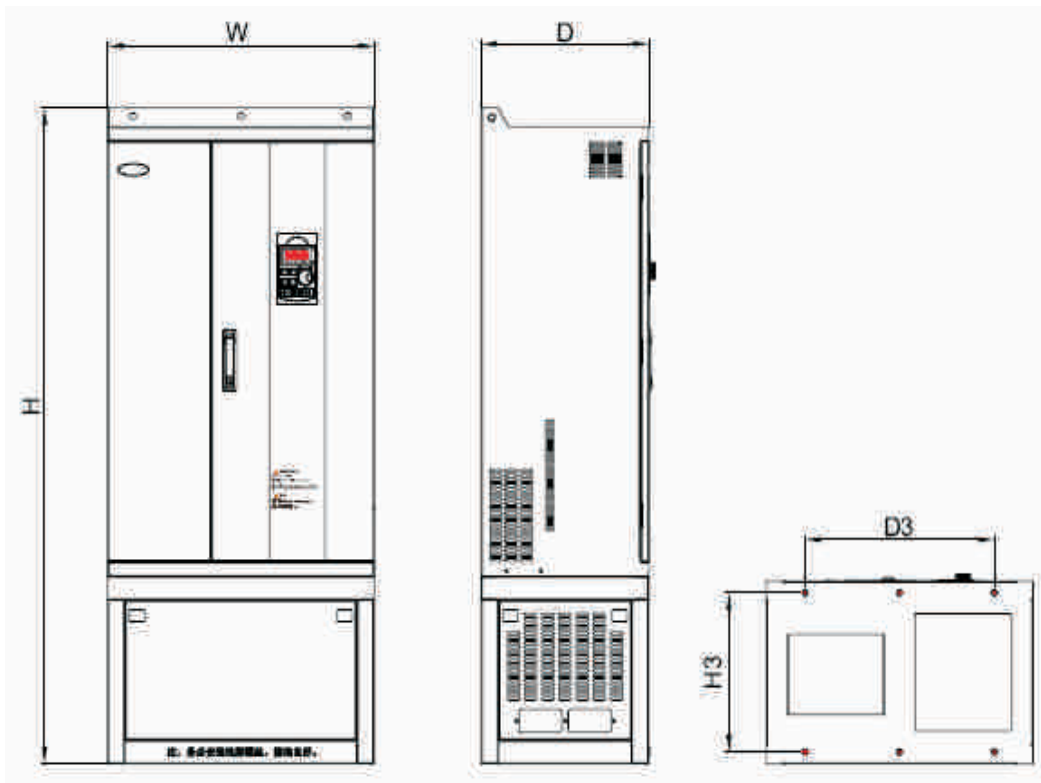

Fig 4(185G-560G)

High performance vector control inverter

List of dimensions and mounting dimensions

Inverter Specification	External dimension (mm)			Installation hole location (mm)					Mounting aperture (mm) d	Figure Fig
	W	H	D	W1	H1	D1	H2	D2		
G1 input voltage range: Single-phase AC220V±15%, 50 / 60 Hz										
HV610-R75G1	101	152	117	89	140	128		84	5	1
HV610-1R5G1										
HV610-2R2G1	125	220	166	110	205	177		124	6.5	1
G2 input voltage range: Three-phase AC220V±15%, 50 / 60 Hz										
HV610-R75G2	125	186	160	113	174	170		113	5	1
HV610-1R5G2										
HV610-2R2G2	160	248	138	148	236	193		128	5	2
HV610-004G2										
HV610-5R5G2	195	330	185	150	315	197	284	130	6	3
HV610-7R5G2										
HV610-011G2	227	338	196	150	375	206	350	133	7	3
HV590-015G2	255	435	202	150	425	213	400	140	7	3
HV610-018G2										
HV610-022G2	307	557	266	230	537	278	501	204	9	3
HV610-030G2										
HV610-037G2	377	628	280	240	600	292	568	228	9	3
HV610-045G2										
HV610-055G2										
HV610-075G2	500	788	350	270	762	357	728	266	13	3
HV610-093G2	540	900	348	320	867	358	828	278	13	3
HV610-110G2										
HV610-132G2	620	1035	390	500	1005	400	960	307	13	3
HV610-160G2	780	1290	400	600	1257	410	1203	316	13	3
HV610-185G2										
HV610-200G2										
HV610-220G2										
G3 input voltage range: Three-phase AC 380~440 (-15%~+10%), 50 / 60 Hz										
HV610-R75G3	125	186	160	113	174	170		113	5	1
HV610-1R5G3										
HV610-2R2G3										
HV610-004G3	160	248	138	148	236	193		128	5	2
HV610-5R5G3										
HV610-7R5G3										
HV610-011G3	195	330	185	150	315	197	284	130	6	3
HV590-015G3										
HV610-018G3	227	338	196	150	375	206	350	133	7	3
HV610-022G3										
HV610-030G3	255	435	202	150	425	213	400	140	7	3
HV610-037G3										

List of dimensions and mounting dimensions

Inverter Specification	External dimension (mm)			Installation hole location (mm)					Mounting aperture (mm)	Figure
	W	H	D	W1	H1	D1	H2	D2	d	Fig
G3 input voltage range: Three-phase AC 380~440 (-15%~+10%), 50 / 60 Hz										
HV610-045G3	307	557	266	230	537	278	501	204	9	3
HV610-055G3										
HV610-075G3	377	628	280	240	600	292	568	228	9	3
HV610-093G3										
HV610-110G3										
HV610-132G3	500	788	350	270	762	357	728	266	13	3
HV610-160G3										
HV610-185G3	540	900	348	320	867	358	828	278	13	3
HV610-200G3										
HV610-220G3										
Cabinet machine (H x W x D): 1268x540x358 (H3 = 266, D3=440)										
HV610-250G3	620	1305	390	500	1005	400	960	307	13	3
HV610-280G3										
Cabinet machine (H x W x D): 1400x620x400 (H3 = 340, D3=440)										
HV610-315G3	780	1290	400	600	1257	410	1203	316	13	3
HV610-355G3										
HV610-400G3										
Cabinet machine (H x W x D): 1650x780x410 (H3 = 340, D3 = 600)										
HV610-450G3	Cabinet machine (H x W x D): 1750x950x460 (H3 = 320, D3=820)									
HV610-500G3										
HV610-560G3										
HV610-630G3										
G4 input voltage range: Three-phase AC 460~480 (-15%~+10%), 50 / 60 Hz										
HV610-R75G4	125	186	160	113	174	170		113	5	1
HV610-1R5G4										
HV610-2R2G4										
HV610-004G4	160	248	138	148	236	193		128	5	2
HV610-5R5G4										
HV610-7R5G4										
HV610-011G4	195	330	185	150	315	197	284	130	6	3
HV590-015G4										
HV610-018G4	227	338	196	150	375	206	350	133	7	3
HV610-022G4										
HV610-030G4	255	435	202	150	425	213	400	140	7	3
HV610-037G4										
HV610-045G4	307	557	266	230	537	278	501	204	9	3
HV610-055G4										
HV610-075G4	377	628	280	240	600	292	568	228	9	3
HV610-093G4										
HV610-110G4										
HV610-132G4	500	788	350	270	762	357	728	266	13	3
HV610-160G4										

High performance vector control inverter

List of dimensions and mounting dimensions

Inverter Specification	External dimension (mm)			Installation hole location (mm)					Mounting aperture (mm)	Figure
	W	H	D	W1	H1	D1	H2	D2	d	Fig
HV610-185G4	540	900	348	320	867	358	828	278	13	3
HV610-200G4										
HV610-220G4										
Cabinet machine (H x W x D): 1268x540x358 (H3 = 266, D3=440)										
HV610-250G4	620	1305	390	500	1005	400	960	307	13	3
HV610-280G4										
Cabinet machine (H x W x D): 1400x620x400 (H3 = 340, D3=440)										
HV610-315G4	780	1290	400	600	1257	410	1203	316	13	3
HV610-355G4										
HV610-400G4										
HV610-450G4										
HV610-550G4										
HV610-560G4										
HV610-630G4										
Cabinet machine (H x W x D): 1650x780x410 (H3 = 340, D3 = 600)										
Cabinet machine (H x W x D): 1750x950x460 (H3 = 320, D3=820)										

Standard wiring diagram of frequency inverter

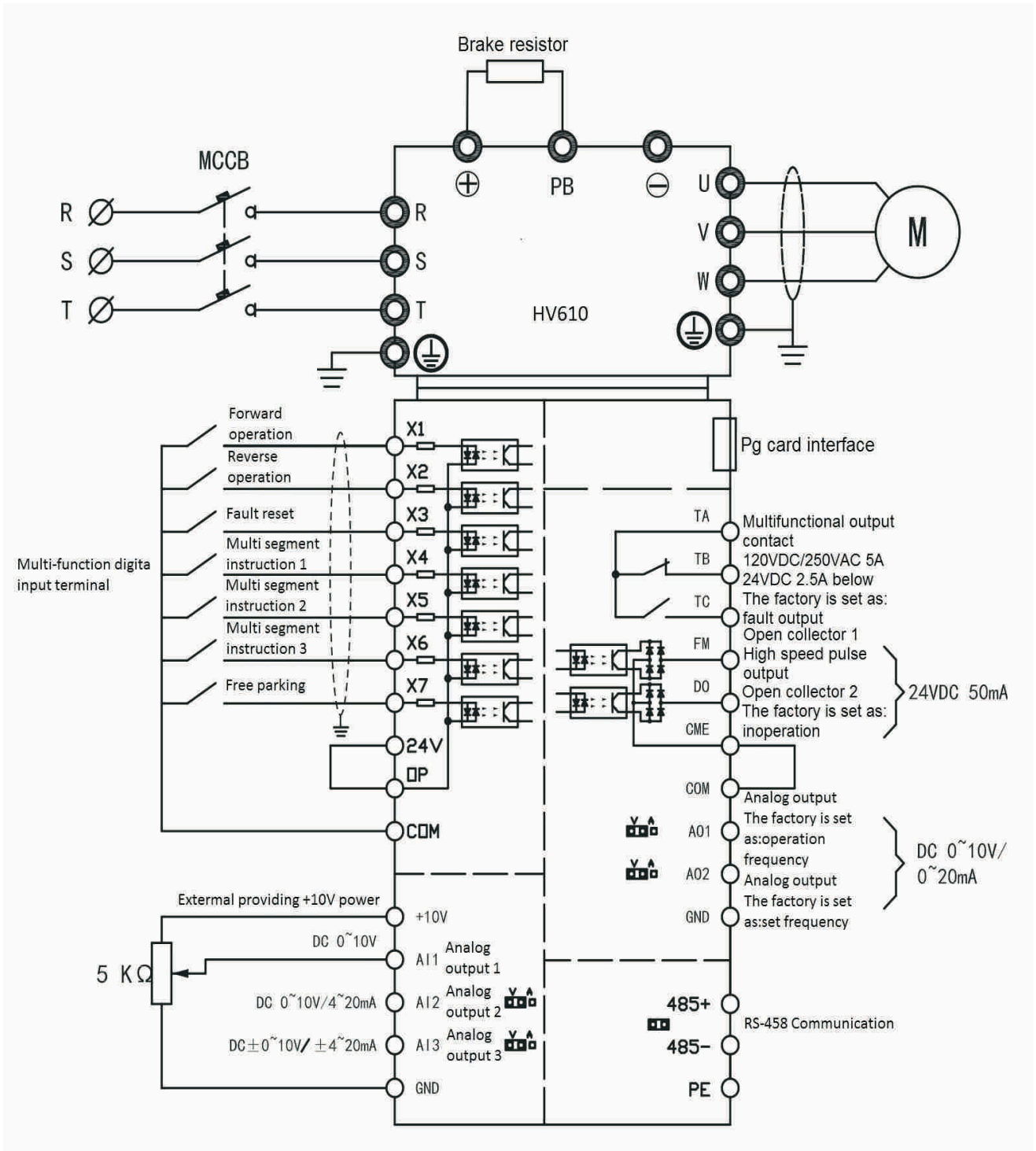

High performance vector control inverter

Expansion accessories

Picture	Model	Description
	PG card	
	HV610-PG-UVW	HV 610 encoder card, 5V / 15V, Differential input encoder, multi-output encoder signal
	HV610-PG-DIF	HV 610 encoder card, 5V, Differential encoder, 1:1 output encoder signal
	HV610-PG-OC	HV610 encoder card, 15V, Open collector encoder
	HV610-PG-RB	HV610 resolver card
	HV610-PG-TX	A B Z pulse input interface, MODBS-RTU communication
	Communication card	
	HV610-MS	Master-Slave communication card
	HV610-DP	HV610 Profibus-DP communication card
	USR-TCP232-410s	Ethernet TCP/IP communication card
	Keypad	
	HV610-Keypad	External Keypad
	HV610-LCDKeypad	External Keypad, LCD display
	HV610-KPHouse	HV610 keypad housing for remote installation
	HV610-CB	Extension cable for remote keypad installation
	Expansion board	
	Relay board	Convert "FM" and "DO" output to relay output



HNC ELECTRIC LIMITED is a company dedicated to the development and production of intelligent industrial automation solutions based on national strategic needs. Supported by its outstanding electrical and electronic technology and strong control technology, it provides control, display, drive and system solutions and other related products and services to customers worldwide.

With 25 years of hard work, we have developed and produced professional CNC systems, industrial robots, servo drives, servo motors, reducers, inverters, PLCs, HMIs, etc. In more than 50 countries and regions around the world, we have established a comprehensive agent system and after-sales service system. In the future, we will, as always, provide more professional services for global industrial automation.

HNC
Electric



Thanks for choosing HNC product
Any technique support, please feel to contact our support team

URL: www.hncelectric.com
Email: support@hncelectric.com