

# TM9-2320-218-10

DEPARTMENT OF THE ARMY TECHNICAL MANUAL

---

OPERATOR'S MANUAL

FOR

TRUCK, UTILITY, 1/4 TON, 4 x 4, M151

(2320-542-4783)

TRUCK, UTILITY, 1/4 TON, 4 x 4, M151A1

(2320-763-1 092)

TRUCK, UTILITY, 1/4 4 x 4, M151A1C,  
106MM RECOILLESS RIFLE

(2320-763-1091)

TRUCK, AMBULANCE, FRONTLINE,

1/4 TON, 4 x 4, M718

(23 1 o-782-6056)



HEADQUARTERS, DEPARTMENT OF THE ARMY  
MARCH 1968

**OPERATOR'S MANUAL**  
**TRUCK, UTILITY: ¼ TON, 4 x 4, M151**  
**TRUCK, UTILITY: ¼ TON, 4x4, M151A1**  
**TRUCK, UTILITY: ¼ TON, 4x4, M151A1C, 106MM**  
**RECOILLESS RIFLE**  
**TRUCK, AMBULANCE: FRONTLINE, ¼ TON, 4x4, M718**

	Paragraphs	Pages
<b>CHAPTER 1. INTRODUCTION</b>		
Section I. General -----	1-1, 1-5	1-1, 1-2
II. Description and data -----	1-6, 1-16	1-2, 1-16
<b>CHAPTER 2. OPERATING INSTRUCTIONS</b>		
Section I. Service upon receipt of vehicle -----	2-1, 2-2	2-1
II. Controls and instruments -----	2-3, 2-5	2-2, 2-3
III. Operation under usual conditions -----	2-6, 2-17	2-5, 2-13
IV. Operation under unusual conditions -----	2-18, 2-23	2-16, 2-19
V. 106mm recoilless rifle -----	2-24, 2-31	2-20, 2-23
VI. Truck, ambulance, frontline, ¼ ton, 4 x 4, M718 -----	2-32, 2-38	2-24, 2-26
<b>CHAPTER 3. MAINTENANCE INSTRUCTIONS</b>		
Section I. Parts, tools, and equipment -----	3-1, 3-4	3-1
II. Lubrication -----	3-5, 3-15	3-1, 3-11
III. Preventive-maintenance services -----	3-16, 3-22	3-11, 3-17
IV. Troubleshooting -----	3-23, 3-24	3-17
V. Corrective maintenance -----	3-25, 3-28	3-21, 3-23
VI. Maintenance under unusual conditions -----	3-29, 3-32	3-24, 3-25
<b>CHAPTER 4. MATERIEL USED IN CONJUNCTION WITH MAJOR ITEM</b>		
Section I. General -----	4-1, 4-2	4-1
II. Winterization kit (-65° F) -----	4-3, 4-9	4-1, 4-7
III. Hardtop enclosure kit -----	4-10, 4-15	4-9, 4-10
IV. Door and side curtain kit -----	4-16, 4-18	4-11, 4-13
V. Hot water heater kit (-25° F) -----	4-19, 4-25	4-14, 4-18
VI. Deepwater fording kit -----	4-26, 4-32	4-19, 4-23
VII. 100-ampere generator kit -----	4-33, 4-39	4-24, 4-25
VIII. Portable fire extinguisher -----	4-40, 4-45	4-27
IX. M4 pedestal gun mount -----	4-46, 4-50	4-27, 4-29
X. M14 rifle mount -----	4-51, 4-55	4-29, 4-30
<b>CHAPTER 5. SHIPMENT AND DESTRUCTION OF MATERIEL TO PREVENT ENEMY USE</b>		
Section I. Shipment -----	5-1, 5-2	5-1
II. Destruction of materiel to prevent enemy use -----	5-3, 5-5	5-1
<b>APPENDIX A. REFERENCES</b> -----	A-1, A-3	A-1, A-2
B. BASIC ISSUE ITEMS LIST -----	B-1, B-2	B-1
<b>INDEX</b> -----		I-1

\*This technical manual supersedes TM 9-2320-218-10, 17 October 1962, including all changes.

## CHAPTER 1

### INTRODUCTION

---

#### Section I. GENERAL

##### 1-1. Scope

*a.* This technical manual contains instructions for operation and operator maintenance of all four ¼ ton, 4 x 4, utility truck models M151, M151A1, M151A1C, and M718 frontline ambulance unless otherwise noted. It also provides operating and maintenance instructions for these vehicles when equipped with any of the special purpose equipment kits; deepwater fording, -65° F winterization, -25° F hot water heater, hardtop enclosure, 100-ampere generator kit, door and side curtain passenger enclosures, machinegun mount, and M14 rifle mount.

*b.* Before operating this vehicle the driver must be familiar with TM 21-305, the Driver's Manual. Also, he should be familiar with AR 385-55 on the prevention of army motor vehicle accidents, and AR 385-40 on accident reporting and records. For safe firing limits of the M151A1C, refer to figure 2-31. Appendix A contains a list of current references, technical manuals, forms and other available publications applicable to models M151, M151A1, M151A1C utility trucks and M718 ambulance.

*c.* Appendix B contains the basic issue items which are required for stockage by operational maintenance and includes accessories, attachments, component assemblies, and sub-assemblies with quantities thereof, which constitute the major end item of equipment; and the maintenance accessories, tools, supplies, and spare assemblies and parts accompanying the equipment, all of which constitute the major end item for issue to users.

*d.* Lubrication chart (fig 3-1) reflects the latest lubrication requirements and should be used as instructed.

*e.* Notice of discrepancies or recommended changes should be forwarded on DA Form 2028 direct to: Commanding General, U.S. Army Tank Automotive Command, 28251 Van Dyke, Warren, Michigan 48090, ATTN: AMSTA-TPW.

*f.* This technical manual differs from TM 9-2320-218-10, October 1962 as follows:

- (1) Adds information on utility truck, ¼ ton, 4 x 4, M151A1.
- (2) Adds information on utility truck, ¼ ton, 4 x 4, M151A1C, including the 106mm recoilless rifle.
- (3) Adds information on the M718 front-line ambulance truck.
- (4) Adds current operator's instructions for vehicles with special purpose kits; deepwater fording, -65° F winterization, -25° F hot water heater, hardtop enclosure, 100-ampere generator, machinegun mount, and M14 rifle mount kits.
- (5) Revises information and illustrations to correspond to current vehicle production standards.
- (6) Revises information on driver's preventive maintenance, troubleshooting, and corrective maintenance.

produced by Military Media Inc., copyright 1999

##### 1-2. Maintenance Allocation

The prescribed maintenance responsibilities, as allocated in the maintenance allocation charts are reflected in this technical manual. In all cases where the nature of repair, modification, or adjustment is beyond the scope of facilities of the operator, crew, or user, the supporting unit should be informed in order that trained personnel with suitable tools and

equipment may be provided or other instructions issued.

**1-3. Forms, Records, and Reports**

a. *Authorized Forms.* The forms generally applicable to units operating this materiel are listed in appendix A. For a listing of all forms, refer to DA Pam 310-2. Instructions for the use of the forms are contained in TM 38-750.

b. *Field Report of Accidents.*

(1) The accident reports and records required by the army safety programs are listed in AR 385-40. These reports are required whenever accidents involving injury to personnel or damage to materiel occur.

(2) Whenever an accident or malfunction involving the use of ammunition occurs, further firing of the lot which malfunctions will be immediately discontinued and reported in accordance with AR 700-1300-8.

c. *Equipment Improvement Recommendations.* Deficiencies detected in the equipment or materials should be reported using the Equipment Improvement Recommendation section of DA Form 2407 in accordance with TM 38-750.

**1-4. Equipment Serviceability Criteria**

Equipment serviceability criteria for the vehicles are found in TM 9-2320-218-ESC, ESC/1, and ESC/2.

**1-5. Abbreviations**

The abbreviations listed herein are explanations of abbreviations used on the vehicle data and service plates, throughout this manual, and in the basic issue items list.

- ac ----- alternating current
- approx ----- approximately
- assy ----- assembly (ies)
- cap ----- capacity

- CG ----- center of gravity
- cu ft ----- cubic feet
- cut ----- cutting
- dc ----- direct current
- dia ----- diameter
- EM ----- empty
- F ----- Fahrenheit
- ft ----- feet
- gal(s) ----- gallon(s)
- gr ----- grade
- hd ----- head
- hdl ----- handle (d)
- hex ----- hexagon
- i/a/w ----- in accordance with
- in. ----- inch (es)
- incl ----- including, inclusive
- infl ----- inflation
- lb ----- pound(s)
- lg ----- long
- LO ----- lubrication order
- lt ----- light
- max ----- maximum
- mfd ----- manufactured
- mfr ----- manufacturer
- mi ----- miles
- min ----- minimum
- MPH (mph) ----- miles per hour
- nom ----- nominal
- NR ----- non-expendable and recoverable
- opng ----- opening(s)
- pt(s) ----- pint(s), point
- qt(s) ----- quart(s)
- qty ----- quantity
- rd ----- round
- rd-pt ----- round point
- S ----- steel
- temp ----- temperature
- sgle ----- single
- stght ----- straight
- w ----- wide
- w/ ----- with
- w/e ----- with equipment
- w/o ----- without
- wt ----- weight

**Section II. DESCRIPTION AND DATA**

**1-6. Description of Vehicles (Figs 1-1 through 1-6)**

a. The 1/4 ton, 4 x 4, utility trucks, M151 and

M151A1 (figs 1-1, 1-2) M151A1C, including 106mm recoilless rifle, (fig 1-3) and M718 frontline ambulance truck (fig 1-4) are de-



signed for use over all types of roads as well as cross-country terrain, and in all weather conditions. While intended operations of the four vehicles vary, as well as some of their driving characteristics, maintenance support will be the same as for the M151 series trucks unless otherwise indicated. The vehicles have four driving wheels, and front-wheel drive may be engaged as road conditions and terrain conditions require. The vehicles are powered by a four-cylinder, in-line, liquid-cooled, gasoline engine, located forward of the passenger compartment, under the hood. Vehicles have four-wheel hydraulic service brakes and a mechanical parking brake which operates with a contracting band on the transmission-transfer brake drum. All wheels are individually suspended on coil springs. The body is of unitized construction, and proper precautions should be exercised in raising the vehicles (par 3-25). Airdrop eyes are provided at the wheels for securing vehicles to airdrop pallettes.

Pintle hooks are provided at the rear of M151 and M151A1 vehicles for towing trailers. Stowage space is provided for removable tops, tools, and miscellaneous equipment. The vehicles are designed to ford hard bottom water crossings to a depth of twenty-one inches. With the addition of deepwater fording equipment, and when applicable, vehicles will ford hard bottom water crossings to a depth of five feet. The vehicles should be driven very carefully until operators familiarize themselves with the different handling characteristics of the various model vehicles under different loads. Towed loads are prohibited with M151-A1C and M718 vehicles.

b. The M151,  $\frac{1}{4}$  ton, 4 x 4, utility truck (figs 1-1, 1-2) is a general purpose personnel or cargo carrier. It provides space for four men with equipment, including the driver. Its performance features are condensed, summarized and tabulated in paragraph 1-16.

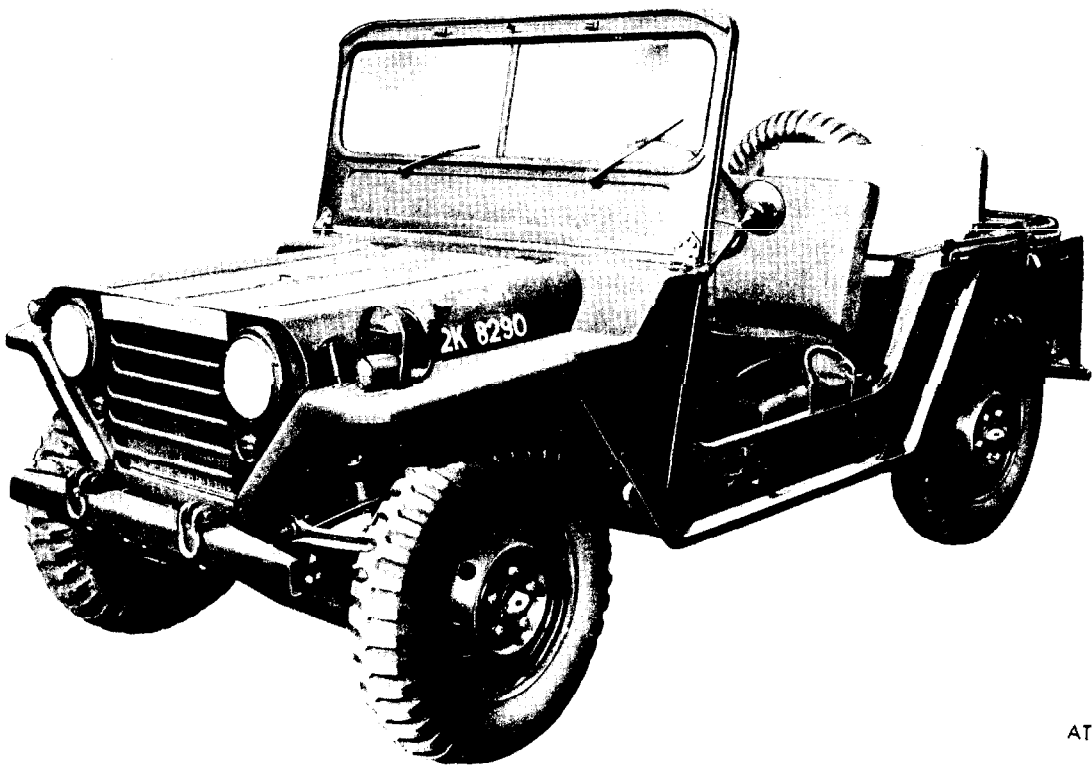

AT 8679

Figure 1-1. M151 and M151A1, 4 x 4,  $\frac{1}{4}$  ton, utility trucks, front  $\frac{3}{4}$  view with top removed.

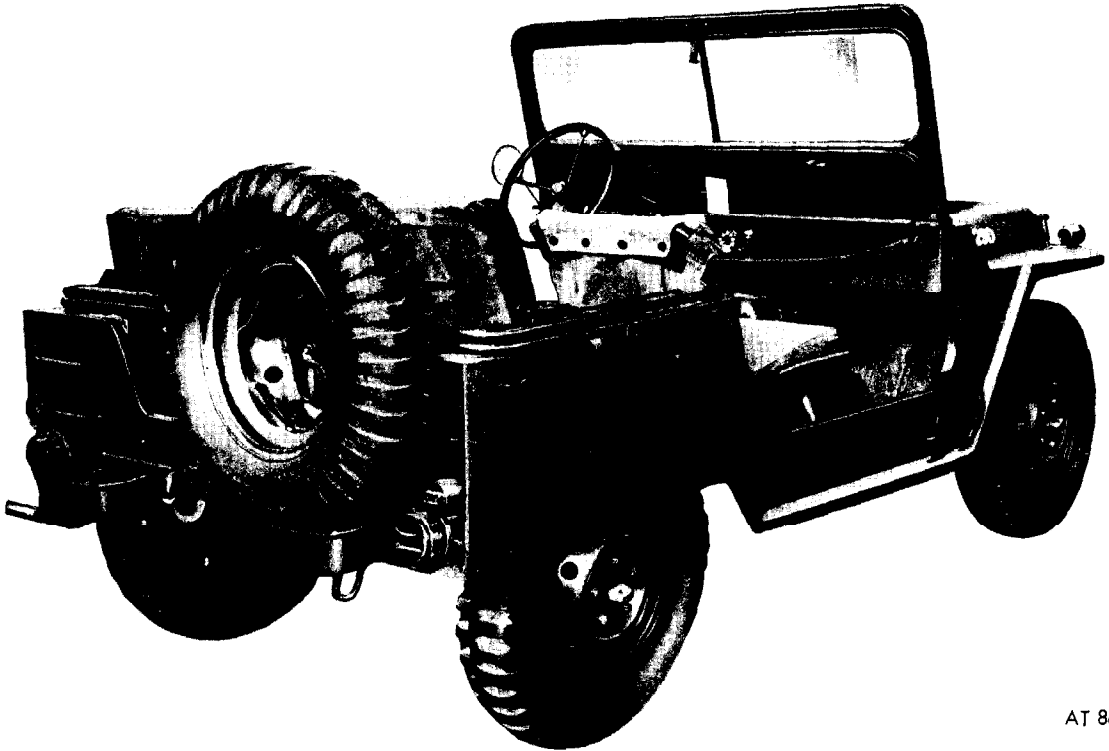

AT 8680

*Figure 1-2. M151 and M151A1, 4 x 4, 1/4 ton, utility trucks, rear 3/4 view with top removed.*

c. The M151A1, 1/4 ton, 4 x 4, utility truck (figs 1-1, 1-2) is a general purpose personnel or cargo carrier similar in outward appearance to the M151. Earlier M151 and M151A1 vehicles did not have directional turn indicators and later models do not have side reflectors. The main functional difference between the M151A1 vehicle and later models is that suspension systems are substantially stronger as described in paragraph 1-13. The performance features of the M151A1 vehicle are tabulated in paragraph 1-16.

d. The M151A1C vehicle, (fig. 1-3), is equipped with a 106 MM recoilless rifle, an M79 rifle mount, provisions for mounting six rounds of ammunition and the necessary hardware, to create a mobile weapon system.

e. The M718, 4 x 4, 1/4 ton, frontline ambulance truck (fig 1-4) is designed to carry ambulatory and litter patients, (par 2-34 (b)). The body of the M718 vehicle is 11" longer than M151 and M151A1 vehicles and 5" wider

to accommodate litters. Operators should be cautious when the M718 is loaded because of the changes in the center of gravity and other different handling characteristics created by the different size and weight of the vehicle.

#### **1-7. Engine**

The liquid-cooled 4-cylinder overhead valve gasoline engine (fig 1-7) delivers 71 horsepower. It has a pressure-type lubrication system. The engine is equipped with an oil filter, which is of the throwaway type, where the filter element and case are one unit. The case is designed for removal without the use of special tools. An oil pressure operated fuel pump safety switch functions to prevent the fuel pump from operating when the ignition switch is left on inadvertently. When the oil pressure drops below a safe operating range, the fuel pump safety switch results in opening an electrical circuit to the fuel pump causing it to stop operating. With no fuel, the engine

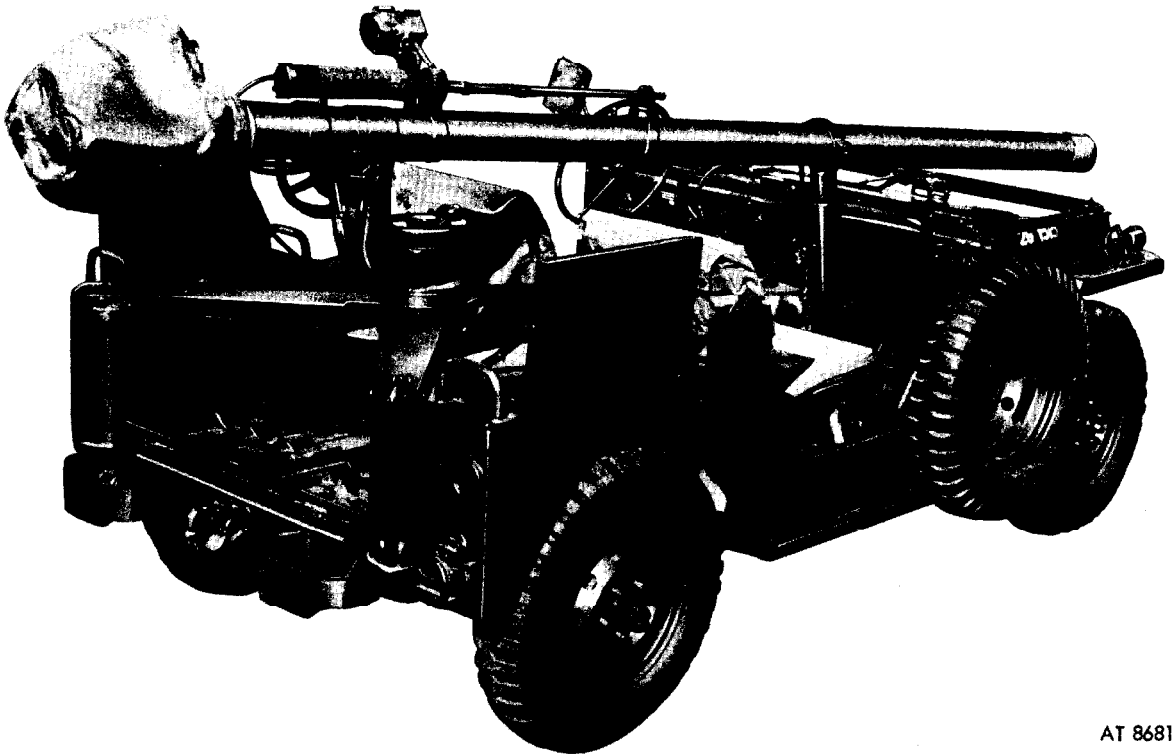

AT 8681

Figure 1-3. M151A1C, 106mm recoilless rifle, 4 x 4, 1/4 ton, utility truck; rear 3/4 view.

stops. When oil pressure rises to operating range, the fuel pump safety switch closes causing the fuel pump to function and to supply engine fuel. The engine is equipped with positive crankcase ventilation and eliminates entrance of water during fording operations. All openings are sealed to prevent entry of water.

### 1-8. Fuel System

The main components of the fuel system are the fuel tank, fuel pump, carburetor, air cleaner, and connecting lines and hose.

a. *Fuel Tank.* The fuel tank is located under the driver's seat. A drain plug is provided in the bottom center of the tank. The filler cap (gas tank cap) is a pressure-type cap with a valve inside. This valve is to be closed during deepwater fording. A removable strainer is provided in the filler neck of the tank. Changes were made in the original M151 gas tank filler cap, hence this item should be checked for the proper issue of equipment.

b. *Fuel Pump.* The fuel pump and filter is

an integral assembly, mounted inside the fuel tank. The pump is operated electrically and emits a ticking noise whenever it is pumping fuel. All fuel entering the pump first passes through the filter element, within which the pump is completely enclosed. If the ignition switch is left in the "ON" position with the engine not running, the fuel pump will stop pumping when the oil pressure is not high enough to close the fuel pump electrical circuit.

c. *Carburetor.* The carburetor is a side draft, single barrel type, mounted on the intake manifold on the left side of the engine. Vehicles may come equipped with either a Holley or Zenith carburetor. The carburetor is mechanically controlled by the accelerator pedal, hand throttle and manual choke. For deepwater fording (under water), the Holley carburetor is externally vented to the air cleaner. The Zenith carburetor is internally vented.

d. *Air Cleaner.* The air cleaner is an oil-bath-type, mounted with brackets to the left front

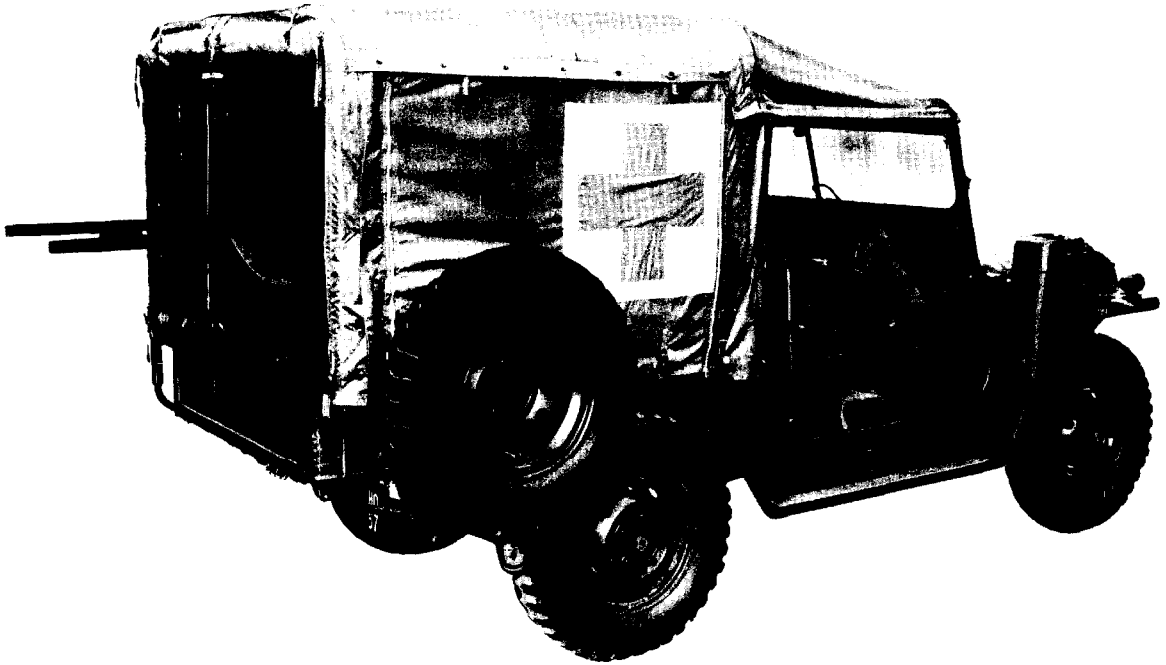

AT 8682

*Figure 1-4. M718, 4 x 4, 1/4 ton, frontline ambulance truck, rear 3/4 view.*

fender, inside the engine compartment. Provision has been made to attach an air intake pipe extension to the air cleaner for under-water operation of the vehicle.

### **1-9. Engine Cooling System (Fig 1-8)**

The engine is cooled by liquid pumped through the radiator and water jackets in the cylinder head and block. Coolant is circulated throughout the system by a pump, mounted on the front face of the cylinder block and driven by 2 "V"-type belts, on older models. Newer models have three belt pump drives. A thermostat to control flow of coolant through the radiator is located in the front center of the cylinder head; it starts to open at approximately 180° F. The system is pressurized and care should be exercised when removing the radiator filler cap. An electrical sending unit located on the rear of the engine cylinder head operates the temperature gage on the instrument panel.

### **1-10. Electrical System**

The vehicle electrical system operates on 24 volts. Two 12-volt batteries are connected in series. All major components of the electrical system, such as the generator, regulator, starter, and distributor are of waterproof design for operation under deep fording conditions. Extreme care must be exercised in using tools around any part of the electrical system. Serious damage to personnel and equipment can result from accidentally placing tool between a positive terminal, wire, or battery post and body ground (negative). While minor variations may be found on M-151 vehicles and later models, on the front of current vehicles will be found a blackout headlamp, two 7" sealed beam headlamps, two blackout markers and two directional signals. On current models, the rear of the vehicles mount a blackout stoplight on the right plus two light assemblies on either side containing vehicle service taillamps, service stoplights,

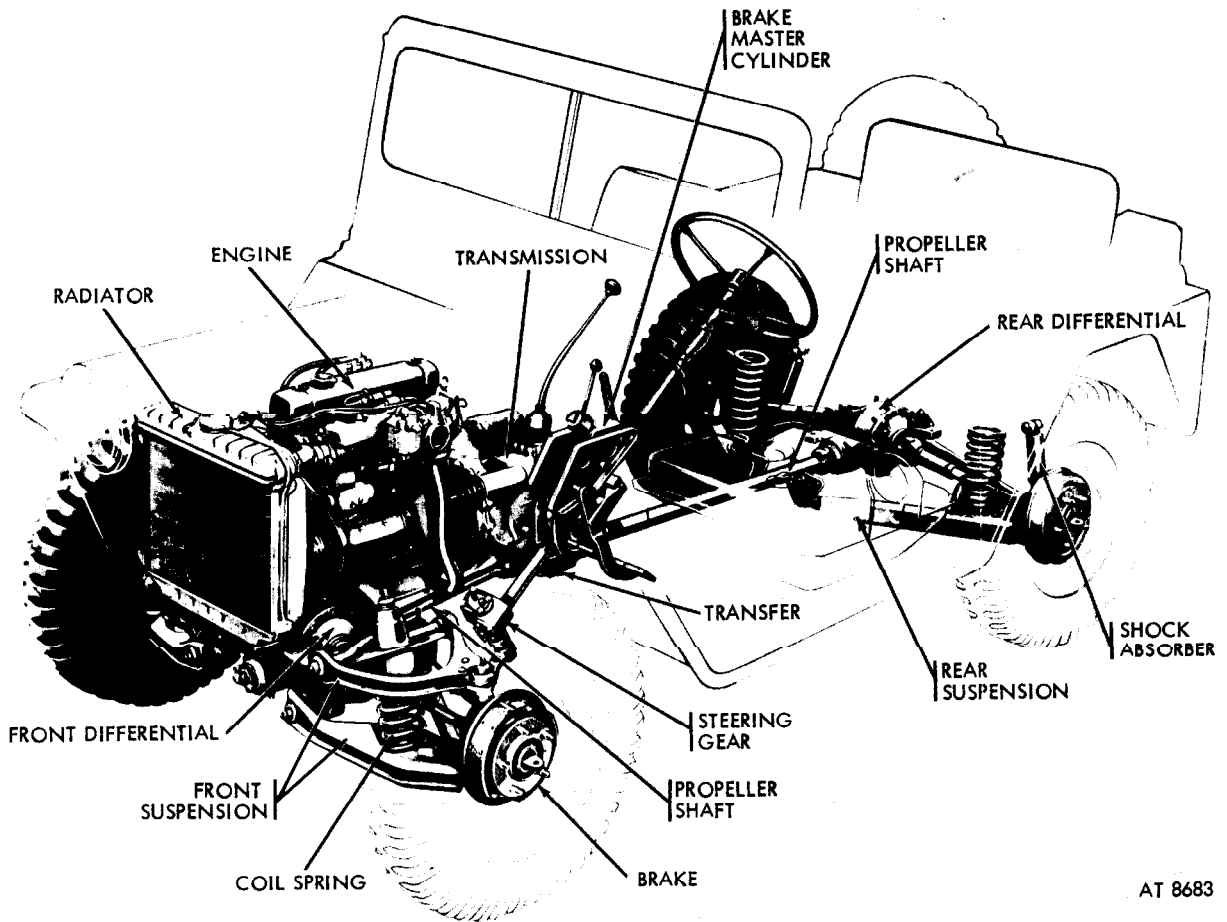

AT 8683

Figure 1-5. M151 and M151A1, 4 x 4, ¼ ton, utility trucks, locations of major components-cutaway view.

blackout taillight and directional signals. On later vehicles, left and right turn signals are actuated by the handle on the control box mounted to the left on the steering column. In its extreme "UP" position, this control activates the emergency flasher system. Aside from the 100-ampere generator (alternator) special purpose kit that may be installed, vehicles may come equipped with 25 ampere generators or 60-ampere generators (alternators). They are not interchangeable. In some vehicles 180-ampere generators (alternators) may be found for special purposes.

### 1-11. Brake Systems

The vehicle is equipped with a service brake

system and a parking brake. The service brakes operate from the brake pedal and do not show a rear service stoplight unless the light switch is correctly positioned for daytime driving (par 2-4d). The master cylinder is mounted on the left cowl and the filler plug is accessible from inside the engine compartment. One wheel cylinder is located at each wheel mounted to the backing plate. The parking brake is a drum and external contracting band-type. The drum is attached to the transmission output shaft. The brake is effective in either forward or reverse. On later model vehicles, the new Orscheln-style parking brake lever provides a rotary adjust-feature in the handle to provide degrees of tension on the brake band.

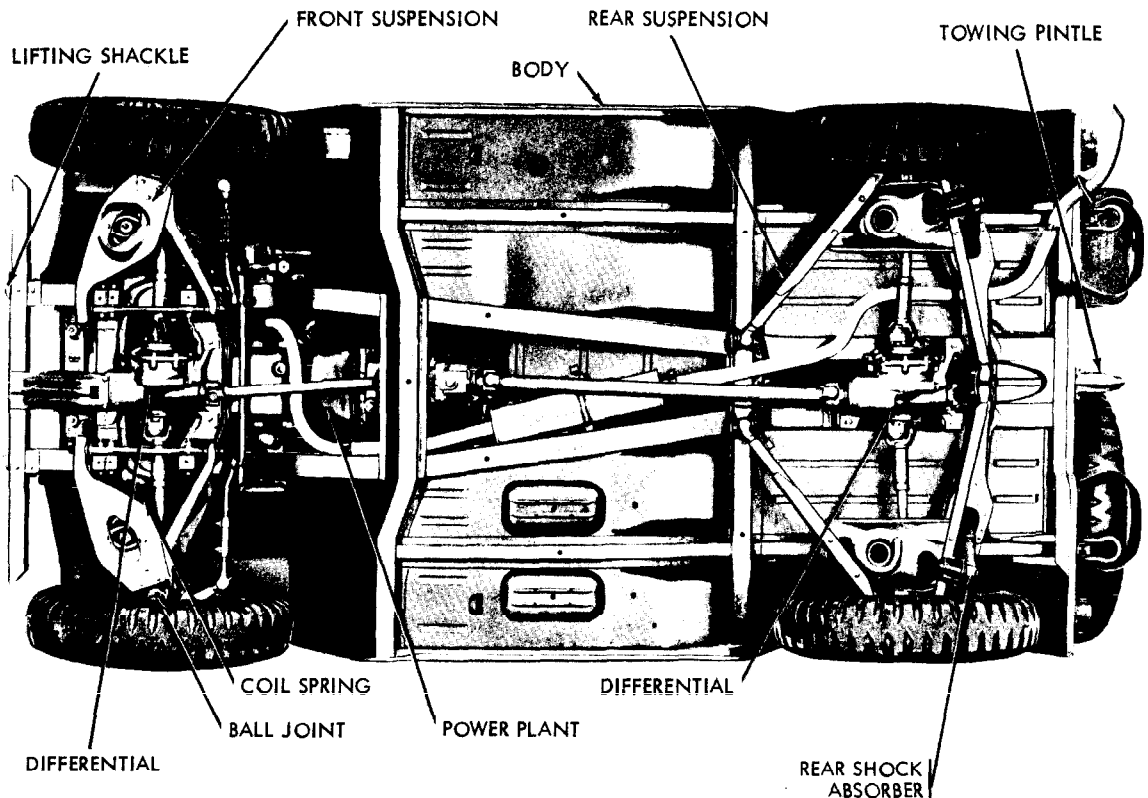

AT 8684

Figure 1-6. M151 and M151A1, 4 x 4, 1/4 ton, utility trucks, bottom view of vehicles.

### 1-12. Wheels and Tires

The wheels are made of steel alloy stampings and are secured to wheel spindle flanges by five nuts. All threads are right hand, and the retaining nuts are interchangeable from left to right sides. The tires are lightweight, low pressure type, with cross-country nondirectional tread design; size is 7.00 x 16.

### 1-13. Suspension

The vehicle is supported by individual coil springs at each wheel. An individual shock absorber is provided at each coil spring. The front shock absorbers pass through the coil springs. The front suspension is of the double arm type, while the rear is a single "A" shaped swing arm. The difference in suspension between the M151 vehicle and the M151-

A1, M151A1C and M718 vehicles is that on the latter vehicles rear suspension arms are constructed of stronger steel and are equipped with two rubber bump stops on each side instead of one. From a maintenance repair or replace standpoint, individual arms of the M151 and later models are not interchangeable, but the complete rear suspension assembly is interchangeable with the earlier model M151.

### 1-14. Differences Between Models

Differences, in abbreviated form, existing between vehicle models in the M151 series are tabulated in paragraph 1-16. Differences in models are also discussed in paragraph 1-6. It may be helpful to think of the M151A1 as a later and sturdier basic vehicle of the ori-

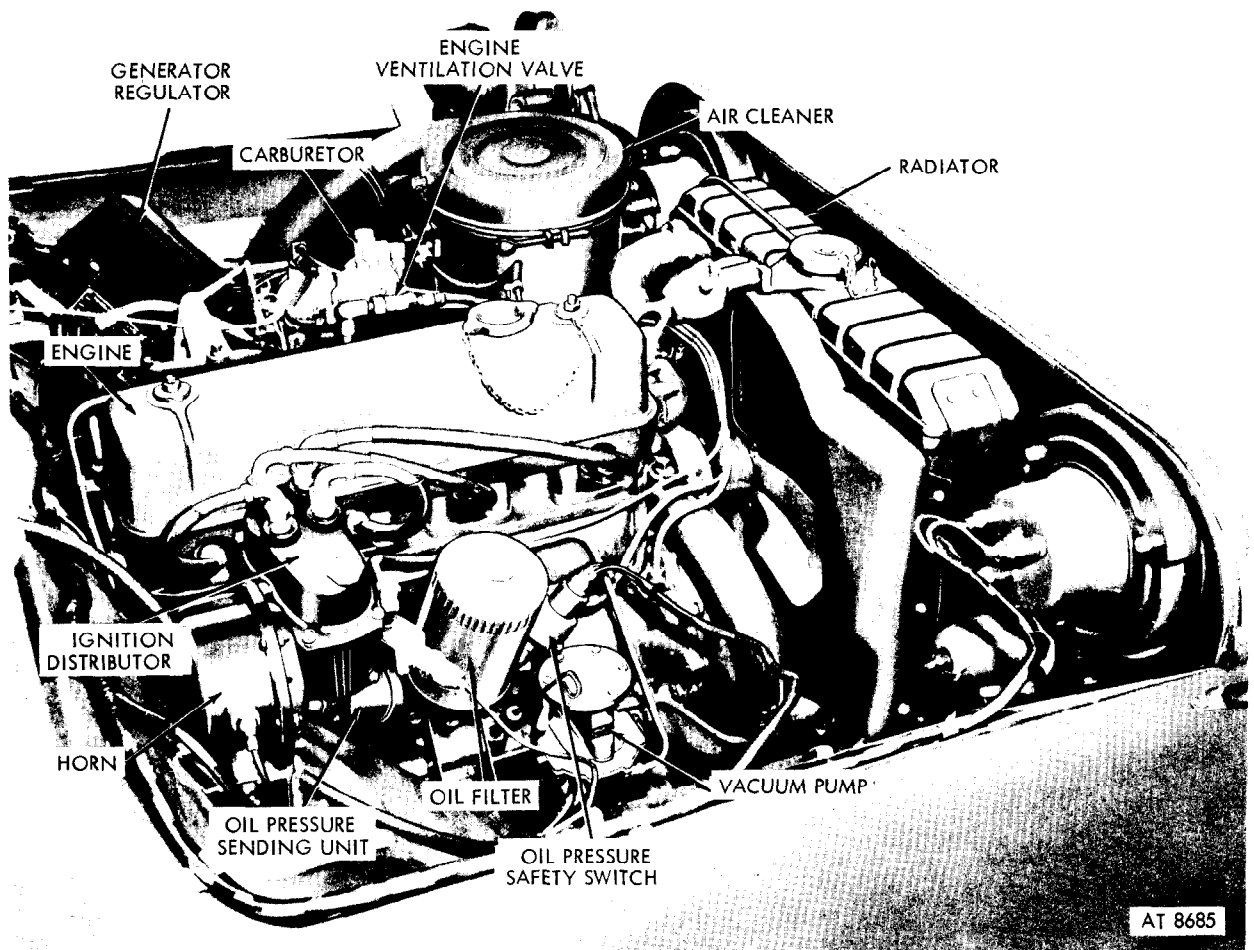

Figure 1-7. Engine compartment.

ginal M151 series with a "beefed-up" suspension system necessitated by the heavier loads imposed by the 106mm rifle installed to create the M151A1C, the litter load of the M718 ambulance truck model and for other performance improvements. In their designed operation, the M718 vehicle is intended to be used as a frontline ambulance, the M151A1C is intended as a mobile 106mm rifle weapon system, while the M151A1 is intended as a general purpose utility truck and personnel carrier, like its predecessor, the M151 vehicle.

#### 1-15. Name, Caution, and Instruction Plates (Figs 1-9 Through 1-13)

a. The location and details of certain name, caution, and instruction plates are shown in

figures 1-9 through 1-13. Observe all cautions and instructions on these plates at all times. For vehicle weight, dimensions, payload, towed load, and servicing data, refer to these vehicle data plates. Maximum permissible speeds are shown on dash plates but are not indicated to exceed safety limits. For an explanation of abbreviations used on the data plates, refer to paragraph 1-5.

b. Overlay plates are provided for those M151 vehicles provided with heavier suspension systems for installation over the originally equipped nameplates and bear the designation of truck, utility:  $\frac{1}{4}$  ton, 4 x 4, M151A1. (This applies to M151 vehicles prior to vehicle registration 2E8934 through 2J8393.)

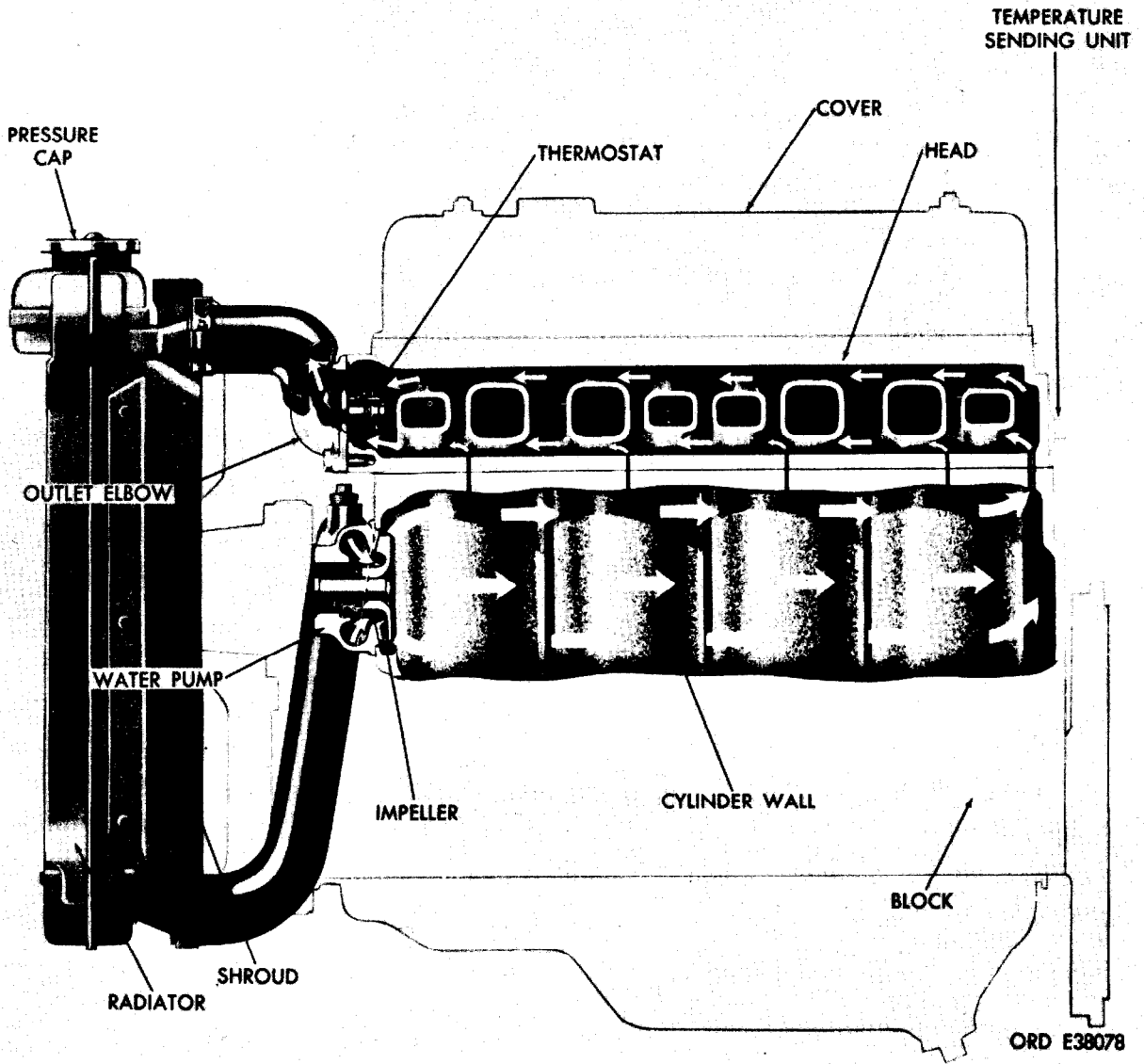
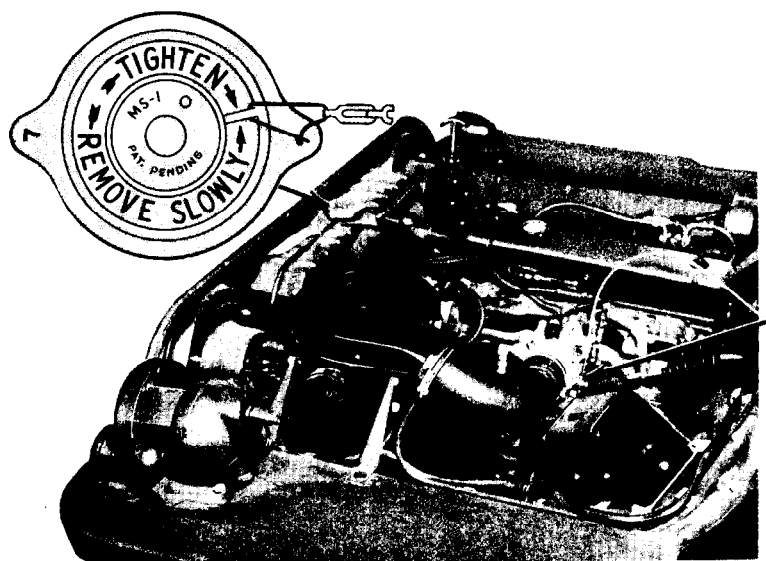

Figure 1-8. Engine cooling system.





SERIAL NO  
 ORD PART NO  
 CONTRACT NO  
 MODEL M-151  
 RATED R.P.M. 4200  
 FIRING ORDER 1-3-4-2  
 SPARK ADVANCE STATIC 6° B.T.C.  
 RESET INTAKE & EXHAUST VALVE LASH 0.15 HOT  
 MAIN OIL PRESSURE 35-45 P.S.I.  
 FUEL SUPPLY PRESSURE 4-5 P.S.I.  
 OIL PAN CAPACITY 4 QTS. ± FOR FILTER  
 ENGINE ROTATION CLOCKWISE VIEWED FROM FRONT  
 GASOLINE SPEC. MIL-G-3056 A  
 TIMING INTAKE VALVE CLOSES 68° A B C 000 CLEARANCE  
 OIL — OF 30 (MIL-L-2104) FOR +32° TO 120°F  
       OF 10 (MIL-L-2104) FOR -10° TO +40° F  
       OF 5 (MIL-L-10295) FOR -65° TO 0° F

AT 8686

Figure 1-9. Name, caution, and instruction plates, engine plate.

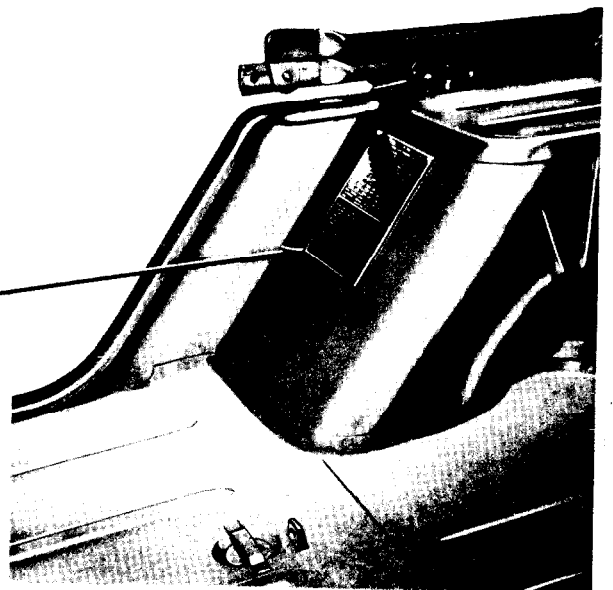
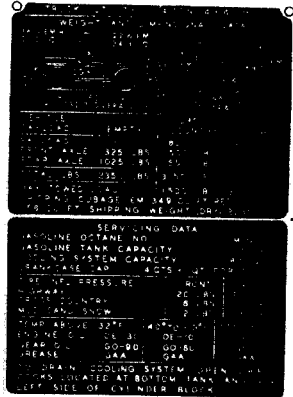
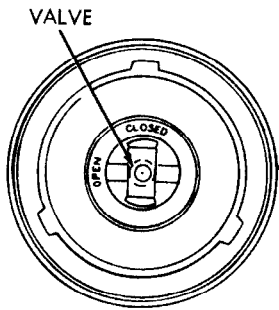
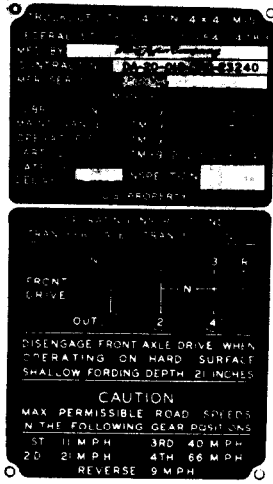
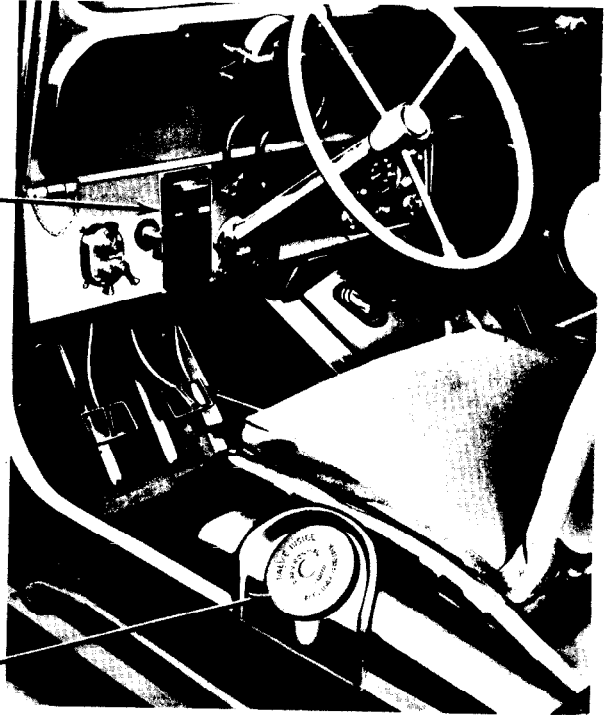

AT 8687

Figure 1-10. Typical M151 name, caution and instruction plates.

TRUCK, UTILITY 1/4 TON 4x4 M151A1  
 FEDERAL STOCK NO. 2420-218-1020  
 MFR. BY JORN MOTOR CO.  
 CONTRACT NO. DA 20 113 AMD 62787 (THY)  
 MFR. SERIAL NO. \_\_\_\_\_  
 MANUAL  
 LUBRICATION TM 9 2320 218 12  
 MAINTENANCE TM 9 2320 218 20  
 OPERATOR'S TM 9 2320 218 10  
 PARTS LIST TM 9 2320 218 20P  
 DATE OF DELIVERY \_\_\_\_\_ INSPECTION \_\_\_\_\_  
 U.S. PROPERTY

OPERATING INSTRUCTIONS  
 TRANSFER CASE TRANSMISSION

DISENGAGE FRONT AXLE DRIVE WHEN OPERATING ON HARD SURFACE SHALLOW FORDING DEPTH 21 INCHES

**CAUTION**  
 MAX. PERMISSIBLE ROAD SPEEDS IN THE FOLLOWING GEAR POSITIONS

1ST	11 M.P.H.	3D	40 M.P.H.
2D	21 M.P.H.	4TH	66 M.P.H.
		REVERSE	9 M.P.H.

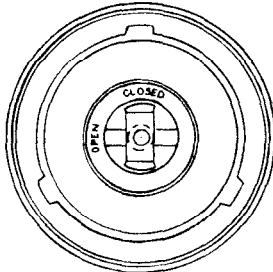
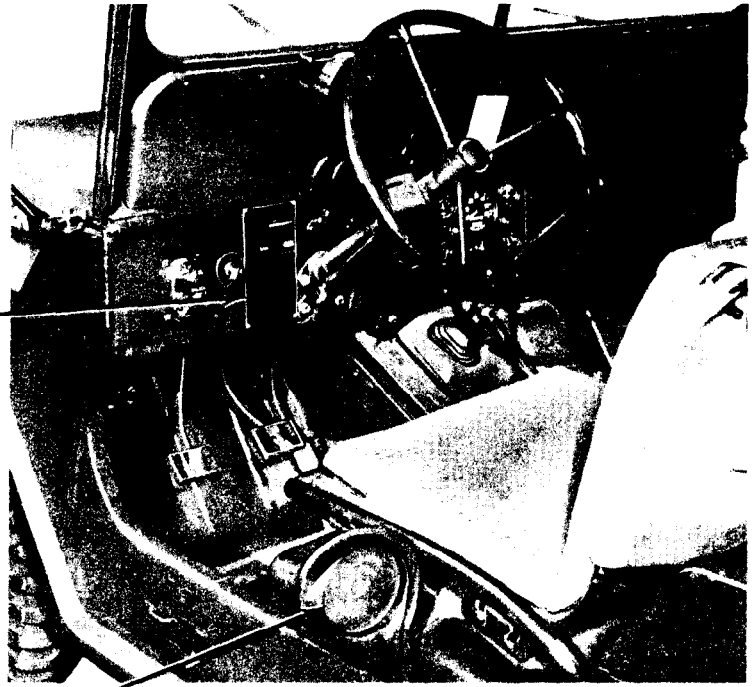

TRUCK, UTILITY 1/4 TON 4x4 M151A1  
**WEIGHT AND DIMENSIONAL DATA**

37.5EM	23.9EM	52.5EM	71.0EM
48.4HW	25.6HW	51.3HW	68.0HW

132.7 OVERALL 175 OVERALL

VEHICLE	EMPTY	CLOSE	HIGHWAY
PAYLOAD	800 LBS	COUNTRY	1200 LBS
FRONT AXLE	1340 LBS	1315 LBS	1370 LBS
REAR AXLE	1090 LBS	1085 LBS	2050 LBS
TOTAL LBS	2400 LBS	3200 LBS	3600 LBS

MAX. TOWED LOAD 17500 LBS 2000 LBS  
 SHIPPING CUBAGE 6M 350 CU. FT. REDUCED TO 260 CU. FT. SHIPPING WEIGHT (DRY) 2300 LBS

**SERVICING DATA**

GASOLINE OCTANE NO.	MIN 83
GASOLINE TANK CAPACITY	17 GALS.
COOLING SYSTEM CAPACITY	8.5 QTS.
CRANKCASE CAP. 4 QTS.	+1 QT. FOR FILTER

TIRE INFL. PRESSURE	FRONT	REAR
HIGHWAY	20 LBS	25 LBS
CROSS COUNTRY	20 LBS	20 LBS
MUD, SAND, SNOW	15 LBS	15 LBS

TEMP. SERVICE 70°F 40° 10° -10° F 0° 10° 25° F  
 ENGINE OIL OE 30 OE 10 OE 5  
 GEAR OIL GO 90 GO 80 GO 5  
 GREASE GAA GAA GAA

TO DRAIN COOLING SYSTEM OPEN DRAIN COCKS LOCATED AT BOTTOM TANK AND ON LEFT SIDE OF CYLINDER BLOCK

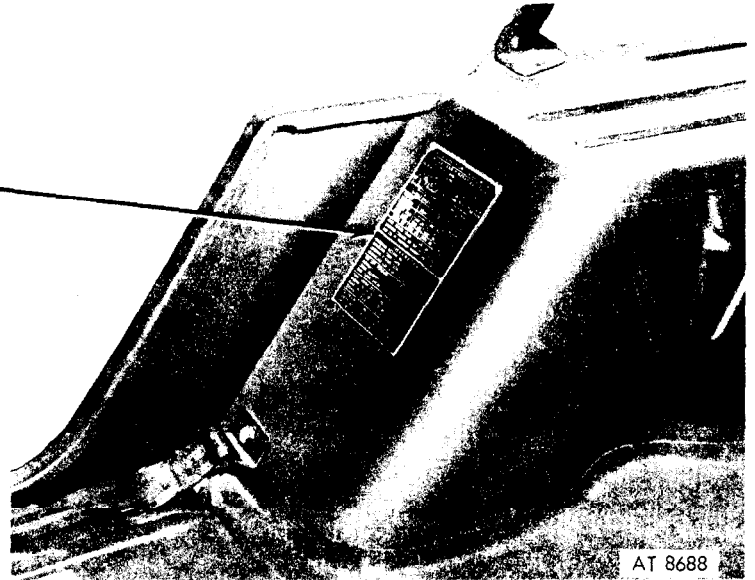

AT 8688

Figure 1-11. Typical M151A1 name, caution and instruction plates.

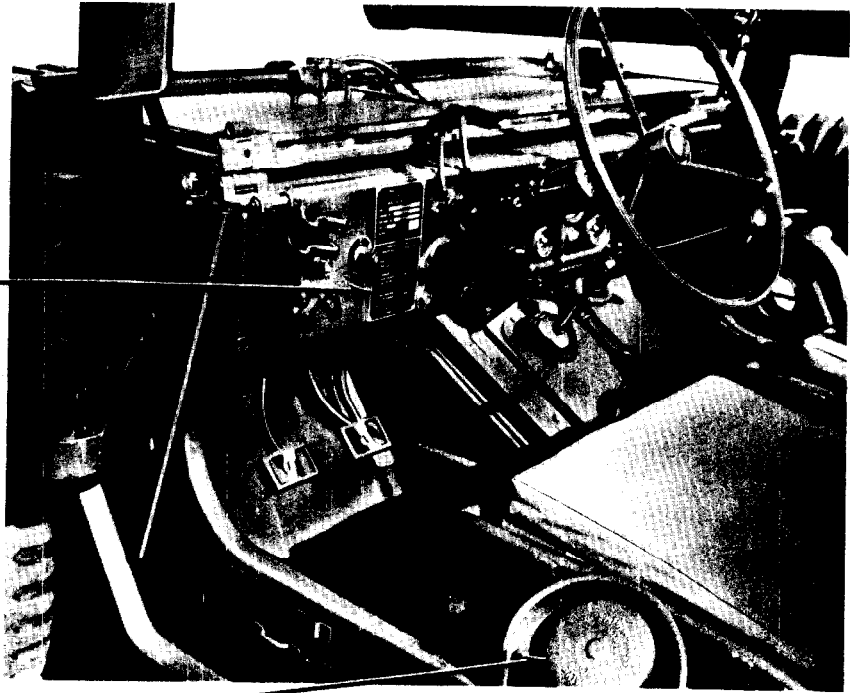

TRUCK UTILITY, TDM 4 X 4  
M151A1C  
FEDERAL STOCK NO 2320 781 1091

MFD BY \_\_\_\_\_  
CONTRACT NO \_\_\_\_\_  
MFR SERIAL NO \_\_\_\_\_  
DATE OF \_\_\_\_\_ INSPECTION \_\_\_\_\_  
DELIVERY \_\_\_\_\_

U.S. PROPERTY

OPERATING INSTRUCTIONS

TRANSFER CASE		TRANSMISSION	
FRONT	IN	1	2 R
DRIVE	OUT	3	4

DISENGAGE FRONT AXLE DRIVE  
WHEN OPERATING ON HARD SURFACE  
SHALLOW FORDING DEPTH 21 INCHES

TOP SPEED 60 M.P.H.

MAX PERMISSIBLE ROAD SPEEDS  
IN THE FOLLOWING GEAR POSITIONS:

1ST	11 M.P.H.	3D	40 M.P.H.
2D	21 M.P.H.	4TH	50 M.P.H.
REVERSE 9 M.P.H.			

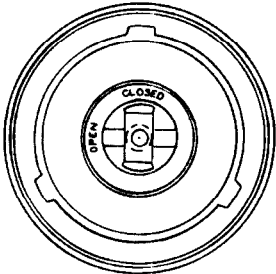

TRUCK UTILITY, TDM 4 X 4 M151A1C  
WEIGHT AND DIMENSIONAL DATA  
- 56 2 - 25 6

FRONT AXLE    REAR AXLE    TOTAL LBS  
1530 LBS    2970 LBS    4500 LBS

SHIPPING CUBAGE W/ CHIN    390 CU. FT.  
REDUCED TO 280 CU. FT.

WITH INFIL MOUNT KIT    2750 LBS  
WITH 106MM RIFLE (W. O. AMMO)    3220 LBS

SERVICING DATA

GASOLINE OCTANE NO.	MIN 83
GASOLINE TANK CAPACITY	17 GALS.
COOLING SYSTEM CAPACITY	8.0 QTS.
CRANKCASE CAP. 4 QTS. - 1 QT. FOR FILTER	
TIRE INFL. PRESSURE:	FRONT    REAR
HIGHWAY	23 LBS    40 LBS
CROSS COUNTRY	25 LBS    40 LBS
W/SD SAND/SNOW	20 LBS    35 LBS
TEMP. ABOVE 32°F	40 10 10 F 0 10 65 F
ENGINE OIL	OE 30    OE 10
SCALE OIL	OE 30    OE 10
GREASE	GAA    GAA

TO DRAIN COOLING SYSTEM OPEN DRAIN  
COCKS LOCATED AT BOTTOM TANK AND ON  
LEFT SIDE OF CYLINDER BLOCK

VEHICLE MANUALS

LUBRICATION	TM 9 2320-718 12
MAINTENANCE	TM 9 2320-718 20
OPERATORS	TM 9 2320-718 0
PART - LIST	TM 9 2320 818 20P
LUBRICATION	TM 9 1009 231 10
TECHNICAL	TM 9 1000-205 12

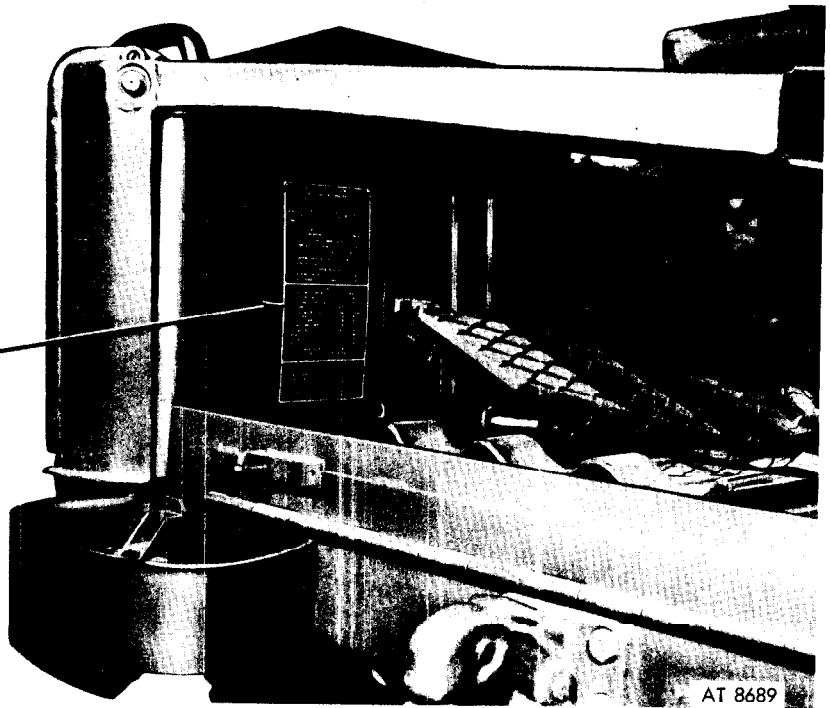

AT 8689

Figure 1-12. Typical M151A1C name, caution and instruction plates.

**TRUCK AMBULANCE, FRONT LINE, 1/4 TON, 4x4, M718**  
 FEDERAL STOCK NO. 2310-782-6056  
 MFD. BY **READ**  
 CONTRACT NO. **30-6-GP926-01-30-18**  
 MFR. SERIAL NO. \_\_\_\_\_

**MANUALS**  
 LUBRICATION LO-9-2320-218-12  
 MAINTENANCE TM-9-2320-218-20  
 OPERATOR'S TM-9-2320-218-10  
 PARTS LIST TM-9-2320-218-20P  
 DATE OF DELIVERY \_\_\_\_\_ INSPECTION \_\_\_\_\_

**U. S. PROPERTY**

**OPERATING INSTRUCTIONS**  
**TRANSFER CASE TRANSMISSION**

FRONT DRIVE

IN ○ 1 ○ 3 ○ R  
 ○ N ○  
 OUT ○ 2 ○ 4 ○

DISENGAGE FRONT AXLE DRIVE WHEN OPERATING ON HARD SURFACE SHALLOW FORDING DEPTH 21 INCHES

**CAUTION**  
 MAX. PERMISSIBLE ROAD SPEEDS IN THE FOLLOWING GEAR POSITIONS

1ST 11 M.P.H. 3RD 40 M.P.H.  
 2ND 21 M.P.H. 4TH 66 M.P.H.  
 REVERSE 9 M.P.H.

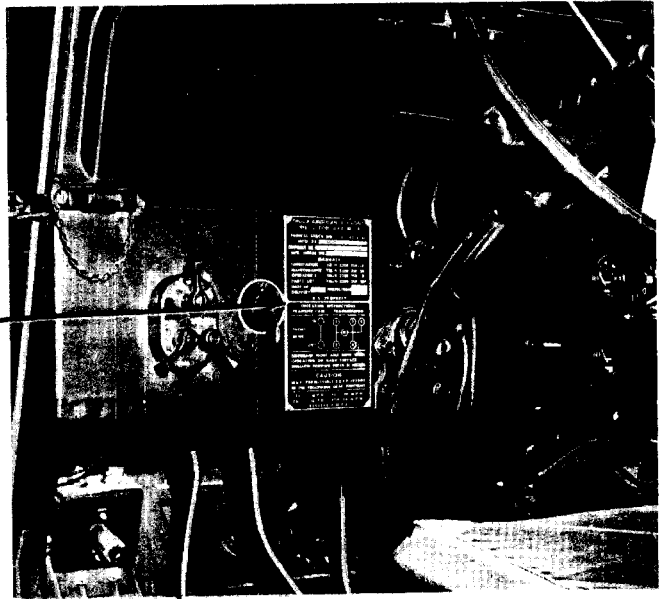

**TRUCK AMBULANCE, FRONT LINE, 1/4 TON, 4x4 M718**  
 WEIGHT AND CAPACITIES DATA

VEHICLE PAYLOAD

	EMPTY	1 OR 2 LP 2 AP LOADS
FRONT AXLE	1380 lbs	1800 lbs
REAR AXLE	1380 lbs	2272 lbs
TOTAL LBS	2760 lbs	4072 lbs

SHIPPING CUBAGE (M 35) (C 45) (R 45) (D 45) (E 45) (F 45) (G 45) (H 45) (I 45) (J 45) (K 45) (L 45) (M 45) (N 45) (O 45) (P 45) (Q 45) (R 45) (S 45) (T 45) (U 45) (V 45) (W 45) (X 45) (Y 45) (Z 45)

SHIPPING WEIGHT (D 45) (E 45) (F 45) (G 45) (H 45) (I 45) (J 45) (K 45) (L 45) (M 45) (N 45) (O 45) (P 45) (Q 45) (R 45) (S 45) (T 45) (U 45) (V 45) (W 45) (X 45) (Y 45) (Z 45)

**SERVICING DATA**

GASOLINE OBTANE NO.	MIN. 83
GASOLINE TANK CAPACITY	17 GALS.
COOLING SYSTEM CAPACITY	8.5 QTS.
CRANKCASE CAP.	4 QTS. 1 QT. FOR FILTER
TIRE INFL. PRESSURE	FRONT 20 lbs REAR 25 lbs
ROADWAY	20 lbs 25 lbs
CROSS COUNTRY	20 lbs 25 lbs
MUD, SAND, SNOW	15 lbs 20 lbs

TEMP. ABOVE 32 F TO 140 TO 10 F TO 65 F  
 ENGINE OIL DE 30 DE 10 DES 65  
 GEAR OIL 60 80 100 80 GDS  
 GREASE GAA GAA GAA

TO DRAIN COOLING SYSTEM OPEN DRAIN COCKS LOCATED AT BOTTOM TANK AND ON LEFT SIDE OF CYLINDER BLOCK

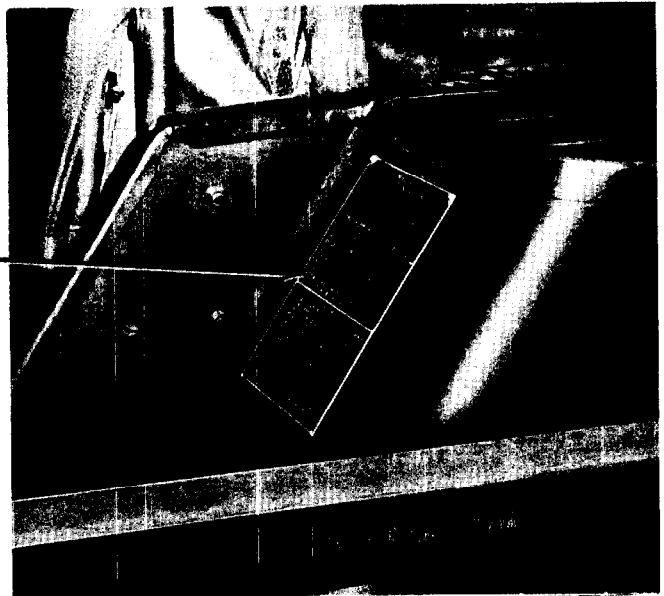

AT 8690

Figure 1-13. M718 name, caution and instruction plates.

**1-16. Tabulated Data**

<i>Model</i>	<i>M151</i>	<i>M151A1</i>	<i>M151A1C</i>	<i>M718</i>
<i>a. Max Permissible Road Speeds.</i>				
1st Gear -----	11 mph	11 mph	11 mph	11 mph
2nd Gear -----	21 mph	21 mph	21 mph	21 mph
3rd Gear -----	40 mph	40 mph	40 mph	40 mph
4th Gear -----	65 mph	65 mph	50 mph	65 mph
Reverse -----	9 mph	9 mph	9 mph	9 mph
<i>b. Fuel—All Models.</i>				
(95 minimum research octane) -----	17 gals	17 gals	17 gals	17 gals
<i>c. Fuel System—All Models.</i>				
Fuel filter: -----	Impregnated paper type located in fuel tank.			
Air cleaner: -----	Oil bath type located under hood.			
Fuel pump: -----	Electric type located in fuel tank.			
<i>d. Engine Oil Capacity.</i>				
Add for filter capacity -----	4 qts	4 qts	4 qts	4 qts
Oil, engine (above 32° F) -----	1 qt	1 qt	1 qt	1 qt
Oil, engine (40° F to -10° F) -----	OE-30	OE-30	OE-30	OE-30
Oil, engine (40° F to -10° F) -----	OE-10	OE-10	OE-10	OE-10
Oil, engine (0° F to -65° F) -----	OES	OES	OES	OES
<i>e. Differential Capacity.</i>				
Oil, gear (above 32° F) -----	2 pts	2 pts	2 pts	2 pts
Oil, gear (40° F to -10° F) -----	GO-90	GO-90	GO-90	GO-90
Oil, gear (40° F to -10° F) -----	GO-80	GO-80	GO-80	GO-80
Oil, gear (0° F to -65° F) -----	GOS	GOS	GOS	GOS
<i>f. Grease (Type).</i>				
	GAA	GAA	GAA	GAA
<i>g. Cooling System.</i>				
Radiator filler cap—all models: -----	Pressure type (7 psi)			
Thermostat type—all models: -----	Spring and cartridge			
Thermostat opening range—all models: -----	180° F to 202° F			
Thermostat location—all models: -----	Cylinder head			
Coolant -----	8.5 qts	8.5 qts	8.5 qts	8.5 qts
<i>h. Tires.</i>				
Number -----	5	5	5	5
Type—all models: -----	Lightweight nylon cord			
Tread—all models: -----	Nondirectional cross-country			
Size—all models: -----	7.00 x 16			
Plies -----	4 (6-ply rating)			
<i>i. Tire Inflation Pressure.</i>				
<b>Front Tires:</b>				
Highway use: -----	20 lbs	20 lbs	25 lbs	20 lbs
Cross-country use: -----	18 lbs	20 lbs	25 lbs	20 lbs
Snow, sand, mud: -----	12 lbs	15 lbs	20 lbs	15 lbs
<b>Rear Tires:</b>				
Highway use: -----	25 lbs	25 lbs	40 lbs	25 lbs
Cross-country use: -----	22 lbs	20 lbs	40 lbs	25 lbs
Snow, sand, mud: -----	18 lbs	15 lbs	35 lbs	20 lbs

<i>Model</i>	<i>M151</i>	<i>M151A1</i>	<i>M151A1C</i>	<i>M718</i>
<i>j. Electrical System—All Models, 24 Volts.</i>				
Batteries—all models: -----	2 under right seat			
Type, voltage and polarity: -----	2 HN, 12 volts, negative grounded			
Capacity: -----	45 ampere/hours at 20 hr rate			
Spark plugs: -----	14 mm size, .029-.032 gap			
Generator: -----	25 amp	25 amp*	25 amp*	25 amp*

\*See par 1-10 regarding 60-ampere generator (alternator).

<i>k. Service Brakes—All Models: Hydraulic.</i>				
Master cylinder: -----	Reservoir and cylinder located: cowl, left side			
Brake fluid capacity: -----	1 pt	1 pt	1 pt	1 pt

*l. Parking Brakes—All Models: Mechanical, drum and band.*

<i>m. Payload—Including Personnel:</i>				
Highway -----	1200 lbs	1200 lbs	2010 lbs	1200 lbs
Cross-country -----	800 lbs	800 lbs	2010 lbs (incl 106 mm rifle)	900 lbs

Rated payload:

<i>Front axle wt</i>				
Empty -----	1325 lbs	1340 lbs	1440 lbs	1385 lbs
Loaded -----	1500 lbs	1515 lbs	1695 lbs	1455 lbs
Cross-country -----	1500 lbs	1515 lbs	****	****
Highway -----	1535 lbs	1550 lbs	****	****
<i>Rear axle wt</i>				
Empty -----	1025 lbs	1060 lbs	1140 lbs	1395 lbs
Loaded -----	1650 lbs	1685 lbs	2895 lbs	2225 lbs
Cross-country -----	1650 lbs	1685 lbs	****	****
Highway -----	2015 lbs	2050 lbs	****	****
Gross vehicle wt.—highway -----	3540 lbs	3600 lbs	4590 lbs	3680 lbs
Shipping weight -----	2350 lbs	2400 lbs	3070 lbs (w/rifle) 2580 lbs w/inst., no rifle	2780 lbs

*n. Engine—All Models.*

General: -----	Army design, 4-cylinder, internal combustion			
Horsepower rating: -----	71 hp at 4,000 rpm at 60° F air temp			
Belts for fan, 25-amp generator, water pump -----	2, "V" wedge, 0.38 in. wide x 33 in. long			
Belts for later model vehicles -----	3 "V" wedge, 0.47 in. wide x 35.25 in. long			

*o. Dimensions.*

Length: -----	132.7 in.	132.7 in.	143.5 in.	143.0 in.
Width -----	64 in.	64.0 in.	76.5 in.	71 in.
To topmost point -----	71.0 in.	71.0 in.	77.2 in.	76.3 in.
Wheelbase: -----	85 in.	85 in.	85 in.	85 in.

*p. Personnel Complement:*

(Operator and crew/patients) -----	4	4	4	par 2-35 b
------------------------------------	---	---	---	------------

<i>Model</i>	<i>M151</i>	<i>M151A1</i>	<i>M151A1C</i>	<i>M718</i>
<i>q. Cruising Range.</i> (Without towed load) -----	300	300	275	300
<i>r. Fording Depth Without</i> Special Equipment -----	21 in.	21 in.	20 in.	21 in.
<i>s. Turning Radius</i> -----	17.9 ft	18.5 ft	18.5 ft	18.5 ft
<i>t. Vehicle Kits</i>				
Winterization (-65° F) -----	x	x		
Hardtop -----	x	x		
Machinegun mount -----	x	x		
Door and side curtain -----	x	x		
M14 rifle mount -----	x	x	x	
Deepwater fording -----	x	x		x
100-amp alternator -----	x	x	x	x
Heater, hot water (-25° F) -----	x	x	x	x



## CHAPTER 2

### OPERATING INSTRUCTIONS

---

#### Section I. SERVICE UPON RECEIPT OF VEHICLE

##### 2-1. General

*a.* When new, used, or reconditioned materiel is first received by the using organization, it is the responsibility of the officer-in-charge to determine whether the materiel has been properly prepared for service by the supplying organization and to be sure it is in condition to perform its function. Reporting will be done on DA Forms 2408-5, 2408-6, 2408-7, and 2408-8, which are records of all services and corrective maintenance. The following additional services are to be scheduled by the responsible officer.

- (1) New vehicle 500-mile service; to be scheduled on DA Form 2403 (Roster) for processing at 500 miles after vehicle issuance.
- (2) New vehicle 1000-mile service; to be scheduled on DA Form 2403 (Roster) for processing at 500 miles after completion of the 500-mile service.
- (3) Upon completion of the 1000-mile service, all oil change, lubrication and ("S" semiannual preventive-maintenance) services are to be scheduled and performed by organizational maintenance personnel in accordance with intervals prescribed by TM 9-2320-218-20.

*b.* If no previously performed, the following services must be accomplished before placing vehicle into service.

- (1) Lubricate vehicle in accordance with lubrication order regardless of interval, excluding gearcase and engine. Check processing tag for gearcase and engine oil. If tag states that oil is

suitable for 500 miles of operation and is of the proper viscosity for local climatic operation, check the level, but do not change oil.

- (2) Schedule second "S" service on DA Form 2403, Preventive-Maintenance Roster and arrange for oil change at 500 miles.

*c.* Services to be performed by operators are designated under preventive-maintenance services, paragraph 3-16. Maintenance services to be performed by organizational maintenance personnel upon receipt of vehicles are designated in TM 9-2320-218-20. Whenever practicable, operators, crews or users will assist organizational maintenance personnel in the performance of these services.

*d.* When using organizations receive M151-A1 vehicles, the general appearance is that of an M151; however, the differences are such that they are not visible externally. The main functional difference is in the rear suspension system and is described in paragraph 1-13.

##### 2-2. Break-In Services

*a.* Refer to Section II, Controls and Instruments, and to Section III, Operation Under Usual Conditions. Operators are cautioned to exercise special care in performing all before-operation checks and inspections as indicated by table 1.

*b.* Upon receipt of new vehicles, operators may find them somewhat more difficult to drive and stiff in their handling characteristics until they have been broken-in. Precautions, as necessary, should be taken.

c. The following must be avoided whenever practicable.

- (1) Excessive vehicle speeds. Refer to operating instruction data plates, figures 2-11 and 2-12.
- (2) Skipping gears when shifting.
- (3) Rapid acceleration or rapid deceleration, using engine as a brake.

(4) Loading beyond capacity.

(5) Overheating engine.

(6) Sudden or forced engagement of operating controls.

*Note.* Always use first gear for initial forward movement regardless of terrain conditions.

## Section II. CONTROLS AND INSTRUMENTS

### 2-3. General

This section describes, locates, illustrates, and furnishes operators, crews or drivers sufficient information pertaining to the various

controls and instruments provided for proper operation of the M151, M151A1, M151A1C and M718 vehicles. For special purpose equipment controls, refer to chapter 4.

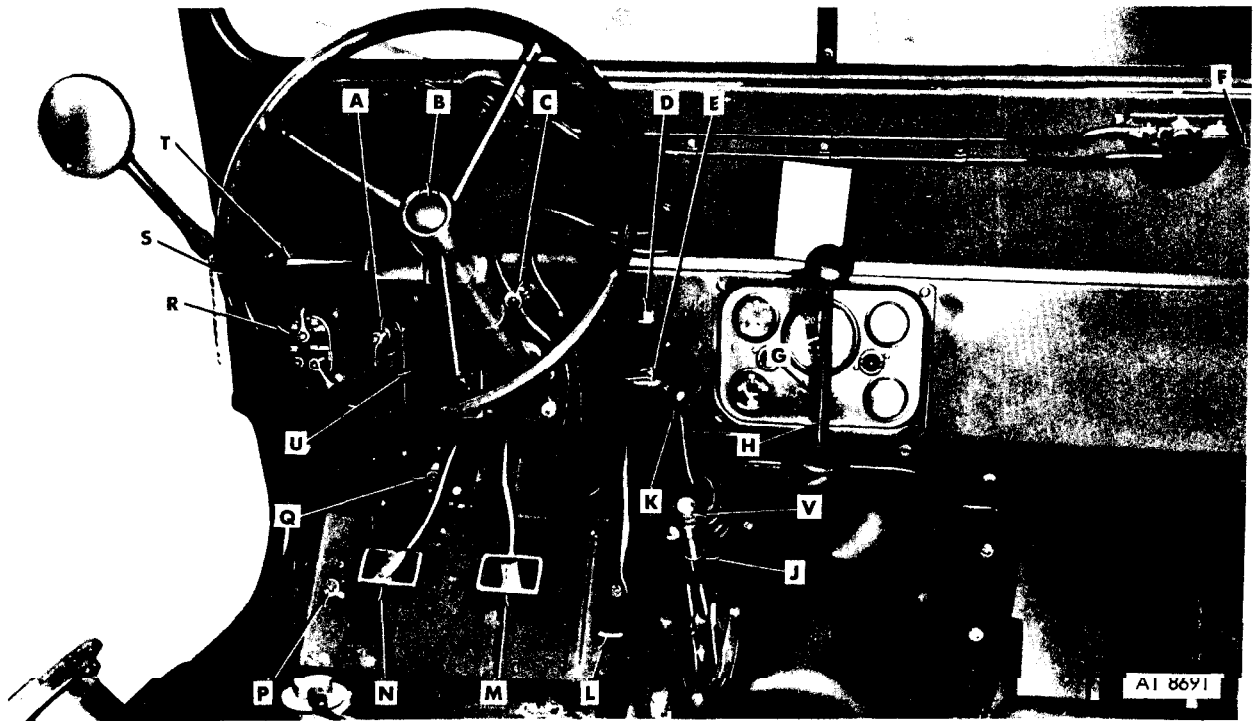

A—Ignition switch  
 B—Horn button  
 C—Windshield wiper valve  
 D—Choke  
 E—Throttle  
 F—Manual windshield wiper  
 G—High beam indicator

H—Transmission shift lever  
 J—Parking brake lever  
 K—Transfer shift lever  
 L—Accelerator pedal  
 M—Brake pedal  
 N—Clutch pedal  
 P—High beam selector switch

Q—Starter switch  
 R—Light switch  
 S—Steering wheel  
 T—Directional signal control switch  
 U—Vehicle instruction plate  
 V—Parking brake adjustment

Figure 2-1. Driving controls.

## 2-4. Driving Controls

All driving controls are illustrated in figure 2-1. Earlier models of the M151 vehicle may be found in the field without the directional signal lamps which are illustrated in this manual. They will be found on all later model vehicles, however.

a. *Transfer Shift Lever.* This control engages or disengages the front wheel drive. Front wheel drive can be engaged or disengaged during operation of vehicle without stopping or without engaging or disengaging the clutch. There are just two positions for the transfer shift lever, "IN" and "OUT". Gear selection for front wheel drive is always the same as for the rear wheels and is controlled by the transmission shift lever. In ordinary use under normal road conditions, the vehicle is operated with rear wheel drive only, the transfer shift lever being left in "OUT" position. The transfer shift lever position is illustrated in figure 2-1-(K).

b. *Starter Switch.* The starter switch is located in the upper portion of the floorboard above the clutch, to the upper right of the headlight high beam selector switch, and conveniently located for use by the left foot. The starter switch actuates the starter and should normally be accuated in the sequence described by paragraph 2-9. Location of the starter switch is illustrated by figure 2-1-(Q).

c. *Throttle.* The throttle provides for hand operated control of engine speed, independent of the accelerator. Its primary use is to hold engine speed at a selected level during starting and warmup. To increase engine speed pull out throttle; to decrease engine speed, turn throttle and push it in. A ratchet is incorporated in this control to hold it in desired position. The throttle knob must be turned so that the word "Throttle" is right side up in order for ratchet to engage. The throttle location is illustrated in figure 2-1-(E).

d. *Light Switch.* The light switch is operated by three levers; the selector lever, the auxiliary lever, and the unlock lever (fig. 2-2). The selector lever has five positions; "OFF," "BO/MK" (blackout marker), "BO DRIVE" (black-

out drive), "STOP LTS" (stoplights), and "SER DRIVE" (service drive). The auxiliary lever has four positions, "OFF," "PANEL BRT" (instrument panel bright), "DIM," and "PARK." This lever controls instrument panel brightness, and in the "PARK" position turns the headlights off while leaving the taillight and instrument panel lights on. The unlock lever prevents accidental movement of the selector lever to any position except "BO/MK" and "OFF". To move the selector lever to any other position, the unlock lever must be raised. The light switch location is illustrated in figure 2-1-(R).

**Caution:** Place selector lever to "STOP LTS" position for daytime driving.

e. *Directional Turn Signals.* Turn signals are composed of left and right front and rear on-off lamps, distribution box or solid state flasher and control handle assembly. The control handle is mounted on the left side of the steering column. In its "DOWN" position, lamps on the left side of the vehicle are actuated in an on-off fashion. Right hand lamps are actuated in the "UP" position. In its extreme "UP" position, the control handle actuates a solid state flasher by lifting a switch that switches all directional lights on and off to serve as a hazard or emergency warning.

f. *Rear Blackout Stoplight.* The blackout stoplight will be found mounted on the right rear of later model vehicles. On the right rear and the left rear of the vehicles will also be found two light assemblies. These lights perform the functions of blackout marker, service stoplight, service taillight and directional signal.

g. *Other Controls.* Other controls, such as headlight high beam selector switch and indicators, clutch pedal, brake pedal, accelerator pedal, parking brake lever, transmission shift lever, manual windshield wiper and wiper valve, horn button ignition switch, choke and steering wheel are shown in figure 2-1.

## 2-5. Instruments and Indicators

All instruments and indicators for operation of vehicle are illustrated in figure 2-3.

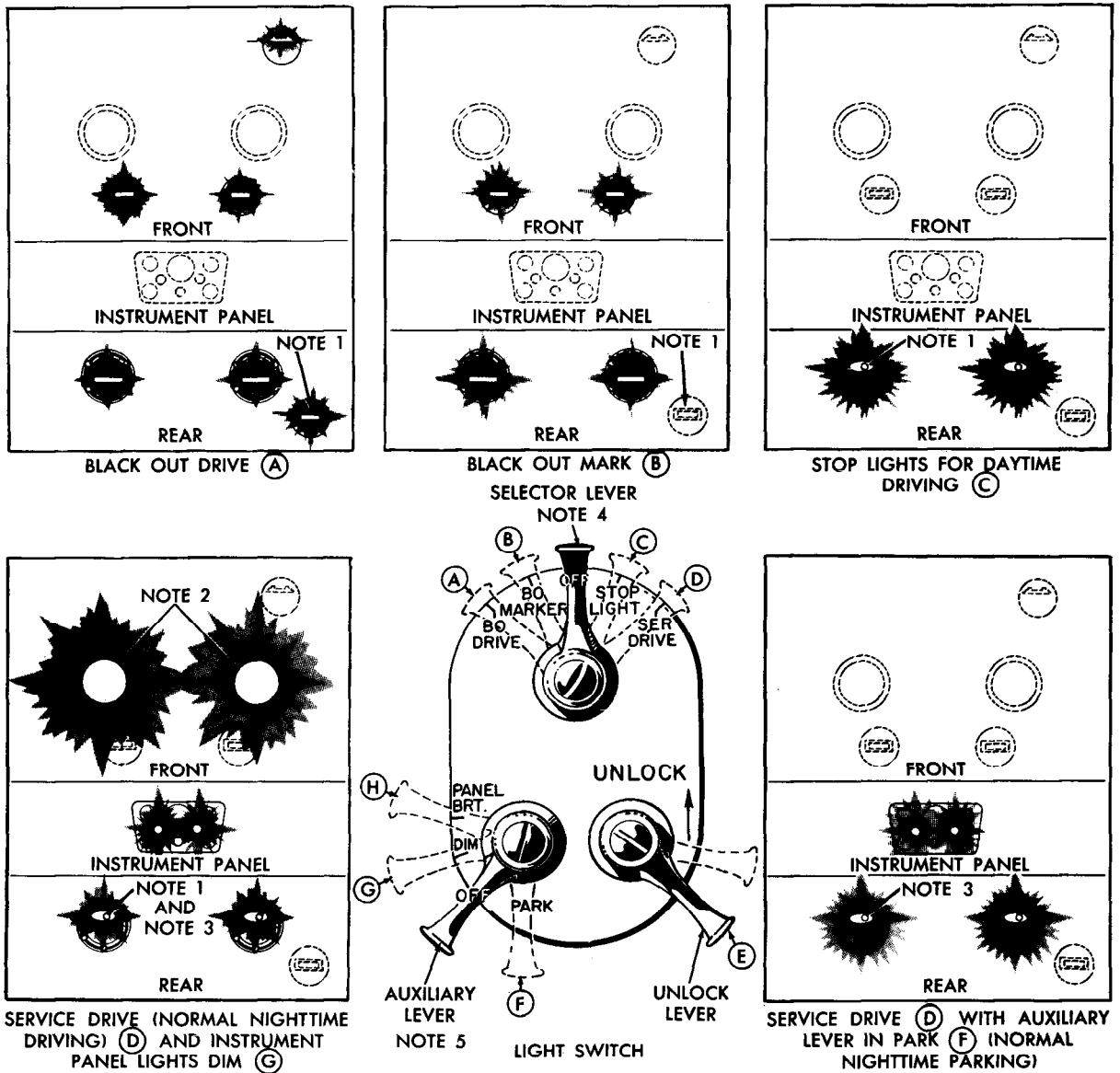

NOTE 1. STOP LIGHT GOES ON WHEN BRAKES ARE APPLIED

NOTE 2. DIMMER SWITCH OPERATES HI AND LO BEAM OF HEADLIGHTS WHEN IN SERVICE DRIVE (D).

NOTE 3. TAIL LIGHT GOES ON

NOTE 4. TO PLACE SELECTOR LEVER IN BLACKOUT DRIVE (A) STOP LIGHT (C), OR SERVICE DRIVE (D) UNLOCK LEVER (E) MUST BE LIFTED TO UNLOCK POSITION. NO LIGHTS OPERATE WHEN SELECTOR LEVER IS IN OFF POSITION.

NOTE 5. INSTRUMENT PANEL LIGHTS ARE BRIGHT IN PANEL BRT (H) POSITION. THE AUXILIARY LEVER CAN BE OPERATED AT ANYTIME IN ANY POSITION.

AT 8692

Figure 2-2. Operation of light switches.

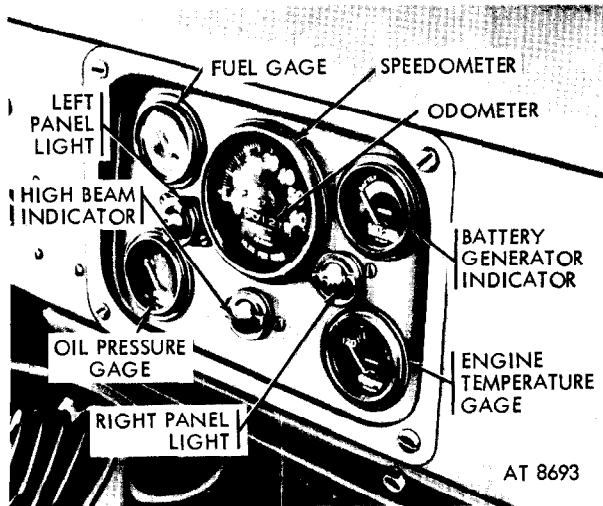

Figure 2-3. Instruments and indicators.

a. *Battery Generator Indicator.* This instrument indicates the condition of the batteries. During normal operation, the instrument pointer should be operating in the green area of the instrumental dial. If the instrument pointer consistently functions in the yellow or red area, a malfunction is indicated and should be reported to organizational maintenance.

b. *Headlight High Beam Indicator.* A red glowing light in the indicator indicates that

the headlight high beam is "ON". No light in the indicator, when headlights are "ON," indicates that the headlight low beam is "ON."

c. *Oil Pressure Gage.* This instrument indicates engine lubrication system pressure. Normal oil pressure at idle engine speed is 15 to 30 psi. Normal pressure at normal operating engine speed is 35 to 45 psi.

d. *Engine Temperature Gage.* This instrument indicates coolant temperature of the cooling system. If the temperature gage indicates an excessively high reading (220° F), stop engine and investigate cause.

**Warning:** Exercise extreme care in opening radiator filler cap. Open cap only a small amount to allow pressure to escape. Cap is designed for partial opening for this purpose.

e. *Fuel Gage.* This instrument indicates amount of fuel in the fuel tank. It is electrically controlled from a sending unit in the fuel tank.

f. *Speedometer.* This instrument indicates speed in miles per hour at which vehicle is traveling. The odometer indicates accumulated mileage.

g. *Left and Right Panel Lights.* Panel lights are provided to assist reading the instruments at night.

### Section III. OPERATION UNDER USUAL CONDITIONS

#### 2-6. General

This section contains instructions for the steps necessary to operate the 1/4 ton, 4 x 4, M151 and M151A1 utility trucks under conditions of moderate temperature, humidity, and terrain. These vehicles are lighter in weight, possess better acceleration, lower center of gravity, shorter turning radius and are speedier than their predecessors. With individual wheel suspension a better ride is provided and the body remains more stable. It is the only one of its type in the army vehicle fleet. These features give the driver a different "feel" than he is accustomed to in other vehicles. Therefore, special

emphasis on driver familiarization and training is necessary. In the case of M151A1C and M718 vehicles, because of additional loads, centers of gravities are changed and operators should also familiarize themselves with the handling characteristics and precautionary measures to be taken for safe operation of these vehicles. For operations under other than usual conditions, refer to paragraph 2-18.

#### 2-7. Operating Precautions

a. The speeds indicated on the instruction plates of the dash panels (figs 2-11, 2-12) are guides only to the mechanical capacity of the vehicle in each gear ratio. Data plate speeds

do not connote permission to drive beyond limits of safety, which are dependent on road conditions, weather, visibility, loading, and skill of drivers.

**Warning:** Extreme care should be used when driving M151 and M151A1 vehicles. They have more responsive steering and acceleration than other vehicles. Watch speed, especially on turns. A full right or left turn (90°) at speeds over 20 mph can cause any vehicle to go out of control and/or turn over.

b. Do not disengage clutch when descending hills, except when necessary to shift to a lower gear.

c. Do not partially engage (ride) clutch.

d. Do not race engine, especially when not under load.

e. Do not fill cooling system when engine is overheated.

f. Operate with recommended tire pressure (figs 1-10 through 1-13, par 1-16-i).

g. Do not operate starter for more than 30 seconds at a time. Wait at least 15 seconds between attempts to start engine. If engine fails to start after several attempts, refer to table 2.

h. Disengage front wheel drive when operating on hard surface unless grade is steep.

i. Bring vehicle to complete stop before shifting into reverse gear.

j. Keep vehicle under control at all times.

k. When vehicle is stuck or otherwise under heavy load, do not "rev" up engine and slip clutch to gain more torque. Such action will result in damage to clutch, pressure plate, and flywheel.

l. When vehicle is stuck, do not rock vehicle by shifting from first gear to reverse gear while throttle is partly open. Such action will damage transmission gear teeth. Operator must wait each time, before shifting gears to an opposite direction, for engine to return to idle speed and for transmission gear sets to stop revolving.

m. Do not shift into front wheel drive while one or both rear wheels are spinning (par 2-10-j).

n. Operators who have not been familiarized with these vehicles should be trained to be aware of what can be expected in performance and vehicle safety, and effective vehicle use.

o. Operators should train themselves to check the speedometer at all times. Observe curve conditions before entering and adjust speed accordingly. Sudden darting or sharp steering action at any speed is considered dangerous.

p. When towing a trailer, exercise care,

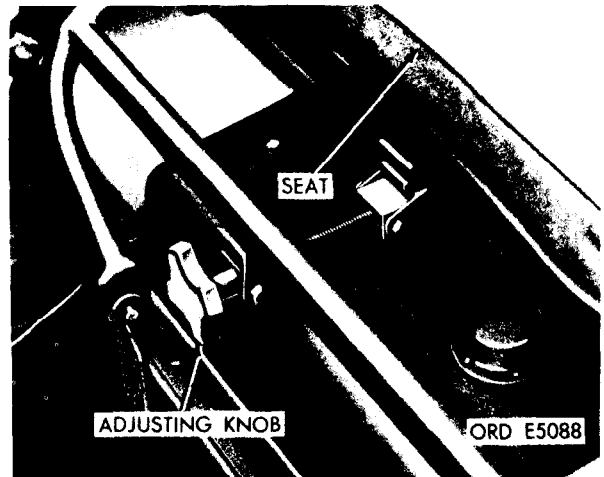

Figure 2-4. Seat adjustment—early model.

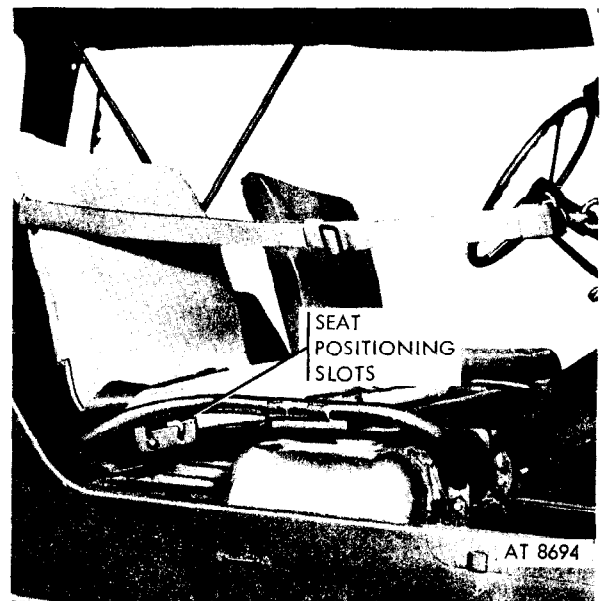

Figure 2-5. Two position seat adjustment.

especially when turning. The added towed load will increase the tendency of this vehicle to continue to steer into the turn. Do not use the M718 and M151A1C to tow additional loads.

g. Drive an unloaded vehicle at a lower speed than a loaded vehicle under the same operating conditions.

## 2-8. Before-Starting Operations

Before starting engine, perform applicable before-operation inspections and services outline in Table 1, Preventive-Maintenance Checks and Services.

## 2-9. Starting the Engine

a. Adjust drivers' seats for most comforta-

ble and effective position (figs 2-4, 2-5).

b. Apply (pull back) parking brake (figs 2-6, 2-1-(J)).

c. Place transmission (gear) shift lever in neutral (figs 2-6, 2-1 (H)).

d. Pull choke control as necessary (figs 2-7, 2-1-(D)).

e. Turn ignition switch to "ON" position (figs 2-8, 2-1-(A)).

f. Depress clutch pedal and depress starter switch with toe (figs 2-9, 2-1-(Q), 2-1-(N)). Release the starter switch when engine starts.

g. Adjust throttle (figs 2-7, 2-1-(E)), only

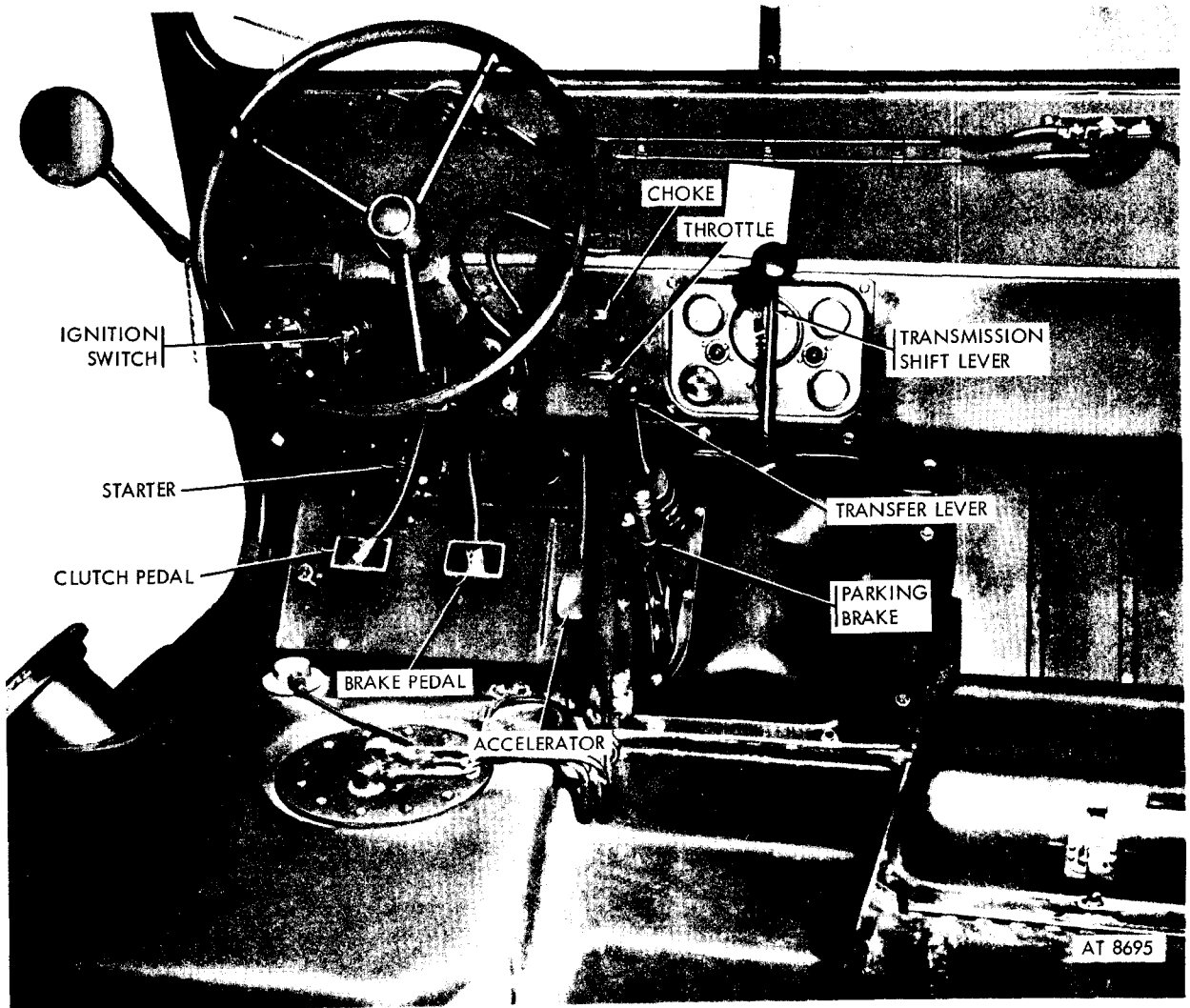

Figure 2-6. Starting and driving controls.

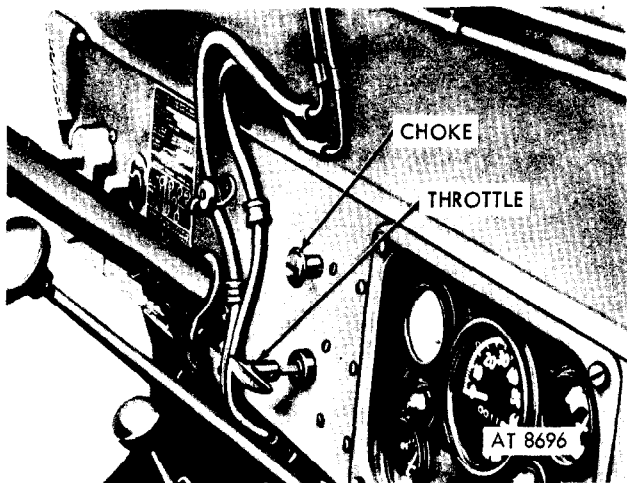

Figure 2-7. Choke and throttle.

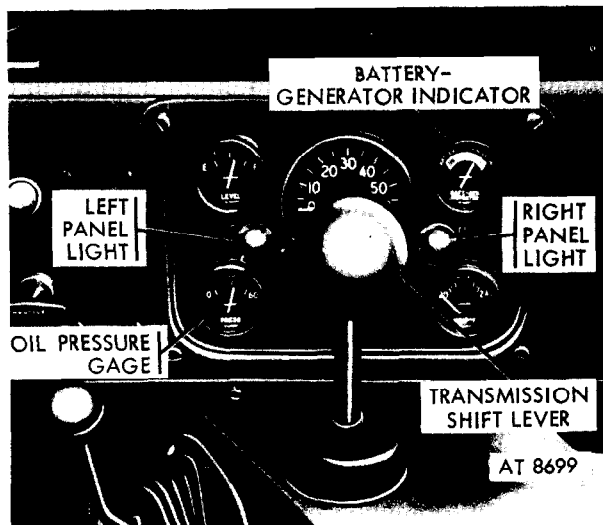

Figure 2-10. Oil pressure gage and battery generator indicator.

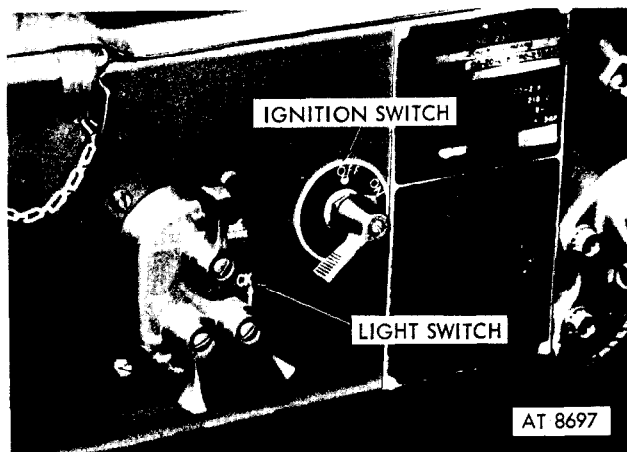

Figure 2-8. Light switch and ignition switch.

CAUTION		
MAX. PERMISSIBLE ROAD SPEEDS IN THE FOLLOWING GEAR POSITIONS		
1ST	11 M.P.H.	3RD 40 M.P.H.
2D	21 M.P.H.	4TH 65 M.P.H.
		REVERSE 9 M.P.H.

AT 8700

Figure 2-11. Maximum permissible road speeds, M151, M151A1, M718.

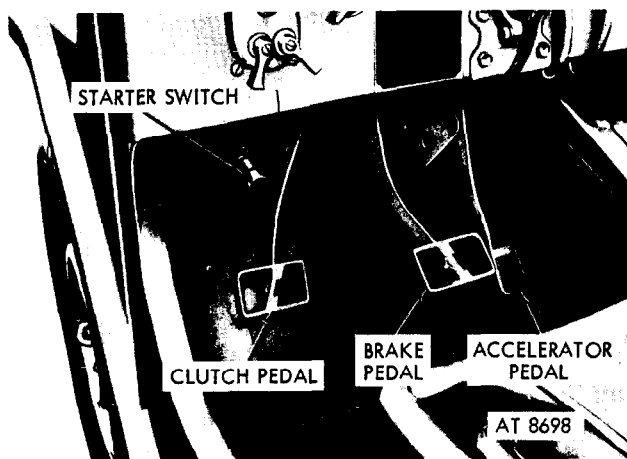

Figure 2-9. Starter switch and clutch pedal.

FRONT DRIVE		IN		OUT	
		1	3	R	
		2	N	4	
DISENGAGE FRONT AXLE DRIVE WHEN OPERATING ON HARD SURFACE SHALLOW FORDING DEPTH 21 INCHES					
<b>TOP SPEED 50 M.P.H.</b>					
MAX PERMISSIBLE ROAD SPEEDS IN THE FOLLOWING GEAR POSITIONS					
1ST	11 M.P.H.	3 D	40 M.P.H.		
2 D	21 M.P.H.	4TH	50 M.P.H.		
		REVERSE	9 M P H		

AT 8701

Figure 2-12. Maximum permissible road speeds, M151A1C.



when faster than normal engine speed is required, paragraph 2-4 c.

*h.* Check oil pressure (fig 2-10). Gage should read above 15. Battery generator indicator (fig. 2-10), should register in green area.

*i.* Push in choke control (figs 2-7, 2-1-(D)), when engine warms up.

## 2-10. Driving the Vehicle

*a.* Set light switch for stoplight operation (day time) or designated lighting (night time), refer to paragraph 2-4 *d* and figure 2-2.

*b.* Depress clutch pedal (figs 2-9, 2-1-(N)).

*c.* Place transmission shift lever (figs 2-10, 2-1-(H)), in first gear. Refer to shift pattern on dash panel plate (figs 2-1-(U), 1-10 through 1-13).

*Note.* Vehicle may be started in second gear on a hard level surface with a light load after it has been operated for more than 500 miles.

*d.* Place transfer lever (figs 2-10, 2-1-(K)) for front wheel drive in desired position. Refer to shift pattern on dash panel plate (figs 1-10 through 1-13).

*e.* Release parking brake lever (figs 2-6, 2-1-(J)) and move lever forward to release parking brake.

*f.* Slowly release clutch pedal (figs 2-9, 2-1-(N)) to engage clutch. Depress accelerator pedal (figs 2-9, 2-1-(L)) to increase engine speed.

*g.* As vehicle speed increases, shift progressively through second and third gears to fourth gear using clutch and decreasing engine speed between each shift.

*h.* For purely mechanical purposes, limits of safety not being considered, maximum permissible speeds in each gear position are listed on the dash panel plates, figures 2-11 and 2-12, located as illustrated in figure 2-1-(U). However, safety considerations must be exercised by operators at all times; observe applicable speeds.

*i.* When it is necessary to engage front wheel drive with transfer shift lever (figs 2-10, 2-1-(K)) move transfer lever forward to "IN" position.

*j.* Front wheel drive is used only under conditions where additional traction is needed, such as unusual road conditions, cross-country operation, or conditions involving mud, snow, sand, ice, steep grades, or fording. Front wheel drive can be engaged without stopping, slowing down, or declutching, and is accomplished by moving the transfer lever forward to the "IN" position.

**Caution:** When terrain conditions indicate the need for front wheel drive, shift the transfer lever before encountering the obstacle.

**Caution:** Do not attempt to shift "IN" to front wheel drive while one or both rear wheels are spinning. Depress clutch, idle the engine, and shift the transfer lever.

*k.* Under normal conditions on level terrain, front wheel drive can be disengaged, without stopping the vehicle, by pulling transfer lever backward to "OUT" position. Under conditions causing disengagement to be difficult, it may be necessary to drive a short distance in a straight line before disengaging front wheel drive.

*l.* The design of the suspension system must be considered when learning how to drive a vehicle. This is especially true of a small light vehicle such as the ¼ ton, 4 x 4, utility truck, M151. Lightweight vehicles in army use, such as the M151 and ¼ ton, 4 x 4, utility truck, M38A1, have different rear suspension systems. The M38A1 and earlier military vehicles use a solid axle type rear suspension. M151 series vehicles have an individual type rear wheel suspension. Refer to figure 2-13. Each system has its own operating and driving characteristics. Each requires driver familiarization and training to assure safe operation under all conditions, by the broad range of using personnel. Some of the differences that can be noticed by the driver are shown below:

*m.* When turning, or driving around a curve as illustrated by figure 2-13, vehicles with a solid axle using leaf springs (M38A1) show very noticeable body tilt (side tilt). This tilt tells the driver automatically that he is beginning to reach a speed where he should exercise greater care. Individual suspension equipped vehicles give a more level ride and, when turn-

REAR SUSPENSION SYSTEM COMPARISON

SOLID REAR AXLE SUSPENSION

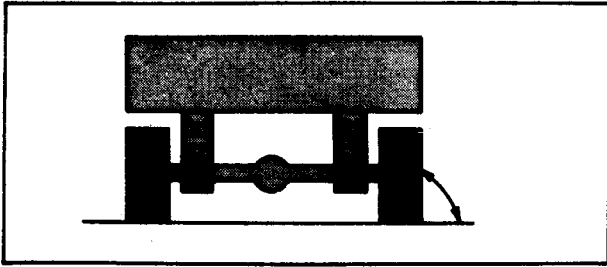

WHEEL ANGLE IS CONSTANT.

INDIVIDUAL WHEEL SUSPENSION

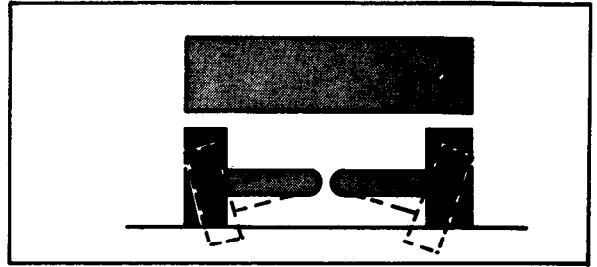

WHEEL ANGLE CHANGES WITH ROAD CONDITIONS AND LOADING.

Obvious body tilt gives early warning that vehicle is approaching its stability limit.

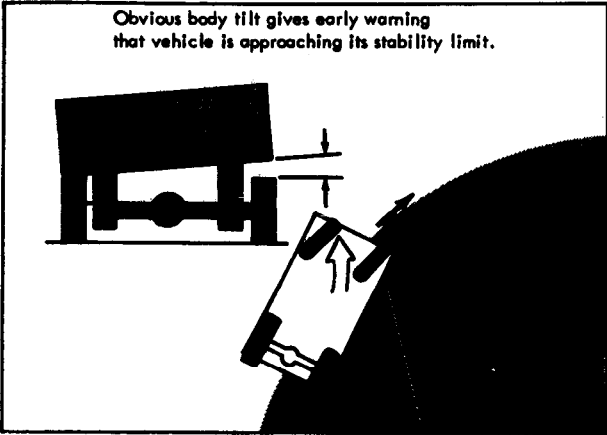

FORCES AT REAR WHEELS CAUSE REAR END TO STEER TOWARD CENTER OF CIRCLE.

Level ride gives little warning that vehicle is approaching the stability limit

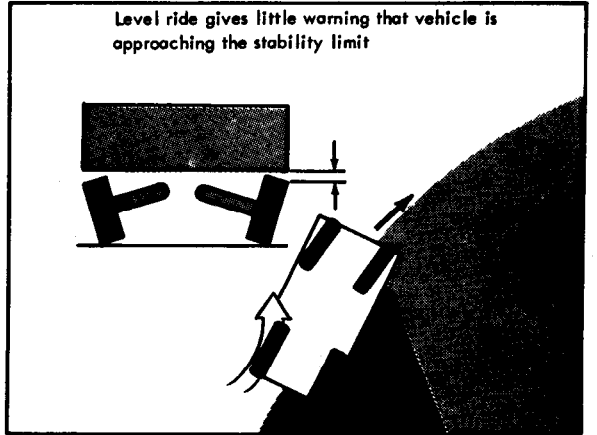

FORCES AT REAR WHEELS CAUSE REAR END TO SWING OUT OF CIRCLE.

Front end plows out on turn at an excessive speed. Correction is to reduce speed and steer into the turn.

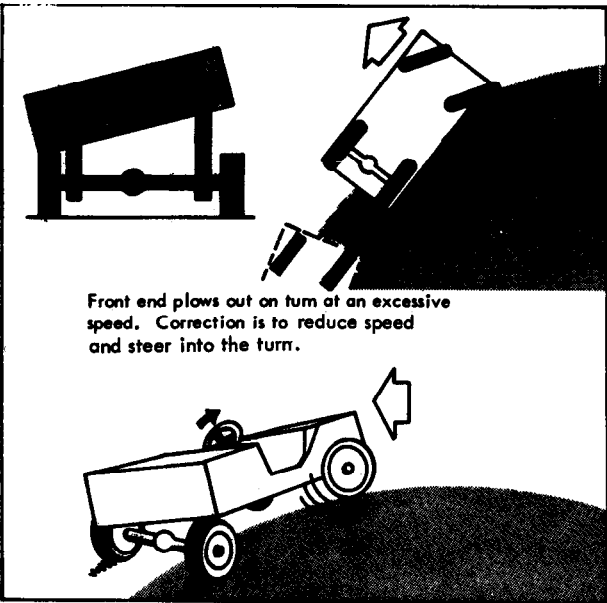

FRONT INNER WHEEL HAS TENDENCY TO LIFT.

Rear end breaks away to the outside of turn at an excessive speed. Correction is to reduce speed and steer out of the turn.

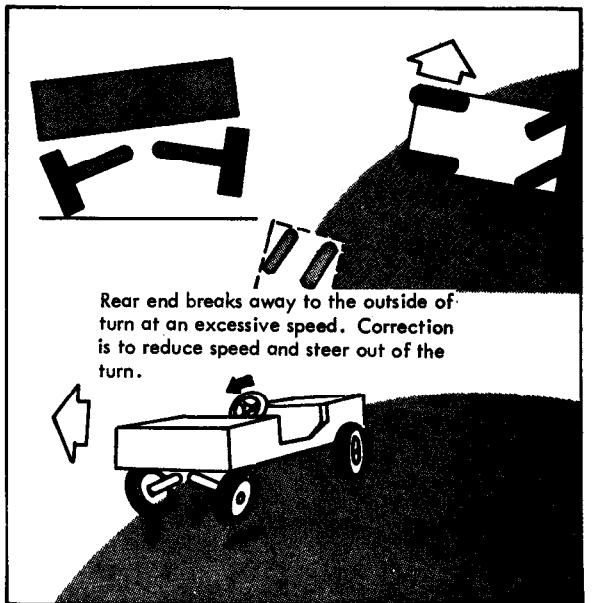

REAR INNER WHEEL HAS TENDENCY TO LIFT.

ORD E 80578

Figure 2-13. Rear suspension system, turning comparison.

ing, there is very little warning to the driver that he is reaching an unsafe speed and at the same time losing road traction.

*n.* The solid axle type suspension effect, as shown by figure 2-13, on steering is to steer the vehicle out of curves. Drivers correct this by turning into the turn. With individual rear wheel suspension the tendency is reversed. The vehicle tends to continue to steer into the turns, and drivers correct this by turning out of the turn.

*o.* Each system has different wheel to ground contact, figure 2-13, when cornering or turning. In the solid axle system the inside front wheel leaves the ground. In the individual wheel suspension system the inside rear wheel leaves the ground and the driver is required to compensate for this loss of traction at the inside rear wheel by reducing acceleration to maintain control. Avoid this situation.

*p.* With individual wheel suspension vehicles it can be shown that the ride is improved since much of the road shock is absorbed by the suspension. It is more difficult to realize at what speed the vehicle is going with this improved ride quality. Because of this improved performance it is easy to accelerate above safe speed limits without realizing this is being done.

## 2-11. Stopping the Vehicle

*a.* Release accelerator pedal and apply brakes. Apply brakes slowly to avoid skidding tires.

*b.* Just before vehicle stops, depress clutch pedal and shift transmission into neutral. Release clutch pedal. Apply parking brakes as applicable.

## 2-12. Driving in Reverse

*a.* Bring vehicle to complete stop.

*b.* Allow engine to return to idle speed. Depress clutch pedal and shift transmission into reverse gear. (For shift pattern refer to operating instruction plates (figs 1-10 through 1-13).) Release clutch pedal slowly.

**Caution:** Limit reverse speed to 9 mph.

## 2-13. Parking the Vehicle

*a.* Put all switches in "OFF" position unless tactical situation requires otherwise.

*b.* Apply parking brake. Chock wheels if on very steep grade.

*c.* Avoid parking in mud or water, if possible.

## 2-14. Operating the Lights

*a.* Refer to paragraph 2-4-d for instructions to operate lights required by mission assigned. Refer to TM 21-305 for additional information on operating lights.

*b.* To operate lights on towed trailer, insert trailer coupling cable into electrical connection receptacle at left rear corner of vehicle body. The vehicle lighting switch controls the trailer lights in the same way as it controls the vehicle lights. (Applicable to M151 and M151A1 vehicles only.)

## 2-15. Towing the Vehicle

*a.* The engine may be started by towing the vehicle only after proper approval has been obtained.

- (1) Attach towing cable to front lifting shackles on bumper. See figure 1-8.
- (2) Shift vehicle into high, 4th, gear.
- (3) Hold clutch pedal down and begin towing.
- (4) When speed of 5 to 10 miles per hour is reached, slowly lift foot from clutch pedal, turn on ignition switch, and depress accelerator; choke as necessary.

*b.* Towing the vehicle when disabled requires varied procedures depending on nature of disability. For this reason, no specific towing procedures are given. The following general procedures apply. Approval must be obtained for towing from the individual designated in authority.

**Caution:** Use the towing shackles for all towing operations.

- (1) If no damage exists in power train from wheels to transfer case, and front wheel drive can be disengaged

and transmission can be placed in neutral position, vehicle may be towed with all wheels on the ground.

- (2) If damage is within the transfer case, disconnect front and rear propeller shafts at differentials and secure end to frame. Vehicle may then be towed with all wheels on ground.
- (3) If damage is in either rear or front wheel drive shafts, universal joints, or differentials, remove front or rear wheel drive shafts. Vehicle may then be towed with all wheels on the ground.
- (4) To tow vehicle with front wheels off the ground, disengage front wheel drive by moving transfer lever to the "OUT" position.
- (5) In all situations under which a disabled vehicle is to be towed, be sure to place transmission gearshift lever in neutral position and disengage front wheel drive.

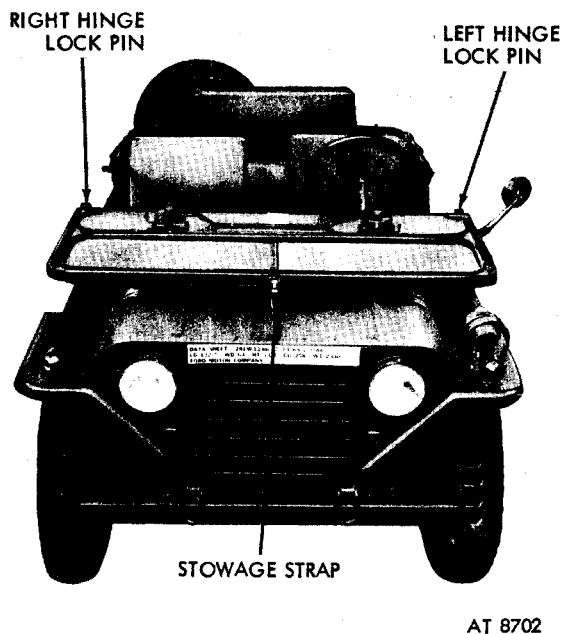

Figure 2-14. Erecting the windshield, stowage strap, hinge lock pins.

## 2-16. Raising and Lowering the Windshield

a. Vehicles are equipped with fold-down windshield assemblies. Windshields may be folded forward on the hood of the engine compartment and secured.

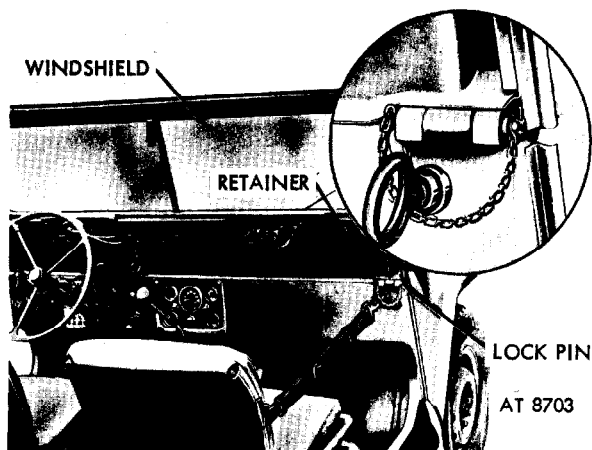

Figure 2-15. Erecting the windshield, hinge lock pins and retainers.

b. To erect the windshield, unbuckle the stowage strap, and remove right and left hinge lock pins (fig 2-14).

c. After the windshield is unbuckled, raise it and install the two hinge lock pins and retainers as illustrated by figure 2-15.

d. To lower the windshield reverse the procedure in b and c above.

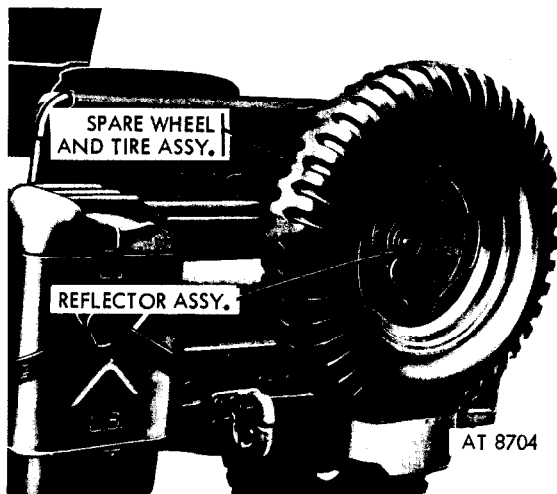

Figure 2-16. Remove obstructions from rear.

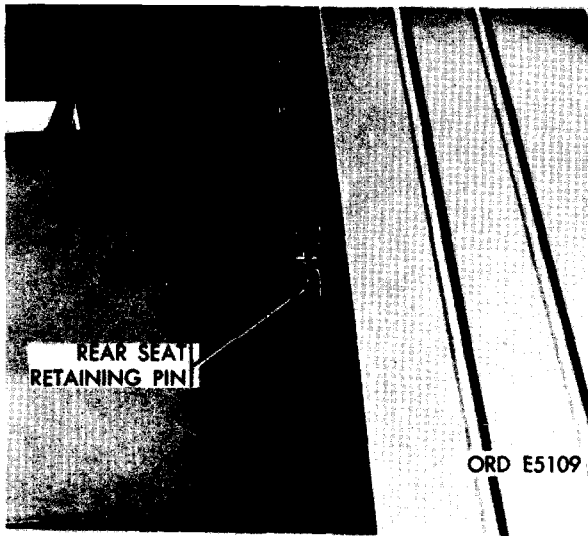

Figure 2-17. Seat retaining pin.

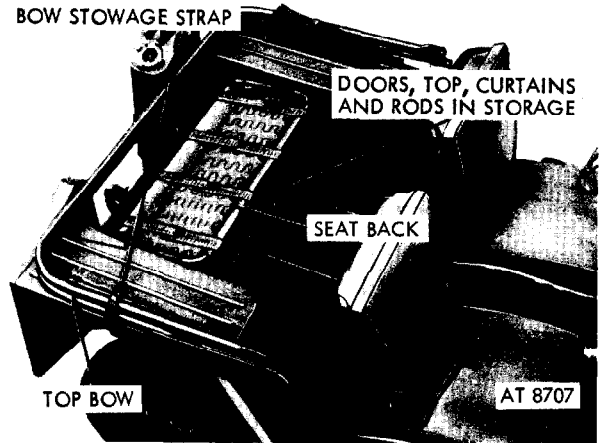

Figure 2-19. Bow stowage straps.

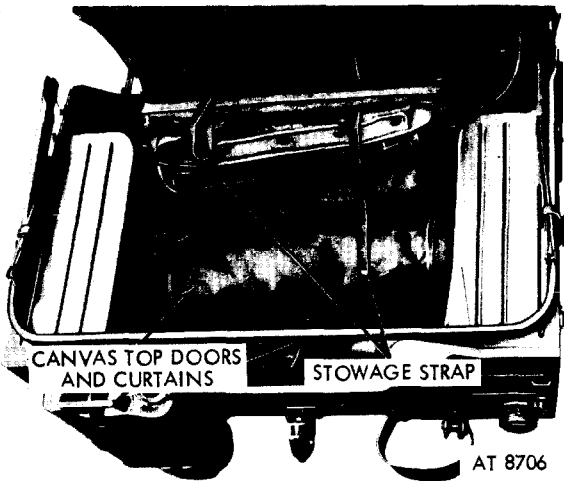

Figure 2-18. Stowage disassembly.

## 2-17. Installing, Removing and Storing Canvas Top

a. M151, M151A1 and M718 vehicles are equipped with canvas tops and rear curtains. Canvas doors and side curtains are contained in special purpose kits. In M151 and M151A1 vehicles these are stored under the rear seat assembly when not in use. M151 and M151A1 vehicles can be operated with all enclosure parts removed, as illustrated by figure 1-1, with all parts installed as illustrated by figure 4-16, or with only some parts installed. Assem-

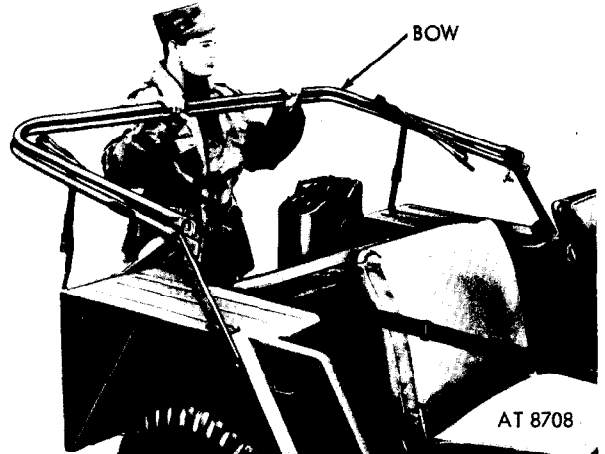

Figure 2-20. Raising the bows.

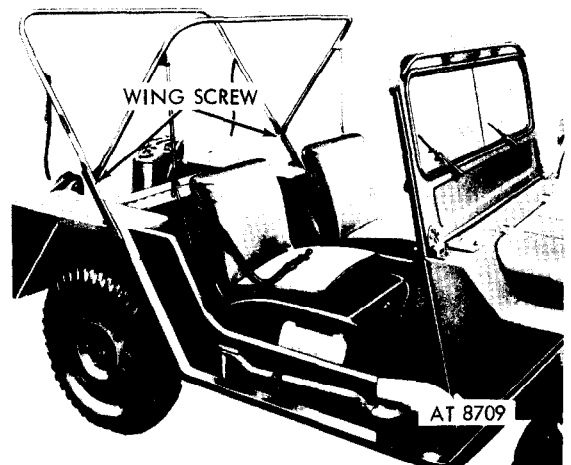

Figure 2-21. Bows erected.

bly and installation of all enclosure units can be done without tools. For instructions on the installation of M151 and M151A1 door and side curtain kits refer to paragraph 4-17. Coverage for the M718 vehicle is provided in paragraphs 2-32 through 2-38. Tops and side curtains are impractical for M151A1C vehicles when 106mm rifles are installed.

b. Remove the spare wheel and tire assembly and reflector assembly, plus any other obstructions from the rear of the vehicle as illustrated in figure 2-16.

c. Remove the two rear seat retaining pins as illustrated in figure 2-17.

d. Fold the back of the rear seat assembly forward. Remove two retaining pins and lift the whole seat assembly out of its support brackets and lay it on the floor. Unbuckle the stowage straps and remove the stowed canvas. The package is illustrated in figure 2-28 for older model vehicles. The canvas top is the largest single item in the package. Lay it aside temporarily.

e. Stow remaining curtains and rods in the original position, if only the top is to be installed, and install the seat and retaining pins. Unbuckle the two stowage straps holding the top bows and tip the back of the back seat to forward position. See figure 2-19.

f. Stand at rear center of the vehicle and grasp bows: raise and pull backward to lock in position (fig 2-20).

g. Raise bows upward and forward over the vehicle, aline holes in bows, and install two wing screws (fig 2-21).

h. Unfold the canvas top. Lay it over the right front fender and hood with button fasteners up (fig 2-22). Start the beaded edge of the canvas top through the slot at top of the windshield.

i. Stand in the passenger compartment and proceed sliding the canvas top through the slot at top of the windshield (fig 2-23).

*Note.* Hold canvas up so it does not catch on bracket.

j. Center the canvas over the windshield (fig 2-24).

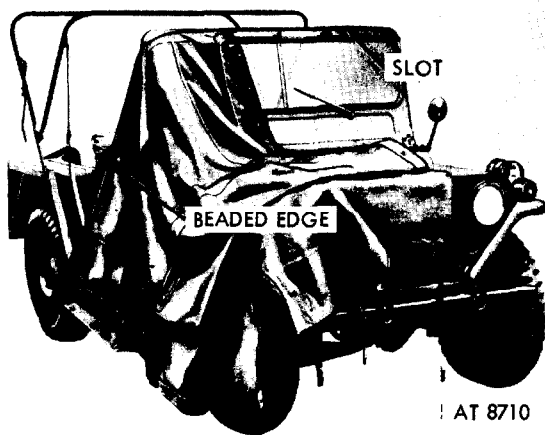

Figure 2-22. Canvas top unfolded.

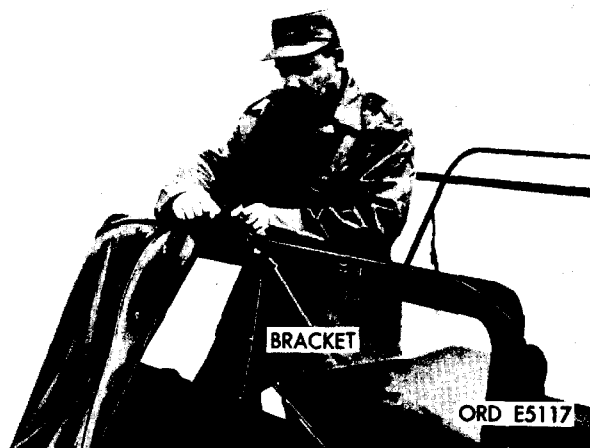

Figure 2-23. Canvas top sliding through slot.

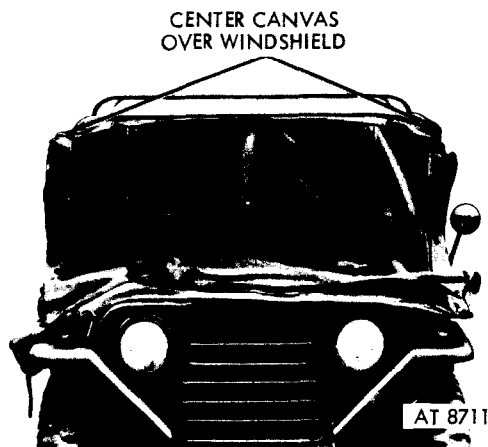

Figure 2-24. Canvas centered over windshield.



Figure 2-25. Assembling canvas over bows.

k. Pull the canvas back over the bows, push the bow assembly slightly forward and pull canvas down over it (fig 2-25).

l. Attach the ends of bow brace rods to windshield brackets and install retainers (fig 2-26). Wrap canvas flap around bow brace rod and secure five button fasteners on each side of vehicle. Wrap three canvas tabs around bow under the center of top and secure button fasteners.

m. Secure the canvas with four holddown straps across the back of vehicle (fig 2-27). Replace spare tire and reflector assembly on the rear of vehicle.

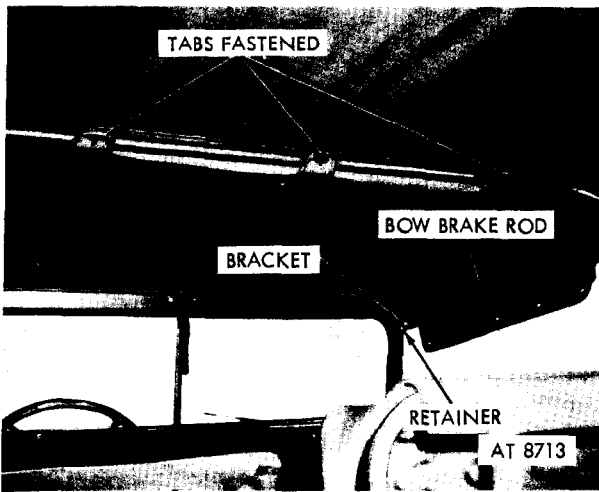

Figure 2-26. Retaining bow brace rod and top tabs fastened.

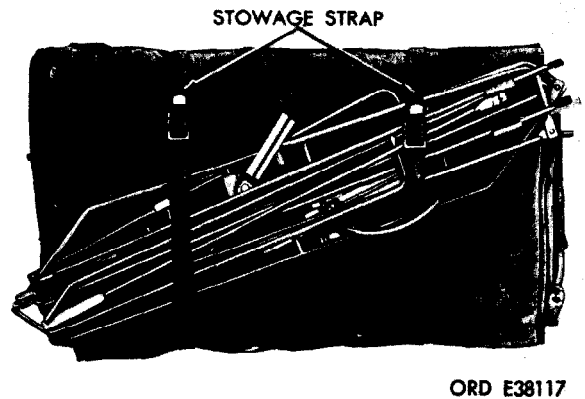

Figure 2-28. Stowing the top.

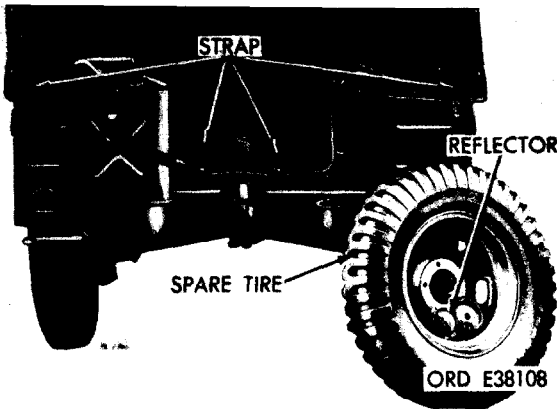

Figure 2-27. Back straps secured.

n. Canvas enclosures, tops and all supporting rods for M151 and M151A1 vehicles are stowed under the rear seat as illustrated by figure 2-18 and described above. To stow the top, disassemble it by using the steps above in reverse order. Lay the rear seat on a flat surface, bottom side up. Fold canvas parts to the size of the seat bottom. When enclosure windows are stowed, keep them inside and avoid sharp folds. Lay folded parts on seat bottom. Fold all joints in supporting rods and stow on top of the canvas parts, corner to corner. Secure the assembly with stowage straps, (fig 2-28) stow under rear seat position and replace rear seat.

## Section IV. OPERATION UNDER UNUSUAL CONDITIONS

### 2-18. General Conditions

a. In addition to the operating procedures described for usual conditions, special instructions of a technical nature for operating and servicing this vehicle under unusual conditions are contained or referred to in this section. In addition to the normal preventive-maintenance service, special care in cleaning and lubrication must be observed where extremes of temperature, humidity, and terrain conditions are present or are anticipated. Proper cleaning, lubrication, and storage and handling of fuels and lubricants not only insure proper operation and functioning, but also guard against excessive wear of the working parts and deterioration of the vehicle.

b. TM 21-300 contains very important instructions on driver selection, training, and supervision; TM 21-305 prescribes special driving instructions for operating wheeled vehicles under unusual conditions.

**Caution:** It is imperative that approved practices and precautions be followed. A detailed study of TM 21-300 and TM 21-305 is essential for use of this vehicle under unusual conditions.

c. Refer to Lubrication Order 9-2320-218-12 for lubrication under unusual conditions; refer to paragraph 3-16, for preventive-maintenance checks and maintenance procedures to be performed by the operator.

d. When chronic failure of vehicle results from subjection to extreme conditions, report the condition on DA Form 2407 (par 1-3).

### 2-19. Extreme Cold-Weather Conditions

#### a. General Problems.

- (1) Extensive preparation of materiel scheduled for operation in extreme cold weather is necessary. Generally, extreme cold will cause lubricants to thicken or congeal, freeze batteries or prevent them from furnishing sufficient current for cold-weather starting, crack insulation and cause electrical short circuits, prevent fuel

from vaporizing and properly combining with air to form a combustible mixture for starting, and will cause the various construction materials to become hard, brittle, and easily damaged or broken.

- (2) The cooling system should be prepared and protected for temperatures below 32° F, in accordance with instructions given in TM 9-207 and TB ORD 651, on draining and cleaning the system and the selection, application, and checking of antifreeze solution to suit the anticipated conditions.
- (3) TM 9-207 also describes the method of correcting the specific gravity of batteries exposed to extreme cold.
- (4) For description of operations in extreme cold, refer to FM 31-70 and FM 31-71 as well as to TM 9-207.

**Caution:** It is imperative that the approved practices and precautions be followed. TM 9-207 contains general information which is specifically applicable to this vehicle as well as to all other ordnance materiel. This information must be considered an essential part of this technical manual, not merely as an explanatory supplement to it.

b. *Winterization Equipment.* Special equipment is provided for the vehicle when protection against extreme cold weather (0° F to -65° F) is required. This equipment is issued as specific kits. Description, data and operation of the equipment are contained in chapter 4. TM 9-207 contains general information on winterization equipment and processing.

### 2-20. Extreme Cold-Weather Operation

#### a. General.

- (1) The driver must be very cautious when starting or driving the vehicle after a shutdown for extended periods of time. Congealed lubricants may cause failure of parts. Tires may be frozen to the ground or frozen in the



shape of a flat spot while underinflated. One or more brake shoes may be frozen fast. Each condition must be taken into account by the operator in order to prevent damage to the vehicle. After warming up the engine, drive the vehicle slowly as a test run, being careful not to stall the engine. Depending upon the temperature of the inactive vehicle and the length of time it has been subjected to extreme temperatures, cautious trial runs should be timed to heat the gears, tires and other components to the point where normal operations can be expected.

- (2) The driver must frequently note instrument readings for indication of any malfunction. If any instrument reading continues to deviate from normal, he must stop the vehicle and investigate the cause.
- (3) The driver should refer to TM 21-305 for special instructions on driving hazards in snow, ice, and unusual terrain encountered under extreme cold conditions.

b. *At Halt or Parking.*

- (1) When halted for short shutdown periods, park the vehicle in a sheltered spot out of the wind. If no shelter is available, park so that the vehicle does not face into the wind. For long shutdown periods, if high, dry ground is not available, prepare a footing of planks or brush. Chock in place if necessary.
- (2) When preparing the vehicle for shutdown period, place control levers in the neutral position to prevent them from possible freezing in an engaged position. Freezing may occur when water is present due to condensation.
- (3) Clean all parts of the vehicle of snow, ice, and mud as soon as possible after operation. Refer to table 1 (par 3-21) for detailed after-operation procedures. If the winterization brush guard cover and hood cover are not

installed, be sure to protect all parts of the engine and engine accessories against entrance of loose, drifting snow during the halt. Snow penetrating the engine compartment may melt and then freeze or form ice and cause damage to moving parts when engine starts. Cover and shield the vehicle but keep the ends of the canvas paulins off the ground to prevent them from freezing to the ground.

- (4) If no power plant heater is present, the batteries should be removed and stored in a warm place. However, it is unnecessary to drain engine oil (OES) as it will remain fluid even though unheated.
- (5) Refuel immediately in order to reduce condensation in the fuel tank. Prior to refueling, remove fuel tank drain plug and drain off any accumulated water.
- (6) Correct tire inflation pressures are prescribed on vehicle data plates and illustrated in figures 1-10 through 1-13.
- (7) When drain plugs have been removed or drain cocks opened to remove liquid from the cooling system of any equipment, the drains must be inspected to be sure none are obstructed. If the drain hole has become obstructed by foreign material, a soft wire should be used to clear the hole of the obstruction. This is particularly important before leaving a vehicle if the engine block is being drained to protect the block from freezing. The draining of an engine cooling system to prevent freezing will be done only when no approved antifreeze solution is available.

## 2-21. Extreme Hot-Weather Operation

a. *General.* Continuous operation of the vehicle at high speeds of under long hard pulls in lower gear ratios on steep grades or in soft terrain may cause the engine to overheat. Avoid the continuous use of low-gear

ratios whenever possible. Continuously be alert for overheating, and halt the vehicle for a cooling off period whenever necessary and the tactical situation permits. Make frequent inspections and servicing of the cooling system engine oil filter, and carburetor air cleaner. If the vehicle engine is consistently overheating, look for dust, sand, or insects in radiator fins and blow out any accumulation with compressed air or water under pressure. Flush cooling system, if necessary.

b. *At Halt or Parking.*

- (1) Do not park the vehicle in the sun for long periods, as the heat and sunlight will shorten the life of all rubber, fabric, plastics and paint used in or on the vehicle. When practical, park under cover to protect vehicle from sun, sand, and dust.
- (2) Cover inactive vehicle with tarpaulins if no other suitable shelter is available. Where entire vehicle cannot be covered, protect window glass against etching by sand, and protect engine compartment against entry of sand.
- (3) Correct tire inflation pressures are prescribed on vehicle data plates and illustrated in figures 1-10 through 1-13.
- (4) Materiel inactive for long periods in hot, humid weather is subjected to rapid rusting and accumulation of fungus growth. Make frequent inspections and clean and lubricate to prevent excessive deterioration.

## 2-22. Operation on Unusual Terrain

a. *General.*

- (1) Operation on snow- or ice-covered terrain or in deep mud requires use of tire chains on the driving wheels.

**Caution:** Attempted operation, with only one wheel of a driving axle equipped with a tire chain, may result in serious damage to the tire and/or power train.

- (2) Select a gear ratio low enough to maintain engine speed above recommended minimum speed without causing the wheels to spin. When addi-

tional traction is needed, such as on ice, snow, mud, or difficult terrain, front axle drive should be engaged by moving transfer lever forward. As soon as normal driving conditions are re-encountered, shift transfer lever into "OUT" to disengage front axle drive. Care must be taken when vehicle is stalled or mired to see that a spinning wheel or wheels do not become buried to the extent that the suspension arm rests on the surface of the mud, sand, or snow.

- (3) If one or more wheels become mired or begin to spin, it may be necessary for the vehicle to be winched or towed by a companion vehicle, or it may be necessary to jack up the mired wheel and insert planking or matting beneath it. Do not jam sticks or stones under a spinning wheel, as this only forms an effective block and will wear the tire tread unnecessarily.
- (4) Skidding and the loss of steering and torque traction are the chief difficulties encountered on icy roads. When rear end skidding occurs, instantly turn front wheel in the same direction that the rear end is skidding. Decelerate the engine but do not declutch. Apply brakes very gradually.
- (5) The operator must know at all times the exact direction in which the front wheels are steering. The vehicle may, on ice-covered or slippery terrain, continue in a straight-ahead direction even though the front wheels are turned to the right or left.
- (6) Lowering tire pressure, to travel over sand, ice, mud, and snow will help to increase traction if tire chains are not available.

*Note.* Do not lower tire pressure to the extent that damage will result. Restore to recommended tire pressure as soon as possible after emergency. Refer to vehicle data plates as illustrated by figures 1-10 through 1-13.

- (7) When traveling over crusted surfaces, avoid breaking through. A road bed

of canvas or planking is suitable on short stretches to ensure against this possibility.

- (8) Operation in sand or dust may require daily cleaning of carburetor air cleaner and engine oil filter and even more frequent cleaning may be found necessary in certain cases.
- (9) High altitude operation requires careful maintenance of the cooling system, as the boiling point of the coolant drops in proportion to the altitude reached. The pressurized cooling system of this vehicle will operate at a temperature of 220° F without loss of coolant if all connections and the filler cap are maintained in a sealed condition.

**Warning:** Extreme care must be exercised in removing radiator filler cap when temperature gage reads above 180° F.

b. *Recommended Tire Pressures.*

- (1) *Sand.* For emergency operations in beach and desert sand, reduce tire inflation as prescribed in figures 1-10 through 1-13.
- (2) *Rocks and boulders.* Tires must be correctly inflated as prescribed in figures 1-10 through 1-13. Overinflated tires will result in an increase in the shock transmitted to the vehicle as it moves over rough or rocky ground. Underinflated tires will cause internal ruptures of the tire and damage to the tube.
- (3) *Mud and snow.* Tire inflation pressures may be reduced to improve vehicle performance during operation in snow and mud. Restore to the recommended tire inflation as indicated by the vehicle data plates as soon as possible after these conditions cease.

c. *After-Operation Procedures.* Remove accumulations of ice, snow, and mud from under the fenders and from the wheels, axles, radiator core, engine compartment, steering knuckles and arms, air cleaner intake, and electrical connections.

**Caution:** Exercise care when removing such accumulations in order to prevent damage to the affected parts.

## 2-23. Fording Operation

a. *General.* In fording, the vehicle may be subjected to water varying in depth from only a few inches to depths sufficient to completely submerge it. Factors to be considered are spray-splashing precautions, normal fording capabilities, deepwater fording using fording kits, and accidental complete submersion.

b. *Normal Fording.* All critical components of the vehicle are provided at manufacture with waterproofing protection for fording bodies of water to a depth of 21 inches. For greater depths, a deepwater fording kit must be installed. Instructions for normal fording without use of deepwater fording kit, are described below.

c. *Determine the Feasibility of Fording.* After fording to the 21-inch depth has been learned to be feasible, place the transmission in low gear and engage front wheel drive.

d. *Observe the Following Precautions.*

- (1) Make sure engine is operating efficiently.
- (2) Enter water slowly, but prevent engine stall.
- (3) If engine stalls, start in usual manner.
- (4) Limit speed to 3-4 mph.
- (5) Avoid unnecessary use of clutch.
- (6) Do not rely on brakes until tested and found reliable.

e. *Operation After Normal Fording.* After leaving the water, disengage front wheel drive if terrain permits. Actuate brakes several times to aid in drying out brake linings and test them. On older model vehicles open the floor drain (fig 2-29) to release water from inside the vehicle if it has collected. On later model vehicles the floor drain openings are permanently open, as illustrated by figure 2-30. Refer to paragraph 3-31 for after fording operation.

f. *Accidental Submersion.* If complete submersion of the vehicle occurs accidentally, it must be salvaged, temporarily preserved as

described in paragraph 3-30, and then sent to an ordnance maintenance unit as soon as possi-

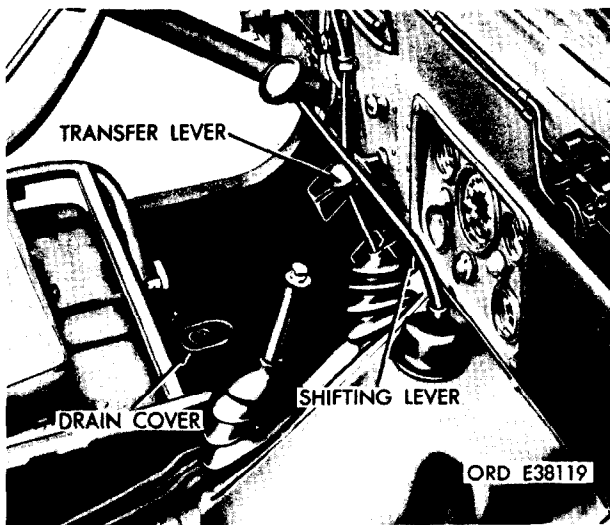

Figure 2-29. Floor drain cover, earlier model vehicles.



Figure 2-30. Floor drain openings, later model vehicles.

ble for necessary permanent maintenance.

g. *Deepwater Fording.* Refer to paragraph 4-29 for deepwater fording kit operation.

## Section V. 106MM RECOILLESS RIFLE

### 2-24. Description

Condensed data covering the 106mm recoilless rifle, M151A1C, 4 x 4, 1/4 ton, utility truck is provided in paragraph 1-16. A description is given in paragraph 1-6e. The 106mm recoilless rifle, consisting of the cal. .50 spotting rifle M8C, the 106mm recoilless rifle M40A1, and 106mm rifle mount M79 is designed as a self-propelled mobile weapon system when mounted on the bodies of 1/4 ton, 4 x 4, utility trucks. When mounted on the M151A1, the vehicle becomes an M151A1C vehicle. The vehicle is provided with overload, heavy duty springs to accommodate the heavier load when M151A1 vehicles are modified to M151A1C vehicles.

### 2-25. Data

More detailed data concerning the 106mm recoilless rifle will be found in TM 9-1000-205-12, Operation and Organizational Maintenance; cal. .50 spotting rifle, M8C, 106mm rifles M40A1 and M40A1C; rifle mounts T173 and M79; and tripod T26. Total weight of the items specified in paragraph 2-24 is approximately 480 lbs. Firing limits of the 106mm rifle are illustrated in figure 2-31.

### 2-26. Controls and Instruments

Controls and instruments of M151A1C vehicles are included in paragraphs 2-3 through 2-5. Firing controls of the 106mm recoilless rifle are included in TM 9-1000-205-12.

### 2-27. Name and Identification Markings and Plates

Name and identification markings of the 106mm recoilless rifle are located on the rear face of the rifle chamber, including the name, model designation, serial number and weight of the item as illustrated by figure 2-32. The name, model designation and serial number of the cal. .50 spotting rifle appear on the top of the receiver as illustrated by figure 2-32. The name, model designation, serial number and weight of the M79, 106mm rifle mount appear on the left side of the traversing assembly as illustrated by figure 2-32.

### 2-28. Operating Instructions

Operating instructions for the 106mm recoilless rifle appear in TM 9-1000-205-12. Major components are illustrated by figure 2-32. To lock the gun into position for traveling pur-

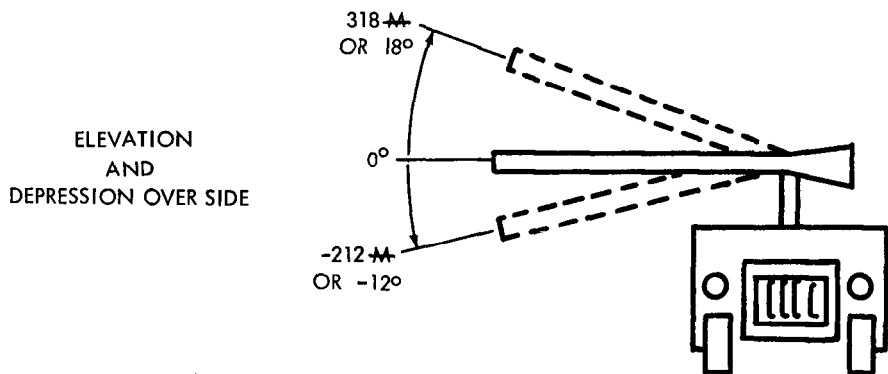
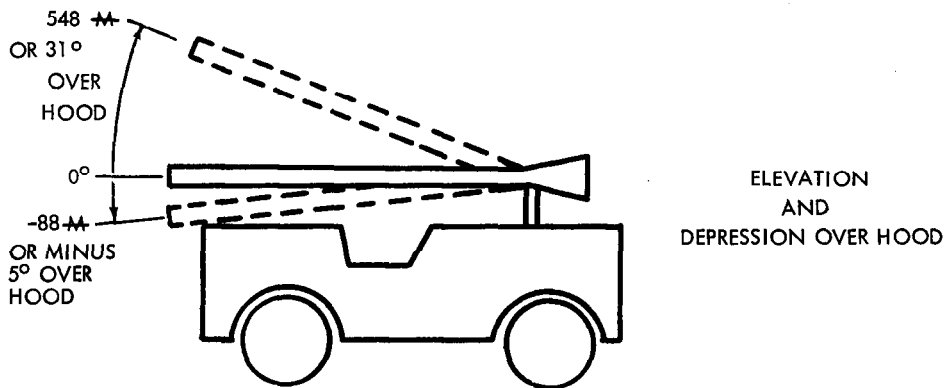
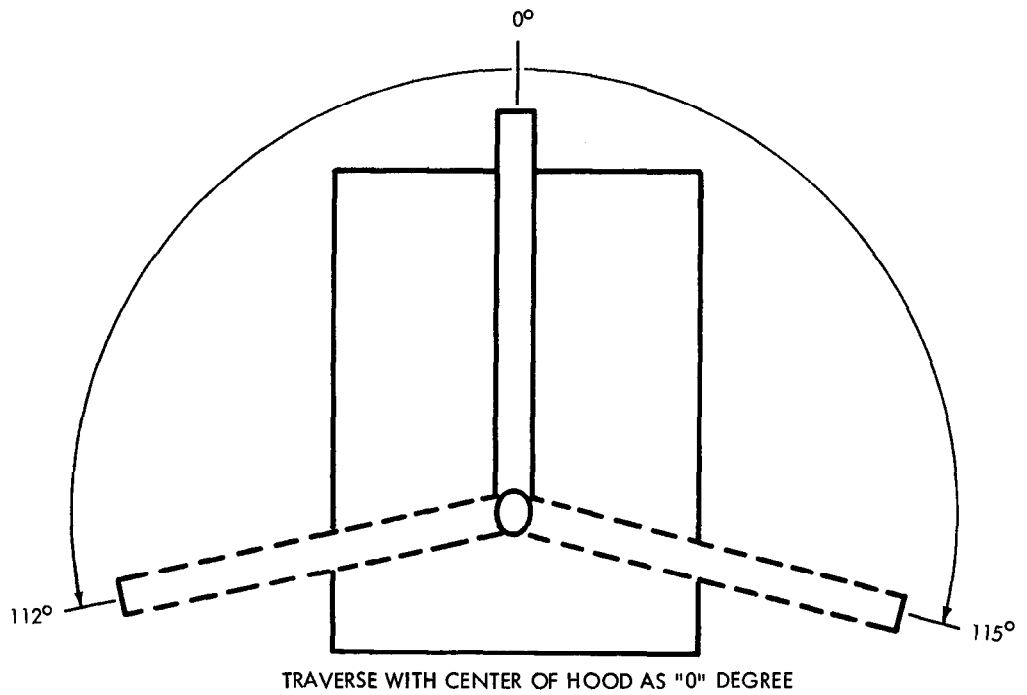

AT 8716

Figure 2-31. Firing limits of the 106mm recoilless rifle.

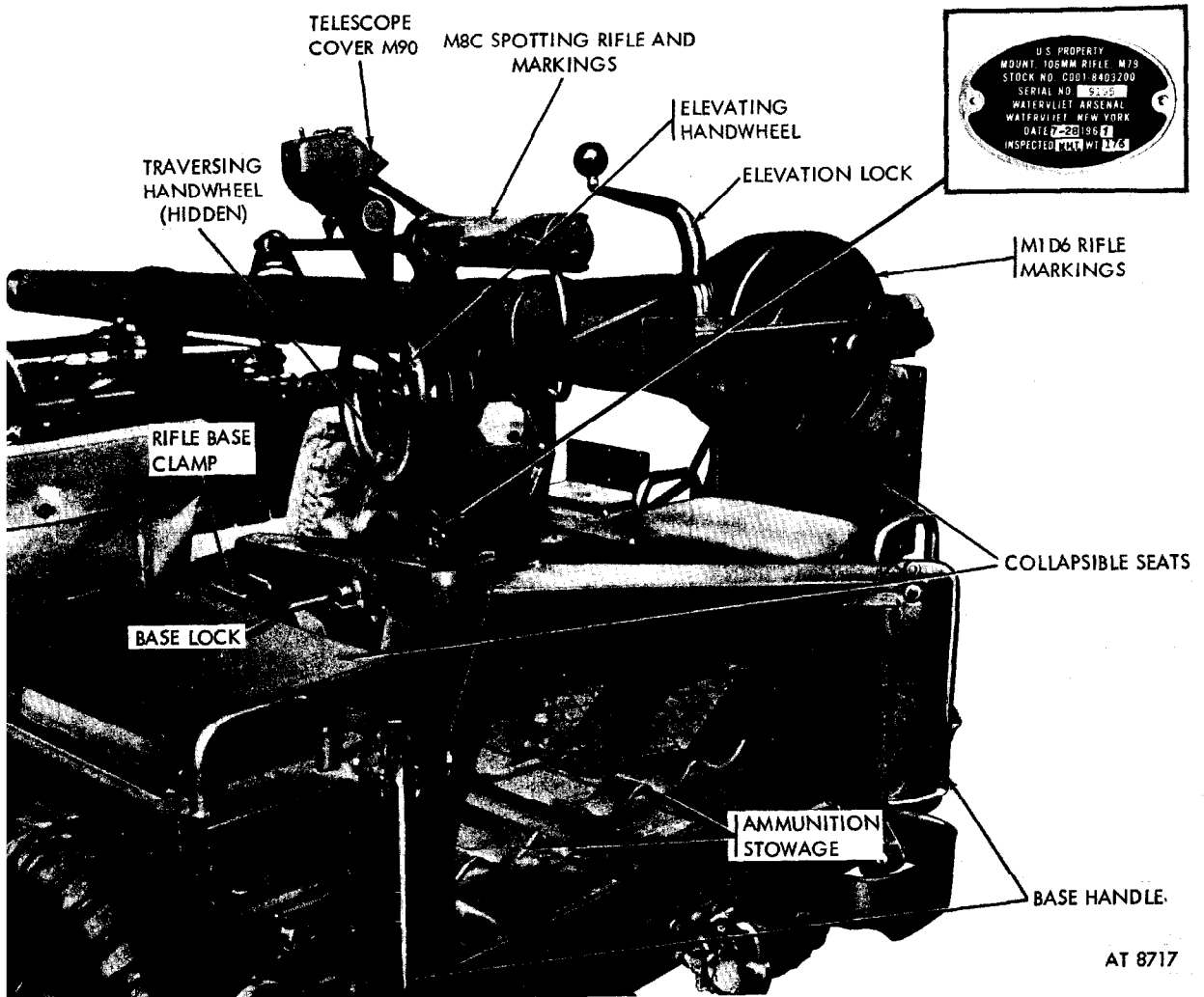

Figure 2-32. 106mm recoilless rifle installation.

poses, the gun barrel should be swivelled into position above the saddle of the rifle clamp, figure 2-33, with the traversing handwheel. The windshield should be lowered as covered by paragraph 2-16 and the gun barrel lowered into the clamp saddle with the elevating handwheel. The pedestal lock is used to lock the rifle clamp into position and should be checked. The rifle assembly may be raised and locked into position so that the windshield is erected and the gun is locked by the rifle clamp. Place the rifle clamp over the gun barrel and lock the rifle into place with the rifle clamp handle as shown by figure 2-34. Check elevation lock,

base locks, base handles, ammunition storage and miscellaneous material before traveling.

**2-29. Preventive Maintenance**

Detailed preventive-maintenance instructions for the 106mm recoilless rifle, M79 rifle mount and M8C cal. .50 spotting rifle will be found in TM 9-1000-205-12.

**2-30. Lubrication**

Lubrication instructions for the 106mm recoilless rifle, are found in TM 9-1000-205-12. General lubrication instructions of the M151-A1C vehicle will be found in paragraph 3-5 of this manual.

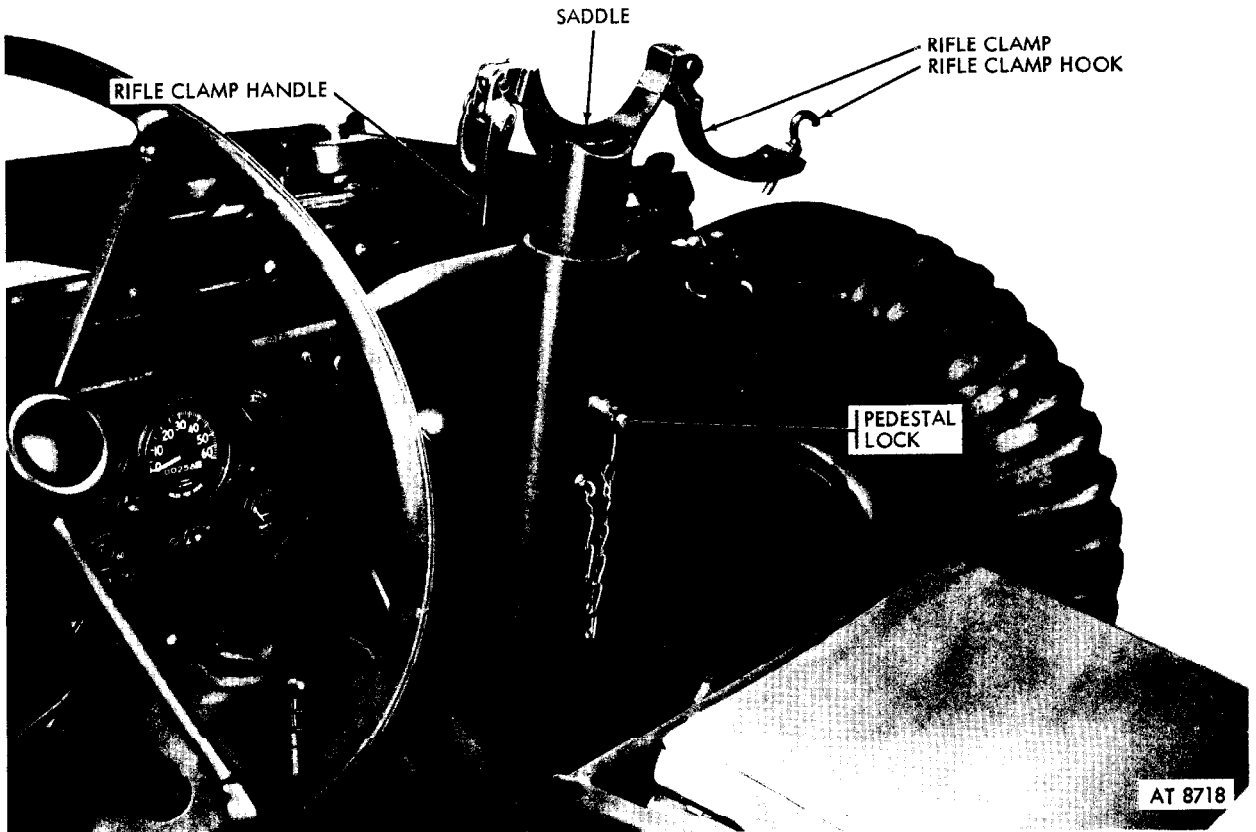
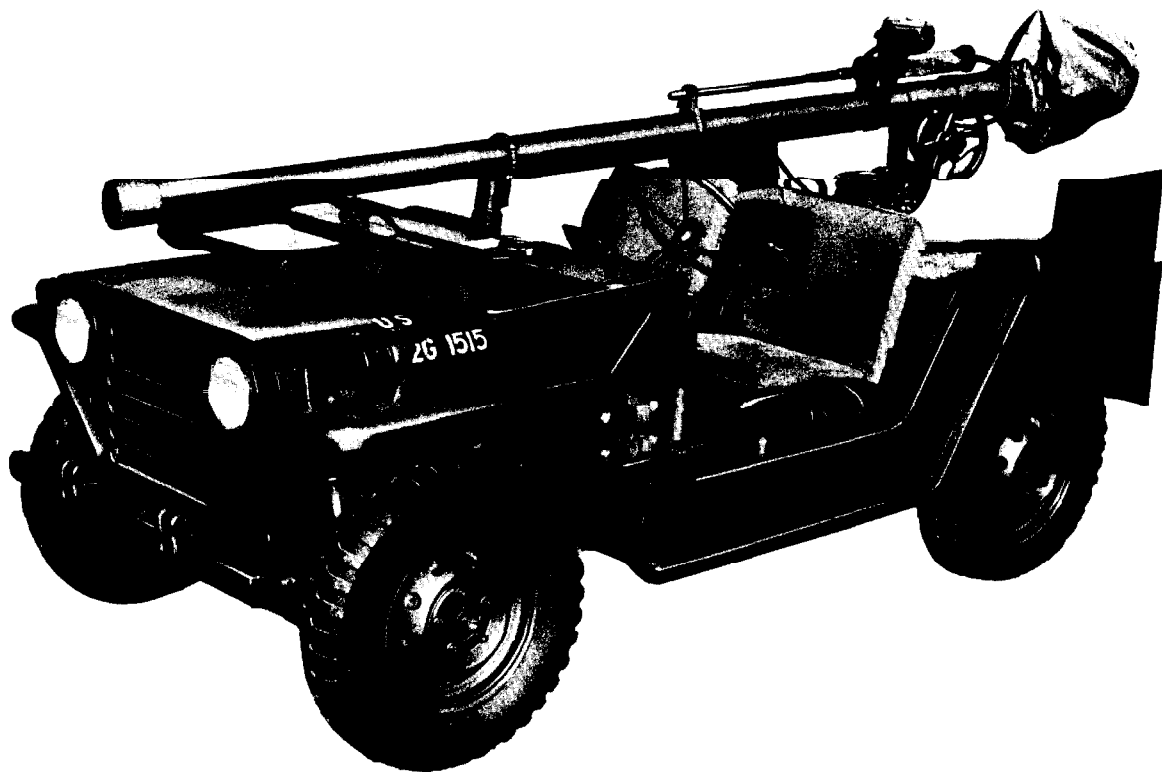

Figure 2-33. Locking the 106mm recoilless rifle into place, rifle clamp.

## 2-31. Troubleshooting

Troubleshooting instructions of the 106mm recoilless rifle, will be found in TM 9-1000-205-12. General troubleshooting instructions for the M151A1C vehicle is included in para-

graph 3-24 of this manual. Any defects or unsatisfactory operating characteristics beyond the scope of operating personnel should be reported to the appropriate authority.



AT 8719

*Figure 2-34. Locking the 106mm recoilless rifle into place, locked position.*

## Section VI. TRUCK, AMBULANCE, FRONTLINE ¼ TON, 4x4, M718

### 2-32. Description and Data

Condensed data covering the M718, 4 x 4, ¼ ton, frontline ambulance truck is given in paragraph 1-16. A description of the vehicle is given in paragraph 1-6-d.

### 2-33. Controls and Instruments

Information on controls and instruments covering the M718, 4 x 4, ¼ ton, frontline ambulance truck is given in paragraphs 2-3 through 2-5.

### 2-34. Name, Caution and Instruction Plates

Name, caution and instruction plates appearing on the M718, 4 x 4, ¼ ton, frontline ambulance are illustrated in figures 1-9 and 1-13.

### 2-35. Operating Instructions

a. Operating instructions for the M718 vehicle are provided in paragraphs 2-6 through 2-23. Special attention should be paid to the driving precautions outlined in paragraphs 2-10h to 2-10p.

b. The M718 vehicle (fig 2-35) can accommodate a driver, two litter patients and two ambulatory patients, or a driver and three litter patients in emergencies, or a driver, co-driver and three ambulatory patients.

c. To erect the three litter supports, remove the release pin from the rear of the right front seat (fig 2-36) and lift the seat forward. Remove the six litter rails (fig 2-36), and the litter rail supports from stowage on the floor.



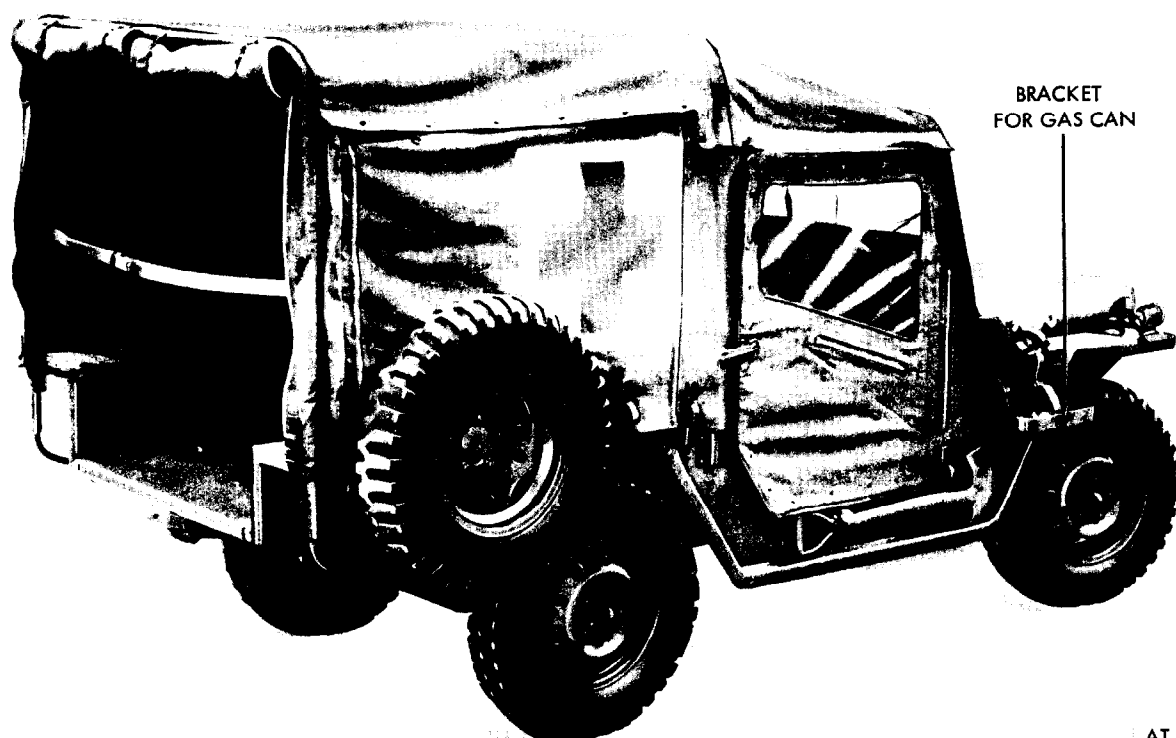

AT 8720

Figure 2-35. M718 doors, sides, and top installed, back curtain raised.

See figure 2-37 for itemized illustration of litter hardware.

d. Move the inverted "U" shaped front rail support (fig 2-36) from its stowage position into the mounting socket closest to the rear of the right front seat. The other arm of the support should remain in the stowage support socket between the front seats. Lock the release pins.

e. Insert the left and right litter rail supports by inserting the right litter rail support in the floor socket near the spare tire (fig 2-36). Insert the left litter rail support in the floor socket behind the driver's seat (fig 2-38), and lock it in place. Insert the remaining rear litter rail support, with the bent shoulder, in the socket at the left rear of the vehicle (fig 2-39). Lock all supports.

f. All six litter rails are of the same size and shape. For convenience, install the two litter rails on the floor of the vehicle and lock

them in place with the retaining pins, and with the wire litter holders in a forward position.

g. To assemble the right litter holder, install the two litter rails to right litter rail support (fig 2-38) and lock them in place with the four retaining pins. Assemble the left litter rails in the same fashion as described using the left litter rail support and the rear litter rail support on which to mount them (fig 2-39). Lock the two litter rails in place with the four retaining pins provided. Leave curtains unzipped or close them appropriate to the intended purpose. The M718 vehicle, with a two litter installation is shown in figure 2-40 and with doors and sides closed is illustrated in figure 2-35.

### 2-36. Preventive Maintenance

Preventive maintenance of the M718, 4 x 4, 1/4 ton, frontline ambulance truck is given in paragraphs 3-16 through 3-22.

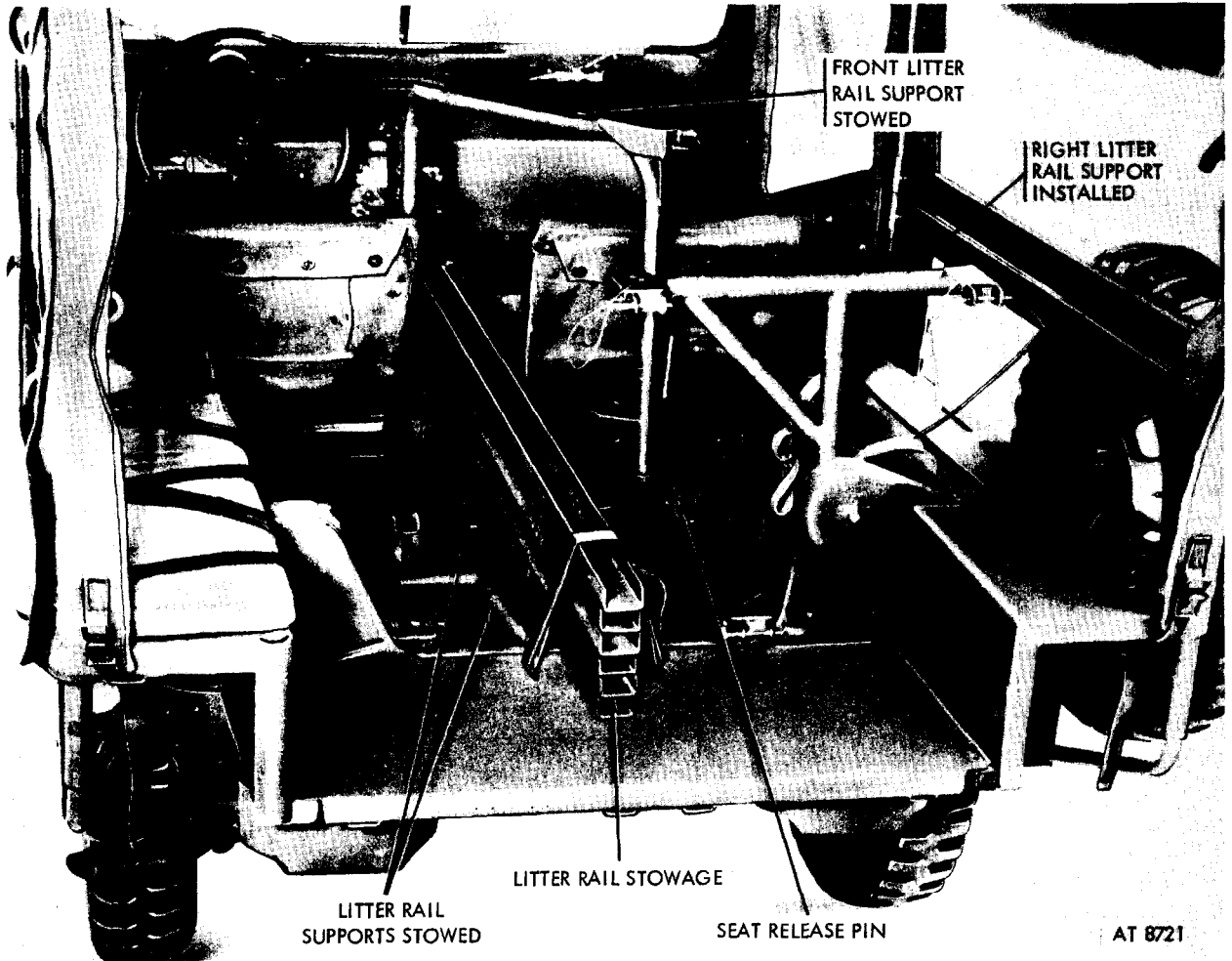

*Figure 2-36. M718 right litter rail support installed, front, left and rear litter rail supports and litter rails in stowed position.*

### **2-37. Lubrication**

Lubrication of the M718, 4 x 4, 1/4 ton, frontline ambulance truck is given in paragraphs 3-5 through 3-15.

### **2-38. Troubleshooting**

Troubleshooting of the M718, 4 x 4, 1/4 ton, frontline ambulance truck is given in paragraph 3-23.

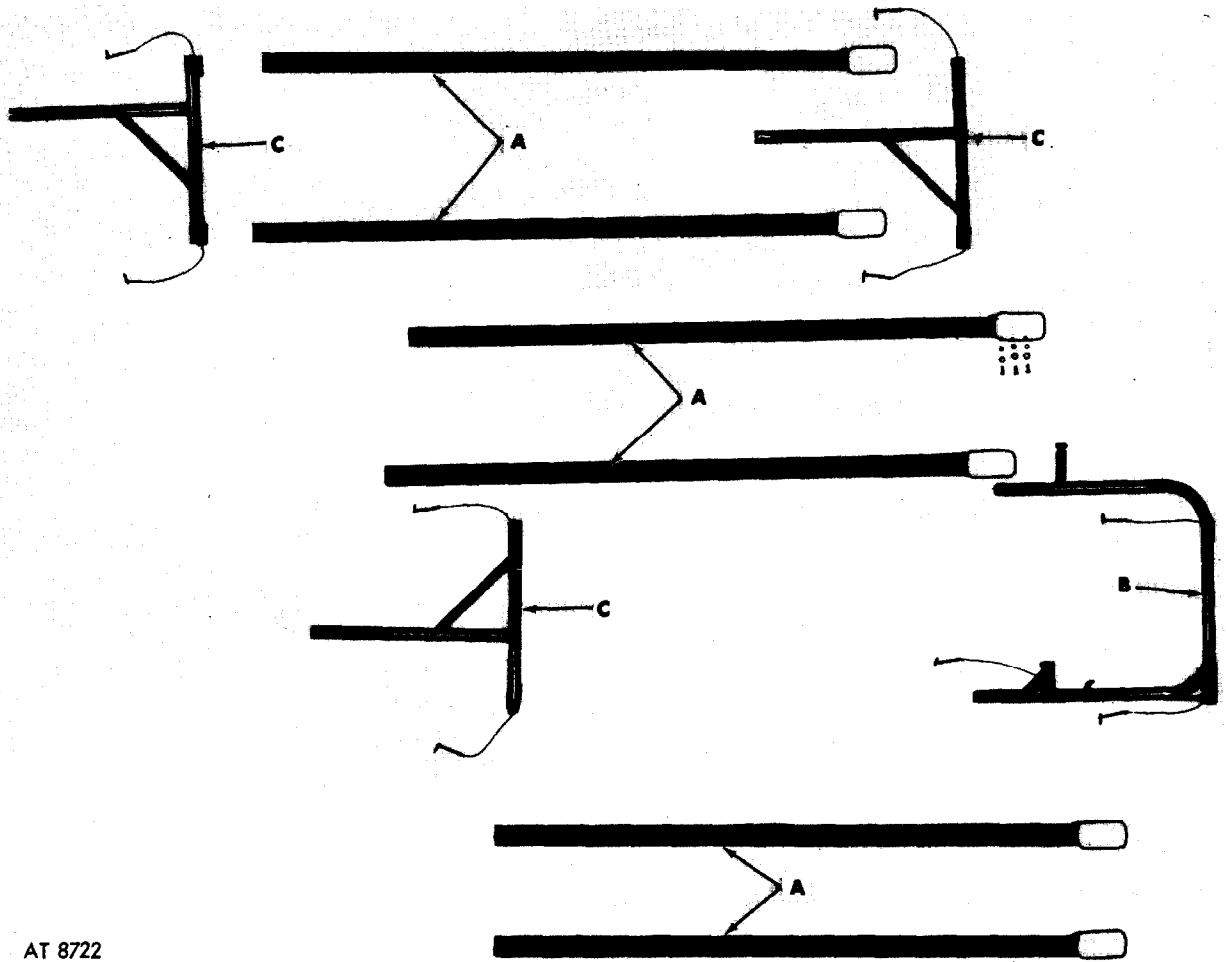

AT 8722

A—Litter rails  
B—Front litter rail support

C—Left, right and rear litter rail supports

Figure 2-37. M718 litter rails, supports and miscellaneous hardware.

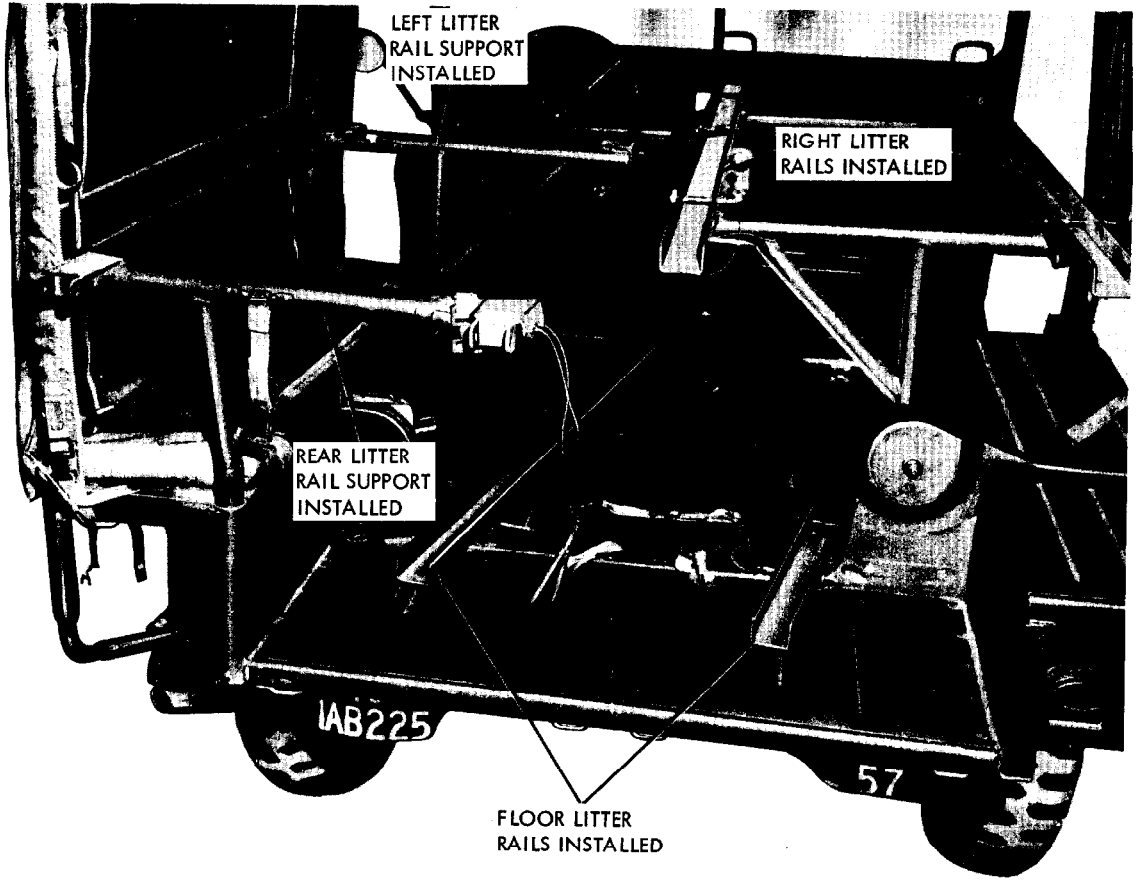

AT 8723

*Figure 2-38. M718 left litter rail support, rear litter rail support and lower litter rails installed (three litter installation).*

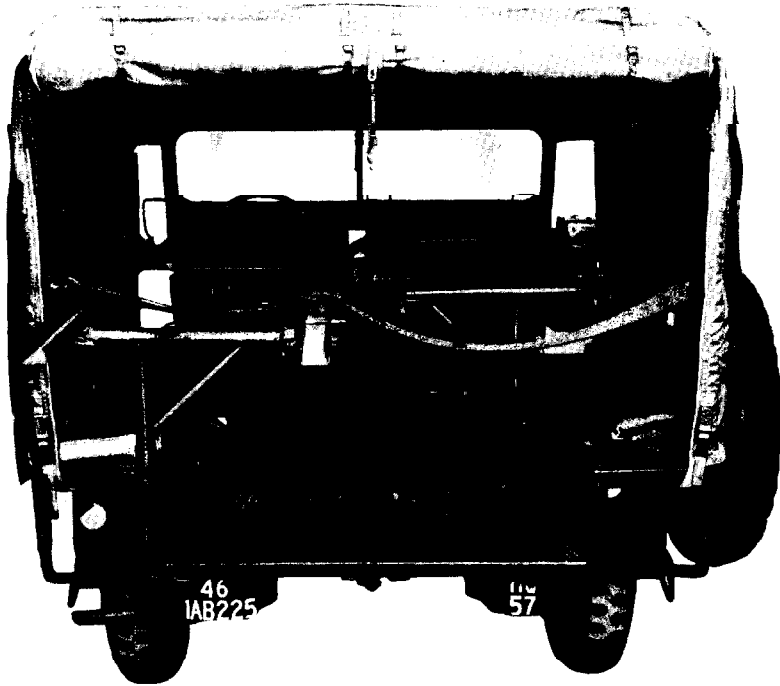

AT 8724

*Figure 2-39. M718 left litter rails, right litter rails and lower litter rails installed, back curtain raised.*

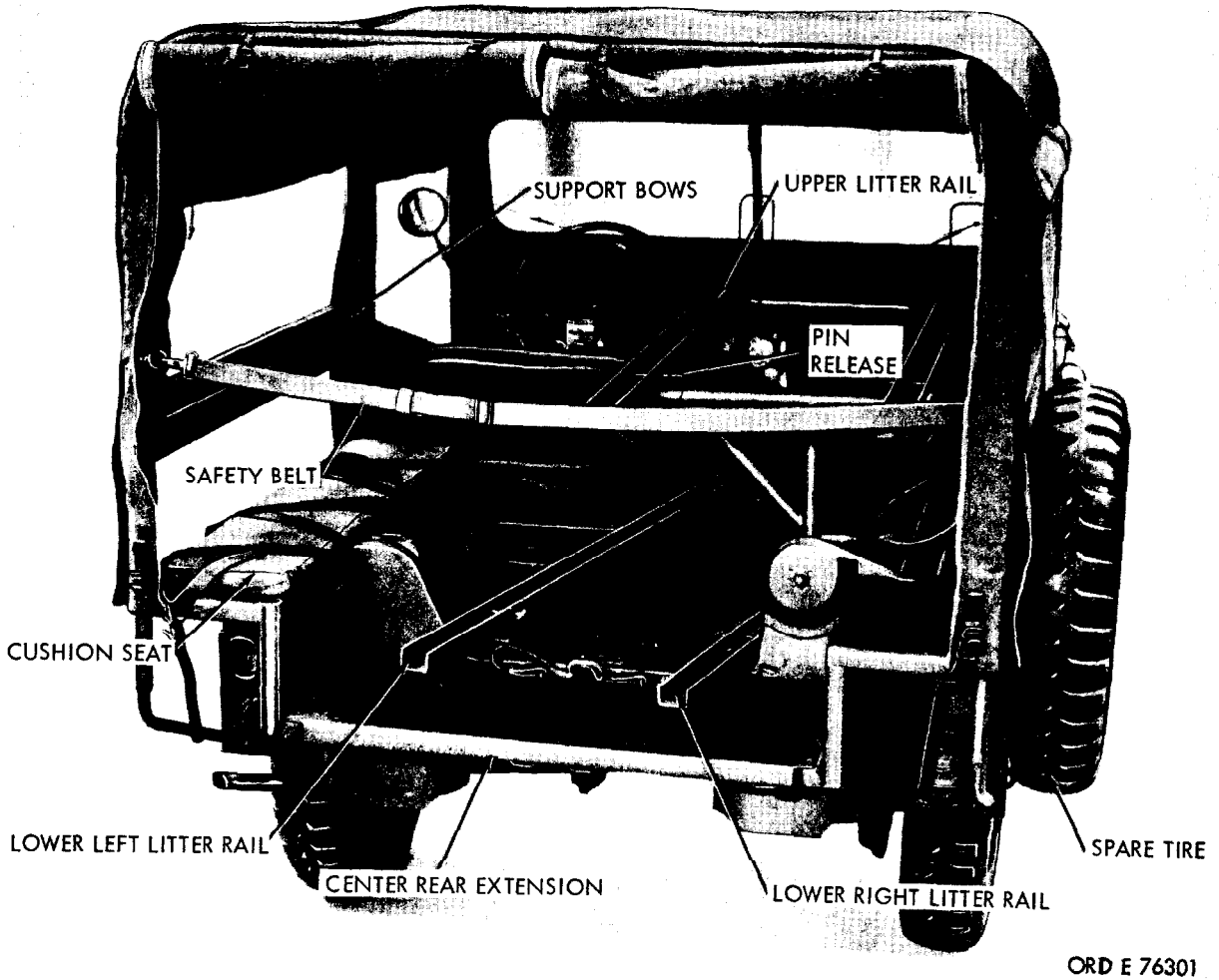

ORD E 76301

*Figure 2-40. M718 two-litter installation.*

## CHAPTER 3

### MAINTENANCE INSTRUCTIONS

---

#### Section I. PARTS, TOOLS, AND EQUIPMENT

##### 3-1. General

Tools, equipment, and repair parts are issued to the operator, crew, or user for operating and maintaining the materiel. Tools and equipment should not be used for purposes other than prescribed and should be properly stored, when not in use, as indicated in, Appendix B, Basic Issue Items List.

##### 3-2. Repair Parts

Repair parts are supplied with or issued for replacement of those parts that become worn, broken, or otherwise unserviceable, providing replacement of these parts is within the scope of operational maintenance functions. Repair parts supplied for M151, M151A1, M151A1C

and M718 vehicles are listed in Appendix B, Basic Issue Items List.

##### 3-3. Common Tools and Equipment

Standard and commonly used tools and equipment having general application to this materiel are authorized for issue by tables of allowances and tables of organization and equipment. Common tools and equipment supplied for M151, M151A1, M151A1C and M718 vehicles are listed in Appendix B, Basic Issue Items List.

##### 3-4. Special Tools and Equipment

No special tools or equipment are authorized for operational maintenance of M151 series vehicles.

#### Section II. LUBRICATION

##### 3-5. Lubrication Order LO 9-2320-218-12

Lubrication chart, figure 3-1, prescribes cleaning and lubricating procedures as to locations, intervals, and proper materials for this vehicle. The lubrication chart is derived from Lubrication Order 9-2320-218-12.

This order is issued with each vehicle and is to be carried with it at all times. In the event the vehicle is received without a copy, the using organization shall immediately requisition one. Lubrication which is to be performed by supporting maintenance personnel is listed on the lubrication order under the heading NOTES.

##### 3-6. General Lubrication Instructions Under Usual Conditions

*a. General.* Any special lubricating instructions required for specific mechanisms or parts are contained in the pertinent sections. Lub-

ricating instructions for special purpose kits are included in Chapter 4, Materiel Used in Conjunction with Major Item.

*b. Service Intervals.* Service intervals specified on the lubricating order are for normal operation and where moderate temperature, humidity and atmospheric conditions prevail.

##### 3-7. Points of Application

Lubricating fittings, grease cups, oilers, and oil holes are shown in figures 3-2 through 3-5 and are referenced to the lubrication order. Wipe these devices and surrounding surfaces clean before and after lubricant is applied.

##### 3-8. Reports and Records

Report unsatisfactory performance of prescribed petroleum fuels, lubricants, or preserving materials, using DA Form 2407, Maintenance Request.

# LUBRICATION CHART

TRUCK, UTILITY: 1/4 TON, 4 x 4, M151 (2320-542-4783)

TRUCK, UTILITY: 1/4 TON, 4 x 4, M151A1 (2320-763-1092)

TRUCK UTILITY: 1/4 TON, 4 x 4, M151A1C, 106MM RECOILLESS RIFLE (2320-763-1091)

TRUCK, AMBULANCE: FRONTLINE, 1/4 TON, 4 x 4, M718 (2310-782-6056)

Lubrication will be performed only as prescribed by this order except as required under unusual conditions as described in referenced TM.

Clean fittings before lubricating. Clean parts with THINNER, paint, volatile mineral spirits (TMP) or SOLVENT, dry cleaning (SD). Dry before lubricating. Lubricate dotted arrow points on both sides of the equipment.

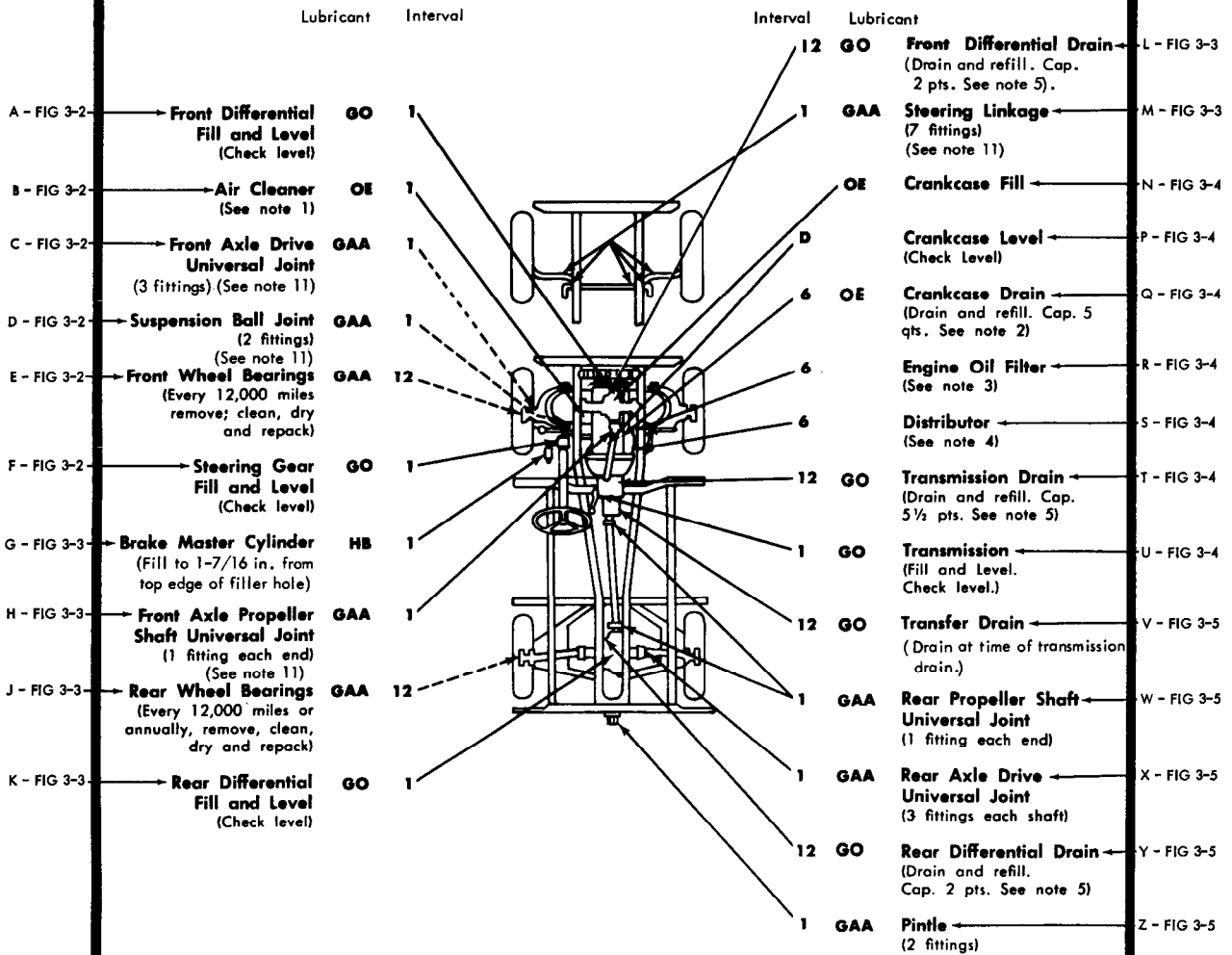

AT 8725

Figure 3-1. Lubrication chart (sheet 1 of 2).



— KEY —

LUBRICANTS	EXPECTED TEMPERATURE			FOR ARCTIC OPERATION Refer to TM 9-207	LUBRICANTS	INTERVALS See Note 6
	above +32°F	+40°F to -10°F	0°F to -65°F			
OE—OIL LUBR, ENGINE	OE 30	OE 10	OES		OES—OIL, LUBR, ENGINE, SUB-ZERO	D—Daily (Operator) 1—1,000 Miles 6—6,000 Miles or 6 months* 12—12,000 Miles or annually* *Whichever Occurs first
GO—LUBRICANT, GEAR, UNIVERSAL	GO 90	GO 80	GOS		GOS—LUBRICANT, GEAR, UNIVERSAL, SUB-ZERO	
GAA—GREASE, LUBR, AUTOMOTIVE AND ARTILLERY	GAA	GAA	GAA		HBA—FLUID, HYDRAULIC, BRAKE, ARCTIC	
HB—FLUID, HYDRAULIC, BRAKE	HB	HB	HBA		CW—LUBR, CHAIN, EXPOSED GEAR AND WIRE ROPE	

— NOTES —

1. AIR CLEANER

Every 1,000 miles, clean oil reservoir and refill with OE crankcase grade. Disassemble, clean all parts, refill with OE as above whenever crankcase oil is changed. For desert, or extremely dusty conditions, disassemble, clean all parts and refill with OE once every operating day or more frequently if required.

2. CRANKCASE

Drain every 6,000 miles or semi-annually. Drain only when engine is hot. Refill to FULL MARK on gage. Run engine a few minutes and check oil level. Under adverse conditions it may become necessary to drain the crankcase oil more frequently.

3. OIL FILTER

Every 6,000 miles or semi-annually, while draining crankcase, remove oil filter assembly and discard. Install new oil filter assembly.

4. DISTRIBUTOR

Every 6,000 miles or semi-annually, remove cover assembly and rotor. Saturate felt at rotor end of shaft with 2 to 3 drops of PL. Wipe breaker cam sparingly with GAA and lubricate breaker arm pivot with 1 or 2 drops of PL. Remove slotted plug under nameplate on distributor housing and withdraw wick. Soak wick in PL. Fill plug opening with GAA. Insert wick, remove excess grease and install plug.

5. GEARCASES

Drain every 12,000 miles or annually. Drain only when hot after operation. Fill to plug level before operation and after draining. Clean vents especially after an operation in water or mud.

6. LUBRICATION INTERVALS

When practicable, Lubrication Service will be made to coincide with the vehicle "S" P.M. Service. For this purpose a 10% tolerance (variation) in specified lubrication point mileage is permissible.

7. OIL CAN POINTS

Every 1,000 miles lubricate all doors and compartment hinges, latches, hood catches, throttle bellcrank, carburetor linkage, seat adjusting screw, spare tire wing nut, accelerator pedal pivot pin, seat retaining pins and rear seat pivot pins and vehicle lifting eyes with PL.

8. DO NOT LUBRICATE

Shock absorber bushings, support arm pivots.

9. LUBRICATE AT TIME OF ASSEMBLY BY DS AND GS PERSONNEL

Ventilator valve assembly, generator assembly, starter assembly and speedometer cable assembly.

10. BRAKE FLUID

Use hydraulic brake fluid (HB) non-petroleum base only. Use of hydraulic brake fluid petroleum base renders brakes inoperative.

11. SPECIAL INSTRUCTIONS

Special stress should be made to lubricate each propeller shaft bearing and suspension ball joint until clean lubricant comes through the seals.

*Copy of this lubrication order will remain with the vehicle at all times. Instructions contained herein are mandatory and supersede all conflicting lubrication instructions dated prior to the date of this lubrication order.*

By Order of the Secretary of the Army:

HAROLD K. JOHNSON,  
General, United States Army,  
Chief of Staff.

Official:

KENNETH G. WICKHAM  
Major General, United States Army,  
The Adjutant General.

FIG 3-6

FIG 3-7

FIG 3-7

AT 8726

Figure 3-1. Lubrication chart (sheet 2 of 2).

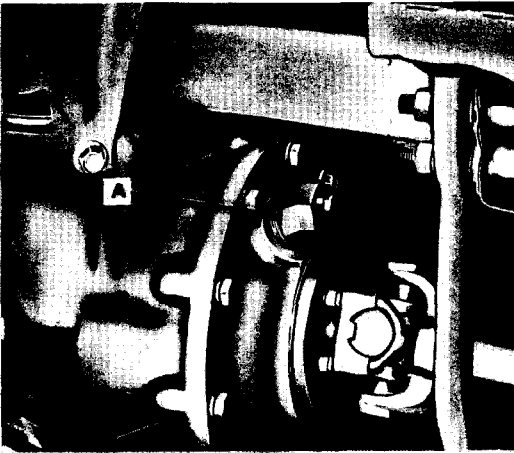

**A. FRONT DIFFERENTIAL FILL AND LEVEL**

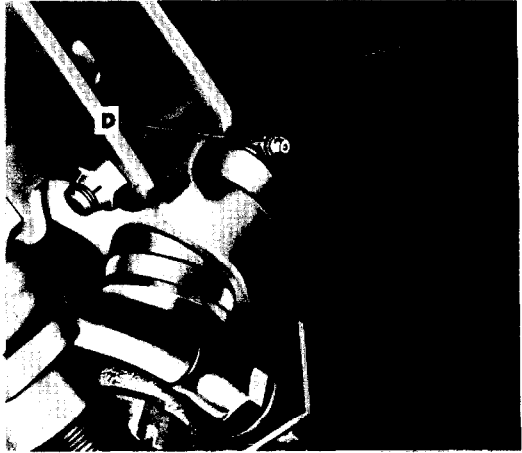

**D. SUSPENSION BALL JOINT**

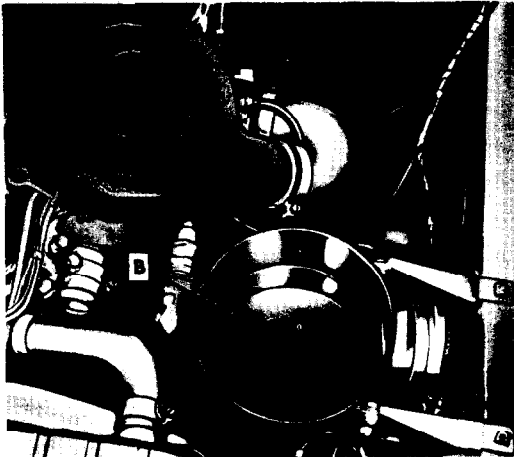

**B. AIR CLEANER**

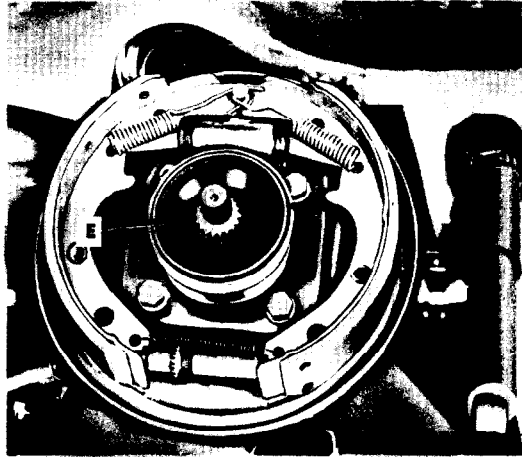

**E. FRONT WHEEL BEARINGS**

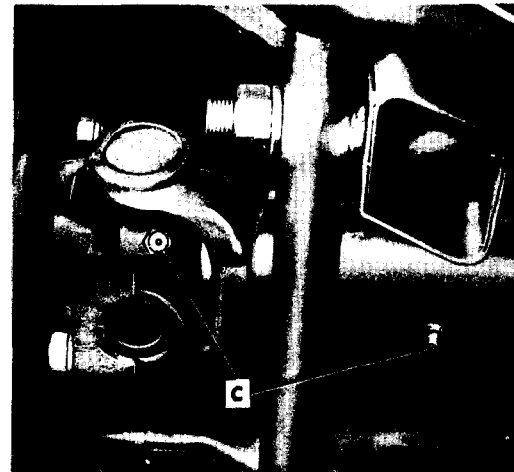

**C. FRONT AXLE DRIVE UNIVERSAL JOINT**  
AT 8727

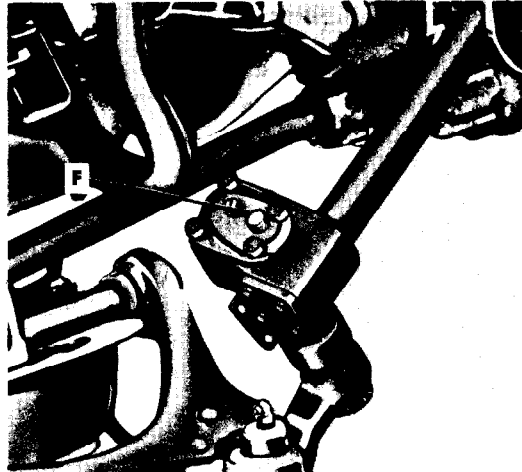

**F. STEERING GEAR, FILL AND LEVEL**

*Figure 3-2. Localized lubrication points, "A" through "F".*

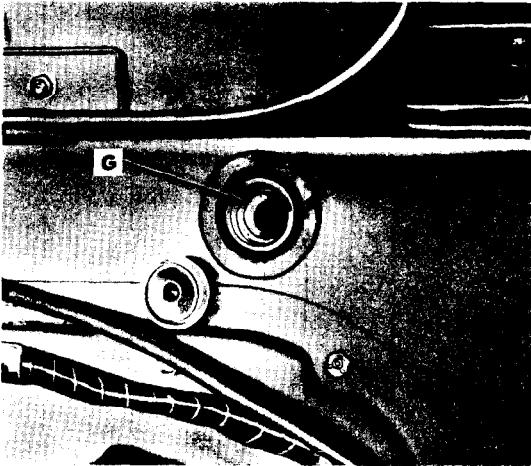

G. BRAKE MASTER CYLINDER

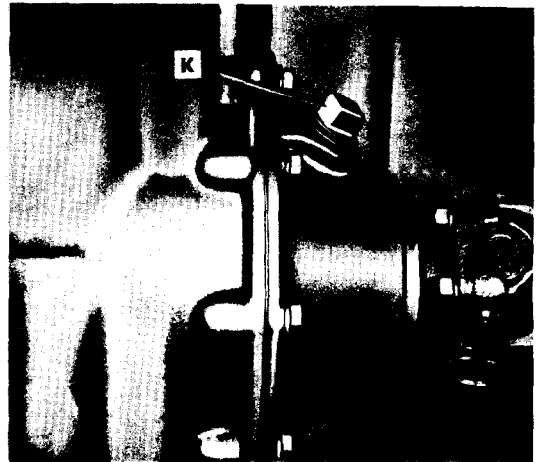

K. REAR DIFFERENTIAL  
FILL AND LEVEL

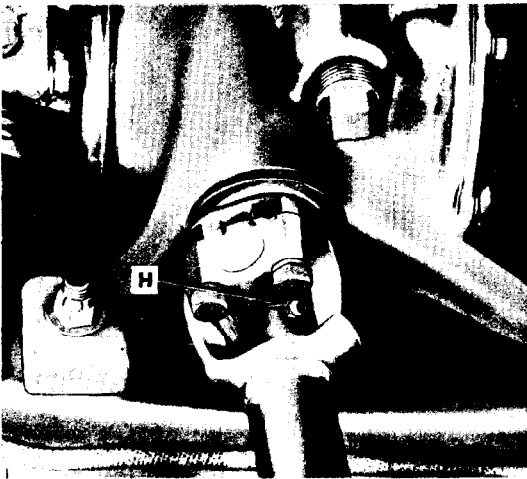

H. FRONT AXLE PROPELLER  
SHAFT UNIVERSAL JOINT

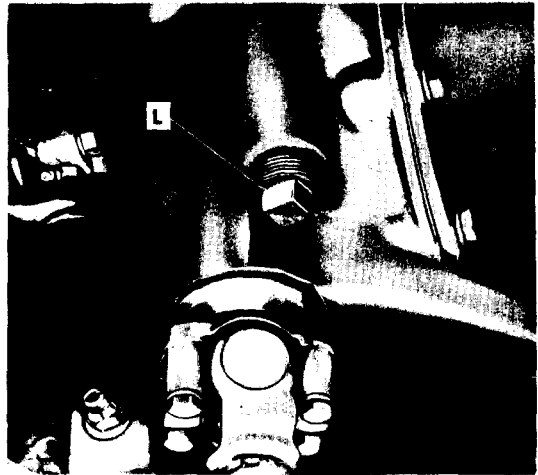

L. FRONT DIFFERENTIAL DRAIN

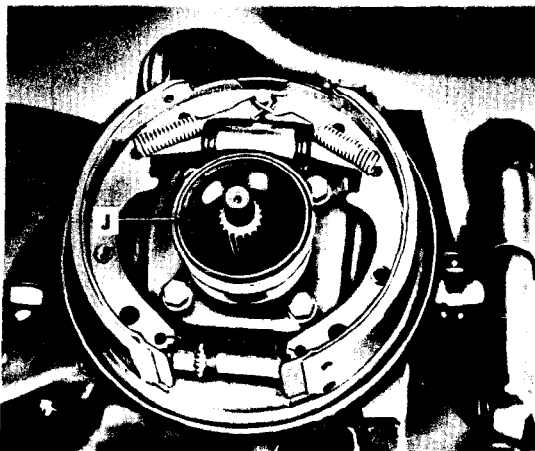

J. REAR WHEEL BEARINGS

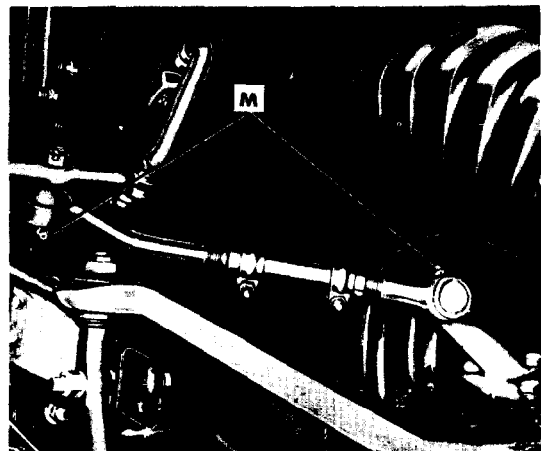

M. STEERING LINKAGE  
AT 8728

Figure 3-3. Localized lubrication points, "G" through "M".

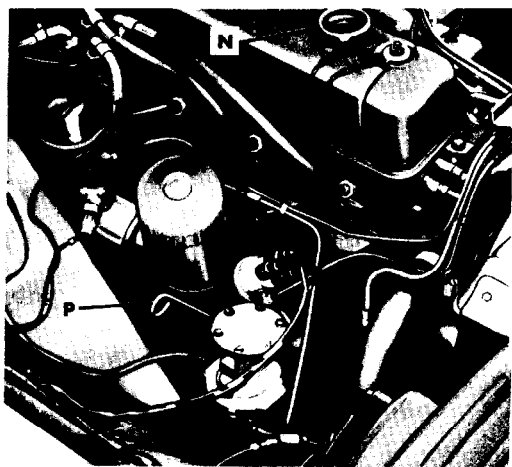

**N.** CRANKCASE FILL  
**P.** CRANKCASE LEVEL

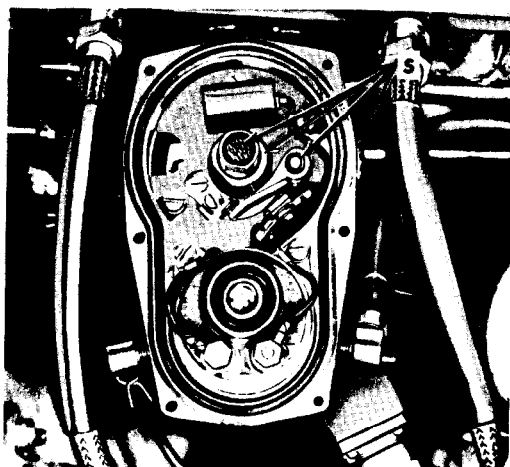

**S.** DISTRIBUTOR

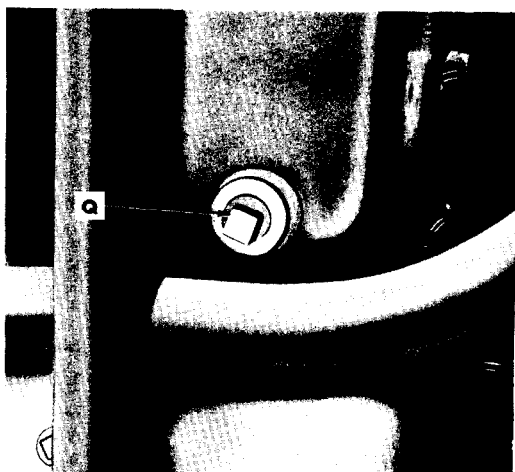

**Q.** CRANKCASE DRAIN

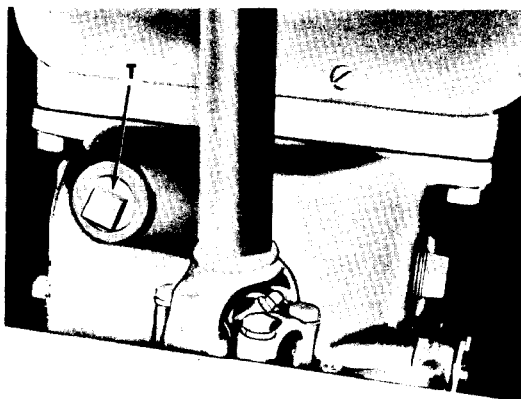

**T.** TRANSMISSION DRAIN

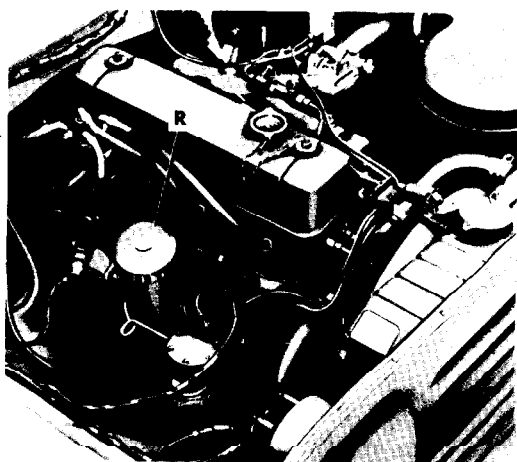

**R.** ENGINE OIL FILTER  
AT 8729

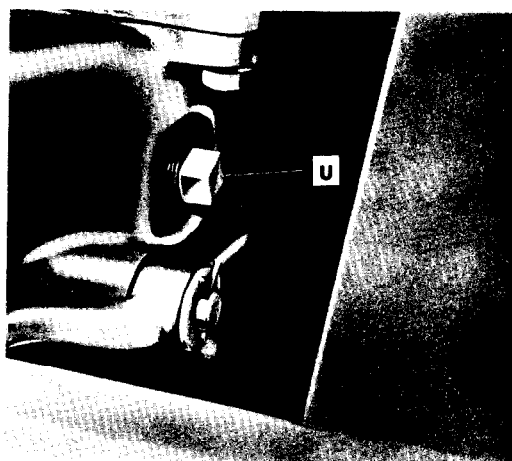

**U.** TRANSMISSION FILL  
AND LEVEL

*Figure 3-4. Localized lubrication points, "N" through "U".*

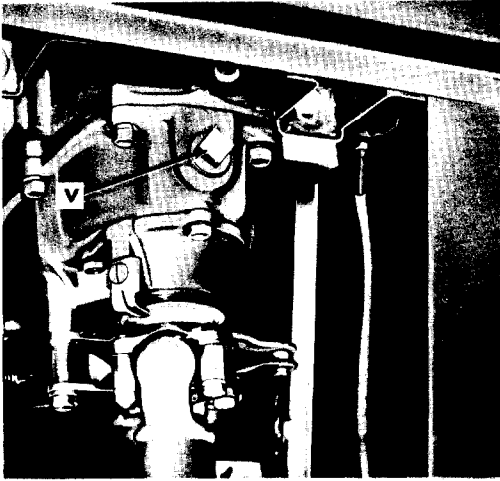

V. TRANSFER DRAIN

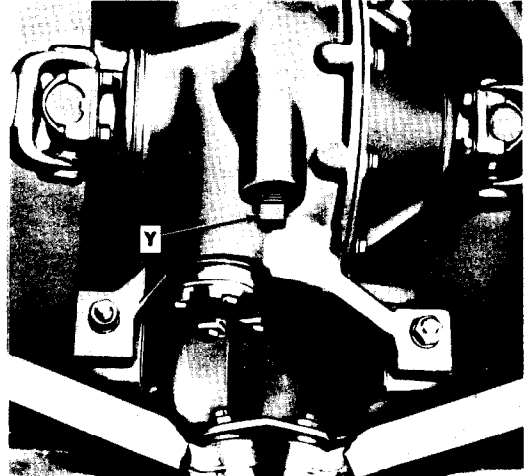

Y. REAR DIFFERENTIAL DRAIN

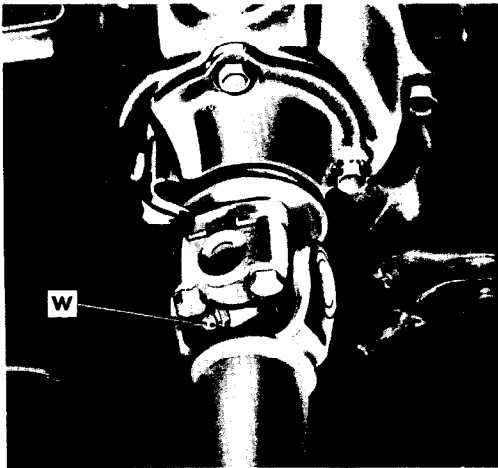

W. REAR PROPELLER SHAFT  
UNIVERSAL JOINT

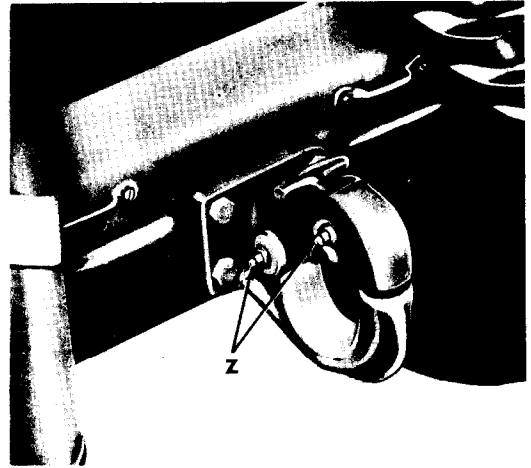

Z. PINTLE POINTS

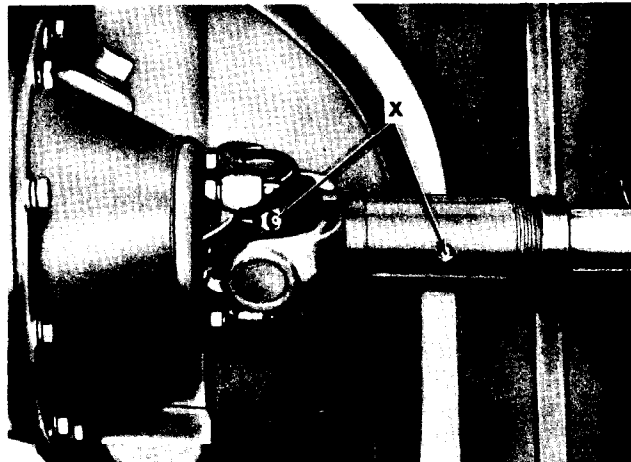

X. REAR AXLE DRIVE  
UNIVERSAL JOINT

AT 8730

Figure 3-5. Localized lubrication points, "V" through "Z".

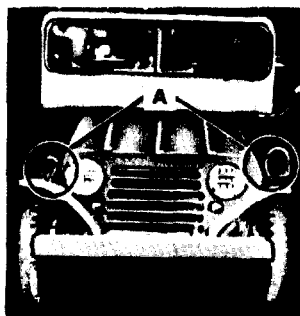

A. HOOD CATCH ASSEMBLY

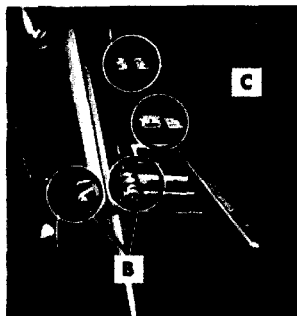

B. WINDSHIELD RETAINING PINS  
C. HOOD HINGES

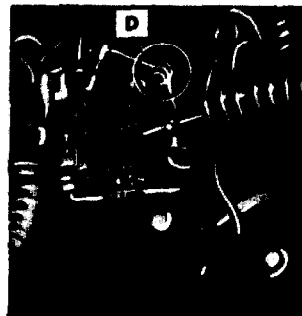

D. THROTTLE BELLCRANK

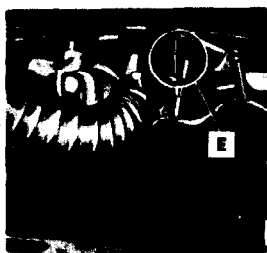

E. CARBURETOR LINKAGE

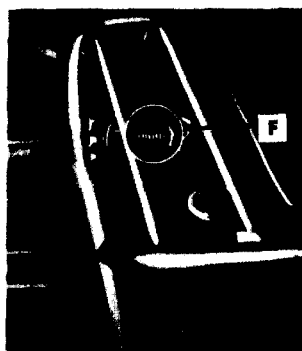

F. SEAT ADJUSTING SCREW  
EARLY MODELS

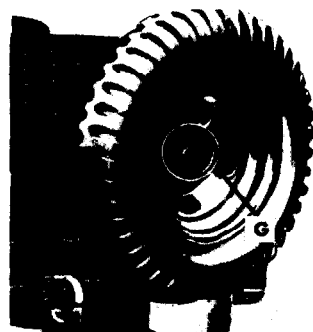

G. SPARE TIRE WING NUT

AT 8731

Figure 3-6. Oil can points, localized views, "A" through "G".

### 3-9. Oil Can Points

In addition to the lubrication points illustrated in figure 3-2 to 3-5, points to be lubricated by oil can, are shown in figures 3-6 and 3-7.

### 3-10. Organizational Maintenance Lubricate and "DO NOT LUBRICATE" Points

Certain points should not be lubricated by organizational maintenance personnel. These are described as "DO NOT LUBRICATE" points and are illustrated by figure 3-8. However, organizational maintenance personnel are expected to lubricate certain other assemblies as illustrated by figure 3-8.

### 3-11. Weapons Lubrication

M106 recoilless rifle and mount will be lubricated in accordance with TM 9-1000-205-

12. Other weapons will be lubricated in accordance with applicable technical manuals.

### 3-12. General Lubrication Instructions Under Unusual Conditions

*a. Service Intervals.* Reduce service intervals specified on the lubrication order, i.e., lubricate more frequently, to compensate for abnormal or extreme conditions, such as high or low temperatures, prolonged periods of highspeed operation, continued operation in sand or dust, immersion in water, or exposure to moisture. Any one of these operations or conditions may cause contamination and quickly destroy the protective qualities of the lubricants. Intervals may be extended during inactive periods commensurate with adequate preservation.

*b. Changing Grades of Lubricants.* Lubricants are prescribed in lubrication order

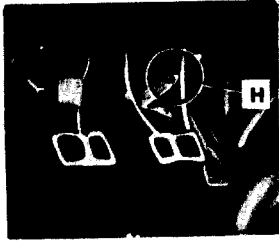

H. ACCELERATOR PEDAL PIVOT PIN



J. BATTERY COVER CLAMPS AND TOOL COMPARTMENT HINGE

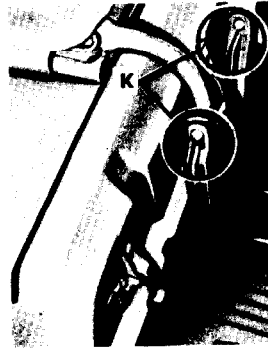

K. TWO POSITION SEAT DETENT PIN AND DETENT SLOT



L. SEAT RETAINING PINS AND REAR SEAT PIVOT PINS

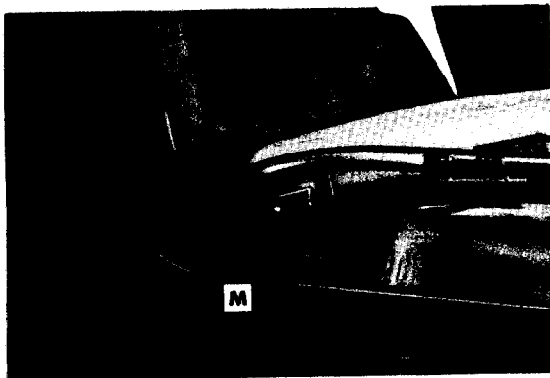

M. RECEPTACLE COVER HINGE

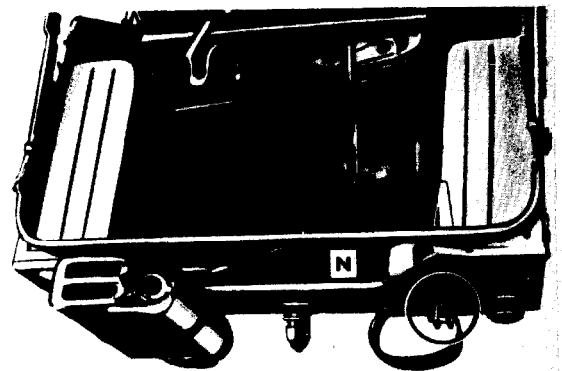

N. VEHICLE LIFTING EYES

AT 8732

Figure 3-7. Oil can points, localized views, "H" through "N".

LO 9-2320-218-12 (fig 3-1) in accordance with three temperature ranges: above +32°F, +40°F to -10°F, and from 0°F to -65°F. Change the grade of lubricants whenever weather forecast data indicates that air temperatures will be consistently in the next higher or lower temperature range or when sluggish starting caused by lubricant thickening occurs. No change in grade will be made when a temporary rise in temperature is encountered.

*c. Maintaining Proper Lubricant Levels.* Lubricant levels must be observed closely and necessary steps taken to replenish them in order to maintain proper levels at all times.

### 3-13. Lubrication for Continued Operation Below 0° F

Refer to TM 9-207 for instructions on necessary special preliminary lubrication of the vehicle, and to paragraph 4-8 for lubrication instructions on winterization kit (-65° F).

### 3-14. Lubrication After Fording Operations

a. After any fording operation, in water 12 inches or over, lubricate all chassis points to cleanse bearings of water or grit as well as any other points required in accordance with paragraph 3-31 for maintenance operations after fording.

b. If the vehicle has been in deep water for

LUBRICATE AT TIME OF ASSEMBLY BY DIRECT SUPPORT AND GENERAL SUPPORT MAINTENANCE PERSONNEL

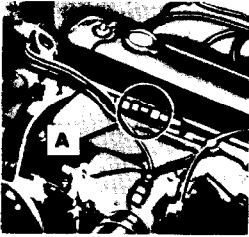

A. VENTILATOR VALVE ASSEMBLY

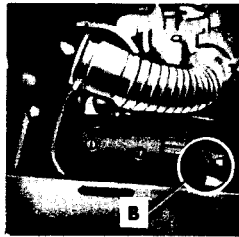

B. GENERATOR ASSEMBLY

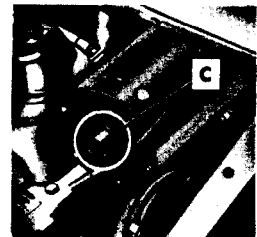

C. STARTER ASSEMBLY

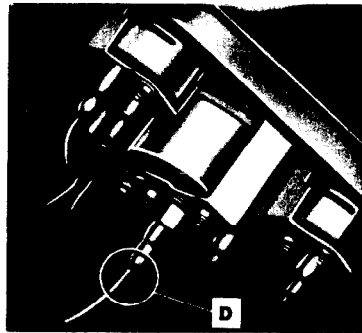

D. SPEEDOMETER CABLE ASSEMBLY

DO NOT LUBRICATE

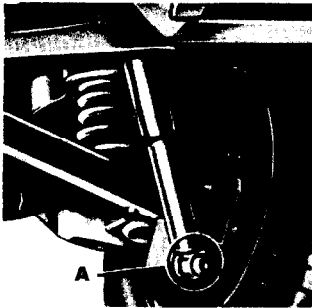

A. SHOCK ABSORBER BUSHINGS

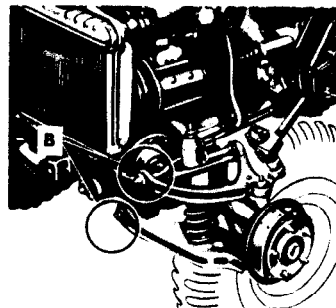

B. SUPPORT ARM PIVOTS

AT 8733

Figure 3-8. Lubricate at time of assembly by direct support and general support maintenance personnel and "DO NOT LUBRICATE" points.

a considerable length of time or was submerged beyond its fording capabilities, precautions must be taken as soon as practicable to avoid damage to the engine and other vehicles components as follows:

(1) Perform a complete lubrication ser-

vice regardless of time interval, paragraph 3-5.

(2) When engine oil is drained, check for the presence of water or sludge; if found, drain the oil and flush the engine with preservative engine oil



PE-30. Before putting in new oil, install a new oil filter assembly (fig 3-1-(R)).

*Note.* If preservative engine oil is not available, engine lubricating oil OE-30 may be used.

- (3) Operation in bodies of salt water increases the rapid accumulation of rust and corrosion, especially on unpainted surfaces. It is most important to remove all traces of salt water and salt deposits from every part of the vehicle. For assemblies which have to be disassembled, dried, and relubricated, perform these services as soon as the situation permits. Wheel bear-

ings must be disassembled and re-packed after each submersion. Regardless of the temporary measures taken, the vehicle must be delivered as soon as practicable to the supporting maintenance unit.

### 3-15. Lubrication After Operation Under Dusty and Sandy Conditions

After operation under dusty or sandy conditions, clean and inspect all points of lubrication for fouled lubricants and relubricate as necessary.

*Note.* A lubricant which is fouled by dust and sand acts as an abrasive mixture and causes rapid wear of parts.

## Section III. PREVENTIVE-MAINTENANCE SERVICES

### 3-16. General

Preventive maintenance is the systematic care, inspection, and servicing of equipment to maintain it in serviceable condition, prevent breakdowns, and assure maximum operational readiness. Preventive maintenance is accomplished by the equipment operator. The operator's role in the performance of preventive-maintenance services is:

*a.* To perform the daily service each day the equipment is operated.

*b.* To assist the organizational maintenance mechanics in the performance of any other scheduled periodic services specified by pertinent technical manuals.

*c.* To assist the organizational maintenance mechanics in the lubrication of the equipment in accordance with the pertinent lubrication order.

### 3-17. Responsibility

Operators and crew chiefs are personally responsible for assigned vehicles. Squad, section, and platoon leaders are charged with supervisory responsibility for vehicles pertaining to their commands. Unit and organization commanders are required to insure that vehicles issued or assigned to their commands are properly maintained in a serviceable condition, and that they are properly cared for and used.

### 3-18. Recording Repairs

Repairs accomplished will be in accordance with procedures and standards prescribed in appropriate technical manuals. The equipment record system provides for recording repairs required and accomplished on specific items of equipment. This will include, but is not limited to, adjusting, cleaning, and replacing. Deficiencies discovered before, during, and after operation that cannot be corrected by the operator will be entered on DA Form 2404. Deficiencies immediately corrected by the operator are not recorded, except when such corrections are made by replacing parts or which constitute repairs for supporting maintenance. Such repairs will be recorded as organizational maintenance.

### 3-19. Intervals

The mileage that materiel travels is the principal criterion for the frequency of preventive-maintenance services. On wheeled vehicles semi-annual "S" service is performed at 6,000 miles or six month intervals, whichever occurs first.

*Note.* Lubrication intervals should be shortened and lubrication frequency increased over the frequency and intervals specified when operating for extended periods under unusual conditions.

### 3-20. General Procedures for All Services and Inspections

a. The following general procedures apply to preventive-maintenance services and to all inspection, and are just as important as the specific procedures.

b. Inspection to see if items are in good condition, correctly assembled or stowed, secure, not excessively worn, not leaking, and adequately lubricated apply to most items in the preventive-maintenance and inspection procedures. Any or all of these checks that are pertinent to any item (including supporting, attaching, or connecting members) will be performed automatically, as general procedures, in addition to any specific procedures given.

- (1) Inspection for "good condition" is usually an external visual inspection to determine whether the unit is damaged beyond safe or serviceable limits. Good condition is explained further as meaning: not bent or twisted, not chafed or burred, not broken or cracked, not bare or frayed, not dented or collapsed, not torn or cut, not deteriorated.
- (2) Inspection of a unit to see that it is correctly assembled or stowed is usually a visual inspection to see if the unit is in its normal position in the vehicle and if all its parts are present and in their correct relative position.
- (3) Inspection of a unit to determine if it is "secure" is usually an external visual examination or a check by hand, wrench, or pry-bar for looseness. Such an inspection must include any brackets, lockwashers, locknuts, locking wires, or cotter pins as well as any connecting tubes, hoses, or wires.
- (4) By "excessively worn" is meant worn beyond serviceable limits or to a point likely to result in failure if the unit is not replaced before the next scheduled inspection. Excessive wear of mating parts of linkage connection is usually evidenced by too much play (lash or lost motion). It includes il-

legibility as applied to markings, data and caution plates, and printer matter.

- (5) Where the instruction "tighten" appears in the procedure, it means tighten with a wrench, even if the item appears to be secure.
- (6) Such expressions as "adjust if necessary" or "replace if necessary" are not used in the specific procedures. It is understood that whenever inspection reveals the need of adjustment, repairs or replacement, the necessary action will be taken.

c. Any special cleaning instructions required for specific mechanisms or parts are contained in the pertinent section. General cleaning instructions are as follows:

- (1) Use dry-cleaning solvent or mineral spirits paint thinner to clean or wash grease or oil from all metal parts, except those exposed to powder fouling during firing. This solvent will not readily dissolve the corrosive salts from powder and primer compositions.
- (2) Use rifle-bore cleaner to clean all armament parts which have been exposed to powder fouling during firing.  
*Note.* Rifle-bore cleaner is not a lubricant. Parts which require lubrication will be wiped dry and oiled.
- (3) A solution of one part grease-cleaning compound to four parts of dry-cleaning solvent or mineral spirits paint thinner may be used for dissolving grease and oil from engine blocks, chassis, and other parts. After cleaning, use cold water to rinse off any solution which remains.
- (4) After the parts are cleaned, rinse and dry them thoroughly. Apply a light grade of oil to all polished metal surfaces (other than optical instruments) to prevent rusting.
- (5) When authorized to install new parts, remove any preservative materials, such as rust-preventive compound, protective grease, etc.; prepare parts

as required (oil seals, etc.); and for those parts requiring lubrication, apply the lubricant prescribed in the lubrication order.

d. General precautions in cleaning are as follows:

- (1) Dry-cleaning solvent or mineral spirits paint thinner is flammable and should not be used near an open flame. Fire extinguishers should be provided when these materials are used. Use only in well-ventilated places.
- (2) These cleaners evaporate quickly and have a drying effect on the skin. If used without gloves, they may cause cracks in the skin and, in the case of some individuals, a mild irritation or inflammation.
- (3) Avoid getting petroleum products, such as dry-cleaning solvent, mineral spirits paint thinner, engine fuels, or lubricants, on rubber parts as they will deteriorate the rubber.
- (4) The use of diesel fuel oil, gasoline, or benzene (benzol) for cleaning is prohibited.

e. To prevent formation of damaging mildew, shake out and air the canvas cover for several hours at frequent intervals. Have any loose grommets or rips in the canvas repaired without delay. Failure to make immediate repairs may allow a minor defect to develop into major damage. Mildewed canvas is best cleaned by scrubbing with a dry brush. If water is necessary to remove dirt, it must not be used until mildew has been removed. If mildew is present, examine fabric carefully for evidence of rotting or weakening of fabric by stretching or pulling. If fabric shows indication of loss of tensile strength, it is probably not worth retreatment. If not damaged, notify organizational maintenance personnel so that steps can be taken to have the canvas retreated. Oil and grease can be removed by scrubbing with issue soap and warm water. Rinse well with clear water and dry.

f. Nameplates, caution plates, and instruction plates made of steel rust very rapidly. When they are found to be in a rusty condition,

they should be thoroughly cleaned and heavily coated with preservative oil.

### 3-21. Preventive Maintenance by Driver or Operator(s)—(Table 1)

a. *Purpose.* To assure maximum operational readiness, it is necessary that the vehicle be systematically inspected at intervals every day it is operated, so defects may be discovered and corrected before they result in serious damage or failure. Certain scheduled maintenance services will be performed at these designated intervals. Any deficiencies discovered that cannot be corrected by the operator, or corrected by replacing parts, will be reported on DA Form 2404.

b. *Daily Preventive-Maintenance Service.* Each vehicle will be inspected each day that it is operated. Definitions of these services appear in (1) through (3) below.

- (1) *Before-operation service.* This is a brief service to ascertain that the vehicle is ready for operation; it is mainly a check to see if conditions affecting the vehicle's readiness have changed since the last after-operation service.
- (2) *During-operation service.* This service consists of detecting unsatisfactory performance. While driving, the driver or crew should be alert for any unusual noises or odors, abnormal instrument readings, steering irregularities or any other indications of malfunction of any part of the vehicle. Every time he applies the brakes, shifts gears, or turns the vehicle, the driver should instinctively consider it a test and note any unusual or unsatisfactory performance.
- (3) *After-operation service.* This is the basic daily service for tactical vehicles. It consists of correcting, insofar as possible, any operation deficiencies. Thus the vehicle is prepared to operate upon a moment's notice.

c. *Preventive Maintenance Locator.* Refer to figure 3-9 for location of items to be checked and serviced as indicated in table 1.

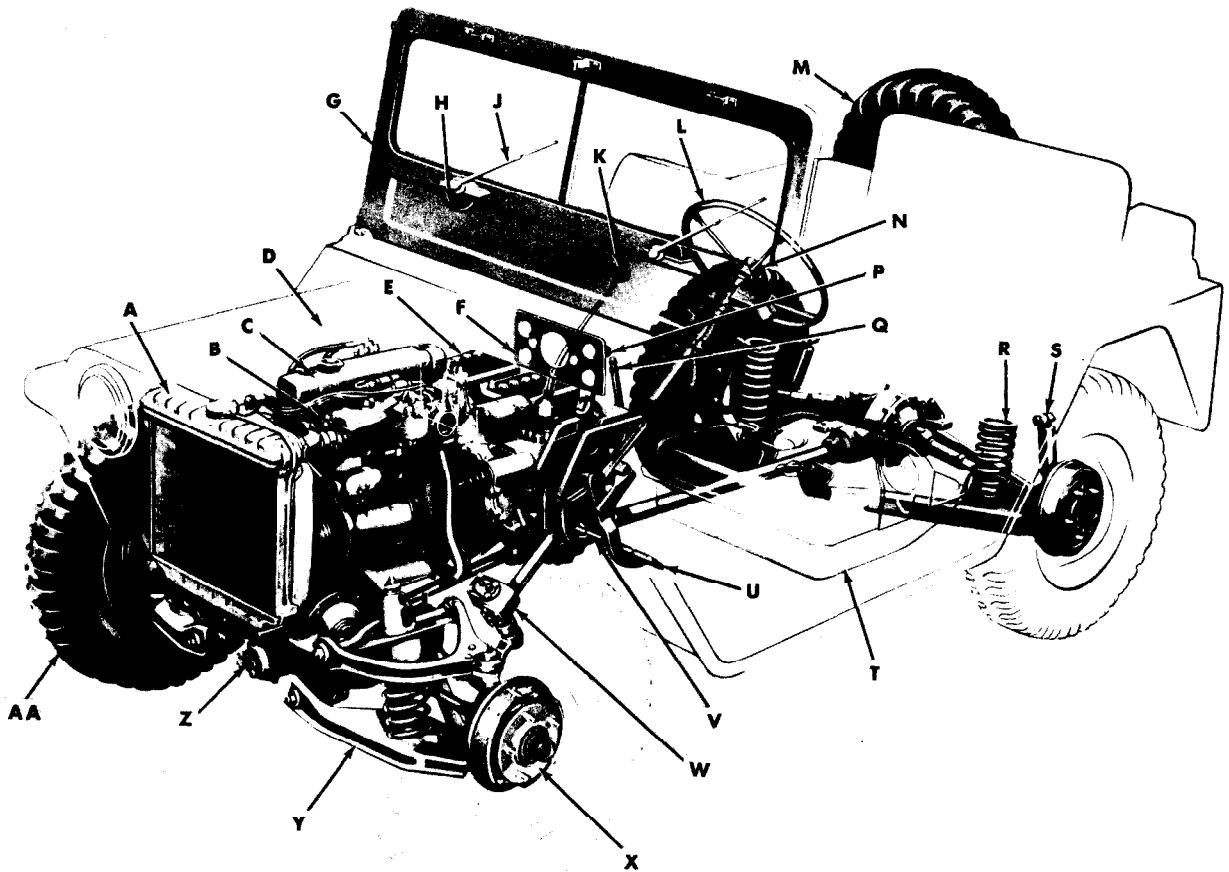

AT 8734

A—Radiator  
 B—Engine oil level dip stick  
 C—Engine  
 D—Engine compartment  
 E—Batteries  
 F—Instrument panel  
 G—Windshield  
 H—Windshield wiper motor  
 J—Windshield wiper

K—Transmission shift lever  
 L—Steering wheel  
 M—Spare tire and wheel  
 N—Horn button  
 P—Transfer case shift lever  
 Q—Parking brake lever  
 R—Spring  
 S—Shock absorbers

T—Fuel tank  
 U—Clutch pedal  
 V—Brake pedal  
 W—Steering gear  
 X—Brake system  
 Y—Front suspension system  
 Z—Differential  
 AA—Tires

Figure 3-9. Preventive-maintenance locator.

Table 1. Preventive-Maintenance Checks and Services

Interval and Sequence No.			Item to be Inspected	Procedure	Paragraph Reference
Before Operation	During Operation	After Operation			
1			Radiator Coolant.	Check coolant level, fill just below bottom of filler neck. Check if drain cocks are tight. Inspect hoses, clamps, radiator core, and radiator frame for leaks.	3-27
2			Engine Oil Level.	Check oil level, and add as required. Do not exceed "full" mark. Check that oil plugs are tight in place.	3-5
3			Engine Compartment.	Check for any evidence of fuel, oil, or hydraulic fluid leaks. Check if all wiring is properly secured and connected. Remove any obstructions, brush or leaves, that may have entered. Check if vent hole in master cylinder cap is clean. Check for hairline cracks in the area where the fan blades are riveted.	3-20
4			Tools and Canvas Top and Vehicle Publications.	Check that all tools are present and in a serviceable condition in the tool compartment. Check if all canvas top components are present, and if not in use, that they are properly stowed under the rear seat. Check driver's seat map compartment to see if lubrication order, technical manual, form(s) and Equipment Log Binder are present.	Appendix B
5			Batteries.	Remove battery filler caps and check electrolyte levels. Inspect condition of terminals.	3-28
6			Tires.	Gage tires, including spare for correct pressure. Remove any penetrating objects such as nails, glass, etc. Note if tire loses air. Check for missing valve caps or unusual wear.	1-16 3-25
7			Vehicle Equipment.	Visually inspect the following for security of mounting or damage: vehicle body, towing pintle, lifting shackles, spare tire mounting, gasoline can straps, reflectors, pioneer tools, fire extinguisher (if so equipped), windshield hinges and locking pins. If canvas top is installed check if straps are tight and button fasteners are snapped. Check passenger seat safety strap for serviceability.	3-20
8			Fuel.	Add fuel and fill spare gasoline can if required. Check if strainer in tank filler neck is clean. <b>Warning:</b> Always remove strainer to check unless checking in daylight. Do not use any lights to check strainer while installed in tank.	

Table 1. Preventive-Maintenance Checks and Services—Continued

Interval and Sequence No.			Item to be Inspected	Procedure	Paragraph Reference
Before Operation	During Operation	After Operation			
9			Leaks and Underbody.	Check under vehicle for differential, transmission, gasoline line, or brake fluid leaks. Look for fluid spots on the ground which will help find leaks. Some seepage around oil seals is normal. Remove any accumulations of mud, brush, or debris from under vehicle, especially around propeller and drive shafts, front suspension, and wheel wells.	3-20
10	17		Instruments.	Turn ignition switch on and observe instruments for correct operation. Start engine and again observe instruments before operating vehicle. If oil pressure is zero, stop engine and investigate.	2-5
11	16		Brakes.	Before operation depress foot brake pedal for proper amount of travel, and check stop-light. Check parking brake for proper amount of tension and make rotary adjustment on handle, if necessary. During operation, depress foot brake pedal, observe brake pedal travel in operation and braking operation for effectiveness. During operation test parking brake by its ability to hold on an incline.	1-11
12			Windshield Wipers, Lights, Horn.	Check operation of windshield wipers and horn (if tactical situation permits). Check operation of lights and turn signal if tactical situation permits.	2-4d
13			Windshield and Mirror.	Clean windshield; clean and adjust mirror as required.	3-20
14	15		Controls.	Check starter switch for normal actuating pressure and note that engine starts at once without unusual noises. In warming up the engine, check operation of choke, accelerator and throttle controls. During operation listen for any unusual noises when engine is under load, check clutch, gear shifting and steering. Note operating faults, such as wander, shimmy difficulty in engaging gears, etc. When conditions are favorable, on a level stretch of unobstructed highway, speed up the vehicle to see that it reaches—but does not exceed—maximum permissible speed.	2-7
		18	Vehicle Exterior.	Check general condition of the body. Check towing pintle. Check security of all locking and fastening devices. Wash or wipe off exterior of vehicle with clean soft cloth.	3-20

Table 1. Preventive-Maintenance Checks and Services—Continued

Interval and Sequence No.			Item to be Inspected	Procedure	Paragraph Reference
Before Operation	During Operation	After Operation			
		19	Springs and Underbody.	<p>Check for damage under the vehicle, especially springs and shock absorbers. Check for leaks. Remove any accumulations of mud, brush, or debris from under vehicle.</p> <p><i>Note.</i> Perform all before-operation preventive-maintenance services as a part of after-operation preventive maintenance. Do not gage tires when they are hot.</p>	3-20

**3-22. Operator Participation in Performance of Organizational Preventive Maintenance**

When practical and applicable, operators will accompany the vehicle when it is returned to organizational maintenance for the semi-

annual "S" preventive-maintenance service. Operators may thus relate to organizational personnel, first hand and detailed information on any unusual noises or peculiar operating conditions. Also, operators will assist in the performance of these periodic maintenance services.

**Section IV. TROUBLESHOOTING**

**3-23. Scope**

a. This section contains troubleshooting information for locating and correcting some of the troubles which may develop in the vehicle. Troubleshooting is the systematic isolation of defective components by means of an analysis of trouble symptoms, testing to determine the defective component, and applying the remedies. In the majority of cases, the driver can only note trouble symptoms, by detecting strange or unusual noises or other irregularities, and report them to organizational maintenance personnel for further action.

b. Standard automotive theories and principles of operation apply in troubleshooting this vehicle. The driver must pay careful attention to any symptoms of trouble, unusual noises, odors, or handling, or any observable defective condition, and report them to organizational maintenance personnel if the remedy is beyond his responsibility. The greater the number of

symptoms that can be detected and evaluated, the easier and quicker the defect can be isolated and corrected.

**3-24. Troubleshooting Table**

a. The troubleshooting malfunction (symptoms), probable causes, and corrective actions that can ordinarily be performed by the driver are listed in table 2. In emergency situations where the services of organizational maintenance personnel are not available and where immediate corrective action must be taken to operate the vehicle, the operator may perform such additional actions of which he is capable.

b. The operator must bear in mind the importance of detecting and reporting any symptoms of trouble that occur during operation of the vehicle. Many symptoms of serious and costly trouble are apparent only during operation, and if not detected and reported by the driver, may go undetected until they result in complete failure.

Table 2. Troubleshooting

Malfunction	Probable causes	Corrective action
1. Engine will not turn when starting motor is actuated.	a. Defective starter system. b. Mechanical seizure of parts. c. Other causes.	a. Troubleshoot starting system. (See items 10 and 11.) b. Notify organizational maintenance. c. Notify organizational maintenance.
2. Engine turns over but will not start.	a. Ignition switch in "OFF" position. b. Fuel tank empty.  c. Combustion chambers flooded with fuel.  d. Battery cables loose or corroded. e. Batteries weak.  f. Inadequate fuel air mixture. g. Other causes.	a. Turn switch to "ON" position. b. Fill fuel tank. Note. Do not fill fuel tank prior to checking for visible signs of leaks in fuel system. If fuel leaks are found, notify organizational maintenance. c. Push choke all the way in, open throttle, and crank engine to expel excessive fuel. If flooding continues, notify organizational maintenance. d. Notify organizational maintenance. e. Notify organizational maintenance. In emergencies, tow-start vehicle (par 2-15). f. Pull out choke. g. Notify organizational maintenance.
3. Engine starts but does not continue to run.	a. Inoperative fuel pump safety switch or low oil level in crankcase. b. Fuel level low. c. Carburetor float stuck. d. Other causes.	a. Check crankcase oil level. Add oil if necessary. If trouble continues, notify organizational maintenance. b. Check fuel level and fill if necessary. c. Notify organizational maintenance. d. Notify organizational maintenance.
4. Engine overheating.	a. Coolant level low.  b. Pressure cap missing or not sealing. c. Fan belt loose or broken. d. Radiator obstructed with brush or leaves, etc. e. Insufficient oil in crankcase. f. Other causes.	a. Check coolant level in radiator and fill to slightly below bottom of filler neck, adding anti-freeze solution as necessary. Look for hose and radiator leaks. Not organizational maintenance if loss of coolant continues. b. Obtain serviceable cap. Coordinate with organizational maintenance. c. Notify organizational maintenance. d. Clean. e. Check oil level and add as required. Coordinate with organizational maintenance. f. Notify organizational maintenance.
5. Lack of power.	a. Choke not fully open. b. Parking brake applied. c. Other causes.	a. Push choke control rod all the way in. b. Release parking brake. c. Notify organizational maintenance.
6. Engine will not idle or it misfires.	Causes are beyond scope of operator's maintenance.	Notify organizational maintenance.
7. Excessive oil consumption.	a. External leaks. b. Crankcase overfilled. c. Other causes.	a. Notify organizational maintenance. b. Drain excess oil and maintain oil at correct level. Coordinate with organizational maintenance. c. Notify organizational maintenance.



Table 2. Troubleshooting—Continued

Malfunction	Probable causes	Corrective action
8. Spark knock or ping (a sharp metallic knock occurring on acceleration or when operating under heavy load).	<ul style="list-style-type: none"> <li>a. Engine overheating.</li> <li>b. Low octane fuel.</li> <li>c. Other causes.</li> </ul>	<ul style="list-style-type: none"> <li>a. Refer to item 4 above.</li> <li>b. Use correct grade fuel.</li> <li>c. Notify organizational maintenance.</li> </ul>
9. Excessive fuel consumption.	<ul style="list-style-type: none"> <li>a. Leaks.</li> <li>b. Choke left out.</li> <li>c. Improper driving techniques.</li> <li>d. Air cleaner restricted or dirty.</li> <li>e. Other causes.</li> </ul>	<ul style="list-style-type: none"> <li>a. Carefully inspect fuel system for leaks. Report condition to organizational maintenance.</li> <li>b. Push choke control in.</li> <li>c. Follow driving instructions par 2-10; also refer to TM 21-305.</li> <li>d. Clean and service air cleaner. Coordinate with organizational maintenance.</li> <li>e. Notify organizational maintenance.</li> </ul>
10. Starter will not crank engine.	<ul style="list-style-type: none"> <li>a. Loose or corroded connections.</li> <li>b. Battery discharged.</li> <li>c. Other causes.</li> </ul>	<ul style="list-style-type: none"> <li>a. Examine cables for unsatisfactory terminal connections and report condition to organizational maintenance.</li> <li>b. Notify organizational maintenance.</li> <li>c. Notify organizational maintenance.</li> </ul>
11. Slow cranking speed.	<ul style="list-style-type: none"> <li>a. Incorrect crankcase oil viscosity.</li> <li>b. Loose or corroded connections.</li> <li>c. Other causes.</li> </ul>	<ul style="list-style-type: none"> <li>a. In cold weather, heavy oil will slow down cranking speed and cause the battery voltage to drop, especially when engine is cold. Use oil of correct viscosity. Coordinate with organizational maintenance.</li> <li>b. Notify organizational maintenance.</li> <li>c. Notify organizational maintenance.</li> </ul>
12. Fuel gage inoperative or operating abnormally.	<ul style="list-style-type: none"> <li>a. Fuel tank empty.</li> <li>b. Other causes.</li> </ul>	<ul style="list-style-type: none"> <li>a. Fill fuel tank and observe gage.</li> <li>b. Notify organizational maintenance.</li> </ul>
13. Oil pressure gage inoperative or operating abnormally.	<ul style="list-style-type: none"> <li>a. Engine oil supply low.</li> <li>b. Other causes.</li> </ul>	<ul style="list-style-type: none"> <li>a. Fill crankcase to proper level with grade of oil specified in lubrication order (LO 9-2320-218-12). Coordinate with organizational maintenance.</li> <li>b. Notify organizational maintenance.</li> </ul>
14. Engine temperature gage inoperative or operating abnormally.	<p>Causes are beyond scope of operator's maintenance.</p>	<p>Notify organizational maintenance.</p>
15. Battery-generator indicator inoperative or operating abnormally.	<ul style="list-style-type: none"> <li>a. Loose or corroded battery cable terminals.</li> <li>b. Other causes.</li> </ul>	<ul style="list-style-type: none"> <li>a. Notify organizational maintenance.</li> <li>b. Notify organizational maintenance.</li> </ul>
16. Speedometer does not register speed or mileage.	<p>Causes are beyond scope of operator's maintenance.</p>	<p>Notify organizational maintenance.</p>
17. Horn does not operate.	<p>Causes are beyond scope of operator's maintenance.</p>	<p>Notify organizational maintenance.</p>
18. Horn operates continually.	<p>Horn button stuck or grounded, or horn cable grounded in steering column.</p>	<p>Temporarily pull connector apart at horn, right hand rear side of engine compartment. Notify organizational maintenance.</p>
19. Instrument panel lights inoperative (with switch on).	<ul style="list-style-type: none"> <li>a. Lamps burned out.</li> <li>b. Other causes.</li> </ul>	<ul style="list-style-type: none"> <li>a. Notify organizational maintenance.</li> <li>b. Notify organizational maintenance.</li> </ul>

Table 2. Troubleshooting—Continued

Malfunction	Probable causes	Corrective action
20. Lights, other than instrument panel, inoperative (with switch on).	Causes are beyond scope of operator's maintenance.	Notify organizational maintenance.
21. Abnormal operation of clutch: chatter, grabbing, slippage, dragging, gear clashing.	Causes are beyond scope of operator's maintenance.	Notify organizational maintenance.
22. Hard shifting of transmission and front-wheel drive transfer.	<ul style="list-style-type: none"> <li>a. Incorrect lubrication (too thick for temperature).</li> <li>b. Other causes.</li> </ul>	<ul style="list-style-type: none"> <li>a. Drain and refill with grade of lubricant specified in lubrication order (LO 9-2320-218-12), or if not practical, drive slowly until lubricant warms up. Change lubricant at first opportunity. Coordinate with organizational maintenance.</li> <li>b. Notify organizational maintenance.</li> </ul>
23. Transmission or front-wheel drive transfer, slips out of gear.	Causes are beyond scope of operator's maintenance.	Notify organizational maintenance.
24. Transmission or transfer noisy in operation.	<ul style="list-style-type: none"> <li>a. Insufficient lubricant.</li> <li>b. Other causes.</li> </ul>	<ul style="list-style-type: none"> <li>a. Fill to level of filler plug. Refer to lubrication order (LO 9-2320-218-12). Coordinate with organizational maintenance.</li> <li>b. Notify organizational maintenance.</li> </ul>
25. Lubricant leaks from transmission or transfer.	<ul style="list-style-type: none"> <li>a. Drain plugs loose.</li> <li>b. Lubricant level too high.</li> <li>c. Other causes.</li> </ul>	<ul style="list-style-type: none"> <li>a. Tighten drain plugs.</li> <li>b. Drain to plug level. Refer to lubrication order (LO 9-2320-218-12). Coordinate with organizational maintenance.</li> <li>c. Notify organizational maintenance.</li> </ul>
26. Front or rear differential noisy.	<ul style="list-style-type: none"> <li>a. Insufficient or incorrect lubricant.</li> <li>b. Other causes.</li> </ul>	<ul style="list-style-type: none"> <li>a. Lubricate in accordance with lubrication order (LO 9-2320-218-12). Coordinate with organizational maintenance.</li> <li>b. Notify organizational maintenance.</li> </ul>
27. Lubricant leaks from front or rear differential.	<ul style="list-style-type: none"> <li>a. Loose drain plugs.</li> <li>b. Lubricant level too high.</li> <li>c. Other causes.</li> </ul>	<ul style="list-style-type: none"> <li>a. Tighten drain plugs.</li> <li>b. Drain to plug level. Refer to lubrication order with organizational maintenance.</li> <li>c. Notify organizational maintenance.</li> </ul>
28. Improper braking action: hard, soft, or spongy pedal; grabbing, chattering, squealing, pulling sideways, dragging, overheating, and slipping.	Causes are beyond scope of operator's maintenance.	Notify organizational maintenance.
29. Abnormal tire wear.	<ul style="list-style-type: none"> <li>a. Tire pressure low.</li> <li>b. Use of front-wheel drive on hard surfaced roads and at speeds above 25 mph.</li> <li>c. Poor driving practice.</li> <li>d. Other causes.</li> </ul>	<ul style="list-style-type: none"> <li>a. Keep inflated to correct pressure, par 1-16. Check valve caps.</li> <li>b. Use front-drive only when maximum traction is needed at speeds below 25 mph.</li> <li>c. Refer to TM 21-305.</li> <li>d. Notify organizational maintenance.</li> </ul>

Table 2. Troubleshooting—Continued

Malfunction	Probable causes	Corrective action
30. Wheel wobbles.	a. Loose wheel nuts. b. Other causes.	a. Tighten as required. b. Notify organizational maintenance.
31. Hard steering.	a. Tire pressure low. b. Insufficient lubrication.  c. Other causes.	a. Inflate to correct pressure par 1-16. b. Lubricate steering gear and linkage (LO 9-2320-218-12). Coordinate with organizational maintenance. c. Notify organizational maintenance.
32. Looseness in steering.	a. Tire pressure low. b. Other causes.	a. Inflate to correct pressure par 1-16. b. Notify organizational maintenance.
33. Shimmy in front wheels. (Jerking motion, making it difficult to hold steering wheel steady.)	Causes are beyond scope of operator's maintenance.	Notify organizational maintenance.
34. All other unusual noises, odors, or operating difficulties.	Causes are beyond scope of operator's maintenance.	Notify organizational maintenance.

**Section V. CORRECTIVE MAINTENANCE**  
**(INSTRUCTIONS FOR OPERATOR)**

**3-25. Changing Wheel and Tire Assembly**  
**(Figures 3-10 to 3-12)**

*Note.* Later model vehicles are manufactured with steel wheels. Some earlier model vehicles were manufactured with magnesium wheels. Intermixing of steel and magnesium wheels is not recommended. If intermixing is necessary, however, both front wheels should be of one type and both rear wheels of the other type. Only in emergencies should intermixing occur.

Instructions for removal of an unserviceable wheel and tire assembly and for installation of a spare tire assembly are given below and are illustrated as indicated.

a. Set parking brake and use blocking at opposite wheel for extra safety precautions. Obtain jack and combination jack handle and wheel nut wrench from tool kit under front passenger seat. Loosen wheel nuts; do not remove. All threads are right hand (fig 3-10).

b. Put jack button in "UP" position. Turn out jack screw to approximate height. Place jack in recess of lower suspension arm (fig 3-11). Insert handle of the wheel wrench in jack ratchet and raise the wheel off the ground.

c. Remove wheel nuts and remove wheel and tire assembly from brakedrum. Remove spare

wheel and tire assembly from stowage and stow unserviceable assembly.

d. Position spare wheel assembly on brakedrum. Install and turn nuts up snugly. Put jack button in "DOWN" position and lower wheel to ground. Remove jack. Tighten wheel nuts securely (fig 3-10). Stow jack and wrench.

**3-26. Correcting Tire Valve Leaks**

a. If a tire continuously loses air, check valve core with a drop of water or saliva for leakage. If leaking, tighten core with end of valve cap or replace core if necessary.

b. Check all valves for caps; if any are missing, install new caps, (fig 3-12).

c. Maintain tire pressures specified in paragraph 1-16 for various conditions.

**3-27. Draining and Filling the Cooling System**

a. *Draining.* Instructions for draining the cooling system are given below:

**Caution:** Remove radiator cap (fig. 3-13) slowly to relieve pressure.

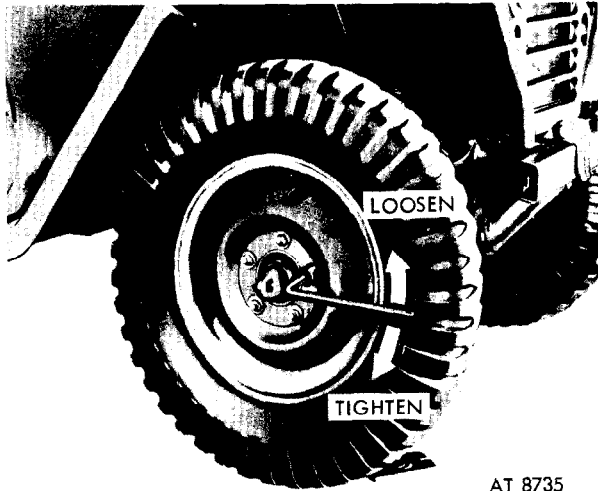

AT 8735

Figure 3-10. Wheel nut loosening and tightening.

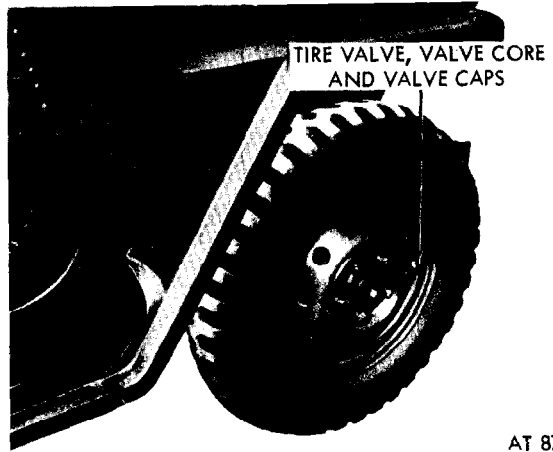

AT 8737

Figure 3-12. Locating the tire valve and valve core.

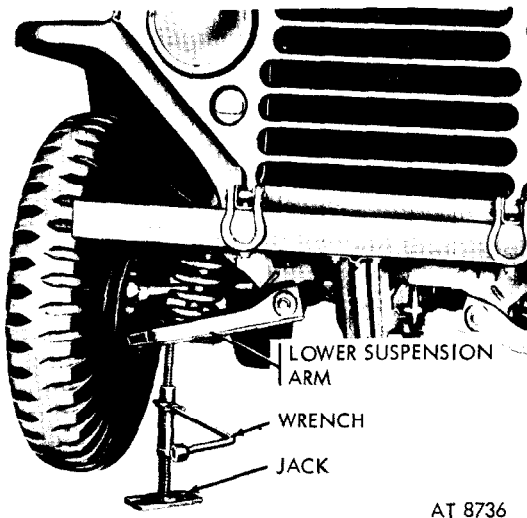

AT 8736

Figure 3-11. Locating the jack and lifting the wheel.

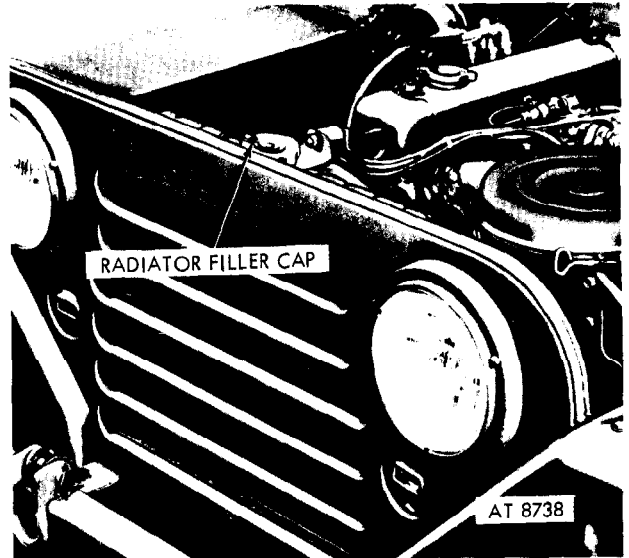

AT 8738

Figure 3-13. Radiator filler cap.

- (1) Place container under radiator drain cock, if coolant is to be reused. Open drain cock, as located by figure 3-14.
- (2) Place container under cylinder block drain cock, if coolant is to be reused. Open drain cock, as located by figure 3-15.

b. *Filling.* To fill the cooling system after draining, proceed as follows:

- (1) Close both drain cocks.
- (2) Pour coolant into radiator filler neck

to level just below bottom of filler neck. (If coolant is not to be reused, fill with clean water and rust inhibitor or anti-freeze solution.)

- (3) Start engine to expel air.
- (4) Add coolant as necessary.
- (5) Install radiator filler cap (fig 3-13).

**Caution:** Do not put coolant into cooling system when engine is overheated. If engine is at normal operating temperature, start and run engine while filling radiator.

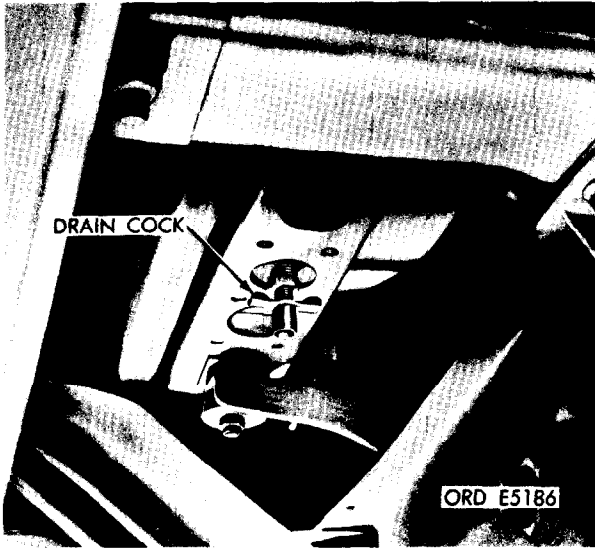

Figure 3-14. Radiator drain cock.

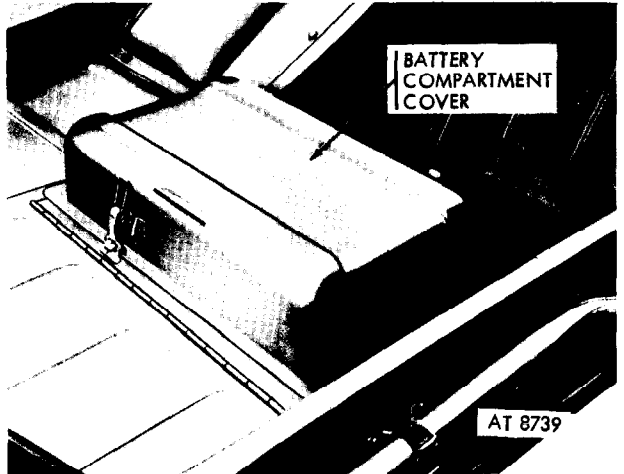

Figure 3-16. Battery compartment cover.

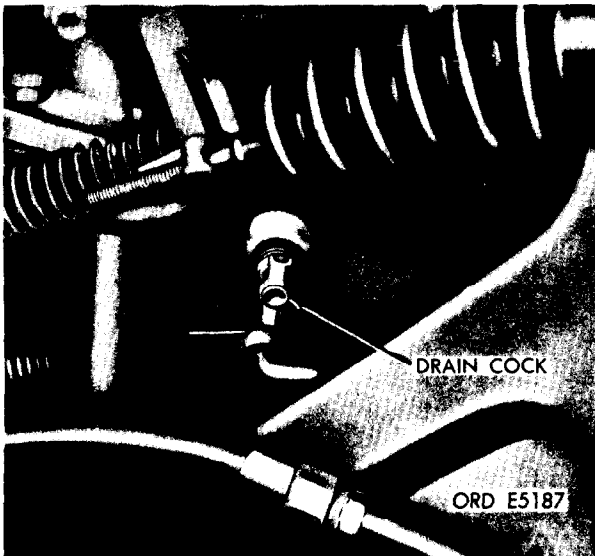

Figure 3-15. Cylinder block drain cock.

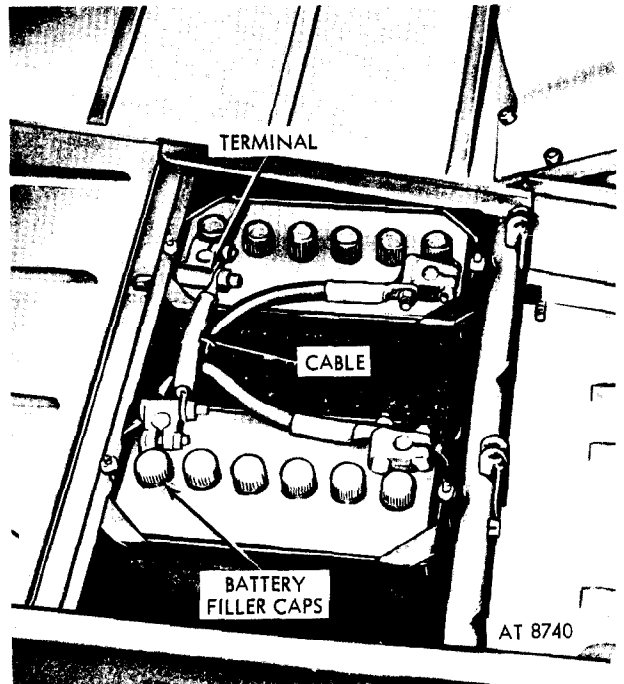

Figure 3-17. Batteries and battery filler caps.

### 3-28. Checking Electrolyte Level in Batteries

a. Remove right hand front passenger seat. Remove battery compartment cover located as illustrated by figure 3-16.

b. Unscrew the six filler caps (fig 3-17) one by one from each battery, inspecting the electrolyte level and replacing the caps. If the electrolyte level is low, notify organizational

maintenance personnel so that the proper fluid can be replaced and the correct level maintained, or fill with the most clean and pure water obtainable. Refer to paragraph 3-30 for extreme hot weather maintenance of batteries.

**Warning:** In all parts of this operation, use extreme care to prevent battery compartment

cover or tools from touching any electrical connection point and any metal part of the vehicle at the same time. Such a short circuit will instantly burn a pit in the metal. Exercise

special care not to wear jewelry, bracelets, or rings when working near the batteries. Each battery is rated at 12 volts and can cause painful injuries when short circuited.

## Section VI. MAINTENANCE UNDER UNUSUAL CONDITIONS

### 3-29. Extreme Cold-Weather Maintenance Problems

a. The importance of maintenance must be impressed on all concerned. Maintenance of mechanical equipment in extreme cold is exceptionally difficult in the field. Even shop maintenance cannot be completed with normal speed, because the equipment must be allowed to thaw out and warm up before the mechanic can make satisfactory repairs. In the field, maintenance must be undertaken under the most difficult of conditions. Bare hands stick to cold metal. Fuel in contact with the hands results in supercooling due to evaporation, and the hands can be painfully frozen in a matter of minutes. Engine oils, except subzero grade, are unpourable at temperatures below  $-40^{\circ}$  F. Ordinary greases become solid.

b. These difficulties increase the time required to perform maintenance. At temperatures below  $-40^{\circ}$  F, maintenance requires up to five times the normal amount of time. The time required to warm up a vehicle so that it is operable at temperatures as low as  $-50^{\circ}$  F. may approach 2 hours. Vehicles in poor mechanical condition probably will not start at all, or only after many hours of laborious maintenance and heating. Complete winterization, diligent maintenance, and well-trained crews are the key to efficient arctic-winter operations.

c. Refer to TM 9-207 for a general discussion of extreme cold maintenance procedures, application of anti-freeze compounds and arctic-type lubricants, handling of storage batteries in extreme cold, and de-winterization procedures.

**Caution:** It is imperative that the approved maintenance procedures be followed. TM 9-207 contains general information which is specifically applicable to these vehicles as well as to all other vehicles. It must be considered

an essential part of this technical manual, not merely an explanatory supplement to it.

### 3-30. Extreme Hot-Weather Maintenance

a. *Cooling System.* Thoroughly clean and flush the cooling system (par 3-27) at frequent intervals and keep system filled to within  $1\frac{1}{2}$  inches of the overflow pipe with clean water when operating in extremely high temperatures. Formation of scale and rust in the cooling system occurs more rapidly during operation in extremely high temperatures; therefore, corrosion-inhibitor compound should always be added to the cooling liquid. Avoid the use of water that contains alkali or other substances which may cause scale and rust formations. Use soft water whenever possible.

b. *Batteries.* In torrid zones, check level of electrolyte in cells daily and replenish, if necessary, with pure distilled water. If this is not available, rain or drinking water may be used. However, continuous use of water with high mineral content will eventually cause damage to batteries and should be avoided.

#### c. *Chassis and Body.*

- (1) In hot, damp climates, corrosive action will occur on all parts of the vehicle and will be accelerated during the rainy season. Evidences will appear in the form of rust and paint blisters on metal surfaces and mildew, mold, or fungus growth on fabrics and glass.
- (2) Protect all exposed metal surfaces with a film of preservative lubricating oil (medium) on unfinished exposed metal surfaces. Cables and terminals should be protected by ignition-insulation compound.
- (3) Make frequent inspections of idle, inactive vehicles. Remove corrosion from exterior metal surfaces with

abrasive paper or cloth and apply a protective coating of paint, oil, or suitable rust preventive.

### 3-31. Maintenance of Materiel After Fording

*a. General.* Although the vehicle unit housings are sealed to prevent the free flow of water into the housings, it must be realized that, due to the necessary design of these assemblies, some water may enter, especially during submersion. The following services should be accomplished on vehicles which have been exposed to some depth of water or completely submerged, especially in salt water. Precautions should be taken as soon as practicable to halt deterioration and avoid damage before vehicle is driven extensively in regular service. Refer to TM 9-238 for deepwater fording kit information.

*Note.* The following operations will be coordinated with organizational maintenance personnel.

*b. Body and Chassis.* Drain and clean out body, engine, and tool compartment; clean all exposed painted surfaces and touch up paint where necessary. Coat unpainted metal parts with preservative lubricating oil. Lubricate the chassis thoroughly as directed in the lubrication order (LO 9-2320-218-12). Do more than the usual lubrication job, making sure the lubricant is forced into each lubrication point to force out any water present. Lubricate until grease is visible at sealed area.

*c. Engine, Transmission, Transfer Case, and Axles.* Check the lubricant in the engine, transmission, transfer case, and axles. Should there be evidence that water has entered, drain, flush and refill with the correct lubricant; replace engine oil filter with new filter, and remove and clean transmission breather valve assembly.

*d. Wheels and Brakes.* Remove front and rear wheels, wheel drive shafts, and joints and flush all parts, except rubber seals, with a half and half mixture of engine oil (OE-10) and mineral spirits paint thinner. Lubricate as required. Wash all wheel bearings thoroughly with mineral spirits paint thinner, after which

repack, assemble and adjust. Dry out brake linings and clean rust and scum from brake-drum face. Check brake system for presence of water.

*e. Batteries.* Check the batteries for quantity of electrolyte to be sure no water entered through the vent caps. This is of special importance should the materiel have been submerged in salt water.

*f. Electrical Connections.* Check all electrical connections for corrosion, particularly the bayonet-type connectors. Clean as necessary.

*g. Fuel System.* Drain fuel tank of any accumulated water; clean fuel filter and lines, as necessary. If water is found in the air cleaner, clean and refill with oil.

*h. Distributor.* Remove the distributor cap and check to determine if any water has entered the distributor. If water is present, drain, clean, and lubricate as required (LO 9-2320-218-12).

*i. Condensation.* Although most units are sealed, the sudden cooling of the warm interior air upon submersion may cause condensation of moisture within the cases of instruments. A period of exposure to warm air after fording should eliminate this condition. Cases which can be opened may be uncovered and dried.

*j. Salt Water Immersion.* Refer to paragraph 3-14 b (3). Aluminum or magnesium parts may have to be replaced if exposed for extended periods.

### 3-32. Maintenance After Operation on Unusual Terrain

*a. Mud.* Thorough cleaning and lubrication of all parts affected must be accomplished as soon as possible after operation in mud, particularly when a sea of liquid mud has been traversed. Clean radiator fins and interior of engine compartment. Repack wheel bearings, if necessary. Clean, oil, and stow tire chains in vehicle, if supplied.

*b. Sand or Dust.* Clean engine and engine compartment. Touch up all painted surfaces

damaged by sand. Lubricate completely to force out lubricants contaminated by sand or dust. Air cleaners and fuel filters must be cleaned at least daily. Radiator fins should be

cleaned with compressed air daily when operating in dusty terrain. When halted, the engine grilles should be covered to protect the engine against entrance of sand or dust.



CHAPTER 4

MATERIEL USED IN CONJUNCTION WITH MAJOR ITEM

Section I. GENERAL

4-1. Scope

a. This chapter contains operating and maintenance instructions on the special purpose kits provided for the M151, M151A1, M151-A1C and M718 vehicles. As applicable to specific vehicles, these kits are listed in table 3, and include the winterization kit (-65° F), hardtop enclosure kit, door and side curtain kit, hot water heater kit (-25° F), deepwater fording kit, 100-ampere generator (alternator) kit, machinegun mount kit, and M14 rifle mount kit.

Table 3. Vehicle Kits—M151 Series Vehicles

Model	M151	M151A1	M151A1C	M718
Winterization (-65° F)	X	X		
Hardtop enclosure	X	X		
Door and side curtain	X	X		
Hot water heater (-25° F)	X	X	X	X
Deepwater fording	X	X		X
100-ampere generator (alternator)	X	X	X	X
Machinegun mount	X	X		
M14 rifle mount	X	X		

b. These kits, as applicable, are authorized for issue to troops where climatic conditions require additional weather protection for the vehicle and crew; geographical or tactical situations requiring deepwater fording capabilities of more than 21 inches, when greater generator

outputs are required, and for other intended purposes.

4-2. Service Upon Receipt of Materiel

a. Inspection and Cleaning.

(1) *General.* When a vehicle with an installed kit is received, determine if it has been properly prepared for service and that all necessary parts are present. Refer to (2) below for a systematic method of inspection. Inspect all assemblies, subassemblies, and parts for proper assembly and condition. If any exterior surfaces are coated with rust-preventive compound, remove with dry-cleaning solvent or mineral spirits paint thinner.

(2) *Systematic inspection procedure.* In order to follow a system of inspection when a new or reconditioned vehicle with an installed kit is received, perform a preventive-maintenance check as directed in the appropriate tables and paragraphs in this publication.

b. *Correction of Deficiencies.* Ordinary deficiencies disclosed during preliminary inspection and servicing will be corrected by maintenance personnel performing the installation.

Section II. WINTERIZATION KIT (-65° F)

4-3. Description

Note. The key letters shown in parentheses refer to figure 4-1.

a. *General.* The vehicle winterization kit (-65° F) consists of a gasoline burning crew compartment heater of the fresh-air type. It is

equipped with a windshield defroster, battery compartment heater, engine oil-pan heater, manual controls, and automatic controls for heating the vehicle when unattended. Also, furnished in the kit are a standard slave receptacle installed on the right cowl, and adjustable

brush guard cover for regulating engine temperature under arctic conditions. On older model vehicles an engine priming system, and a starter detent control for freeing the starter drive in extreme cold is also provided.

b. *Heater.* The heater (J) is a gasoline-burning unit with a maximum total heat output of 50,000 btu-hr, including exhaust gas heat. The hot exhaust gas can be used for engine oil pan heating, by means of a diverter-heating shroud surrounding the oil pan, or overboard through the separate heater exhaust tube. The heater exhaust accounts for 20,000 btu-hr of heater output. Fuel for the heater is drawn from the vehicle fuel tank by means of a separate fuel pump (M) furnished with the kit and installed in the crew compartment. Air for

combustion is supplied by a blower contained in the heater. The same blower motor is used to circulate heated air inside the vehicle. The heater housing contains a damper and electrical damper actuator which automatically diverts heated air to the battery compartment (H) under control of an electrical thermostat located in the battery compartment. Temperature of the battery compartment is thus automatically regulated at all times when the heater is operating, regardless of other control settings. A "T-handle" control (L) on the heater housing is connected to the heater exhaust diverter valve. Pulling upward on the "T-handle" shifts the flow of exhaust from the overboard pipe system into the engine heating shroud where the hot gases escape between

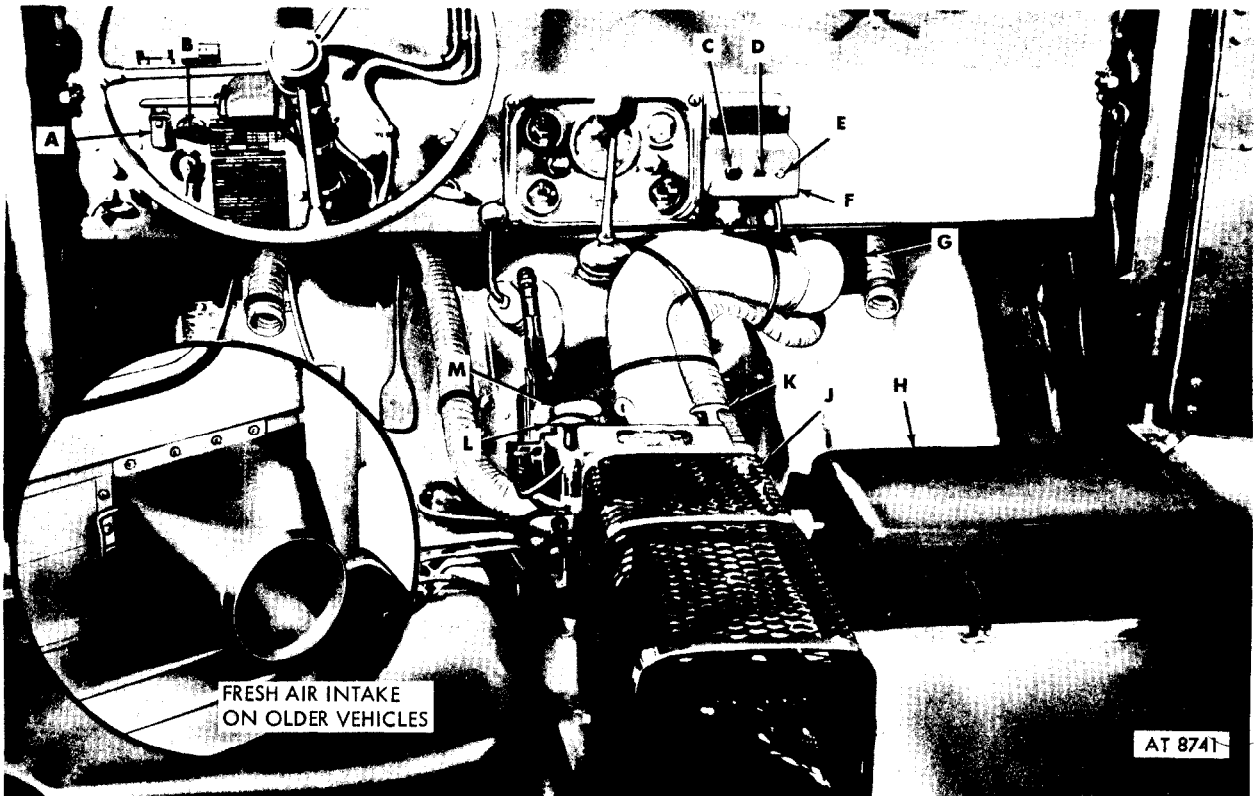

- A—Emergency switch
- B—Defroster control handle
- C—Indicator light
- D—Circuit breaker reset button
- E—Heater control switch
- F—Heater control box

- G—Diverter box
- H—Battery box
- J—Heater guard and heater
- K—Diverter actuator damper control handle
- L—Exhaust diverter control handle
- M—Fuel pump

Figure 4-1. Winterization kit ( $-65^{\circ} F$ ) controls and heater.

the edges of the shroud and the engine oil pan, thus heating the engine oil. Hot air windshield defrosting is controlled by two valves, one located on the heater housing and one located on the dash panel (B).

**Caution:** Preheat vehicle before defrosting windshield.

*c. Electrical Controls.* In order to prevent damage to the heater exchanger unit of the heater, a time-delay mechanism is built into the on-off switch circuit. With this system, the blower continues to run after the switch has been turned off and fuel has ceased to flow to the burner. A temperature-sensitive switch shuts off current to the blower only when the heat exchanger has cooled to the point where warpage of the heat exchanger or other damage cannot occur. The heater control box (F) also contains an overload relay with reset feature (D) to prevent damage to the electrical wiring in case of electrical malfunction. An indicator light (C) is incorporated into the control switch panel. This light serves a double purpose. First, it indicates the burner is in operation, since it is connected to a temperature-sensitive switch. Secondly, the light continues to burn after the heater is shut off and goes out only when the burner is cool enough to ignite safely. An emergency switch (A) is furnished, covered by a safety panel, which turns off the whole heater electrical system without regard to damaging the components, etc. This switch is for use only in event of atomic or chemical warfare attack to prevent the heater from circulating contaminated air inside the vehicle.

*d. Slave Receptacle (Fig. 4-2).* An electrical slave receptacle, located on the right cowl, provides a means of starting the vehicle with a service cable connected to a cold starting aid kit (slave kit).

*e. Brush Guard Cover and Flap (Fig. 4-3).* A cover on the radiator brush guard controls the flow of cold air through the radiator and protects the engine from windblown snow. A flap in the cover can be opened to admit air for engine cooling. When not installed on the brush guard, the cover is stowed behind the

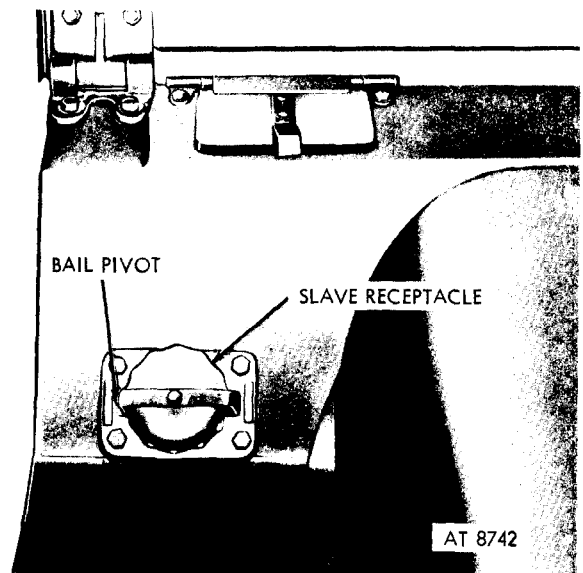

Figure 4-2. Slave receptacle.

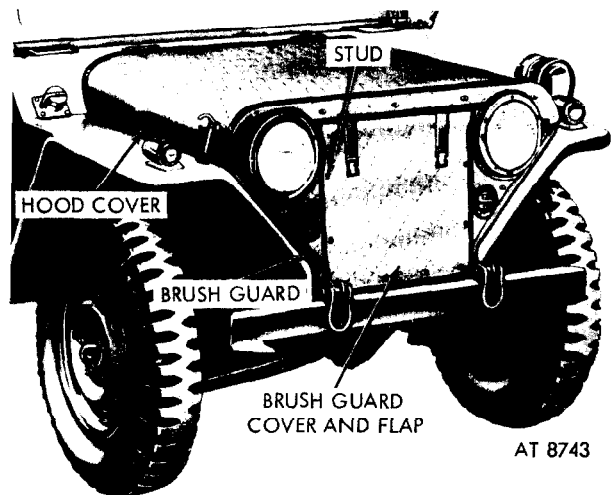

Figure 4-3. Brush guard cover.

rear seat back. An engine hood cover, as illustrated by figure 4-6, is provided to further protect the engine compartment.

*f. Starter Drive Detent and Engine Priming System.* On older model vehicles only, two additional features may be found; an engine priming system and a starter drive detent control. In case of the former, an engine priming pump is installed and connected to priming

PERSONNEL HEATER  
EMERGENCY SWITCH

**WARNING**  
KEEP SWITCH ON↑

SWITCH TO OFF↓  
ONLY IN ATOMIC  
OR GAS ATTACK

**CAUTION**  
PREHEAT VEHICLE  
BEFORE DEFROSTING  
WINDSHIELD

1. TO START POSITION SWITCH TO  
HI OR LO RED LIGHT INDICATES  
HEATER OPERATING

CAUTION DO NOT START IF RED LIGHT  
IS ON

ON-HI

OFF

ON-LO

2. TO STOP RETURN SWITCH TO OFF  
POSITION RED LIGHT WILL STAY  
ON UNTIL HEATER HAS PURGED

PREHEAT TO RESET

20  
RESET

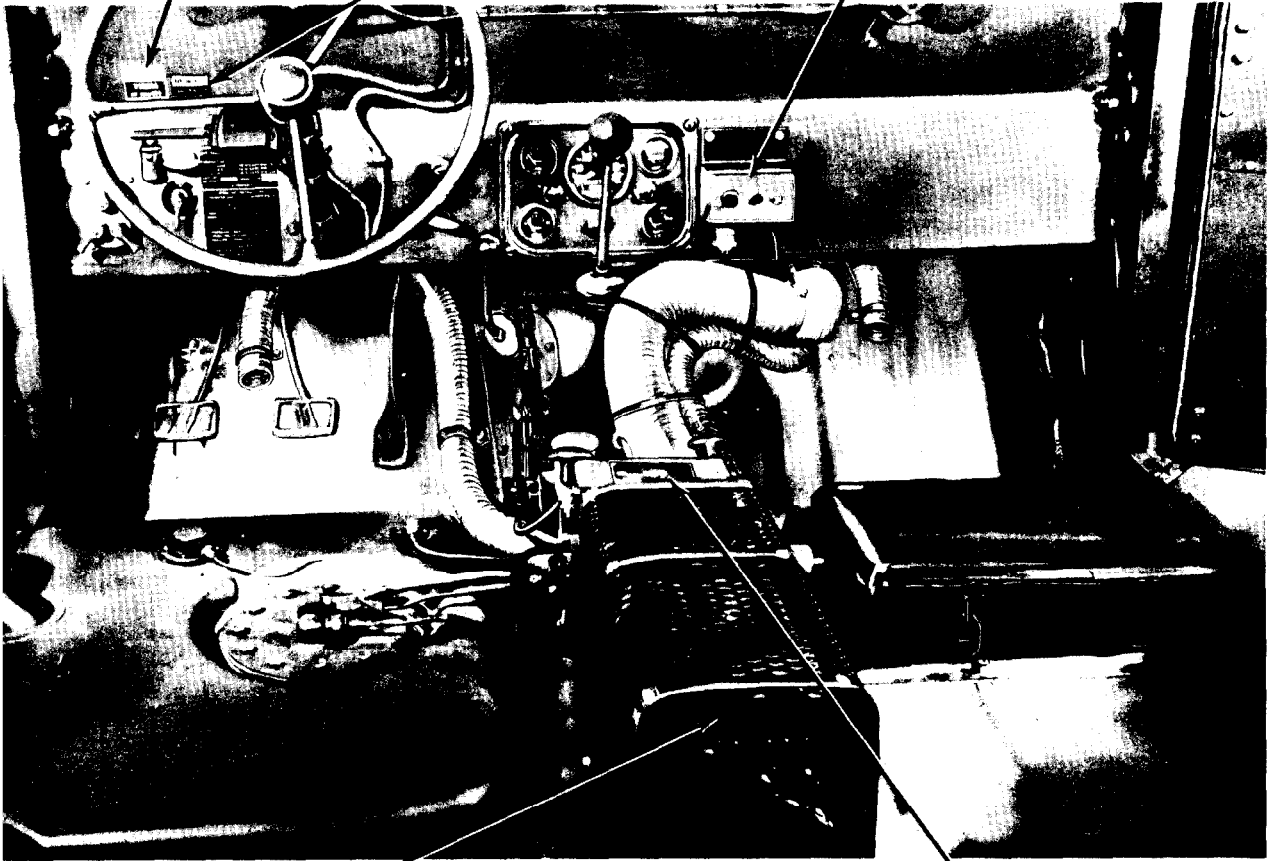

STOCK NO. G254-8720193  
MODEL NO. 1030-D24  
RATING: 30,000 B.T.U./HR.  
SERIAL NO. [REDACTED]  
VOLTS=24    AMPS 6  
STEWART-WARNER CORPORATION  
SOUTH WIND DIVISION  
INDIANAPOLIS, INDIANA, U.S.A.

South Wind "959" DAMPER ACTUATOR

STOCK NO. [REDACTED]  
SERIAL NO. [REDACTED] VOLTS [REDACTED]

PATENTS PENDING  
STEWART-WARNER CORPORATION  
SOUTH WIND DIVISION  
INDIANAPOLIS, INDIANA, U.S.A.

A ↓    ↓ B

Figure 4-4. Name, caution and instruction plates for winterization kit (-65° F).

fittings in the intake manifold. Fuel for the system is taken through a primer pump shutoff valve in a feed line from the heater fuel pump. The priming pump is provided as a means of supplementing the carburetor choke when starting the engine in extreme cold. When a vehicle is equipped with a starter drive detent control, it is hand-operated through a cable and is mounted on the dash panel. It is used to move the starter drive into engagement if extreme cold weather prevents the starter drive from sliding to engage the flywheel. This feature is not incorporated on later model vehicles.

*g. Name, Caution, and Instruction Plates.* The location and details of the heater, name, caution, and instruction plates are shown in figure 4-4.

**4-4. Data**

Model ----- South Wind 1030-D24 or  
 Perfection ES500-24-9  
 Maximum output ----- 50,000 btu/hr  
 Damper actuator model ----- SW959  
 Operating voltage ----- 24v

**4-5. Controls and Instruments**

*Note.* Key letters shown in parentheses refer to figure 4-1.



Figure 4-5. Winterization kit (-65° F) duct assembly installed on later model hardtop vehicles.

*a. General.* This paragraph describes, locates and illustrates the various controls and instruments provided for operation of the M151 and M151A1 utility trucks equipped with  $-65^{\circ}$  F vehicle winterization kits. Controls may be somewhat relocated depending upon when the heater installations were made. Later model hardtop duct installations are shown in figure 4-5.

*b. Emergency Switch (A).* This switch is used to stop both the fuel flow and the blower motor and should be used only in an atomic or gas attack.

*c. Heater Control Switch (E).* This switch controls fuel flow for high and low heat output and stops fuel flow in the "OFF" position.

*d. Circuit Breaker Reset Button (D)* This button is used to reset the circuit breaker in the heater electrical system.

*e. Defroster Control Handle (B).* Heated air to the windshield glass is controlled by this handle.

**Caution:** Too much heat will crack the windshield. Control the defroster handle carefully.

*f. Diverter Actuator Damper Control Handle (K).* This handle is used to control air flow to the defroster or crew compartment by positioning a damper in the diverter box.

*g. Exhaust Diverter Control Handle (L).* This handle is used to divert heater exhaust gas to a shroud on the engine oil pan, when oil pan heating is desired.

*h. Indicator Light (C).* This light indicates that combustion is occurring in the heater. The light will go out during the heater "OFF" cycle.

*i. Slave Receptacle.* The slave receptacle, (fig. 4-2) located on the right front cowl panel, enables the vehicle to accept auxiliary electrical power through a service cable. The receptacle has an index slot and the female connectors are located off-center so that connections will be made correctly.

*j. Brush Guard Cover.* The cover (fig. 4-3) is mounted on the radiator brush guard with

snap fasteners. The cover must be installed whenever the vehicle is at halt and wind-blown snow could be driven into the engine compartment, or when extremely cold winds would cold soak the engine and make starting difficult. The flap should be positioned to maintain normal engine temperature when the engine is operating. When not in use, the brush guard cover is stowed behind the rear seat back.

*k. Primer Pump.* On older model vehicles, a primer pump will be found. Operation of the pump sprays fuel into the intake manifold to assist the regular choke in cold-weather starting. A primer pump fuel shutoff valve was provided in the primer pump feed line and located on the transmission tunnel panel near the transfer shift lever. This valve should be kept closed except when priming the engine when found on applicable vehicles.

#### 4-6. Operating Instructions

**Caution:** Vehicles equipped with this kit may not be used for deepwater fording.

*Note.* Key letters shown in parentheses above and below refer to figure 4-1.

##### *a. Vehicle in Use.*

- (1) *Starting heater.* Move control switch (E) to "ON-HI" position. Indicator light (C) will come on within two minutes, indicating normal operation. If heater fails to start within two minutes, move the control switch to the "OFF" position and wait three minutes before attempting to restart.
- (2) *Heating engine oil pan.* To heat the engine oil pan, pull exhaust diverter handle (L) up. When engine temperature reaches normal range, push this handle down to its normal operating position.

**Warning:** Accumulations of oil or grease on the oil pan will create a serious fire hazard when heating the oil pan. Clean as required.

- (3) *Defrosting.* Pull out diverter actuator damper control handle (K). This positions the damper for maximum air to the defroster diverter. Pull out defroster control handle (B) slightly

and turn to "ON" position for windshield defrosting.

**Caution:** Too much heat will crack the windshield. Control the defroster handle (B) carefully by operating it manually.

- (4) *Control switch.* When all areas of the vehicle have warmed sufficiently, the heater control switch (E) may be snapped down to the "ON-LO" position if desired.
- (5) *Stopping heater.* Stop heater by moving the control switch to the "OFF" position. The indicator lamp will stay on, and the blower will continue to deliver air until the combustion chamber has purged of burning gas and has cooled. Cooling will normally require from two to three minutes.

*Note.* Wait until the indicator light goes out before attempting to restart heater.

**Caution:** Do not stop the heater by pulling the reset button of the circuit breaker or by moving the emergency switch to "OFF" position.

- (6) *Battery heater.* Battery box heating (H) is automatically controlled. A thermostat in the box controls a damper door actuator at the right hand side of the diverter box.
- (7) *Slave receptacle.* (Refer to fig. 4-2.) Turn cap counterclockwise and lift clear of receptacle. Insert service cable connector into receptacle socket. Be sure arrow and indexing dot on service cable connector are aligned with slot in receptacle. Refer to TM 9-207 for proper use of cold starting aid kit (slave kit).

*b. Heater Operated Unattended.* Engine running or not running.

- (1) Pull exhaust diverter control handle (L) up to provide heat to engine oil pan.

**Caution:** Accumulations of oil or grease on the oil pan will create a serious fire hazard when heating the oil pan. Clean as required.

- (2) Position diverter actuator damper

control handle (K) toward the exhaust diverter control handle (L). This positions the damper for maximum air to the defroster diverter.

- (3) Position defroster control handle (B) to "ON" for windshield defrosting.

**Caution:** When the windshield glass is heavily coated with, ice, snow, or frost and the temperature is near or below  $-25^{\circ}$  F, heat from the heater distributor should be directed in greater proportion into the crew compartment than onto the cold windshield. This is necessary to avoid damaging the glass by sudden extreme uneven temperature changes that will occur when the hot air strikes the cold glass directly.

- (4) Position the control switch "ON-LO" or "ON-HI" as required. It should be remembered that long periods of blower use without the generator being driven by the engine will discharge the battery.
- (5) Position fresh air intake to allow a greater proportion of fresh air than recirculated air to enter the heater.

#### 4-7. Preventive Maintenance

Refer to table 4 and perform the daily preventive-maintenance services following the numerical order given in the interval columns for vehicles equipped with the  $-65^{\circ}$  F winterization kit.

#### 4-8. Lubrication

Lubrication of equipment installed with the kit consists of "oil can points" which require sparing use of lubricating oil (OES). Every 1000 miles or semiannually, whichever occurs first, lubricate all pivot points of starter detent in vehicles so equipped, bail pivot and cap threads of slave receptacle, pivot points of all heater air controls and the exhaust diverter control cable. The heater blower motor bearings do not require lubrication.

#### 4-9. Troubleshooting

For troubleshooting the winterization kit ( $-65^{\circ}$  F) refer to table 5.

Table 4. Operator's Daily Preventive-Maintenance Services for Winterization Kit (-65° F) Equipped Vehicle

Interval			Procedure
Before Operation	During Operation	After Operation	
1		16	Clean heater fresh air intake screen.
2		15	Inspect brush guard cover to make sure that all snap fasteners and straps are secure. If not in use, check to be sure cover is stowed behind rear seat back.
3		14	Inspect engine-mounted parts for breakage, wear, and loose screws. Report any deficiency to organizational maintenance. Pay special attention to oil pan for leaks or accumulated oil or grease.
4		13	Tighten slave receptacle cap if necessary.

Interval			Procedure
Before Operation	During Operation	After Operation	
5		12	Check operation of the starter drive detent control and cable, if applicable.
6		11	Inspect hose clamps, electrical connectors, mounting and attaching screws, and controls as necessary.
7		10	Fill fuel tank to minimize condensate water accumulation.
	8		Observe heater operation and quantity of exhaust smoke for slight changes from normal operation. Report unusual conditions to organizational maintenance personnel.
		9	Remove heater fuel filter and drain of any water using special tool wrench #10950836 provided with the winterization kit to prevent fuel lines from freezing.

Table 5. Troubleshooting—Winterization Kit (-65° F)

Malfunction	Probable causes	Corrective action
1. No air output.	a. Emergency switch off. b. Circuit breaker open. c. Defective electrical circuit.	a. Snap switch to "ON" position. b. Press breaker to reset. c. Notify organizational maintenance.
2. No heat output.	a. Fuel tank empty. b. Fuel tank filler cap valve closed. c. Ice in fuel system. d. Defective component.	a. Fill tank. b. Open valve. c. Notify organizational maintenance. d. Notify organizational maintenance.
3. Indicator light always on.		Pull circuit breaker reset button and notify organizational maintenance.
4. Indicator light inoperative.	a. Defective lamp.	a. Use press-to-test feature. Replace lamp if defective.
5. Heater operates several minutes, then stops.	b. Defective wiring or lamp holder. Defective flame detector switch.	b. Notify organizational maintenance. Notify organizational maintenance.
6. Inadequate windshield defrosting.	a. Diverter damper doors closed. b. Hose not connected to nozzle.	a. Open damper doors (par 4-6). b. Position hose on nozzle clamp securely. Notify organizational maintenance.
7. Battery compartment too hot or too cold.	Defective thermostate diverter actuator wiring.	
8. Inadequate heat output.	a. Fuel pump screen restricted. b. Ice crystals in fuel. c. Defective component.	a. Notify organizational maintenance. b. Notify organizational maintenance. c. Notify organizational maintenance.
9. Excessive smoke from heater exhaust.	a. Restricted screen on air intake. b. Defective component.	a. Clean intake air screen. b. Notify organizational maintenance.
10. Overheating.	Defective overheat switch.	Notify organizational maintenance.
11. Gasoline odor.	Fuel leak.	Notify organizational maintenance.
12. Burned gasoline odor.	Defective heat exchanger.	Notify organizational maintenance.



### Section III. HARDTOP ENCLOSURE KIT

#### 4-10. Description

The hardtop body installation for M151 and M151A1 vehicles is a metal and glass enclosure designed for extreme cold-weather operation under arctic conditions. It is fabricated of aluminum panels, including the doors, and is assembled with common bolts, nuts, and screws. The enclosure is, in turn, bolted and screwed to the vehicle body with common fastening devices. The closure affords crew protection

from the effects of arctic windchill, and is usually supplied in combination with the  $-65^{\circ}\text{F}$  winterization kit. The body is equipped with four fixed windows, including rear and side glasses, and two doors having four sliding divided window panes. Weather-sealing gaskets are provided at all panel joints, door openings, window openings, and body mounting surfaces. As illustrated in figure 4-6, a hood cover, brush guard cover and receptacle are provided with the hardtop enclosure kit.

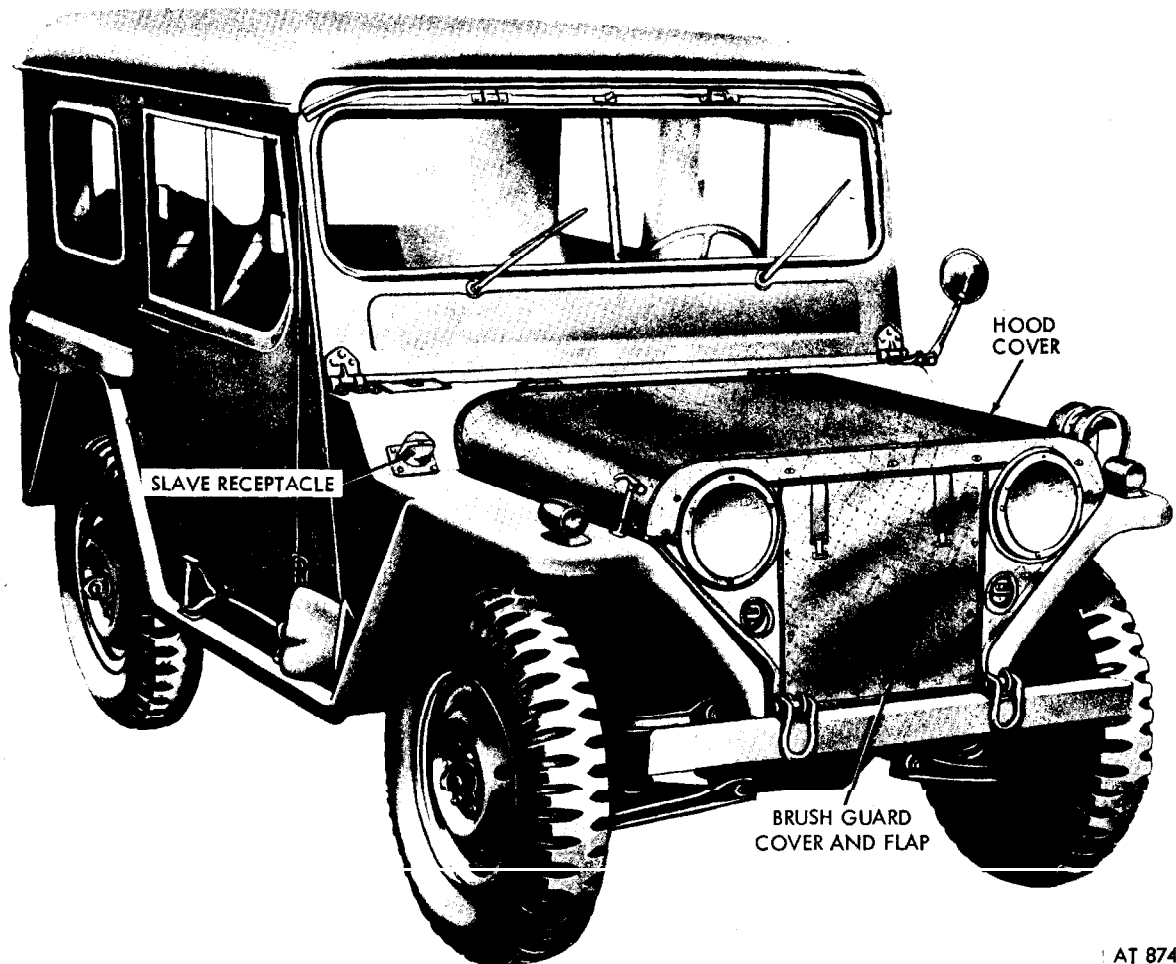

AT 8745

Figure 4-6. Hardtop enclosure kit, complete with engine hood cover and brush guard cover installed.

**4-11. Data**

Material ----- Aluminum alloy (6061-T4)  
 Glass specification --- Laminated safety,  
 class 1, grade C  
 Glass thickness ----- 0.25 in.

**4-12. Controls**

The enclosure (fig. 4-6) is constructed of aluminum and should not be subjected to abusive handling. Door handles and latches are provided for both doors. The windows in the doors can be opened by sliding the windows fore and aft.

**4-13. Daily Preventive Maintenance**

Refer to table 6 and perform the services following the numerical order in the interval columns.

Table 6. Operator's Daily Preventive-Maintenance Services for Hardtop Enclosure Equipped Vehicle

Interval			Procedure
Before Operation	During Operation	After Operation	
1		12	Inspect exterior body panels for scratches, dents or abrasions which might affect corrosion resistance or protective qualities of body.
2		11	Inspect doors for ease of operation, latching and weather-sealing.

Interval			Procedure
Before Operation	During Operation	After Operation	
3		10	Inspect all sealing gaskets for air leaks.
4		9	Inspect glass for broken or chipped panes.
5		8	Check sliding windows for ease of operation and weather-sealing.
6		7	Inspect all bolts, nuts, and attaching parts for security of attachment and tightness. Inspect interior body panels for scratches, dents or abrasion.

**4-14. Lubrication**

a. *Hinges.* Lubricate door hinges lightly with lubricating oil (OE or OES) each time the vehicle is lubricated.

b. *Latch Strikers.* Lightly wipe door latches and door latch strikers with a rag saturated in lubricating oil (OE or OES) each time the vehicle is lubricated.

c. *Internal Latch Parts.* Do not lubricate internal latch parts as lubricant may retard operation under arctic conditions.

**4-15. Troubleshooting**

For troubleshooting hardtop enclosure, refer to table 7.

Table 7. Troubleshooting—Hardtop Enclosure

Malfunction	Probable causes	Corrective action
1. Door not latching.	Broken or sticking latch.	Lubricate outside of latch. Notify organizational maintenance if repair is required.
2. Excessive rattles.	a. Loose parts or joints. b. Worn or damaged glass channel.	a. Tighten. Notify organizational maintenance. b. Notify organizational maintenance.
3. Sticking door glass.	Worn or damaged glass channel.	Notify organizational maintenance.
4. Excessive air leaks.	a. Loose parts or joints. b. Worn or damaged glass channel.	a. Tighten. Notify organizational maintenance. b. Notify organizational maintenance.
5. Water leaks.	a. Loose parts or joints. b. Worn or damaged glass channel.	a. Tighten. Notify organizational maintenance. b. Notify organizational maintenance.
6. Cracked glass.	Worn or damaged glass channel.	Notify organizational maintenance.

## Section IV. DOOR AND SIDE CURTAIN KIT

### 4-16. Description

The canvas door and side curtain kit for M151 and M151A1 models provides an enclosure for protection from the elements not as severe as those applicable to the hardtop enclosure kit. It will be found located under the rear seat along with the soft top as illustrated by figures 2-18, 2-19. The kit (fig. 4-7) consists of a left hand door and side curtain, a right hand door and side curtain, door center rods, rod assemblies and miscellaneous hardware required to install the doors and side curtains.

ware required to install the doors and side curtains.

### 4-17. Operating Instructions

a. Instructions for the installation, removal, stowage, and operating the canvas door and side curtain kit, follow the preliminary procedure for removal of top from stowage, as described in paragraph 2-17 and illustrated in figures 2-16 through 2-27. The top must be erected to install doors and sides.

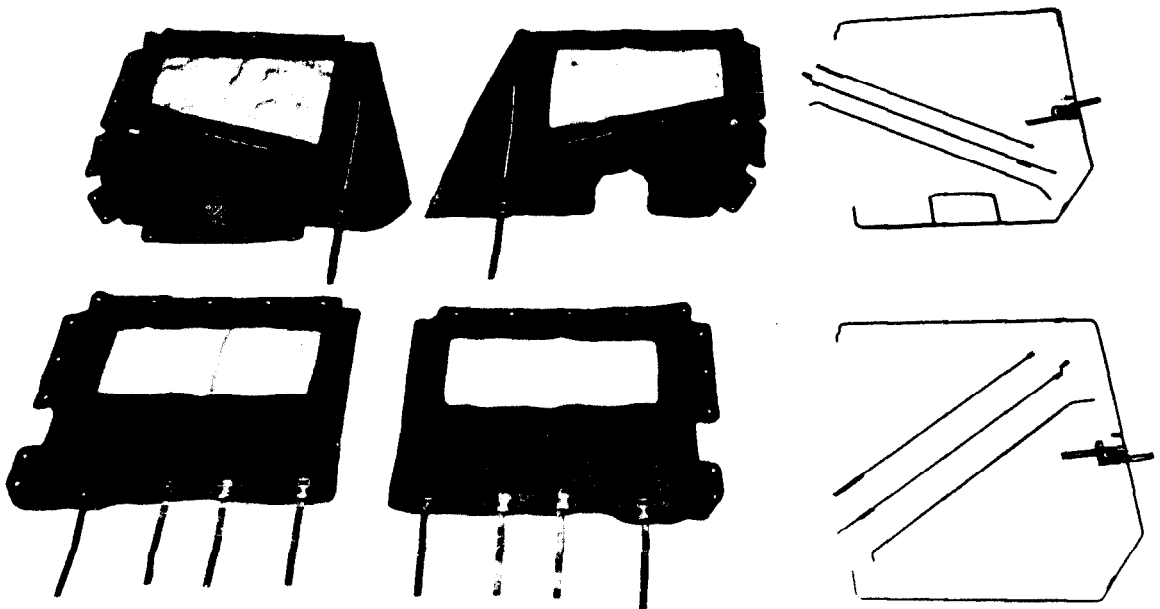

AT 8746

Figure 4-7. Canvas door and side curtain kit.

b. Select the left hand door canvas and supporting rods as illustrated by figure 4-8.

c. Lay the door canvas on a flat surface and assemble the door as illustrated by figure 4-9. Secure all button fasteners.

d. Assemble the right door from canvas and metal rods provided in the same fashion that the left door was assembled and secure all button fasteners.

e. Holding the left door above the vehicle as illustrated by figure 4-10, start the beaded edge of door canvas into the slot on top of the windshield post and slide it the full length of the slot.

f. Slip the bottom end of vertical rod assembly located on forward edge of door into the bracket on vehicle body, as illustrated by figure 4-11.

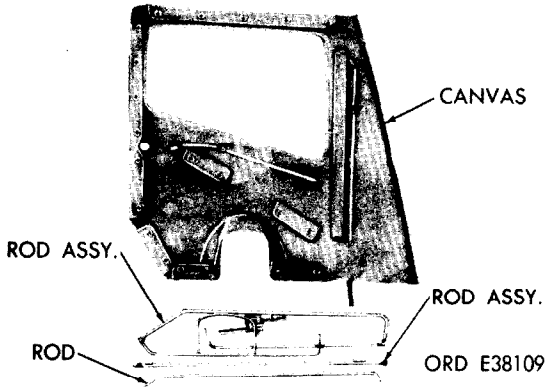

Figure 4-8. Left door canvas, rod assemblies, and rod.

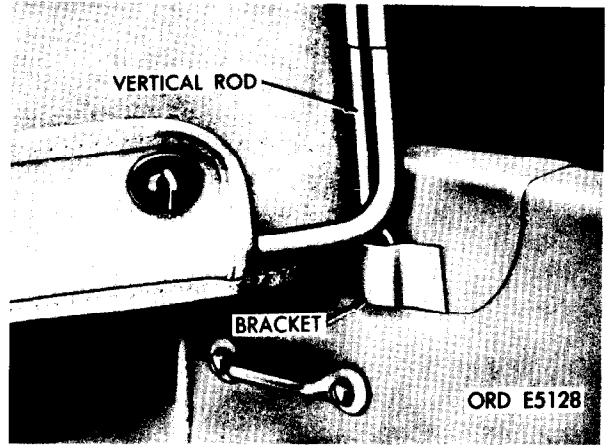

Figure 4-11. Fitting the rods to the body.

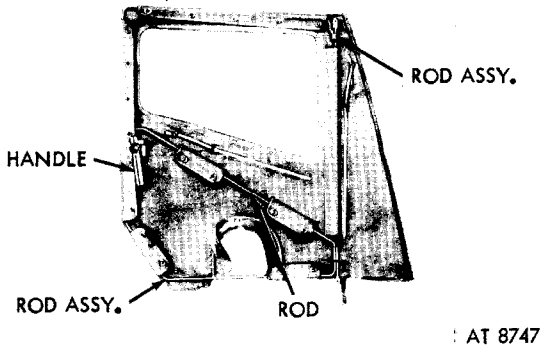

Figure 4-9. Left door assembled.

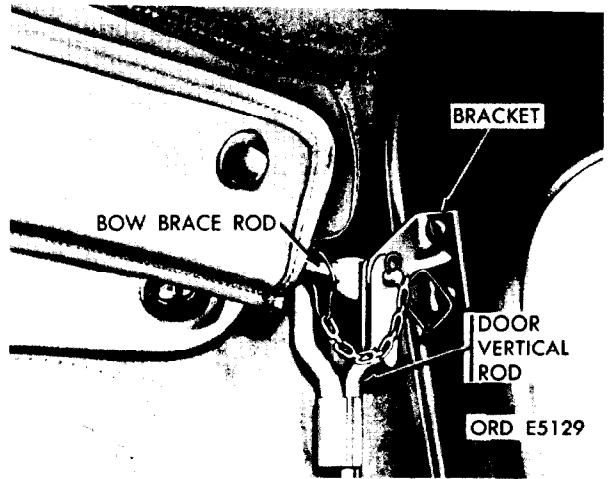

Figure 4-12. Connecting the rods.

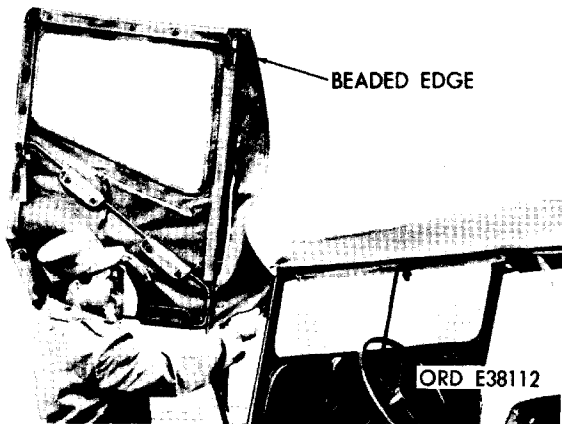

Figure 4-10. Assembling the door to the body.

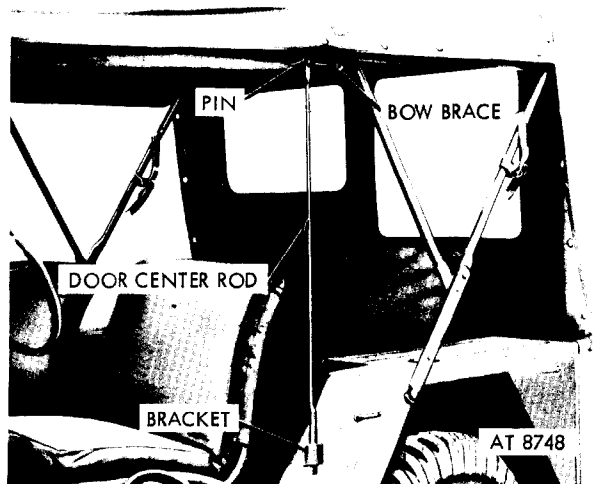

Figure 4-13. Installing the door center rods.

tical rod over bracket on windshield and replace bow brace rod (fig. 4-12).

*h.* Follow the same procedure for installing the right door.

*i.* Install door center rods in brackets on body of the vehicle with pin on top, as illustrated by figure 4-13.

*j.* Select the left side curtain, attach it to canvas top by button fasteners, as illustrated in figure 4-14, starting at the back top corner, working forward, and then down the back.

*k.* Wrap the curtain flap at forward edge around door center rod and secure with button fasteners (fig. 4-15). Secure straps at bottom edge of curtain.

*l.* Repeat the procedure on the right side of vehicle. A view of the assembled door and curtain kit is illustrated in figure 4-16.

*m.* To remove and stow the canvas door and side curtain kit, reverse the procedures given above.

#### 4-18. Preventive Maintenance

Materiel inactive for long periods in hot humid weather is subjected to rapid rusting and accumulation of fungus growth. Make frequent inspections; clean, dry and lubricate to prevent excessive deterioration. Follow the same procedure for lubricating door latches, hinges and strikers as described in paragraph 4-14. In less severe weather conditions inspections need not be conducted as frequently. Canvas parts should be kept in a clean and dry condition and treated in accordance with existing maintenance directions. Rips and tears should be repaired before they are permitted to grow larger.

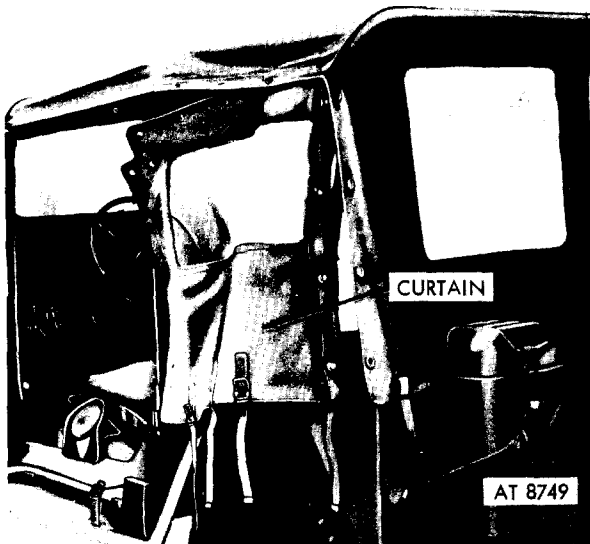

Figure 4-14. Installing left side curtain.

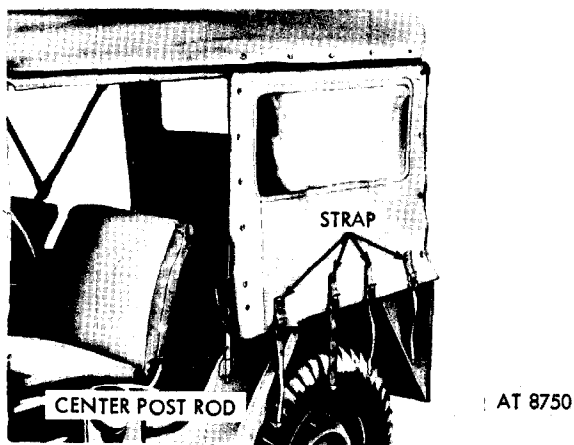
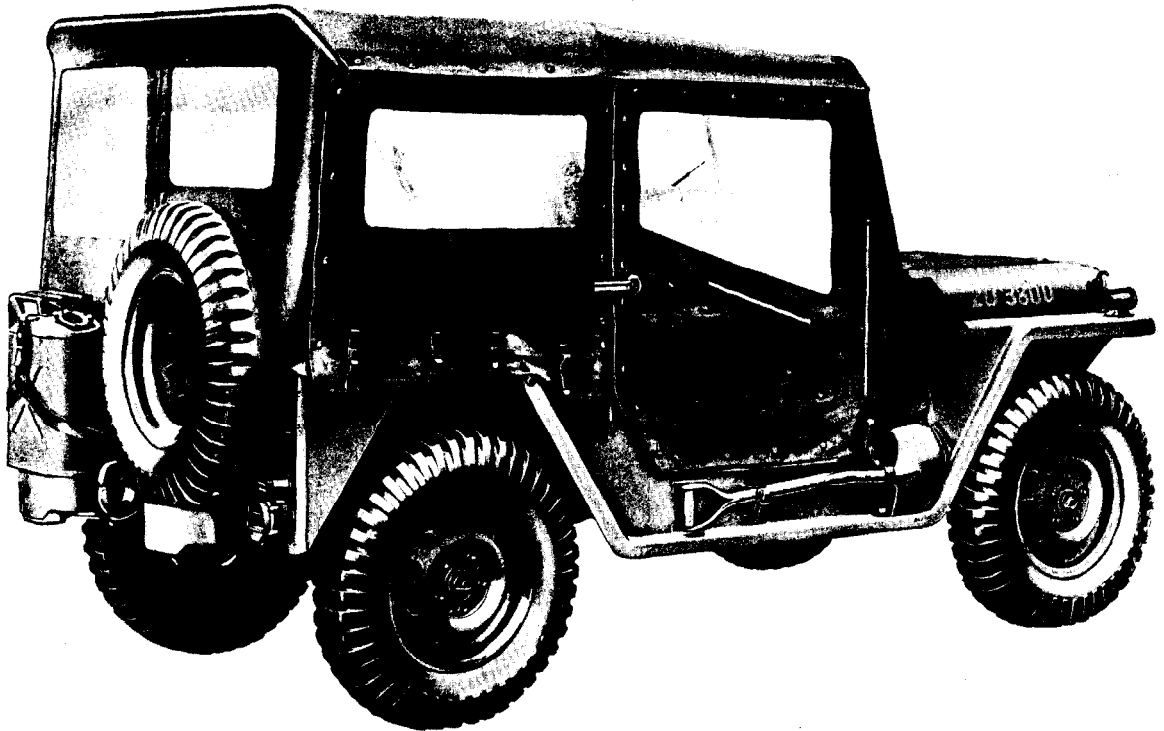

Figure 4-15. Fastening left side curtain.

*g.* Disconnect the bow brace rod at the windshield end. Slip fitting on the end of door, ver-



AT 8751

*Figure 4-16. Canvas top, doors and sides installed.*

## **Section V. HOT WATER HEATER KIT (-25° F)**

### **4-19. General**

*a. General.* The hot water heater kit (-25° F) includes a crew compartment heater with defroster, a slave receptacle, a brush guard cover, and on older models, a starter drive detent. The kit is for use on vehicles operated in areas where the normal temperature during the coldest part of the year is above -25° F. Vehicles with a canvas passenger compartment enclosure may be equipped with this heater. Vehicles equipped with this kit may be used for deepwater fording when the deepwater fording kit is installed.

*b. Hot Water Heater.* The hot water heater

obtains heat from the engine coolant. The heater is connected to the engine cooling system by suitable fittings and hoses and is mounted under the dash panel below the cowl ventilator. Fresh outside air is drawn into the heater through the cowl ventilator, in later models, and then through the heater core by a heavy-duty squirrel cage-type blower. The air heated by the core is distributed to the vehicle interior and windshield glass through hoses and ducts. When fresh air operation is not desired, air from within the vehicle is drawn through openings in the adapter under the cowl ventilator and recirculated through the heater core. Shutoff cocks on the water

pump and cylinder head are provided to stop the circulation of coolant through the heater system during warm weather operation.

c. *Slave Receptacle.* An electrical slave receptacle located on the right cowl provides a means of starting the vehicle with a service cable connected to a cold starting aid kit (slave kit).

d. *Starter Drive Detent Control on Earlier Model Vehicles.* An engaging detent for the starter Bendix drive is mounted on the engine flywheel housing and operated by a control lo-

cated on the dash panel. In extreme cold, the starter drive gear may not slide to engage the engine flywheel. Under these conditions the detent control will free the gear for normal starting engagement. This provision is not incorporated in later model vehicles.

e. *Brush Guard Cover.* The function of the brush guard cover is described in paragraph 4-5 j and illustrated in figures 4-3, 4-6.

f. *Name, Caution, and Instruction Plates.* Location and details of the plates are shown in figure 4-17.

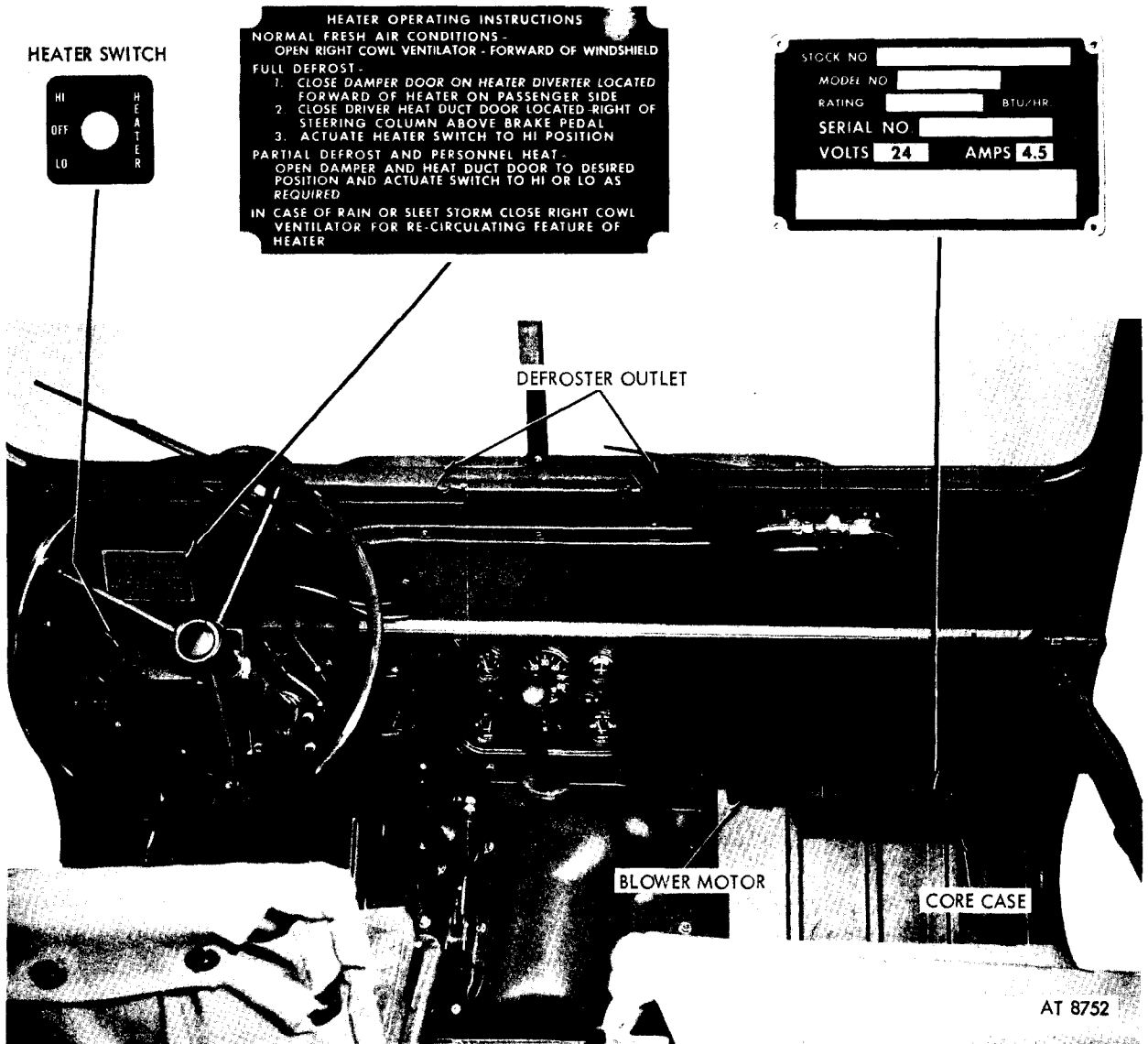

Figure 4-17. Caution and instruction plates for (-25° F) hot water heater.

**4-20. Data**

Model numbers ----- 96906-51326-1  
 (and 8712418)  
 Water capacity ----- 1 qt  
 Blower electrical requirements ---- 24 volts  
 Output, rated ----- 30,000 btu

**4-21. Controls**

*Note.* The key letters shown in parentheses refer to model 96906-51326-1 heater shown in the insert of figure 4-18.

*a. General.* This paragraph describes, locates and illustrates the various controls provided

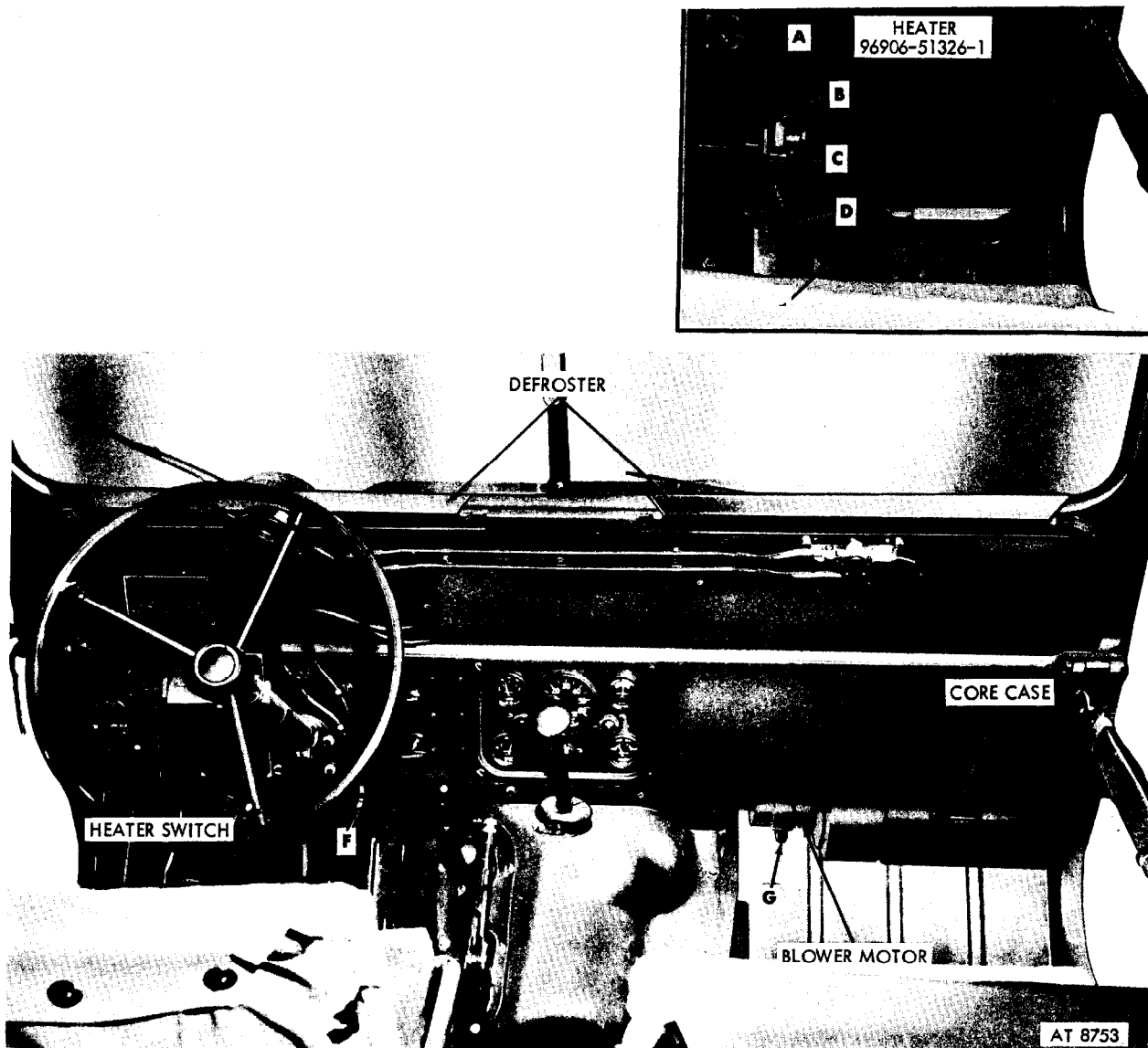

A—Older on-off switch installations  
 B—Driver heat lever  
 C—Defroster lever

D—Auxiliary heat lever  
 E—Diverter box  
 F—G—Model 8712418 diverter controls

*Figure 4-18. Hot water heater (-25° F)-(8712418) installed. Insert illustrates model 96906-51326-1 hot water heater (-25° F) installed.*



for proper operation of the hot water heater (-25° F) kit.

*b. Defroster.* The defroster lever (C) is the lower lever on the left side of the diverter box (E). It provides a means of controlling the air flow through ducts to the windshield glass. An outward pull is required to release the lever. Rotate lever to forward detent for defrosting or to rear detent for the closed position.

*c. Driver Heat Lever.* The driver heat lever (B) is located above the defroster lever on the left side of the diverter box. It provides a means of directing heated air to the driver through a duct connected to the diverter box. An outward pull is required to release the lever from the detents. Rotate lever to forward detent for driver heat or to rear detent for closed position.

*d. Auxiliary Heat Door.* A lever (D) located on the bottom of the diverter box can manually open the door to provide additional heat to crew members.

*e. Heater Switch.* A three-position ("HI," "OFF," and "LO") heater switch (A) located to the right of the instrument cluster on the dash panel in older installations controls the blower motor speed. With the switch in "LO" position the blower motor speed is slower and heater air output is reduced.



Figure 4-19. Heater shutoff cocks.

*f. Shutoff Cocks.* Two shutoff cocks are provided to stop the circulation of engine coolant through the heater core. The shutoffs are located at the front of the engine; one on the water pump and the other on the cylinder head. To allow circulation of coolant through the heater core, turn both shutoff cocks counterclockwise, fully open, (fig. 4-19).

*g. Cowl Ventilator.* The heater ventilator (fig. 4-20) is located on the right hand side of the cowl top panel. When pulled up to the stop, fresh outside air is admitted to the heater. When the ventilator is pushed down to the cowl top panel, air from the crew compartment is reheated and recirculated. The ventilator is accessible from outside the crew compartment.

**Warning:** Do not change the ventilator position with the vehicle in motion.



Figure 4-20. Cowl ventilator.

*h. Slave Receptacle.* Refer to paragraph 4-3 d, figure 4-2.

*i. Brush Guard Cover.* Refer to paragraph 4-3 e, figures 4-3, 4-6.

**4-22. Operating Instructions**

*Note.* The key letters shown in parentheses refer to figure 4-18.

*a. General.* This paragraph contains instruc-

tions for the mechanical steps necessary to operate the hot water heater (-25° F) kit. Each operator should familiarize himself thoroughly with these instructions prior to any attempt to operate the equipment. Failure to observe these instructions may result in hazardous operation, unsatisfactory performance, or premature failure of the equipment.

*Note.* Open the cowl ventilator for fresh air operation of heater.

*b. Defrost.* For maximum defrosting, pull the cowl ventilator (fig. 4-20) up to full open position; move the defroster lever (C) to the rear detent (open) and the driver heat lever (B) to the forward detent (closed). Move heater switch (A) to the "HI" position.

*c. Driver Heat.* For maximum driver heat, pull the cowl ventilator up to full open position; move the driver heat lever (B) to the rear detent (open) and the defroster lever (C) to the forward detent (closed). Move heater switch (A) to the "HI" position.

*d. Crew Heat.* For maximum crew heat, pull the cowl ventilator up to full open position; move the driver heat and defroster levers to the forward detents, and open the dump door (D) on the bottom of the diverter box (E). Move heater switch to "HI" position.

*e. Combinations.* For combinations of defrosting, driver area heating and crew compartment heating, move the appropriate levers to the middle position.

*Note.* With the vehicle in motion the heater may be operated with the blower switch in the "OFF" position, due to air forced through the cowl ventilator by vehicle motion. When dust, exhaust fumes or water (rain or melted snow) are encountered, close the cowl ventilator and the air in the crew compartment will be recirculated and reheated. Heater model 8712418 has a driver heat diverter control, indicated F on figure 4-18, mounted under the dash panel on the steering column, and a crew heat diverter control, indicated G on figure 4-18, beneath the blower motor. The heater on-off switch is mounted on the left of the dash panel inside of the right hand side of the panel.

*f. Starter Drive Detent Control on Older Vehicles.* When available on older vehicles, if the starter motor spins free and will not engage the flywheel when attempting to start

the engine, release starter switch and wait 5 seconds to allow the starter motor to stop turning. Pull starter drive detent control handle (A) and while holding control out, depress starter switch. Release control as soon as starter drive engages flywheel.

**Caution:** Do not hold the detent control out after the starter has engaged or damage to the starter drive detent may result. This caution applies only to those older vehicles with starter drive detent controls.

*g. Slave Receptacle.* (Refer to fig. 4-2.) Turn cap counterclockwise and lift clear of receptacle. Insert service cable connector into receptacle socket. Be sure arrow and indexing dot on service cable connector are aligned with slot in receptacle. Refer to TM 9-207 for proper use of cold starting aid kit (slave kit).

*h. Shutoff Cocks.* (Refer to fig. 4-19.) To open shutoff cock, turn counterclockwise; to close shutoff cock, turn clockwise.

*Note.* Both shutoff cocks must be fully open to allow circulation of coolant through the heater for maximum heat.

**Caution:** If heater or heater hoses leak and repairs cannot be made at the time, close both shutoff cocks and add coolant to engine cooling system as necessary. Report leak as soon as possible.

#### 4-23. Preventive Maintenance

Refer to table 8 and perform the services following the numerical order given in the interval columns.

#### 4-24. Lubrication

Lubrication of the hot water kit components consists of "oil can points" which require sparing use of lubricating oil (OES). Every 1,000 miles or semiannually, lubricate all pivot points of starter detent, bail pivot and cap threads of slave receptacle, pivot points of driver heat and defroster levers, and the auxiliary heat door hinge. The heater blower motor does not require lubrication.

#### 4-25. Troubleshooting

For troubleshooting the -25° F heater, refer to table 9.

Table 8. Operator's Daily Preventive-Maintenance Services for Hot Water Heater (-25° F) Equipped Vehicles

Interval			Procedure
Before Operation	During Operation	After Operation	
1		14	Cowl panel ventilator. Pull cowl ventilator up to open position. Inspect wire mesh screen for obstructions (par 4-21g, fig 4-20).
2		13	Brush guard cover: Inspect to be sure cover is properly installed and that all snap fasteners and straps are in place. If cover is not installed on brush guard, check to be sure cover is stowed behind rear seat back.
3		12	Hoses, clamps: Open hood and inspect for leaks around hoses (par 4-22). Check hoses and clamps for condition.

Interval			Procedure
Before Operation	During Operation	After Operation	
4		11	Slave receptacle: Check to be sure cap is tight. Check cable connections at battery connector and ground (firewall).
5		10	Starter drive detent on older model vehicles: Pull control handle to be sure detent operates properly (par 4-22f).
6		9	Heater core: Inspect for leaks around heater core (par 4-22h).
	7		Defroster operation: Position controls for maximum defrost (par 4-22b). Determine if defrosting air is available at the windshield glass.
	8		Driver heat: Position controls for maximum driver heat (par 4-22c). Determine if air is available at discharge area.

Table 9. Troubleshooting—Hot Water Heater (-25° F)

Malfunction	Probable causes	Corrective action
1. Cool or cold air at outlets.	<ul style="list-style-type: none"> <li>a. Engine not fully warmed up.</li> <li>b. Engine temperature below normal after proper warm up.</li> <li>c. Shutoff cocks partially or fully closed.</li> <li>d. Extreme cold weather.</li> <li>e. Other causes.</li> </ul>	<ul style="list-style-type: none"> <li>a. Wait until engine warms up.</li> <li>b. Notify organizational maintenance.</li> <li>c. Open shutoff cocks fully (par 4-22 h). <b>Caution:</b> Do not use tools or apply excessive force on shutoff cocks.</li> <li>d. Install brush guard cover.</li> <li>e. Notify organizational maintenance.</li> </ul>
2. Blower motor inoperative.	<ul style="list-style-type: none"> <li>a. Lead wire disconnected at heater switch.</li> <li>b. Other causes.</li> </ul>	<ul style="list-style-type: none"> <li>a. Connect lead to switch.</li> <li>b. Notify organizational maintenance.</li> </ul>
3. No air at defroster or driver heat outlet with blower motor operating.	<ul style="list-style-type: none"> <li>a. Control level improperly positioned.</li> <li>b. Hose disconnected at nozzle or diverter box.</li> <li>c. Other causes.</li> </ul>	<ul style="list-style-type: none"> <li>a. Correctly position lever (par 4-21).</li> <li>b. Reconnect hose.</li> <li>c. Notify organizational maintenance.</li> </ul>

**Section VI. DEEPWATER FORDING KIT**

**4-26. Description**

a. *General.* This kit consists of necessary tubes, hoses, fittings and valves to enable the power plant, fuel system and brake hydraulic system to function when submerged in up to five feet of water during fording operations. An intake tube is installed to furnish carbure-

tor intake air. This tube also functions as a means of ventilating the brake hydraulic system, engine crankcase, ignition system and fuel tank. An exhaust tube is furnished to carry the exhaust above water level. A ventilation control valve mounted on the instrument panel operates the fording ventilation system.

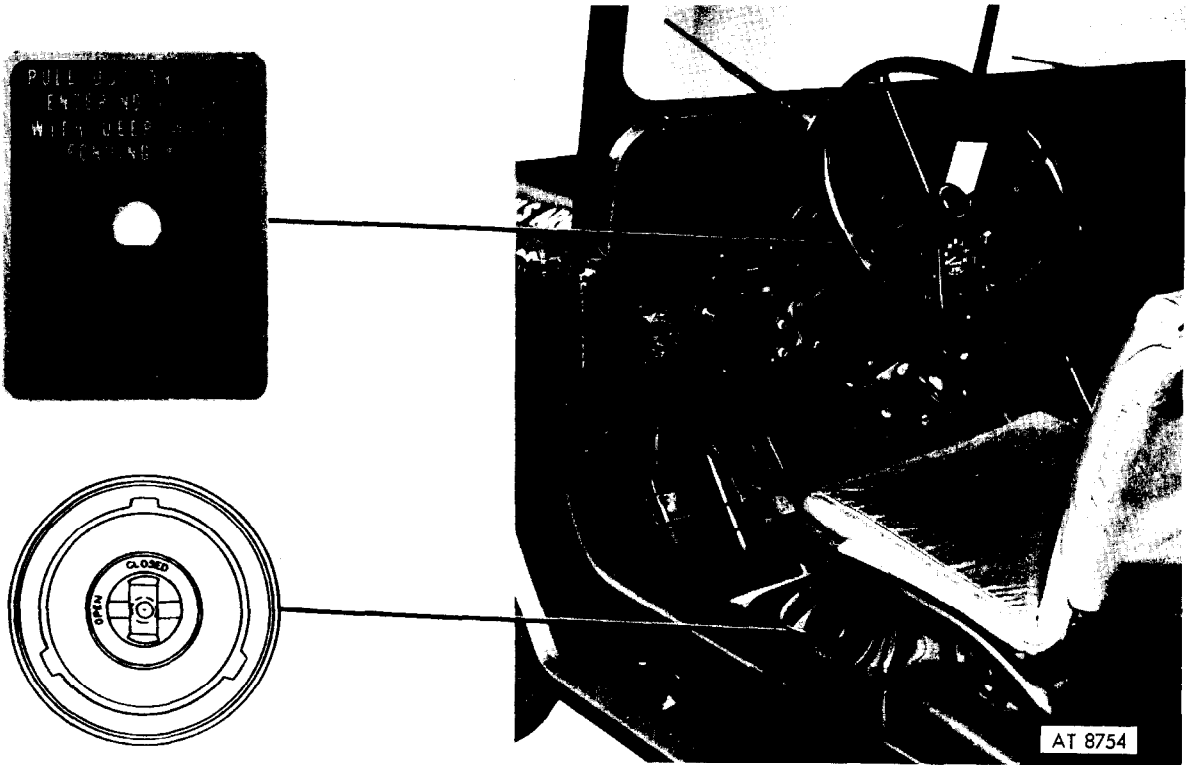

Figure 4-21. Instruction plates for deepwater fording kit.

The fuel tank cap is equipped with a fording valve which is manually closed before fording. The deepwater fording kit is shown assembled and disassembled in figures 4-24 and 4-25.

*b. Name, Caution, and Instruction Plates.* Location and details of the plates are shown in figure 4-21.

**4-27. Data**

Army part number	-----	7536098
Weight of kit (gross)	-----	76.0 lb
Fording depth	-----	5 ft (60 in.)

**4-28. Controls**

*a. Fording Valve.* (Refer to fig. 4-22.) A control handle and instruction plate for the fording valve are located on the instrument panel near the choke and throttle controls (fig. 4-21). When the control is pulled out as directed, the engine, brake, hydraulic and fuel venting systems are connected through the

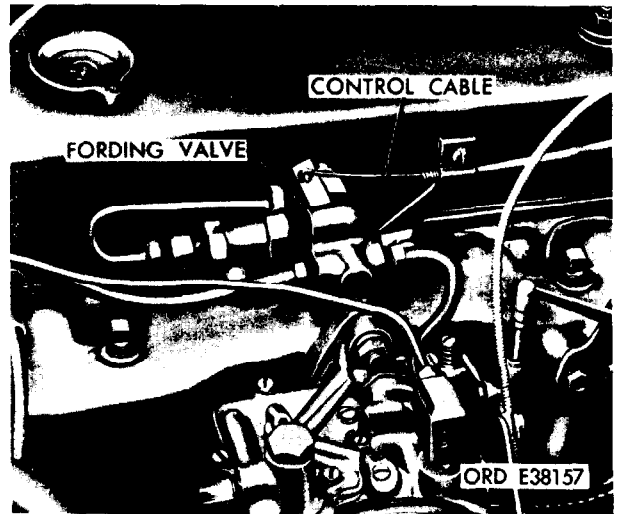

Figure 4-22. Fording valve and cable.

fording valve to the extension intake tube so that they can be provided with an outlet to the atmosphere (above the water line).

b. *Fuel Filler Cap Valve.* A fording setting is provided in the fuel tank cap (fig. 4-21) which is set to closed position before fording. Instructions for use of this valve are embossed on the fuel tank filler cap. The valve is set by turning the lever inside the cap to the positions marked "OPEN" or "CLOSED".

**4-29. Operating Instructions**

a. *Operations to Be Performed Before Fording.*

- (1) Pull out fording valve control. (Open floor drains on older models.)
- (2) Set fuel tank filler cap to the closed position for fording.
- (3) Secure floatable objects to vehicle.
- (4) Remove drain plug from storage boss and install in flywheel housing cover drain opening (fig. 4-23).

*Note.* On models prior to serial number 2C2197, the drain plug is stored in the driver's seat map compartment (rear of seat back).

b. *Fording Operation.*

**Warning:** Do not attempt to ford water deeper than 60 inches, as water will enter intake pipe, stalling engine, damage vehicle, and endangering occupants.

- (1) Make sure engine is operating efficiently.

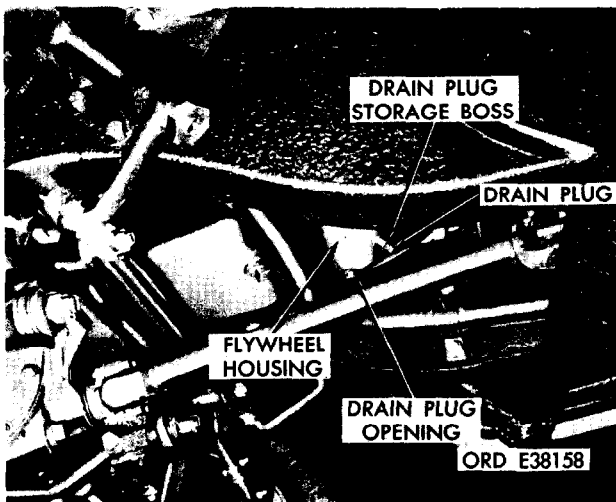

Figure 4-23. Flywheel housing drain plug.

- (2) Place transmission in first gear and engage front wheel drive.

- (3) Enter water slowly, but prevent engine stall.
- (4) If engine stalls, start in usual manner.
- (5) Limit speed to 3-4 mph.
- (6) Avoid unnecessary use of the clutch.
- (7) Do not rely on brakes until dried out.

c. *Operations to Be Performed After Fording.*

- (1) Push fording valve control in to restore normal ventilating.
- (2) Set fuel tank filler cap valve to "OPEN".
- (3) Close floor drain valves. (Floor drains are open on later model vehicles.)
- (4) Drag brakes to dry out shoes.
- (5) Remove drain plug from flywheel housing cover drain opening and stow in flywheel housing storage boss (fig 4-23) or in the driver's seat map compartment.

**Caution:** Immediately, or as soon as the tactical situation permits, perform the after-fording maintenance as directed in paragraph 3-31.

**4-30. Preventive Maintenance**

Refer to table 10 and perform the preventive-maintenance services following the numerical order given in the interval columns.

Table 10. Operator's Daily Preventive-Maintenance Services for Deepwater Fording Kit Equipped Vehicles

	Intervals			Procedure
	Before Operation	During Operation	After Operation	
1				Inspect fuel tank filler cap fording valve for ease of operation.
2			12	Check tightness of four-way vent connection located on firewall.
3			11	Inspect installation of brake master cylinder vent for security of attachment and watertightness.
4			10	Inspect exhaust extension tailpipe for watertight connection and security of attachment to body.
5		7		Inspect exhaust extension tailpipe cover for operation.
6			9	Inspect air intake tube for tightness of connection to air cleaner and security of attachment to body.
			8	Operate engine and fording valve to check operation.

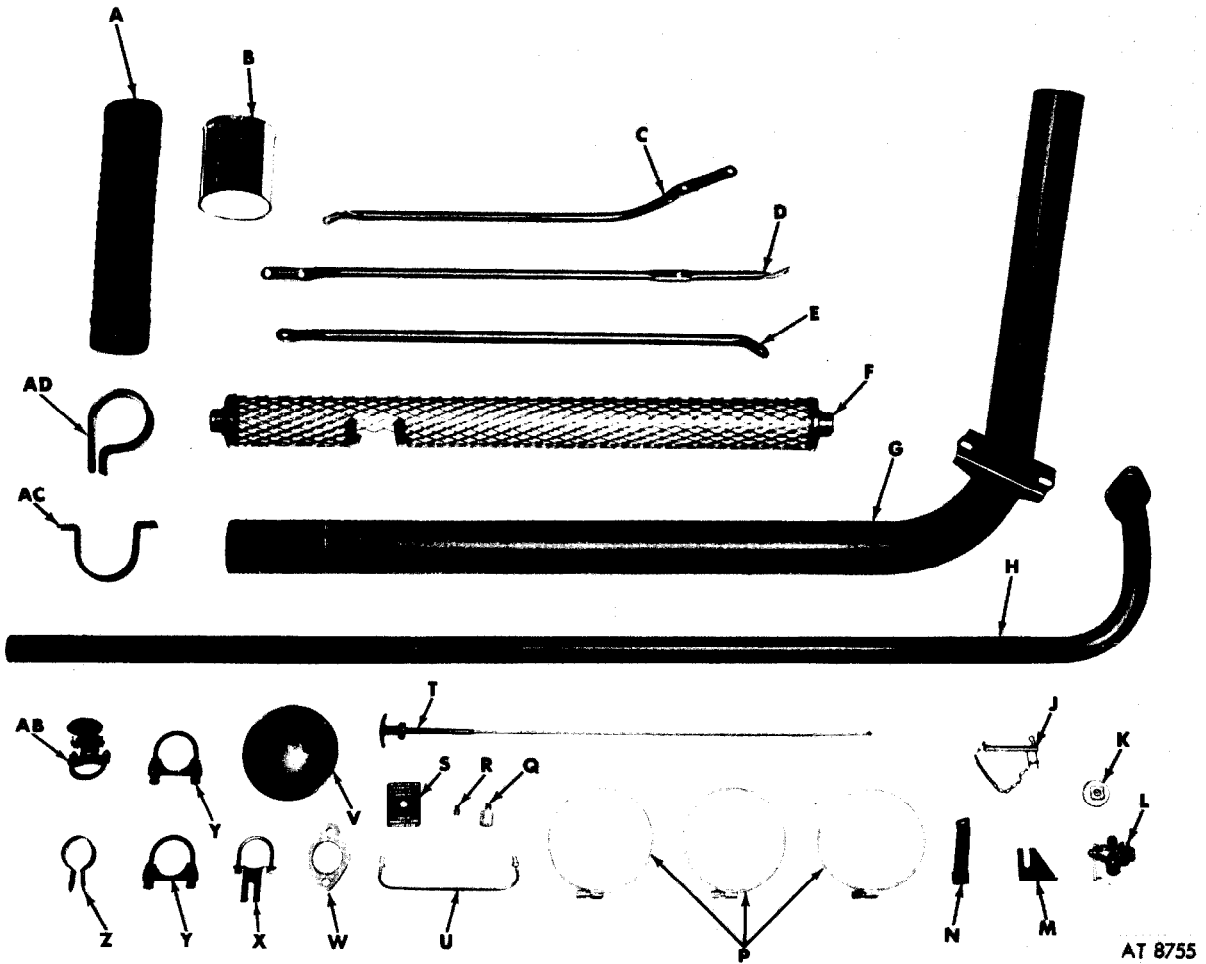

AT 8755

Key	Item	Part Number	Key	Item	Part Number
A	Hose, air duct	10884934	T	Control assembly	7536127
B	Sealer, MIL-S-158, type 2		U	Tube assembly	7536130
C	Support	7536119	V	Deflector, rain	8329647
D	Support	7536110	W	Gasket	7331368
E	Support	10950865	X	Clamp assembly	
F	Guard assembly	11630422		U-Bolt	7536099
G	Tube assembly	10950866		Clamp	10885586
H	Pipe assembly	7536117		Washer, lock	96906-35335-33
J	Pipe assembly	10936812		Nut	96906-51967-1
K	Plug	10950854	Y	Clamp assembly	
L	Valve assembly	7535978		U-Bolt	7536099
M	Bracket	10885587		Clamp	11630420
N	Bracket	7536126		Washer, lock	96906-35335-33
P	Clamp	96906-35842-5	Z	Clamp	7536103
Q	Cross	7536114	AB	Cover assembly	10885593
R	Plug	444571	AC	Bracket	7536116
S	Plate, instruction	7536148	AD	Clamp assembly	10950970

Figure 4-24. Deepwater fording kit disassembled

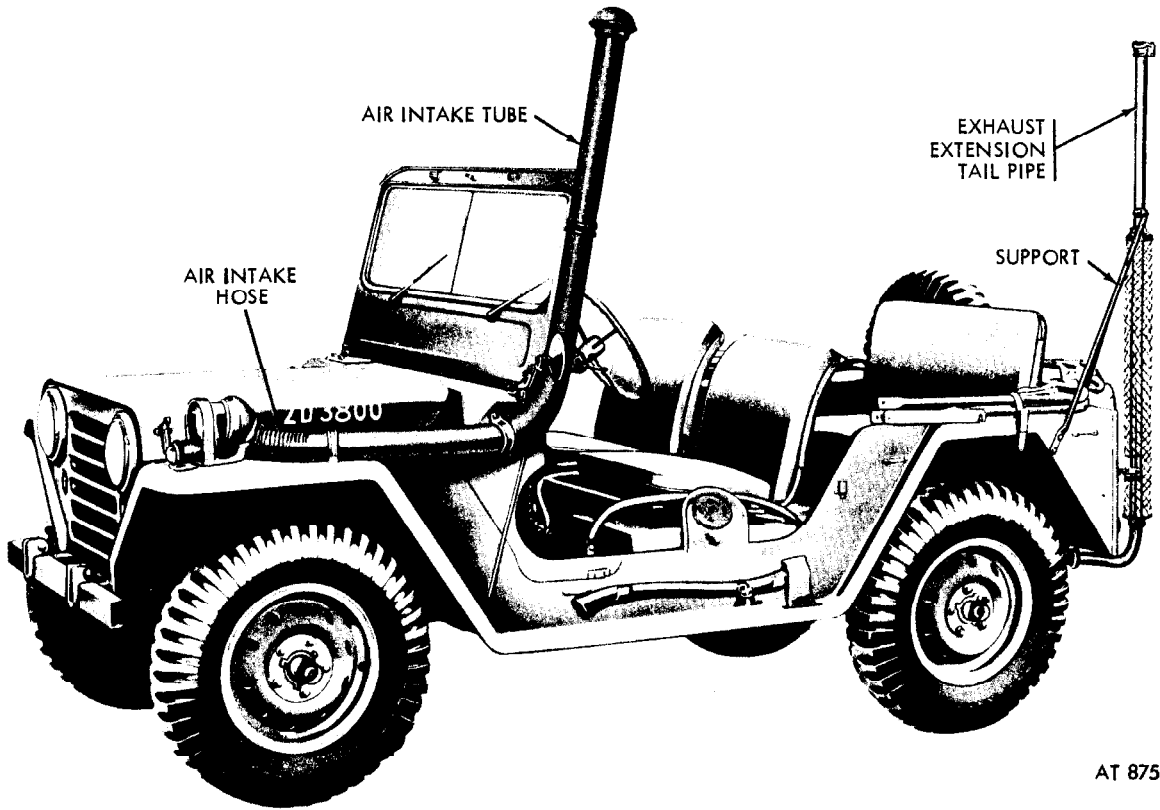

AT 8756

Figure 4-25. Deepwater fording kit installed.

**4-31. Lubrication**

Follow the directions provided in paragraph 3-31 as they concern lubrication instructions. MIL-S-12158 type 2 sealer is provided in a one quart can with the deepwater fording kit. This should be applied to battery and cable con-

nections liberally and regularly of those vehicles engaged in deepwater fording operations to reduce corrosion at the terminals.

**4-32. Troubleshooting**

For troubleshooting deepwater fording kits, refer to table 11.

Table 11. Troubleshooting—Deepwater Fording Equipment

Malfunction	Probable causes	Corrective action
1. Excessive smoking from vehicle exhaust pipe.	a. Carburetor inlet restricted. b. Improper fording valve operation.	a. Notify organizational maintenance. b. Notify organizational maintenance.
2. Loss of power.	a. Carburetor inlet restricted. b. Restricted exhaust. c. Improper fording valve operation. d. Fuel tank filler cap valve inoperative.	a. Notify organizational maintenance. b. Notify organizational maintenance. c. Notify organizational maintenance. d. Adjust or replace cap.
3. Stalling on land.	a. Carburetor inlet restricted. b. Restricted exhaust. c. Improper fording valve operation. d. Fuel tank filler cap valve inoperative.	a. Notify organizational maintenance. b. Notify organizational maintenance. c. Notify organizational maintenance. d. Position valve correctly or replace cap.

Table 11. Troubleshooting—Deepwater Fording Equipment—Continued

Malfunction	Probable causes	Corrective action
4. Stalling in water.	<ul style="list-style-type: none"> <li>a. Leaks in air intake system.</li> <li>b. Leaking exhaust.</li> <li>c. Improper fording valve operation.</li> <li>d. Loose ventilating line connections.</li> <li>e. Fuel tank filler cap valve inoperative.</li> </ul>	<ul style="list-style-type: none"> <li>a. Examine and tighten all intake connections.</li> <li>b. Examine and tighten all exhaust connections.</li> <li>c. Notify organizational maintenance.</li> <li>d. Examine and tighten all ventilating line connections.</li> <li>e. Position valve correctly or replace cap.</li> </ul>
5. Water in engine. (Shown by water bubbles on oil level indicator-dip stick.)	<ul style="list-style-type: none"> <li>a. Leaks in air intake system.</li> <li>b. Loose ventilating line connections.</li> <li>c. Improper fording valve operation.</li> </ul>	<ul style="list-style-type: none"> <li>a. Examine and tighten all intake connections.</li> <li>b. Examine all ventilating line connections and tighten.</li> <li>c. Notify organizational maintenance.</li> </ul>
6. Water in fuel.	<ul style="list-style-type: none"> <li>a. Fuel tank filler cap valve inoperative.</li> <li>b. Improper fording valve operation.</li> <li>c. Loose ventilating line connections.</li> <li>d. Leaks in air intake system.</li> </ul>	<ul style="list-style-type: none"> <li>a. Position valve correctly or replace cap.</li> <li>b. Notify organizational maintenance.</li> <li>c. Examine all ventilating line connections and tighten.</li> <li>d. Notify organizational maintenance.</li> </ul>
7. Water in brake fluid.	<ul style="list-style-type: none"> <li>a. Loose ventilating line connections.</li> <li>b. Improper fording valve operation.</li> <li>c. Leaks in air intake system.</li> </ul>	<ul style="list-style-type: none"> <li>a. Examine all ventilating line connections and tighten.</li> <li>b. Notify organizational maintenance.</li> <li>c. Examine and tighten all intake connections.</li> </ul>

**Section VII. 100-AMPERE GENERATOR KIT**

**4-33. Description**

a. *General.* The 100-ampere charging system is used when the electrical requirements of special equipment, such as radio transmitters, exceed the capabilities of the standard 25-ampere charging system, or 60-ampere system in later models. The system consists of three major components; an alternating current generator which is in the same location as the standard generator; a regulator; which is located in the engine compartment on the right fender housing; and a fan-cooled rectifier, which is located in front of the regulator. The basic difference between this system and the standard 25-ampere dc system is that the generator unit produces alternating current rather than direct current. Since alternating current cannot be used to charge storage batteries or supply current directly to the vehicle electrical system, a rectifier is connected between the generator and the regulator to convert the alternating current to direct current.

The higher current produced by the system is carried directly to the batteries by heavy gage cables. The kit, disassembled is shown in figure 4-27.

*Note.* All components of the system are water-proofed or sealed so vehicles with this equipment may be used for fording.

b. *Generator (Alternator).* The generator is given by four belts. Externally it is not sealed, however, the internal components are water-proof and cannot be damaged by submersion in water. The generator will not function when submerged, but will start charging when removed from the water. The unit is cooled by an internal fan which is located at the rear of the generator housing.

c. *Regulator.* The regulator is a sealed unit and is not affected by water. It contains a load relay which connects the system to the vehicle batteries when the ignition switch is turned on.



d. *Rectifier.* The rectifier is a full-wave, waterproof, and fan-cooled unit. It provides direct current at up to 100 amperes for the 24 volt battery system from the ac provided by the alternator to the rectifier.

e. *Name, Caution, and Instruction Plates.* Details of the alternator and the regulator nameplates are shown in figure 4-26.



GENERATOR NAME PLATE

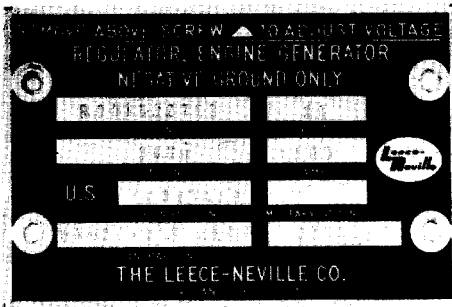

REGULATOR NAME PLATE

AT 8757

Figure 4-26. Nameplates for 100-ampere generator kit.

**4-34. Data**

a. *Generator (Alternator):*

Army part no. _____	8376991
Rated volts _____	28
Rated amperes _____	100
Speed range _____	2,000 to 8,000 rpm
Weight _____	37.7 lb

b. *Rectifier:*

Army part no. _____	10906314
Rated volts _____	28
Rated amperes _____	100
Weight _____	11.2 lb

c. *Regulator:*

Army part no. _____	10947439
Rated volts _____	28
Rated amperes _____	100
Weight _____	11.3 lb

**4-35. Controls and Instruments**

There are no new driver-operated controls related to the operation of this equipment.

**4-36. Operating Instructions**

**Caution:** When the vehicle is not in motion and electrical equipment with high current draw is in use, start the engine and use the hand throttle to increase the engine speed until the battery indicator is in the green band.

When the vehicle is operated at low road speeds and electrical equipment with high current draw is in use, shift to a lower gear to increase engine speed to keep the battery-generator indicator in the green band. Do not exceed maximum road speeds shown on vehicle instruction plate for gear position selected.

**4-37. Daily Preventive Maintenance**

a. Inspect fan belts. Notify organizational maintenance if fan belts are broken, frayed, glazed or loose.

b. Inspect battery electrolyte level and re-fill as required. Report excessive use of water to organizational maintenance.

c. Inspect and clean rectifier plates.

- (1) Use compressed air or soft brush and water to remove accumulation of sand, mud, etc.
- (2) Notify organizational maintenance if rectifier plates are chipped or burned.

d. Inspect and clean rectifier cooling fan.

- (1) Use compressed air or soft brush and water to remove accumulation of sand or mud.
- (2) Notify organizational maintenance if cooling fan is inoperable.

**Caution:** Do not touch the plates with metal objects.

**4-38. Lubrication**

None required; the generator bearings are factory-lubricated and do not require any further service.

**4-39. Troubleshooting**

For troubleshooting instructions on the 100-ampere charging system, refer to table 12.

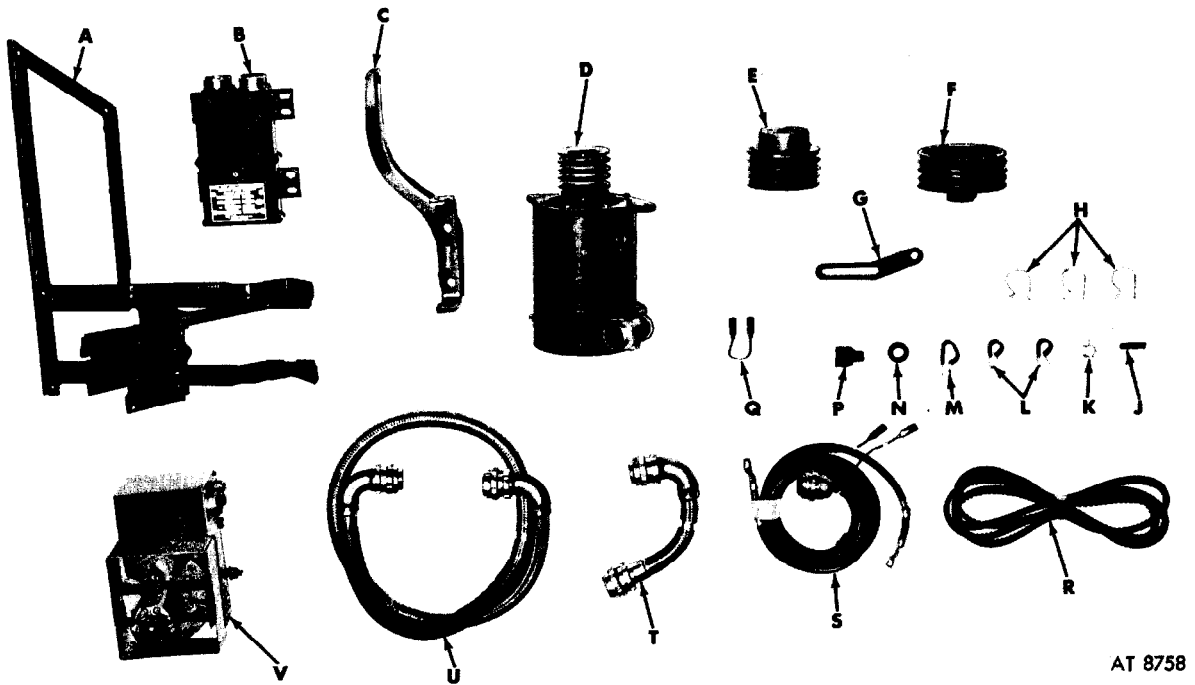

AT 8758

Key	Item	Part Number	Key	Item	Part Number
A	Bracket	10885575	L	Clip	10885578
B	Regulator	10947439	M	Clamp	96906-21333-102
C	Support assembly	10884909	N	Grommet	96906-35490-19
D	Generator (alternator)		P	Connector	96906-27147-1
	and pulley	10921859	Q	Lead, electrical	8710635
E	Pulley, water pump	10884985	R	Belt set	10884910
F	Pulley, crankshaft	10884986	S	Harness wiring	10885581
G	Bracket	10950831	T	Cable assembly	10885577
H	Clamp	96906-9025-18	U	Cable assembly	10950824
J	Sleeve	7056636	V	Rectifier and cooling fan assembly	10885146
K	Clamp	7728831			

Figure 4-27. 100-ampere generator kit disassembled.

Table 12. Troubleshooting—100-Amp Charging System

Malfunction	Probable causes	Corrective action
1. Fan belt squeal (slipping belts).	<ul style="list-style-type: none"> <li>a. Loose belts.</li> <li>b. Glazed belts.</li> <li>c. One or more broken belts.</li> </ul>	<ul style="list-style-type: none"> <li>a. Notify organizational maintenance.</li> <li>b. Notify organizational maintenance.</li> <li>c. Notify organizational maintenance.</li> </ul>
2. Excessive battery water usage.	<ul style="list-style-type: none"> <li>a. Voltage regulator set too high.</li> <li>b. Cracked and/or leaking battery case.</li> </ul>	<ul style="list-style-type: none"> <li>a. Notify organizational maintenance.</li> <li>b. Notify organizational maintenance.</li> </ul>
3. Battery not being charged (indicated by battery-generator indicator).	<ul style="list-style-type: none"> <li>a. Current draw of special electrical equipment exceeds charging rate.</li> <li>b. Loose or corroded negative cable.</li> <li>c. Loose charging system negative cable.</li> <li>d. Loose regulator ground wire.</li> <li>e. Loose or dirty cable connectors.</li> <li>f. Other.</li> </ul>	<ul style="list-style-type: none"> <li>a. Increase engine speed to increase charging rate. (Maximum charging rate is obtained at 1150 engine rpm.) If indicator still stays in the yellow or red band, notify organizational maintenance.</li> <li>b. Notify organizational maintenance.</li> <li>c. Notify organizational maintenance.</li> <li>d. Tighten regulator ground wire. Notify organizational maintenance.</li> <li>e. Notify organizational maintenance.</li> <li>f. Notify organizational maintenance.</li> </ul>

## Section VIII. PORTABLE FIRE EXTINGUISHER

### 4-40. Description

The portable fire extinguisher used with M151, M151A1, M151A1C and M718 vehicles is a hand-charged, Freon CF3BR, 2.75 pound, valve grip lever type. On M718 vehicles it is located in a bucket mounted to the left rear fender body panel, directly behind and to the left of the driver's seat as illustrated by figure 4-28, and can be used for electrical, fuel, oil, canvas and rubber fires. On M151A1C vehicles it is located on the left front fender.

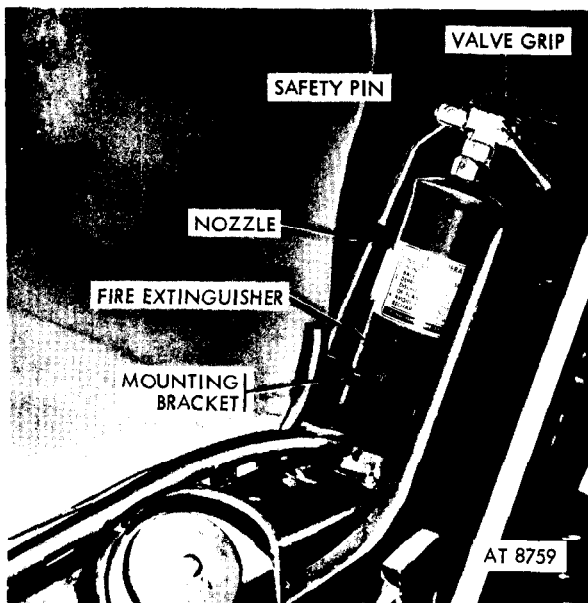

Figure 4-28. Portable fire extinguisher installed.

### 4-41. Data

For requisitioning purposes refer to the federal stock number and item description in Troop-Installed Items, Appendix B.

### 4-42. Controls

The valve grip lever and safety pin (fig. 4-28), are provided to discharge the portable fire extinguisher.

### 4-43. Name and Instruction Plate

The CF3BR name and instruction plate is illustrated in figure 4-29.

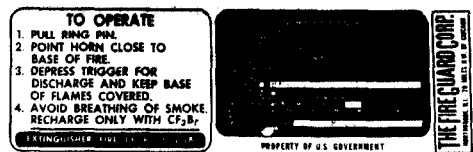

Figure 4-29. Name and instruction plate for portable fire extinguisher CF3BR.

### 4-44. Operating Instructions

- a. Pull ring pin.
- b. Point horn close to base of fire.
- c. Depress trigger for discharge and keep base of flames covered.
- d. Avoid breathing smoke and fumes.

### 4-45. Daily Preventive Maintenance

Do not operate vehicle until a fully-charged extinguisher has been installed, if the vehicle is designated to be equipped with one. After use of fire extinguisher return it to organizational maintenance so that a fully charged fire extinguisher is available for operational readiness at all times.

## Section IX. M4 PEDESTAL GUN MOUNT

### 4-46. Description and Data

The M4 pedestal gun mount (10885124) is provided for applicable M151 and M151A1 vehicles and is illustrated in figure 4-30. The pedestal is composed of an upright socket, column and handle assembly and supported in

place by left and right braces and other miscellaneous mounting hardware. The M4 pedestal gun mount is used to provide mounting facilities for the 7.62mm, M60 machinegun or other weapons as may be specified.

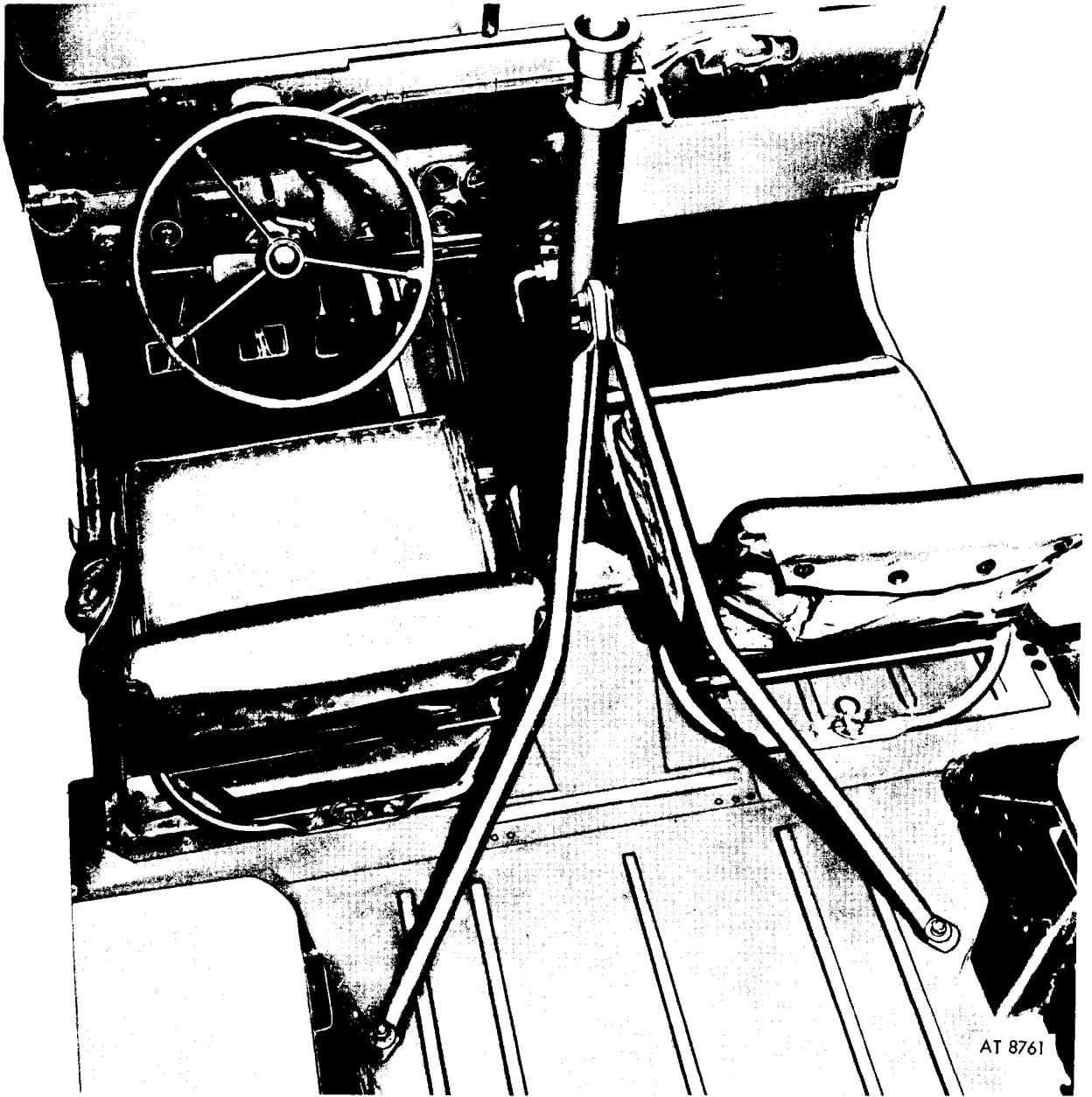

*Figure 4-30. M4 pedestal gun mount installed.*

#### **4-47. Operating Instructions and Controls**

For operating instructions refer to the applicable weapons manual. Controls should operate smoothly and freely and lock the weapon securely when in the traveling position.

#### **4-48. Daily Preventive Maintenance**

As daily preventive maintenance procedure, operators should follow the general instructions given in paragraph 3-20, accomplishing such action as may be necessary for proper

operation, and reporting any malfunction beyond the scope of operational maintenance as prescribed by paragraph 3-21.

#### 4-49. Lubrication

Moving parts of the M4 pedestal gun mount should be lubricated when performing general lubrication procedures, or as necessary, to assure smooth, each action of the mounted weapons. Lubricate other mount fittings to prevent rust; facilitating removal or installation of the mount and weapon; and, assuring proper operation and maintenance of mount and weapon for operational readiness as required. Refer to the appropriate weapons manual for weapons lubrication.

#### 4-50. Troubleshooting

Because of simplicity in the M4 mount, formal and detailed troubleshooting procedures are not given. Operators should assure that operation of the weapon using the mount is satisfactory and that the mount is serving its intended purpose satisfactorily. If operational maintenance tools, repair parts and procedures can not correct malfunctions uncovered by operation and preventive-maintenance procedures, deficiencies should be reported as indicated by paragraph 3-21 and the equipment provided to organizational maintenance for repair or replacement.

### Section X. M14 RIFLE MOUNT

#### 4-51. Description and Data

M14 rifle mounts (8712407) are provided for applicable M151 and M151A1 vehicles and are illustrated in figures 4-31 and 4-32 as they appear in vehicles with canvas enclosures and with hardtop special purpose kits installed. With M14 rifle mounts installed, readily accessible locations are provided for the M14 rifles. Floor brackets are supplied for left and right sides of the vehicle into which rifles are inserted. Catch assemblies mounted on the left hand and right hand sides of dash panel hold the rifles in place as shown in figures 4-31 and 4-32.

#### 4-52. Operating Instructions and Controls

For weapons operating instructions refer to the applicable weapons manual. Rifle mounts should operate smoothly and freely and lock the weapons securely when in the traveling position.

#### 4-53. Daily Preventive Maintenance

As daily preventive-maintenance procedure, operators should follow the general instructions given in paragraph 3-20, accomplishing such action as may be necessary for proper operation, and reporting any malfunction beyond the scope of operational maintenance as prescribed by paragraph 3-21.

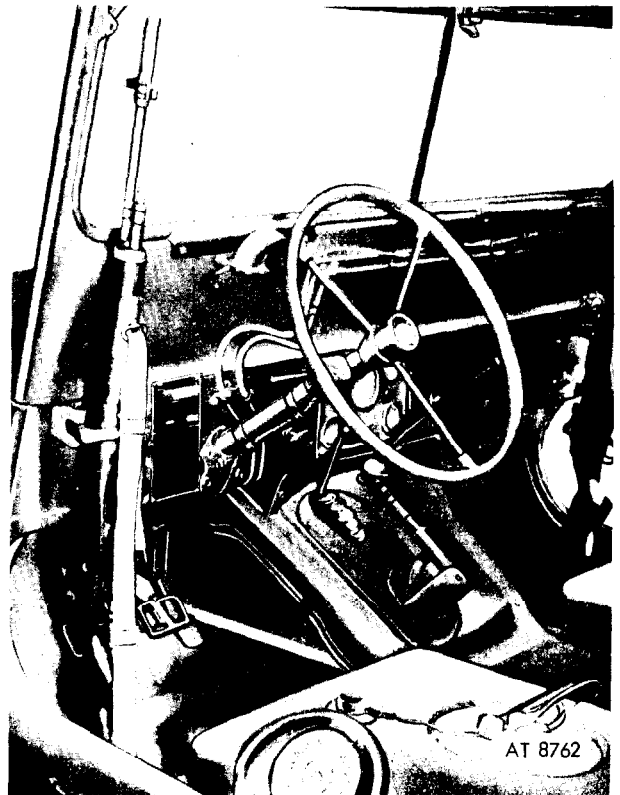
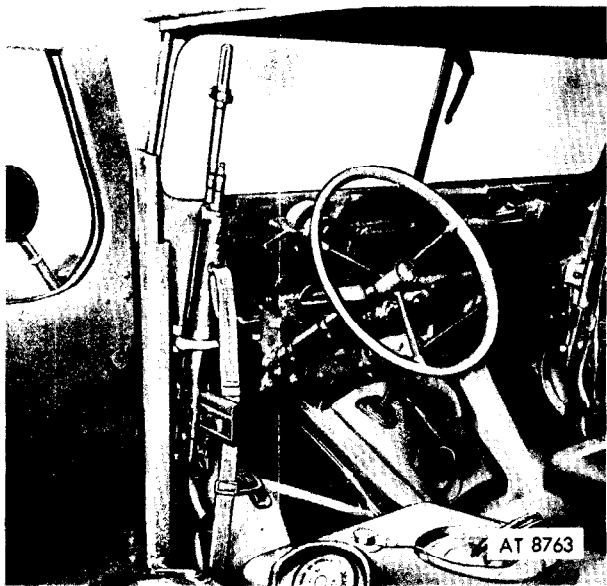

Figure 4-31. M14 rifle mount kit installed, left and right side (softtop vehicle).



*Figure 4-32. M14 rifle mount kit installed, left and right side (hardtop vehicle).*

#### **4-54. Lubrication**

Moving parts of the M14 rifle mounts should be lubricated when performing general lubri-

cation procedures, or as necessary, to assure smooth, easy action installing and removing M14 rifles. Lubricate other mount fittings to prevent rust; facilitating removal or installation of the mount and weapon; and, assuring proper operation of mount and weapon for operational readiness as required. Refer to the appropriate weapons manual for weapons lubrication.

#### **4-55. Troubleshooting**

Because of simplicity in M14 rifle mounts, formal and detailed troubleshooting procedures are not given. Operators should assure that operation of the weapons using M14 rifle mounts are satisfactory and that the mounts are serving their intended purpose satisfactorily. If operational maintenance tools, repair part and procedures can not correct malfunctions uncovered by operation and preventive-maintenance procedures, deficiencies should be reported as indicated by paragraph 3-21 and the equipment provided to organizational maintenance for repair or replacement.

## CHAPTER 5

### SHIPMENT AND DESTRUCTION OF MATERIEL TO PREVENT ENEMY USE

---

#### Section I. SHIPMENT

##### 5-1. Domestic Shipping Instructions

When shipping M151 series vehicles, the officer in charge of preparing shipments will be responsible for the vehicle being shipped in a serviceable condition, and properly processed for shipment, including the preparation of

army shipping documents.

##### 5-2. Loading and Blocking Instructions

The operator, crew, or driver may assist, as required, in loading and blocking the vehicle on railroad cars.

#### Section II. DESTRUCTION OF MATERIEL TO PREVENT ENEMY USE

##### 5-3. General

a. Destruction of the M151 series vehicles, when subject to capture or abandonment in the combat zone, will be undertaken by the using organization only when, in the judgment of the unit commander concerned, such action is necessary in accordance with orders of, or policy established by, the army commander.

b. The information which follows is for guidance only. Certain procedures outlined below require the use of explosives and incendiary grenades which normally may not be authorized items for the vehicle. The issue of these and related materiel, and the conditions under which destruction will be effected, are command decisions in each case, according to the tactical situation. Of the several means of destruction, those most generally applicable are:

###### Mechanical

Requires axe, or similar implement.

###### Burning

Requires gasoline, oil, incendiary grenades, or other flammables.

###### Demolition

Requires suitable explosives or ammunition. Refer to FM 5-25.

###### Gunfire

Includes artillery, machine guns, rifles using rifle grenades, and launchers using antitank rockets. Under some circumstances hand grenades may be used.

In general, destruction of essential parts, followed by burning, will usually be sufficient to render the vehicle useless. However, selection of the particular method of destruction requires imagination and resourcefulness in the utilization of the facilities at hand under the existing conditions. Time is usually critical.

c. If destruction to prevent enemy use is resorted to, the vehicle must be so badly damaged that it cannot be restored to a usable condition in the combat zone, either by repair or cannibalization. Adequate destruction requires that all parts essential to the operation of the vehicle, including essential spare parts, be destroyed or damaged beyond repair. However, when lack of time and personnel prevents destruction of all parts, priority is given to the destruction of those parts most difficult to replace. Equally important, the same essential parts must be destroyed on all like vehicles so the enemy cannot construct one complete unit from several damaged ones.

d. If destruction is directed, due consideration should be given to:

- (1) Selection of a point of destruction that will cause greatest obstruction to enemy movement and also prevent hazard to friendly troops from fragments or ricocheting projectiles which may occur incidental to the destruction.
- (2) Observation of appropriate safety precautions.

#### 5-4. Destruction of M151 Series Vehicles

##### a. Method No. 1—By Burning.

- (1) Using an axe, pick mattock, sledge, or other heavy implement, smash all vital elements such as distributor, carburetor, generator, ignition coil, fuel pump, spark plugs, air cleaner, lights, instruments, and controls. If time permits, and a sufficiently heavy implement is available, smash the engine cylinder block and head, crankcase, and transmission.
- (2) Puncture fuel tank as near the bottom as possible, collecting gasoline for use as outlined in (5) below.
- (3) Slash tires. If tires are inflated, exercise care to prevent injury should the tire blow out while being slashed. Whenever practicable, it is usually preferable to deflate tires before slashing.
- (4) Explosive ammunition, if available nearby, should be removed from packing or other protective material. Place ammunition in and about the vehicle so that it will be fully exposed to the fire and in such locations that the greatest damage will result from its detonation. Remove any safety devices from ammunition.
- (5) Pour gasoline and oil in the over the entire vehicle. Ignite by means of an incendiary grenade fired from a safe distance, a burst from a flame thrower, a combustible train of suitable length, or other appropriate means. Take cover immediately. If

gasoline and oil are not available, use other flammables such as oily rags or waste, wood, or paper. Ignite by means of incendiary grenades or other suitable means.

**Caution:** Cover must be taken without delay since an early explosion of the explosive ammunition, if present, may be caused by the fire. Due consideration should be given to the highly flammable nature of gasoline and its vapor. Carelessness in its use may result in painful burns.

Elapsed time: about 6 minutes.

##### b. Method No. 2—By Demolition.

- (1) Prepare two, 2-pound charges of EXPLOSIVE, TNT (two 1 pound blocks, or equivalent, per charge, together with the necessary detonating cord to make up each charge). Set the charges as follows:
  - (a) The first, on top of the clutch housing.
  - (b) The second, as low on the left side of the engine as possible.
  - (c) Connect the two charges for simultaneous detonation with detonating cord. Provide for dual priming to minimize the possibility of a misfire.
  - (d) For priming, either a nonelectric blasting cap crimped to at least 5 feet of safety fuse (safety fuse burns at the rate of 1 ft in approximately 40 sec; test before using) or an electric blasting cap and firing wire may be used. Safety fuse, which contains black powder, and nonelectric blasting caps must be protected from moisture at all times. The safety fuse may be ignited by a fuse lighter or a match; the electric blasting cap requires a blasting machine or equivalent source of electricity.

**Warning:** Keep the blasting caps, detonating cord, and safety fuses separated from the charges until required for use.

*Note.* For the successful execution of methods of destruction involving the use of demolition materials,



all personnel concerned must be thoroughly familiar with the pertinent provisions of FM 5-25. Training and careful planning are essential.

- (2) Destroy the tires as outlined in a(3) above.
- (3) Detonate the charges. If primed with nonelectric blasting cap and safety fuse, ignite and take cover. If primed with electric blasting cap, take cover before firing the charges. The danger zone is approximately 200 yards.

Elapsed time: about 5 minutes.

*c. Method No. 3—By Gunfire.*

- (1) Destroy the tires as outlined in a(3) above.
- (2) Destroy the vehicle by gunfire, using artillery, machine guns, rifles using rifle grenades, or launchers using antitank rockets. Fire on the vehicle aiming at the engine, axles, body, and wheels. Although one well-placed, di-

rect hit may destroy the vehicle, several hits are usually required for complete destruction unless an intense fire is started, in which case the vehicle may be considered destroyed.

**Warning:** Firing artillery at ranges of 500 yards or less should be from cover. Firing rifle grenades or antitank rockets should be from cover.

Elapsed time: about 5 minutes.

*d. Method No. 4—By Mechanical Means.* Perform operations as indicated in a(2) and (3) above. Also puncture fuel tank in several places.

### **5-5. Destruction of Guns, Ammunition and Fire Control Equipment**

For instructions in the destruction of guns, ammunition and fire control equipment aboard the M151A1C vehicle, refer to TM 9-1000-205-12.

## APPENDIX A

## REFERENCES

**A-1. Publication Indexes**

The following indexes should be consulted frequently for latest changes or revisions of references given in this appendix and for new publications relating to materiel covered in this manual.

Dictionary of United States Army Terms .....	AR 320-5
Index of Army Motion Pictures, Film Strips, Slides, and Phono-Recordings .....	DA Pam 108-1
Military Publication Indexes (As applicable) .....	DA Pam 310-series
Military Symbols .....	FM 21-30
Military Terms, Abbreviations, and Symbols: Authorized Abbreviations and Brevity Codes .....	AR 320-50
Military Training .....	FM 21-5
Techniques of Military Instruction .....	FM 21-6

**A-2. Forms**

The following forms pertain to this materiel. (Refer to DA Pamphlet 310-2 for index of blank forms.)

Standard Form 46, U.S. Government Motor Vehicle Operator's Identification Card	
Standard Form 91, Operator's Report of Motor-Vehicle Accident (card)	
Standard Form 94, Statement of Witness	
Claim for Personal Property .....	DA Form 1089
Recommended Changes to DA Technical Manual Parts Lists or Supply Manual, 7, 8, or 9 (cut sheet) .....	DA Form 2028
Equipment Utilization Record .....	DA Form 2400
Organizational Control Record for Equipment .....	DA Form 2401
Equipment Inspection and Maintenance Worksheet .....	DA Form 2404
Maintenance Request Register .....	DA Form 2405
Equipment Status and Deadline Report .....	DA Form 2406
Maintenance Request .....	DA Form 2407
Equipment Log Book Assembly—Instructions for General Equipment .....	DA Form 2408
Equipment Daily or Monthly Log .....	DA Form 2408-1
Equipment Maintenance Record (Organizational) .....	DA Form 2408-3-1
Equipment Modification Record .....	DA Form 2408-5
Equipment Maintenance Record (Support Echelons— Field and Depot) .....	DA Form 2408-6
Equipment Transfer Record .....	DA Form 2408-7
Equipment Acceptance Record .....	DA Form 2408-8
Equipment Component Register .....	DA Form 2408-10
Accident Identification Card .....	DD Form 518
Weapon Record Book .....	DA Form 9-13 and DA Form 9-13-1

**A-3. Other Publications**

The following publications contain information pertinent to major item materiel and associated equipment.

*a. Camouflage.*

Camouflage, Basic Principles ..... FM 5-20  
 Camouflage of Vehicles ..... FM 5-20B

*b. Decontamination.*

Decontamination ..... TM 3-220  
 Defense Against CBR Attack ..... FM 2140

*c. Demolition of Materiel to Prevent Enemy Use.*

Demolition Materiel ..... TM 9-1946  
 Explosives and Demolition ..... FM 5-25

*d. General.*

Basic Arctic Manual ..... FM 31-70  
 Driver's Manual ..... TM 21-305  
 Driver's Selection and Training ..... TM 21-300  
 Operation and Maintenance of Ordnance Materiel in  
     Extreme Cold Weather (0° to -65° F) ..... TM 9-207  
 Lubrication of Ordnance Materiel ..... TM 9-273  
 Motor Transportation, Operations ..... FM 25-10  
 Mountain Operations ..... FM 70-10  
 Operations in the Arctic ..... FM 31-71  
 Use of Antifreeze Solutions in Engine Cooling System in  
     Operating Vehicles ..... TB ORD 651

*e. Maintenance and Repair.*

Care and Maintenance of Pneumatic Tires ..... TM 9-1870-1  
 Cleaning of Ordnance Materiel ..... TM 9-208-1  
 Cooling Systems: Vehicles and Powered Ground Equipment ..... TM 9-2858  
 Lubrication Order for 1/4 ton, 4 x 4, Utility Truck, M151 ..... LO 9-2320-218-12  
 Materials Used for Cleaning, Preserving, Abrading, and  
     Cementing Ordnance Materiel and Related Materials  
     Including Chemicals ..... TM 9-247  
 Operation and Organizational Maintenance: Cal. .50  
     Spotting Rifle M8C, 106MM Rifles M40A1 and M40A1C;  
     106MM Rifle Mounts T173 and M79; and Tripod T26 ..... TM 9-1000-205-12  
 Organizational Maintenance for 1/4 ton, 4 x 4, Utility  
     Trucks, M151, M151A1, M151A1C and M718 Ambulance ..... TM 9-2320-218-20  
 Painting Instructions for Field Use ..... TM 9-2851  
 Deepwater Forging of Ordnance Materiel ..... TM 9-238  
 Storage Batteries, Lead-Acid Type ..... TM 9-6140-200-15

## APPENDIX B

### BASIC ISSUE ITEMS LIST

#### Section I. INTRODUCTION

#### B-1. Scope

This appendix lists items which accompany the M151 and M151A1, 4 x 4, 1/4 ton, utility trucks, 106mm recoilless rifle, M151A1C, 4 x 4, 1/4 ton, utility truck and M718, 4 x 4, 1/4 ton, frontline ambulance truck or are required for installation, operation, or operator's maintenance.

#### B-2. Explanation of Columns

The following provides an explanation of columns in the tabular list in section II.

##### a. Source, Maintenance and Recoverability Codes (Column 1).

- (1) Source Code, Column 1a, indicates the selection status and source for the listed item. Source codes are:

<i>Code</i>	<i>Explanation</i>
P	Applies to repair parts which are high mortality parts; procured by technical services stocked in and supplied from the technical service depot system, and authorized for use at indicated maintenance echelons.
C	Applies to repair parts authorized for local procurement. If not obtainable from local procurement, such repair parts will be requisitioned through normal supply channels with a supporting statement of nonavailability from local procurement.
M	Applies to repair parts which are not procured or stocked but are to be manufactured by using units at indicated maintenance echelons.

- (2) Maintenance Code, Column 1b, indicates the lowest category of maintenance authorized to install the listed item. The maintenance level code is:

<i>Code</i>	<i>Explanation</i>
C	Operator/Crew

- (3) Recoverability Code, Column 1c, indicates whether unserviceable items

should be returned for recovery or salvage. Items not coded are expendable. Recoverability codes are:

<i>Code</i>	<i>Explanation</i>
NR	Indicates an item that is <i>nonexpendable</i> and <i>recoverable</i> and is economically repairable.
R	Indicates a repair part or assembly that is expendable and recoverable and is economically repairable and, when available, is furnished by supply on an exchange basis.
S	Indicates an item that is expendable and recoverable and which may be placed in "ready for issue" condition by one or more of the re-finishing, cleaning, replating, anodizing, adjusting, welding, etc., processes.

- b. Federal Stock Number, Column 2, lists 11-digit Federal stock number for the item.

c. Description, Column 3, indicates the Federal item name and any additional description required. The abbreviation "w/e", when used as a part of the nomenclature, indicates the Federal Stock Number includes all armament, equipment, accessories, and repair parts issued with the item. A five-digit manufacturer's code or other service code and part number is included in parentheses for reference.

d. Unit of Issue, Column 4, indicates the unit used as a basis for issue, e.g., ea, pr, ft, yd, etc.

e. Quantity Incorporated in Unit Pack, Column 5, indicates the actual quantity contained in the unit pack.

f. Quantity Incorporated in Unit, Column 6, indicates the total quantity of the item used on the equipment.

g. Quantity Authorized, Column 7, indicates the total quantity of an item to be on hand

and necessary for operation and maintenance of the equipment. Items to be requisitioned as required as indicated by an asterisk.

*h. Illustration, Column 8.*

- (1) Figure Number, Column 8a, indicates the figure number of the illustration in which the item is shown.

- (2) Item or Symbol Number, Column 8b, indicates the callout number used to reference the item in the illustration.

*i. Abbreviations.*

Refer to paragraph 1-4 of this manual for explanation of abbreviations used in this appendix.

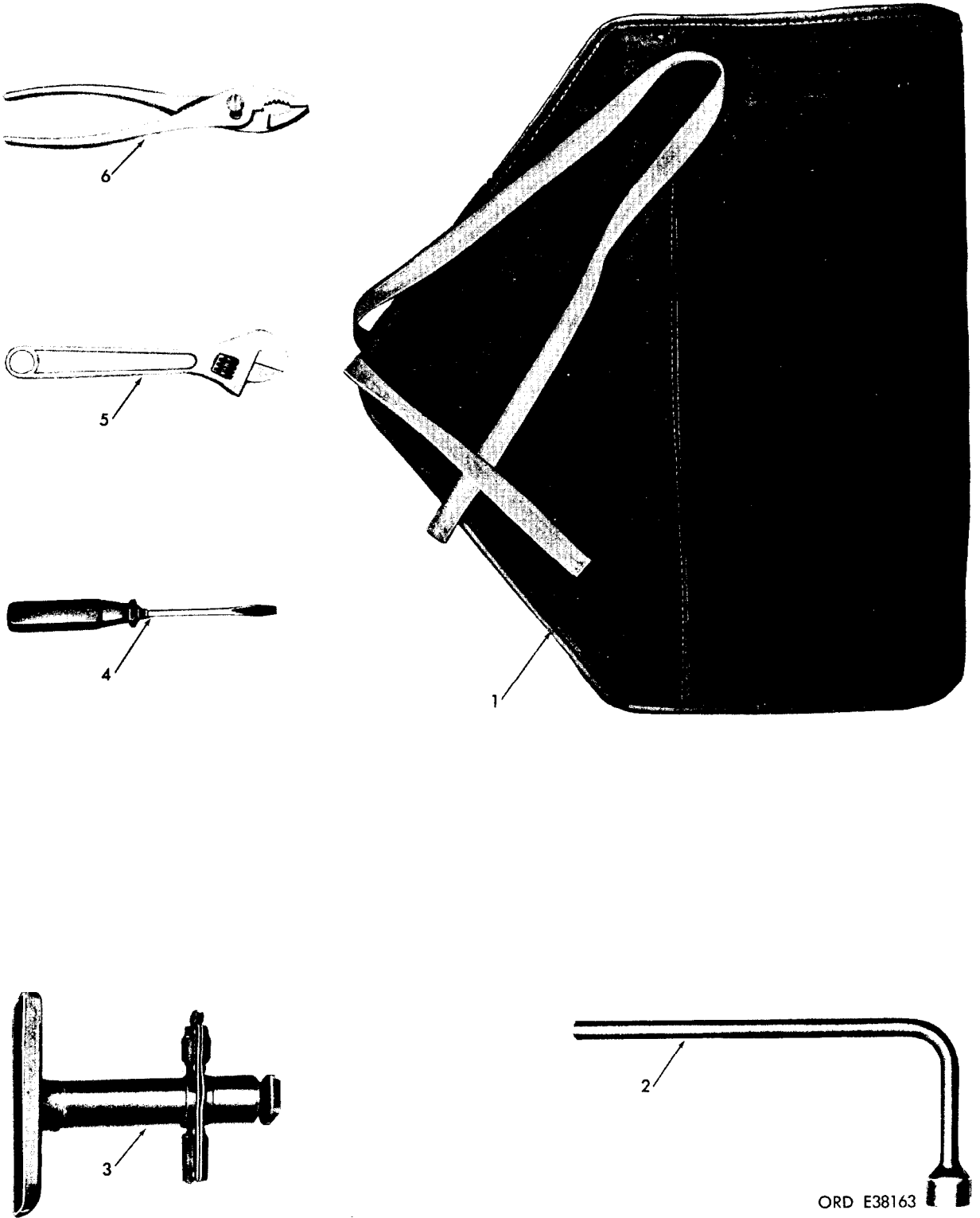

ORD E38163

Figure B1-1. Basic issue items.

## Section II.

## BASIC ISSUE ITEMS LIST

(1) SOURCE, MAINT. AND RECOV. CODE			(2) FEDERAL STOCK NUMBER	(3) DESCRIPTION	(4) UNIT OF ISSUE	(5) QTY INC IN UNIT PACK	(6) QTY INC IN UNIT	(7) QTY AUTH.	(8) ILLUSTRATION	
(a) SOUR- CE	(b) MAI- NT.	(c) RE- COV.							(a) FIG. NO.	(b) ITEM OR SYM. NO.
				<b>BASIC ISSUE ITEMS LIST MAJOR COMBINATIONS</b>						
			2320-542-4783	TRUCK, UTILITY: ¼ ton, 4 x 4, M151, w/e					1-1	
			2320-763-1092	TRUCK, UTILITY: ¼ ton, 4 x 4, M151A1, w/e					1-1	
			2320-763-1091	TRUCK, UTILITY: ¼ ton, 4 x 4, M151A1C, 106mm recoilless rifle, w/e					1-3	
			2310-782-6056	TRUCK, AMBULANCE: frontline, ¼ ton, 4 x 4, M718, w/e					1-4	
				<b>COMPONENTS OF MAJOR ITEMS</b> The following items under the subheading below are <b>INSTALLED IN POSITION</b> on the <b>TRUCK</b> prior to issue of the vehicle to using troops.						
				<b>MISCELLANEOUS EQUIPMENT, COMMON</b>						
			5140-772-4142	BAG, COTTON DUCK: 10" x 20" w/flap	ea			1	B1-1	1
				<b>REPAIR PARTS VEHICULAR</b>						
				WHEEL, TIRE AND TUBE: complete (components to be requisitioned separately) (7331281)	ea			1		
				Composed of:						
			2640-052-0944	1-CAP, TIRE VALVE: std-bore						
			2610-269-7332	1-INNER TUBE, PNEUMATIC TIRE, lt.-trk., 7.00 x 16, w/valve (35392-8) (96906)						
			2610-678-1363	1-TIRE, PNEUMATIC; lt. trk, 7.00 x 16, 4 ply w/6 ply rating, NDCC tread, nylon (7342996)						
			2640-050-1229	1-VALVE CORE, PNEUMATIC TIRE: std- bore (51377-1) (96906)						
			2530-678-2994	1-WHEEL, PNEUMATIC TIRE: steel, 16 x 4.5 (10921860)						
				<b>TOOLS, COMMON</b>						
			2120-729-5779	JACK: dbl-screw, hand, ratcheting, 2 ton capacity, 6½" closed hgt, 15" open hgt, O.D. finish (7700157) (in tool compartment under right seat)				1	B1-1	3
			5120-223-7397	PLIERS: slip joint, str-nose, comb jaw, w/cutter, 8" long (type II, class 2, style A)	ea			1	B1-1	6
			5120-222-8852	SCREW DRIVER: flat tip, common, flared sides, plastic handle, rd-blade, ¼ w tip, 4" blade, 7¼" long (nom) (15219-1) (96906)	ea			1	B1-1	4

5120-240-5328	WRENCH: open end, adjustable, sgl-hd, str-hdl, 15/16-jaw opng, 7½" long, phosphate finish (15461-3) (96906) (fed spec GGG-W-631, type 1)	ea		1	B1-1	5
5120-811-4114	WRENCH: socket, handled, 90° offset, 11/16 in.-hex opng (nom), 5"-offset (nom), 10" long (nom) (8754458) (in tool compartment under right seat)	ea		1	B1-1	2
	WRENCH: drain plug (11630419) (in tool compartment under right seat)	ea		1		
	TOOLS, COMMON (OPTIONAL)					
5120-708-3365	JACK: dbl-screw, hand, rotating, 1½ ton capacity, 7 1/16" closed hgt., 16½" open hgt, OD finish (7083365)	ea		1		
5120-708-3364	HANDLE, JACK: handle, folding type, 36" long (nom), OD finish (7083364) (for jack 7083365)	ea		1		
	MISCELLANEOUS EQUIPMENT, M151A1C					
	BAG, TOOL: cotton duck, 6" w x 8½" d x 19½" lg w/zipper					
	MISCELLANEOUS EQUIPMENT, M718					
4210-555-8837	EXTINGUISHER, FIRE, FREON: CF3BR, hand charged, 2.7 lb cap (10916537)	ea		1	4-37	
4210-440-3222	BRACKET: fire extinguisher (10924916)	ea	1	1	4-37	
5310-088-1251	NUT: self locking, hex, cad plated ¼ (51922-1) (96906) (for attaching brkt 10924916)	ea	4	4		
	WASHER, LOCK, FLAT: external tooth cad or zn plated (35335-19) (96906) (for attaching brkt 10924916)					
	PUBLICATIONS					
7510-889-3494	BINDER, EQUIPMENT LOG BOOK: looseleaf, 3-ring, 1" cap, 7¾" x 10¼ (appropriate forms as listed in TM 38-750, appendix II are to be furnished with this binder, including:	ea		1		
	D.A. Form 2408 Equip. Log Assy. (Records)	ea		1		
	D.A. Form 2408-1, Form, Equip. Daily-Monthly Log	ea		1		
	D.A. Form 2408-2, Form, Equip. Lubrication Record	ea		1		
	D.A. Form 2408-3, Form, Equip. Maintenance Record	ea		1		
	D.A. Form 2408-5, Form, Equip. Modification Record	ea		1		
	D.A. Form 2408-6, Form, Equip. Maintenance Record (Support Echelons)	ea		1		



## BASIC ISSUE ITEMS LIST—Continued

(1) SOURCE, MAINT. AND RECOV. CODE			(2) FEDERAL STOCK NUMBER	(3) DESCRIPTION	(4) UNIT OF ISSUE	(5) QTY INC IN UNIT PACK	(6) QTY INC IN UNIT	(7) QTY AUTH.	(8) ILLUSTRATION	
(a) SOUR- CE	(b) MAI- NT.	(c) RE- COV.							(a) FIG. NO.	(b) ITEM OR SYM. NO.
				PUBLICATIONS—Continued						
				D.A. Form 2408-7, Form, Equip. Transfer Reports	ea			1		
				D.A. Form 2408-8, Form, Equip. Acceptance and Registration Record	ea			1		
				D.A. Form 2408-10, Form, Equip. Component Register	ea			1		
				D.A. Form 2408-14, Form, Equip. Uncorrected Fault Record	ea			1		
				TM 9-2320-218-10, Manual, Technical (Operators) (In map compartment)	ea			1		
				LO 9-2320-218-12, Order, Lubrication (In map compartment)	ea			1		
			1015-722-8906	COVER: Weapons Log Book and Publications	ea			1		
				TROOP INSTALLED ITEMS						
				The items listed under the subheadings below are not issued with the vehicle, but are installed on the vehicle by the using troops in the space provided.						
P	C		7240-222-3088	CAN, GASOLINE: 5 gal military type (MIL SPEC MIL-C-1283) (42-C-2140) In brkt-6566675 on left rear of M151 and M151A1. In bracket-6566675 on right side of M718 at front fender. In bracket-6566675 on left side of M151A1C front of driver.	ea			1	4-16	
P	C		7240-177-6154	SPOUT, GASOLINE CAN: flex cam type 2¼" O.D., 16" long (in tool compartment under right seat)	ea			1		
			1005-589-1271	RIFLE, U.S. ARMY: 7.26mm, M14 (7267000) (in mtg kit 8712407)	ea			1	4-40	
			5110-293-2336	AXE, SINGLE BIT: 4¾" cutting edge, 35½" to 36½" long, 4 lb (in brkts on left side of vehicle)	ea			1	1-1	
			5120-293-3336	SHOVEL, HAND: round point, D-handle	ea			1	1-2	
			2540-693-1027	CHAIN, TIRE: pneumatic, single 7.00 x 16, type-TS (51381-15) (96906) (In tool compartment under seat.)	ea			1		
				TROOP INSTALLED ITEMS, M718						
			6530-783-7905	LITTER: folding, rigid pole, aluminum pole (in litter rails)	ea			3		
				SPLINT SET: w/carrying bag, 10" h x 10" w x 32" 1. (strapped on right front fender)	ea			1		

## INDEX

	Paragraph	Page		Paragraph	Page
Abbreviations	1-5	1-2	Rear blackout stoplight	2-4f	2-3
Accelerator pedal, location of	2-4g	2-3	Starter switch	2-4b	2-3
Accidents, field report of	1-3	1-2	Throttle	2-4c	2-3
Air cleaner	1-8d	1-5	Turn signals	2-4e	2-3
Alternator ( <i>See</i> Generator (alternator))			Warning light, emergency	2-4e	2-3
Ambulance, frontline, M718:			Fire extinguisher, portable	4-42	4-27
Controls and instruments	2-33	2-24	Generator kit	4-35	4-25
Description and data	2-32	2-24	Hardtop enclosure kit	4-12	4-10
Lubrication instructions	2-37	2-26	Hot water heater kit (-25° F):		
Operating instructions	2-35	2-24	Auxiliary heat door	4-21d	4-17
Preventive maintenance	2-36	2-25	Brush guard cover	4-21i	4-17
Troubleshooting	2-38	2-26	Cowl ventilator	4-21g	4-17
Basic issue items	1-1c	1-1	Defroster	4-21b	4-17
Battery electrolyte level	3-28	3-23	Driver heat lever	4-21c	4-17
Battery generator indicator	2-5a	2-5	General	4-21a	4-16
Before-starting operations	2-8	2-7	Heater switch	4-21e	4-17
Blackout headlamp	1-10	1-6	Shutoff cocks	4-21f	4-17
Blackout markers	1-10	1-6	Slave receptacle	4-21h	4-17
Blackout stoplight	2-4d	2-3	Rifle mount, M4 pedestal (machinegun)	4-47	4-28
Body tilt	2-10l	2-9	Rifle mount, M14 rifle	4-52	4-29
Brake, parking, location of	2-4g	2-3	Rifle, 106mm recoilless	2-26	2-20
Brake pedal, service, location of	2-4g	2-3	Vehicle	2-4	2-3
Brake systems	1-11	1-7	Winterization kit (-65° F):		
Brakes, tabulated data	1-16k	1-17	Air intake damper control handle	4-6b	4-7
Break-in services	2-2	2-1	Brush guard cover	4-5j	4-6
Brush guard cover	4-5j	4-6	Control switch, heater	4-5c	4-6
Canvas doors and side curtains, in- stalling, removing and stowage	4-16	4-11	Defroster control handle	4-5e	4-6
Canvas top, installing, removing and stowage	2-17	2-13	Diverter actuator damper control handle	4-5f	4-6
Capacities, tabulated data	1-16	1-16	Electrical controls	4-3c	4-3
Carbon monoxide warning ( <i>See</i> in- side front cover)			Emergency switch	4-5b	4-6
Caution, name and instruction plates ( <i>See</i> Name, caution and instruc- tion plates)			Exhaust diverter control handle	4-5g	4-6
Caution notices ( <i>See</i> Operators pre- caution page(s))			General	4-5a	4-6
Changing wheel and tire assembly	3-25	3-21	Indicator light	4-5h	4-6
Choke, location of	2-4g	2-3	Reset button	4-5d	4-6
Clutch pedal, location of	2-4g	2-3	Slave receptacle	4-5i	4-6
Common tools and equipment	3-3	3-1	Cooling system	1-9	1-6
Controls:			Draining	3-27a	3-21
Deepwater fording kit:			Extreme hot-weather maintenance	3-30a	3-24
Fording valve	4-28a	4-20	Filling	3-27b	3-22
Fuel tank cap	4-28b	4-21	Tabulated data	1-16g	1-16
Driving controls:			Correcting tire valve leaks:	3-26	3-21
Directional turn signals	2-4e	2-3	Corrective maintenance	3-25	3-21
Light switch	2-4d	2-3	Data:		
Other controls	2-4g	2-3	Deepwater fording kit	4-27	4-20
			Fire extinguisher, portable	4-41	4-27
			Generator (alternator) kit, 100 amperes:		
			Generator (alternator)	4-34a	4-25

INDEX—Continued

	Paragraph	Page		Paragraph	Page
Rectifier .....	4-34b	4-25	Vehicle destruction, method		
Regulator .....	4-34c	4-25	No. 4, mechanical .....	5-4d	5-2
Hardtop enclosure kit .....	4-11	4-10	Weapons and ammunition		
Hot water heater kit (-25° F) .....	4-20	4-16	destruction .....	5-5	5-3
Rifle mount, M4 pedestal			Detecting and reporting .....	3-24b	3-17
(machinegun) .....	4-46	4-27	Differences between vehicle models ..	1-14	1-8
Rifle mount, M14 rifle .....	4-51	4-29	Dimensions, tabulated data .....	1-16o	1-17
Rifle, 106mm recoilless .....	2-25	2-20	Door and side curtain kit:		
Vehicle, tabulated .....	1-16	1-16	Description .....	4-16	4-11
Winterization kit (-65° F) .....	4-4	4-5	Operating instructions .....	4-17	4-11
Deepwater fording .....	4-29	4-21	Preventive maintenance .....	4-18	4-13
Deepwater fording kit:			Draining and filling cooling system:		
Controls .....	4-28	4-20	Draining .....	3-27a	3-21
Data .....	4-27	4-20	Filling .....	3-27b	3-22
Description .....	4-26a	4-19	Driving controls ( <i>See</i> Controls,		
Lubrication .....	4-31	4-23	driving)		
Name, caution and instruction			Driving in reverse .....	2-12	2-11
plates .....	4-26b	4-19	Driving instructions .....	2-10	2-9
Operating instructions .....	4-29	4-21	Driving notes and cautions .....	2-10	2-9
Preventive maintenance .....	4-30	4-21	Electrical system .....	1-10	1-6
Troubleshooting .....	4-32	4-23	Electrical system, tabulated data .....	1-16j	1-17
Description:			Engine:		
Ambulance, frontline .....	2-32	2-24	Cooling system .....	1-9	1-6
Controls ( <i>See</i> Controls)			Description .....	1-7	1-4
Brake systems .....	1-11	1-7	Starting .....	2-6	2-5
Deepwater fording kit .....	4-26	4-19	Tabulated data .....	1-16n	1-17
Door and side curtain kit .....	4-16	4-11	Temperature gage .....	2-5d	2-5
Electrical system .....	1-10	1-6	Equipment improvement recom-		
Engine .....	1-7	1-4	mendations .....	1-3c	1-2
Engine cooling system .....	1-9	1-6	Equipment serviceability criteria .....	1-4	1-2
Fire extinguisher, portable .....	4-40	4-27	Extreme cold-weather conditions:		
Generator (alternator) kit, 100			General problems .....	2-19a	2-16
ampere .....	4-33	4-24	Winterization equipment .....	2-19b	2-16
Hardtop enclosure kit .....	4-10	4-9	Extreme cold-weather maintenance		
Hot water heater kit (-25° F) .....	4-19	4-14	problems .....	3-29	3-24
Instruments and indicators ( <i>See</i>			Extreme hot-weather maintenance:		
Instruments and indicators)			Batteries .....	3-30b	3-24
Rifle mount, M4 pedestal			Chassis and body .....	3-30c	3-24
(machinegun) .....	4-46	4-27	Cooling system .....	3-30a	3-24
Rifle mount M14 rifle .....	4-51	4-29	Extreme cold-weather operation:		
Rifle, 106mm recoilless .....	2-24	2-20	At halt or parking .....	2-20b	2-17
Suspension .....	1-13	1-8	General .....	2-21a	2-17
Vehicles .....	1-6	1-2	Fan belts, tabulated data .....	1-16n	1-17
M151 .....	1-6b	1-3	Filling the radiator .....	3-27	3-21
M151A1 .....	1-6c	1-4	Fire extinguisher, portable:		
M151A1C .....	1-6d	1-4	Controls .....	4-42	4-27
M718 .....	1-6e	1-4	Data .....	4-41	4-27
Winterization kit (-65° F) .....	4-3	4-1	Description .....	4-40	4-27
Destruction of materiel to prevent			Name and instruction plate .....	4-43	4-27
enemy use:			Operating instructions .....	4-44	4-27
Vehicle destruction, method No. 1			Preventive maintenance .....	4-45	4-27
burning .....	5-4a	5-2	Firing limits of 106mm recoilless		
Vehicle destruction, method No. 2,			rifle .....		
demolition .....	5-4b	5-2	Fording, normal .....	2-23b	2-19
Vehicle destruction, method No. 3,			Fording operation:		
gunfire .....	5-4c	5-2	Accidental submersion .....	2-23f	2-19
			Deepwater fording .....	4-29	4-21

## INDEX—Continued

	Paragraph	Page		Paragraph	Page
Determine the feasibility of fording .....	2-23c	2-19	Controls and instruments .....	4-35	4-25
Fording precautions .....	2-23d	2-19	Data .....	4-34	4-25
General .....	2-23a	2-19	Description .....	4-33	4-24
Normal fording .....	2-23b	2-19	General .....	4-33a	4-24
Operation after normal fording .....	2-23e	2-19	Generator (alternator) .....	4-33b	4-24
Forms, records and reports .....	1-3a	1-2	Lubrication .....	4-38	4-25
Field report of accidents .....	1-3b	1-2	Operating instructions .....	4-36	4-25
Report of deficiencies .....	1-3c	1-2	Preventive maintenance .....	4-37	4-25
Vehicle operation and maintenance .....	1-3a	1-2	Rectifier .....	4-33d	4-24
Front wheel drive:			Regulator .....	4-33c	4-24
Disengaging .....	2-10K	2-9	Troubleshooting .....	4-39	4-25
Engaging .....	2-10j	2-9	Ground contact .....	2-10o	2-11
Fuel .....	1-16b	1-16	Hardtop enclosure kit:		
Fuel gage .....	2-5e	2-5	Controls .....	4-12	4-10
Fuel pump .....	1-8b	1-5	Data .....	4-11	4-10
Fuel system .....	1-8	1-5	Description .....	4-10	4-9
Air cleaner .....	1-8d	1-5	Lubrication .....	4-14	4-10
Carburetor .....	1-8c	1-5	Preventive maintenance .....	4-13	4-10
Fuel pump .....	1-8b	1-5	Troubleshooting .....	4-15	4-10
Fuel tank .....	1-8a	1-5	Headlight high beam indicator .....	2-5b	2-5
Tabulated data .....	1-16c	1-16	Headlight high beam selector switch .....	2-4g	2-3
Fuel tank .....	1-8a	1-5	Heater, winterization kit (-65° F) (See Winterization kit (-65° F))		
Gage, oil pressure .....	2-5c	2-5	Heater (-65° F), unattended operation .....	4-6b	4-7
General:			Hot water heater kit (-25° F):		
Controls and instruments .....	2-3	2-2	Controls .....	4-21	4-16
Deepwater fording kit .....	4-26a	4-19	Data .....	4-20	4-16
Destruction of materiel to prevent enemy use .....	5-3	5-1	Description .....	4-19	4-14
Extreme cold-weather operation .....	2-20a	2-16	Lubrication .....	4-24	4-18
Extreme cold-weather problems .....	2-19a	2-16	Operating instructions .....	4-22	4-17
Extreme hot-weather operation .....	2-21a	2-17	Preventive maintenance .....	4-23	4-18
Fording operation .....	2-23a	2-19	Troubleshooting .....	4-25	4-18
Generator (alternator) kit, 100 amperes .....	4-33a	4-24	Ignition switch, location of .....	2-4g	2-3
Hot water heater kit (-25° F) .....	4-19a	4-14	Indicators and instruments (See Instruments and indicators)		
Lubrication instructions under usual conditions .....	3-6a	3-1	Installing, removing and stowing canvas enclosure (See Door and side curtain kit)		
Materiel used in conjunction with major item .....	4-1	4-1	Installing, removing and stowing canvas top (See Canvas top)		
Operation under unusual conditions .....	2-18	2-16	Instruction, name and caution plates (See Name, caution and instruction plates)		
Operation under usual conditions .....	2-6	2-5	Instruments and indicators:		
Parts, tools and equipment .....	3-1	3-1	Battery generator indicator .....	2-5a	2-5
Preventive-maintenance services .....	3-16	3-11	Engine temperature gage .....	2-5d	2-5
Scope .....	1-1	1-1	Fuel gage .....	2-5e	2-5
Service upon receipt of materiel .....	4-2a	4-1	Headlight high beam indicator .....	2-5b	2-5
Service upon receipt of vehicle .....	2-1	2-1	Oil pressure gage .....	2-5c	2-5
Winterization kit (-65° F) .....	4-3a	4-1	Speedometer .....	2-5f	2-5
General conditions, operation under unusual conditions .....	2-18	2-16	Intervals, lubrication .....	3-5	3-1
General lubrication instructions under unusual conditions .....	3-12	3-8	Intervals, preventive-maintenance services .....	3-19	3-11
General procedures for all services and inspections .....	3-20	3-12			
Generator (alternator) kit, 100 amperes:					

INDEX—Continued

	Paragraph	Page		Paragraph	Page
Kits, special purpose ( <i>See</i> Special purpose kits)			Heater, winterization (—65° F)	4-3b	4-2
Lights ( <i>See</i> Operating the lights)			Hot water heater (—25° F)	4-19f	4-15
Loading and blocking instructions	5-2	5-1	Vehicle	1-15	1-9
Lubricating materials	3-5	3-1	Oil pressure gage	2-5c	2-3
Lubrication chart	3-5	3-1	Operating instructions:		
Lubrication, do not lubricate points	3-10	3-8	Ambulance, frontline, M718	2-35	2-24
Lubrication locations	3-7	3-1	Deepwater fording kit	4-29	4-21
Lubrication, organizational maintenance lubricate points	3-10	3-8	Door and side curtain kit	4-17	4-11
Lubrication under unusual conditions:			Driving the vehicle	2-10	2-9
After fording operations	3-14	3-9	Engine	2-9	2-7
Below 0° F	3-13	3-9	Fire extinguisher, portable	4-44	2-1
Changing grades of lubricant	3-12b	3-8	Front wheel drive	2-10j	2-9
Dusty and sandy conditions	3-15	3-11	Generator, service upon receipt of vehicle	2-1	2-1
Maintaining proper lubrication level	3-12c	3-9	Generator (alternator) kit, 100 amperes	4-36	4-25
Service intervals	3-12a	3-8	Hot water heater kit (—25° F)	4-22	4-17
Lubrication under usual conditions:			Light switch	2-4d	2-3
Application points	3-7	3-1	Operating precautions	2-2c	2-2
General	3-6a	3-1	Reverse	2-12	2-11
Kits ( <i>See</i> Special purpose listings)			Rifle mount, M4	4-47	4-28
Oil can points	3-9	3-8	Rifle mount, M14	4-52	4-29
Organizational maintenance	3-10	3-8	Rifle, 106mm recoilless	2-28	2-20
Reports and records	3-8	3-1	Starter switch	2-4b	2-3
Weapons lubrication	3-11	3-8	Stopping the vehicle	2-11	2-11
Lubrication, weapons	3-11	3-8	Throttle	2-4c	2-3
Maintenance after fording ( <i>See</i> Materiel, maintenance of, after fording)			Towing the vehicle	2-15	2-11
Maintenance after operation on unusual terrain:			Transfer shift lever	2-4a	2-3
Mud	3-32a	3-25	Windshield	2-16	2-12
Sand or dust	3-32b	3-25	Winterization kit (—65° F)	4-6	4-6
Maintenance allocation	1-2	1-1	Operating precautions	2-7	2-5
Materiel, maintenance of after fording:			Operating the lights	2-4d	2-3
Batteries	3-31e	3-25	Operation after normal fording	2-23e	2-19
Body and chassis	3-31b	3-25	Operation on unusual terrain:		
Condensation	3-31i	3-25	After-operation procedures	2-22c	2-19
Distributor	3-31h	3-25	General	2-22a	2-18
Electrical connections	3-31f	3-25	Recommended fire pressure	2-22b	2-19
Engine, transmission, transfer case and axles	3-31c	3-25	Operation under unusual conditions	2-18	2-16
Fuel system	3-31g	3-25	Operation under usual conditions	2-6	2-5
General	3-31a	3-25	Operational readiness	3-21	3-13
Salt water immersion	3-31j	3-25	Operator participation in organizational maintenance	3-22	3-17
Wheels and brakes	3-31d	3-25	Parking the vehicle	2-13	2-11
Materiel used in conjunction with major item	4-1	4-1	Panel lights	2-5g	2-5
Mount, rifle ( <i>See</i> Rifle mount)			Parts, tools and equipment, general	3-1	3-1
Name, caution and instruction plates:			Preventive maintenance:		
Deepwater fording	4-21	4-16	Adjust if necessary	3-20b	3-12
Generator (alternator)	4-33e	4-25	After-operation service	3-21b	3-13
			Ambulance, frontline, M718	2-36	2-25
			Before-operation service	3-21b	3-13
			Daily preventive-maintenance service	3-21b	3-13
			Deepwater fording kit	4-30	4-21
			Door and side curtain	4-18	4-13
			During-operation service	3-21b	3-13
			Fire extinguisher, portable	4-45	4-27

INDEX—Continued

	Paragraph	Page		Paragraph	Page
General .....	3-16	3-11	Lubrication .....	2-30	2-22
General procedures for all services and inspections .....	3-20	3-12	Name and identification markings and plates .....	2-27	2-20
Generator (alternator) kit, 100 ampere .....	4-37	4-25	Operating instructions .....	2-28	2-20
Hardtop enclosure kit .....	4-13	4-10	Preventive maintenance .....	2-29	2-22
Hot water heater (~25° F) .....	4-23	4-18	Troubleshooting .....	2-31	2-23
Intervals .....	3-19	3-11	Scope:		
Operational readiness .....	3-21	3-13	Manual .....	1-1	1-1
Operator participation in organizational maintenance .....	3-22	3-17	Materiel used in conjunction with major item .....	4-1	4-1
Operator's role in preventive maintenance .....	3-16	3-11	Troubleshooting .....	3-23	3-17
Preventive maintenance by drivers or operators .....	3-21	3-13	Service upon receipt of kit materiel:		
Purpose .....	3-21a	3-13	Correction of deficiencies .....	4-2b	4-1
Recording repairs .....	3-18	3-11	Inspection and cleaning .....	4-2a	4-1
Responsibility .....	3-17	3-11	Service upon receipt of vehicle:		
Rifle mount, M4 .....	4-48	4-28	Break-in services .....	2-2	2-1
Rifle mount, M14 .....	4-53	4-29	Condition .....	2-1a	2-1
Rifle, 106mm recoilless .....	2-29	2-22	Lubrication .....	2-1b	2-1
Table .....	3-21	3-15	Preventive maintenance .....	2-1c	2-1
Winterization kit (~65° F) .....	4-7	4-7	Responsibility .....	2-1a	2-1
Publications (See Forms, records and reports)			Shipping instructions:		
Records, forms and reports (See Forms, records and reports)			Domestic shipping instructions ..	5-1	5-1
References .....	1-1b	1-1	Loading and blocking instructions .....	5-2	5-1
Repair parts .....	3-2	3-1	Special purpose kits:		
Repairs, recording of .....	3-18	3-11	See: Deepwater fording kit		
Report of equipment improvement .....	1-3c	1-2	See: Door and side curtain kit		
Report of publications improvement ..	1-1e	1-1	See: Generator (alternator) kit, 100 amperes		
Reports, forms and records (See Forms, records and reports)			See: Hardtop enclosure kit		
Responsibility, preventive-maintenance services .....	3-17	3-11	See: Hot water heater kit (~25° F)		
Rifle mount, M4 pedestal (machinegun):			See: Rifle mount, M4 pedestal (machinegun)		
Description and data .....	4-46	4-27	See: Rifle mount, M14 rifle		
Lubrication .....	4-49	4-29	See: Winterization kit (~65° F)		
Operating instructions and controls .....	4-47	4-28	Special tools and equipment .....	3-4	3-1
Preventive maintenance .....	4-48	4-28	Speed limits .....	2-10h	2-9
Troubleshooting .....	4-50	4-29	Speed limits caution .....	2-10h	2-9
Rifle mount, M14 rifle:			Speedometer .....	2-5f	2-5
Description and data .....	4-51	4-29	Starting the engine .....	2-9	2-7
Lubrication .....	4-54	4-30	Steering effect .....	2-10n	2-11
Operating instructions and controls .....	4-52	4-29	Stopping the vehicle .....	2-11	2-11
Preventive maintenance .....	4-53	4-29	Suspension .....	1-13	1-8
Troubleshooting .....	4-55	4-30	Systems:		
Rifle mount, M79, 106mm recoilless rifle .....	2-24	2-20	Brake .....	1-11	1-7
Rifle, 106mm recoilless:			Electrical .....	1-10	1-6
Controls and instruments .....	2-26	2-20	Engine Cooling .....	1-9	1-6
Data .....	2-25	2-20	Fuel .....	1-8	1-5
Description .....	2-24	2-20	Tables:		
			Table 1. Preventive-maintenance and services .....	3-21	3-15
			Table 2. Troubleshooting .....	3-24	3-18
			Table 3. Vehicle kits—M151 series vehicles .....	4-1	4-1

INDEX—Continued

	Paragraph	Page		Paragraph	Page
Table 4. Operator's daily preventive-maintenance services for winterization kit (-65° F) equipped vehicle	4-7	4-8	Tires	1-16h	1-16
			Tire inflation pressure	1-16i	1-16
			Turning radius	1-16s	1-18
			Vehicle kits	1-16t	1-18
Table 5. Troubleshooting winterization kit (-65° F)	4-9	4-8	Thermostat	1-9	1-6
			Tire, changing tires	3-25	3-21
Table 6. Operator's daily preventive-maintenance services for hardtop enclosure equipped vehicle	4-13	4-10	Tire valve leaks	3-26	3-21
			Tires, tabulated data	1-16h	1-16
Table 7. Troubleshooting hardtop enclosure	4-15	4-10	Tools and equipment:		
			Common	3-3	3-1
Table 8. Operator's daily preventive-maintenance services for hot water heater (-25° F) equipped vehicles	4-23	4-18	Special	3-4	3-1
			Top, hardtop ( <i>See</i> Hardtop enclosure)		
Table 9. Troubleshooting hot water heater (-25° F)	4-25	4-18	Top, soft top ( <i>See</i> Canvas top)		
			Towing the vehicle	2-15	2-11
Table 10. Operator's daily preventive-maintenance services for deepwater fording kit equipped vehicles	4-30	4-21	Transmission shift lever, location of	2-10c	2-9
			Troubleshooting:		
Table 11. Troubleshooting deepwater fording equipment	4-32	4-23	Deepwater fording kit	4-32	4-23
			Hardtop enclosure	4-15	4-10
Table 12. Troubleshooting 100-ampere charging system	4-39	4-25	Hot water heater kit (-25° F)	4-25	4-18
			Generator (alternator) kit,		
Tabulated data:			100 ampere	4-39	4-25
Brakes, parking	1-16l	1-17	Rifle mount, M4	4-50	4-29
Brakes, service	1-16k	1-17	Rifle mount, M14	4-55	4-30
Cooling system	1-16g	1-16	Rifle, 106mm recoilless	2-31	2-23
Cruising ranges	1-16q	1-18	Table	3-24	3-17
Differential capacity	1-16e	1-16	Vehicle, M151	3-23	3-17
Dimensions	1-16o	1-17	Vehicle, M151A1	3-23	3-17
Electrical system	1-16j	1-17	Vehicle, M151A1C	3-23	3-17
Engine	1-16n	1-17	Vehicle, M718	3-23	3-17
Fan belts	1-16m	1-17	Winterization kit (-65° F)	4-9	4-7
Fording depth	1-16r	1-18	Turn signal, directional	2-4e	2-3
Fuel	1-16b	1-16	Unsatisfactory materiel ( <i>See</i> Equipment improvement recommendations)		
Fuel system	1-16c	1-16	Vehicle:		
Grease	1-16f	1-16	Controls ( <i>See</i> Controls)		
Oil capacity, engine	1-16d	1-16	Accidental submersion		
Payload	1-16m	1-17	Description:		
Personnel complement	1-16p	1-17	M151 vehicle	1-6b	1-3
Speed, maximum permissible	1-16a	1-16	M151A1 vehicle	1-6c	1-4
			M151A1C vehicle	1-6d	1-4
			M718 vehicle	1-6e	1-4
			Doors and side curtain		
			Kits ( <i>See</i> Special purpose kits)		
			Top ( <i>see</i> Canvas top or hardtop)		
			Wheels and tires	1-12	1-8
			Windshield:		
			Erecting the windshield	2-16b	2-12
			Locking the windshield	2-16c	2-12
			Lowering the windshield	2-16d	2-12
			Windshield wiper, location of	2-4g	2-3
			Winterization kit (-65° F)	4-3	4-1