

The logo for the 'Rose collection' is centered within a white rectangular border. The word 'Rose' is written in a red, elegant script font. To the right of 'Rose' is a small, stylized white rose with two leaves. Below 'Rose' and the rose icon, the word 'collection' is written in a clean, white, sans-serif font.

Rose
collection

Timber-alternative sash windows



The Rose Collection is a suite of three stunning timber-alternative sash windows, designed and manufactured in the UK. They blend the charm of classic timber with the benefits of modern manufacturing techniques and materials, redefining tradition. The result is a collection of timelessly stylish sash windows that keep your home secure, warm and quiet, all in a virtually maintenance-free package that never needs repainting.

First manufactured in 1985, each window in the Rose Collection has decades of experience and expertise built-in as standard. Rose Collection windows are precisely engineered using cutting-edge manufacturing technology, then expertly crafted and impeccably hand-finished.

The Rose Collection — sash windows designed for you.

Traditional style and elegance. Modern performance. No compromises.

Contents

The Ultimate Rose	4	Energy and Security	35
The Heritage Rose	12	Design	32
The Charisma Rose	20	Refurb and New Build	36
Comparison of Models	28	Certification	38
The Rose Collection	30	Conservation	39



QUITE SIMPLY, THE
UK'S MOST AUTHENTIC
TIMBER-ALTERNATIVE
SASH WINDOW



Ultimate
Rose

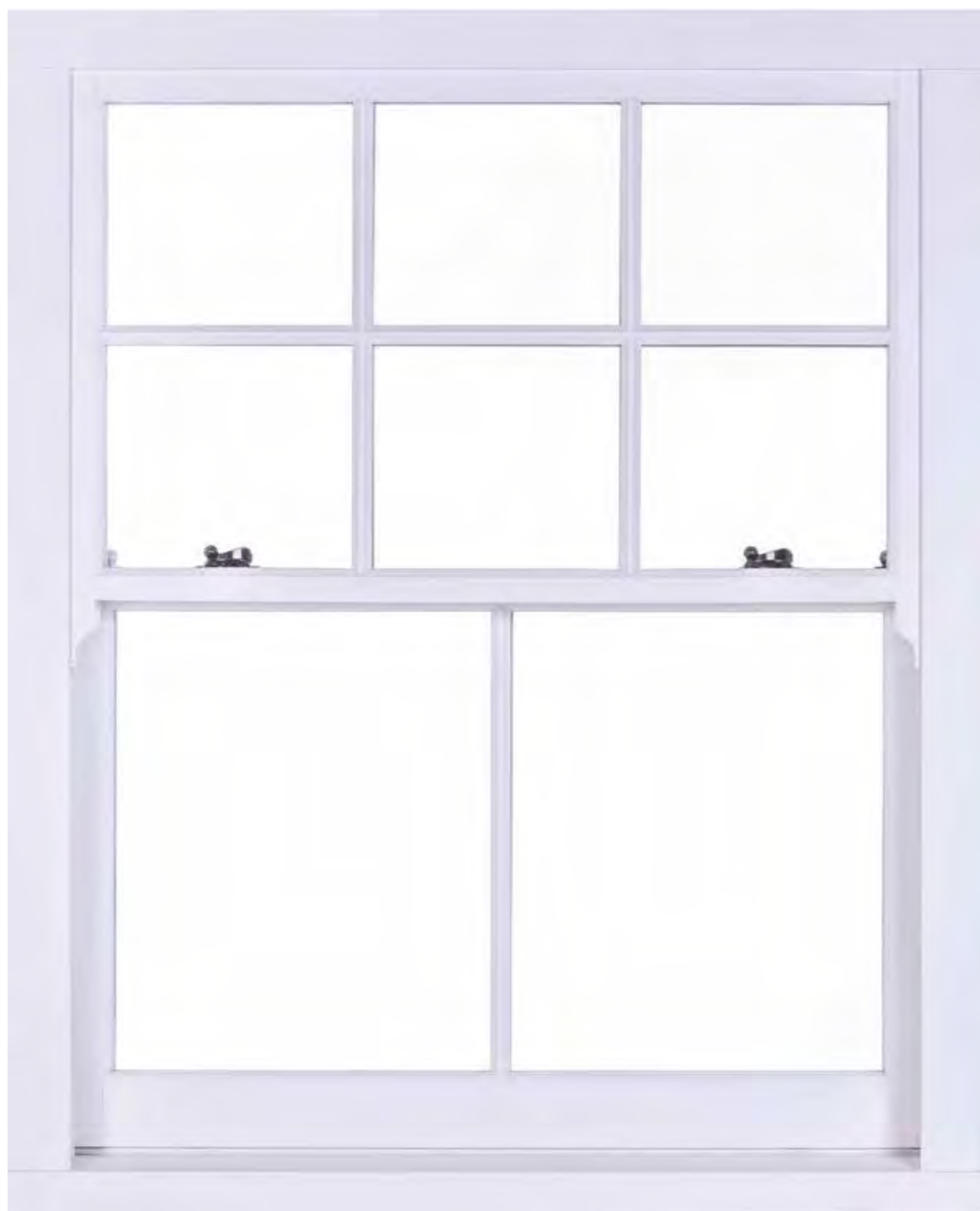

The Ultimate Rose



Ultimate Rose is the epitome of the Rose Collection design philosophy - outstanding aesthetics and exceptional performance. Ultimate Rose is, quite simply, the UK's most authentic timber-alternative sash window. It redefines tradition.

We've re-engineered the timber-alternative sash window from the ground up, looking at every seam and detail that differed from a timber original and designing it out. The ultra-slim 35mm meeting rail, the seamless run-through sash horns and even the internal sash interlock - everything has been redesigned to achieve what no other timber-alternative sash window can; a smooth, seamless finish. The result is that even from close up only an expert can tell that it's not timber.

Based around our innovative true mechanical jointing system, Ultimate Rose is built in exactly the same way as timber. There are no mitred welds or fake mechanical joints here, just simple, strong, joinery-style butt joints - horizontal on the frame and vertical on the sashes - just like a timber original.

The attention to detail matters.

But while Ultimate Rose may look identical to traditional timber sash windows, the one place it's designed to be different is in performance. 'A'-rated energy efficiency, high security and independently tested sound insulation mean that not only will your home look great with Ultimate Rose, it will be warm, quiet and secure.

Add all this together and you get a modern sash window that looks and performs better than anything else on the market.

That's why we call it Ultimate Rose.

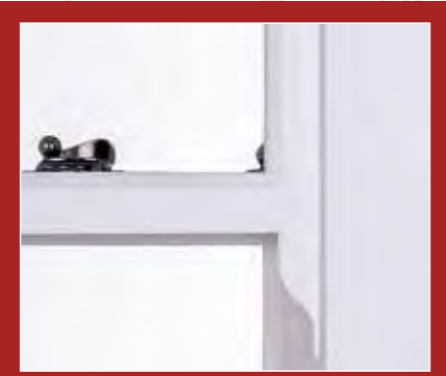

Seamless run-through horns

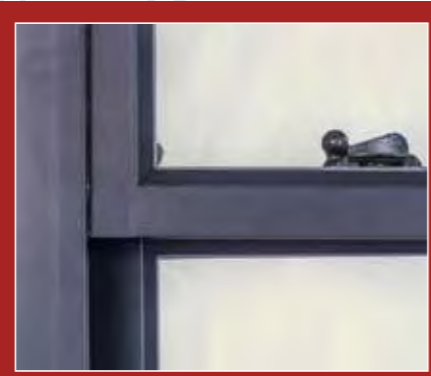

Seamless no horn option

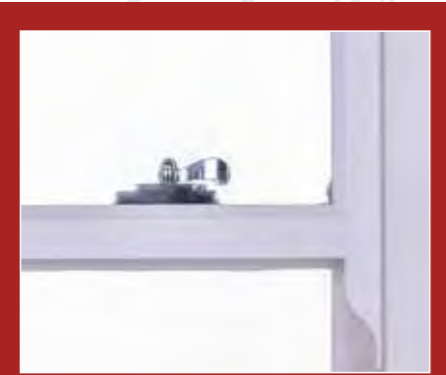

Seamless 35mm meeting rail

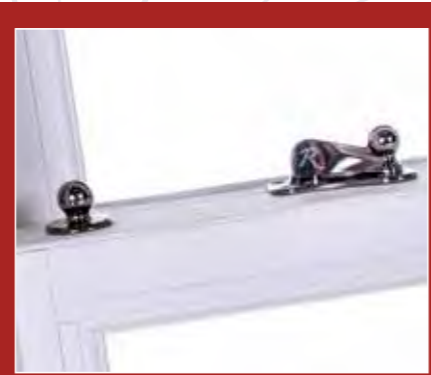

Traditional globe furniture

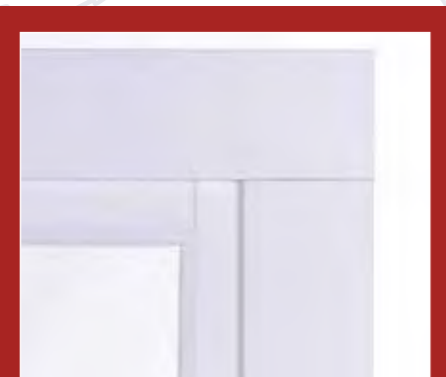

True mechanical joints

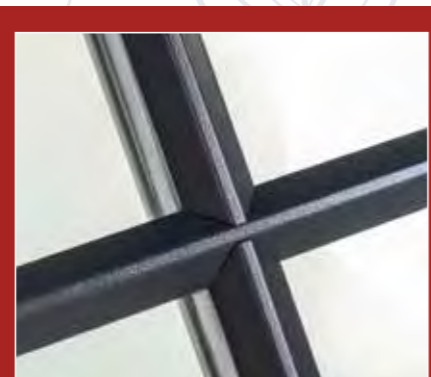

Authentic astragal bars



Optional deep cill



Optional staff bead



The Ultimate Rose

- Closed-end true mechanical joints
- Ultra-slim 35mm seamless midrail
- Seamless run-through sash horns
- Slim putty-line external profiles
- Deep bottom rail
- Optional removable staff bead
- Optional external chamber covers (coming soon)
- Aluminium-mounted authentic astragal bars
- Optional period deep cill
- Range of finishes and woodgrains
- Traditional globe furniture (note: acorn furniture required for Part Q/PAS 24)
- Tilting sashes for simple cleaning
- Maintenance-free - no more painting
- Widely specified in conservation areas

Features



Out



In

Options

Colour Options



We can also supply the Ultimate Rose window in any RAL colour. Please ask for details.

Hardware Options

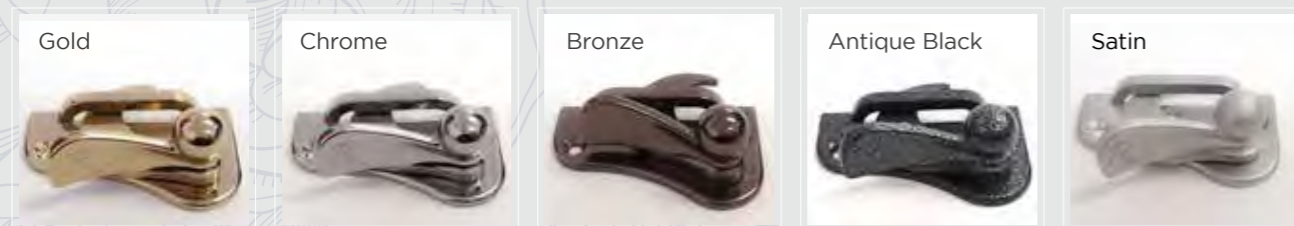

Ultimate
Rose

Technical Details

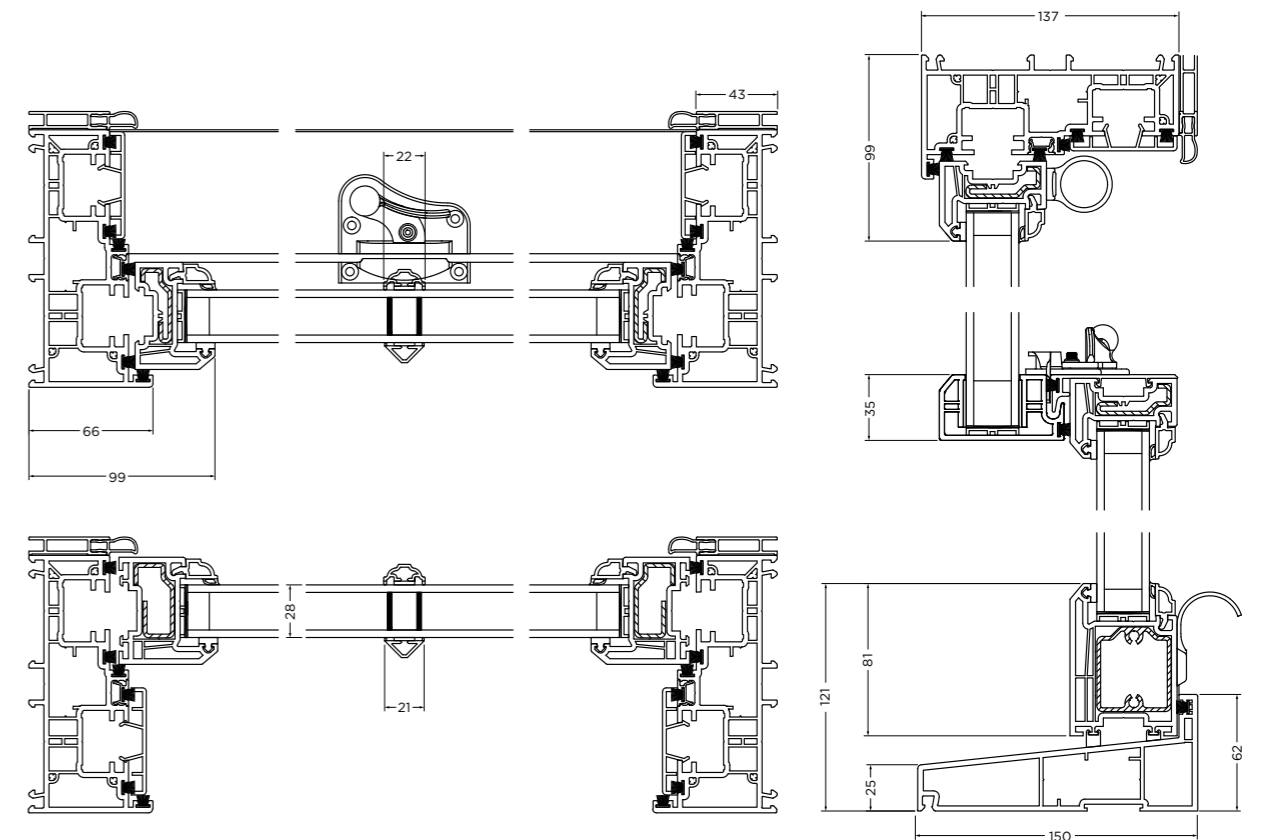

Icons with borders are standard features. Ones without borders are options.



THE QUINTESSENTIAL
PERIOD SASH WINDOW,
UPDATED FOR THE
21ST CENTURY



Heritage
Rose



The Heritage Rose



Tradition is the watchword of Heritage Rose

Second only to Ultimate Rose in terms of timber authenticity, Heritage Rose is a classically styled sash window that delivers the convenience and all-round excellence of modern uPVC.

Heritage Rose uses the same slim, putty-line profiles as Ultimate Rose, but includes a wider 44mm midrail and welded joints. It also features optional flat run-through horns, a deep bottom rail as standard and traditional chamfered astragal bars.

And while Ultimate Rose is indistinguishable from timber even from close up, the period detailing and profiles on Heritage Rose mean that from the pavement no-one will know that it isn't an original timber window.

Heritage Rose has been used in conservation areas across the UK, including the Royal Borough of Kensington and Chelsea, Cambridge, Lincoln, Snowdonia and the Lake District. Like every window in the Rose Collection it offers truly modern performance, keeping your home warm, quiet and secure.



Flat run-through horn



Mitre-welded corners



Deep bottom rail



Putty line chamfers



44mm midrail with flat interlock



Acorn furniture

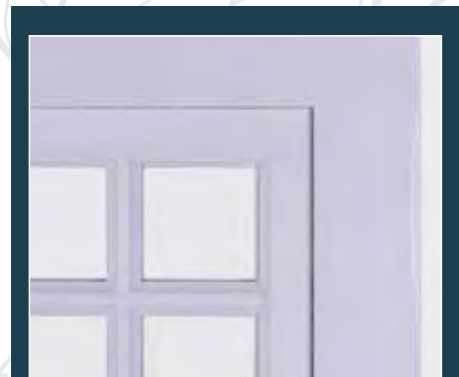

Polished weld option



Heritage astragal bars



The Heritage Rose

- Welded joints
- Slim 44mm midrail
- Optional flat faced run-through sash horns
- Slim putty-line external profiles
- Deep bottom rail
- Aluminium-mounted heritage astragal bars in a range of period designs
- Flush or protruding cills
- Range of finishes and woodgrains
- Classic acorn furniture
- Tilting sashes for simple cleaning
- Maintenance-free – no more painting

Features



Out



In

Options

Colour Options



We can also supply the Heritage Rose window in any RAL colour. Please ask for details.

Hardware Options

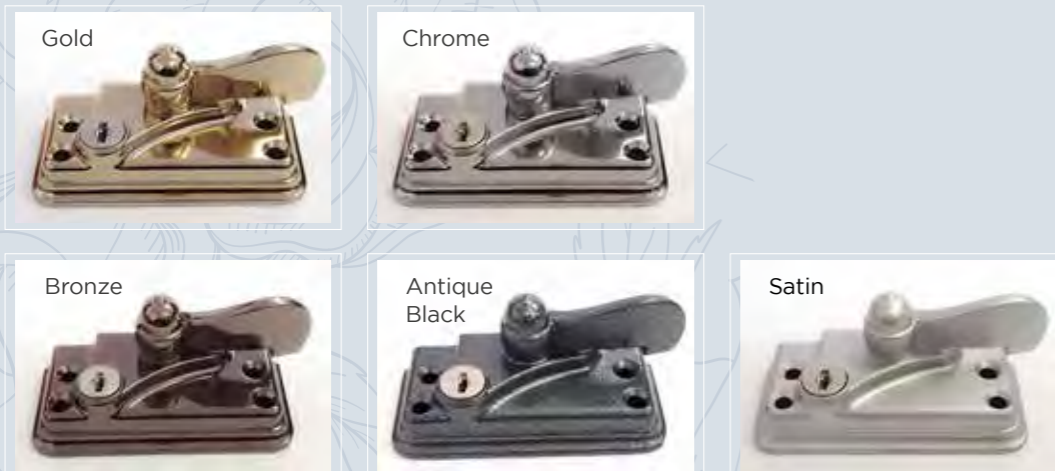

Heritage
Rose

Technical Details

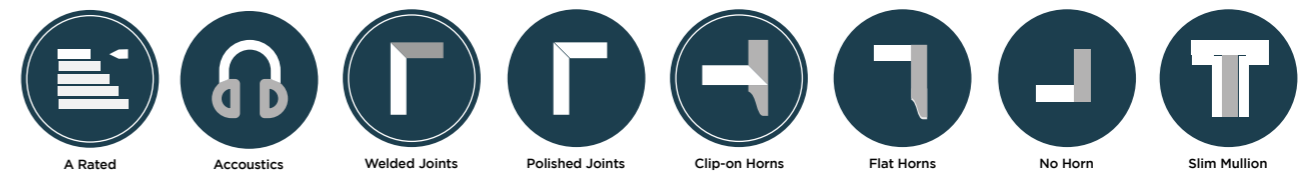
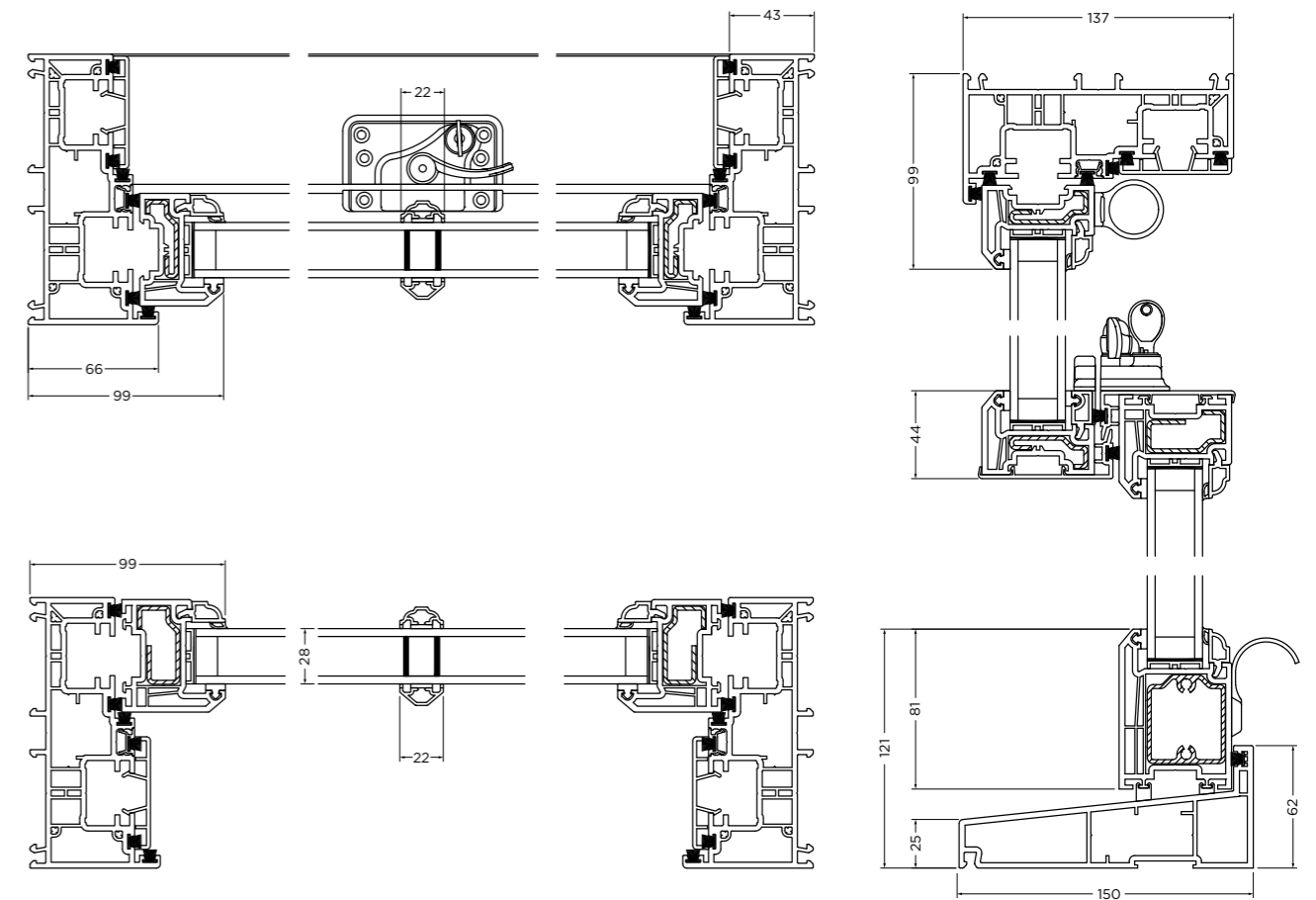

Icons with borders are standard features. Ones without borders are options.



COMPETITIVELY
PRICED PERIOD LOOKS
WITH A HOST OF
MODERN FEATURES



Charisma
Rose



The Charisma Rose



Contemporary, classic and uniquely versatile.

Take one of the most respected, competitively-priced uPVC systems on the market and turn it into a stylish timber-effect sash window – the result is Charisma Rose

With a bolder, more contemporary appearance than its Rose Collection siblings, Charisma Rose is a versatile sash window ideally suited to everything from upgrading existing windows on older properties to adding retro-chic to newly built homes. And while it may be more budget-friendly than Ultimate and Heritage Rose, it's still built with the care, attention, and high spec components that are a hallmark of the Rose Collection.

Like all windows in the Rose Collection, Charisma Rose is low-maintenance, easy to operate and comes with a wide range of options and finishes. Competitively priced, it's a great all-rounder that offers contemporary yet classic style, with vintage details and modern performance.



60mm sculptured lines



No horn option



Run-through horn option

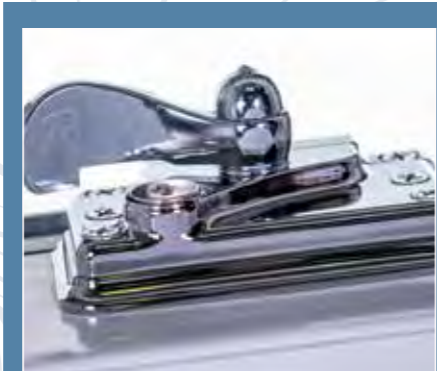

Acorn furniture

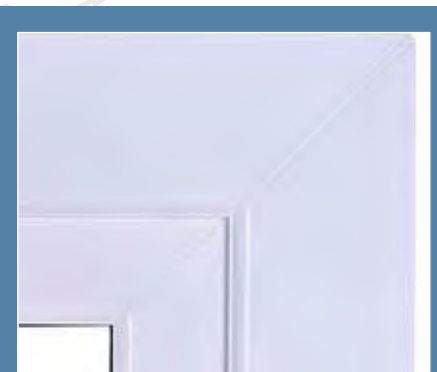

Mitre-welded corners



"Geo" astragal bars



The Charisma Rose

- Welded joints
- 60mm midrail
- Optional flat faced run-through sash horns
- Sculptured profiles
- Optional deep bottom rail
- Aluminium-mounted Geo astragal bars in a range of period designs
- Range of finishes and woodgrains
- Classic acorn furniture
- Tilting sashes for simple cleaning
- Maintenance-free – no more painting



Features



Out



In

Options

Colour Options

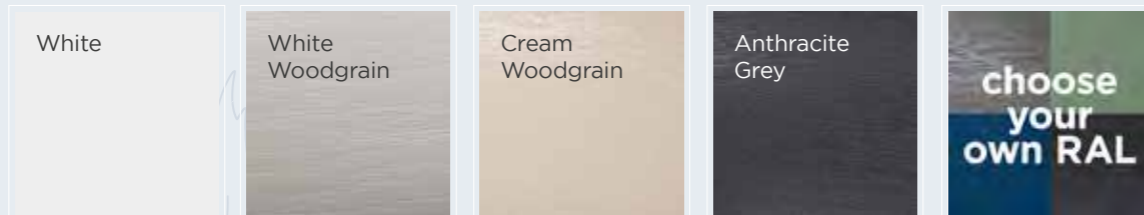

We can also supply the Charisma Rose window in any RAL colour. Please ask for details.

Hardware Options

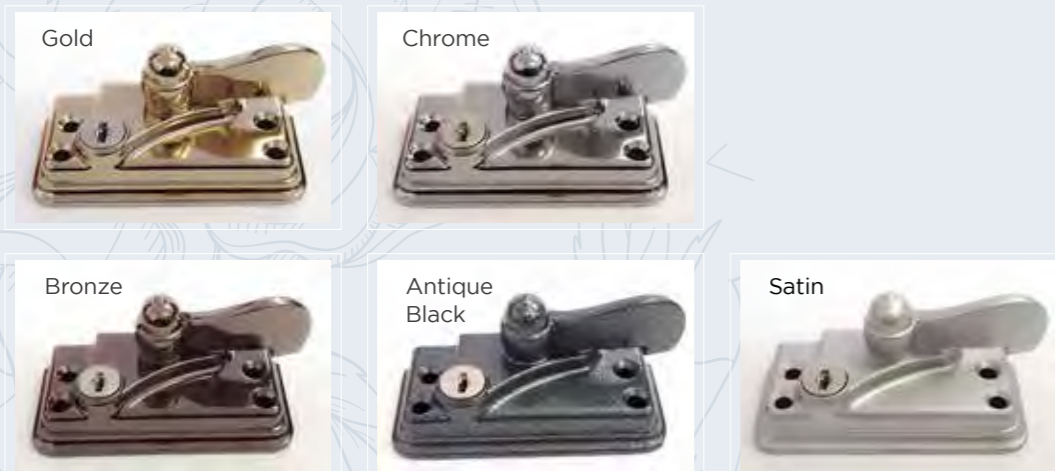

Charisma
Rose

Technical Details

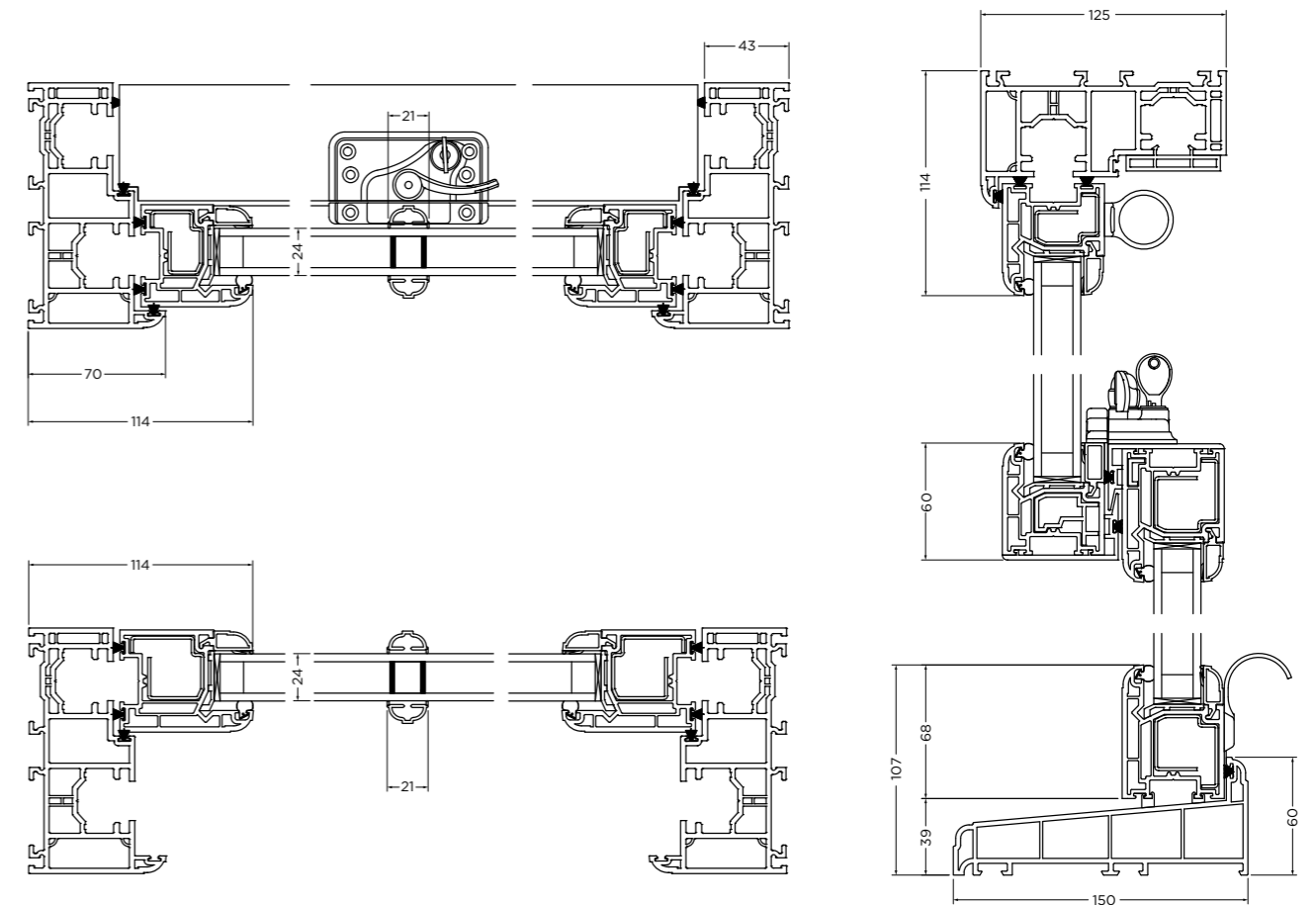

Icons with borders are standard features. Ones without borders are options.



Comparison of Models

The Rose Collection delivers unbeatable authenticity and exceptional performance. But as a range it's also hugely versatile, offering options that suit a diverse array of properties, budgets and applications.

The Collection consists of three core windows – Ultimate Rose, Heritage Rose and Charisma Rose. While each model has elements that make it unique, all three have some things in common:

- Available with or without sash horns
- 'A'-rated energy efficiency
- Upgradable acoustic protection
- Optional Secured by Design/ PAS24/Part Q security upgrade
- Available with arched or shaped heads
- Can be colour-bonded with any RAL colour
- Available in multi-part combinations and bays

The Ultimate Rose



Profile detail: putty line
Meeting rail: 35mm seamless
Run-through horn: seamless
No Horn: seamless (option)
Corner detail: true mechanical
Polished welds: not available
Deep bottom rail: standard
Deep cill: option
Astragal bars: authentic
Furniture: globe
Removable staff bead: option
Chamber cover*: option
Part Q/PAS24/SBD: option

*Coming in 2020

The Heritage Rose



Profile detail: putty line
Meeting rail: 44mm
Run-through horn: flat (option)
No horn: option
Corner detail: welded
Polished welds: option
Deep bottom rail: standard
Deep cill: not available
Astragal bars: heritage
Furniture: acorn
Removable staff bead: not available
Chamber cover*: not available
Part Q/PAS24/SBD: option

The Charisma Rose



Profile detail: sculptured
Meeting rail: 60mm
Run-through horn: flat (option)
No horn: option
Corner detail: welded
Polished welds: not available
Deep bottom rail: option
Deep cill: not available
Astragal bars: geo
Furniture: acorn
Removable staff bead: not available
Chamber cover*: not available
Part Q/PAS24/SBD: option



MORE THAN 30 YEARS
OF KNOWLEDGE,
EXPERIENCE & DESIGN
GOES INTO EVERY
SASH WINDOW
WE MAKE



Designed for you

Combine more than 30 years of sash window experience with industry-leading design, engineering and attention to detail, and you start to see why Rose Collection windows stand out from the crowd. The same amount of effort goes into every window we make, no matter which model you choose.

But more than that, we pride ourselves in doing everything we can to tailor our windows to your needs. No matter how complex or individual your specific requirements, if it's possible, we'll work out how to do it.

From curved and Gothic arches to bespoke astragal bar and glass designs, there isn't much we haven't seen before. The features shown on this page are just some of the ways in which we can help make your vision a reality.

Astragal bar designs



Arches & shapes

Although most sash windows are rectangular, arched and shaped heads are more popular than you may think. From gentle curves and fully semi-circular true arches, to pointed gothic arches and straight angled heads, we can manufacture your sash windows to virtually any shape you require.



Bay windows

Stone, brick or bay poles. Square or flared. Two, three, four or more parts. With our help you can achieve any bay configuration you require with a combination of sash windows.



Slim mullion combinations

On Ultimate and Heritage Rose, as well as coupling windows together we can offer slim mullion combinations, narrowing the vertical coupling to give a more traditional appearance.

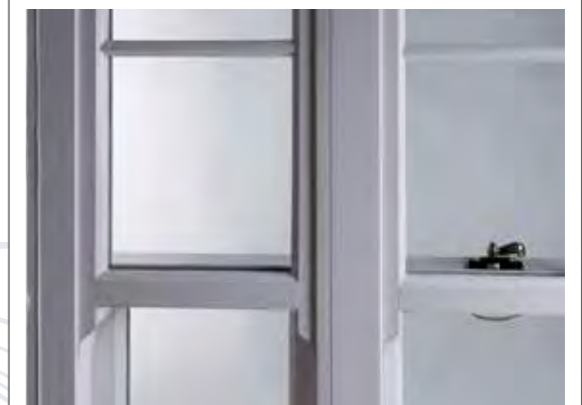

Hand Crafted Engineering



Rose Collection sash windows effortlessly combine high-quality modern performance with detailed vintage aesthetics, using durable, long-lasting, maintenance-free modern materials. Manufacturing windows this way requires a complex mix of traditional craftsmanship and cutting-edge modern technology, brought together by years of experience and knowledge.

More often than not, standard uPVC windows are manufactured in large factories filled with more equipment than staff. Windows are made in hours, with very little human participation. Our Buckinghamshire manufacturing facility couldn't be more different.

Split into two distinct areas, the first part of the factory is where we cut, mill, reinforce and – on Heritage and Charisma Rose – weld. We've invested heavily in the very best machinery here – our state of the art machining centre, saws, CNC millers and multi-head welders ensure accuracy and consistency at the start of the manufacturing process.

After that, the cut and milled profiles pass into the second part of our factory, where windows are assembled, finished and glazed. This part couldn't be more different, with more than 40 staff and very little machinery involved. It's more like a large joinery than a modern window factory.

Our skilled, experienced staff do everything by hand, from completing the mechanical butt joints to glazing and applying astragal bars. Instead of taking mere hours, windows spend a week in our factory, from saw to door.

It's only this combination of state of the art technology and traditional craftsmanship that allows us to make stunning, authentic timber-alternative sash windows that offer the highest levels of modern performance.

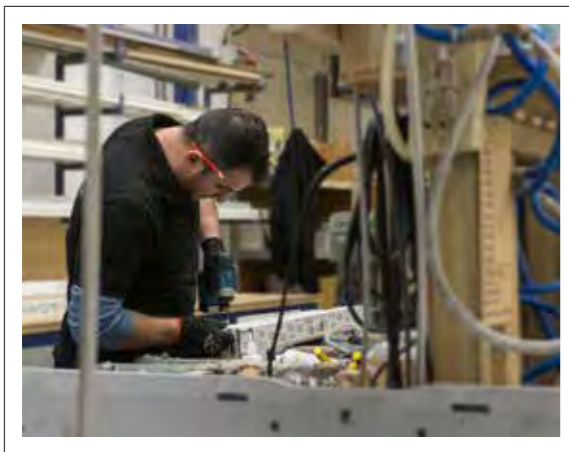

uPVC in Conservation Areas



Sash windows are quintessentially British; they've been an important part of our architectural heritage since the 17th century. Unfortunately, many original sash windows have already been lost; replaced with inappropriate low-cost casements that aren't sensitive to their surroundings.

In response, more and more parts of the UK are being designated as conservation areas, sometimes with the extra protection of an Article 4 Directive. This helps to preserve the character and appearance of an area, and in doing so protect our architectural heritage.

Rose Collection sash windows have heritage and conservation at the heart of their design. In an area where sash windows are common, the Rose Collection blends in perfectly—a far superior option than the “mock sash” casement windows used so often in the past.

As you move up the model range, so you move up in terms of authenticity. At the top you have Ultimate Rose—a window that looks and feels exactly like an original timber sash window, even from close up. In fact they're so authentic, we often receive comments from customers who say that people don't know they've replaced their windows with Rose Collection timber-alternatives. That's why Rose Collection sash windows have been approved for use on projects in conservation areas across the UK.

You should always check with your local authority to see if your project requires permission. Your local Rose Collection Approved Installer can help guide you through this process.



Refurb and New Build

While Rose Collection sash windows are an obvious choice for refurbishment projects, they're also popular in new builds. And while the windows used for each project type are the same, the requirements of those projects differ widely.

Typically sash windows are used in three scenarios: refurbishments where original sash windows are being replaced, refurbishments where sashes have previously been replaced with something less appropriate, and new buildings built in a classic style.

On refurbishment projects replacement windows have to be authentic, while offering improved performance over the windows they are replacing. Aesthetics are critical; whether it's a period property in a conservation area or simply a traditional home that was built for sash windows. Once the look and feel are right, the low-maintenance energy efficiency, security and acoustic benefits are a welcome bonus.

On new builds priorities are a little different. Certification is key as regulations are much tighter than

on replacement windows. Energy efficiency, security, ventilation, opening restrictions – these are all areas that need to pass stringent building regulations. Windows still need to look great, but they don't necessarily have to match period windows in adjacent buildings. Instead, they need to realise the vision of the architect or self-builder while fully complying with building regulations.

Fortunately we've designed Rose Collection sash windows to work equally well in both refurbishment and new build projects. They have the classic style, slim sightlines and period detailing demanded by authentic refurbishments, while offering the full spectrum of modern performance benefits – backed up by independently tested certification – that modern building regulations require.

On older properties sash windows are usually check fitted – sitting behind the outer brickwork on a stepped reveal with only a small amount of frame visible. On new builds they're usually reveal fitted – installed directly into a flat window reveal with all of the frame showing.



Certification

Rose Collection sash windows aren't just about authenticity and style; they also provide all the benefits you'd expect from cutting-edge design and modern materials and manufacturing techniques. So whether you're replacing old windows or building in new ones, you can be confident that your sash windows will offer both the performance and compliance that you need.

Energy Efficiency

All our windows are 'A' rated as standard, with a U-value of 1.5 W/m²K. With different glazing this can be further enhanced where required.

Weatherproofing

Rose Collection sash windows are independently tested to BS6375 for air and water permeability and wind loading. All models achieve Class 3 for air permeability, up to 8A – the highest you can get – for water tightness, and 1600 Pa (114.3 mph) for wind loading, which is classed as hurricane level.

Part Q/ PAS 24

All Rose Collection sash windows are optionally available with the enhanced security that provides PAS 24:2016 accreditation and Part Q compliance for new builds.

Sustainability

uPVC is fully recyclable up to ten times, giving it a 350 year lifespan. Moreover, this is closed-loop recycling – new windows made from old.

Secured by Design

Building on our PAS 24:2016 format, all Rose Collection sash windows are available with Secured by Design accreditation.

Glass and Glazing Federation

Roseview are a proud and active member of the GGF. The GGF is recognised by the UK government and plays a key role in researching and defining new regulations (including Building Regulations) relating to windows, doors and glazing.

Acoustic testing

All models in the Rose Collection have been independently tested and audited by UKAS accredited BlueSky Certification. This makes them the only uPVC sash windows on the market with dedicated acoustic accreditation.





The Rose Collection

Rose collection

Ultimate rose

Heritage rose

Charisma rose

Incarnation secondary glazing

03/20. The content of this document, photographic reproduction and technical details remain the sole property of Roseview Windows, all rights reserved. It cannot be reproduced, in whole or in part, without explicit permission. Terms and conditions of sale apply, a copy of which is available on request. Created by Karma Design www.karmadesignuk.com



