

COMBi-GTE 6,000-11,000

The multi-directional forklift designed for the safe, space saving and productive handling of long and bulky loads.

COMBiLiFT

LIFTING INNOVATION



COMBI-GTE 6000-11,000

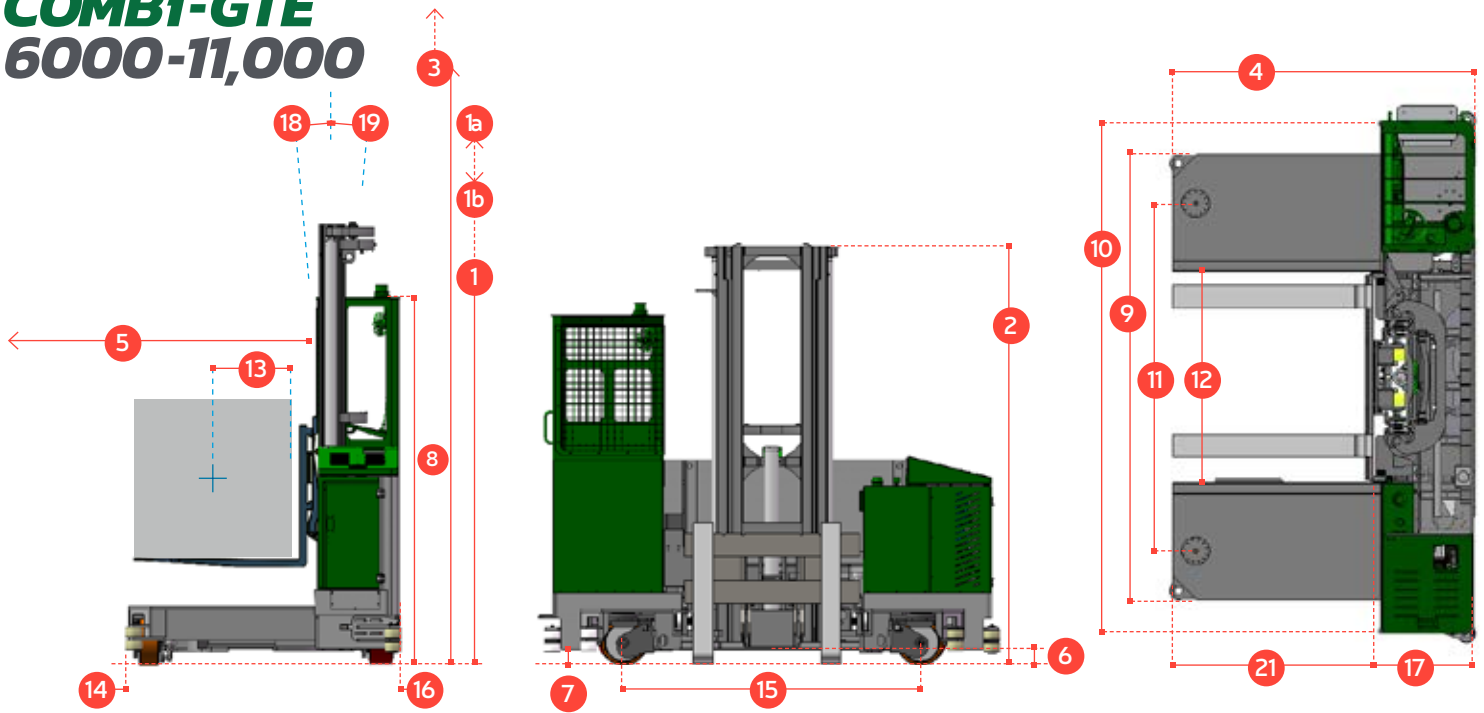

REF.	DESCRIPTION	6,000 GTE	11,000 GTE
1a	Max. Lift Height		236"
1b	Free Lift Height		150"
2	Height Mast Closed		157"
3	Max. Mast Raised		279"
4	Overall Length	50"	54"
5	Mast travel		27½"
6	Ground Clearance Under Mast		5"
7	Ground Clearance to Center of Wheelbase		5"
8	Height Over Cab (without work lights)		105"
9	Width		116¼"
10	Outside Spread of Fork Arms		53"
11	Wheelbase		90½"
12	Frame Opening		55"
13	Load Center Distance		12"
14	Overhang Front		6"
15	Track	38½"	42½"
16	Overhang Back		5½"
17	Length from Face of Fork	26"	30"
18	Forward Tilt		3°
19	Backward Tilt		4½°
20	Platform Height (with front lowered)		16½"
21	Platform Length		24"
22	Overall Width		135"
A	Capacity	6,000 lbs	11,000 lbs
B	Unladen Weight	19,000 lbs	20,500 lbs
C	Maximum Ground Speed	7 mph	
D	Gradeability	10%	
E	Battery Capacity	72 V 560 Ah	
G	Fork Section	2" x 6" x 24"	
H	350 / 150 - 280 Front Tire	OD 13¾" / Width 6"	
I	16 x 7 - 12 Rear Tire	OD 16" / Width 7"	
J	Standard Color	Yellow & Gray	

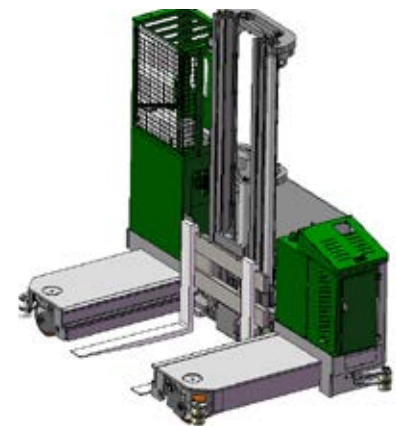

Features Include:

- Rubber Mounted Overhead Guard
- 4 Wheel Steering
- Load Sensing Steering
- 2 Wheel Hydrostatic Drive
- Tilting Chassis +/- ½" at front

Distributed by:

Optional:

- Wire Guidance
- Fold-up Forks

COMBILIFT HAS A POLICY OF CONTINUOUS PRODUCT DEVELOPMENT AND RESERVES THE RIGHT TO ALTER SPECIFICATIONS WITHOUT PRIOR NOTICE. SPECIFICATIONS AND/OR DIMENSIONS MAY VARY FROM THOSE ILLUSTRATED IN SOME COUNTRIES.

303 CONCORD STREET,
GREENSBORO,
NORTH CAROLINA 27406

TOLL FREE: 1-877 COMBI 56
TEL: 336-378-8884
INFO@COMBILIFT.COM

combilift.com