

The G5RV Antenna System -- An Analysis

Rick Hiller – W5RH



The G5RV Legacy

- Old Wives Tales
- Urban Myths
- Repeater QSO's spread:

Lies

Half-truths

Falsehoods.....



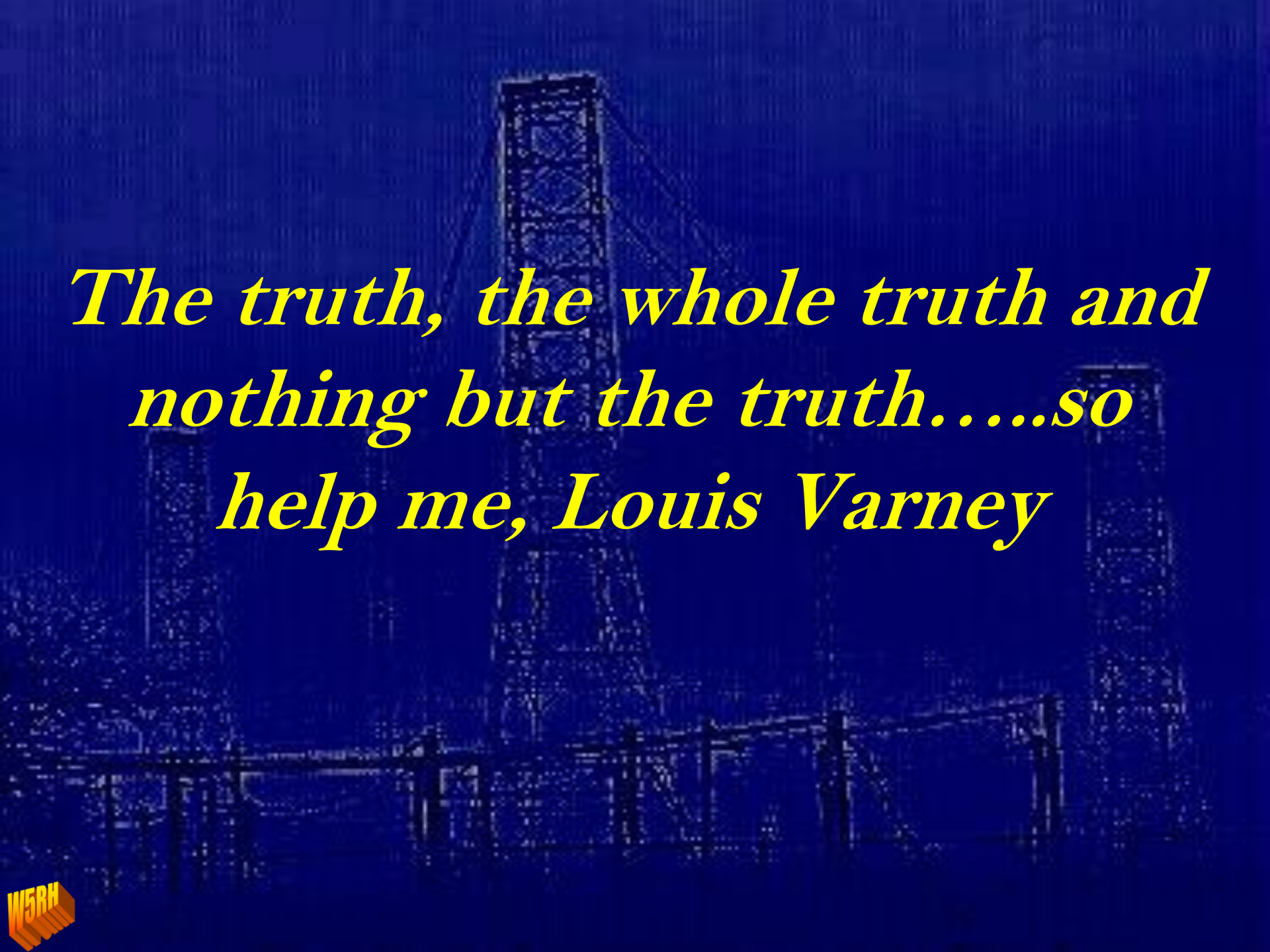

*The truth, the whole truth and
nothing but the truth.....so
help me, Louis Varney*

The G5RV Antenna System – An Analysis

- What it is / what it is not
- Multi-band coverage
- Feeding the antenna
- Modifications
- Recommended deployment

What is the G5RV (circa 1948)

- 102 foot long “Flat top”
- Center Fed with 34 feet of open wire line
- 1:1 Balun
- 75 ohm coax to the transmitter

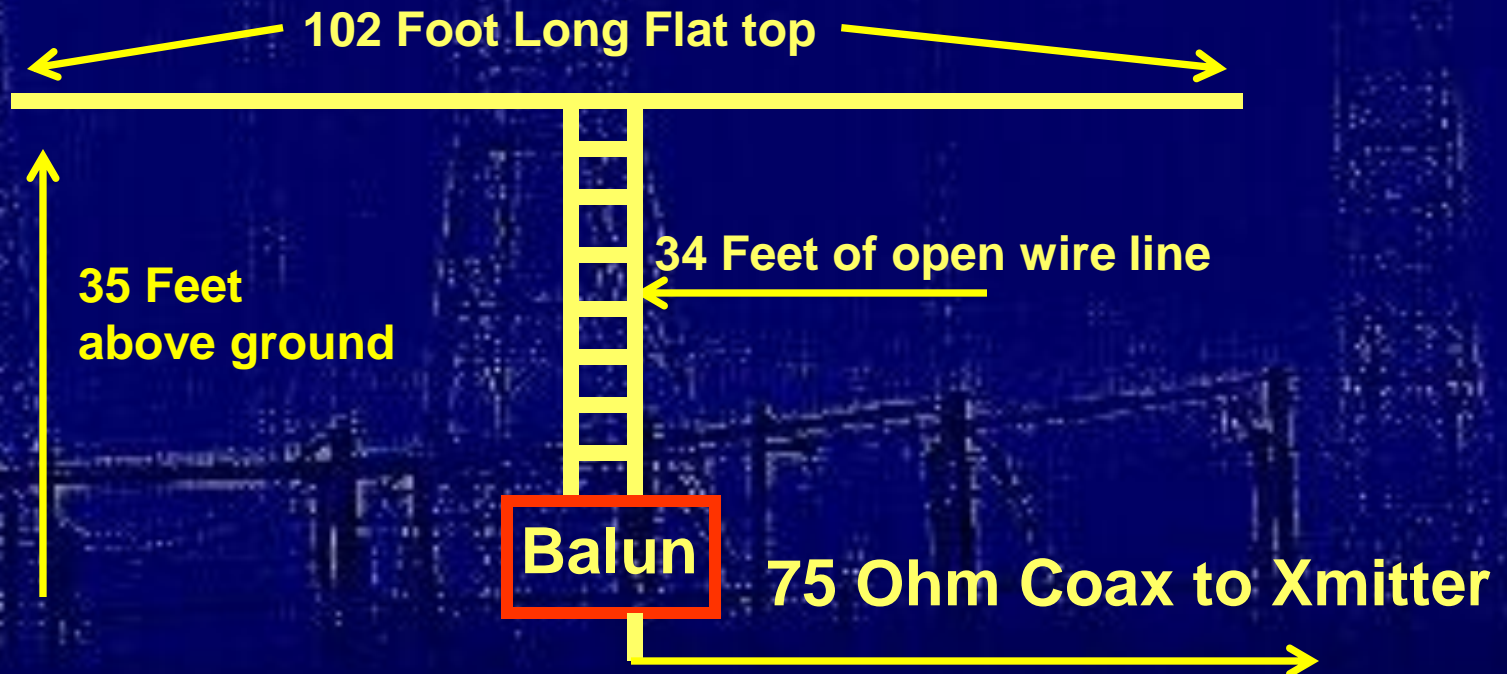

May 1925 QST, W. H. Murphy, states:

“The average transmitting amateur has simply got to fit his antenna into his space.

Just what makes the best antenna does not concern him very much. He is only interested in ‘what makes the best antenna within my space’ ”

**You do what you can do in the
“space available”**



Why this configuration?

- G5RV (2ARU) – Capt. R. Louis Varney
- Needed a gain / multi-lobed pattern for 20M DX
- His garden (back yard) was small
- Room for 1 “fixed” antenna – no W8JK or Yagi-Uda possible

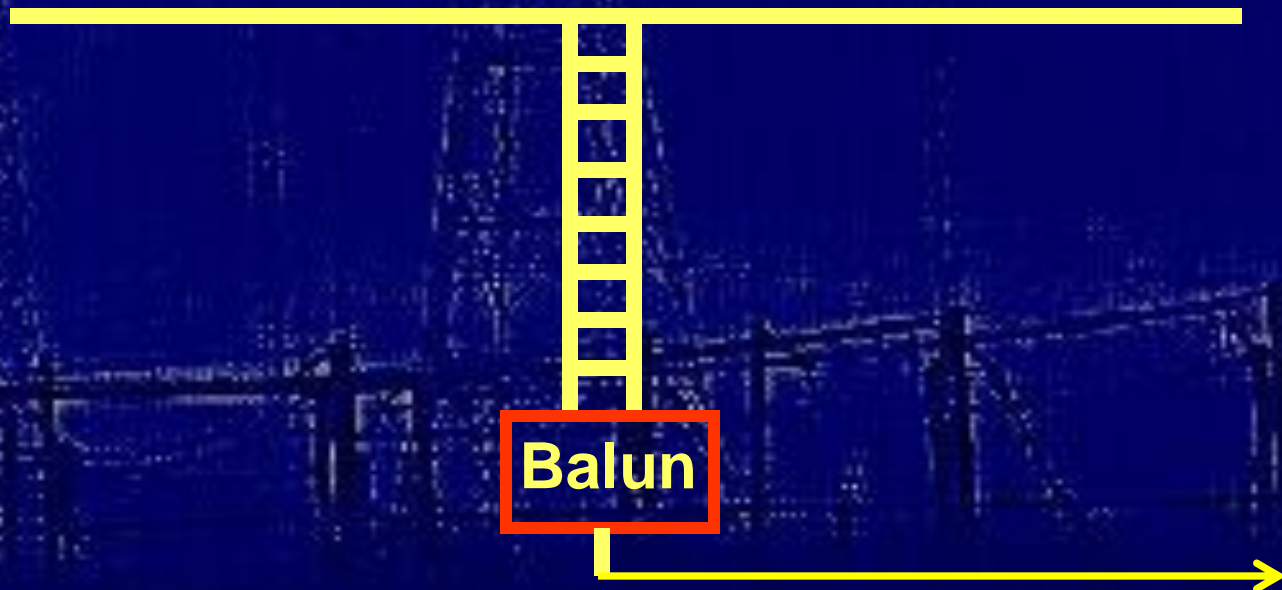

Why does it work on 20 Mx?

- 102 feet = $3/2$ wl on 14 MHz -- resonant
- Feed Z = nominally 90 Ohms +/- j 0 (resonant)
- 34 feet = $1/2$ wl (electrical) at 14 MHz
- System input R = 90 ohms +/- j 0 (approx)

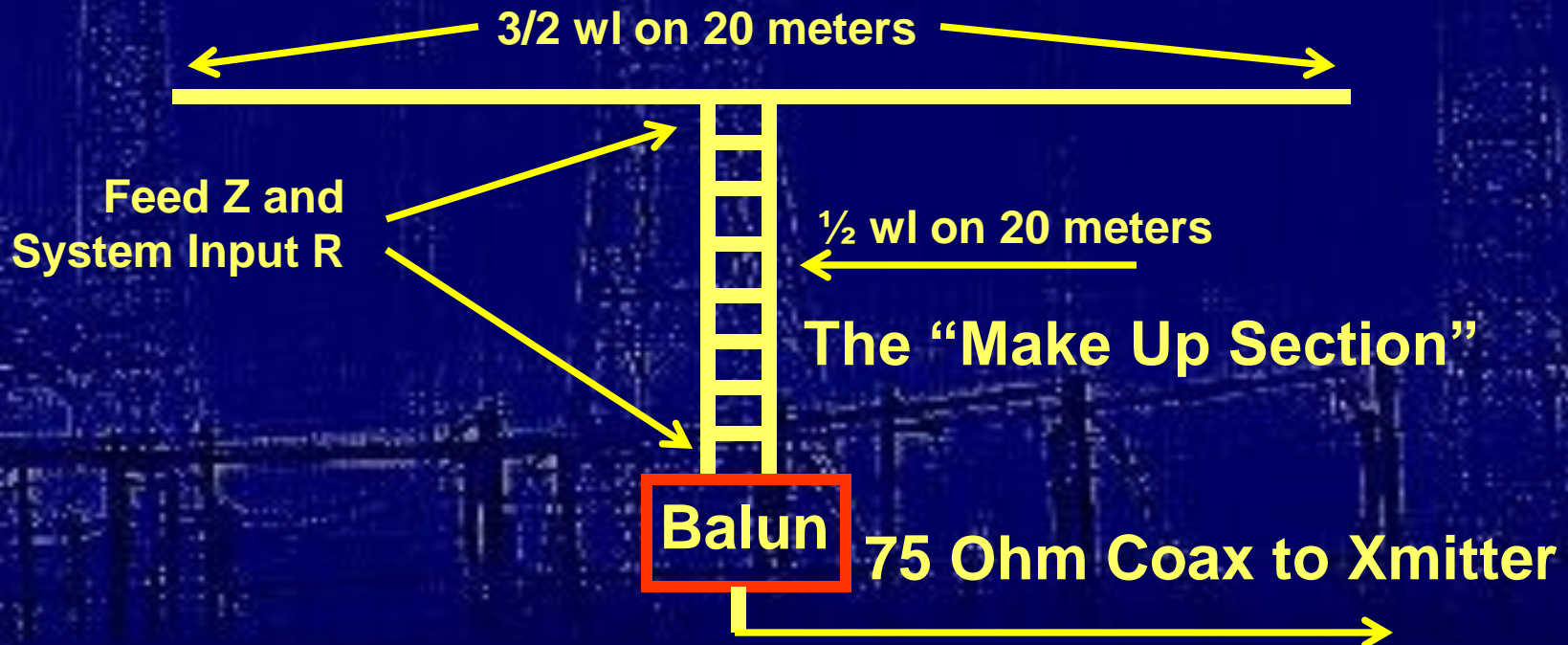

G5RV 20 Meter Standing Wave Current Distribution

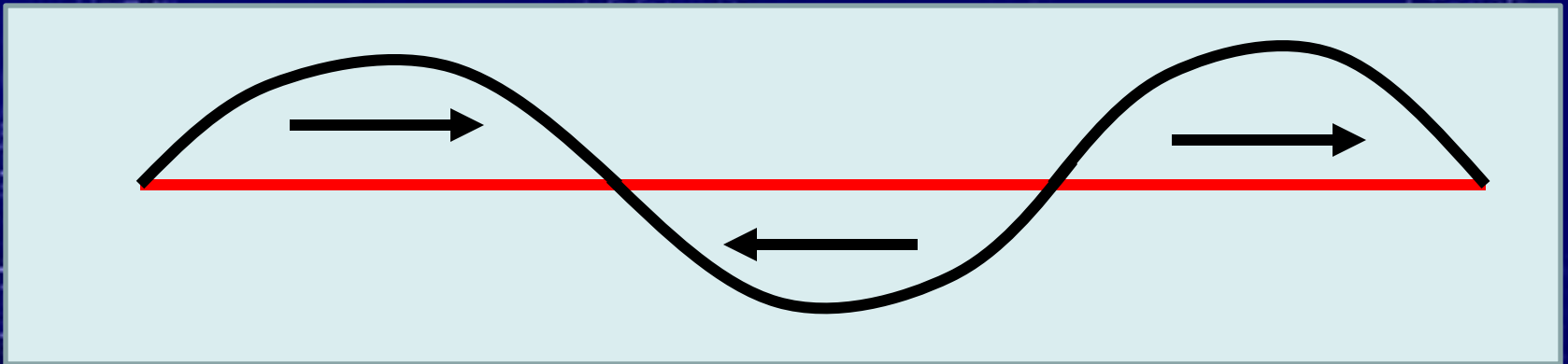

3D pattern 20 meters

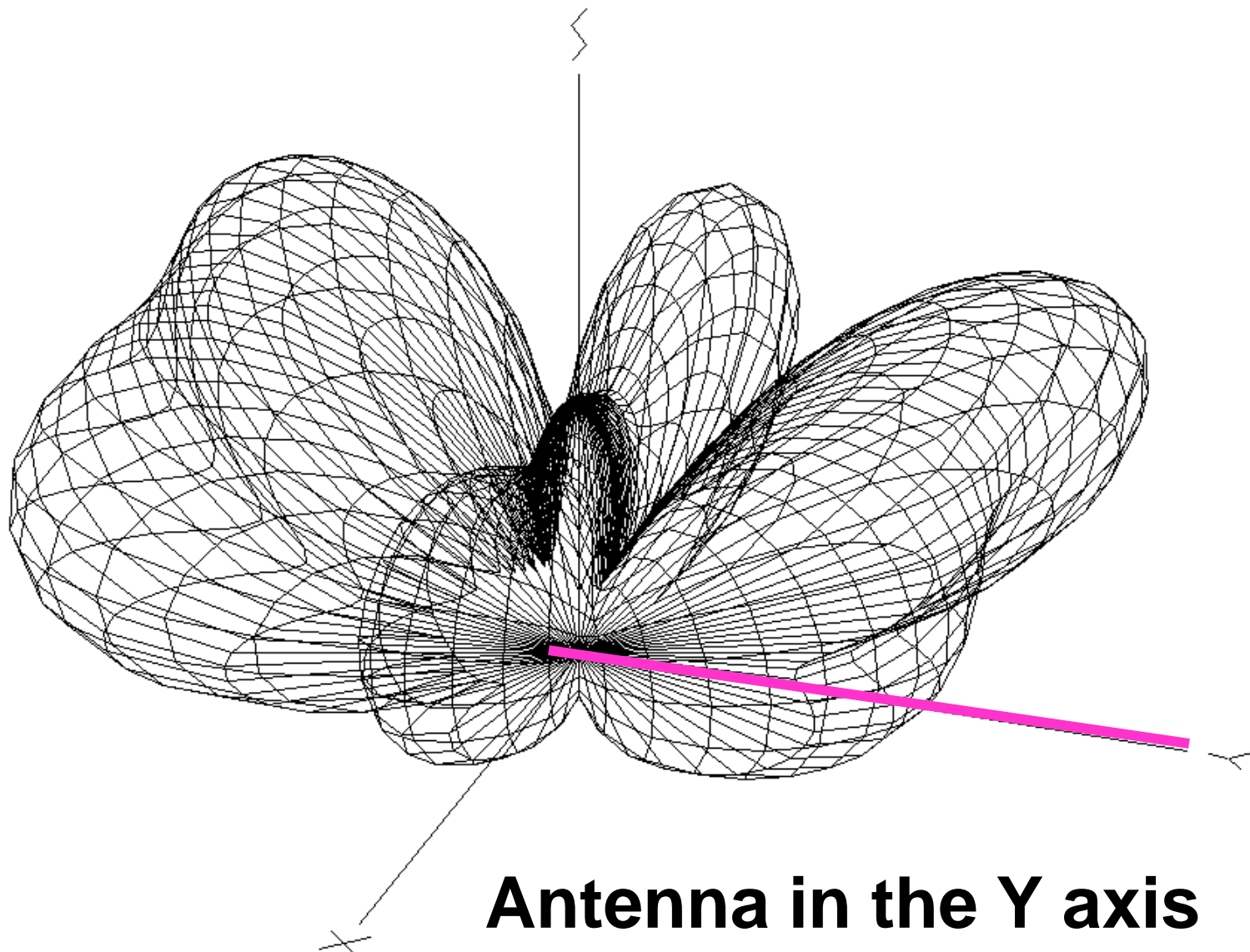

Antenna in the Y axis

20 Mx Pattern 1/2 wl high

14.15 MHz

0 dB

25 deg
7.5 dBi

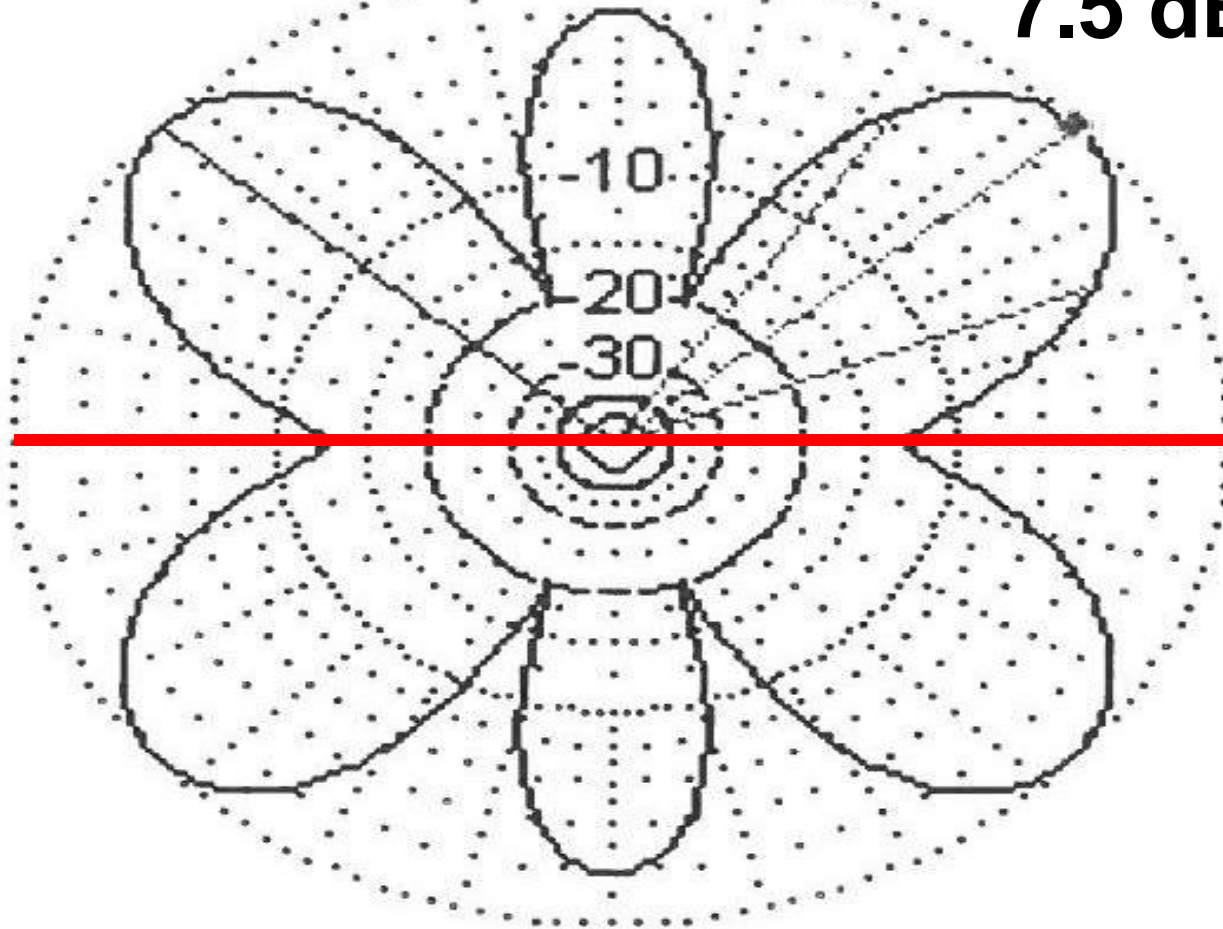

20 M SWR Curve

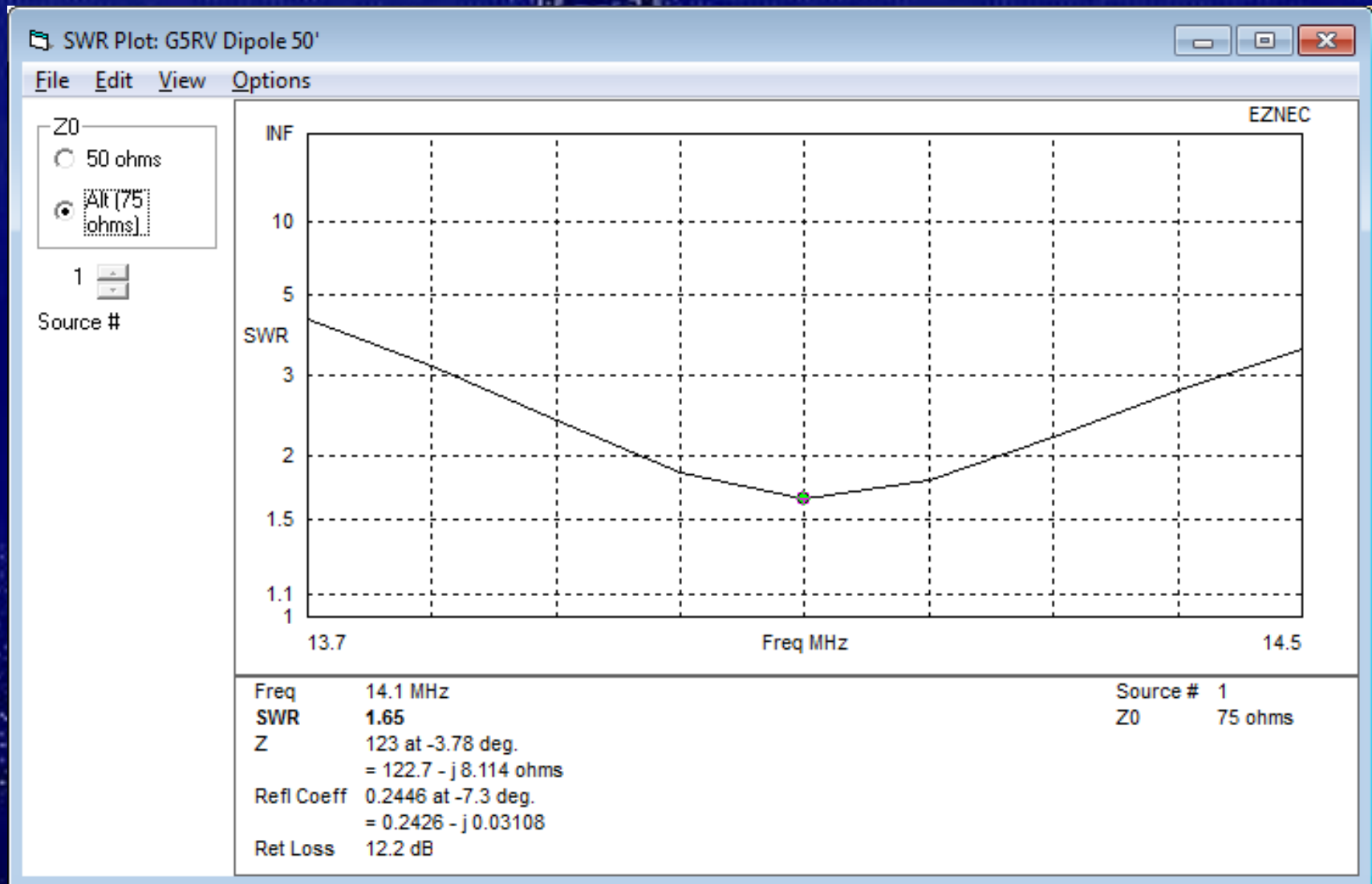

G5RV Tidbits

- G5RV found that some other bands loaded OK using the “valve transmitter” tank circuit tuning only.
- No external ATU required
- Covered 80, 40, and 20
 - (Note: 15 and 10 Meters required an ATU)

G5RV Multi-band

- 80 Meters dipole (132') with part of the open wire doing the “make up” section

G5RV – 80 Meter Standing Wave Currents

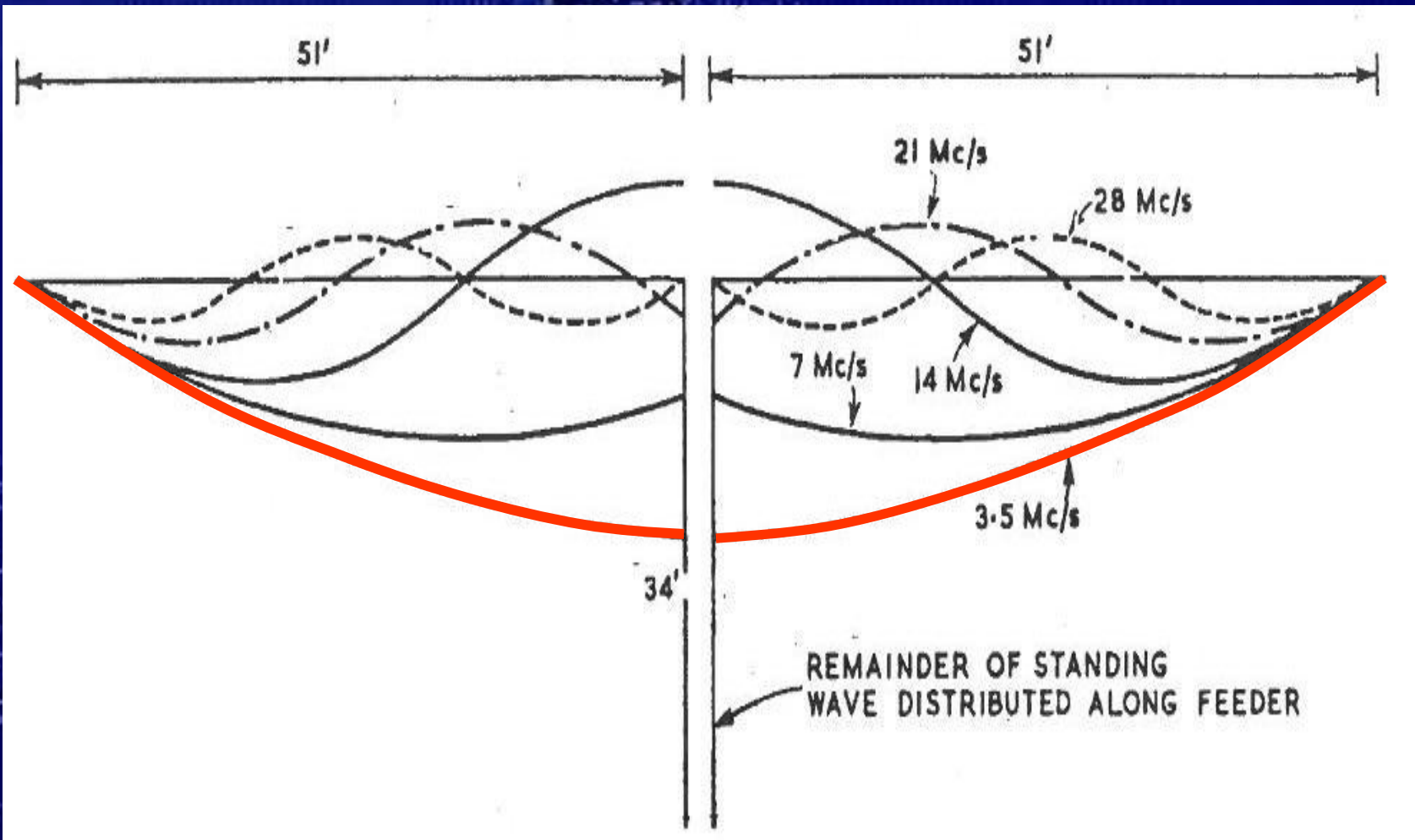

3D pattern 80 meters

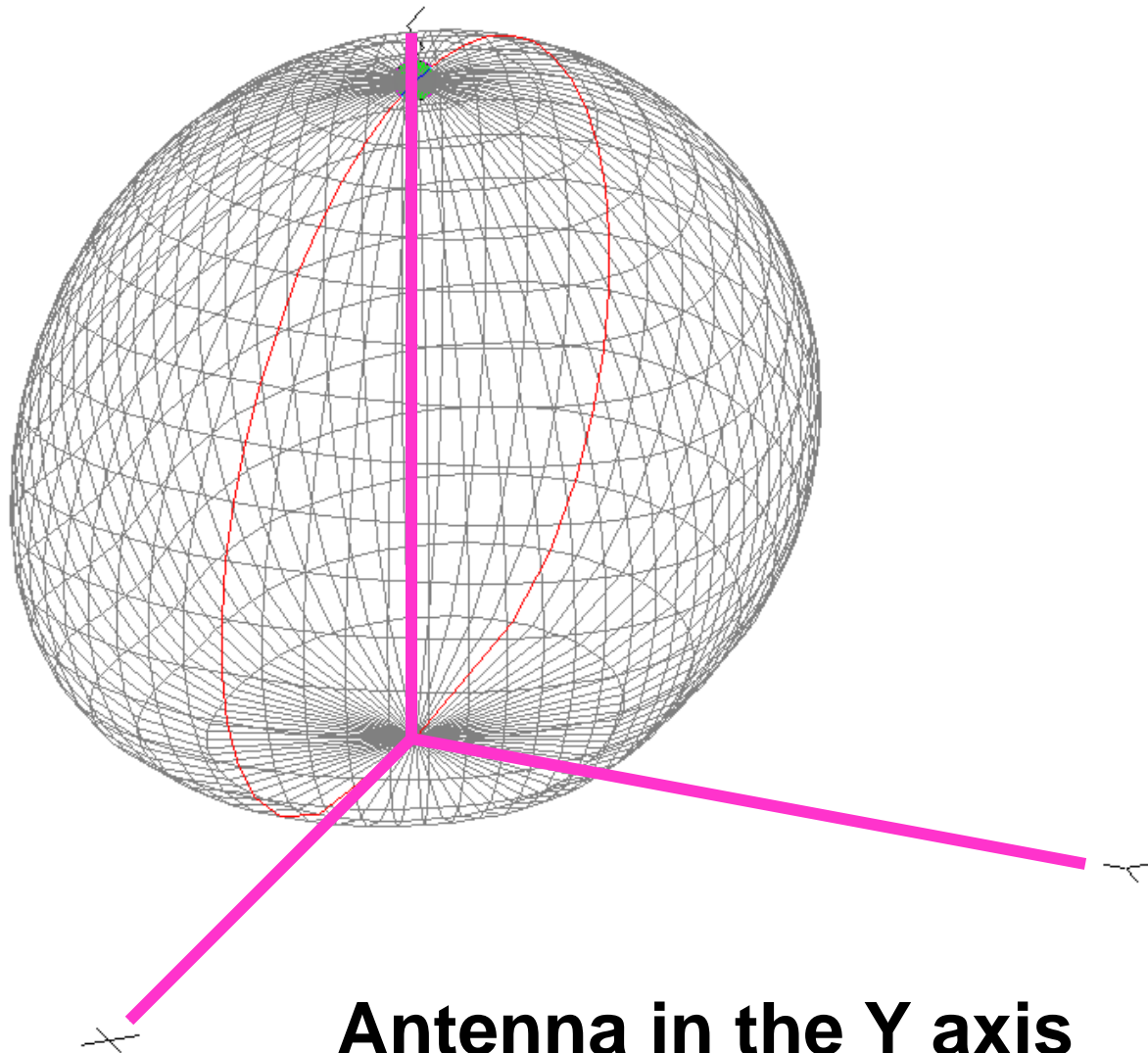

Radiation Pattern 80 Mx @ 35 feet

3.75 MHz

90 deg
5.5 dBi

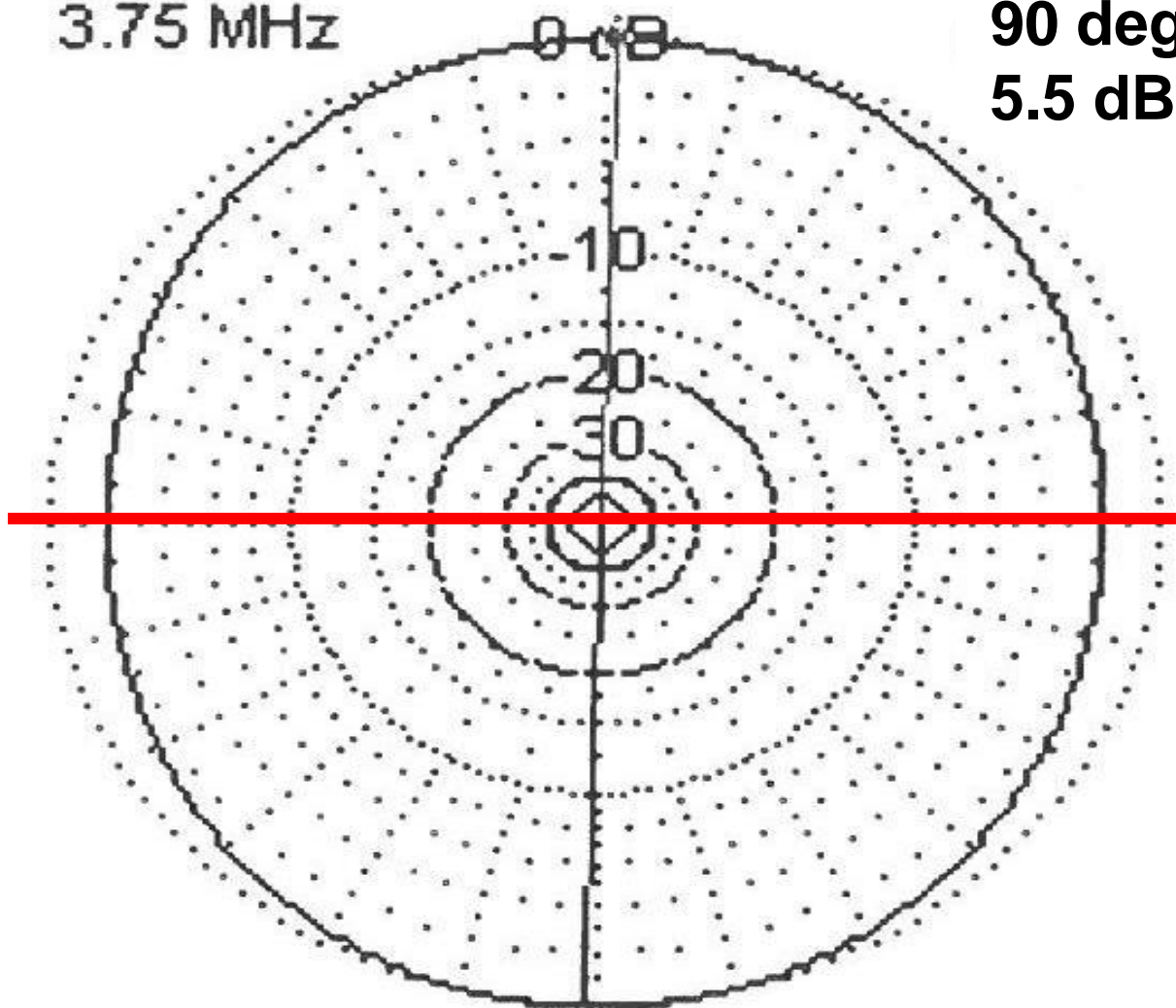

G5RV Multi-band

- 80 Meters dipole with part of the open wire doing the “make up” section
- 40 Meters – 2 “Half waves in Phase” with part of the open wire doing the make-up section.

G5RV -- 40 Meter Standing Wave Currents

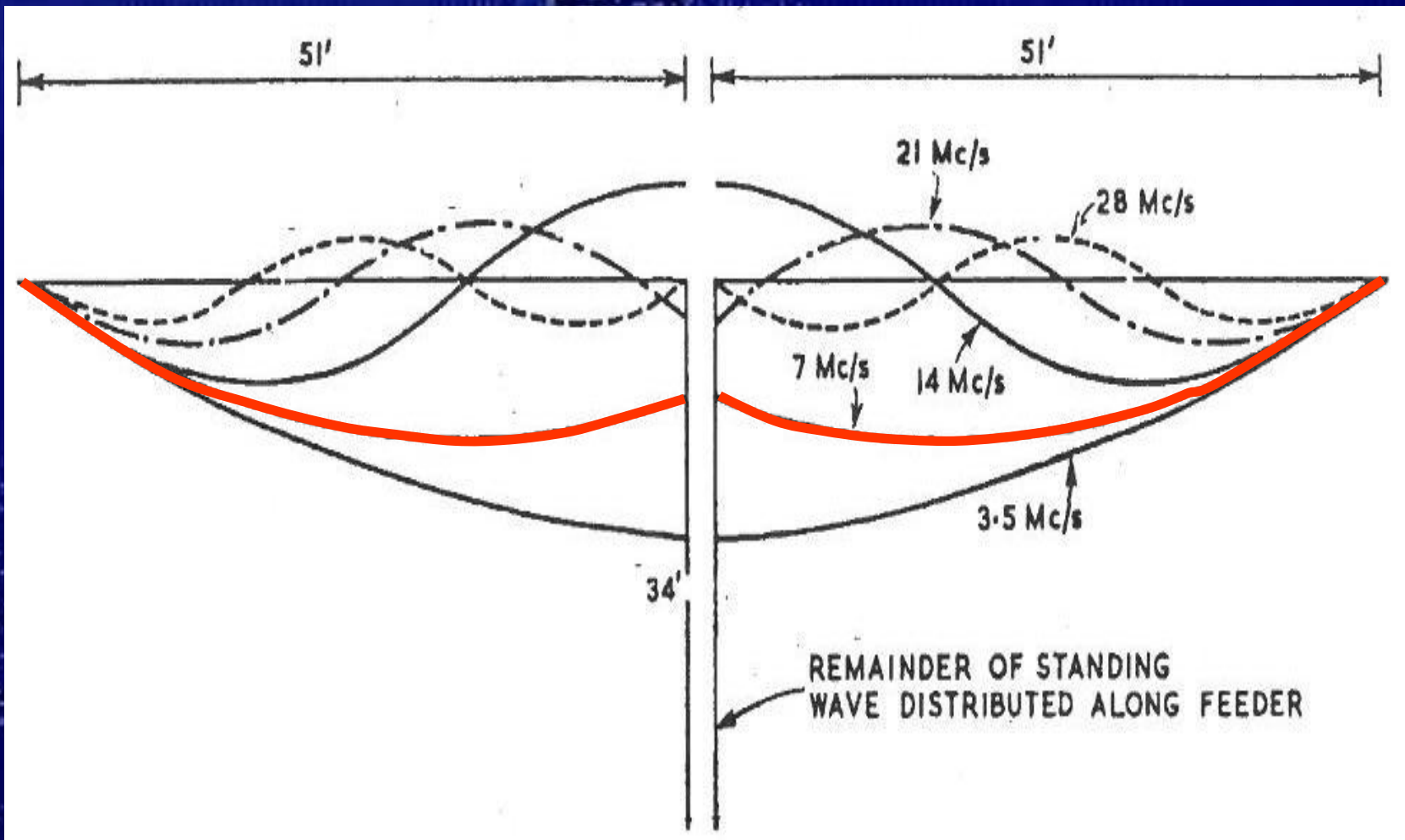

3D pattern 40 meters

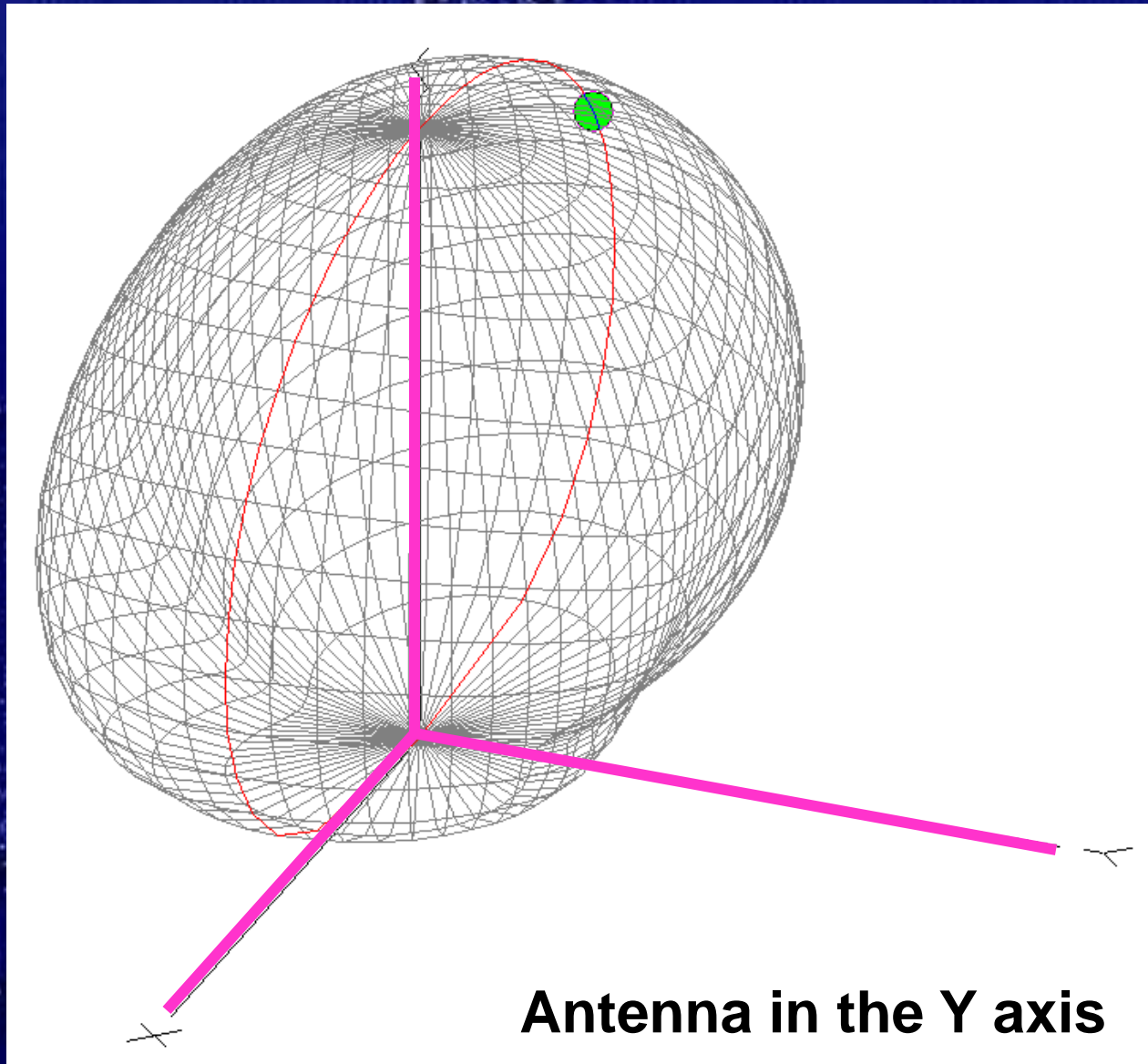

Radiation Pattern 40 Mx @ 35 feet

7.1 MHz

2 60 deg
6.3 dBi

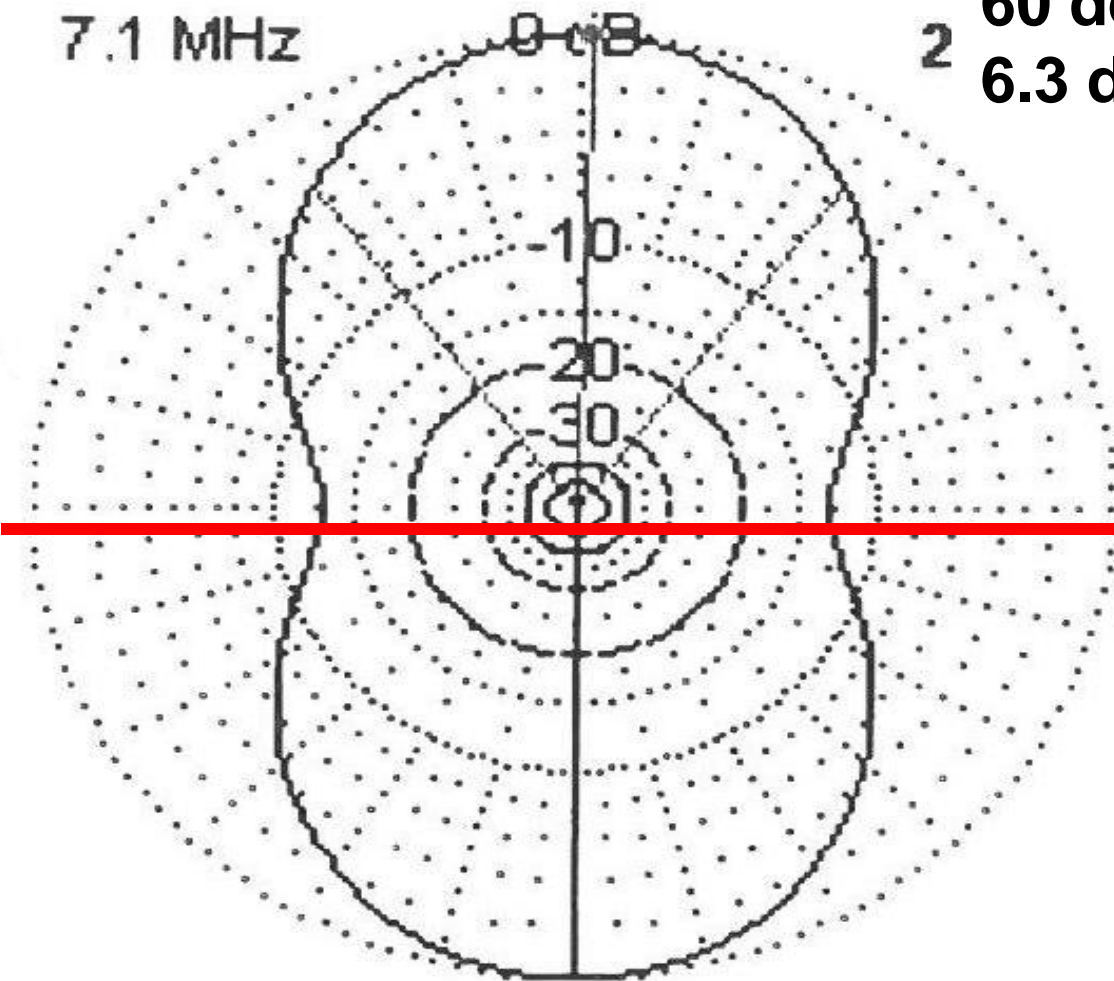

G5RV Multi-band

- 80 Meters dipole with part of the open wire doing the “make up” section
- 40 Meters – 2 “Half waves in Phase” with part of the open wire doing the make-up section.
- 20 Meters – $3/2$ wl

G5RV – 20 Meter Standing Wave Currents

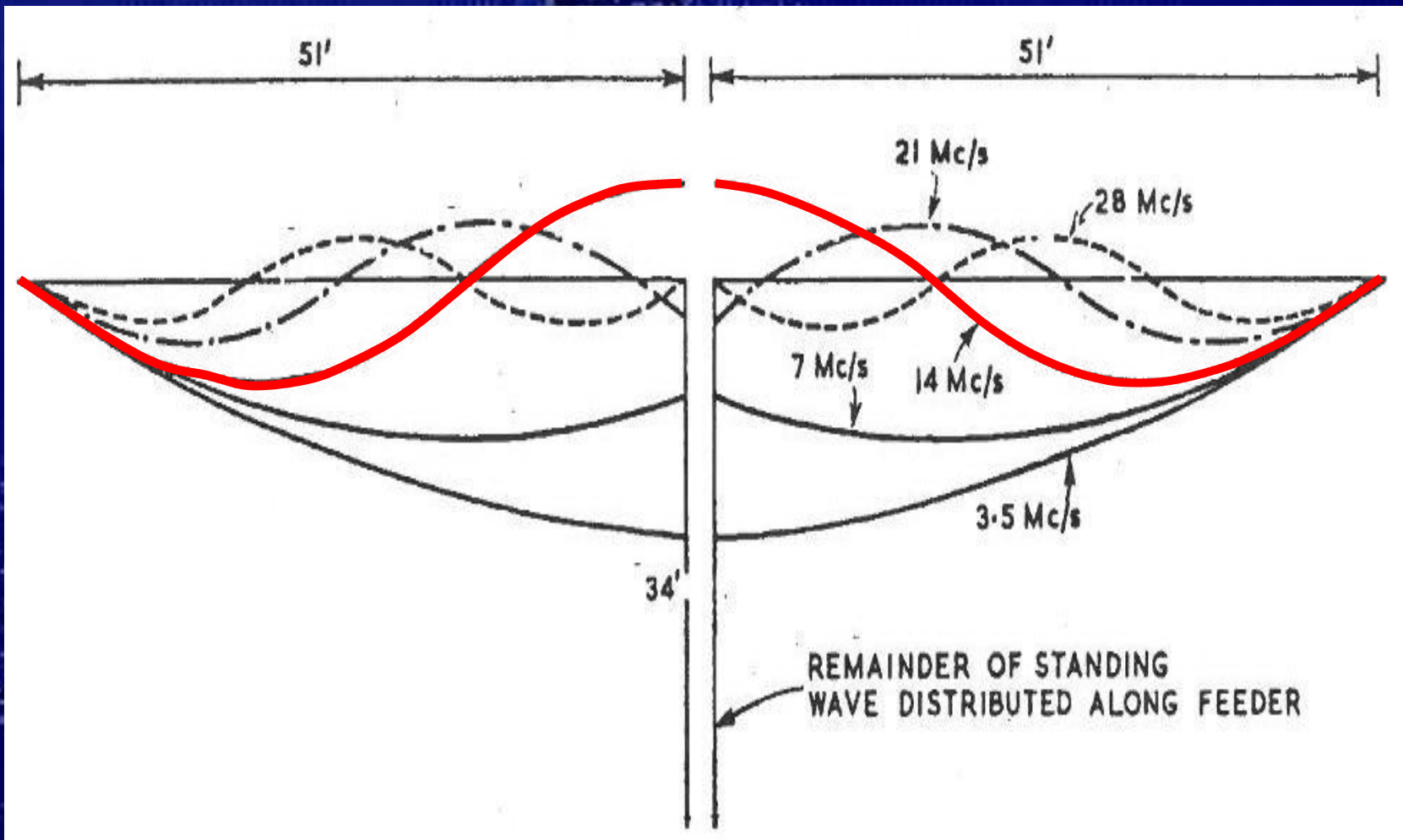

3D pattern 20 meters

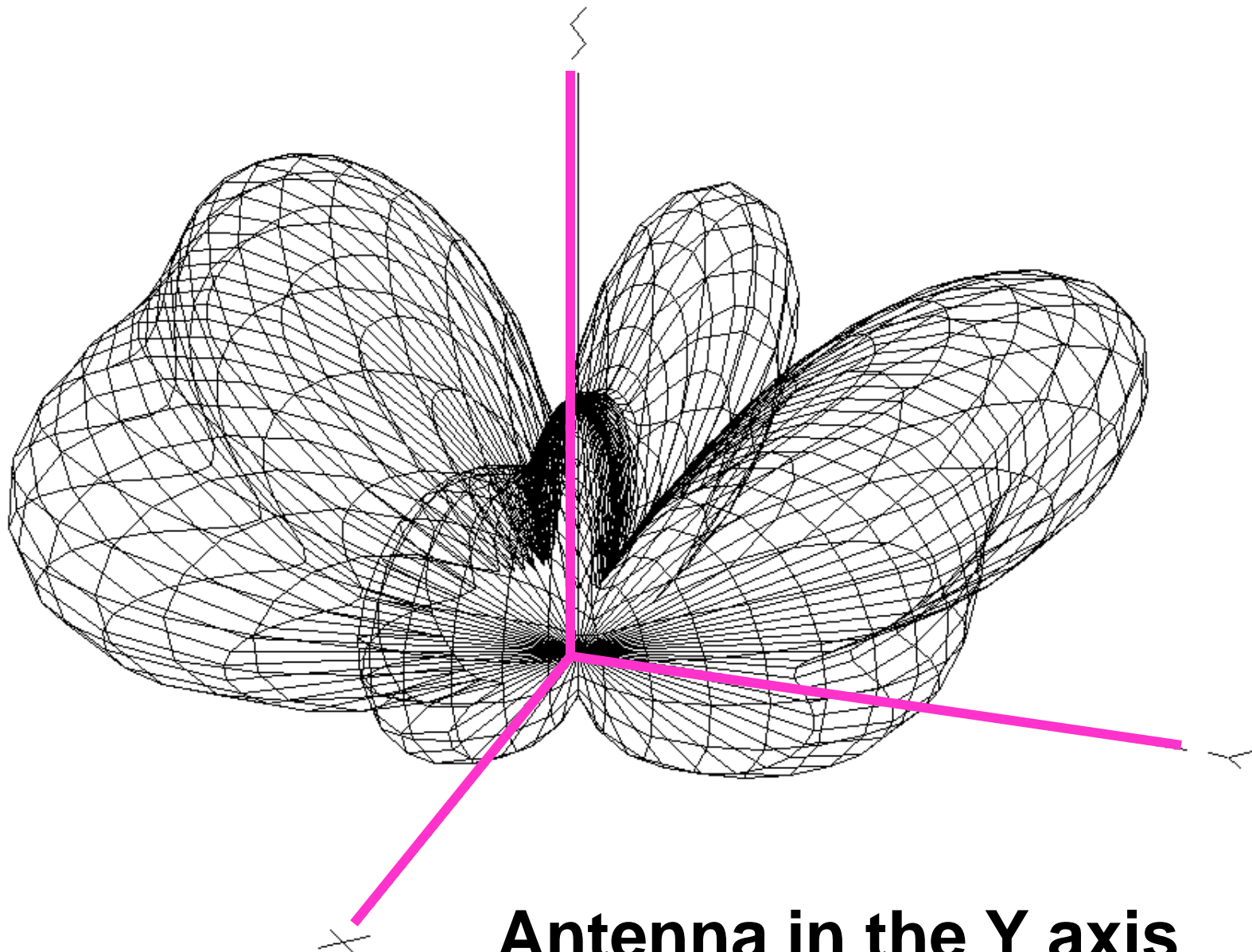

Radiation Pattern

20 Mx @ 35 feet – $\frac{1}{2}$ wl

14.15 MHz

0 dB

25 deg

7.5 dBi

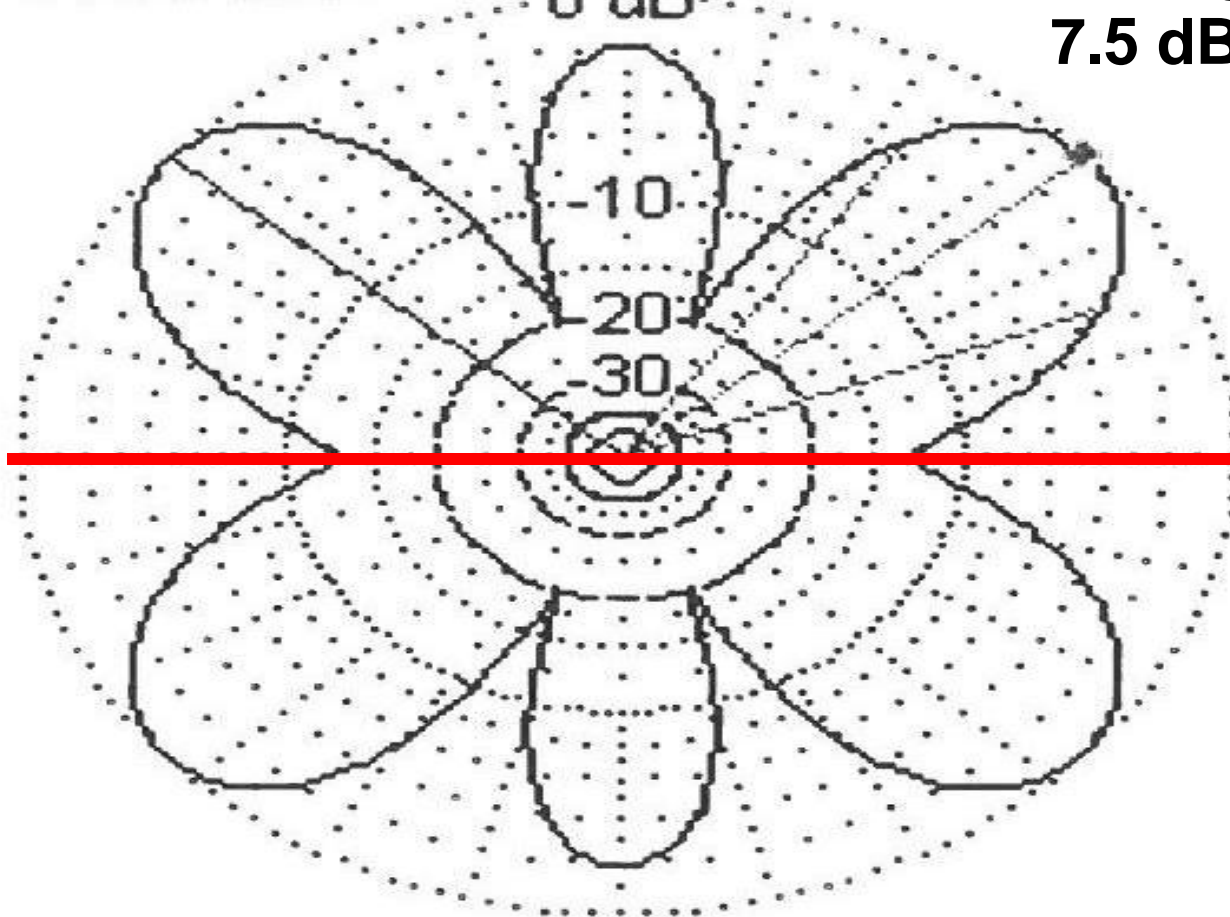

G5RV Multi-band

- 80 Meters dipole with part of the open wire doing the “make up” section
- 40 Meters – 2 “Half waves in Phase” with part of the open wire doing the make-up section.
- 20 Meters – $3/2$ wl
- 15 and 10 Meters he had to use an ATU
–i.e tuned feeders (high SWR)



G5RV – 10 & 15 Mx Standing Wave Currents

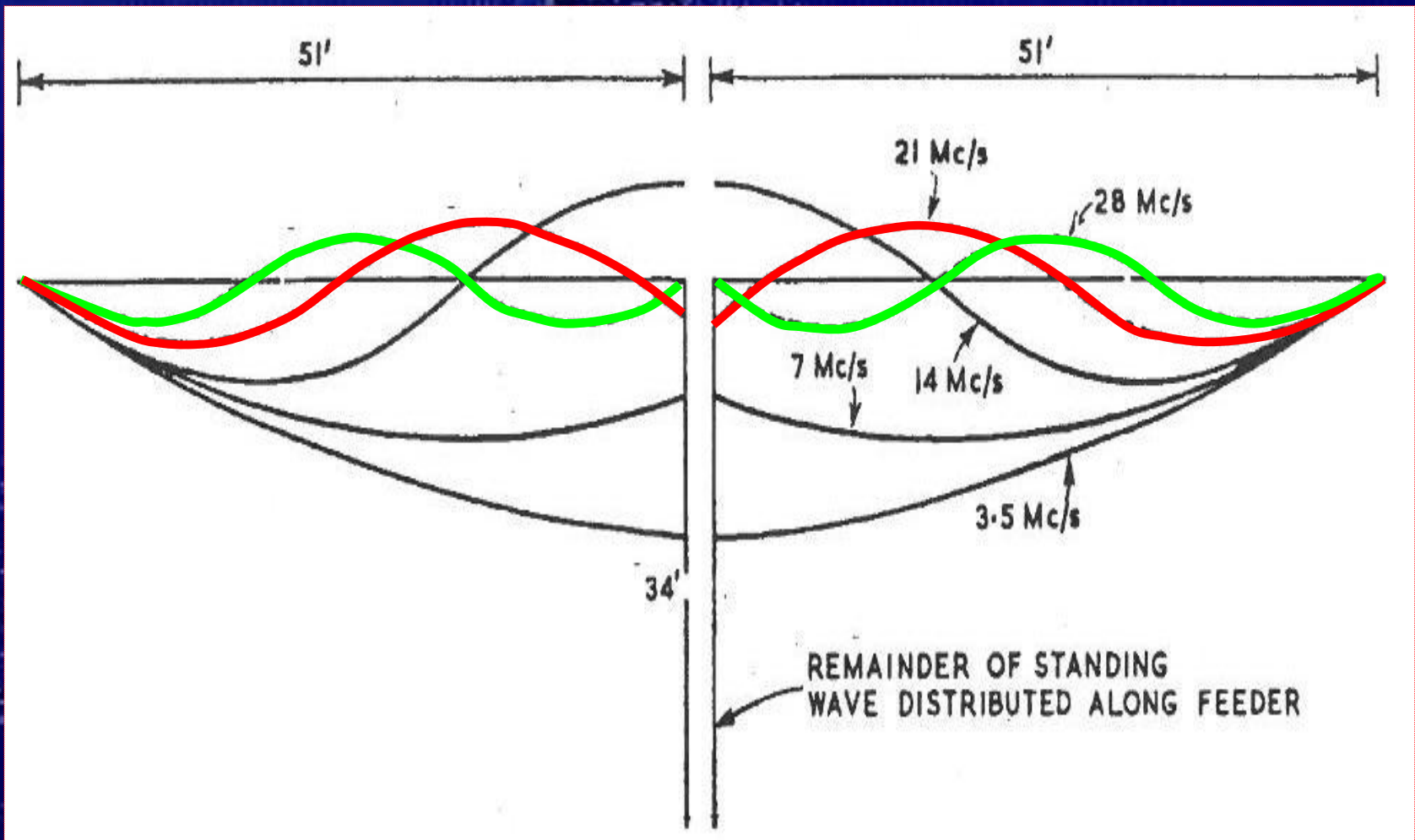

3D pattern 15 meters

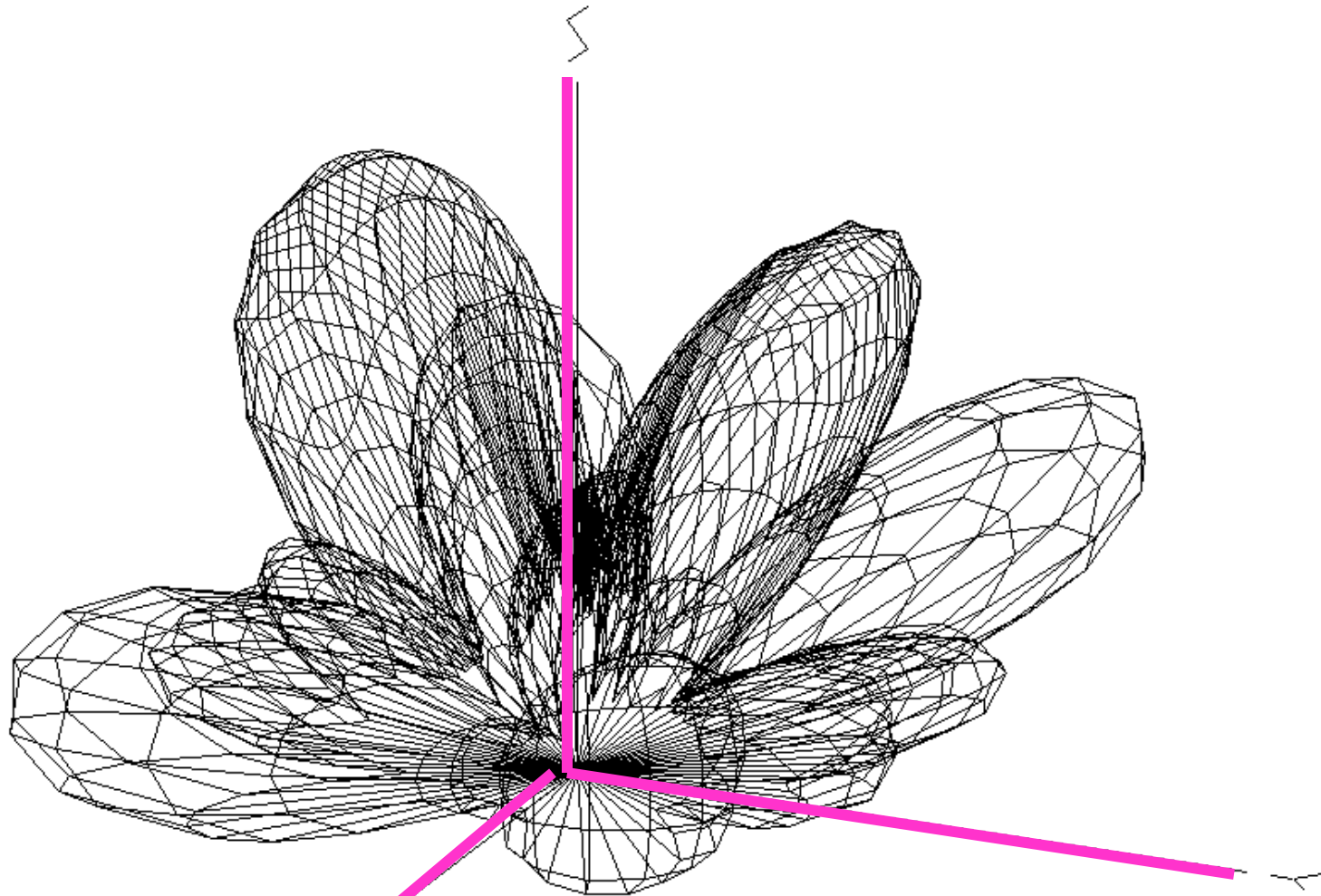

3D pattern 10 meters

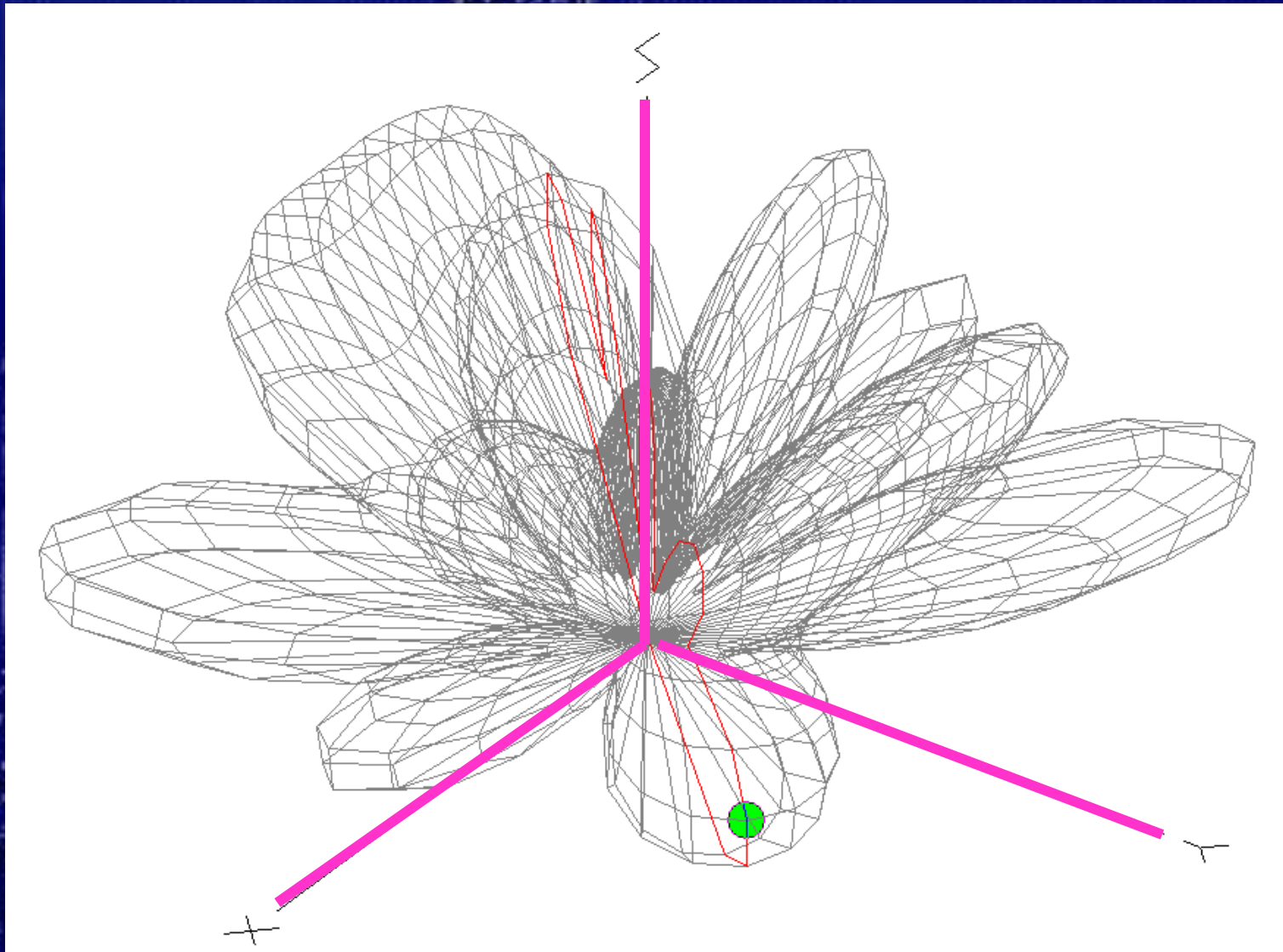

Radiation Patterns

15 and 10 Mx @ 35 feet

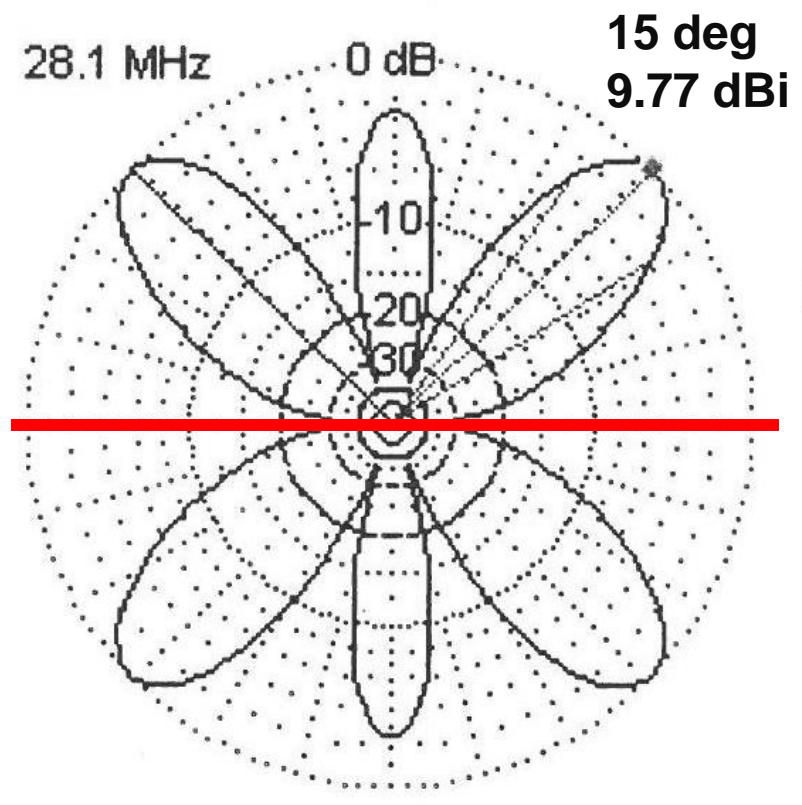
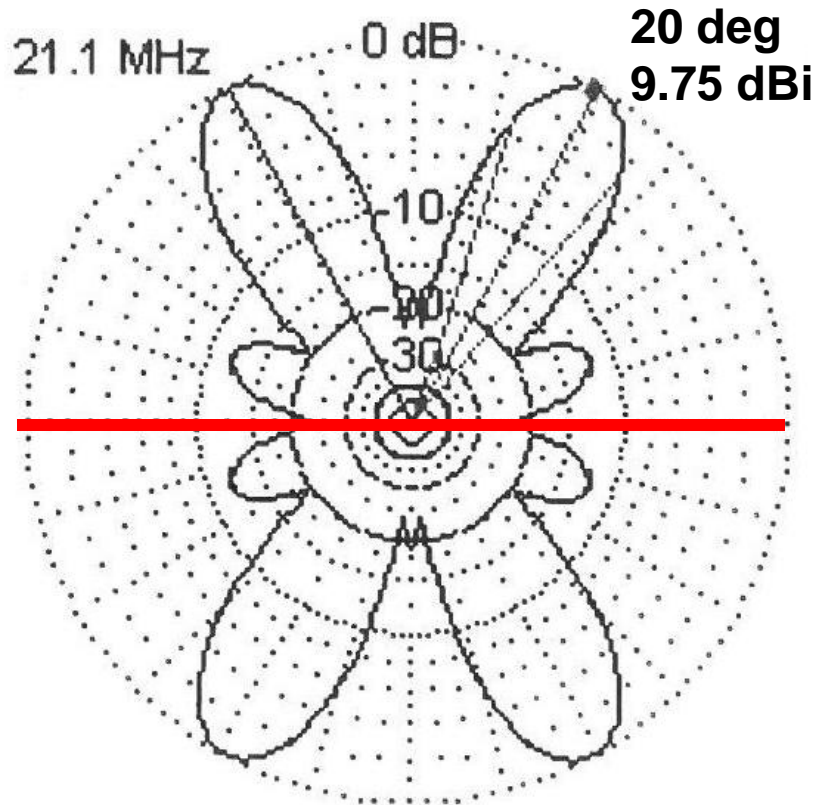

Feeding the G5RV

- **Varney found that open wire 34' long:**
 - **Provided a non-reactive system feed point for 20 MX (electrical 1/2 wl)**
 - **Also, provided reasonable “transformed” input Z values for 80 and 40**

Feeding the G5RV

- In the transmitters today you find an even more restrictive range of Z matching.
- SWR greater than 1.5, on most transceivers, causes the PA to start cutting back, so that the final devices are spared possible high voltages developed by the reactive impedances.
- All situations require an external ATU if multi-banding
 - typically handle up to 10:1 SWR

Feed Z at system input “Make up” Section

Band	Z (nominal)	SWR (75 ohm)
80 (3.75)	31 +j 50	3.5
40 (7.1)	60 - j110	4.5
20	123 - j7	1.7
15	86 +j376	23.9
10	409 -j 917	33.0

Transmission Line Details



Enter values directly, or click spinners, or click and hold spinners.

Freq - VF - Len - WL Conversions

Print

1. Choose Transmission Line, Modify Parameters if Desired.

Type (Modified)	Ro	VF	K1	K2	(Serenade equivalents)	
Belden 8259 (RG-58C)	50	1	0.453223	0.008358	C1	C2
					0.470216	0.274213

Reset Parameters to Original Values

2. Set Frequency, R, and X.

MHz	R	X	<input type="radio"/> At Input <input checked="" type="radio"/> At Load		Matched Loss dB / 100 ft	Plot
7 MHz	151	54			1.258	K1/K2

3. Set Line Length and Input Power.

Length	Units	Electrical Length Modulo 1/2 Wavelength	Input Watts
140.5	Feet	0.9999 λ 359.97 $^\circ$	100

Results

	At Input ●	At Load ●
R	103.41	151.00
X	18.37	54.00
Z	105.03	160.37
SWR	2.172	3.495
SWR (50)	2.152	3.447

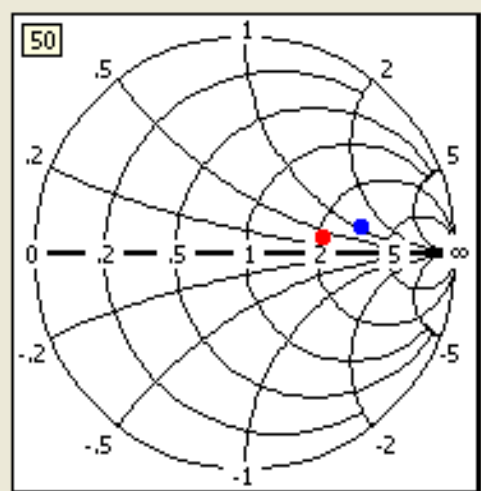

	Loss dB	W	% of Total Loss		
			62	3	35
Cond.	1.685	28.878			
Diel.	0.082	1.409			
SWR	0.937	16.053			
Total	2.704	46.340			

Line Zo 50 -j 1.619

Power at Load
53.66 W

- Show Rho in place of SWR
- Ignore Line Xo in calculations

Prime Center 50

Close

To Balun, or not to Balun....

(that is the question)

- **Varney initially recommended using a Balun**
 - In 1984 he retracted that after doing further measurements.
- **He found / read with highly reactive Z's:**
 - **SWR above 2:1 the losses increase and cores will saturate – losing RF power to heat.**
 - Design Note: only use core based baluns in matched conditions . Handle reactance on the load side of the balun
 - Jerry Sevick/Walt Maxwell
 - **Also measured balanced currents in the feed coax. (His particular situation)**



To Balun, or not to Balun....

- **Consensus is to use a choke at the owl / coax transition point to avoid common mode currents**
 - **Types suggested**
 - Air Wound
 - Badger (W6TC) Coaxial Choke (HR 2/1980)
 - K9YC stacked core chokes / ref NCJ
 - W2DU – Maxwell “bead” choke
- **Note: Coiled coax chokes (10 turns on a #10) will not have the frequency range needed 80M thru 10 M**

Additional bands? 60, 30,17, 12

- Run feedline directly to a wide range ATU for “ALL” band -- G5RV
- Use a modified version from ZS6, W0 or VE3 (none are “all” band) see later slide
- Commercial versions – “All band” – They use ATU’s
- 160 Mx – tie the open wire feedline conductors together – top loaded vertical – Better to extend the wire ends



G5RV – Option #2

Works on any band 80 thru 10

- Center Fed with open wire line direct to ATU

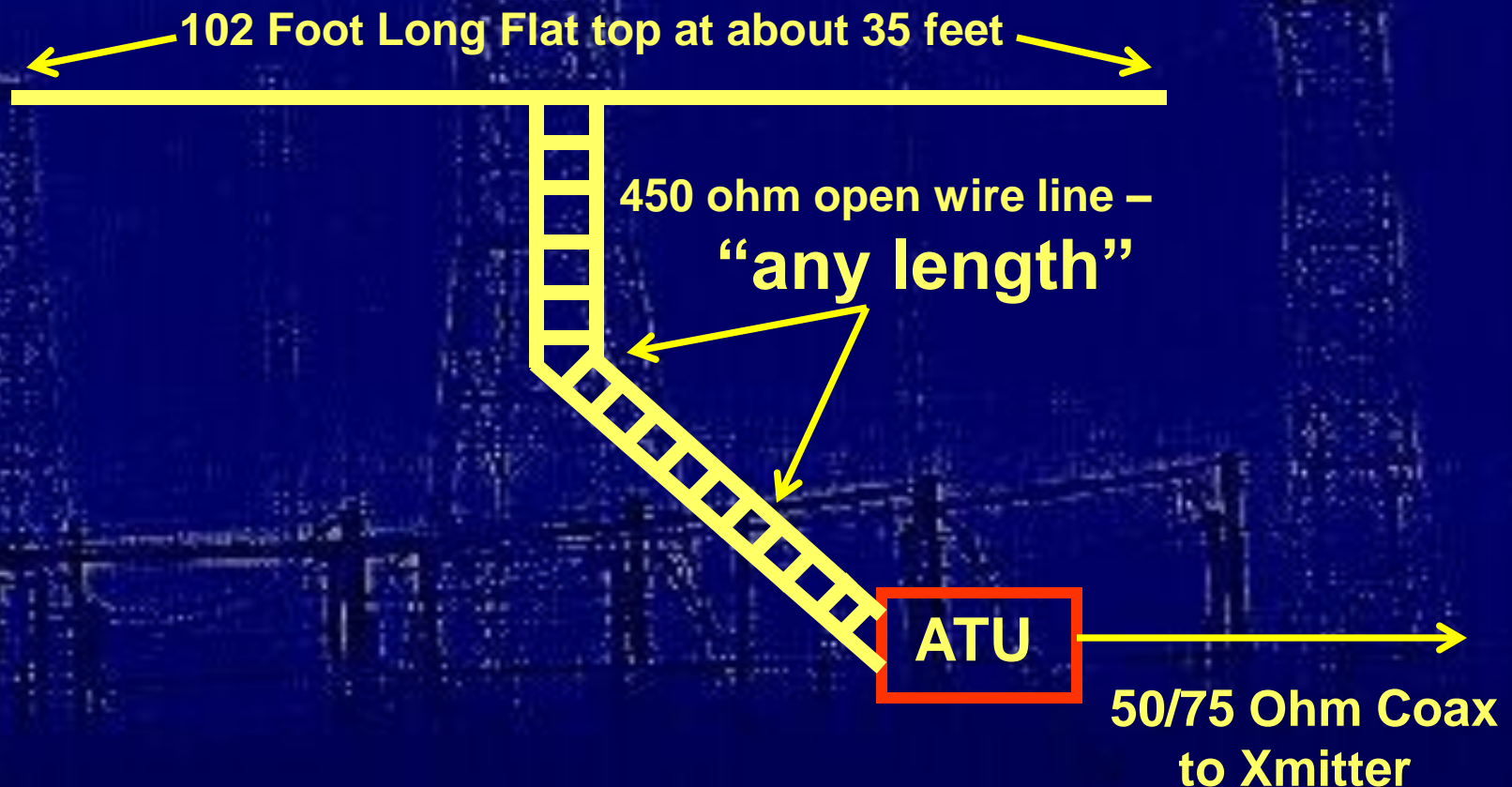

Modified Versions less than 3:1 SWR

- **ZS6BKW / GØGSF** – 93 foot flat top w/ 44.6' owl
– 40,20,17,12,10
- **W0BTU** – 97 ' flat top w/ 39.5 feet 450 ohm window
– 40,20,17,12,10,6,2
- **VE3JKC** – QST Aug 2004 – single band G5RV
– 17 Mx

Commercial Versions

– The Radio Works

- G5RV PLUS – requires a transmatch

– Amateur Radio Supplies

- G5RV Double, Classic, Jr., ZS6BKW

– Radiowavz

- Jr, Lite, G5RV, CL, Max

– MFJ

– E-Bay – various shops



Recommend deployment for G5RV “original” 20 M DX mode

- Erect it as a linearly deployed flat top
- Get it up at least $\frac{1}{2}$ wl on 20 meters (35 feet)
 - Keep it in the clear
- Use open wire / twin lead
 - Measure $\frac{1}{2}$ wl insitu
- Use low loss coax – minimal length
- Tune it for Zero 20M reactance at input to owl
 - varying height and or length – VK1OD.net



Alternate deployment for the G5RV

- Erect it as an:
 - Inverted V
 - Sloper
 - Zig Zag
- Get it up as high as possible
 - Keep it in the clear (avoid building soffits, gutters)
 - Run “Make up section” vertical as best U can
- Don't expect same ease of matching, DX performance, etc.

G5RV Summary

- **Great 20 meter DX antenna for small back yards**
- **Performs well, if installed as recommended**
- **With an ATU can work all HF bands**
 - **However, on most other bands it is a compromise; but it does fit the “space available”.**

References

RadCom Magazine -- RSGB

QST Magazine – ARRL.org

CQ Magazine -- DVD

73 Magazine -- DVD

Ham Radio Magazine -- DVD

ARRL Antenna Handbook

Antennas for All Locations – Moxon

HF Antenna Collection -- RSGB

L.B. Cebik.com (Antennex)

Lew McCoy – W1ICP (SK)



References

Doug DeMaw – W1FB (SK)

W8JI.com – Tom W8JI

E-Ham.net

E-Bay

VK1OD.net

G3TXQ – karinya.net

I1WQR Web Site – great links listing

Collins Radio Collectors Club

The “Radio” Antenna Handbook

Frank C. Jones Antenna Handbook

ARRL Wire Antenna Classics



G5RV (SK) June 2000

NOTABLE SILENT KEYS

LOUIS VARNEY, G5RV, SK

R. Louis Varney, G5RV, who invented the world-famous G5RV antenna, died June 28, at his home in West Sussex, England. He was 89 and had been reported in failing health earlier this year.

The G5RV multiband wire antenna for HF—typically 102 feet on the flattop section—is among the most popular of all antenna designs. Varney first described the G5RV during the late 1950s in the *RSGB Bulletin*. While models fed with coaxial cable have proliferated, Varney's personal recommendation was to use a balanced feed line and a matching network for bands other than 20 meters. (The G5RV dipole is discussed in Chapter 7 of *The ARRL Antenna Book*.) Varney had a full-size and a double-size G5RV, both fed with open-wire feeders, at his own station.

Varney was an RSGB member for 74 years, and he served as life president of the Mid-Sussex Amateur Radio Society. His wife Nelida is among his survivors. Services were July 4.—thanks to Bob D'Imperio, N4XAT, and RSGB

DAVID BOND, W9MG



When the legend becomes fact, print the legend.

Collins Multi-band Antenna

- **1935 Collins Radio had a “very” similar antenna**
 - Multi-band 2, 3 or 4 band depending on config.
 - Using copper tubing open line for matching
 - Appeared in the December 1935 ‘Collins Signal’
 - Also in The *Radio Antenna Handbook* -- 1936
 - Also in The Frank C. Jones *Antenna Handbook* -- 1937

Parting Words

It's well worth spending 10¢ on the antenna, when you're spending \$1 on the radio.

- “The average amateur has simply got to fit his antenna into his space. So.....What makes the best antenna within your space?”**

Maybe it's the G5RV



The End

G5RV Antenna Analysis

The truth, the whole truth and nothing but the truth, so help me, Louis Varney.

Rick Hiller – w5rh

