

User Manual

DuraFon-SIP System Durable, Long-Range Cordless Phone



EnGenius Customer Service
<http://www.engeniustech.com/>

Table of Contents

Safety Instructions	5
General Safety Instructions	5
Product Safety Instructions	5
Battery Safety Instructions	7
Regulatory Information	8
Equipment Checklist	11
Handset Illustration	12
Basic Handset Features	13
Additional Handset Features	15
Base Illustration	21
Base Features	22
Basic Base Station Features	22
Charger Illustration	23
Charger Features	24
Getting Started	25
Base Station Installation	25
Handset and Charger Installation	26
Basic Operations	27
Operation Modes	27
A. Base Operation Modes	27
B. Handset Operation Modes	27
Making a Telephone Call	29
Making a 2-Way/ Intercom Call	30
Making a Broadcast	30
Handset-to-Handset Calls	30
Redial	31
Receiving a Telephone Call	32
Receiving an Intercom Call	32
Ending a Call	33
Adjusting Handset Receiver (Earpiece) Voice Volume	33
Adjusting Handset Speakerphone Voice Volume	33
Placing a Call On Hold	34
Mute	34
Do Not Disturb (Silent Ring)	34
Key Guard	35

Battery Recharge and Replacement	35
Advanced Operations	36
Handset Registration.....	36
Handset Group Subscription	37
Call Transfer	38
Phonebook Operations	39
Programmable Feature Call	43
Caller ID	45
Call Manager.....	46
Incoming	47
Outgoing	47
Call Barring	48
Visual Message Waiting Indicator (VMWI)	49
Adjust Handset Microphone Gain.....	49
Adjust Headset Ring	50
SIP Configuration	51
Introduction	51
Application	51
VoIP Features	51
Registration Handsets.....	51
Default Settings	52
Web Configuration	52
LAN Configuration.....	53
Base Settings	53
Phone Book.....	54
SIP Configuration	55
SIP Server	55
SIP Account	55
Individual Account	56
Group Account	57
Audio Setting.....	58
Tools	59
Admin.....	59
Time	60
Ping Test	60
Firmware	61

Back-up.....61
Reset/Reboot/Registration61
Menu Operations63
Technical Specifications68
Base Station70
Index.....75

Safety Instructions

Caution: *Your wireless telephone gives you freedom and flexibility to stay in touch while you move around. However, when using your phone equipment, safety instructions should be followed to avoid the risks of fire, electric shock, injury to person, and damage to property.*

General Safety Instructions

1. When using your wireless phone, ensure your safety and the safety of others:
 - a. Always watch where you are walking and standing.
 - b. Do not let a phone call distract you from working safely.
 - c. If power goes out, your phone will not work. Backup power is recommended.
2. In an emergency:
 - a. If an emergency occurs, dial the emergency phone number. Remember: if you are in an area where your phone does not have a clear signal from the base, it is highly probable that the call may not go through. Locate the nearest landline telephone or other communications device to call for help.
 - b. Emergency calls may not automatically provide emergency personnel with your name, phone number or location.
3. Notice to Hearing Aid Users: This phone system is compatible with inductively coupled hearing aids.
4. Notice to Cardiac Pacemaker Users: Preliminary studies done by the US FDA and others have shown that, although interference to the implanted cardiac pacemaker may occur when operating very closely, wireless telephones “do not seem to pose a significant problem for pacemaker wearers.” However, until more is known, the FDA suggests that people with pacemakers may want to take precautions when using or carrying a wireless telephone to ensure that there is ample distance between the telephone and the pacemaker. Do not carry the handset in a breast pocket. If you have any reason to suspect that interference is taking place, turn off your handset immediately.

Product Safety Instructions

1. Read and understand all instructions.
2. Follow all warnings and instructions including those marked on the product.
3. Changes or modifications to this product not expressly approved by the

manufacturer will void the warranty and the FCC authorization to operate the equipment. Use only manufacturer provided accessories.

4. Do not use the telephone near water. Never spill liquid of any kind on this product.
5. Unplug the product from the wall telephone jack and power outlet before cleaning. Do not use liquid or aerosol cleaners. Use damp cloth for cleaning.
6. Do not place this product on an unstable cart, stand, or table. The product may fall and cause personal injury or damage to the product or other property.
7. Power Outage: In the event of a power outage, your handset charger will not recharge the handset battery, and the base station will not allow you to make an outgoing call or take an incoming call. Both the charger and the base station require electricity for operation. You should have a telephone that does not require electricity available for use during power outages, or have a temporary backup power supply.
8. Slots or openings in the product's housing are provided for ventilation. These openings must not be blocked or covered. Placing the product on a bed, carpeting, or other similar surface may block these openings and should be avoided. This product should never be placed near or over a radiator or heat register, or in a built-in installation unless proper ventilation is provided.
9. Never push objects of any kind into this product through housing slots/openings as they may damage the product, touch dangerous voltage points or short out parts that could result in fire, electric shock, or injury.
10. This product should be operated only from the type of power source indicated on the marking label. If you are not sure of the type of power supply to your home, consult your dealer or local power company.
11. Do not overload wall power outlets and extension cords as this may result in fire or electric shock.
12. To avoid electric shock or burn, do not disassemble this product. Send this product to an authorized service center when service or repair work is required. Call Customer Service for locations near you. Opening or removing covers may expose you to dangerous voltages, electrical currents or other risks. Incorrect re-assembling of the product may cause electric shock when the product is subsequently used.
13. Avoid using the product during a storm. There may be a risk of electric shock from lightning.
14. Do not place the product where persons can step, trip, or fall on it.
15. Do not place conductive objects over or near the antenna.
16. Do not use the product to report a gas leak while in the vicinity of the leak.

17. Do not install the base station or the handset charger near microwave ovens, radios, TV sets, speakers, or other electrical equipment. These appliances may cause interference to the product or experience interference from the product.
18. Unplug the base station or the charger adaptor from the power outlet and refer to an authorized service center under the following conditions:
 - a. If liquid has been spilled into the product.
 - b. When the power supply cord or plug is damaged or frayed.
 - c. If the product has been exposed to rain or water.
 - d. If the product does not operate normally by following the operating instructions.
 - e. If the product has been dropped or housing has been damaged.
 - f. If the product shows a distinct change in performance.

Battery Safety Instructions

1. Use only manufacturer approved Li-Ion rechargeable batteries and charger. Do not use other types of rechargeable batteries or non-rechargeable batteries. The batteries could short-circuit, and the battery enclosure may be damaged causing a hazardous condition.
2. Follow the charging instruction in this manual and instruction labels and markings in the handset and charger compartments.
3. Battery must be recycled or disposed of properly. Do not dispose the battery in a fire. The cells may explode.
4. Do not dispose of the battery in municipal waste. Check with local codes for disposal instructions.
5. Exercise care in handling the batteries so you do not short-circuit the battery with conductive materials such as rings, bracelets, keys, pocketknives, and/or coins. The battery or conductive material may overheat and cause burns or fire.
6. Do not expose batteries to rain or water.
7. Do not open or mutilate the battery. Released electrolyte is corrosive and may cause injury to eyes or skin. The electrolyte may be toxic if swallowed.
8. During charging, the battery heats up. This is normal and is not dangerous.

Regulatory Information

DuraFon-SIP System

FCC ID: A8J-SP935

IC: 10103A-SP935

This device complies with Part 15 of the FCC Rules. Operation is subject to the following two conditions:

- 1) This device may not cause harmful interference, and
- 2) This device must accept any interference received, including interference that may cause undesired operation.

Privacy of communications may not be ensured when using this phone.

Base Station

Federal Communication Commission Interference Statement

This equipment has been tested and found to comply with the limits for a Class B digital device, pursuant to Part 15 of the FCC Rules. These limits are designed to provide reasonable protection against harmful interference in a residential installation. This equipment generates uses and can radiate radio frequency energy and, if not installed and used in accordance with the instructions, may cause harmful interference to radio communications. However, there is no guarantee that interference will not occur in a particular installation. If this equipment does cause harmful interference to radio or television reception, which can be determined by turning the equipment off and on, the user is encouraged to try to correct the interference by one of the following measures:

- Reorient or relocate the receiving antenna.
- Increase the separation between the equipment and receiver.
- Connect the equipment into an outlet on a circuit different from that to which the receiver is connected.
- Consult the dealer or an experienced radio/TV technician for help.

FCC Caution: Any changes or modifications not expressly approved by the party responsible for compliance could void the user's authority to operate this equipment.

This device complies with Part 15 of the FCC Rules. Operation is subject to the following two conditions: (1) This device may not cause harmful interference, and (2) this device must accept any interference received, including interference that may cause undesired operation.

IMPORTANT NOTE:

FCC Radiation Exposure Statement:

This equipment complies with FCC radiation exposure limits set forth for an uncontrolled environment. This equipment should be installed and operated with minimum distance 20cm between the radiator & your body.

This transmitter must not be co-located or operating in conjunction with any other antenna or transmitter.

Industry Canada Statement:

This device complies with RSS-210 of the Industry Canada Rules. Operation is subject to the following two conditions:

(1) This device may not cause harmful interference, and (2) this device must accept any interference received, including interference that may cause undesired operation.

IMPORTANT NOTE:

Radiation Exposure Statement:

This equipment complies with IC radiation exposure limits set forth for an uncontrolled environment. This equipment should be installed and operated with minimum distance 20cm between the radiator & your body.

This device has been designed to operate with an antenna having a maximum gain of 2 dBi. Antenna having a higher gain is strictly prohibited per regulations of Industry Canada. The required antenna impedance is 50 ohms.

Portable Handset

Federal Communication Commission Interference Statement

This equipment has been tested and found to comply with the limits for a Class B digital device, pursuant to Part 15 of the FCC Rules. These limits are designed to provide reasonable protection against harmful interference in a residential installation. This equipment generates, uses and can radiate radio frequency energy and, if not installed and used in accordance with the instructions, may cause harmful interference to radio communications. However, there is no guarantee that interference will not occur in a particular installation. If this equipment does cause harmful interference to radio or television reception, which can be determined by turning the equipment off and on, the user is encouraged to try to correct the interference by one of the following measures:

- Reorient or relocate the receiving antenna.
- Increase the separation between the equipment and receiver.

- Connect the equipment into an outlet on a circuit different from that to which the receiver is connected.
- Consult the dealer or an experienced radio/TV technician for help.

FCC Caution: Any changes or modifications not expressly approved by the party responsible for compliance could void the user's authority to operate this equipment.

This device complies with Part 15 of the FCC Rules. Operation is subject to the following two conditions: (1) This device may not cause harmful interference, and (2) this device must accept any interference received, including interference that may cause undesired operation.

IMPORTANT NOTE:

Radiation Exposure Statement:

This equipment complies with FCC radiation exposure limits set forth for an uncontrolled environment. End users must follow the specific operating instructions for satisfying RF exposure compliance. To maintain compliance with FCC RF exposure compliance requirements, please follow operation instruction as documented in this manual.

This transmitter must not be co-located or operating in conjunction with any other antenna or transmitter.

Industry Canada Statement:

This device complies with RSS-210 of the Industry Canada Rules. Operation is subject to the following two conditions: (1) This device may not cause harmful interference, and (2) this device must accept any interference received, including interference that may cause undesired operation.

IMPORTANT NOTE:

Radiation Exposure Statement:

This equipment complies with IC radiation exposure limits set forth for an uncontrolled environment. End users must follow the specific operating instructions for satisfying RF exposure compliance. To maintain compliance with IC RF exposure compliance requirements, please follow operation instruction as documented in this manual.

This device has been designed to operate with an antenna having a maximum gain of 2.5dBi. Antenna having a higher gain is strictly prohibited per regulations of Industry Canada. The required antenna impedance is 50 ohms.

Equipment Checklist

1. In a Base + Handset package, please find the following components:
 - a. Base Station x 1 (antenna installed)
 - b. Base AC/DC Adapter x 1
 - c. Handset x 1 (antenna installed)
 - d. Handset Antenna x 1 (Long ×1)
 - e. Desktop Charger x 1
 - f. Charger AC/DC Adapter x 1
 - g. 1700mA Li-Ion Battery Pack x 1
 - h. Telephone Cord x 1
 - i. Quick Guide
 - j. RJ45 cable x 1

2. In a Handset package, please find the following components:
 - a. Handset x 1 (antenna installed)
 - b. Handset Antenna x 1 (Long ×1)
 - c. 1700mA Li-Ion Battery Pack x 1
 - d. Desktop Charger x 1
 - e. Charger AC/DC Adapter x 1
 - f. Quick Guide

3. Optional Accessory
 - a. Outdoor Antenna Kit (including antenna and cable)
 - b. High-Gain Handset Antenna
 - c. Headset

Handset Illustration

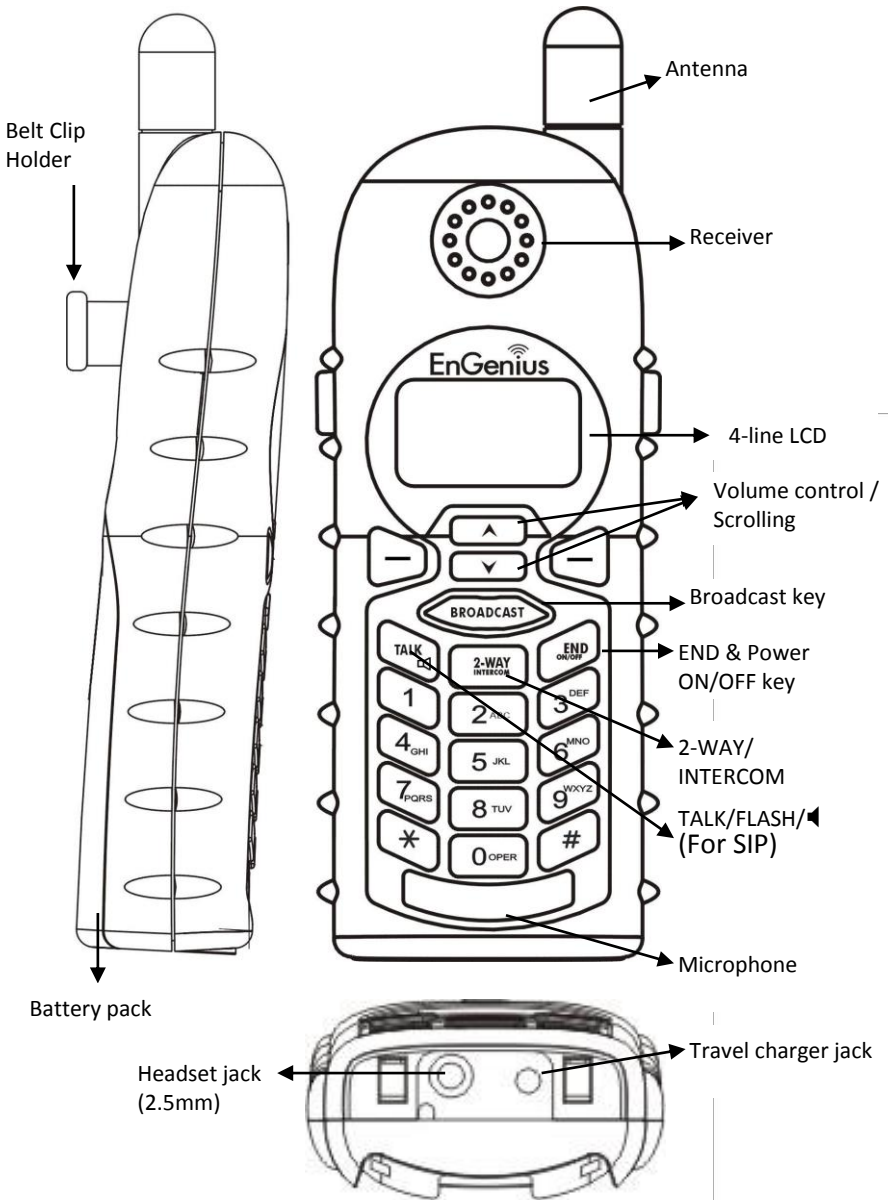

Handset Features

Basic Handset Features

1. 4-Line LCD (Liquid Crystal Display)

- a. The LCD display has LED (Light Emitting Diode) for backlighting.
- b. The 1st line of LCD consists of icons.
- c. Icons explanation from left to right

(1) **RSSI level** (Receive Signal Strength Indicator)

 During a call, the number of bars is proportional to the radio signal strength received.

(2) **Link mode**

 **(2.1) Call in-progress (ON/OFF-Hook)**

Indicates if the phone line is in the OFF-Hook status.

 12

(2.2) Intercom in-progress

Indicates if Intercom mode is active.

Indicates the Handset ID that is sending the intercom call.

(2) 

Line, Sound and Indication

(3.1) Line Indicator

Indicates when using line 1 or the incoming call from FXO line.

(3.2) SIP Indicator

Indicates when using SIP or the incoming call from SIP.



(3.3) Enable ringer



(3.4) Disable ringer



(3.5) Ringer and vibrate mode



(3.6) Vibrate mode



(3.7) Message waiting indicator

(4) **Disable PA and indicate speaker phone**



(4.1) Indicates if the incoming broadcast is disabled.



(4.2) Speaker indicator

Indicates if the speakerphone is active.

(5)

Two-Digit Handset ID

11

Displays the 2-digit Handset ID of owner.

(6)

Battery Strength



Number of bars is proportional to the amount of battery time remaining.

- d. The 2nd and 3rd lines of the LCD, maximum 16-characters each, display status, message, menu selections, or user-editable alphanumeric characters.

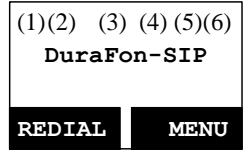

e. The last line displays the left and right soft keys.

2. Ringer

- a. Rings to an incoming call and intercom call.
 - b. Distinctive alert sounds indicating various events:
 - (1) Single beep: successful key entry.
 - (2) Double beep: indicates power on/off.
 - (3) Triple beep: failed operation.
 - (4) Periodic 1-Long 2-Short beeps (every 1 minute): low battery warning; out of range; call on hold.
- Re: No beep: invalid key entry.

3. TALK/FLASH ()

- a. Places or answers a telephone or intercom call.
- b. Sends a Flash signal to the phone line to retrieve a dial tone after the call ends, or to perform the Call Waiting feature provided by local phone companies during a call.

4. SPEAKERPHONE ()

Press and hold the key for over 2-seconds to enable/disable the speakerphone during incoming, outgoing or intercom call.

5. 2-WAY INTERCOM ()

- a. Places an intercom call to another handset, a group handset (group paging) or all registered handsets.
- b. Intercom calls are digital, full duplex, and are conducted without the assistance of the base station.





6. BROADCAST ()

- a. Half duplex broadcasting to handsets for immediate announcement.
- b. Half duplex broadcasting to base stations.

Re : Press the  key on the left top corner of the handset to activate the broadcast function.

7. Left/Right Soft Keys ()

- a. Make menu selection.

8. Up () /Down () Scrolling Keys
- Scroll through records and menu selections.
 - Adjust receiver voice volume when in the Talk mode.
 - Press  to enter received call log when in the Standby mode.
 - Press  to enter phonebook when in the Standby mode.
9. END; On/Off Key ()
- Ends a call.
 - Leaves current menu operation, up one level.
 - Press for 3-seconds to turn off the power.

Additional Handset Features

- Multiple Handsets Registration
 - Up to 10 handsets can be registered to a base station.
 - ID 10-19: Individual Handset IDs.
 - ID 1~7: Group IDs. Handsets can “subscribe” from the handset menu to group(s) and be paged when a landline caller or an intercom caller enters a Group ID.
- Ringer Vibrator
 - Two (2) options for Line (incoming call) ringing and intercom ringing.
 - Six (6)-level ringer volume selections (Off/Low/Medium/High/Vibrate/Vibrate & High) for each option.
 - Eight (8) ringer type selections for each option.
- Caller ID
Displays incoming call phone number and name on the LCD (needs Caller ID service from local telephone company).
- Call Waiting with Caller ID
Displays 2nd incoming call information on the same phone line when 1st call is in progress (needs Call Waiting with Caller ID service from local telephone company).
- Name Tagging with Caller ID
Match the Caller ID with the phone book entries; once matched, the LCD screen will display the name or nickname instead of pure Caller ID info (needs Caller ID service from local telephone company).

6. DND (Do Not Disturb, i.e., Silent Ring)
7. Call Logs
 - a. Redial: Stores 10 phone numbers (up to 26-digits each) dialed most recently. Can perform last-number redial on all 10 numbers.
 - b. Received and New Call Log: Total 50-entries (16-digit phone number, 16-character names, and Date/Time stamp), needs Caller ID service from local telephone company.
 - c. Phone numbers and names can be saved into phone book while in display.
8. Call Manager: Includes: blocking incoming call, outgoing call and assign line dedication, line selection.
 - a. Incoming Call:
 - a-1. PA On/Off: Enable or disable the Broadcast feature from other handsets or the base station. When PA is Off, the handset cannot receive Broadcast calls from the base station or other registered handsets, but it can Broadcast to the base station or other registered handsets.

a-2. Line On/Off: Enable or disable the ability to receive incoming calls from telephone line call. When Line is Off, the handset cannot receive incoming calls from a telephone line call, but it can still make outgoing calls.

a-3. Int. On/Off: Enable or disable the Intercom from other handsets or the base station. When Int. is Off, the handset cannot receive Intercom calls from the base station or other registered handsets, but it can Intercom to the base station or other registered handsets.
 - b. Outgoing Call
Select the mode of line selection (Auto/Manual/Predefine line/Off) when you make a line call.
 - b-1. Auto: A handset will select one of available lines from subscribed bases before making an outgoing call. (Default)

 - b-2. Manual: A handset will be prompted to select from a list of available lines before making an outgoing call. (1 for telephone line, 5 for SIP call)

b-3. Off: Disable the capability to make an outgoing call.



c. Call Barring

c-1. Block users from dialing long distance or international calls.

c-2. Up to 5-digits of each Call Barring setting, up to 5-entries allowed.

Changing requires you to enter the "Call Settings" (**MENU**-4-3).

Note: You must key in the accurate user ID and password to perform this feature. The default password is "0000."

9. Any Key Answer (except  and **SILENT** soft Key)
- a. If you enable Any Key Answer while you have two incoming line calls simultaneously, you can answer the SIP call or PSTN call by pressing  the scrolling key.
10. Key-Guard
- a. When the Key-Guard is selected, all keys will be locked. Press **UNLOCK** (Left) soft key followed by ***** to release it.
- b. The Key-Guard will be automatically enabled once returning back to idle mode for 15-seconds.
11. Dialing Prefix
- a. Up to 14-digits, including pause(s), one access code can be pre-programmed to be added automatically in front of the dialed number when dialing from call logs, phone book, and dial-and-send dialing.
12. Call Hold
- a. Places call on hold.
13. Mute
- a. Press **MUTE** (Left) soft key during talk, the handset microphone will be muted. Press **UNMUTE** (Left) soft key to release it.
14. Phone Book
- a. 50-entries, each stores a phone number or handset ID (up to 26-digits) and name (up to 16-characters).
- b. Alphabetically sorted display and search by letter.
- c. Dial from display.
- d. During the stand-by mode, you can enter the phone book by pressing



the scrolling key.

- e. Phone Book transfer via air
 - i. Transfer a specific Phone Book to one handset or all registered handsets
 - ii. Transfer all Phone Books to one handset or all registered handsets
15. Key Tone
 - a. Four-level Key Tone volume selections (Off/Low/Medium/High).
 - b. Four Key Tone type selections.
16. Call Timers
 - a. Displays call time duration for current call, during and immediately after the call.
17. Programmable Feature Call
 - a. Allows user to pre-program the most frequently used Feature codes into the DuraFon-SIP, which is adjunct to the PBX system.
 - b. Up to 10-entries can be saved.
 - c. Once the feature code has been programmed, you can quickly perform those functions during the call by pressing the **OPTION** soft key.
18. Menu Display
 - a. To avoid mis-setup in the “Call Settings” (**MENU-4**), “Phone Settings” (**MENU-5**), and “Base Settings” (**MENU-6**), these settings can be hidden.
 - b. The Handset password is required before entering Menu Display (**MENU-8**), the default handset password is “0000.”
 - c. When disabling the settings, they will no longer be displayed unless enabled by entering Menu Display again.
19. PA On/Off
 - a. Enable or disable the Broadcast function.
 - b. When PA is Off, the handset cannot receive Broadcast from the base station or other registered handsets; but it can broadcast to other registered handsets.
20. Group Setting
 - a. Allows the handset to subscribe to one or several groups.
Re: Up to 7 groups (1~7) can be subscribed.
21. Custom Name
 - a. Change the “DuraFon-SIP” screen to the desired wording or info, such as

the handset user's name.

Re: Up to 32-characters can be entered.

22. Change Pwd

- a. Change the handset password, which requires entering the Call Barring (MENU-4-3) and Menu Display (MENU-8).

Re: Default PIN is "0000."

23. DTMF Duration (from web)

24. Programmable Flash Key Timing (from web)

25. Assign Next Handset ID for New Handsets

- a. Use a registered handset from MENU-6-1 to assign a Next Handset ID to a new handset.
- b. If you do not assign Next Handset ID, the system will automatically assign a handset ID to a new handset.
- c. When entering the Base Settings, a PIN is required. The Default is "0000."

26. Clear Handset

- a. Use a registered handset from MENU-6-2 to remove the other registered handset, in case the other registered handset is defected.
- b. Once the other registered handset is clear, the user is able to register a new handset in its place.
- c. When entering the Base Settings, the PIN is required. Default is "0000."

27. Change PIN

To change the base PIN, enter the "Base Settings" (MENU-6-3).

- a. Use a registered handset to change the PIN from MENU-6-3.
- b. The default PIN is "0000."
- c. When entering the Base Settings, the PIN is required. The default PIN is "0000."

28. Auto Hang Up Feature (from web)

- a. From Web, "System-Base Settings-Auto Hang up" to turn On/Off this auto hang up feature.
- b. If turning On the feature, the handset will automatically hang up the call when the far-end hangs up its call.

29. Mic Gain

Change the handset microphone gain based on the handset's use in different environments – Quiet, Normal and Noisy environment.

- a. This requires entering the “Phone Settings” (MENU-5-1).
30. Headset Ring
Change the ringer emitting either from the handset speaker or the headset receiver.
- a. This requires entering the “Phone Settings” (MENU-5-8).
- 31 Base Intercom Auto-Answer (from web)
- a. From Web, “System-Base Settings-Base Intercom Auto-Answer” to turn On/Off the Intercom Auto-Answer feature.
 - b. Default is ON, If turning OFF the feature, you will need to press the base Intercom or Broadcast key to answer handset Intercom calls to the base.

Base Illustration

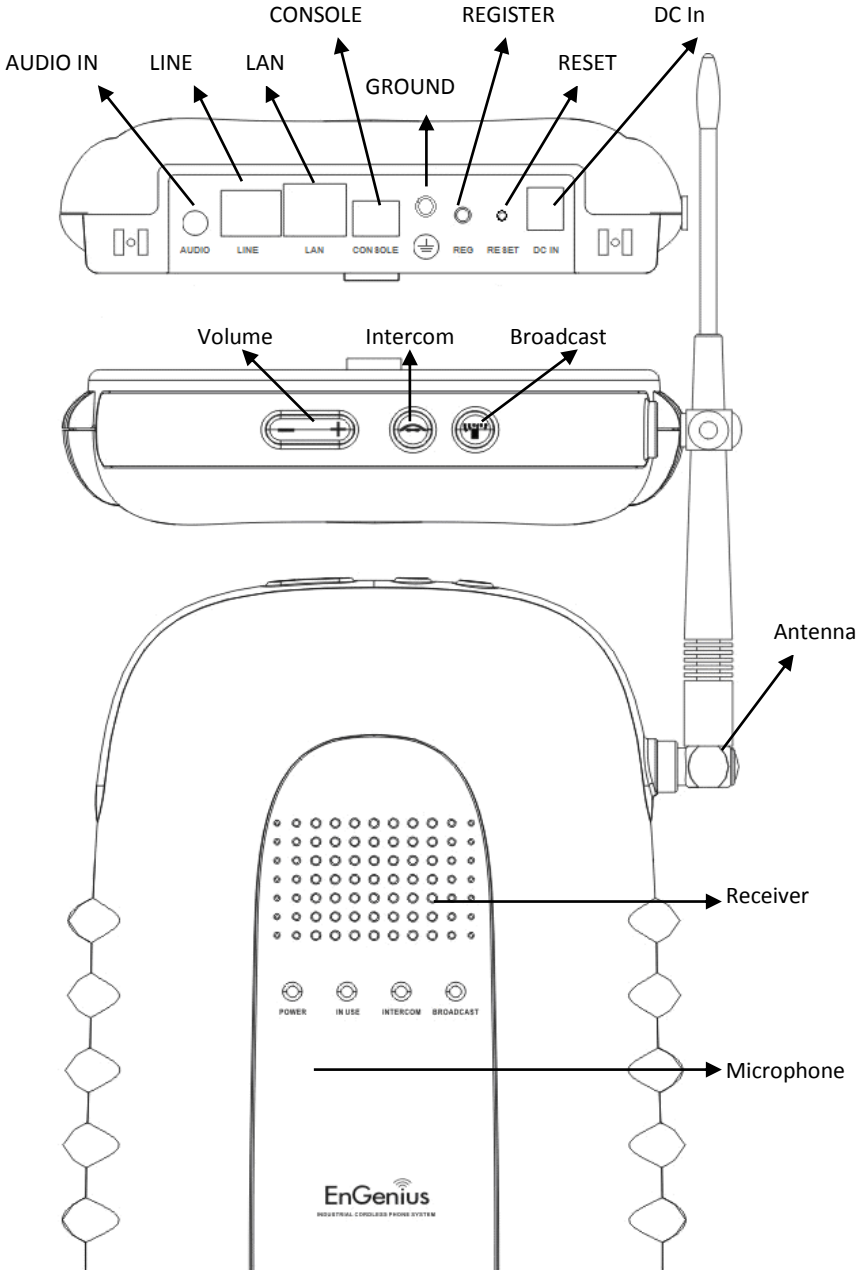

Base Features

Basic Base Station Features

1. Audio-In Jack (3.5mm)
Connect to an external device for music on hold.
2. FXO Jack (L1)
Standard RJ-11 connector to plug in the telephone line.
3. Ethernet Jack
Standard RJ-45 connector to plug in the Ethernet (LAN) line.
4. Console Jack
Jack for console (Type-B USB connector).
5. GND
Connecting the ground cable.
6. REG button for Registration and Page
 - a. Press and hold this REG button until the "INTERCOM" LED flashes status to enter registration mode.
 - b. To search for a misplaced handset; press "REG" button, all registered handsets will beep for 30-seconds. Press "REG" again or any key on the handset to stop.
7. RESET Button
 - a. Restores base station to factory settings.
 - b. Reset button is intended to prevent accidental system reset.
 - c. All handsets (including administrator) and additional base(s) need to be re-registered after a base station reset. The web configuration is also to reset to factory settings.
8. DC In: to plug in the 12V DC power adapter.

Charger Illustration

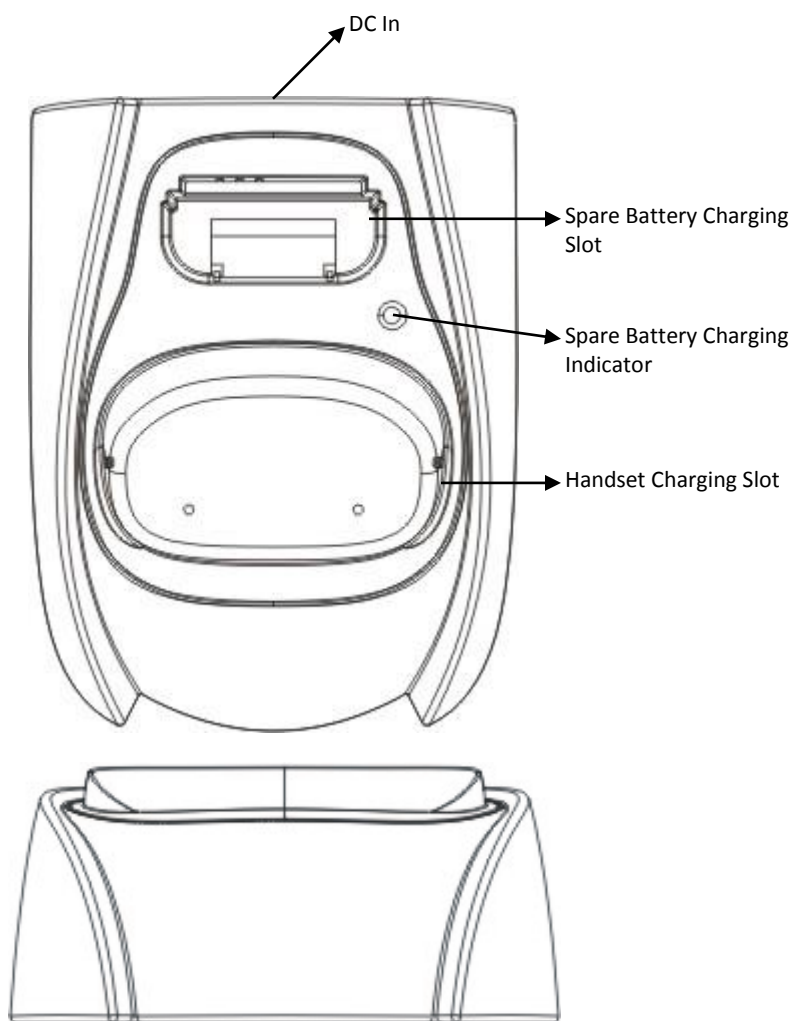

Charger Features

1. DC In
Connects to Charger AC Adapter.
2. Handset Charging Slot
 - a. Charges handset battery when handset is placed in the cradle.
 - b. Refer to the handset LCD for charging status.
 - (1) Charging: battery status bar is running and the LCD screen shows: "Charging."
 - (2) Fully Charged: battery status bar stands still and the LCD screen displays "Charge Complete."
 - (3) Charge Fail: If an error occurs during charging mode, the LCD screen will display "Charge Fail."
3. It is impossible to overcharge the battery using this charger.
4. The charging station adapter can also be used as a travel charger. However, you cannot turn off the power while you charge the handset via the travel charger. A warning message, "Unplug Travel Charger then OFF" will be shown on the LCD.

Notes:

1. Fully charge battery packs before first use.
2. Handset will "power on" automatically when placed on the charging slot.
3. However, if you drain the battery completely, it will take approximately one minute for the handset to auto power on.

Getting Started

Base Station Installation

1. Plug the transformer end of the base station AC/DC adapter into a standard AC electrical power outlet, plug the other end into the “DC In” jack on the back of the base station.
2. Plug the phone cord into the “RJ11” FXO jack.
3. Plug the Ethernet cord into the “RJ45” LAN jack.

PS: For SIP configuration, please see page 51.

Handset and Charger Installation

1. Plug the transformer end of the Charger AC/DC adapter into a standard AC electric power outlet, plug the other end into the “DC In” jack on the back of the Charger.
2. Install the battery pack onto the handset.
3. Install the handset antenna.
4. Place the handset onto the charger slot.
5. Fully charge the battery for three hours before use.
6. The phone system is now ready to perform basic functions such as making and receiving phone calls and intercom calls. No base station or handset programming is needed for basic operations.

Note:

1. Handset(s) packaged along with a Base Station are pre-registered at the factory. If you have a new handset, you will need to register the handset with the base station in order to be recognized as a member handset by the base(s) and by other handsets. See Handset Registration.
2. Fully charge battery packs before the first usage.

Basic Operations

Operation Modes

Both the base station and handset have feature levels that can only be accessed when in certain modes.

A. Base Operation Modes

1. **STANDBY mode**- this is the default mode. The page key is active in standby mode only. The base "Power" LED will light up during this mode.
2. **TALK mode**- the base station operates in this mode during a phone call. The "In Use" LED will light up only for a FXO call.
3. **REGISTRATION mode**- the base station enters this mode by pressing and holding the REG button for 3-seconds. The INTERCOM LED will be blinking in "Registration" mode, and a prompt sound will be emitted.

B. Handset Operation Modes

1. **STANDBY mode**- this is the default mode.
 - a. If there is no on-going activity, the handset automatically goes into SLEEP/STANDBY mode to save battery power.
 - b. The handset can be turned off completely by holding down the  key for 3-seconds.
 - c. The standby screen display (custom name) can be edited.
 - d. The 2-digit number represents the handset ID.



2. **MENU mode**
 - a. Press the (Right) soft function key to activate Menu mode.
 - b. In Menu mode, the handset settings and information contained in the memory can be changed.
 - c. The functions available through the Menu selection are covered in greater detail starting on page 63.
 - d. The Menu structure display as below:

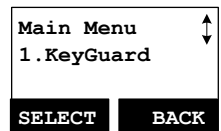

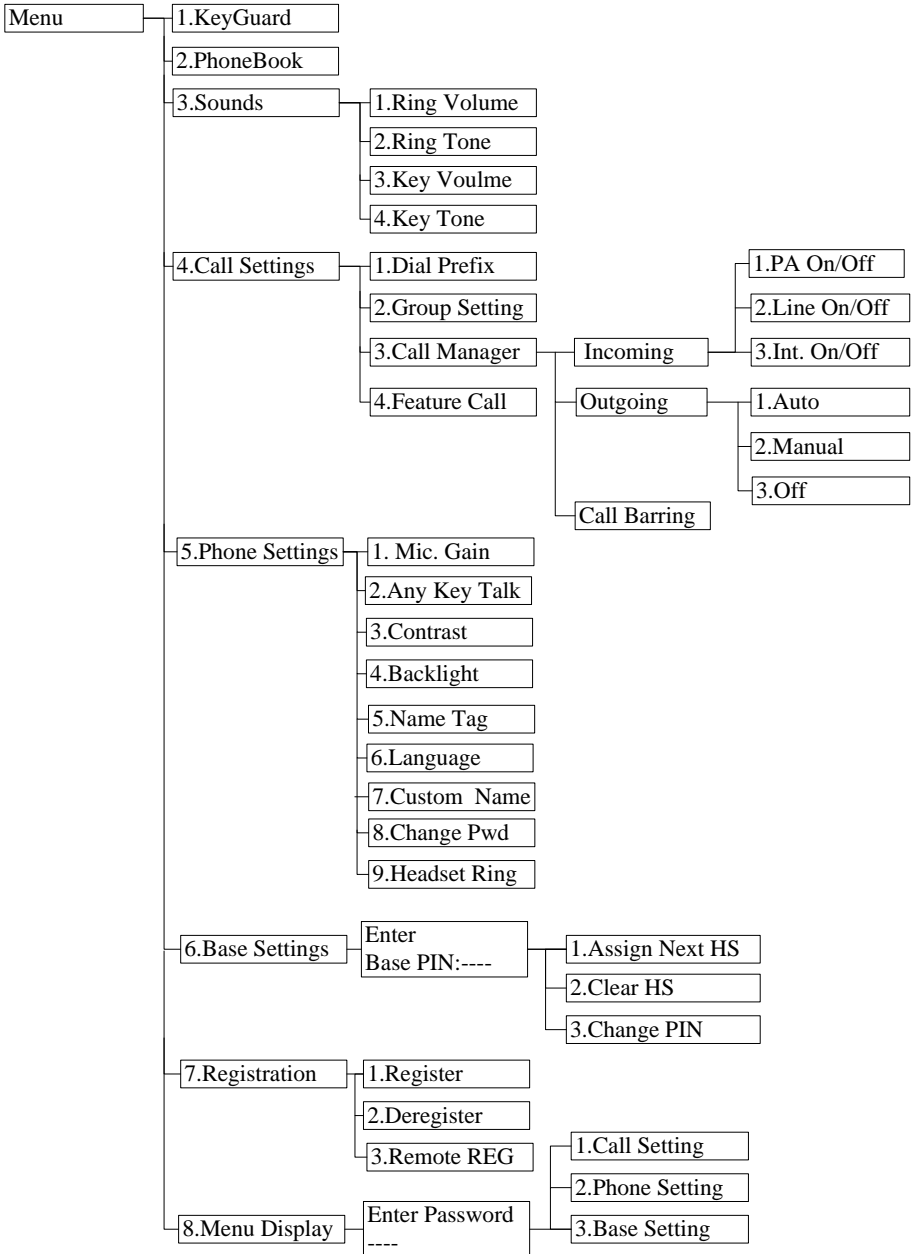

3. Menu Tree

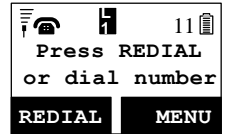

Making a Telephone Call

1. Press  wait for dial tone, then enter the phone number.





2. Alternatively, you can enter the phone number first, then press  key.

When using this method, you can use the **CLEAR** (Left) and **DELETE** (Right) soft keys to edit the number entered.

"Delete" erases the last digit entered. "Clear" erases the entire line but remains in the dial-and-send dialing.



3. **Speed dial** by accessing the entries in the phone book.
(Menu→2)

a. Press  or  scrolling key to enter the phone book.

b. Press  to dial the number.



4. To abort dialing, press  key.

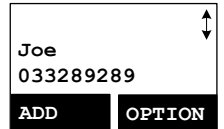



Notes:

1. If a link cannot be established, the LCD will show "Base not found" after a 6-second time out.
2. A call duration timer will start displaying the length of the call after a link is established.

Making a 2-Way/ Intercom Call

The DuraFon-SIP Cordless Phone System offers private, Intercom/ 2-Way Radio calls independent of the base station. Intercom/ 2-Way communication can be placed between handsets.

1. Press  key followed by a two-digit handset ID or Group ID.
2. Press  key to end the call.

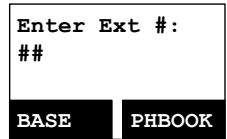

Notes:



1. Intercom calls can be made regardless of the Base Station being present.
2. If a Group ID is entered, the first handset (belonging to that group) that answers will establish a link with the caller. See Handset Group Subscription.
3. If a link cannot be established, the LCD shows "Paging timeout" after a 35-second time out.

Making a Broadcast

Handset-to-Handset Calls

1. Broadcasting to all handsets
 - a. Press and hold  key from one handset.



- b. Start speaking the broadcast message once you hear the key tone; the speakerphone of destination handsets will open when it receives the voice.
Re: the initiating handset needs to press and hold  key while speaking or broadcasting.
- c. Release  key to end broadcasting.

2. Broadcasting to a group of handsets

- a. Enter the Group ID and then press and hold



key.

- b. Start speaking the broadcast message once you hear the key tone; the speakerphone of destination handsets will open when it receives the voice.

Re: the initiating handset needs to press and hold  key while speaking or broadcasting.

- c. Release  key to end the broadcasting.

3. Broadcasting to an individual handset

- a. Enter the Handset ID and then press and hold

 key.



- b. Start speaking the broadcast message once you hear the key tone; the speakerphone of destination handsets will open when it receives the voice.

Re: the initiating handset needs to press and hold  key while speaking or broadcasting.



- c. Release  key to end the broadcasting.

Redial

- 1. Press **REDIAL** (Left) soft key.

- 2. The LCD shows the last phone number dialed. To dial this number, press  key.



- 3. Use  or  key to scroll through the last 10 phone numbers dialed. Select and press  key to dial the selected number.

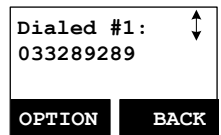

Note: Intercom numbers (Handset ID) are not stored in the last 10 numbers dialed log.

Receiving a Telephone Call

1. When an incoming call arrives, the LCD will show the Caller ID message, and the ringer will ring or vibrate unless the ringer has been turned off.
2. If the handset is on the charger cradle (ringer will be temporarily switched to “Ring” if it has been set to “Vibrate”), lift the handset and press  key to start a conversation.





Re: You can turn on the “Any Key Talk” from **MENU**-5-2.

Notes:

1. You can press **SILENT** (Left) soft key if you choose to ignore the call. Unlike turning off the ringer (from the handset menu), the **SILENT** key operation is valid only for the current call.
2. If Caller ID service is available, the LCD will display the incoming call information. If the LCD shows “Private” or “Unknown,” the caller or the originating phone company may have blocked the caller’s information.

Receiving an Intercom Call

1. When an intercom call arrives (called from other handsets, ex. Handset 12), the ringer will ring or vibrate unless the ringer has been turned off. Press  to answer the intercom call.
2. If the handset is on the charger cradle (ringer will be temporarily switched to “Ring” if it has been set to “Vibrate”), lift the handset and press  key to start a conversation.

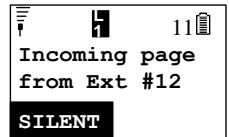

3. If the handset is not on the cradle and **MENU**-5-2 “Any Key Talk” setting is “On,” press any key (except  and the **SILENT** soft key) to answer.



Notes:

1. The LCD displays the caller’s Handset ID.
2. You can press the **SILENT** (Left) soft key if you choose to ignore the call. Unlike turning off the ringer the **SILENT** key operation is valid only for the current call.

Ending a Call



To end a telephone or intercom call, press  key, or place handset into charger cradle.

Adjusting Handset Receiver (Earpiece) Voice Volume

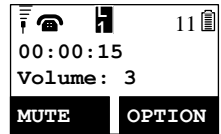
1. Voice volume can only be adjusted during a call.
2. There are 6 levels of volume selections. Use  or  key to adjust.
3. The new setting will remain effective for all future calls until changed.



Adjusting Handset Speakerphone Voice Volume

1. Voice volume can only be adjusted during a call (in speakerphone mode).
2. There are 6 levels of volume selections. Use  or  key to adjust.
3. The new setting will remain effective for all future calls until changed.

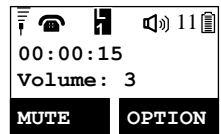

Placing a Call On Hold

1. When a call is in progress, it can be put on hold by pressing **OPTION** (Right) soft key and the ***** key.
2. To return to the conversation, press **UNHOLD** (Left) soft key.

You have a
call on hold

UNHOLD **OPTION**

Notes:

1. Handset LCD displays when a call is on hold. An alert tone (a beep) every 30-seconds will remind the handset that a call is on hold.
2. If the operation (e.g., call transfer) fails after putting a call on-hold, the held call may be dropped.

Mute

1. After a link is established, you can press **MUTE** (Left) soft key to mute the handset microphone.
2. When mute is active, the other end will not hear your voice, but can still speak to you.
3. To leave the mute state, press **UNMUTE** (Left) soft key. Mute is effective only for the current call.

00:00:15
MUTE
UNMUTE **OPTION**

Do Not Disturb (Silent Ring)

1. Enter the key sequence **MENU**-3-1, then select "Off." Press **SELECT** (Left) soft key to confirm your choice. This will turn off the ringer until it is turned on again from the menu.
2. For temporary silencing the ringer when an incoming call arrives, press **SILENT** (Left) soft key.

Joe
033289289
SILENT

Key Guard

1. To prevent accidental dialing, you can press **MENU** (Right) soft key, then press "1" to select Key Guard option. The handset keypad is now locked. No key entry is accepted.



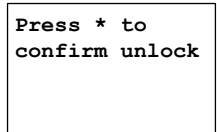

2. To unlock the keypad, press **UNLOCK** (Left) soft key, then, within 2-seconds, press the digit ***** to unlock.



3. Once returning back to standby mode for 15-seconds, the Key Guard will be automatically enabled.
4. Key Guard is in effect until unlocked.

Battery Recharge and Replacement

1. Charge the battery when one or several of the following happen:
 - a. Phone beeps twice (every 60-seconds in talk mode, every 10-minutes in standby mode).
 - b. Battery icon is empty.
 - c. Phone does not respond when a power On/Off key  is pressed.
 - d. LCD and backlighting become dim.
 - e. Talk range shortfall is experienced.
2. You can replace the handset battery after placing the call-in-progress on hold and press  key. To retrieve the call on hold, press Talk key again after replacing the battery and powering on the handset.
3. Battery talk time and standby times vary depending on the talk/standby pattern and the operating distance. Putting the handset back on the charger cradle as often as possible is recommended for best performance.

Use only the manufacturer's provided battery and charger!

Advanced Operations

Handset Registration

1. If your handset(s) is purchased as part of a system, it has been pre-registered with the base station at the factory.
2. If the Handset ID is "00," this means it is a new handset or the ID has been erased. You will need to register the handset with the base station.

3. Registration:

- a. Press **MENU-7** to enter the registration mode.
- b. Press and hold the base's REG button for 3-seconds until the INTERCOM LED lights up and flashes. The base station will emit a prompt sound to remind you the base station is in the registration mode.

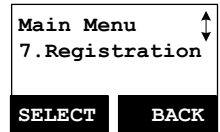

- c. Press handset key **1**, this completes the registration process. The base station will assign a handset ID between 10 and 19 automatically. The assigned ID will be displayed on the handset LCD, indicating successful registration.

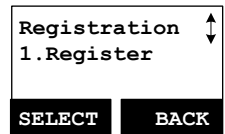

- d. Repeat above steps for all additional handsets.

4. De-registration:

- a. You can de-register the handset you're using from the base station. De-registration will reset the Handset ID to 00, erase the system security code, and free up the handset ID for future registration.

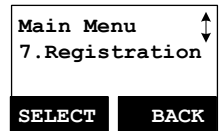

- b. After de-registration, the handset will not be able to use the base station to make or receive phone calls, nor can it intercom other handsets.

- c. Press **MENU-7** to enter the registration mode.
- d. Press and hold the base's PAGE button for 3-seconds until the In Use INTERCOM LED lights up and flashes, also the base station will emit a prompt sound to remind you the base station is in the de-registration mode.



- e. Press the handset number key **2**, this completes the

de-registration process. Upon successful de-registration, the handset display will show “Please register.”

Notes:

1. The base station has a 30-second registration timeout starting when you press the REG button. The handset has a 6-second registration timeout starting when the registration or de-registration option has been selected. The base station and handset will automatically exit registration mode after timeout.
2. Repeat registration or de-registration process if unsuccessful.

Handset Group Subscription

1. Up to nine handset groups (1-7) can be defined, and handset users can decide which group(s) they want to be in.
2. For example, Group 1 represents the Customer Service Group, Group 2 represents the Sales Group

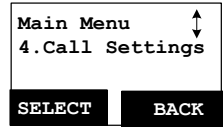

and Group 3 is the Marketing Group. Suppose that handset 11 wants to receive incoming rings for all Sales and Marketing related calls. Then handset 11 will need to “subscribe” to Group 2 and Group 3.

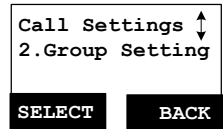

3. Group Selections:
 - a. Press handset **MENU**-4 to enter the Call Settings menu.
 - b. Press number **2**, handset enters group setting menu.



- c. Press **OPTION** soft key followed by **1** key to subscribe the group (“#”, #:1~7). Enter 1~7.
- d. Repeat for all desired groups.

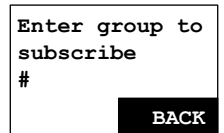

- e. Delete group selections by pressing **OPTION** soft key followed by **2** to Unsubscribe the group.



Notes:

1. The handset can change group affiliations at any time.
2. The base station is not responsible for group assignments. Consequently, it cannot de-subscribe a handset from a group.
3. When an intercom caller enters a group ID, all handsets subscribed to this group will ring. The first handset to answer will establish a link with the caller. Afterward, it is a one-to-one call, not a one-to-many call.

Call Transfer

While a telephone call is in progress, you can transfer it between different handsets.

Direct transfer

1. Press **OPTION** (Right) soft key, followed by the ***** key to put the call on hold.
2. Press **OPTION** (Right) soft key, followed by selecting **XFER** item and then entering the destination handset ID, then the held call will be transferred directly.

After the call is transferred to the destination handset, the original handset will go back to standby mode automatically.



Indirect transfer

If you want to talk to the destination handset before the call is transferred, you can follow the below method:

1. During the call, press **2-WAY INTERCOM** key, then enter the destination handset ID.
2. Press the **TALK CC** of the destination handset to answer the intercom call, you can now talk to the destination handset.

After talking, press **END ON/OFF** to end the intercom call, and then the destination handset is able to pick up the incoming call automatically.

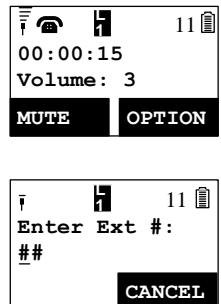

After the call is transferred to the destination handset, the original handset will go back to standby mode automatically.

Notes: If the destination handset does not answer after paging it or transferring timeout, the call is routed back to the originating handset.

Phonebook Operations

1. You can store up to 50-entries in the phone book. Each entry can contain a phone number or handset ID (up to 26-digits) and a name (up to 16-characters).
2. To access the phone book, press **MENU** (Right) soft key, followed by **2** or press **↓** scrolling key while the handset is in standby mode.



3. To add a new entry:
 - a. Press **ADD** (Left) soft key.
 - b. Enter the name when LCD prompts "Name?" Use **DELETE** (Right) soft key to delete the last digit entered. When completed, press **SAVE** (Left) soft key to save. Re: Up to 16-characters can be entered as the name.

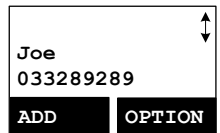



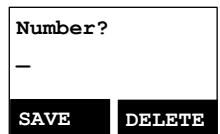
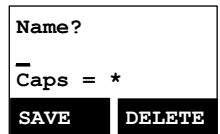



- c. You will then be prompted to enter a number for the name just entered. Re: Up to 26-digits can be entered as the number.
 - d. After entering the number, press the **SAVE** (Left) soft key to save this entry into phone book.
 - e. Enter a phone book entry without a name; all records without a name will be placed on the top of the phone book list.



- f. To enter the name, press the corresponding keypad number one or more times according to the order of the character on the key.

See table below for a list of available characters and their orders. For example, press **2** once for the character “A,” twice for “B,” etc.

Notes:

1. When entering a phone number, the cursor automatically advances to the next digit field. Use  or  scrolling key to move the cursor backward or forward to insert or delete (the digit above the cursor or left of the cursor if the cursor is on the right of the last digit).
2. When entering a name, the cursor automatically advances to the next character field if you press a different key for the next character. If you need to enter consecutive characters from the same key, you can wait for the cursor to advance or use  or  scrolling key to move the cursor backward or forward manually. Also use  or  to move the cursor to insert (to the left of the cursor) or delete (the character above the cursor or left of the cursor if cursor is on the right of the last character).
3. By default, all letters are entered in upper case. Use the  key to toggle between upper and lower cases.
4. A “Pause” entry represents a 1-second delay in dialing the following digits, which is useful when calling a sequence of segmented numbers (e.g., access codes, credit card numbers, auto-attendant entries, etc.) Pause is entered by pressing the # key twice (LCD displays P). Entering pause twice (PP) will result in 2-seconds pause in the dialing.

5. Character Table:

Key	Characters and Orders
1	' + , . * () & 1
2	A B C 2
3	D E F 3
4	G H I 4
5	J K L 5
6	M N O 6
7	P Q R S 7
8	T U V 8
9	W X Y Z 9
0	0
*	Caps – when in character editing. * – when in number editing.
#	Space & # – when in character editing. # & P (Pause) – when in number editing.

4. The entries are alphabetically sorted and stored as a list in an ascending order (A to Z) from the top of the list.
5. The first line of the LCD display shows the name and the 2nd line shows the phone number. If the phone number is longer than 16-digits, press **OPTION** (Right) soft key and select Option 3 “View Number” to view the complete number.
6. To search for a record:
 - a. Use **Y** scrolling key to enter the Phone Book mode.
 - b. Press a key that corresponds to the first character of the name you are looking for.
 - c. For example, you are looking for “EnGenius,” then press the number **3** twice.
 - d. Use **^** or **Y** scrolling key to locate the exact record you are looking for.
7. To erase phone book:
 - a. Use **^** or **Y** scrolling key or the alphabetical search method to locate the record to be erased or edited.

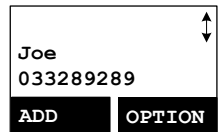



b. Press **OPTION** (Right) soft key to enter the option menu.

c. Press **1** to erase the desinated phone entry.

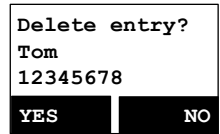
d. LCD shown “Delete entry?” Press **YES** (Left) soft key to confirm your change.



8. To edit phone book:

a. Use  or  scrolling key or the alphabetical search method to locate the record to be erased or edited.

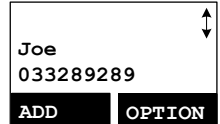

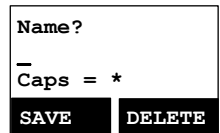

b. Press **OPTION** (Right) soft key to enter the option menu.

c. Press **2** to edit the designated phone entry.





9. Dial from display:

a. Press  or  to dial the phone number or Handset ID displayed.

10. To transfer the phone book:

To transfer the phone book, both parties have to enter the phone book transfer mode first by following below:

a. Press **OPTION** (Right) soft key followed by **5** or by scrolling   key to transfer when the handset is in phone book mode.

b. For the phone sending party, press **1** to enter the sending mode.

i. Either press **TX ALL** (Left) soft key to transfer all phone book entries to another handset(s).

ii. Or press **TX ONE** (Right) soft key to transfer one entry to another handset(s).

iii. Press the 2-digit handset ID or group ID, then select all phone book entries or one entry to be transferred.

Re: “00” means all handsets.

iv. During phone book transfer, the LCD shows “Sending” and 2-digit countdown on the LCD to indicate the phone book numbers which are pending.

c. For the phone book receiving party, press **2** to enter the receive mode.

i. When entering the receiving mode, the LCD shows “Ready.”

- ii. Start to receive the phone book, the LCD shows, “Get phone book from Ext. # : xx.”
- iii. A beep is emitted when receiving each phone book.
- iv. When the phone book is being received, a 2-digit countdown shows on the LCD to indicate the phone book numbers that are pending.

Re: Since the phone book transfers through the wireless interface, it may partially miss transmission if there is any interference.

11. To transfer phone book via web:

You can edit/store 50-phone book entries via the web interface. The base can be used as the sending party.

- a. Place the receiving handsets to Receiving mode, by pressing **OPTION** (Right) soft key follow by **5** , **2** to enter Receiving mode. The LCD shows “Ready.”
- b. Press “Transfer” button on the web interface of the base to send up to 50-entries of the phone book.

Re: The handset will not update any phone book when it stores up to a maximum of 50-entries.

Programmable Feature Call

- 1. If DuraFon-SIP base station is installed behind a PBX system, it is feasible to pre-program some call features along with the PBX’s feature code into the system.
- 2. Up to 10 most frequently used feature call codes can be pre-programmed.
- 3. Name and enter feature call codes:

- a. Press **MENU** (Right) soft key while the handset is in the standby mode.
- b. Press **4** , followed by **4** to enter the “Feature Call” menu.
- c. Press **ADD** (Left) soft key to add a new feature call entry.
- d. Key in the name of the feature call, like editing a phone book entry, i.e. “PBX Transfer.” Press **SAVE** (Left) soft key to confirm.

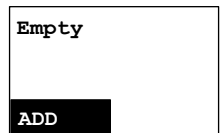
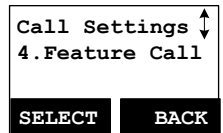

- e. Key in the feature call code of the corresponding PBX feature, i.e. F*70.

Press **SAVE** (Left) soft key to confirm.

Re: "F" represent the Flash signal.

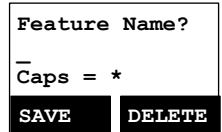

- f. The 1st feature call and corresponding feature call code you entered will appear on the LCD screen.

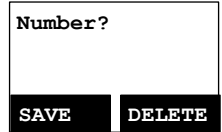

- g. Press **OPTION** (Right) soft key to delete or edit the feature call you programmed into the system.
 h. Repeat the same operations to program the 2nd and subsequent feature call that you will use frequently.

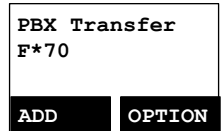

4. Using pre-programmed feature call during the call.

- a. Press **OPTION** (Right) soft key while the handset is in the Talk mode.
 b. Press the correspondence number of the feature call you want to perform, i.e. press "0" to perform the "PBX Transfer."

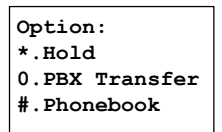
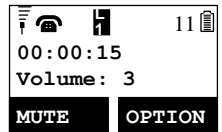

Notes:

1. This feature call would be useful if the DuraFon-SIP base station is adjunct to a PBX system or
2. If you have not pre-programmed any feature call into the system, only “#.Phonebook” in the **OPTION** menu.
3. The DuraFon-SIP’s programmable feature call may not function with all PBX or Key phone systems due to the diversity of various proprietary systems.

Caller ID

1. Contact your local phone company to subscribe to this feature. The phone system receives and displays Caller ID information transmitted by your local phone company. This information may include the calling phone number, name, date and time. This unit can store up to 50 calls of Caller ID information.
2. The display will show the date and time of the call on the first line, followed by the name on the second line, and the phone number on the third line. An unread record will have a “NEW” at the end of the first line of the display.
3. When viewing a call record, the number can be dialed, stored to the phone book or deleted.

View Call Log

1. To view the call log, press **▲** to enter the Call Log.
Press **▲** or **▼** key to scroll through the numbers and names when available.

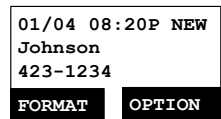

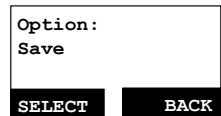

2. Press **OPTION** (Right) soft key, you can **▲** or **▼** key to choose save, delete or clear all.
a. Save call log:

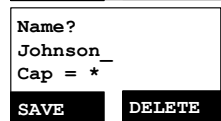

- (1) Press **SELECT** (Right) soft key, you can use **▲** or **▼** key to scroll the name, and press **DELETE** to edit the name.
Then press **SAVE** (Left) soft key to save the name.



- (2) Use  or  key to scroll the number, and press **DELETE** to edit the number.
Then press **SAVE** (Left) soft key to save the number.

Number? 4231234_	
SAVE	DELETE

- (3) After the above process, the call log is saved into the phone book.

b. Delete call log:

- (1) Press **SELECT** (Right) soft key followed by **YES** (Left) soft key to confirm deleting.





Option: Delete	
SELECT	BACK

c. Clear All:

- (1) Press **SELECT** (Right) soft key followed by **YES** (Left) soft key to confirm clearing all Caller ID records.

Option: Clear all	
SELECT	BACK

Call a Caller ID

1. Press  key on idle screen to enter the call log, use  or  key to scroll the call log.
2. When screen displays a Caller ID, Press  to dial this number.

Call Manager

“Call Manager” feature allows four options:

1. The first option is “Incoming.” The handset can be selected to enable receiving of the incoming PA, intercom call, line call.
2. The second option is “Outgoing.” The handset can be set to access available bases automatically, manually or as a pre-defined telephone line.
3. The third option is “Call Barring.” The handset can be selected to block the calls, which are not allowed.

Note: When entering this menu (Call Manager), you must enter the handset’s password first (4-digits). The default handset password is “0000.”

Incoming

1. Press **MENU** (Right) soft key followed by **4** to enter the Call Settings mode.
Press **3** to select Call Manager, then enter handset's password (4-digits).

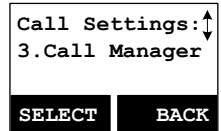

- a. Press **1** to enable receiving PA On/Off.
Re: Default setting is "ON."

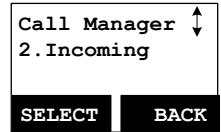

- b. Press **2** to enable receiving Line On/Off which includes FXO line only.
Re: Default setting is "ON."
- c. Press **3** to enable receiving Intercom On/Off.
Re: Default setting is "ON."

(1) By default, all incoming calls will ring all handsets.



When entering this menu, you must enter handset password first (4-digits).
Re: The default handset password is "0000."

Outgoing

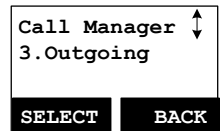
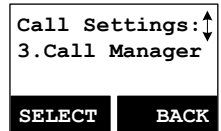
1. Press **MENU** (Right) soft key followed by **4** to enter the Call Settings mode.
Press **3** to select Call Manager followed by entering handset's password (4-digits).
The handset is able to make outgoing calls via the SIP line or PSTN line.
Re: Default setting is "Auto."





- a. Press **1** to "Auto." The handset is able to make outgoing calls via an available line and SIP line automatically.

- b. Press **2** to “Manual.” When pressing  key in standby mode, the handset LCD will show the available line. Press  or  to scroll the options: 1. SIP, 2. Line. Press 1, you can select the SIP line 1 to make a call.
- c. Press **3** to “Off.” The handset is disabled from making any outgoing calls.

Call Barring

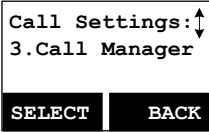
- 1. Press **MENU** (Right) soft key followed by **4** to enter the Call Settings mode.
Press **3** to select Call Manager, and enter handset’s password (4-digits).



Press  or  to scroll the options: select “Call Barring” to block users from dialing long distance or international calls. This also blocks incoming calls from outside lines or other registered handset.
Re: Default Call Barring is “OFF.”

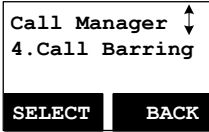

- 2. To add the Call Barring code:
 - a. Once you turn on the Call Barring feature, you can key in the “Call Barring” code.
To add one block code, press **ADD** (Left) soft key then start entering the Call Barring code. After entering the Call Barring code, press **SAVE** (Left) soft key to save.
 - (1) Up to 5-digits can be edited for the Call Barring code. For example, if you want to block all calls dialing to Manhattan, NY area, you can enter 1212 as the Call Barring code.
 - (2) If your base station is adjacent to a PBX system, please also include that specific number to retrieve the PSTN tone.

- b. Press **OPTION** (Right) soft key to delete or edit the Call Barring codes.
Up to 5 sets of Call Barring codes can be programmed.

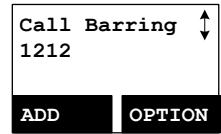

- c. If you want to block all outgoing calls, enter “* * * * *” 5 “*” keys, then press **SAVE** (Left) soft key to save it, and all outgoing calls will be restricted.

Visual Message Waiting Indicator (VMWI)



VMWI feature supports the FSK message and stutter tone detection, which is received from the telephone line; it will activate a message icon on the handset.

Notes:

1. A subscription to the telephone company’s voice mail service is required.
2. If the handset still indicates the icon, even after you have listened to all messages, turn it off by pressing and holding “Caller ID” key on the handset.

Adjust Handset Microphone Gain

If you will use the handset in different workplaces or environments, you can adjust the handset microphone gain to obtain a better voice quality that is suitable for various locations.

- a. Press **MENU** (Right) soft key while the handset is in the standby mode.
- b. Press **5** (Phone Settings), followed by **1** to enter the “Mic. Gain” menu.
- c. Use  or  key to scroll the “Standard,” “Medium” and “Low” options.
- d. If you are using the handset in quiet environments, like an office or meeting room, the “Standard” level is recommended.

If you are using the handset in a noisy environment, like a factory or outdoor place, the level of “Medium” or “Low” is recommended.

Adjust Headset Ring

When using the headset, you can change the ringer to emit from either the handset speaker or receiver of headset to avoid missing calls.

- a. Press **MENU** (Right) soft key while the handset is in the standby mode.
- b. Press **5** (Phone Settings), followed by “9” to enter the “Headset Ring” menu.
- c. Select **On**, so the ringer emits from the headset receiver; if **Off** is selected, the ringer will emit from the handset speaker.

SIP Configuration

Introduction

The DuraFon-SIP is a long-range cordless telephone system with built-in LAN and a traditional FXO port. It provides users the ability to make VoIP or PSTN calls via different ports. Below describes how to setup the SIP configuration of the DuraFon-SIP base from the web.

Application

Typically, the DuraFon-SIP is able to connect to a legacy PBX (or PSTN line) via a telephone jack, and in addition, with an IP-PBX via a networking jack. These two interfaces are perfectly suitable for adjunct telephone systems in enterprise environments as shown in the following figure.

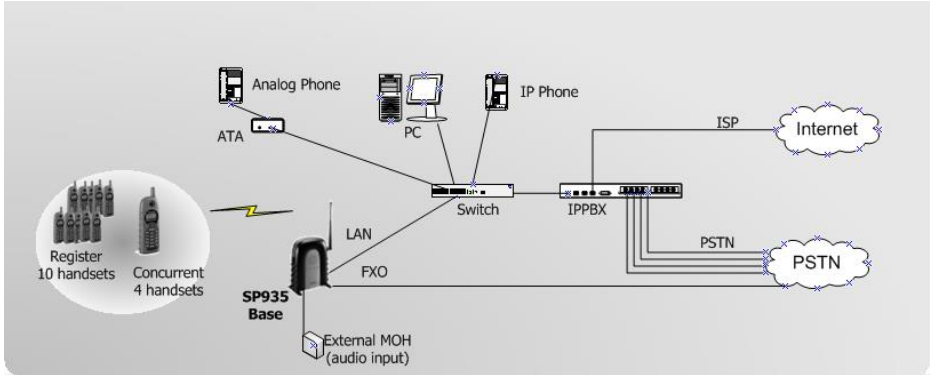

VoIP Features

- Support 3 VoIP and 1 PSTN line calls simultaneously.
- Each handset has only one SIP account.
- Register Up to 10 SIP accounts and 10 handsets accordingly.
- Flexible Call Manager features to dedicate either the SIP or PSTN call.
- Use G.711U-law for VoIP codec.
- SIP and LAN setting from web configuration.
- Internet interface: 10/100base-T LAN port x1

Registration Handsets

- Before setting the SIP configuration, the available handset(s) of the DuraFon-SIP must register to the base.
- Register handset:

- (1) Press and hold the register key on the base until the “INTERCOM” LED changes to a flashing status. The base can perform the handset registration while the LED is flashing.
- (2) On handset, enter “MENU, 7, 1” to enter the registration.
- (3) The assigned ID (from 10 to 19) will be displayed on handset LCD, indicating successful registration.
- (4) Repeat the above steps for all additional handsets.

Default Settings

Connect the Internet port to the DuraFon-SIP’s LAN port.

IP Address	192.168.1.156
Username / Password	admin / admin

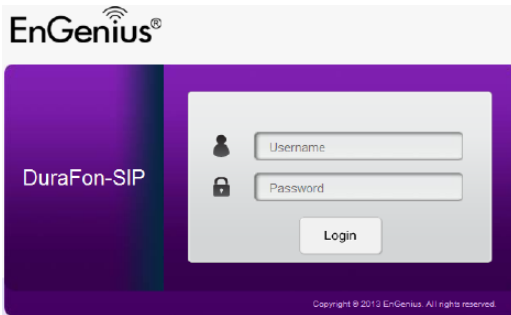

Web Configuration

Open a web browser (Internet Explorer/Firefox/Safari/Chrome) and enter the IP Address <http://192.168.1.156>



The default username and password are **admin**. Once you have entered the correct username and password, click the Login button to open the web-base configuration page. If successful, you will be logging in and see the configuration of DuraFon-SIP.

LAN Configuration

System
Status
LAN
Log
Base Settings
Phonebook
 VoIP
 Tools

Mode Dynamic IP (DHCP) Static IP

LAN IP

IP Address

IP Subnet Mask

Default Gateway

DNS



DNS type

Primary DNS

Secondary DNS

Note: When you change the LAN IP to DHCP, once you click **Apply**, the change will take effect. You will now know the new IP of the DuraFon-SIP in advance of accessing the web configuration next time.

Base Settings

System
Status
LAN
Log
Base Settings
Phonebook
 VoIP
 Tools

Authentication Password

Advanced Settings

Auto Hang Up

Base Intercom Auto Answer

Message Waiting Indication

DTMF CID Format

Line Detection

PSTN Line In Dedication



PSTN Line Out Dedication

RF Settings

Channel Range

Note: When you change any of the Base Settings, click **Apply** for the change to take effect. The items shown in gray are not changeable and are reserved for other versions.

Phone Book

 System
Status
LAN
Log
Base Settings
Phonebook
 VoIP
 Tools

No file selected.

You can store up to 50-entries in the phone book on the DuraFon-SIP base.

- Click the **Add phone book** button to add entries. Click the **Export phone book** button to export this phone book to a specific file in .csv format.

- If you have this contact list file in advance, you can click the **Browse** button to select it, and click the **Import phone book** button to import the contact list.

Note: After you edit all entries in the phone book via web interface, you need to place handsets in receiving phone book mode. Click the **Transfer phone book** button to send the phone book over the air. See phone book transfer via web on page 43.

Phonebook List

No	Name	Number	Action	
1	Bill	10	<input type="button" value="Edit"/>	<input type="button" value="Release"/>
2	Mark	11	<input type="button" value="Edit"/>	<input type="button" value="Release"/>
3	Richard	12	<input type="button" value="Edit"/>	<input type="button" value="Release"/>

SIP Configuration

SIP Server

- System
- VoIP**
- Basic
- Account Setting
- Audio Setting
- Tools

VoIP Server IP:

VoIP Server Port: (5060-5080) Indicating Server Port

VoIP Dial Mode: Enable Terminate Key

STUN:

QoS:

BLF:

Invite Timeout:

DNS SRV:

Allow SDP NAT Rewrite:

SIP Local Port: (1-65535)

RTP Ports (1024-65535)

Start:

End:

RTP Ptime:

SIP Outbound Proxy:

SIP Outbound Proxy Port: (5060-5080)

Note: The Enable Terminate Key is used for dialing pound (#) digit or not. When you enable it, the # digit is to call out the previous digits immediately. If you disable it, the # digit is regarded as a one of normal digit.

SIP Account

Enter VoIP-> Account Setting

- System
- VoIP**
- Basic
- Account Setting**
- Audio Setting
- Tools

User List

HS ID	SIP Number	Display Name	Status	Account Active	Action
10	10	10		Enable	<input type="button" value="Edit"/> <input type="button" value="Release"/>
11	11	11		Enable	<input type="button" value="Edit"/> <input type="button" value="Release"/>

Note: The status column is shown the SIP account in on-line or off-line. The green light is used for on-line. The gray light is used for off-line

System
VoIP
Basic
Account Setting
Audio Setting
Tools

User Information Settings

User Name

Display Name

Password

Re-type Auth Password

Account Active Enable Disable

Individual Account

- **Note:** You should register every handset on the DuraFon-SIP base before you start setting the SIP configuration.

The default SIP number is set according to handset ID, which means SIP number 10 is set for handset ID 10, and accordingly. You will need to enter the Edit button for each account.

System
Wireless
VoIP
Basic
Account Setting
Audio Setting
Tools

User Information Settings

User Name

Display Name

Password

Re-type Auth Password

Account Active Enable Disable

Click the **Apply** button to save the setting as the screen shows:

Module is reloading, please wait for **1** seconds

After you finish these account settings, you will need to click the **Apply** button as shown in red to activate the setting.

✕ VoIP
Basic
Account Setting
Audio Setting
✕ Tools

User List

HS ID	SIP Number	Display Name	Status	Account Active	Action
10	10	10	<input checked="" type="radio"/>	Enable	Edit Release
11	11	11	<input checked="" type="radio"/>	Enable	Edit Release
12	12	12	<input checked="" type="radio"/>	Enable	Edit Release
13	13	13	<input checked="" type="radio"/>	Enable	Edit Release
14	14	14	<input type="radio"/>	Disable	Edit Release
15	15	15	<input type="radio"/>	Disable	Edit Release
16	16	16	<input type="radio"/>	Disable	Edit Release
17	17	17	<input type="radio"/>	Disable	Edit Release
18	18	18	<input type="radio"/>	Disable	Edit Release
19	19	19	<input type="radio"/>	Disable	Edit Release

Group Acc

1	1	Group1	<input type="radio"/>	Disable	Edit Release
2	2	Group2	<input type="radio"/>	Disable	Edit Release
3	3	Group3	<input type="radio"/>	Disable	Edit Release
4	4	Group4	<input type="radio"/>	Disable	Edit Release
5	5	Group5	<input type="radio"/>	Disable	Edit Release
6	6	Group6	<input type="radio"/>	Disable	Edit Release
7	7	Group7	<input type="radio"/>	Disable	Edit Release



Group Account

When you want to assign one SIP account to ring many handsets at the same time, you can use the “Group Acc” setting. DuraFon-SIP supports 7 SIP accounts for group(s), which are used for incoming calls only.

- **Note:** Handsets should “subscribe” from the handset menu to group(s), before performing a group SIP call.

Group Acc

1	1	Group1	<input type="radio"/>	Disable	Edit Release
2	2	Group2	<input type="radio"/>	Disable	Edit Release
3	3	Group3	<input type="radio"/>	Disable	Edit Release
4	4	Group4	<input type="radio"/>	Disable	Edit Release
5	5	Group5	<input type="radio"/>	Disable	Edit Release
6	6	Group6	<input type="radio"/>	Disable	Edit Release
7	7	Group7	<input type="radio"/>	Disable	Edit Release

System

VoIP

Basic

Account Setting

Audio Setting

Tools

User Information Settings

User Name:

Display Name:

Password:

Re-type Auth Password:

Account Active: Enable Disable

Click the **Apply** button to save the setting as the screen shows:

Module is reloading, please wait for **1** seconds

After you finish these account settings, you need to click the **Apply** button as shown in red to activate the setting.

VoIP

Basic

Account Setting

Audio Setting

Tools

User List

HS ID	SIP Number	Display Name	Status	Account Active	Action
10	10	10	<input checked="" type="radio"/>	Enable	<input type="button" value="Edit"/> <input type="button" value="Release"/>
11	11	11	<input checked="" type="radio"/>	Enable	<input type="button" value="Edit"/> <input type="button" value="Release"/>
12	12	12	<input checked="" type="radio"/>	Enable	<input type="button" value="Edit"/> <input type="button" value="Release"/>
13	13	13	<input checked="" type="radio"/>	Enable	<input type="button" value="Edit"/> <input type="button" value="Release"/>
14	14	14	<input type="radio"/>	Disable	<input type="button" value="Edit"/> <input type="button" value="Release"/>
15	15	15	<input type="radio"/>	Disable	<input type="button" value="Edit"/> <input type="button" value="Release"/>
16	16	16	<input type="radio"/>	Disable	<input type="button" value="Edit"/> <input type="button" value="Release"/>
17	17	17	<input type="radio"/>	Disable	<input type="button" value="Edit"/> <input type="button" value="Release"/>
18	18	18	<input type="radio"/>	Disable	<input type="button" value="Edit"/> <input type="button" value="Release"/>
19	19	19	<input type="radio"/>	Disable	<input type="button" value="Edit"/> <input type="button" value="Release"/>

Group Acc

1	1	Group1	<input type="radio"/>	Disable	<input type="button" value="Edit"/> <input type="button" value="Release"/>
2	2	Group2	<input type="radio"/>	Disable	<input type="button" value="Edit"/> <input type="button" value="Release"/>
3	3	Group3	<input type="radio"/>	Disable	<input type="button" value="Edit"/> <input type="button" value="Release"/>
4	4	Group4	<input type="radio"/>	Disable	<input type="button" value="Edit"/> <input type="button" value="Release"/>
5	5	Group5	<input type="radio"/>	Disable	<input type="button" value="Edit"/> <input type="button" value="Release"/>
6	6	Group6	<input type="radio"/>	Disable	<input type="button" value="Edit"/> <input type="button" value="Release"/>
7	7	Group7	<input type="radio"/>	Disable	<input type="button" value="Edit"/> <input type="button" value="Release"/>

Audio Setting

In Audio Setting, after you change the setting and click **Apply**, you will need to power cycle the base in order for any changes take effect.

System
VoIP
Basic
Account Setting
Audio Setting
Tools

PSTN Line

Transmit Gain	0 dB
Receive Gain	6 dB
Country	USA
AC Impedance	600 Ω
Flash Time	600 ms
DTMF Gain	0 dB
DTMF Duration	100 ms

DSP/Software

PSTN Line In Gain	0 dB
PSTN Line Out Gain	0 dB

Codec/Hardware

Speaker Gain	-8 dB
Microphone Gain	6 dB
Music on Hold Gain	0 dB

Tools

Admin

This page allows you to change the username and password. By default, the username is **admin** and the password is **admin**. The password can contain 0 to 12 alphanumeric characters and is case sensitive.

System
VoIP
Tools
Admin
Time
Ping Test
Firmware
Back-up
Reset/Reboot/Reg

Login Name	admin
Old Password	
New Password	
Repeat New Password	

Admin	
Login Name	Enter a new username for logging into the New Name entry box.
Old Password	Enter the old password for logging into the Old Password entry box.
New Password	Enter the new password for logging into the New Password entry box.
Repeat New	Re-enter the new password in the Confirm Password entry box

Password	for confirmation.
Apply / Cancel	Click Apply to apply the changes or Cancel to return to previous settings.

Time

This page allows you to set the internal clock.

System	
VoIP	
Tools	
Admin	
Time	
Ping Test	
Firmware	
Back-up	
Reset/Reboot/Reg	

Time Setup Synchronize with the NTP Server

Time Zone

NTP Time Server

Time	
Time Setup	Select to sync with a NTP server or with the PC's internal clock.
Time Zone	Select a time zone from the drop-down list and check whether you want to enter the IP address of an NTP server or use the default NTP server to have the internal clock set automatically.
Apply / Cancel	Click Apply to apply the changes or Cancel to return to previous settings.

Ping Test

This page allows you to analyze the connection quality of DuraFon-SIP and trace the routing table to a target in the network.

System	
VoIP	
Tools	
Admin	
Time	
Ping Test	
Firmware	
Back-up	
Reset/Reboot/Reg	

Address to Ping

Ping Result

Ping Test	
Address to Ping	Enter the IP address you would like to search.

Ping Result	Check the specific IP address is live.
Start	Click Start Ping to begin pinging target device (via IP).

Firmware

This page allows you to upgrade the firmware of DuraFon-SIP.

To perform the Firmware Upgrade:

Click the **Browse** button and navigate the OS File System to the location of the upgrade file.

Select the upgrade file. The name of the file will appear in the *Upgrade File* field.

Click the **Apply** button to commence the firmware upgrade.

Note: The device is unavailable during the upgrade process and must be restarted when the upgrade is completed. Any connections to or through the device will be lost.

Back-up

This page allows you to save the current device configurations. When you save the configurations, you can also reload the saved configurations into the device through the “**Restore Settings**” from **A File** section. If extreme problems occur or if you have set up the DuraFon-SIP wrong, you can use the “**Reset**” button in the “**Restore to factory default**” section to restore all the configurations of the DuraFon-SIP to the original default settings.

Back-up	
Restore to factory default	Click Reset button to restore the DuraFon-SIP to its factory default settings.
Backup Setting	Click Save to save the current configured settings.
Restore Setting	To restore settings that have been previously backed up, click Browse , select the file, and click Upload .

Reset/Reboot/Registration

You can press and hold the below buttons to execute specific features or use the web interface.



These features (Reset, Reboot, and Registration) can be performed from this web setting:

System
VoIP
Tools
Admin
Time
Ping Test
Firmware
Back-up
Reset/Reboot/Reg

All the devices settings will be restore to the factory default. Please remember to back-up all your settings before to reset the device.

Reset to Default

In the event the system stops responding correctly or stops functioning, you can perform a reset. Your settings will not be changed. To perform the reset, click on the REBOOT button.

Reboot the Device

Register your handset after pressing the REGISTER button.

Register

System
VoIP
Tools
Admin
Time
Diagnosis
Firmware
Back-up
Reset



In the event the system stops responding correctly or stops functioning, you can perform a reset. Your settings will not be changed. To perform the reset, click on the APPLY button.

Apply

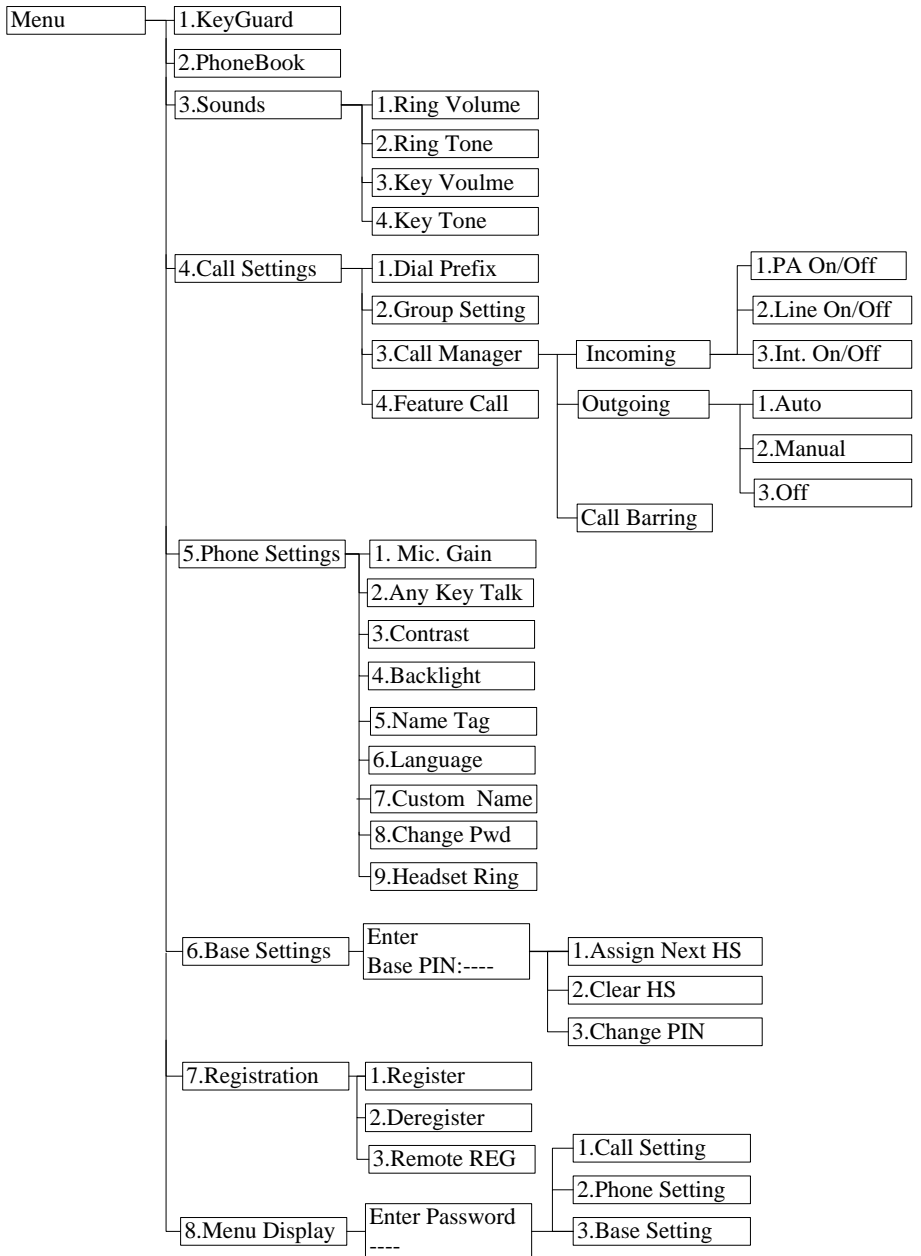
Menu Operations



1. Press **MENU** (Right) soft key to enter menu mode while the phone is in standby mode.

Re: You can either press  or , followed by **SELECT** (Left) soft key to confirm the selected menu. Or press the digit directly to confirm the selected menu. For example, press **MENU** (Right) soft key followed by **4** and **1** to select the Ring Volume.



2. Press **1** to select Key Guard (see Key Guard operation on page [35](#)).

3. Press **2** to add, delete, edit, view and edit the phone book (see Phone book instruction on page [39](#)).

4. Press **3** to set Sounds settings:



- a. Press **1** to select Ring Volume:

Two options for ring volume: Line (for incoming call) and Intercom (for intercom call). Set each option respectively.



When setting each option, use  or  to scroll through 6 options: "Off," "Low," "Medium," "High," "Vibrate" and "Vibrate & High." Press **SELECT** (Left) soft key to save selection. Default = Medium.

- b. Press **2** to select Ring Tone:



Two options for ring tone: Line (ring tone for incoming call) and Intercom (ringer for intercom call). Set each option respectively.

Use the  or  to scroll through 8 ringers, press **SELECT** (Left) soft key to save selection. Default = 1.

- c. Press **3** to select Key Volume when a key is pressed:







Use  or  to scroll through 4 options: "Off," "Low," "Medium," and "High." Press **SELECT** (Left) soft key to save selection. Default = Medium.

- d. Press **4** to select Key Tone:

Use the  or  to scroll through 4 options: 1, 2, 3 and 4. Press **SELECT** (Left) soft key to save selection. Default = 1.

5. Press **4** to set Call Settings:

- a. Press **1** to set Dial Prefix:

- (1) Press  or  to turn on or off the dial prefix feature. Default = Off.
 - (2) If "On" is selected, the handset is prompted to enter the prefix number, up to 14-digits can be entered.
 - (3) Use **Delete** (Left) soft key to edit prefix number.
 - (4) Press **SAVE** (Left) soft key to confirm the selection.
 - (5) When this feature is turned on, the LCD will prompt the user "Dial Prefix? Yes or No" on each outgoing phone call from call logs, phone book, and dial-and-send dialing, the current prefix is also displayed. Re: the prefix number will be added automatically in front of the dialed number if press **YES** (Left) soft key.
 - (6) This feature is useful for access code, calling card, and credit card calls, etc.
- b. Press **2** to Group Select: see Handset Group Subscription on page [37](#).
 - c. Press **3** to set Call Manager: see Call Manager operation on Page [46](#).
 - d. Press **4** to set Feature Call: see Feature Call operation on Page [43](#).
6. Press **5** to set Phone Settings:
- a. Press **1** to set Mic Gain: See Mic Gain operation on Page [49](#).
 - b. Press **2** to set Any Key TALK:
Use **CHANGE** (Left) soft key to select and confirm "On" or "Off."
Default is "Off."
Re: When set "on," press any key (except  and **SILENT** key) to answer the incoming call.
 - c. Press **3** to set LCD Contrast:
 - (1) Use  or  to scroll through option 1~8. Default is 4.
 - (2) Press **SAVE** (Left) soft key to confirm selection.
 - d. Press **4** to set LCD Backlight:
 - (1) Use  or  to scroll through option 1~3 (1. 8-seconds 2. On 3. Off). Default is "8-seconds."
 - (2) Press **SAVE** (Left) soft key to confirm selection.
 - e. Press **5** to set Name Tag:
 - (1) Use **CHANGE** (Left) soft key to select and confirm "On" or "Off." Default is "Off."

(2) Press **SAVE** (Left) soft key to confirm selection.

Re: When Set "On," the handset match the Caller ID with the phone book entries, once matched, the LCD screen will display the name or nickname instead of pure Caller ID info (needs Caller ID service from local telephone company).

f. Press **6** to set Language:

(1) Use **▲** or **▼** to scroll through option 1~3 (1. English, 2. Spanish, 3. French). Default is "English."

(2) Press **SAVE** (Left) soft key to confirm selection.

g. Press **7** to set Custom Name:

(1) Enter characters using the Character Table and method discussed in the Phone book section.

(2) Use **▲** or **▼** to move the cursor backward or forward to insert (to the left of the cursor) or delete (the character above the cursor, or left of the cursor if cursor is on the right of the last character).

(3) Press **SAVE** (Left) soft key to confirm setting.

Re: Once entering the custom name, the greeting of the LCD in standby mode will be changed as entered.

Default greeting is "DuraFon-SIP"

h. Press **8** to Change Password:

(1) Enter original (4-digits) of handset then press **OK** (Left) soft key when entering this menu.

(2) Enter new password (4-digits) then press **SAVE** (Left) soft key to confirm new password.

i. Press **9** to set Headset Ring: See Headset Ring operation on Page 50.

7. Press **6** to set Base Settings:

When entering this menu, you must enter Base PIN code first (4-digits).

Re: The PIN code is for Base Settings. Default is "0000."

a. Press **1** to set Assign Next HS:

(1) Enter 2-digit handset ID then press **OK** (Left) soft key.

(2) When registering a new handset, the base will assign the specific handset ID, which is assigned in advance to the new handset.

b. Press **2** to set Clear HS:

- (1) Enter 2-digit handset ID, then press **OK** (Left) soft key.
 - (2) The base will erase the handset ID from the system.
- c. Press **3** to Change PIN:
 - (1) Enter the new Base PIN followed by **OK** (Left) soft key.
Re: Default Base PIN is "0000."

8. Press **7** to register, de-register handset : see Handset Registration operation on Page 36.

9. Press **8** to set Menu Display:

To avoid mis-setup of Call Settings (MENU-4), Phone Settings (MENU-5) and Base Settings (MENU-6), you can hide these menus, so that other handset users won't have chance to mis-setup these settings.

Re: When entering the Menu Display, you have to enter password first.

 - a. Press **1** to set hiding/un-hiding of the Call Settings menu.
 - (1) Use **CHANGE** (Left) soft key to select and confirm On or Off.
 - b. Press **2** to set hiding/un-hiding of the Phone Settings menu.
 - (1) Use **CHANGE** (Left) soft key to select and confirm On or Off.
 - c. Press **3** to set hiding/un-hiding of the Base Settings menu.
 - (1) Use **CHANGE** (Left) soft key to select and confirm On or Off.

Re: Selecting "On" means the menu will be displayed on screen. Selecting "Off" means the menu will be hidden.

Technical Specifications

Electrical Specifications	Base Station	Portable Handset
Frequency	902-928 MHz	902-928 MHz
RF Power	Peak: 708 mW Average: 354 mW	Peak: 708 mW Average: 88.5 mW
Channel Spacing	200 kHz	200 kHz
Number of Channels	128	128
Modulation	MSK	MSK
Multiple Access	Frequency Hopping TDMA	Frequency Hopping TDMA
Frequency Hopping Rate	100 per second	100 per second
TDMA Frame Length	10 ms	10 ms
Number of Slots/Frame	8	8
Number of Users/Carrier	4	4
Receiver Sensitivity	< -108 dBm (@ BER 10 ⁻²)	< -108 dBm (@ BER 10 ⁻²)
Antenna Connector	Reverse TNC	Non-standard
Antenna Gain	2 dBi 5 dBi External (optional)	2 dBi (Long) 0.5 dBi (Short)
Telephone Interface	RJ11 x 1	NA
VoIP interface	RJ45 x 1	NA
SIP protocol	RFC 3261	NA
Speech Coding	64Kbps G.711alaw, G.711 ulaw	8 kbps G.729A
Channel Coding	8 kbps Convolutional + CRC	8 kbps Convolutional + CRC
Transmission Data Rate	170.667 kbps	170.667 kbps
User Data Rate	128 kbps duplex	128 kbps duplex
Duplex	Time Division Duplex (TDD)	Time Division Duplex (TDD)
Voice Quality	TIA/EIA-470B	TIA/EIA-470B
No. of System ID	65,536	65,536
Ring Signal	20-50 Hz, 15-90 Vrms	NA
Flash Time	100-900 ms programmable	NA
Power Source	100~240V/12V AC/DC Adapter	3.7V, 1700 mAh Li-Ion Battery
Charger Current	NA	500 mA
Charge Time	NA	4 hours (from empty)
Regulation Compliance	FCC Part 15, Part 68	FCC Part 15, Part 68
Operating Temperature	0 – 50 °C	-10 – 60 °C

Storage Temperature	-10 – 70 °C	-10 – 70 °C
Humidity	20 – 75 %	20 – 75 %
Dimension without antenna	161W x 42D x 188H (mm) 6.3" x 16.5" x 7.4"	141 x 58 x 31 mm
Weight	14.1 ounces	6.17 ounces

Base Station

Federal Communication Commission Interference Statement

This equipment has been tested and found to comply with the limits for a Class B digital device, pursuant to Part 15 of the FCC Rules. These limits are designed to provide reasonable protection against harmful interference in a residential installation. This equipment generates uses and can radiate radio frequency energy and, if not installed and used in accordance with the instructions, may cause harmful interference to radio communications. However, there is no guarantee that interference will not occur in a particular installation. If this equipment does cause harmful interference to radio or television reception, which can be determined by turning the equipment off and on, the user is encouraged to try to correct the interference by one of the following measures:

- Reorient or relocate the receiving antenna.
- Increase the separation between the equipment and receiver.
- Connect the equipment into an outlet on a circuit different from that to which the receiver is connected.
- Consult the dealer or an experienced radio/TV technician for help.

FCC Caution: Any changes or modifications not expressly approved by the party responsible for compliance could void the user's authority to operate this equipment.

This device complies with Part 15 of the FCC Rules. Operation is subject to the following two conditions: (1) This device may not cause harmful interference, and (2) this device must accept any interference received, including interference that may cause undesired operation.

IMPORTANT NOTE:

FCC Radiation Exposure Statement:

This equipment complies with FCC radiation exposure limits set forth for an uncontrolled environment. This equipment should be installed and operated with minimum distance 20cm between the radiator & your body.

This transmitter must not be co-located or operating in conjunction with any other antenna or transmitter.

15.214 (d) Cordless telephones shall incorporate circuitry which makes use of a digital security code to provide protection against unintentional access to the public switched telephone network by the base unit and unintentional ringing by the handset. These functions shall operate such that each access of the telephone network or ringing of the handset is preceded by the transmission of a code word.

Access to the telephone network shall occur only if the code transmitted by the handset matches the code set in the base unit. Similarly, ringing of the handset shall occur only if the code transmitted by the base unit matches the code set in the handset. The security code required by this Section may also be employed to perform other communications functions, such as providing telephone billing information. This security code system is to operate in accordance with the following provisions.

(1) There must be provision for at least 256 possible discrete digital codes. Factory-set codes must be continuously varied over at least 256 possible codes as each telephone is manufactured. The codes may be varied either randomly, sequentially, or using another systematic procedure.

(2) Manufacturers must use one of the following approaches for facilitating variation in the geographic distribution of individual security codes:

(i) Provide a means for the user to readily select from among at least 256 possible discrete digital codes. The cordless telephone shall be either in a non-operable mode after manufacture until the user selects a security code or the manufacturer must continuously vary the initial security code as each telephone is produced.

(ii) Provide a fixed code that is continuously varied among at least 256 discrete digital codes as each telephone is manufactured.

(iii) Provide a means for the cordless telephone to automatically select a different code from among at least 256 possible discrete digital codes each time it is activated.

(iv) It is permissible to provide combinations of fixed, automatic, and user-selectable coding provided the above criteria are met.

(3) A statement of the means and procedures used to achieve the required protection shall be provided in any application for equipment authorization of a cordless telephone.

Industry Canada Statement:

This device complies with RSS-210 of the Industry Canada Rules. Operation is subject to the following two conditions:

(1) This device may not cause harmful interference, and (2) this device must accept any interference received, including interference that may cause undesired operation.

Ce dispositif est conforme à la norme CNR-210 d'Industrie Canada applicable aux appareils radio exempts de licence. Son fonctionnement est sujet aux deux conditions suivantes: (1) le dispositif ne doit pas produire de brouillage préjudiciable, et (2) ce dispositif doit accepter tout brouillage reçu, y compris un brouillage susceptible de provoquer un fonctionnement indésirable.

IMPORTANT NOTE:

Radiation Exposure Statement:

This equipment complies with IC radiation exposure limits set forth for an uncontrolled environment. This equipment should be installed and operated with minimum distance 20cm between the radiator & your body.

This device has been designed to operate with an antenna having a maximum gain of 2dBi. Antenna having a higher gain is strictly prohibited per regulations of Industry Canada. The required antenna impedance is 50 ohms.

Déclaration d'exposition aux radiations:

Cet équipement est conforme aux limites d'exposition aux rayonnements IC établies pour un environnement non contrôlé. Cet équipement doit être installé et utilisé avec un minimum de 20cm de distance entre la source de rayonnement et votre corps.

Ce dispositif a été conçu pour fonctionner avec une antenne ayant un gain maximal de dB 2. Une antenne à gain plus élevé est strictement interdite par les règlements d'Industrie Canada. L'impédance d'antenne requise est de 50 ohms.

Telecom

This equipment complies with Part 68 of the FCC rules and the requirements adopted by the ACTA. On the EUT of this equipment is a label that contains, among other information, a product identifier in the format US: SNIW401BSP935. If requested, this number must be provided to the telephone company.

The REN is used to determine the number of devices that may be connected to a telephone line. Excessive RENs on a telephone line may result in the devices not ringing in response to an incoming call. In most but not all areas, the sum of RENs should not exceed five (5.0). To be certain of the number of devices that may be connected to a line, as determined by the total RENs, contact the local telephone company. For products approved after July 23, 2001, the REN for this product is part of the product identifier that has the format US: SNIW401BSP935. The digits represented by 01 are the REN without a decimal point (e.g., 03 is a REN of 0.3). For earlier products, the REN is separately shown on the label.

If your equipment causes harm to the telephone network, the telephone company may discontinue your service temporarily. If possible, they will notify you in advance. But if advance notice is not practical, you will be notified as soon as possible. You will be informed of your right to file a complaint with the FCC. Your telephone company may make changes in its facilities, equipment, operations or procedures that could affect the proper functioning of your equipment. If they do, you will be notified in advance to give you an opportunity to maintain uninterrupted telephone service.

If you experience trouble with this telephone equipment, please contact the following address and phone number for information on obtaining service or repairs.

The telephone company may ask that you disconnect this equipment from the network until the problem has been corrected or until you are sure that the equipment is not malfunctioning.

This equipment may not be used on coin service provided by the telephone company. Connection to party lines is subject to state tariffs.

Company: EnGenius Technologies

Address: 1580 Scenic Avenue, Costa Mesa, CA 92626

Tel no.: 888.735.7888 ext. 827

A plug and jack used to connect this equipment to the premises wiring and telephone network must comply with the applicable FCC Part 68 rules and requirements adopted by the ACTA. A compliant telephone cord and modular plug is provided with this product. It is designed to be connected to a compatible modular jack that is also compliant. See installation instructions for details.

"NOTICE: This equipment meets the applicable Industry Canada Terminal Equipment Technical Specifications. This is confirmed by the registration number. The abbreviation, IC, before the registration number signifies that registration was performed based on a Declaration of Conformity indicating that Industry Canada technical specifications were met. It does not imply that Industry Canada approved the equipment."

"NOTICE: The Ringer Equivalence Number (REN) for this terminal equipment is 0.1. The REN assigned to each terminal equipment provides an indication of the maximum number of terminals allowed to be connected to a telephone interface. The termination on an interface may consist of any combination of devices subject only to the requirement that the sum of the Ringer Equivalence Numbers of all the devices does not exceed five."

« AVIS : Le présent matériel est conforme aux spécifications techniques d'Industrie Canada applicables au matériel terminal. Cette conformité est confirmée par le numéro d'enregistrement. Le sigle IC, placé devant le numéro d'enregistrement, signifie que l'enregistrement s'est effectué conformément à une déclaration de conformité et indique que les spécifications techniques d'Industrie Canada ont été respectées. Il n'implique pas qu'Industrie Canada a approuvé le matériel. »

« AVIS : L'indice d'équivalence de la sonnerie (IES) du présent matériel est de 0.1. L'IES assigné à chaque dispositif terminal indique le nombre maximal de terminaux qui peuvent être raccordés à une interface téléphonique. La terminaison d'une interface peut consister en une combinaison quelconque de dispositifs, à la seule

condition que la somme d'indices d'équivalence de la sonnerie de tous les dispositifs n'exède pas 5. »

Index

- 2-WAY INTERCOM, 14
- 2
- A
- Adjust Handset Microphone Gain, 49
- Adjust Headset, 50
- Adjusting Handset Receiver (Earpiece) Voice Volume, 33
- Adjusting Handset Speakerphone Voice Volume, 33
- Auto Hang Up, 19
- B
- Base Illustration, 21
- Base Operation**, 27
- Base PIN, 66, 67
- Base Station, 11, 13, 22, 25, 26, 30
- Battery Recharge and Replacement, 35
- Battery Strength, 13
- Broadcast, 30
- Broadcasting a group of handsets, 30
- Broadcasting all handsets, 30
- Broadcasting an individual handset, 31
- C
- Call Barring, 17, 19, 46, 48, 49
- Call Hold, 17
- Call Log, 16, 45
- Call Manager, 16, 46, 47, 48, 65
- Call Settings, 17, 18, 37, 47, 48, 64, 67
- Call Timer, 18
- Call Transfer, 38
- Call Waiting with Caller ID, 15, 66
- Caller ID, 15, 16, 32, 45, 46, 49
- Change PIN, 19, 67
- Charger Features, 24
- Charger Illustration, 23
- D
- De-registration, 36
- Direct transfer, 38
- DND, 16

Do Not Disturb (Silent Ring), 34

DTMF Duration, 19

E

Equipment Checklist, 11

F

Feature Call, 18, 43, 65

Flash, 14, 44

FCC, 8, 68

G

Group ID, 15, 30

Group Selections, 37

Group Setting, 18

H

Handset and Charger Installation, 26

Handset Charging Slot, 24

Handset Features, 13, 15, 21

Handset Group Subscription, 30, 37, 65

Handset ID, 13, 15, 31, 33, 36, 42

Handset Registration, 26, 36, 67

Handset to Handset Calls, 30

Headset Ring, 20, 50, 66

I

idle mode, 17

Incoming, 16, 46, 47

Indirect transfer, 38

IC, 8

interference, 8

K

Key Guard, 35, 64

Key Tone, 64

Key Volume, 64

M

Making a Telephone Call, 29

Making an 2-Way/ Intercom Call, 30

Menu Display, 18, 19, 67

MENU mode, 27

Multiple handsets registration, 15

Mute, 17, 34

N

Name tagging with caller ID, 15

O

Outdoor Antenna, 11

Outgoing, 16, 46, 47

P

Phone Settings, 18, 20, 49, 50, 65, 67

Phonebook, 17, 39, 45, 64, 66

Placing a Call On Hold, 34

Programmable Feature Call, 43

Programmable Flash, 19

R

Receiving a Telephone Call, 32

Receiving an Intercom Call, 32

Redial, 16, 31

REG, 27

registration mode, 22, 36, 37, 62

RESET Button, 22

Ring Volume, 64

Ringer, 13, 14, 15

RSSI, 13

Regulatory Information, 8

S

SILENT, 17, 32, 33, 34, 65

speakerphone, 14, 30, 31, 33

Speed dial, 29

T

Talk mode, 15

TALK/FLASH, 14

transformer, 25, 26

V

Vibrator, 15

View Call Log, 45

Visual Message Waiting Indicator, 49

W

warning message, 24