

OPTIONAL MASTER BATH - B

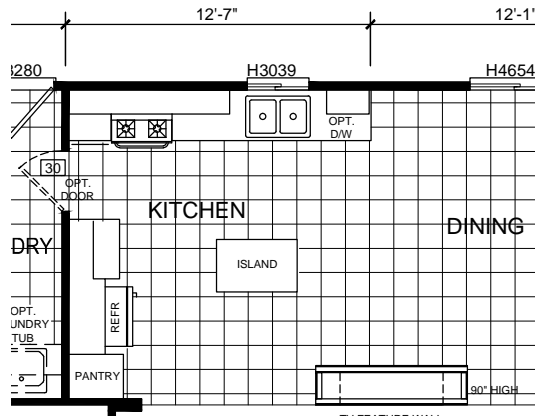

OPTIONAL KITCHEN - A

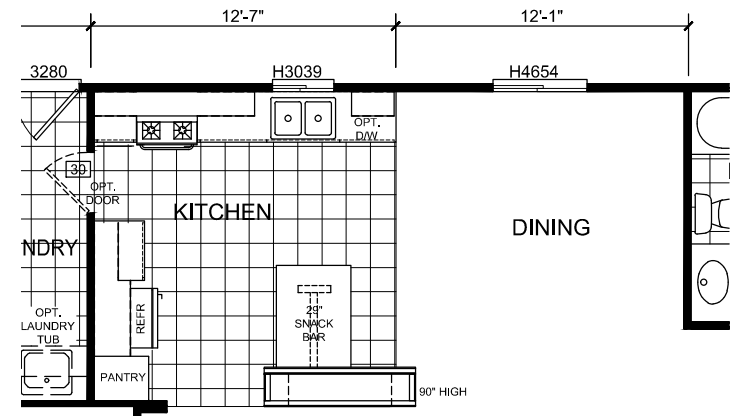

OPTIONAL KITCHEN - B

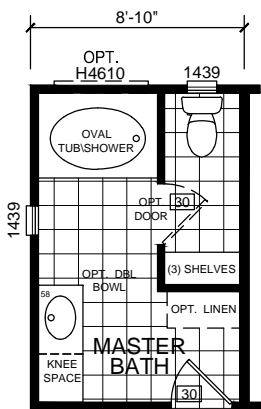

OPTIONAL MASTER BATH - A

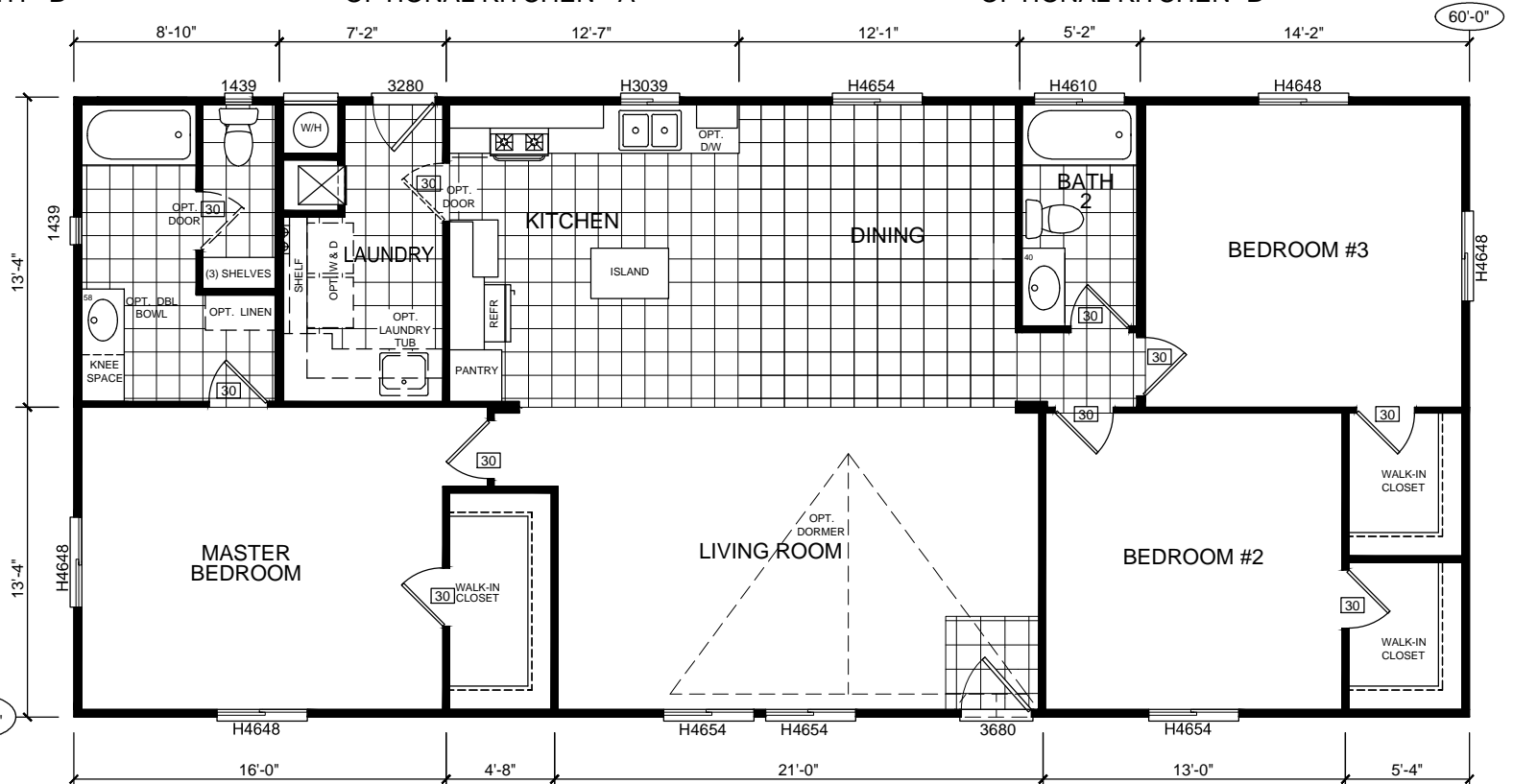

BD-09-6027 (1600 SQ. FT.) 60'-0" x 26'-8"

\*WINDOW SIZES SUBJECT TO CHANGE-8/3/15

**Silvercrest** CHAMPION  
 MANUFACTURED BEAUTIFULLY™  
 299 N. Smith Ave., Corona CA 92880

PROPRIETARY AND CONFIDENTIAL  
 THESE DRAWINGS AND SPECIFICATIONS ARE ORIGINAL.  
 PROPRIETARY AND CONFIDENTIAL MATERIALS OF  
 CHAMPION HOME BUILDERS INC.  
 COPYRIGHT © 1976-2015 BY CHAMPION

APPROVER'S SEAL
-----------------

MODIFICATIONS	
2-SEE REV LOG	BMS 3-02-11
3-SEE REV LOG	BMS 9-02-11
6-W/H TO GAS	BMS 6-15-12
10-SEE REV LOG	AMG 06-18-15

MODEL:	<b>BD-09-6027</b> 60/26-8-3BR	
TITLE:	<b>LITERATURE PLAN</b>	
DATE: 2-25-11	SCALE: 1/8" = 1'-0"	FILENAME:
DRAWN BY: BMS	CHECKED BY:	BD-09-6027-LT101

SHEET NO.:	<b>LT-101</b>
PAGE:	<b>1 OF 1</b>

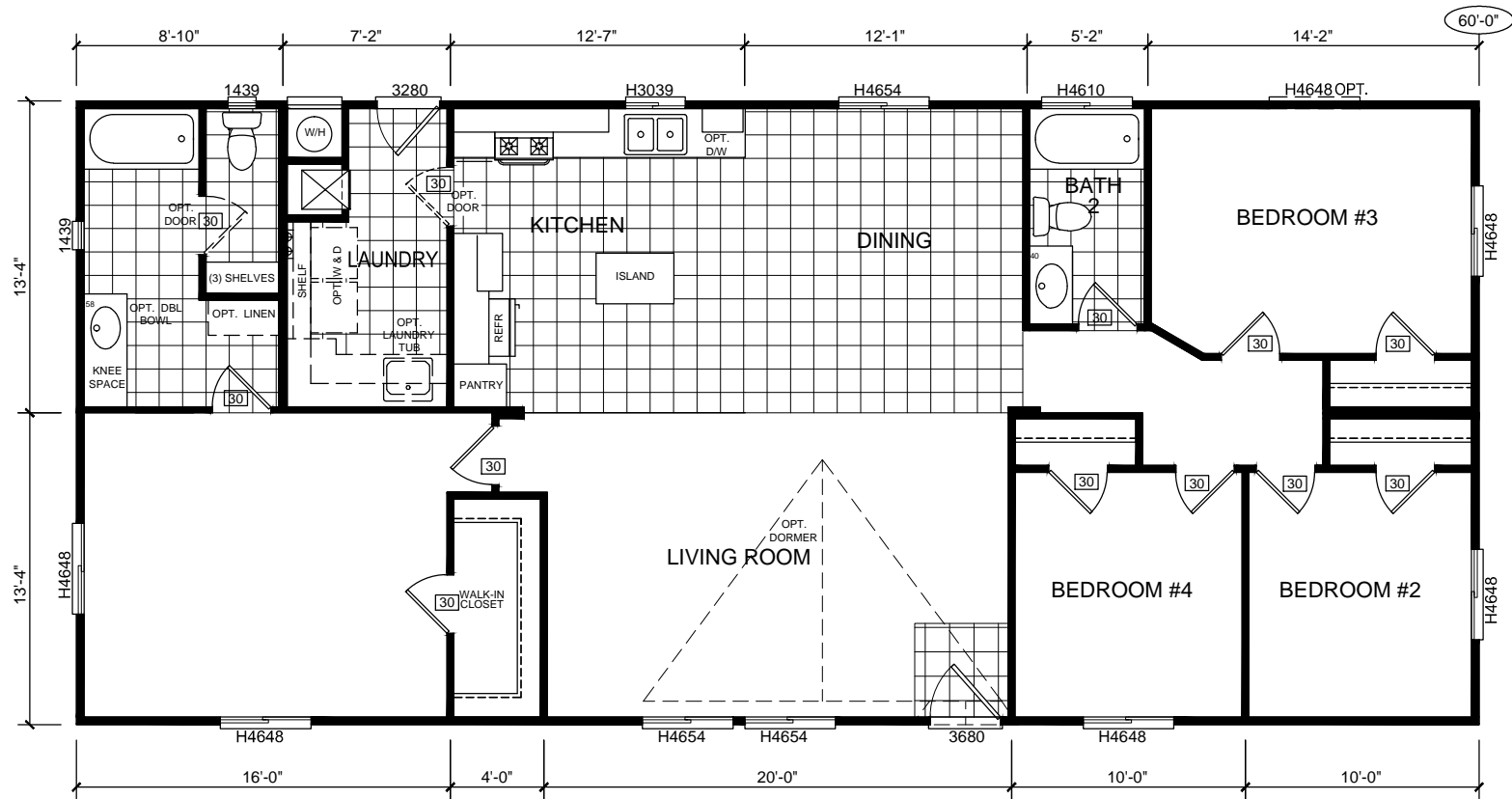

BD-09-6027 (1600 SQ. FT.) 60'-0" x 26'-8" (BEDROOM #4 OPT)



299 N. Smith Ave., Corona CA 92880

PROPRIETARY AND CONFIDENTIAL  
 THESE DRAWINGS AND SPECIFICATIONS ARE ORIGINAL,  
 PROPRIETARY AND CONFIDENTIAL MATERIALS OF  
 CHAMPION HOME BUILDERS INC.  
 COPYRIGHT © 1976-2015 BY CHAMPION

APPROVER'S SEAL

MODIFICATIONS

MODEL:

**BD-09-6027**

60/26-8-3BR

TITLE:

**LITERATURE PLAN**  
 OPTIONAL BEDROOM #4

SHEET NO.:

**LIT-102**

DATE: 6-24-14

SCALE: 1/8" = 1'-0"

FILENAME:

PAGE:

DRAWN BY: BMS

CHECKED BY:

BD-09-6027-LT101

1 OF 1

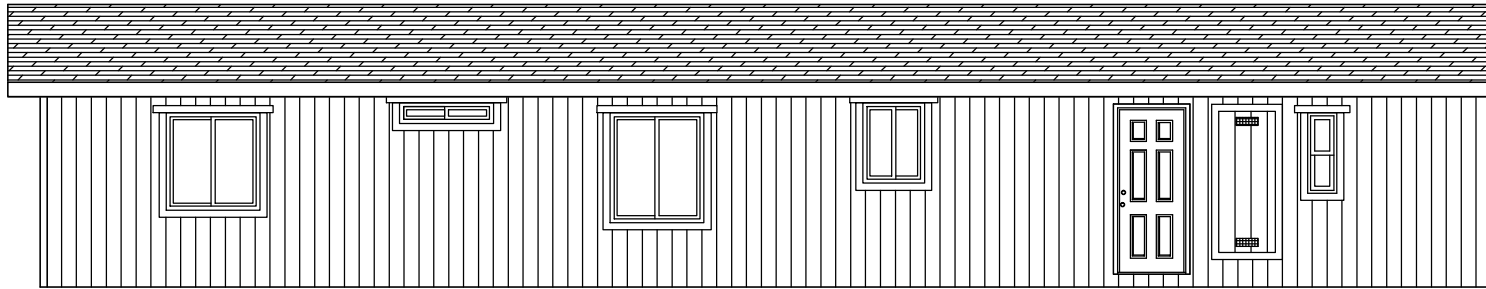

RIGHT

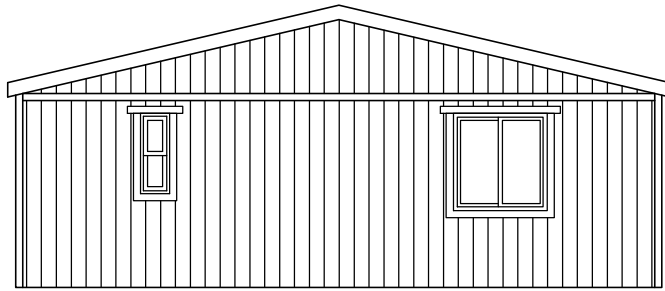

REAR

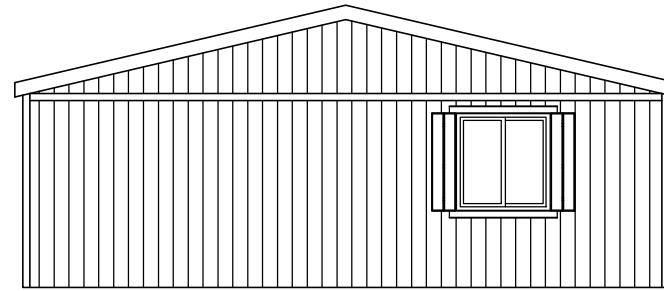

FRONT

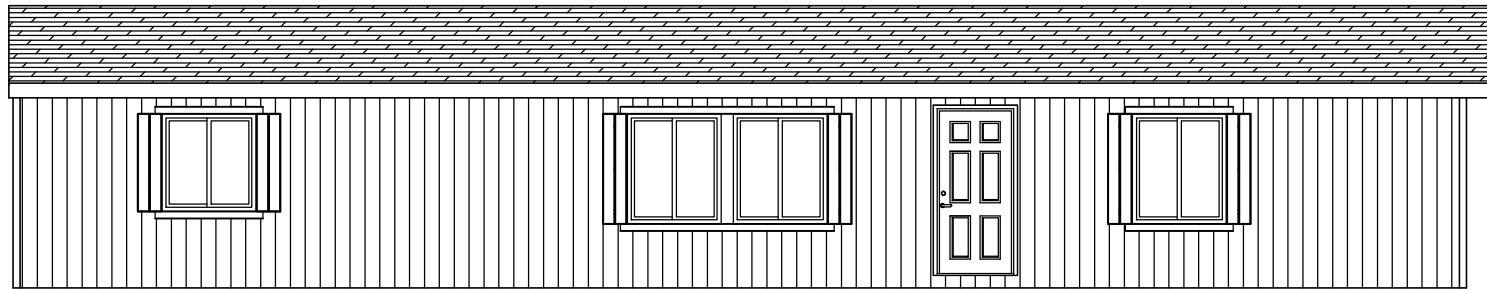

LEFT

**Silvercrest** CHAMPION  
 MANUFACTURED BEAUTIFULLY™  
 299 N. Smith Ave., Corona CA 92880

PROPRIETARY AND CONFIDENTIAL  
 THESE DRAWINGS AND SPECIFICATIONS ARE ORIGINAL,  
 PROPRIETARY AND CONFIDENTIAL MATERIALS OF  
 CHAMPION HOME BUILDERS INC.  
 COPYRIGHT © 1976-2015 BY CHAMPION

APPROVER'S SEAL

MODIFICATIONS

6-W/H TO GAS                      BMS 6-15-12  
 8-SEE REV LOG                    BMS 5-26-14

MODEL: **BD-09-6027**  
 60/26-8-3BR

TITLE: **ELEVATIONS**

DATE: 5-18-11                      SCALE: 1/8" = 1'-0"  
 DRAWN BY: BMS                    CHECKED BY:

FILENAME: BD-09-6027-LT101

SHEET NO.: **AE-101**

PAGE: **1 OF 1**

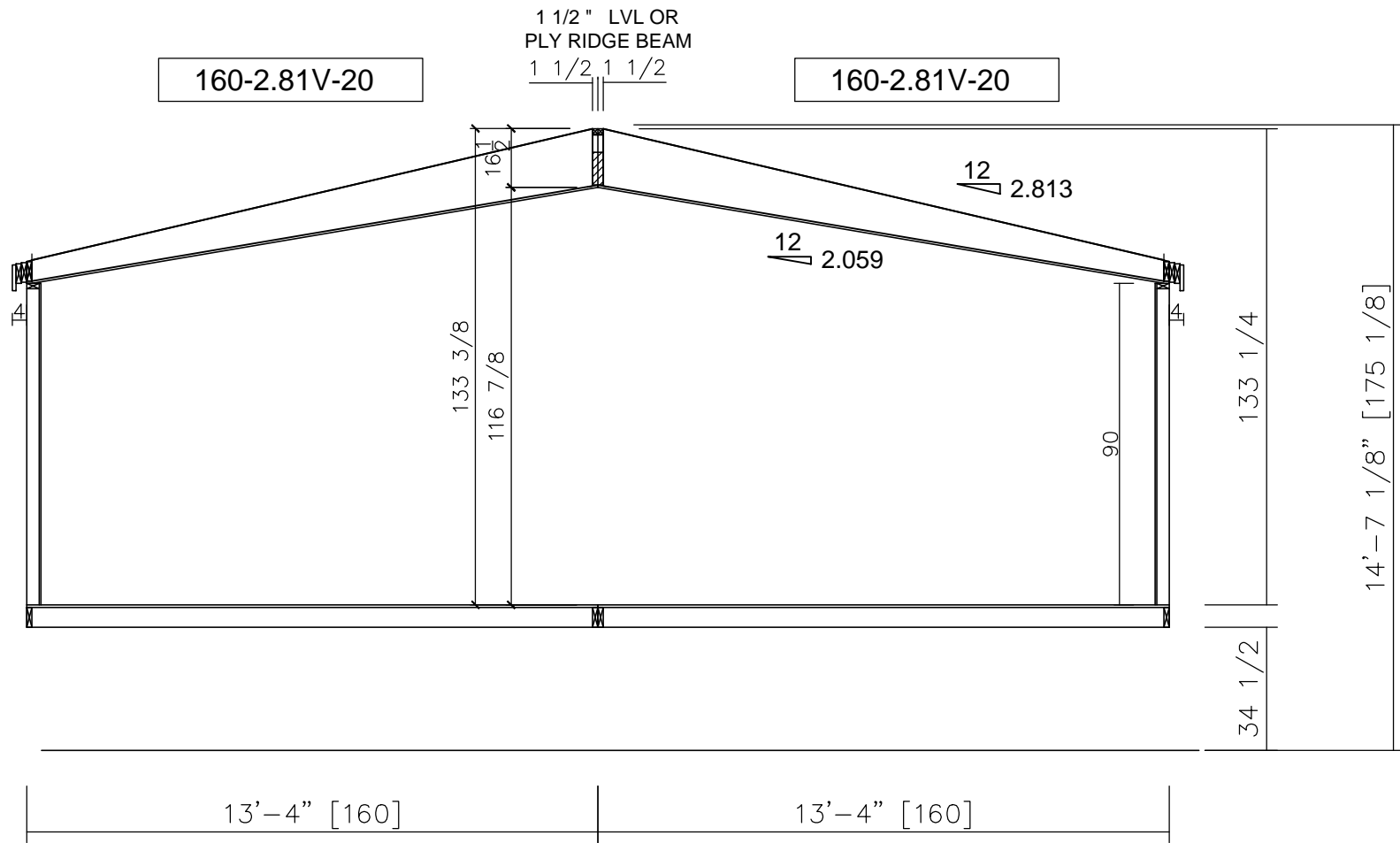

**Silvercrest** CHAMPION  
MANUFACTURED BEAUTIFULLY™

299 N. Smith Ave., Corona CA 92880

PROPRIETARY AND CONFIDENTIAL  
 THESE DRAWINGS AND SPECIFICATIONS ARE ORIGINAL,  
 PROPRIETARY AND CONFIDENTIAL MATERIALS OF  
 CHAMPION HOME BUILDERS INC.  
 COPYRIGHT © 1976-2015 BY CHAMPION

APPROVER'S SEAL

MODIFICATIONS

9-SEE REV LOG

DJM 9-26-14

MODEL:

**BD-09-6027**

60/26-8-3BR

TITLE:

**CROSS SECTION**

SHEET NO.:

**AS-101**

DATE: 2-25-11

SCALE: N.T.S.

FILENAME:

PAGE:

DRAWN BY: BMS

CHECKED BY:

BD-09-6027-LT101

1 OF 1