

OPTIONAL MASTER BATH-B

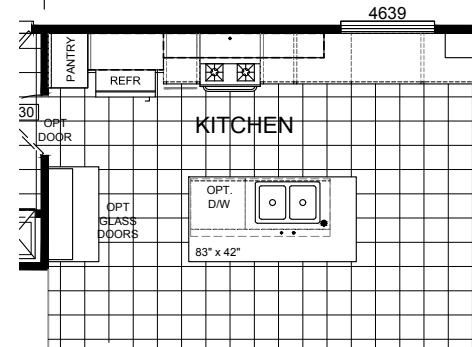

OPTIONAL LAUNDRY ROOM



OPTIONAL KITCHEN

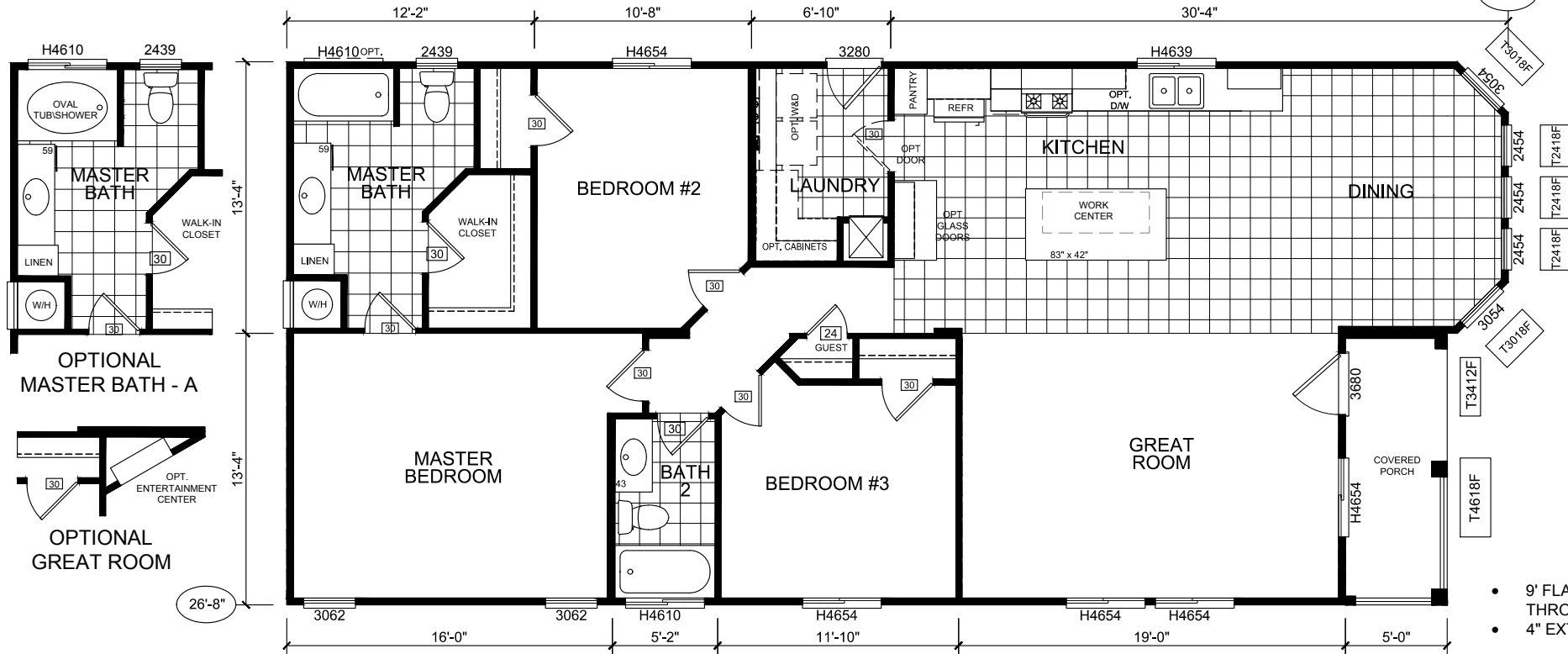

KB-62 1487 SQ. FT. (60'-0"/52'-0" x 26'-8") NO PORCH
 1554 SQ. FT. (60'-0"/57'-0" x 26'-8") WITH PORCH

- 9' FLAT CEILING THROUGHOUT
- 4" EXTERIOR WALL

Silvercrest CHAMPION
 MANUFACTURED BEAUTIFULLY™
 299 N. Smith Ave., Corona CA 92880

PROPRIETARY AND CONFIDENTIAL
 THESE DRAWINGS AND SPECIFICATIONS ARE ORIGINAL,
 PROPRIETARY AND CONFIDENTIAL MATERIALS OF
 CHAMPION HOME BUILDERS INC.
 COPYRIGHT © 1976-2017 BY CHAMPION

APPROVER'S SEAL

MODIFICATIONS

2-SEE REV LOG	BMS 5-22-13
3-SEE REV LOG	BMS 8-29-13
4-SEE REV LOG	BMS 11-11-13
5-SEE REV LOG	AMG 06-05-15

MODEL: **KB-62**
 60/57/26-8-3BR

TITLE: **LITERATURE PLAN**

DATE: 05-21-13 SCALE: 1/8" = 1'-0" FILENAME:
 DRAWN BY: BMS CHECKED BY: KB-62-LT101

SHEET NO.: **LT-101**

PAGE: **1 OF 1**

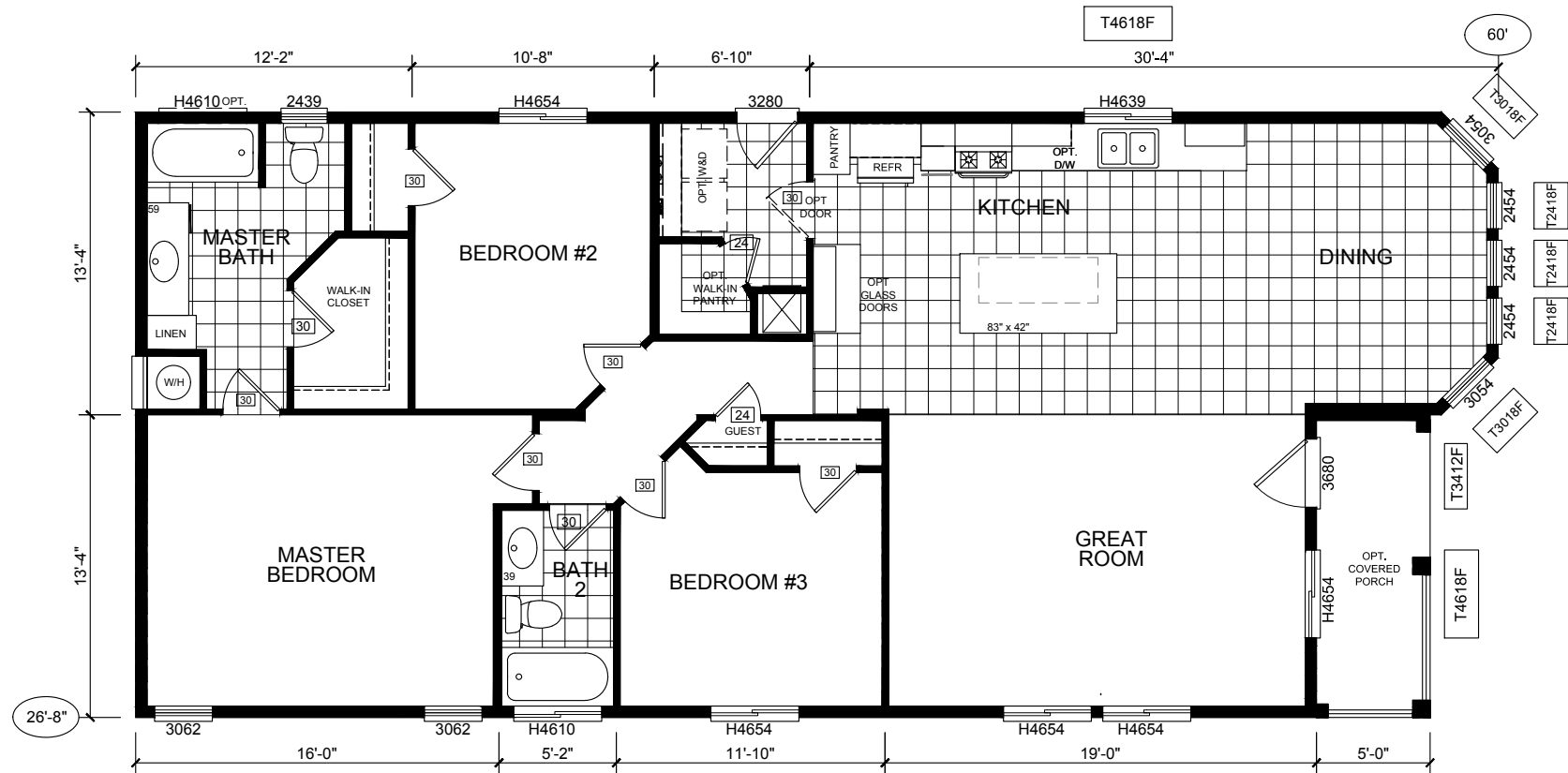

KB-62 (2X6 EXT WALLS) 1487 SQ. FT. (60'-0" / 52'-0" x 26'-8") NO PORCH
 1554 SQ. FT. (60'-0" / 57'-0" x 26'-8") WITH PORCH

- OPTIONAL 2X6 EXTERIOR WALLS REQUIRE FLOOR WIDTH TO REMAIN @ 13'-4"

Silvercrest CHAMPION
 MANUFACTURED BEAUTIFULLY™
 299 N. Smith Ave., Corona CA 92880

PROPRIETARY AND CONFIDENTIAL
 THESE DRAWINGS AND SPECIFICATIONS ARE ORIGINAL.
 PROPRIETARY AND CONFIDENTIAL MATERIALS OF
 CHAMPION HOME BUILDERS INC.
 COPYRIGHT © 1976-2017 BY CHAMPION

APPROVER'S SEAL

MODIFICATIONS

2-SEE REV LOG BMS 5-22-13
 3-SEE REV LOG BMS 8-29-13

MODEL: **KB-62**
 60/57/26-8-3BR

TITLE: **LITERATURE PLAN**
 2X6 EXTERIOR WALLS

DATE: 05-21-13 SCALE: 1/8" = 1'-0" FILENAME: KB-62-LT101

DRAWN BY: BMS CHECKED BY:

SHEET NO.: **LT-102**

PAGE: **1 OF 1**

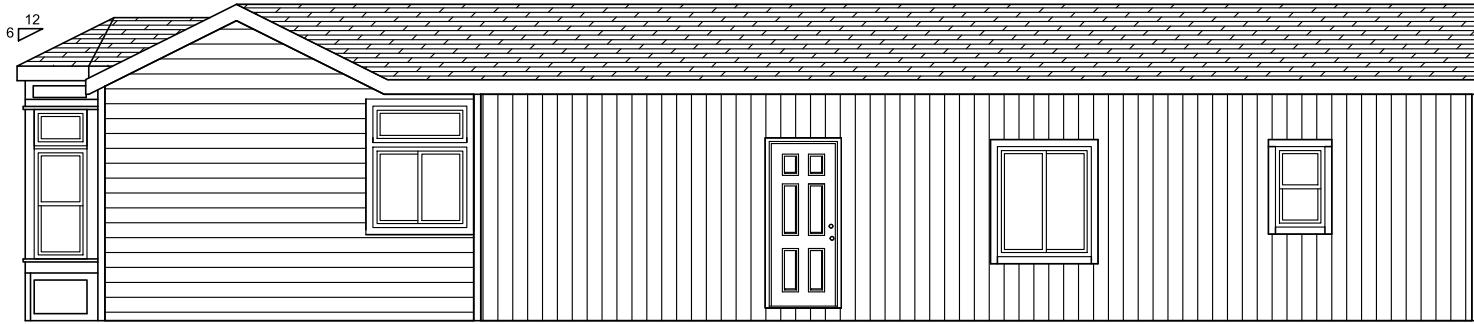

RIGHT

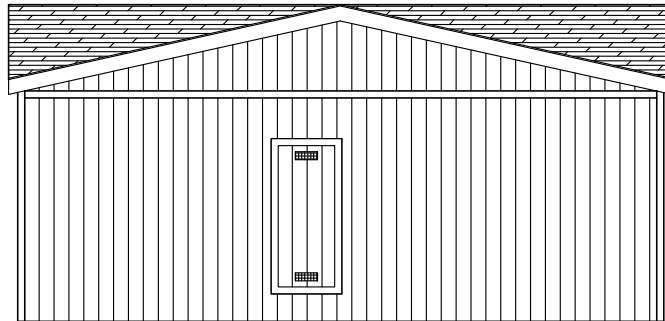

REAR



FRONT

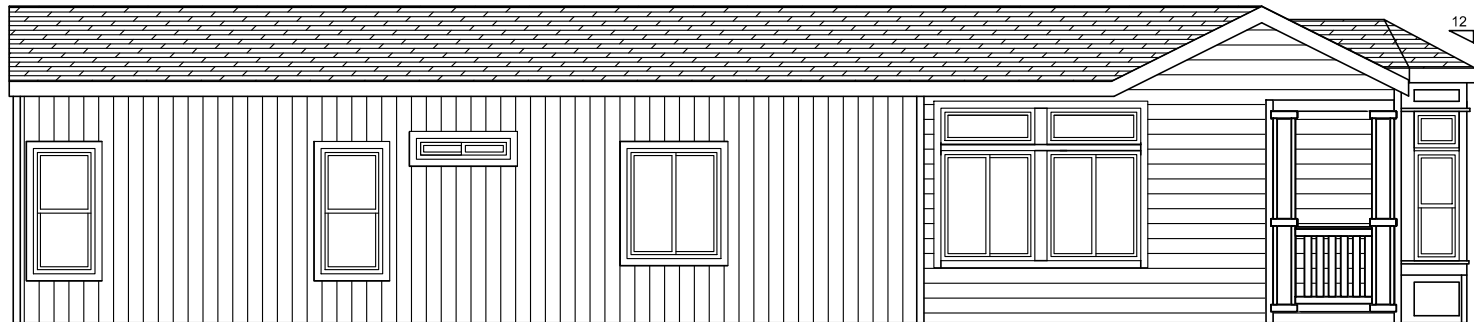

LEFT

Silvercrest CHAMPION
MANUFACTURED BEAUTIFULLY™

299 N. Smith Ave., Corona CA 92880

PROPRIETARY AND CONFIDENTIAL
THESE DRAWINGS AND SPECIFICATIONS ARE ORIGINAL.
PROPRIETARY AND CONFIDENTIAL MATERIALS OF
CHAMPION HOME BUILDERS INC.
COPYRIGHT © 1976-2017 BY CHAMPION

APPROVER'S SEAL

MODIFICATIONS

2-SEE REV LOG

BMS 5-22-13

MODEL:

KB-62

60/57/26-8-3BR

TITLE:

ELEVATION- STD

DATE: 05-21-13

SCALE: 1/8" = 1'-0"

FILENAME:

DRAWN BY: BMS

CHECKED BY:

KB-62-LT101

SHEET NO.:

AE-101

PAGE:

1 OF 1

160-2.66FC

160-2.66F

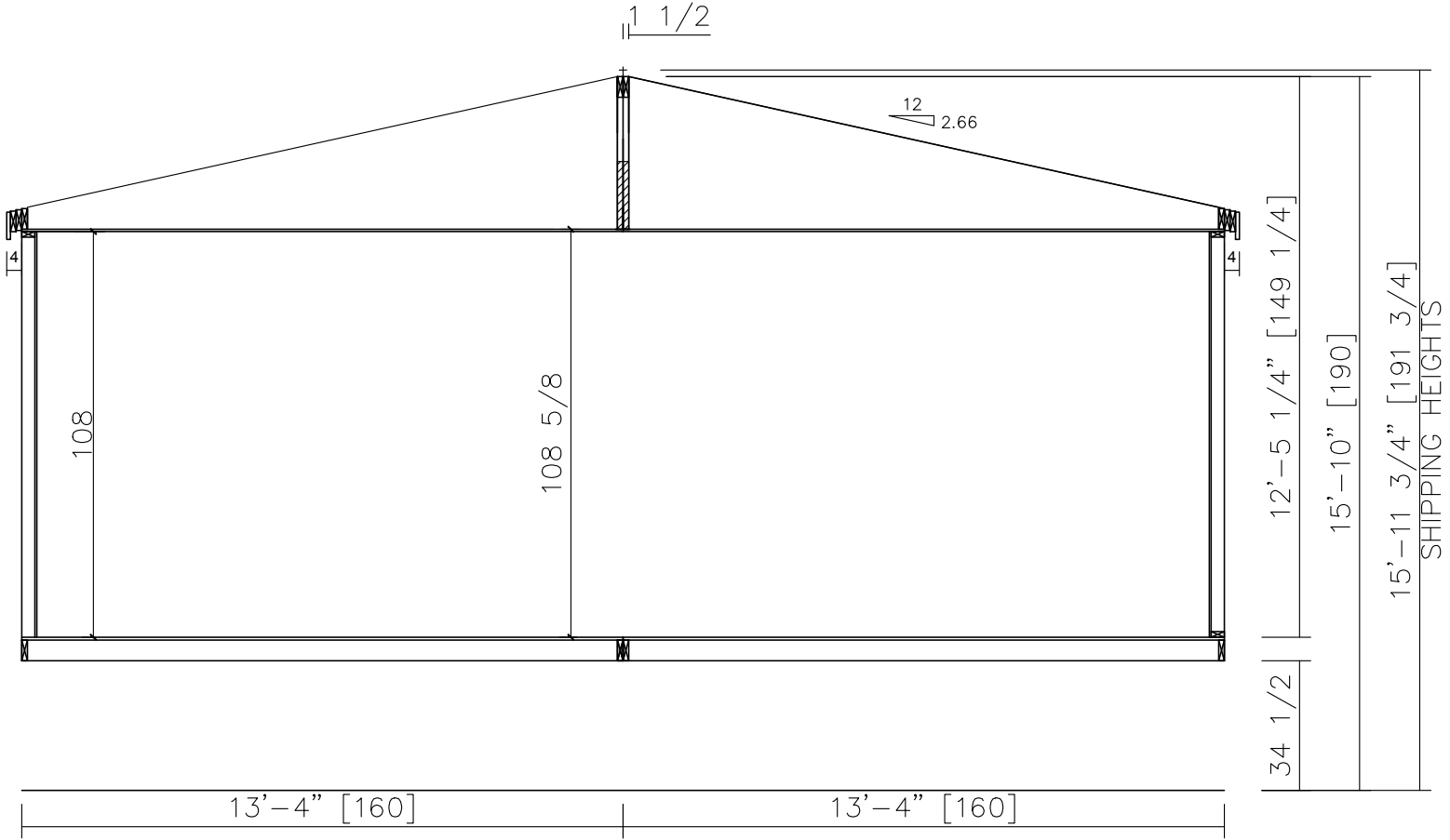

Silvercrest CHAMPION
 MANUFACTURED BEAUTIFULLY™
 299 N. Smith Ave., Corona CA 92880

APPROVER'S SEAL

MODIFICATIONS

MODEL: **KB-62**
 60/57/26-8-3BR
 TITLE: **CROSS SECTION**
 DATE: 05-21-13 SCALE: 1/8" = 1'-0" FILENAME: KB-62-LT101
 DRAWN BY: BMS CHECKED BY:

SHEET NO.: **AS-101**
 PAGE: **1 OF 1**

PROPRIETARY AND CONFIDENTIAL
 THESE DRAWINGS AND SPECIFICATIONS ARE ORIGINAL,
 PROPRIETARY AND CONFIDENTIAL MATERIALS OF
 CHAMPION HOME BUILDERS INC.
 COPYRIGHT © 1976-2017 BY CHAMPION

