

OPTIONAL DEN

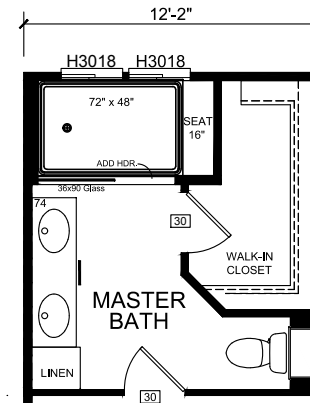

OPTIONAL WALK-IN PANTRY



OPTIONAL RAINFOREST SHOWER

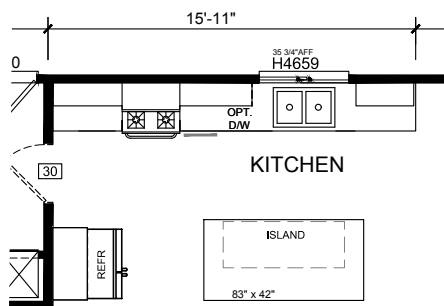

OPTIONAL KITCHEN CABINET LAYOUT

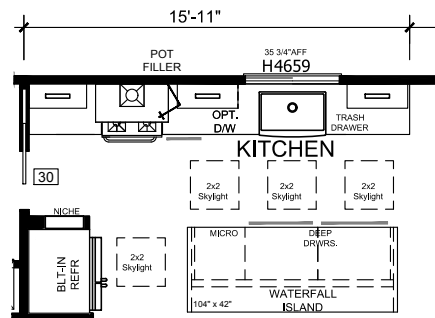

OPTIONAL DISPLAY MODEL KITCHEN



OPTIONAL ENT CENTER W/LINEAR F/P

Silvercrest CHAMPION
 MANUFACTURED BEAUTIFULLY™
 299 N. Smith Ave., Corona CA 92880

PROPRIETARY AND CONFIDENTIAL
 THESE DRAWINGS AND SPECIFICATIONS ARE ORIGINAL.
 PROPRIETARY AND CONFIDENTIAL MATERIALS OF
 CHAMPION HOME BUILDERS INC.
 COPYRIGHT © 1976-2017 BY CHAMPION

APPROVER'S SEAL

MODIFICATIONS
3-SEE REV LOG
SR 12-29-16

MODEL:	KB-66	
	61-4/26-8-3BR	
TITLE:	LITERATURE PLAN	
	OPTIONS	
DATE: 09-18-15	SCALE: 1/8" = 1'-0"	FILENAME:
DRAWN BY: srobertson	CHECKED BY:	KB-66-LT101

SHEET NO.:
LT-102
PAGE:
1 OF 1

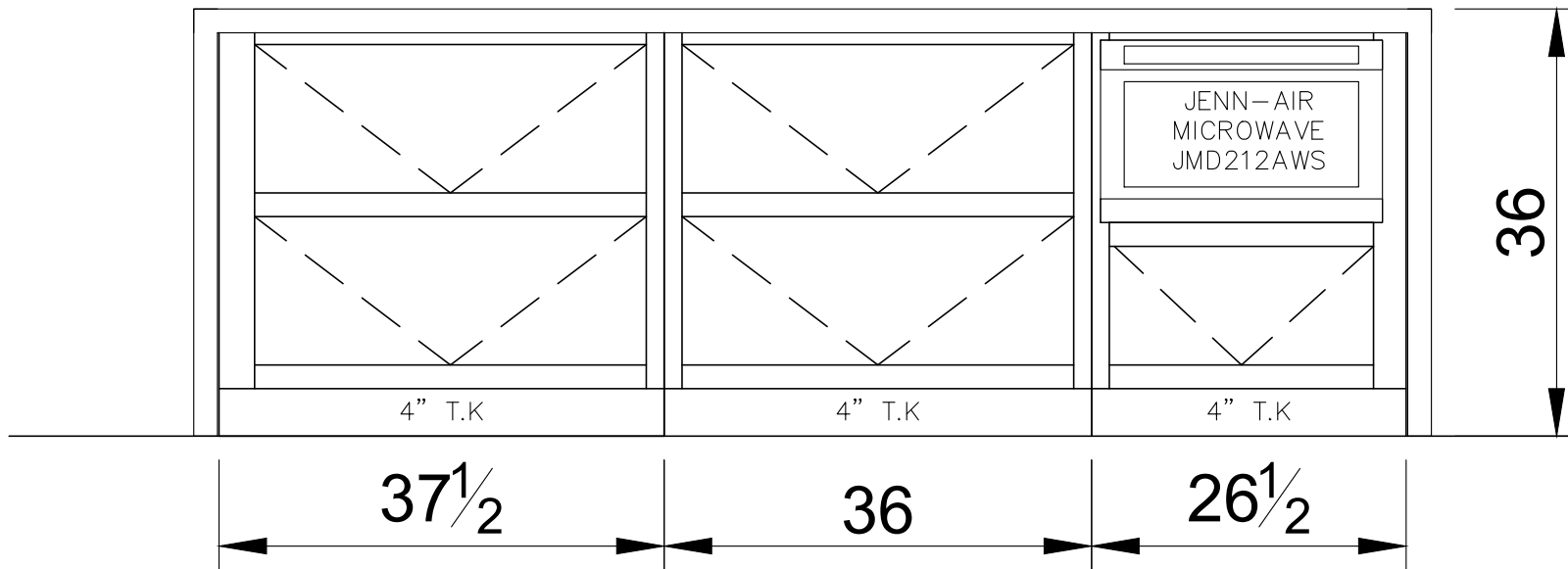

Silvercrest CHAMPION
 MANUFACTURED BEAUTIFULLY™
 299 N. Smith Ave., Corona CA 92880

PROPRIETARY AND CONFIDENTIAL
 THESE DRAWINGS AND SPECIFICATIONS ARE ORIGINAL.
 PROPRIETARY AND CONFIDENTIAL MATERIALS OF
 CHAMPION HOME BUILDERS INC.
 COPYRIGHT © 1976-2017 BY CHAMPION

APPROVER'S SEAL

MODIFICATIONS

MODEL: **KB-66**
 61-4/26-8-3BR

TITLE: **WATER FALL ISLAND**

DATE: 09-18-15 SCALE: 3/4" = 1'-0" FILENAME:
 DRAWN BY: srobertson CHECKED BY: KB-66-LT101

SHEET NO.:
AK-101

PAGE:
 1 OF 1

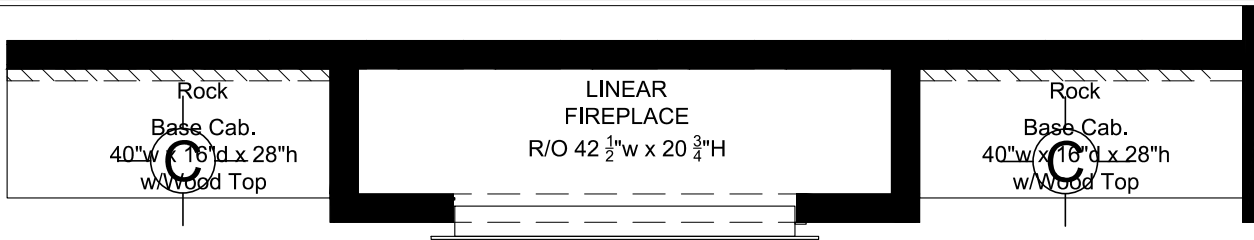

157

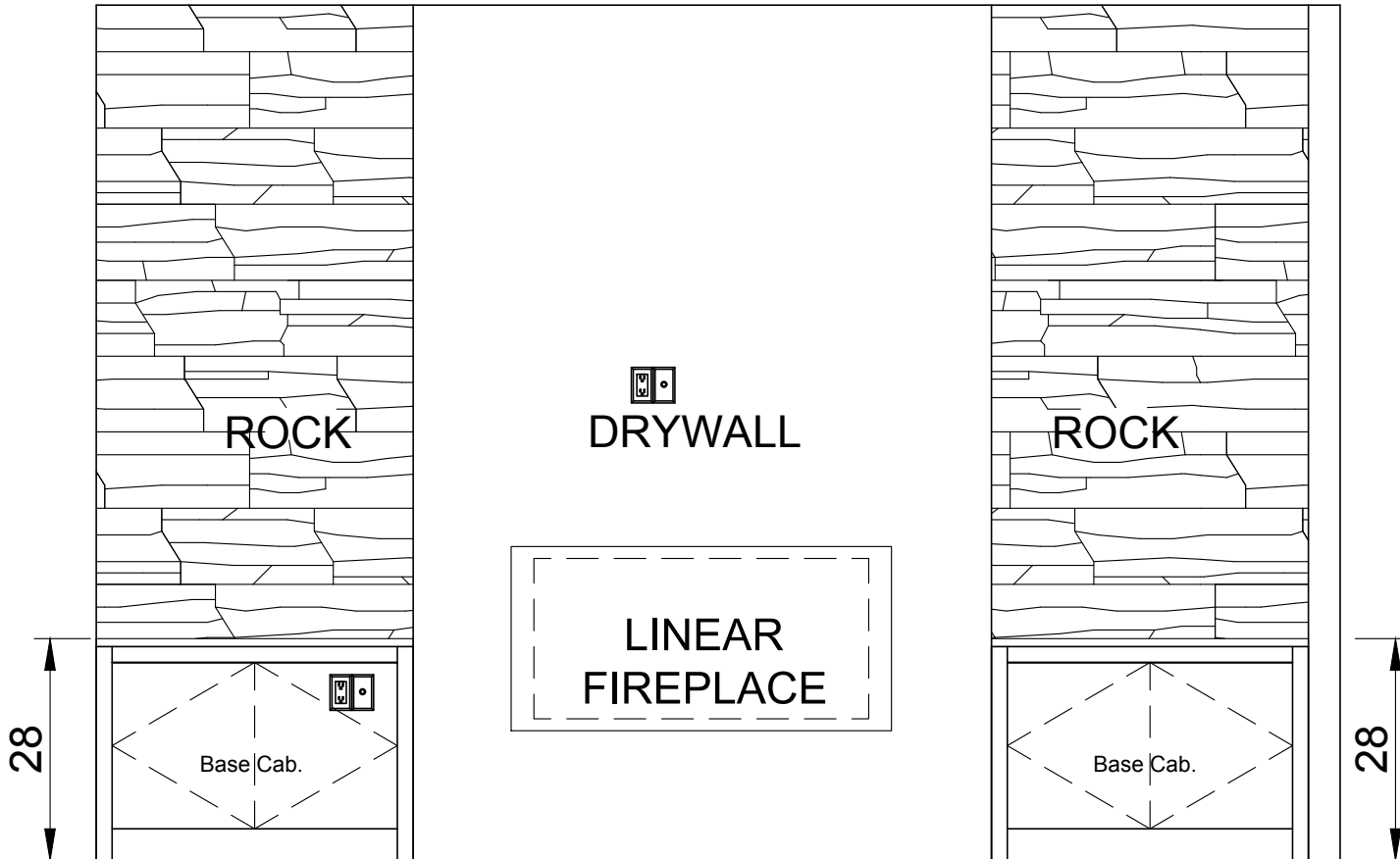

Silvercrest CHAMPION
 MANUFACTURED BEAUTIFULLY™
 299 N. Smith Ave., Corona CA 92880

PROPRIETARY AND CONFIDENTIAL
 THESE DRAWINGS AND SPECIFICATIONS ARE ORIGINAL.
 PROPRIETARY AND CONFIDENTIAL MATERIALS OF
 CHAMPION HOME BUILDERS INC.
 COPYRIGHT © 1976-2017 BY CHAMPION

APPROVER'S SEAL

MODIFICATIONS

MODEL: **KB-66**
 61-4/26-8-3BR

TITLE: **NEW ROCK/TV/BASE CAB**

DATE: 09-18-15 SCALE: 1/8" = 1'-0" FILENAME:
 DRAWN BY: srobertson CHECKED BY: KB-66-LT101

SHEET NO.: **LT-101**

PAGE: **1 OF 1**

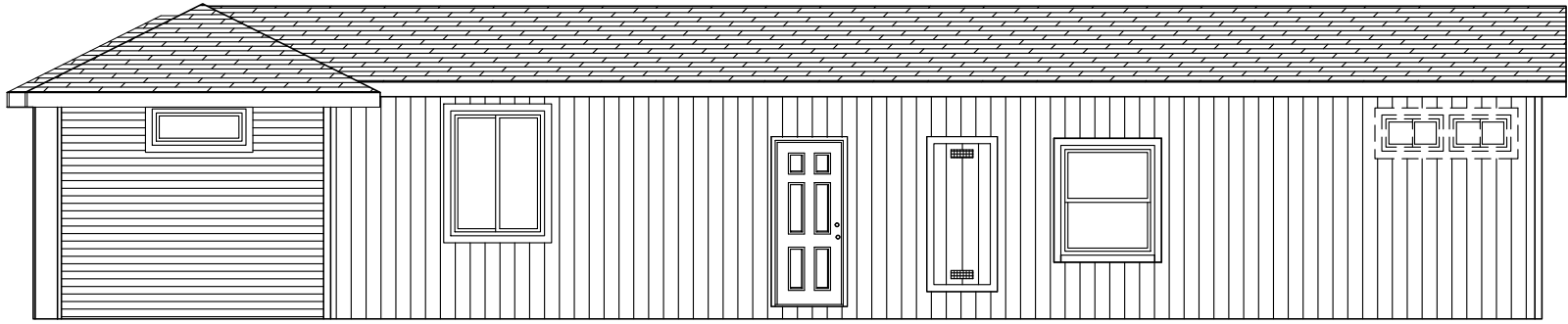

RIGHT

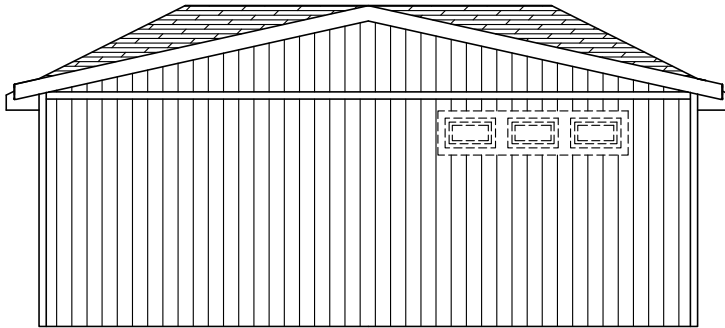

REAR



FRONT

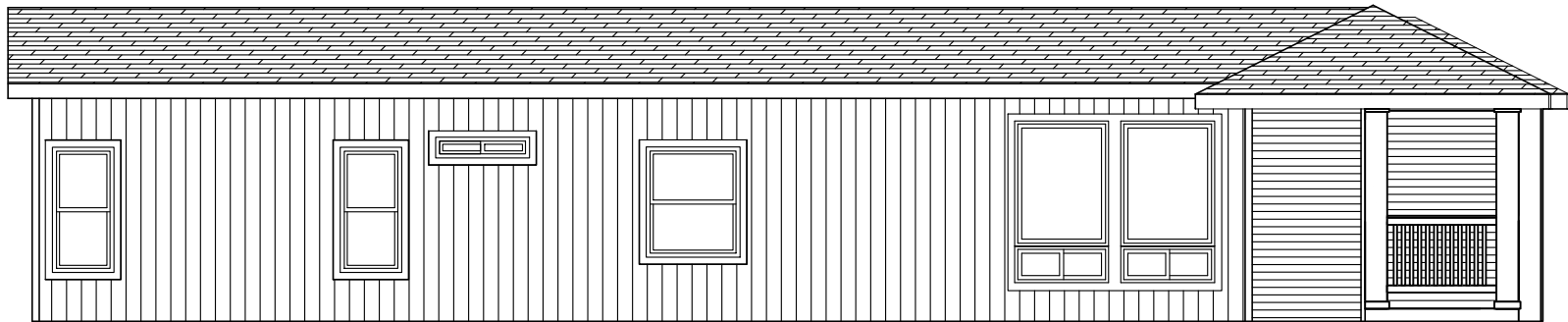

LEFT

Silvercrest CHAMPION
 MANUFACTURED BEAUTIFULLY™
 299 N. Smith Ave., Corona CA 92880

PROPRIETARY AND CONFIDENTIAL
 THESE DRAWINGS AND SPECIFICATIONS ARE ORIGINAL.
 PROPRIETARY AND CONFIDENTIAL MATERIALS OF
 CHAMPION HOME BUILDERS INC.
 COPYRIGHT © 1976-2017 BY CHAMPION

APPROVER'S SEAL

MODIFICATIONS
 4-SEE REV LOG
 AMG 1-23-17

MODEL: KB-66
 61-4/26-8-3BR

TITLE: ELEVATION- STD

DATE: 09-18-15 SCALE: 1/8" = 1'-0" FILENAME: KB-66-LT101

DRAWN BY: srobertson CHECKED BY:

SHEET NO.: AE-101

PAGE: 1 OF 1

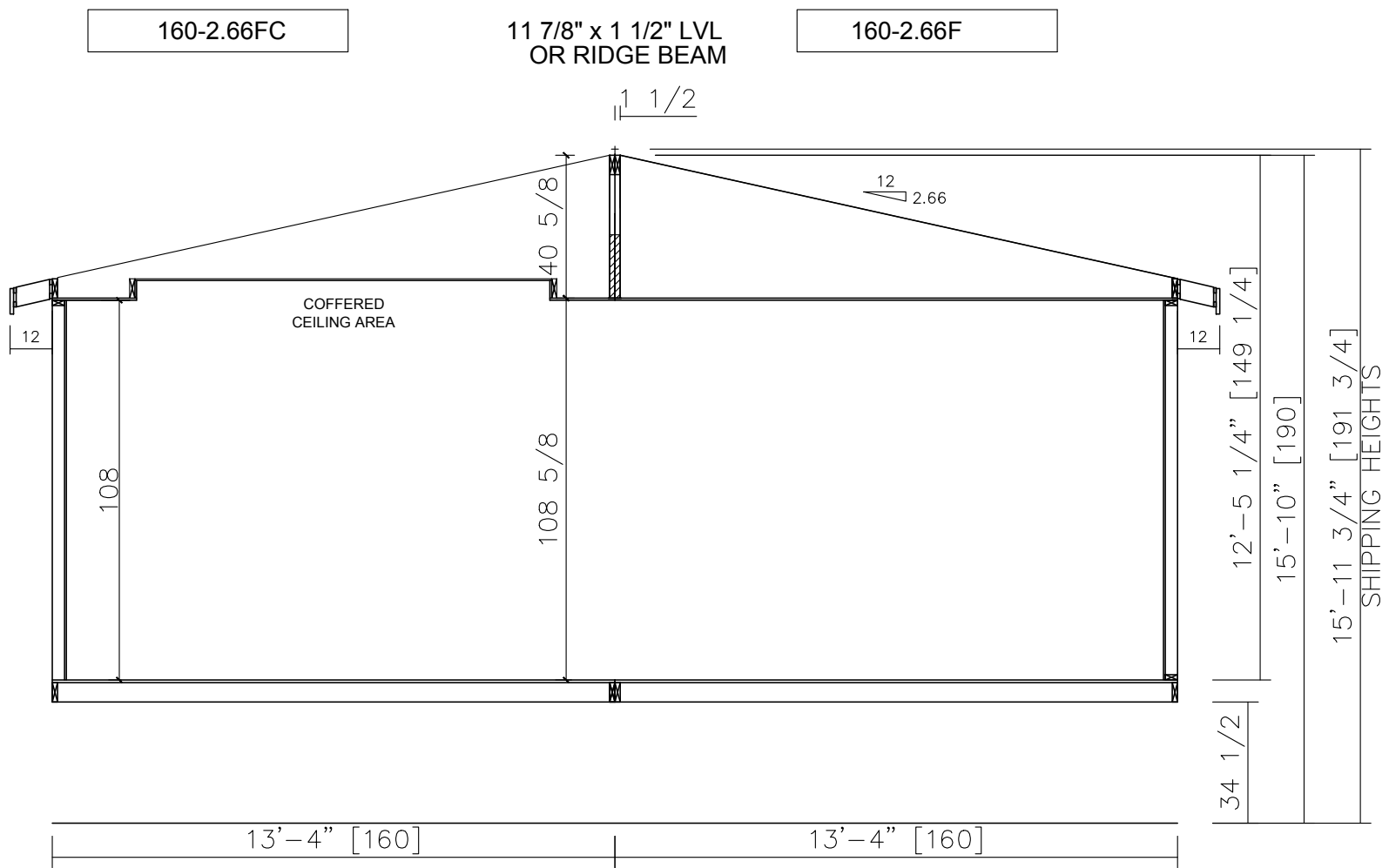

160-2.66FC

11 7/8" x 1 1/2" LVL
OR RIDGE BEAM

160-2.66F

Silvercrest CHAMPION
 MANUFACTURED BEAUTIFULLY™
 299 N. Smith Ave., Corona CA 92880

PROPRIETARY AND CONFIDENTIAL
 THESE DRAWINGS AND SPECIFICATIONS ARE ORIGINAL,
 PROPRIETARY AND CONFIDENTIAL MATERIALS OF
 CHAMPION HOME BUILDERS INC.
 COPYRIGHT © 1976-2017 BY CHAMPION

APPROVER'S SEAL

MODIFICATIONS

MODEL: **KB-66**
 61-4/26-8-3BR

TITLE: **CROSS SECTION**

DATE: 09-18-15 SCALE: 1/8" = 1'-0" FILENAME:
 DRAWN BY: srobertson CHECKED BY: KB-66-LT101

SHEET NO.: **AS-101**

PAGE: **1 OF 1**

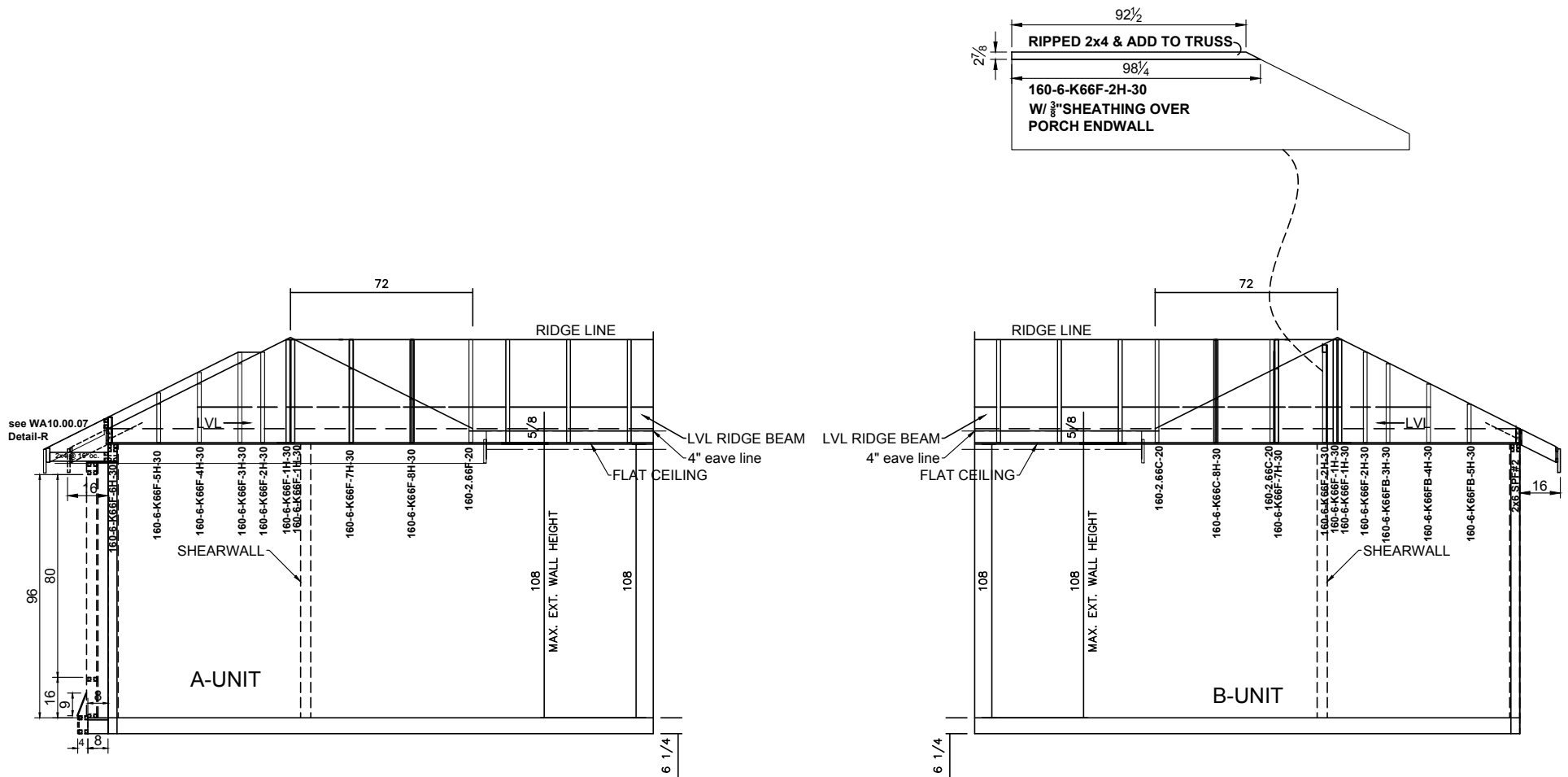

Silvercrest CHAMPION
MANUFACTURED BEAUTIFULLY™

299 N. Smith Ave., Corona CA 92880

PROPRIETARY AND CONFIDENTIAL
THESE DRAWINGS AND SPECIFICATIONS ARE ORIGINAL.
PROPRIETARY AND CONFIDENTIAL MATERIALS OF
CHAMPION HOME BUILDERS INC.
COPYRIGHT © 1976-2017 BY CHAMPION

APPROVER'S SEAL

MODIFICATIONS

MODEL:

KB-66

61-4/26-8-3BR

TITLE:

CROSS SECTION

SHEET NO.:

AS-102

DATE: 09-18-15

SCALE: 1/8" = 1'-0"

FILENAME:

PAGE:

DRAWN BY: srobertson

CHECKED BY:

KB-66-LT101

1 OF 1

