



# Cable Restraints in Wisconsin

**A Guide to Responsible Use**

# Cable Restraints in Wisconsin

## A Guide to Responsible Use

By John F. Olson and Rick Tischaefer

Sponsors include



Wisconsin Department of Natural Resources



Wisconsin Trappers Association

# Acknowledgments

This publication includes much of the information provided in a previous report entitled the *Assessment of Cable Restraints to Capture Coyotes and Foxes in Wisconsin*. We sincerely thank the numerous individuals and key organizations from Wisconsin and elsewhere who contributed and participated in those efforts. The Executive Council of the Wisconsin Conservation Congress has supported our efforts throughout the investigative and rule-making process. Numerous field and supervisory wardens and wildlife biologists of the Wisconsin Department of Natural Resources (WDNR) prepared, approved and worked with the Scientific Collectors Permit needed for this project. Our WDNR Wildlife Health team and the Stoughton Veterinary Service assisted us in pelt studies in 2001, and Dr. Elizabeth Williams, University of Wyoming, conducted all necropsies in 2002. The Missouri Department of Conservation completed all data analysis.

Most importantly, special thanks to the Wisconsin Trappers Association (WTA), its officers, board of directors, individual trappers and their families who sacrificed time and effort during the entire process. They spent long days on study trap lines and in the WDNR Fur

Shed. In addition, countless hours were spent by WTA members at meetings, conferences and fairs presenting study results, answering questions and explaining how responsible use of cable restraints will benefit citizens of Wisconsin.

We thank Natalene Cummings for the excellent illustrations throughout this publication. Her skills have allowed us to more easily depict the tools, components, and recommended uses of cable restraints. We also extend our appreciation to the many cooperating landowners who permitted this trap research to be conducted on their property. They have made a significant contribution to the future of furbearer management in Wisconsin. Bruce Kohn critically reviewed the first draft of this publication.

And finally, special appreciation is extended to those individuals who provided us with advice on study design, protocol, and methods including Tom Krause of Wyoming, Scott Huber of South Dakota, Rally Hess of Minnesota and Hal Sullivan of Ohio. All contributed significantly to our study and/or development of this guide and Wisconsin owes them a debt of gratitude.

## Authors:

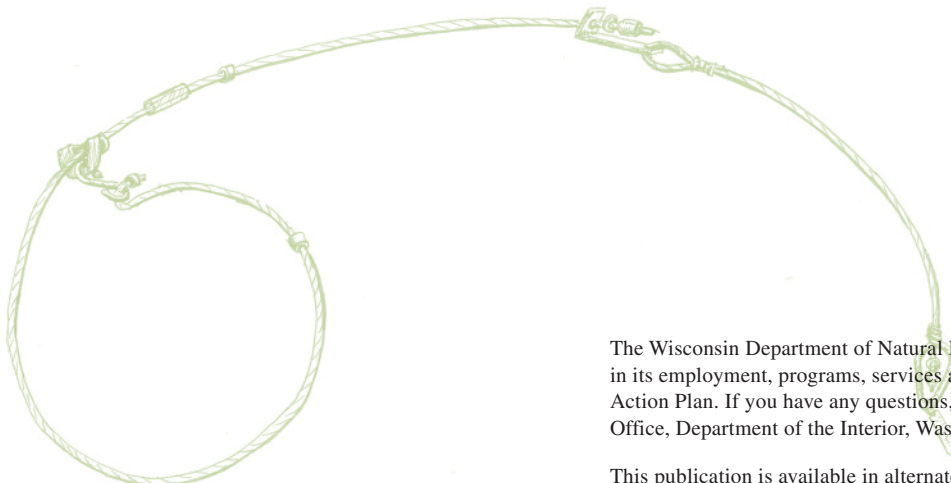
John F. Olson, Furbearer Specialist, Wisconsin Department of Natural Resources

Rick Tischaefter, President of North Dakota Fur Hunters and Trappers Association; Past President of WTA

Edits by Bruce Kohn, Wildlife Research Specialist, Wisconsin Department of Natural Resources

Illustrations by Natalene Cummings

Graphic design by Georgine Price, Madcat Studio



The Wisconsin Department of Natural Resources provides equal opportunity in its employment, programs, services and functions under an Affirmative Action Plan. If you have any questions, please write to Equal Opportunity Office, Department of the Interior, Washington, D.C. 20240.

This publication is available in alternate format (large print, Braille, audio tape, etc.) upon request. Please call 608-266-8204 for more information.



## Table of Contents

Acknowledgments .....	2
Furbearer Management in Wisconsin .....	4
Snares, Past & Present .....	5
Cable Restraints, A New Tool .....	5
How Does a Cable Restraint Work? .....	6
The Wisconsin Cable Restraint Study .....	6
Regulations for Cable Restraints in Wisconsin .....	8
Responsible Use and Placement of Cable Restraints .....	9
Handling Domestics .....	10
Components of the Cable Restraint .....	11
Relaxing Locks .....	11
Ferrules and Swivels .....	12
Loop Stops .....	13
Trap Tags .....	14
Breakaway Devices .....	14
Deodorizing & Conditioning .....	15
Cable Restraint Loop Size and Height .....	16
Fastening and Stabilizing Cable Restraints .....	17
Non-entanglement – THE KEY .....	19
The Future of Cable Restraints – It’s Your Call .....	20



# Furbearer Management in Wisconsin

A primary goal of furbearer management anywhere in North America is the conservation of furbearer populations. As suggested in *Trapping and Furbearer Management in North American Wildlife Conservation, 2001*, “Native wildlife populations are natural resources – biological wealth – that must be sustained and managed for the benefit of present and future generations.”



The focus of wildlife management is to perpetuate and ensure the health of wildlife populations, not individuals within those populations. Conservation looks at the long-term protection and enhancement of the population which is much longer than the life span of any individual animal—for the seventh generation as many native peoples believe. If we want furbearer populations to remain healthy, viable, and self-sustaining populations within the context of human presence, we need to address population management, nuisance, and damage control.

“To protect and enhance our natural resources...” is the foundation of the Wisconsin Department of Natural Resources (WDNR) mission and the guiding principal in furbearer management in Wisconsin. Management of our furbearer resource occurs through biological research, population modeling, intensive surveys, harvest regulations and most importantly, education. This is done through a team approach that includes various department functions such as wildlife management, endangered resources, law enforcement, fisheries, and wildlife research. Several other partners comprise this team including the Wisconsin Conservation Congress, Great Lakes Indian Fish and Wildlife Commission, Wisconsin Trappers Association (WTA), US Department of Agriculture–Wildlife Services, the US Forest Service and the University of Wisconsin system. Annual meetings result in recommendations and agreements that give direction to the program.

Furthermore, the Natural Resources Board endorses and promotes the concept and principles of professional wildlife management. It considers scientific findings to be the primary foundation of sound wildlife management programs, and supports research and surveys necessary to provide the technical information needed. In addition, the Board affirms that furbearers are significant from an ecological, biological, recreational, cultural and economic standpoint. Their strong support enables us to work as a team with partners such as the Conservation Congress and WTA that make our furbearer management program respected throughout the nation.

Modern-day, regulated trapping is an important tool in Wisconsin’s furbearer management program. We have found that mandatory trapper education is critical to building a successful, highly respected trapping community. Through a cooperative program with the WTA, all new trappers (and many seasoned ones as well) learn about the history of trapping, furbearer management, and basic biology of furbearer species. They also receive basic training in responsible, ethical trapping methods, and landowner respect. We hope this publication contributes to their continuing education.

## Snares: Past & Present

Just the mention of the word “snare” brings less than positive images to many people. They envision a wire loop attached to a bent sapling that jerks an animal from its feet when triggered and hangs it suspended in mid-air. In the early years, some individuals did use snares in a less than responsible, ethical and selective manner. This type of activity resulted in a complete ban on their use. Those non-selective, lethal, dryland snaring devices and methods have been illegal in Wisconsin for decades.

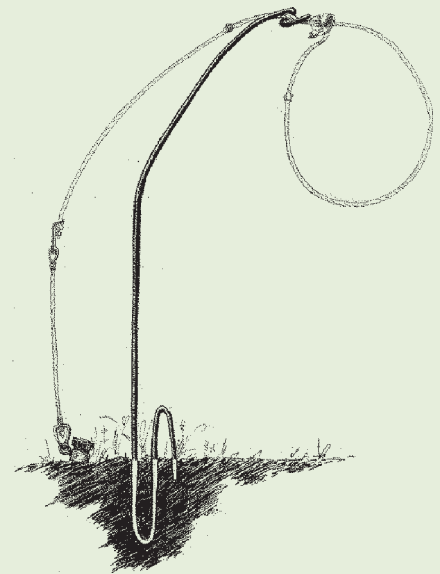
It is unfair to leave this image without further explaining that the only things available for making snares in historic times were sinew, woody fibers, and in later years, cord or thin, single-strand wire. None of these materials could hold large mammals. The materials used allowed even small animals to easily cut them with their teeth or break it by lunging. In addition, early trappers had no means of keeping the noose closed, so they cleverly used saplings and gravity to solve this problem. Elevating the captured animal also kept it out of reach from predators.

*But wait a minute, what’s all this talk about snares! Isn’t this booklet about cable restraints? When are we going to talk about cable restraints? You’re right, just be patient, we’re getting there.*

In the mid-1980’s, extremely high beaver populations resulted in serious threats to trout streams, town roads, railroads, and forested lands. After much thought and discussion, the WDNR decided to allow the use of snares **in water**. Snares were much cheaper and lighter than traditional beaver traps and we felt they may allow trappers to more efficiently harvest beavers.

The snares used today have important components unknown in earlier days such as braided wire, swivels, locks, and great improvements in anchoring technique. Our current rule language defines a snare as “a noose used for catching furbearing animals **in a water set**.” The rules also specify that:

- Snares shall be non-spring activated, constructed of galvanized aircraft cable and include a relaxing mechanical lock and swivel;
- cable length shall be 5 feet or less with a diameter not exceeding 1/8 inch; and,
- at least one-half of the set snare is located underwater at all times.



## Cable Restraints: A New Tool

In Wisconsin, trapping methods and techniques are constantly being reviewed to determine the best methods. These reviews include selectivity, efficiency, practicability, and animal welfare. Winter weather presents a challenge to capturing and restraining coyotes and foxes. Frozen ground, freezing rains and frequent snowfalls makes footholds less efficient during this time of year.

So where is this better mouse trap? What’s available that we’re currently not considering, which would address our needs and be a humane device? Is there anything out there that works well and ranks high on animal welfare scores?

We learned of a relaxing snare device that was being used successfully in other states and highly recommended by furbearer specialists. This is where **cable restraints** enter Wisconsin’s furbearer management program as a humane, efficient, effective, and practical tool.



## How Does a Cable Restraint Work?

How does a cable restraint work without a powering device or spring? Simply, the animal itself provides the energy needed to close the loop.

The cable restraint loop is suspended in a trail or path frequented by an animal. When the animal proceeds down the path and enters the loop it will continue forward until it feels resistance as the loop closes down around its neck. Sounds too simple!

Well, when wild canids travel through their environment they frequently encounter minor obstacles along their path (branches, shrubs, vines, etc.). Normally they simply push through the material instead of making a detour every time they encounter such an obstacle. It's quite possible a wild canine perceives a cable restraint in a similar manner that it perceives a vine or shrub. Not seeing it as danger, it will just push through. When it finds it cannot free itself from this "bush" it often times will try and back out. However, upon feeling any type of constriction the animal instinctively stops pulling back and the washer lock is designed to relax. When set correctly, the cable restraint then humanely holds the animal in place.

## The Wisconsin Cable Restraint Study

The Wisconsin Conservation Congress, the WTA, and the WDNR agreed to work together to conduct a research study to determine the efficiency of cable restraints for capturing selected wild canids (coyotes, foxes and gray wolves). Of most importance was documentation and consideration of any injuries to the wild canids or any non-target species caught, especially domestic pets.

Funding for this trap research and development was provided by in-kind services of members of the WTA and the WDNR Trapper Education program. Study design followed the science-based, field-tested protocol used and perfected by the Furbearer Resources Technical Work Group of the International Association of Fish and Wildlife Agencies. Field studies were conducted from January 1 through February 15 of 2001 and 2002.

Seven trained trappers and technicians used 7 similar cable restraint systems in 715 locations during each 15 day field season. They recorded 7,008 trap nights and 344 definite animal contacts resulting in the capture of 41 coyotes, 16 red fox, 4 gray fox, 5 raccoons, and 2 deer. Trappers released 9 raccoons, 7 domestic dogs, 2 deer and 1 fisher. In addition, 5 coyotes, 3 deer and 1 gray wolf were released via the breakaway device.

Over 1,818 volunteer hours were donated and 17,457 miles driven during this work!. The final cost to WDNR was only \$7,607.06. This reflects the tremendous amount of cooperation received from the WTA.

### Efficiency

Data analysis showed that specific cable restraints tested had an overall performance efficiency of 88 % (captures/all closed devices). Seventy-seven percent of the animals caught were coyotes and foxes; while 94 % of all animals caught were furbearers (coyotes, foxes, raccoons, fisher and gray wolf).

### Pelt Studies

In 2001 pelts were skinned, stretched, dried and then tanned by a commercial tannery to determine affects of restraints on fur quality. Professional fur graders for North American Fur Auction, Inc. (NAFA) inspected all pelts and determined little to no damage to any furbearer.

## Injury Scores-IAFWA Standards

In 2002 necropsy results from 42 coyotes and foxes captured were evaluated following the injury scoring system employed by the International Association of Fish and Wildlife Agencies. Table 1 summarizes the results, with 71% of all injuries classified as mild; 26% as moderate; 2% as moderately severe; and 0% as severe. A score of 70% or greater in the combination of mild and moderate categories is considered acceptable. This scoring system means the higher the score, the better. The total of mild and moderate injury scores for this study was 97%.

## Injury Scores – ISO Standards

We also evaluated injuries using the International Standards Organization (ISO) Injury Scoring System, another independent measure. With this cumulative numeric system a *final score of 55 or less* is necessary to be considered acceptable. This scoring system means the lower the score, the better. The final numeric score of this study for all coyotes and foxes was 6.8 (Table 2). This independent evaluation supports and parallels results of the IAFWA injury score system.

This brings us to today! Following approval from various committees and boards, we are looking toward responsible use of cable restraints on lands in Wisconsin. *The future of this tool lies completely with how it's used on the landscape.* The ultimate final step will be to provide

**Table 1.**  
**2002 Cable Restraint Study-IAFWA Injury Scores\***

Species	Mild	Moderate	Moderately Severe
Coyote	21	9	0
Red Fox	9	1	1
Gray Fox	0	1	0
% of Total	71	26	2

\*IAFWA Standards: The total of categories Mild + Moderate scores must be greater than 70% to be considered acceptable.

**Results of this study: mild + moderate = 97 %.**

interested trappers, from seasoned veterans to first timers with suggestions and recommendations on how to use these tools legally, responsibly, and ethically. Although it has been proven to be a remarkably safe tool to the user and the restrained animal, it can cause the death of an animal without proper use or respect for the law. In the following pages we will try to explain in detail what the rule says and how to use cable restraints wisely.

**Table 2. 2002 Cable Restraint Study-ISO Injury Scores\***

Species	# of Specimens	High Score	Low Score	Average
Coyote	30	11	2	3.5
Red Fox	11	54	2	15.3
Gray Fox	1	11	11	11.0
Total	42	54	2	6.8

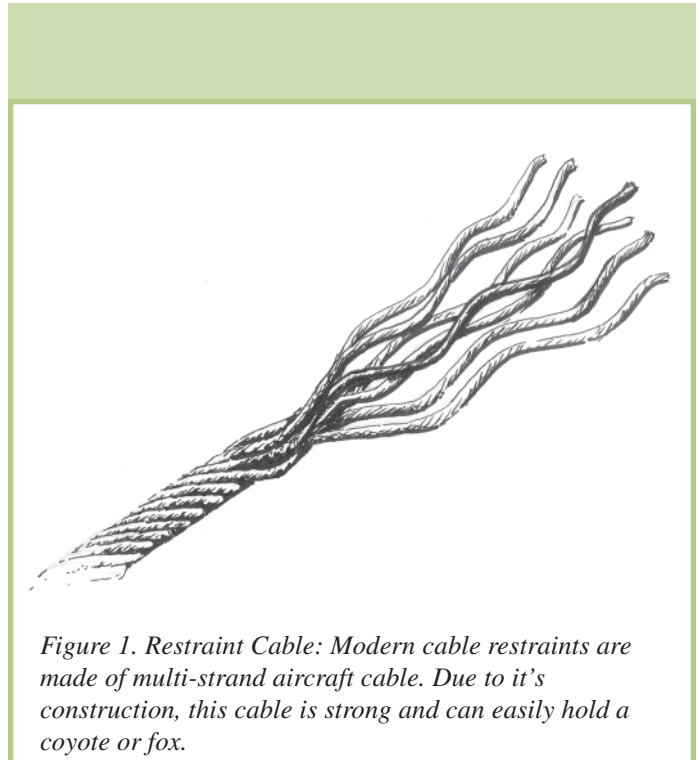
\*ISO Standards: Final score must be 55 or less to be considered acceptable. **Results of this study: 6.8.**



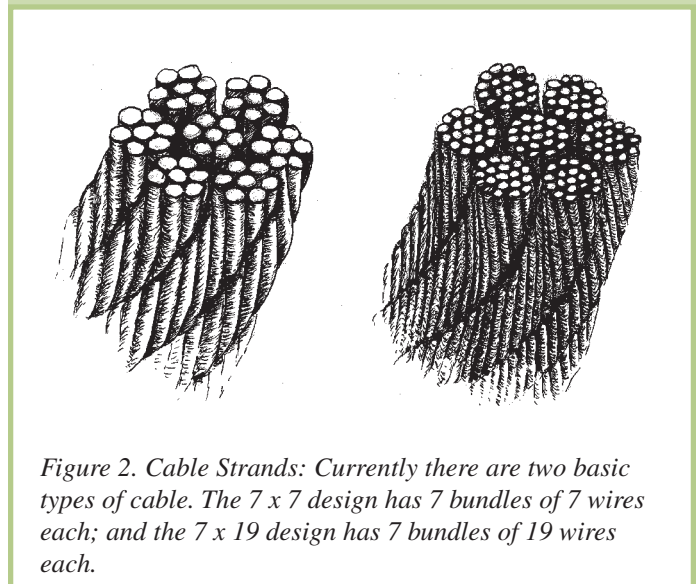
# Regulations for Cable Restraints in Wisconsin

It is very important that trappers fully understand and comply with all regulations pertaining to the use of cable restraints in Wisconsin. These have been developed to insure their humane and ethical use. The following regulations apply to cable restraints:

- Cable restraints are defined as a noose used for restraining furbearers which is not set or staked in such a manner as to permit the restraint device or trapped animal to reach water. They can be used for dryland sets only.
- Cable restraints may only be set, placed or operated for fox and coyotes from January 1 through February 15;
- Cable restraints shall consist of a non-spring activated, galvanized aircraft cable which includes a relaxing mechanical lock, stops, and swivel;
- Cable restraints must be tagged with a metal tag stamped with the name and address of the operator;
- Cables must be 7 feet or less in length with 7 bundles comprised of 7 wires per bundle (7 x 7), or 7 bundles comprised of 19 wires per bundle (7 x 19), with a diameter of 1/8 inch or 3/32 inch. (Figure 2.)
- The relaxing mechanical lock on the cable shall be a reverse-bend washer lock with a minimum outside diameter of 1 1/4 inches.
- Cable stops shall be affixed to the cable to ensure that the portion of the cable which makes up the noose loop may not be longer than 38 inches (12 inch loop) when fully open, or less than 8 inches (2 1/2 inch loop) when fully closed.
- The bottom of the set restraint cable loop cannot be closer than 6 inches or greater than 12 inches above the surface. The surface is defined as ground, ice, crusted or packed snow or any other hard material beneath the cable loop.
- A cable restraint shall include a breakaway device or stop rated at 285 pounds or less. There are two acceptable breakaway devices. One system (Figure 23, page 14), includes an “J” hook breakaway which opens on both ends with sufficient force, and the other (Figure 24, page 14), includes a ferrule breakaway which slips off the end with the same amount of force.
- Cable restraints must be staked in a manner that does not allow the animal or the restraint device to reach any part of a fence or rooted woody vegetation greater than 1/2 inch in diameter.



*Figure 1. Restraint Cable: Modern cable restraints are made of multi-strand aircraft cable. Due to its construction, this cable is strong and can easily hold a coyote or fox.*

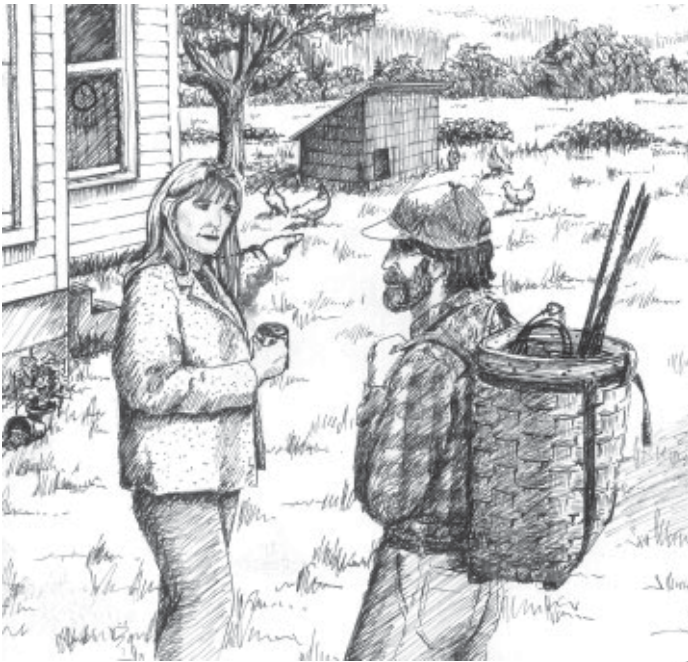


*Figure 2. Cable Strands: Currently there are two basic types of cable. The 7 x 7 design has 7 bundles of 7 wires each; and the 7 x 19 design has 7 bundles of 19 wires each.*

# Responsible Use and Placement of Cable Restraints

## Educate

You've heard it before and here it is again. Your responsible, careful use of this tool will be a major reward to you and others you encounter. When securing permission to trap, show landowners the restraint tools and explain how they work – as a live restraint tool like a collar for a dog. Give them a copy of this booklet, or photocopy portions that explain how the device works, and results of our studies. Landowners will be impressed with your care and concern which will only open more doors, and more opportunities.



*Figure 3. Landowner Permission: Always ask permission! Landowners know and watch their property closely and can direct you to prime locations.*

## Scout and Restrain Yourself!

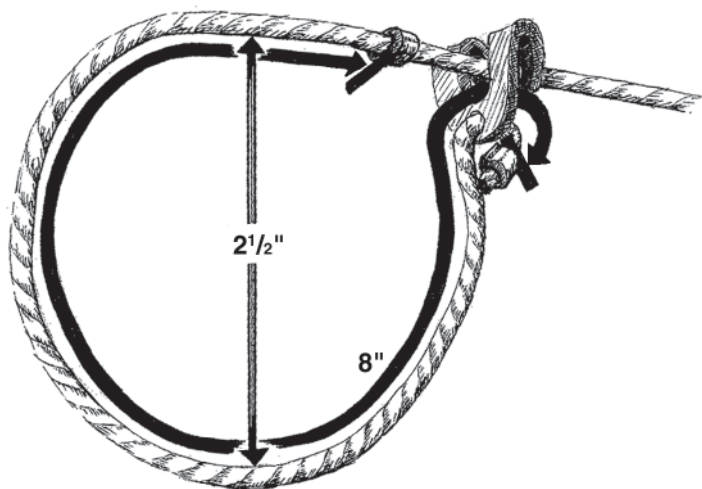
When using these tools, scout areas to assure there are very few or no domestic animals in the vicinity. Although the restraint breakaway will allow livestock to pull the device apart, it's not a wise practice to make any sets where livestock are present. Refrain from setting in areas where dogs are present and allowed to wander off a leash.

## Deer

And more deer! Pure common sense dictates that you do not make sets on deer trails. Deer use these trails frequently and will knock your sets down making them non-functional when approached by coyotes or foxes. Also, avoid using any material over the device that would result in animals "ducking under." This is a sure invitation to catch a deer because they tend to "duck" under rather than jump over most obstacles. To capture wild canines you want the animal to lift his head as they approach the cable restraint because they often are traveling with their nose down in search of scent. A small "chin lift" placed below the loop is far more effective and selective than trying to get an animal to duck under something. Figure 4 clearly depicts how a wild canine keeps its head down while using its nose to search for scent. At the same time there is always a watchful eye and a turned ear, maintaining total awareness of all around.



*Figure 4. Wild canines constantly use their nose, eyes, and ears to keep track of their surroundings. Head down, eyes up.*



*Figure 5. Foot Stop: An 8 inch circumference to the first stop assures a minimum loop size of 2½ inches, more than enough for any foot-restrained animal to escape. The breakaway allows larger animals like livestock to do the same.*

## Bait

The placement of bait for trapping is not allowed in Wisconsin until the trapping season is in progress. Bait can be used once the season is open. You will have plenty of time to place baits for use of cable restraints during the months of January and early February because the trapping season opens in mid-October. However, no traps can be set within 25 feet of exposed bait. Landowner permission should be obtained for the use of any bait, and the bait should be placed in an area where the public or adjacent landowners are not affected.

It is important to identify travel patterns and specific routes used by coyotes and foxes before, and especially after the placement of bait. Veteran trappers report greater success by setting 200 to 300 feet (or more) from bait stations. They suggest placing restraints at critical trail junctions several hundred feet from the bait is far more effective. Wild canines become wary and nervous about the presence of any disturbance or foreign odors as they approach a feeding site. Captures at or near bait stations seem to quickly make the sites inactive.

## Handling Domestics

Although domestic dogs are not in serious trouble when caught in properly set cable restraints, it only makes sense to take precautions to avoid such an occurrence. However, there will be instances where dogs not under control of their owners will show up at your set. It is best to locate the owner if you encounter a dog in one of your restraints and release appears difficult. Our experience has been that most dogs are standing there wagging their tails waiting for the “collar” to be removed, and pose no problem in the release. If additional restraint is necessary, we highly recommend the use of a catchpole (which is nothing more than another cable restraint on the end of a fiberglass handle). Place the noose of the catchpole over the dog’s head and tighten it gently. Then pin the animal down and cut the loop on the cable restraint to release it. A pair of quality cable cutters should become part of your personal cable restraint equipment.

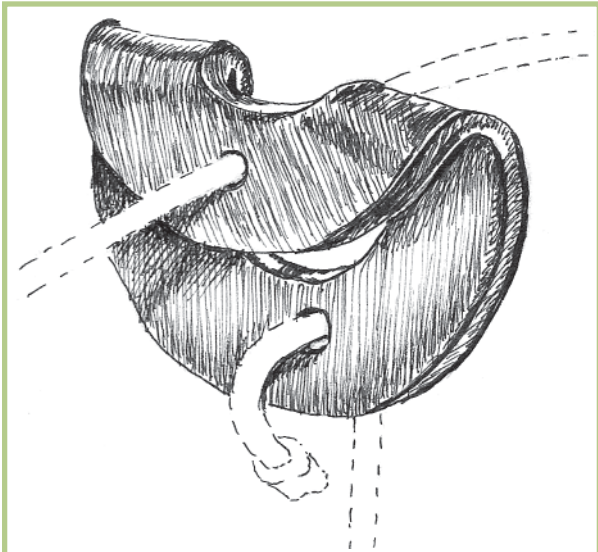
If the owner is known, return dogs promptly and let them know where they were. Our limited experience with this practice has been very positive. Most dog owners will be pleased with your concern for their pet, and many will appreciate your efforts to harvest coyotes and foxes. And it goes without saying, any injured dogs should be promptly delivered to a local veterinarian.



# Components of the Cable Restraint

## Relaxing Locks

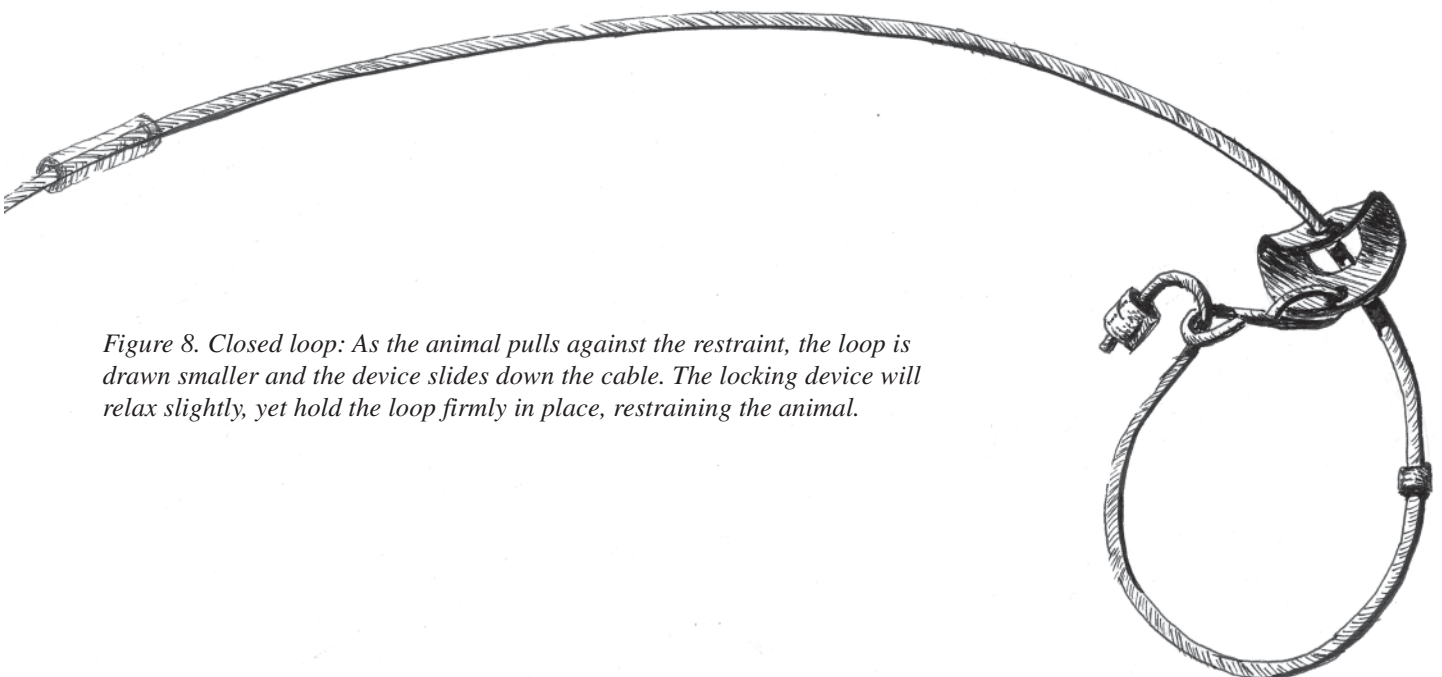
A wide variety of relaxing locks are available. However, in Wisconsin we only allow the reverse-bend washer lock of 1 1/4 inch diameter or larger.



*Figure 6. Relaxing Lock: In Wisconsin the reverse-bend washer lock must be 1 1/4 inches in diameter or larger to assure good performance.*



*Figure 7. Open Loop: The relaxing lock is a critical part of the cable restraint. The restraint loop is set to allow the animal to enter, which then closes firmly but does not cause discomfort to the restrained animals.*



*Figure 8. Closed loop: As the animal pulls against the restraint, the loop is drawn smaller and the device slides down the cable. The locking device will relax slightly, yet hold the loop firmly in place, restraining the animal.*



## Ferrules

Ferrules are used to hold the lock on a cable restraint, or with special tools, can become the breakaway as well. They are also used to hold the swivel on a cable. Ferrules are hammered or crimped onto the cable restraint.

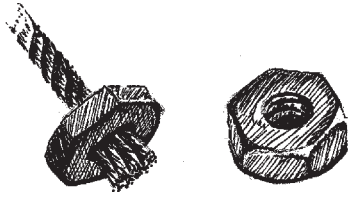


Figure 9. Steel Nut ferrule: Special steel nuts are often used as ferrules. These nuts are heat treated to keep them from cracking when hammered.

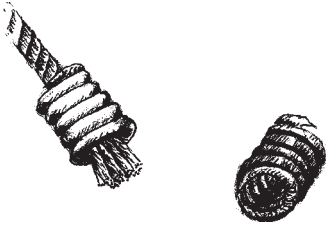


Figure 10. Wire ferrule: Coiled steel wire is also used as a ferrule. Once slipped over the cable, it is then hammered in place.

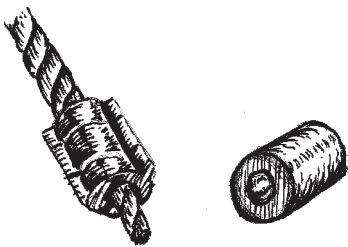


Figure 11. Aluminum ferrule: Single aluminum ferrules are often used.

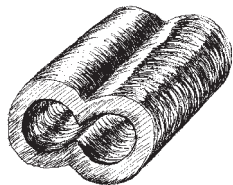


Figure 12. Double end ferrule: A double ferrule is used to form a loop on one end of a restraint cable.

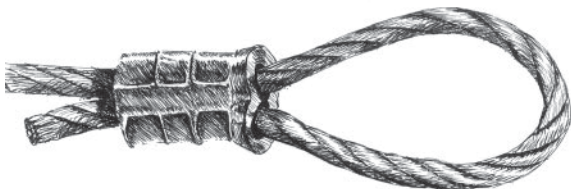


Figure 13. Cable loop with the double end ferrule A double end ferrule provides a secure loop, important when using earth anchors.



Figure 14. Breakaway ferrule: The aluminum breakaway ferrule rated at 285 lbs or less and is one of two options available in Wisconsin.

## Swivels

In Wisconsin a cable restraint must be equipped with a swivel. Some swivels provide a means for anchoring the restraint, while all swivels provide additional comfort to the animal. Swivels reduce the risk of badly kinked or twisted cable and help to keep the set functional. It is recommended to use multiple swivels if possible.

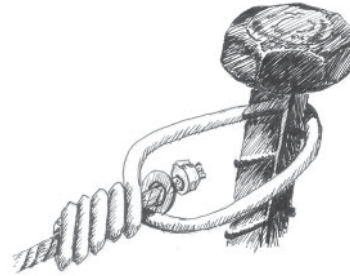


Figure 15. End Swivel: End swivels for cable restraints are most commonly made out of wire. We recommend #9 gauge wire or larger.



Figure 16. End Swivel + Box Swivel: An end swivel, in combination with a box swivel is recommended.

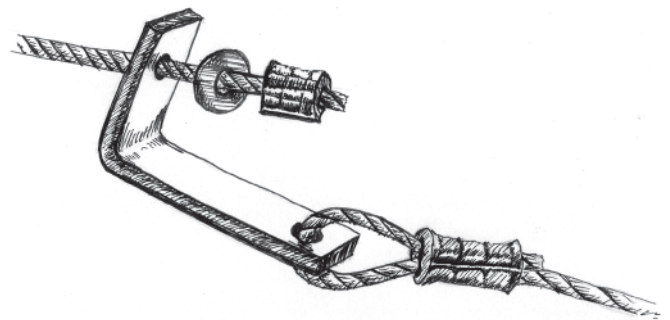


Figure 17. In-line swivel: An in-line swivel has a distinct advantage in areas where you have thick grasses and sedges.

## Loop Stops

Maximum and minimum loop stops are required on dry land cable restraints. These stops prevent the cable from expanding beyond a 12-inch diameter loop or from closing past a minimum of a 2½ inch diameter loop. The maximum stop prevents larger animals from entering the restraint while the minimum loop prevents the restraint from closing around an animals foot.

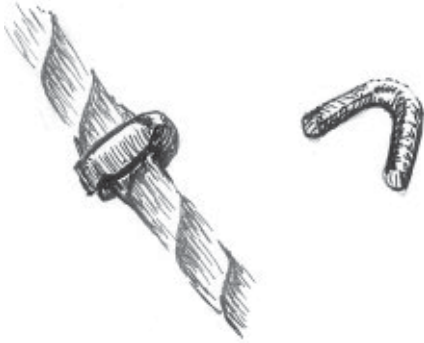


Figure 18. Loop Stop–Horseshoe: Heavy gauge wire can be crimped and hammered on the restraint cable to create a stop.

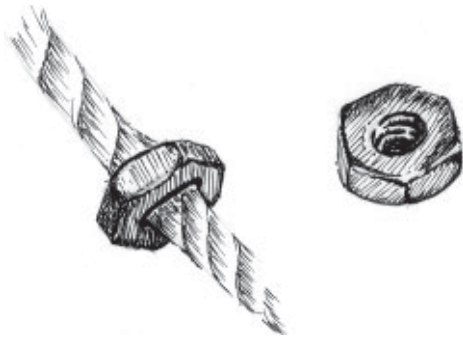


Figure 19. Loop Stop–Nut: In similar fashion tempered steel nuts can be hammered onto the cable as a stop device.

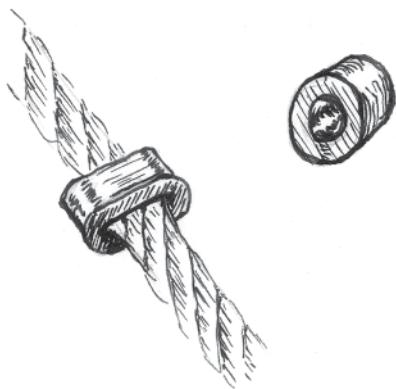


Figure 20. Loop Stop–ferrule: Aluminum ferrules can also be flattened on to the restraint cable and work well as a stop.

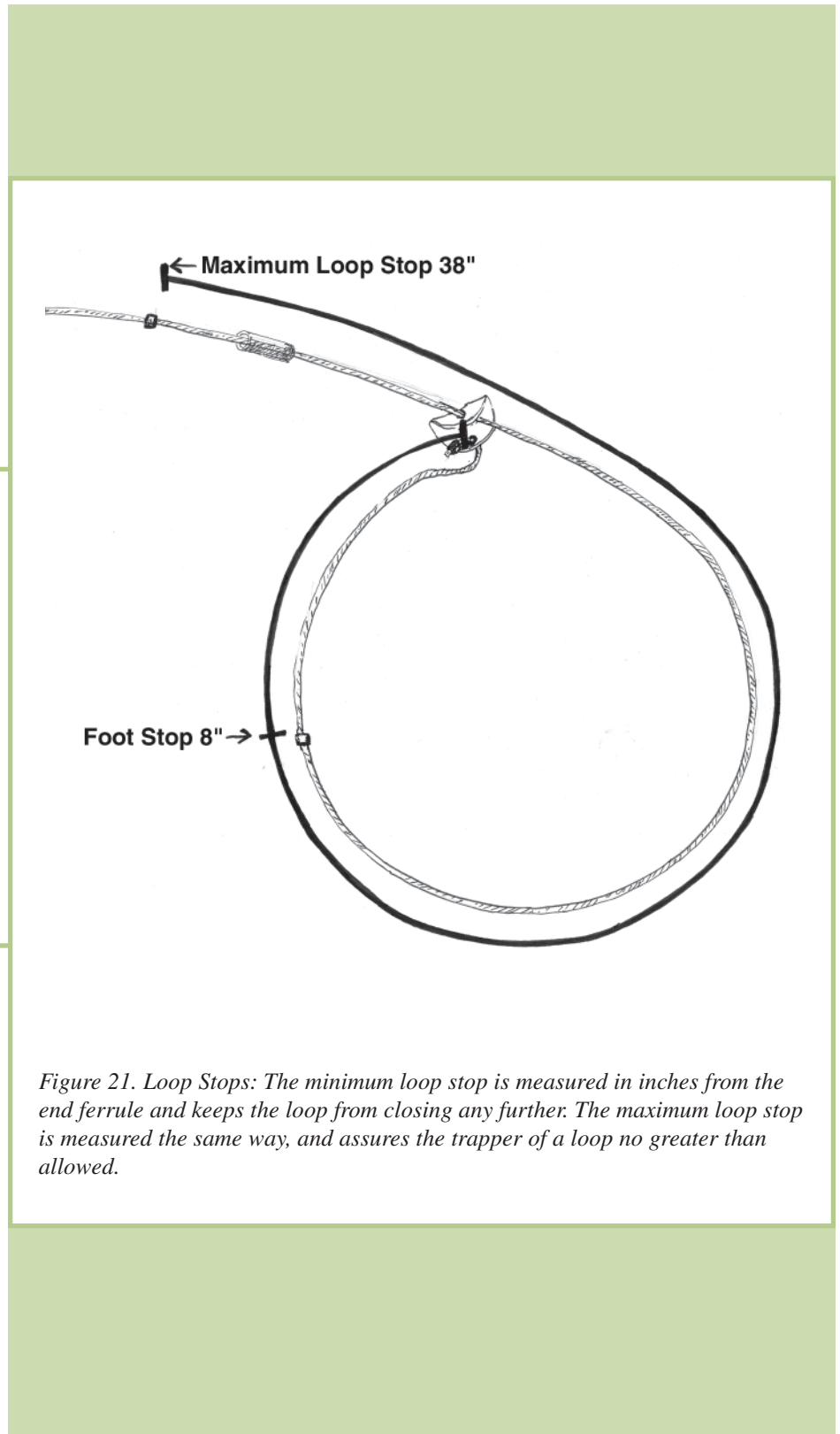


Figure 21. Loop Stops: The minimum loop stop is measured in inches from the end ferrule and keeps the loop from closing any further. The maximum loop stop is measured the same way, and assures the trapper of a loop no greater than allowed.

## Trap Tags - Identification

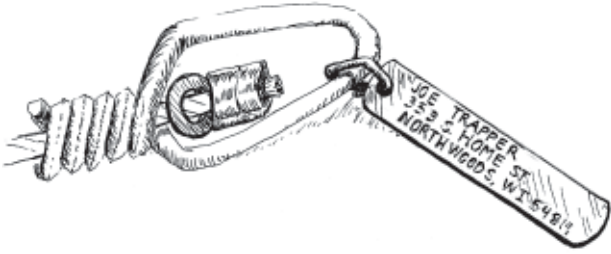


Figure 22. Trap Tags: Cable restraints must have a metal tag stamped with the operator's name and address.

## Breakaway Devices

In Wisconsin, there are two acceptable breakaway devices. One system (Figure 23), includes a “J” hook breakaway which opens on both ends with sufficient force, and the other (Figure 24), includes a ferrule breakaway which slips off the end with the same amount of force.



Figure 23. Cable Restraint–J hook: A complete cable restraint equipped with a J hook breakaway.



J hooks are commercially available at various breakaway strengths. In Wisconsin, it is required to use a 285 lb. or less J hook.



Figure 24. Cable Restraint–ferrule: A complete cable restraint equipped with a ferrule breakaway. This system requires a specialized tool needed to crimp the ferrule to the required tension. It is recommended to purchase these ferrule stops already attached to your cable.



## Deodorizing & Conditioning

Wild canines are basically high tech sensory devices traveling at various speeds through their environment! With olfactory senses over 100 times more sensitive than a human nose, their nose, knows! Little will get passed a wild canine unless masked in some fashion. Just think about it.... You're attempting to convince this animal with a super "smeller" to place its head, through a cable that was just handled and set by you! This one factor is critical in successfully capturing wild coyotes and foxes. Otherwise you will just have a number of good stories about how these telepathic, wily critters slammed on the breaks just inches in front of your set!

There are a number of suggested methods in deodorizing your sets and equipment. An easy method is to paint your cable restraints dull black, brown, or gray to blend in with the vegetation where you will be setting. Painting restraints white does not blend in with the landscape well. The resulting "white circles" are too obvious to canines in dark-hued vegetation such as grasses, brush or cattails. Allow considerable time to allow the paint to dry and rid itself of any petroleum by-products. Dipping is easier and assures more complete coverage.

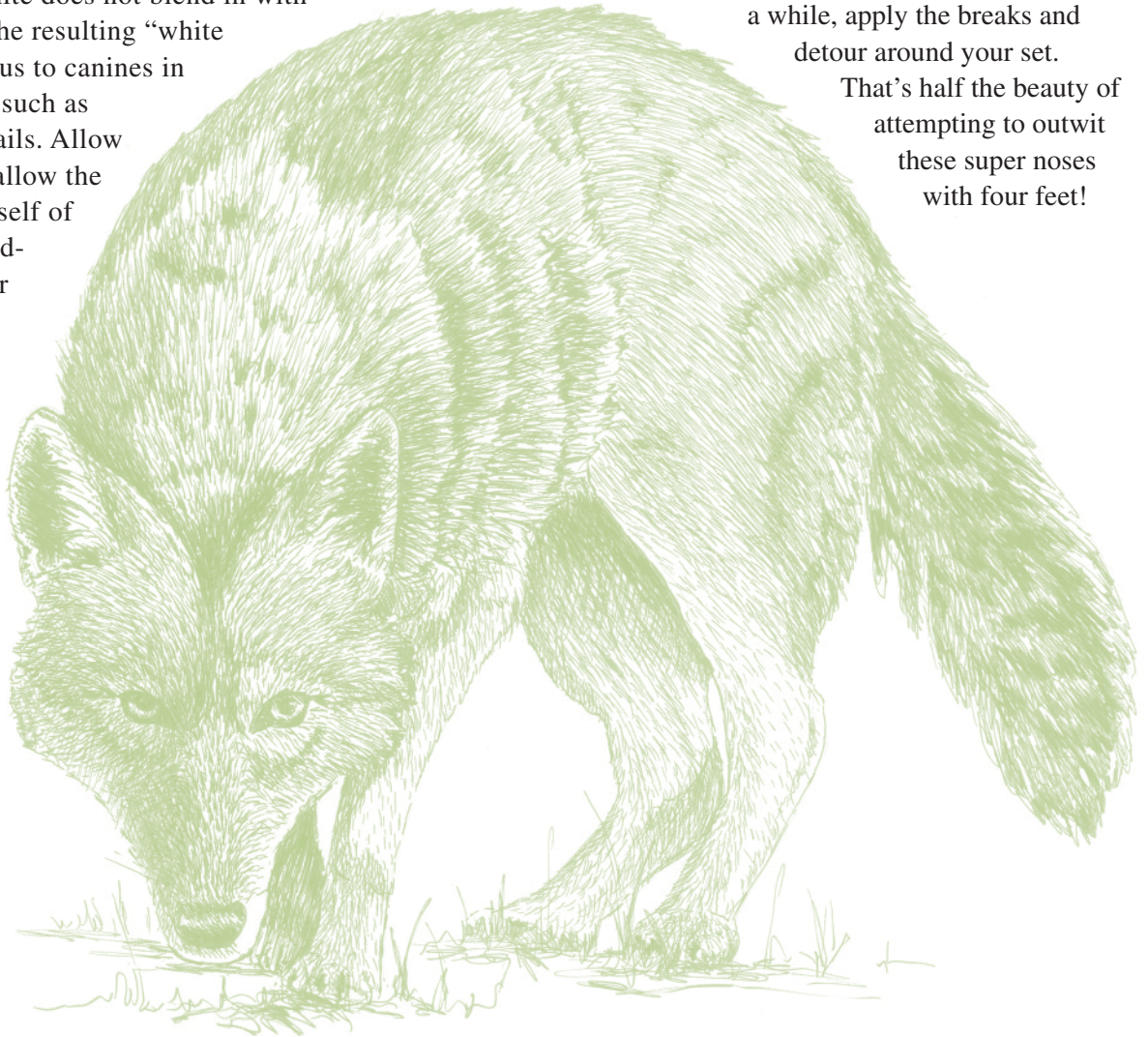
A more preferred method is to simmer the restraints in a mixture of two gallons of water with one pound of baking soda for an hour. This technique removes much of the manufacturer's oils, eliminates most odors, and gives the

aircraft cable a dull gray finish. Drying the restraints with a good quality logwood dye after they have been simmered in the water/baking soda mixture further colors them to blend better into the surroundings.

We strongly recommend that you place the restraints into individual ziplock bags to prevent contamination during transport. With other methods of canine trapping, all other tools used in the field should be deodorized and transported in a manner that keeps them odor free. Wearing clean rubber gloves and boots also helps reduce the amount of human scent at trap sites. We recommend approaching perpendicular to canine travel routes to further minimize disturbance and foreign odors.

But don't get discouraged if you have a refusal or two. No matter how diligent you are about blending in your sets and keeping scent at a minimum, you're destined to have a wild canine detect something once in a while, apply the breaks and detour around your set.

That's half the beauty of attempting to outwit these super noses with four feet!





# Cable Restraint Loop Size and Height

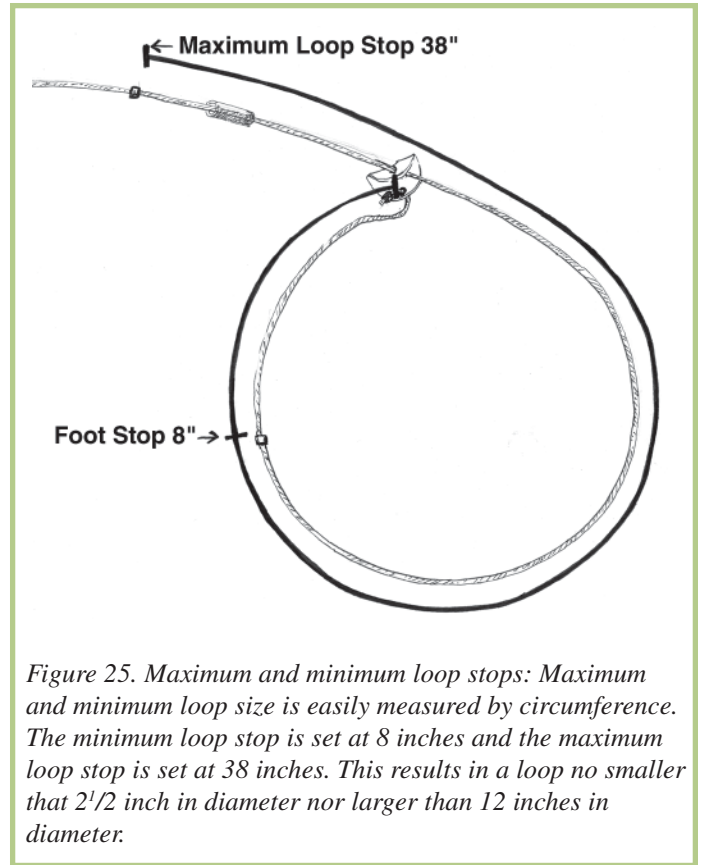
Much work has been done to determine the appropriate loop size of cable restraints used for wild canines. Wisconsin regulations require two “stops” on the cable, one we call a foot stop; the other is the maximum loop stop.

The foot stop is placed 8 inches from the closest portion of the end or ferrule stop thus allowing a 2½ inch diameter loop. This is designed to allow animals caught by the foot to slip free. Animals with large feet such as livestock or gray wolves have the strength to open the breakaway device and walk away.

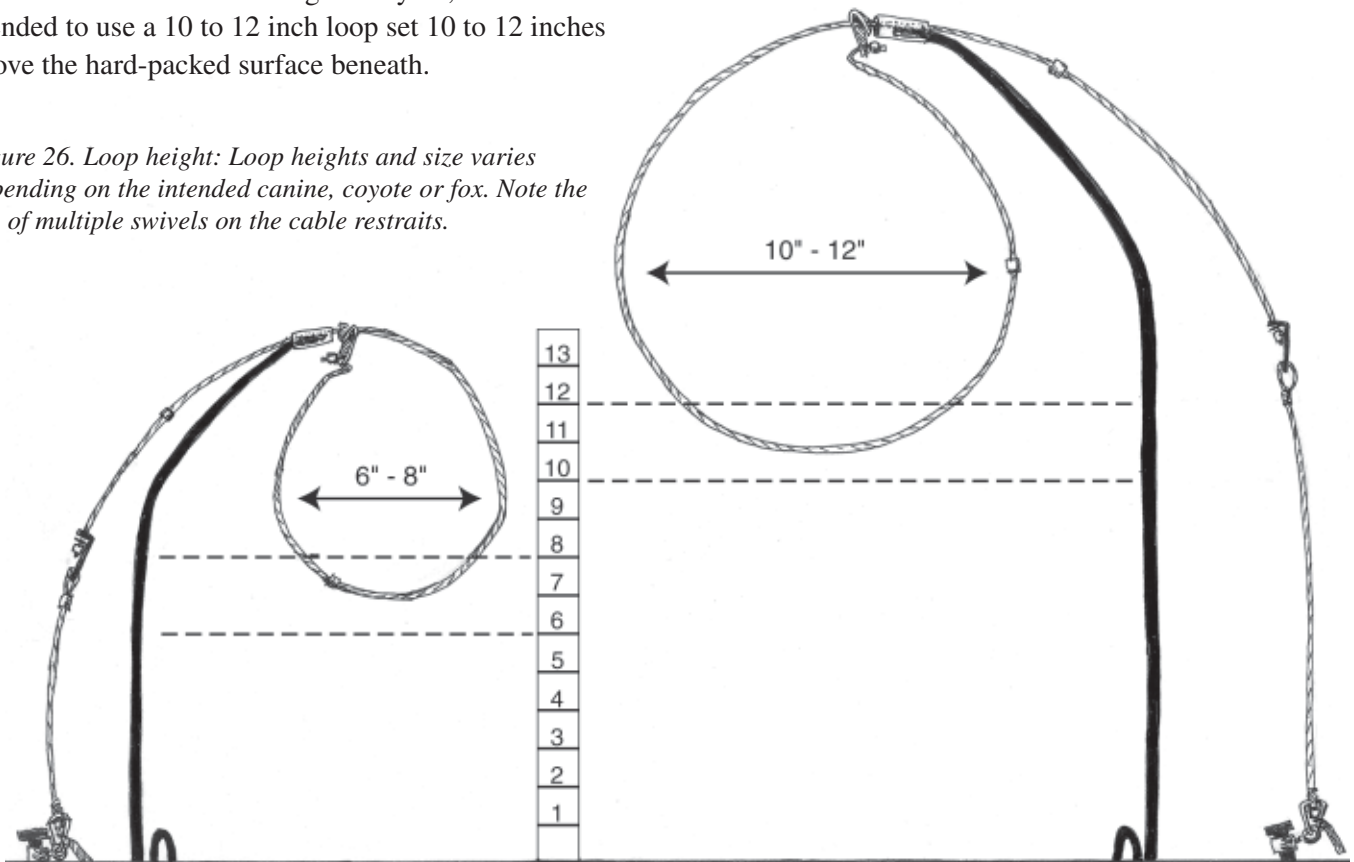
The maximum loop stop is placed 38 inches from the closest portion of the end or ferrule stop to assure no opportunity for the set device to open larger. This results in a maximum loop diameter of 12 inches, more than ample to restrain wild canids.

Loop height is also regulated to reduce incidental catches of non-target species. The bottom of the set loop cannot be closer than 6 inches or higher than 12 inches to the hard-packed surface beneath. When setting for fox, it’s recommended to go with a small loop of approximately 6 to 8 inches set 6 to 8 inches above the hard-packed surface beneath. When setting for coyote, its recommended to use a 10 to 12 inch loop set 10 to 12 inches above the hard-packed surface beneath.

*Figure 26. Loop height: Loop heights and size varies depending on the intended canine, coyote or fox. Note the use of multiple swivels on the cable restraints.*



*Figure 25. Maximum and minimum loop stops: Maximum and minimum loop size is easily measured by circumference. The minimum loop stop is set at 8 inches and the maximum loop stop is set at 38 inches. This results in a loop no smaller than 2½ inch in diameter nor larger than 12 inches in diameter.*



# Fastening and Stabilizing Cable Restraints

Proper staking is extremely important when using cable restraints. Drags are not allowed because they would allow animals to become entangled and this could cause serious injuries or death. Unlike foothold restraining devices, an animal captured in a cable restraint has the use of all four feet to pull against the anchoring device. The anchoring system has to be of sufficient strength to withstand this stress. Thus it is important to use strong earth anchors and/or long, rerod stakes. We recommend double staking using 30-inch rerod as shown in Figure 27.

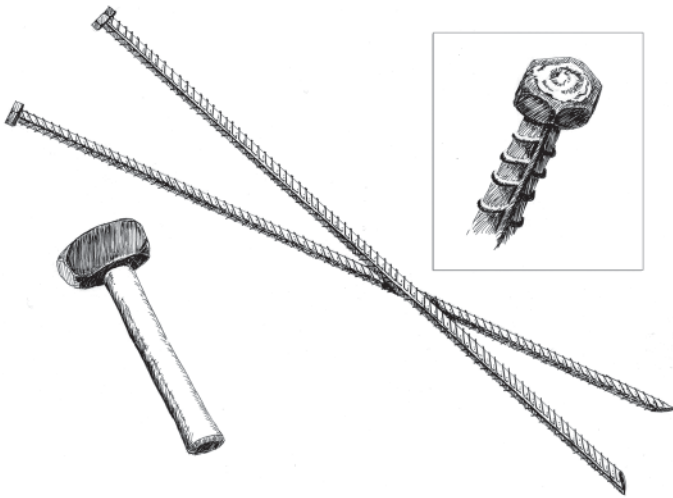


Figure 27. Anchor Stakes: Rerod stakes should be at least 30 inches long, have a nut welded on one end and tapered on the other. A good-sized maul is required to drive stakes of this length!



Figure 28. Double stake device: Commercially made double-stake devices allow for ease in connecting the restraint. Note the double swivel action.

Earth anchors can be employed where frost-free ground conditions allow adequate penetration. This technique also works well in good ice situations such as wetlands. After drilling a 1/2 inch diameter hole, an inserted anchor will freeze in place and when pulled, will lock on the bottom edge of thickening ice. Avoid anchoring right next to cattails or reeds, as these areas will be susceptible to thawing from sunlight.



Figure 29. Earth Anchor Tube: Various tubular or flat metal earth anchors work well in unfrozen ground.

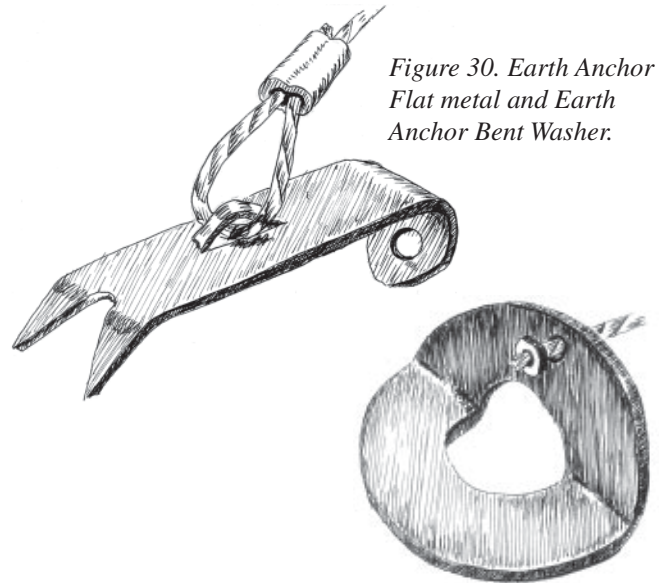


Figure 30. Earth Anchor Flat metal and Earth Anchor Bent Washer.

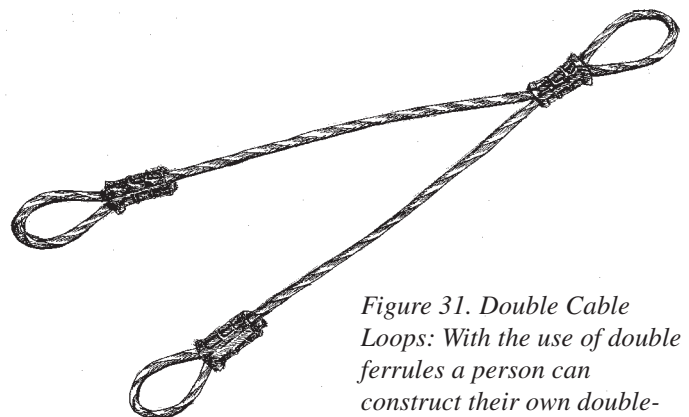
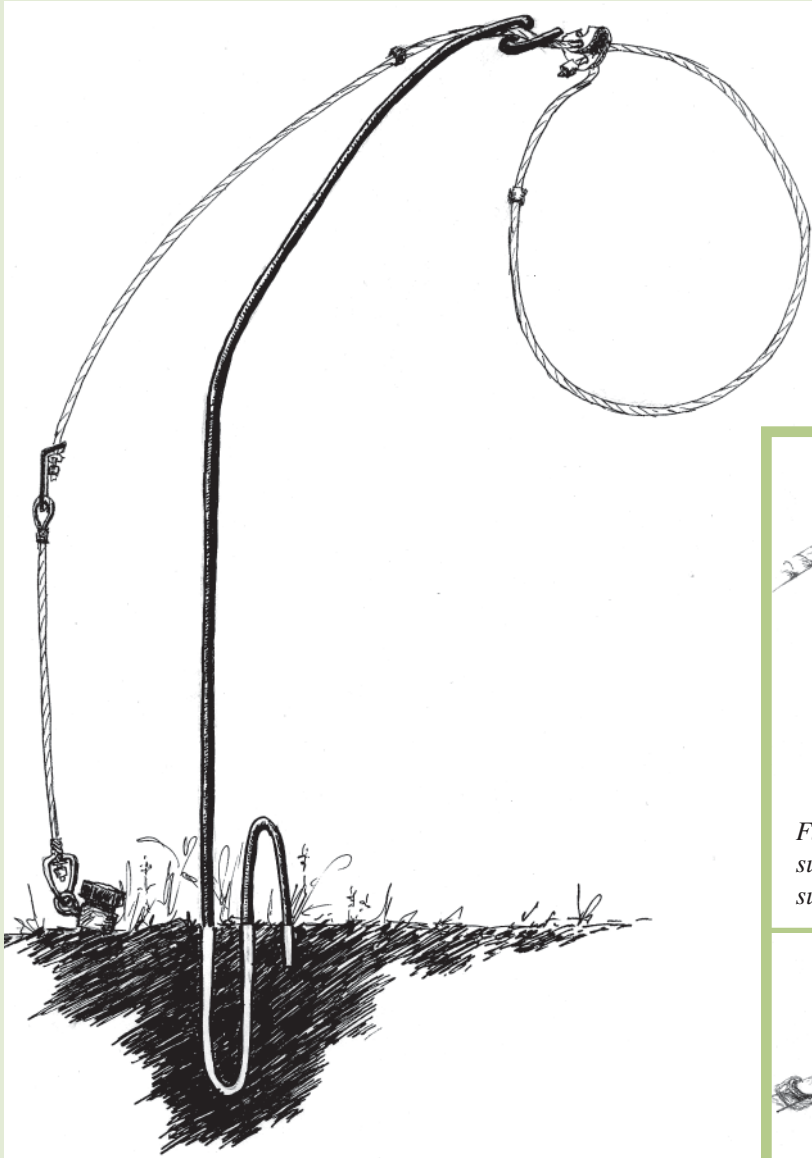


Figure 31. Double Cable Loops: With the use of double ferrules a person can construct their own double-staking device from cable.

Wisconsin requires cable restraints to have at least one swivel. An in-line swivel (Figure 17) is recommended because it assures continued function even in thick vegetation, but an end swivel (Figures 15-16) will comply. Swivels will help to reduce injury and allow cable restraints to function even when an active canine is restrained.

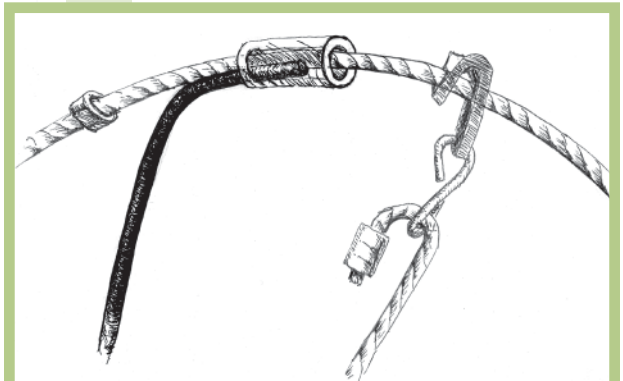
It is important to securely support and stabilize cable restraints. A support system of #9 gauge wire will support the cable at the

proper height and position. Once a person has anchored the support wire into the ground it can be twisted and bent to eventually be at the desired height. If the ground is frozen, a large spike and hammer can be used to make proper anchoring holes. A plastic collar or metal “whammy” included in the construction of the restraint tool (see Figure 33) allows a person to attach the cable restraint to the heavier gauge support wire.

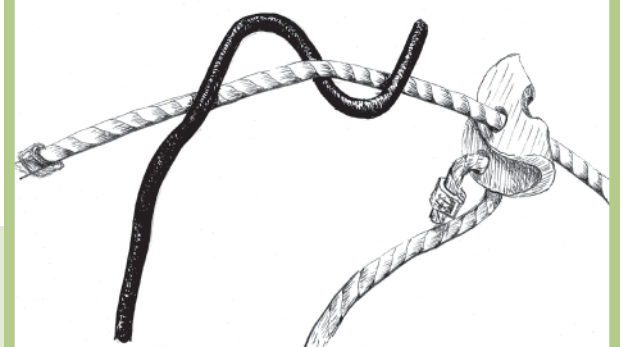


*Figure 32. #9 gauge anchor: With the use of heavy gauge wire a person can easily develop a cable restraint support. Bending the wire twice before inserting into the ground gives additional strength and stability to the support. Note the swivels on the restraint device.*

It is also important to set the cable restraint lock on the support wire at the 10 o'clock or 2 o'clock position, depending on which side of the trail you are setting from. This simple adjustment will enable gravity to keep the loops open even when disturbed by passing deer or other large animals. Use of a plastic collar or looping the cable over the support wire as depicted in Figure 34 will allow the cable to reset itself following a disturbance.



*Figure 33. Plastic Collar: Another method of support is with the addition of a short piece of surgical tubing referred to as a collar.*



*Figure 34. #9 gauge support: Building a small N into the loop support secures the device from easily being knocked down.*



# Non-entanglement —THE KEY!

Memorize the following statements and repeat them a 100 times before making your first set!

***“Little is more important than assuring a restrained animal cannot become entangled. And, this is the law.”***

The future use of cable restraints will largely depend upon your responsible actions to prevent restrained animals from becoming entangled. Our studies show that this single, important precaution assures a safe, live capture of wild canids; a safe, live capture of other wildlife; and a safe, live capture of domestic dogs as well. The most significant attribute of cable restraints is their ability to restrain animals with little or no injury.

## How do you reduce or eliminate entanglement?

1. Set only where the extended cable and restrained animal cannot become entangled in any rooted, woody vegetation larger than 1/2 inch diameter. Grasses, cattails and small woody materials do not cause a problem and often times are excellent places to make good sets. If you need additional material, you can cut off larger woody vegetation and stick it back into the snow or ground. Once severed from the root system they are not considered entanglements.
2. Stake cable restraints solidly in areas totally devoid of large obstacles such as rocks, fences or equipment. You must remember that a restrained wild canine will have all four, powerful legs to try to pull the stake from the ground. For this reason it is recommended to use 30 inch rerod stakes or solid earth anchors. However, even with such solid, strong anchoring systems, large coyotes can pull cable or rerod anchors partially from their position. Be careful to compensate for this by providing a little extra room of non-entanglement around the set.
3. Swivels, swivels and more swivels! Although the law only requires one swivel, consider adding in-line swivels to better assure continued function, reduction in damage to the cable, and continued mobility of restrained animal.



Figure 35. Entanglement comes in several forms including fences, trees, rocks, and logs.

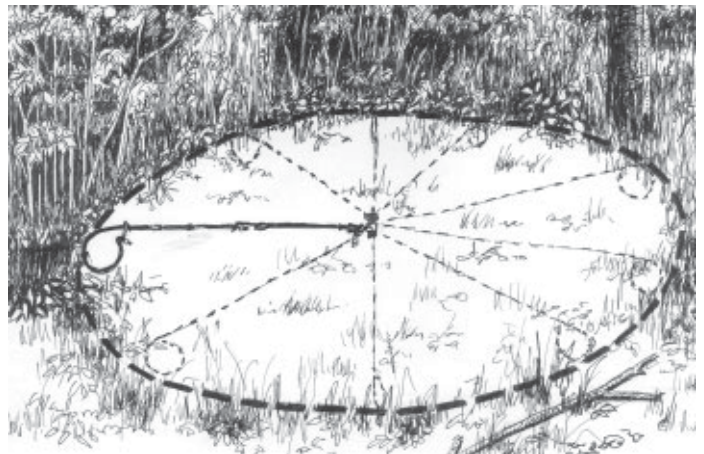


Figure 36. Restraint Circle: Although over-simplified, this is the mental image a person needs to remember when making a cable restraint set. Watch for all possible risks of entanglement.



Figure 37. Respect a landowners needs and avoid making any sets where there is considerable activity. Buildings, cattle, fences, gates and machinery are a few examples.



## The Future of Cable Restraints—It's Your Call!

The future of cable restraints belongs to you! Responsible and ethical use of cable restraints on land is totally your call. When you make sets, rarely is anyone looking over your shoulder. Your decisions at each and every set will depend on your level of ethics and responsibility and will set the stage for your future. You need to know the rules and regulations; have landowner permission; know the land you're on well; and make sets where deer and domestics are a minor concern.

It's your responsibility to set loops so they target only mid-sized canines (coyotes and foxes), and that any restrained animals cannot entangle. It's your responsibility to make every effort to release incidentals carefully, and if a dog is caught, to contact the owner. It's your responsibility to collect all restraint systems when the season ends. And it will be your call to take pride in the results of using these superb tools in a responsible and ethical manner.

The learning curve is going to be nearly vertical! In just three years we've had novice cable restraint trappers go from 2-3 coyotes the first year, to more than 30 the last year. As most folks know, trappers are some of our best field naturalists and observers, as their skills and success are dependent upon keen observation. With the availability of cable restraints during the latter portion of our existing canine season, you will have the opportunity to continue trapping when most folks have gone home. Late season trapping will open a whole new world of animal

sign, animal behavior, and harvest technique that have until now been unavailable here in Wisconsin. Take the opportunity and enjoy.

One last, important suggestion. Try and learn more about cable restraints. Our statewide Wisconsin Cooperative Trapper Education program will continue to teach and train new and veteran trappers the latest discoveries in trapping. Volunteer instructors, all members of The Wisconsin Trappers Association, will teach cable restraint use in all classes. You can also expect to see trap demonstrations at all eleven WTA district meetings and at the annual fall WTA Rendezvous.

For greater detail and more in-depth knowledge about canines and the use of cable restraints we recommend you consider securing copies of the following publications: *DYNAMITE Snares and Snaring*, by Tom Krause, 3200 Lewis Road; Riverton, WY 82501 (307) 856-3830 or the *Ohio Snaring Guide* by Hal Sullivan and the Ohio State Trappers Association, 14001 Stanwood, Navarre, Ohio 44662.

For further information and to keep up to date on regulations, pick up a copy of the Wisconsin Trapping Regulations available annually in September at all WDNR Service Centers. For further information on trapper education contact the WDNR Furbearer Assistant at 608-261-6452 or check the website at: [www.dnr.state.wi.us/org/land/wildlife/trap/index.htm](http://www.dnr.state.wi.us/org/land/wildlife/trap/index.htm). For further information on the WTA check their website at [www.wistrap.org/](http://www.wistrap.org/).

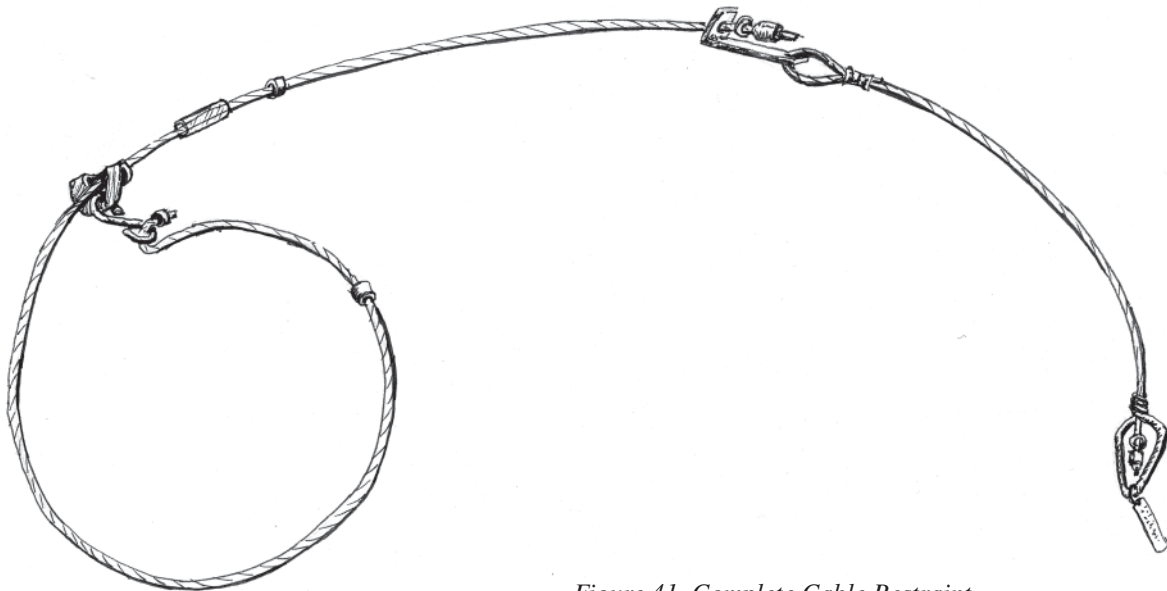
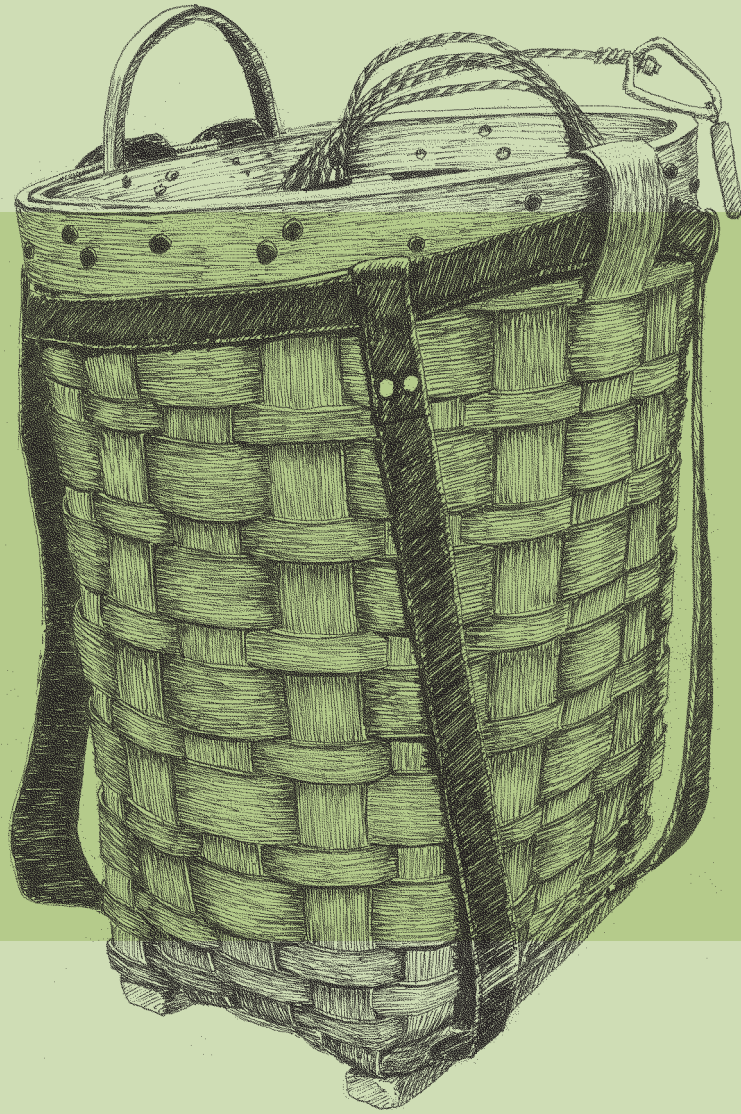


Figure 41. Complete Cable Restraint



Wisconsin Department of Natural Resources  
P.O. Box 7921  
Madison, WI 53707

PUB-WM-443 2004