

Cast Stone Catalog



**The Ark – Concrete Specialties, Inc.**

**713.695.2001**

**Fax: 713.692.6803**

**[www.arkconcrete.com](http://www.arkconcrete.com)**

**713 Lehman St  
Houston, Texas 77018**

**GHBA member since 1998**



**Aug. 2012**

# Cast Stone Product Index

<u>Product</u>	<u>Pg</u>	<u>Product</u>	<u>Pg</u>
Accent Blocks -----	1	Fireplace Over Mantels-----	47
Address Blocks-----	2	Headers & Mantels -----	48
Address Markers-----	3	Keystones -----	52
Balustrades -----	4	Pier Caps – Square -----	53
Balustrades Base and Rail -----	5	Pier Caps – Rectangular -----	59
Balustrade Terminal Posts -----	6	Pool Coping -----	62
Columns Tapered -----	7	Sign Panels - Square Corner -----	63
Columns Base & Cap - Tapered --	8	Sign Panels - Beveled Edges -----	65
Columns Straight and Rope -----	9	Sign Panels – Designer -----	66
Column Base and Caps -----	10	Stars -----	67
Columns Base & Caps–Pilasters ---	11	Vent Blocks -----	68
Commercial- Planter-Bollards -----	12	Wall Caps -----	69
Corbels -----	13	Water Table -----	72
Crown Molding & Bracket -----	14	Windowsills -----	74
Entry Surrounds -----	15	Window Surrounds -----	76
Fireplaces -----	22		

# CAST STONE ACCENT BLOCKS

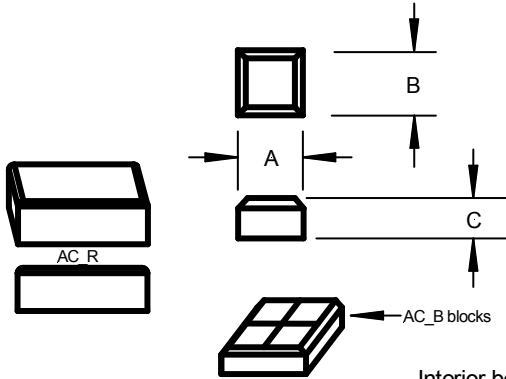

BEVELED ACCENT BLOCKS			
Item Number	'A'	'B'	'C'
AC18	18"	18"	4"
AC12	12"	12"	3.75"
AC9	9"	12"	3.75"
ACR	6.25"	12"	4"
AC8	8"	8"	4"
AC6	6"	6"	3.75"
AC12B	12"	12"	3.75"
AC8B	8"	8"	3.75"

Interior bevels are 1/2" on AC\_B items.

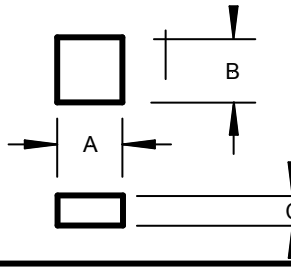

SQUARE ACCENT BLOCKS			
Item Number	'A'	'B'	'C'
AC12S	12"	12"	4"
AC10S	10.5"	12"	5"
AC24S	24"	24"	3.5"
AC30S	30"	30"	3.5"

## Recessed Accent Blocks

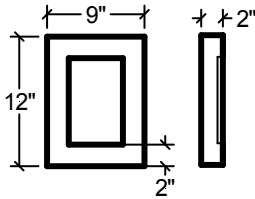

MED 01

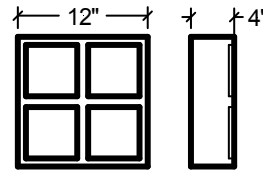

MOL 112906

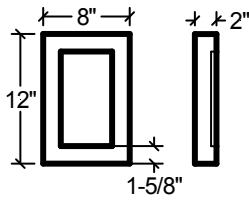

MED 02

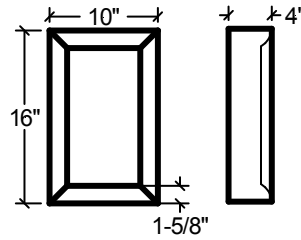

MED 03

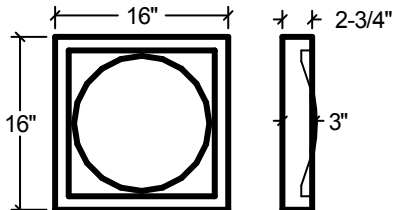

MED 04

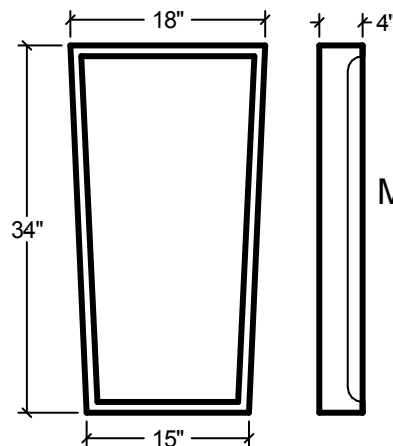

MED 05

# CAST STONE ADDRESS BLOCKS

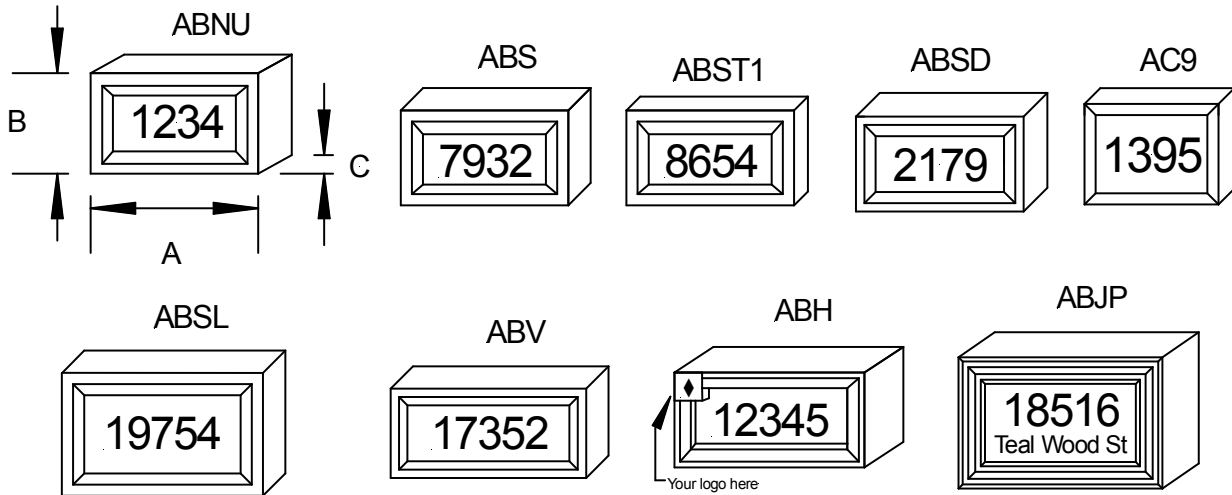

Beveled ADDRESS BLOCKS						
Item Code	'A'	'B'	'C'	Face Size	Number Size	Notes
ABH	17"	8.25"	3.5"	5.31" X 13.81"	3"	Wet pour only
ABJP	18.25"	11.75"	3.75"	6.88" X 13.38"	4"	Dry pack or wet pour
ABNU	14"	9"	3"	5.25" X 10.25"	3"	Dry pack only
ABS	14.5"	8.5"	3"	4.5" X 11"	3"	Dry pack or wet pour
ABSL	18"	11"	3.5"	6.38" X 12.75"	4"	Dry pack or wet pour
ABST1	15"	8.5"	2"	4.5" X 11"	3"	Dry pack or wet pour
ABV	17.5"	8"	3.75"	5.46" X 14.89"	3"	Dry pack only - red river
ABSD	15"	8.5"	3"	5" X 11.5"	4"	Dry pack or wet pour
AC9	12"	9"	2" or 3.5"	7" X 10"	4"	Dry pack or wet pour

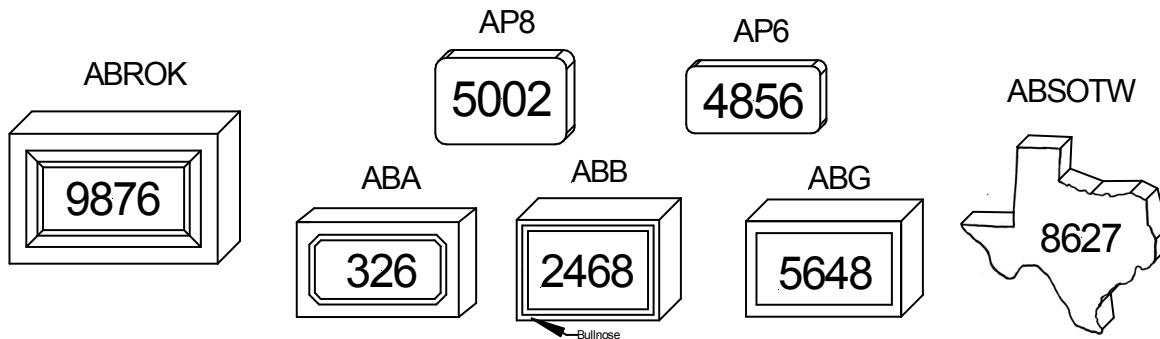

Non-Beveled & Specialty ADDRESS BLOCKS						
Item Code	'A'	'B'	'C'	Face Size	Number Size	Notes
ABG	14"	8.5"	3"	6.11" X 11.88"	4"	Dry pack or wet pour
ABROK	18 5/8"	11 5/8"	3"	6.88" X 13.38"	4"	Dry pack or wet pour
ABA	14.5"	8.5"	3"	5.25" X 11.25"	3"	Dry pack only
ABB	12.75"	9"	3"	7.25" X 10.75"	3"	Dry pack or wet pour
AP8	11.75"	7.75"	1"	11.75" X 7.75"	4"	Wet pour only
AP6	12"	6"	1"	6" X 12"	3"	Wet pour only
ABSOTW	18"	16.5"	1.5"	4" X 13"	3"	Dry pack or wet pour

# CAST STONE ADDRESS MARKERS

**FSAB-1**

325 lbs.

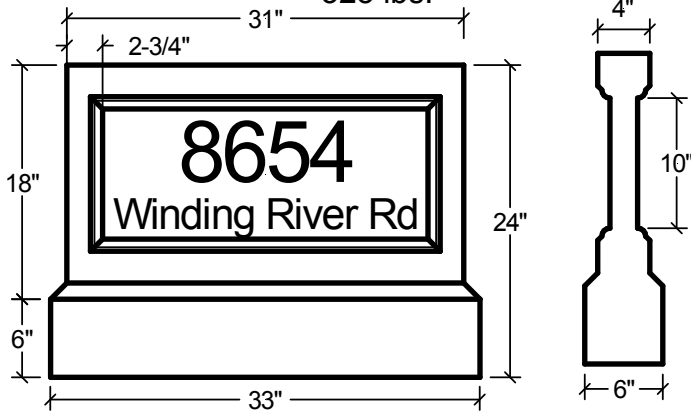

**FSAB - 2**

180 lbs.

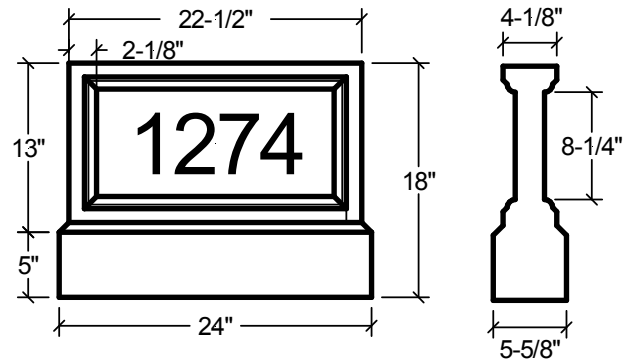

**FSAB - 3**

107 lbs.

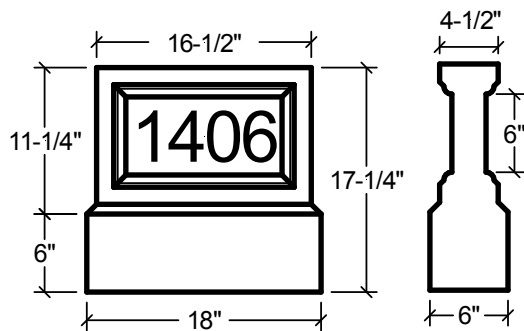

**FSAB - 4**

65 lbs.

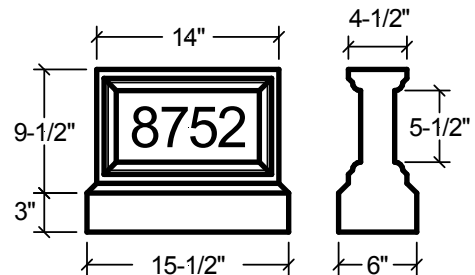

# CAST STONE BALUSTRADES

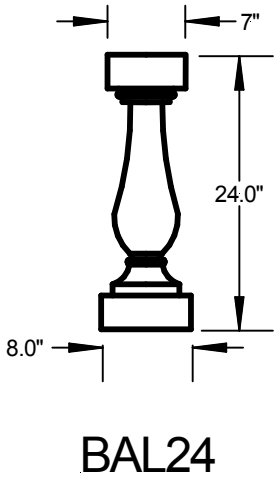
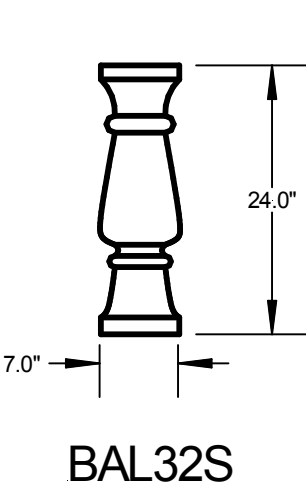
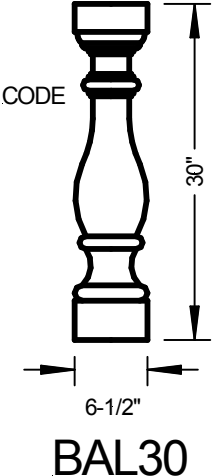
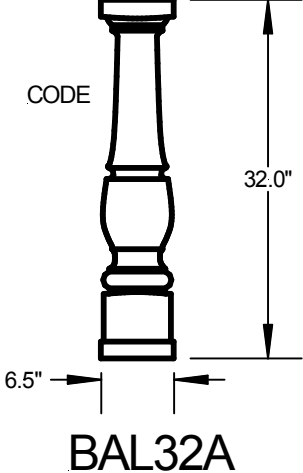
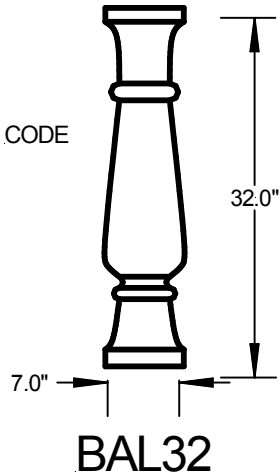

# CAST STONE BALUSTRADE BASE AND RAIL

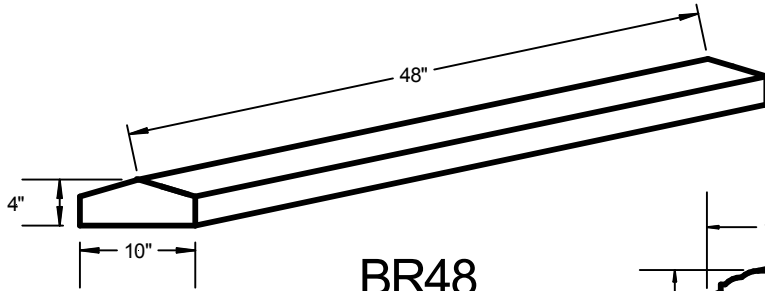

BR48

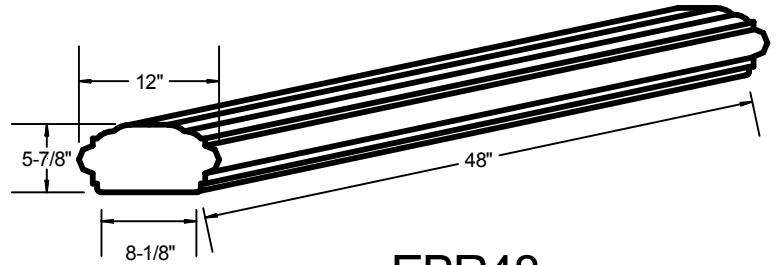

EBR48

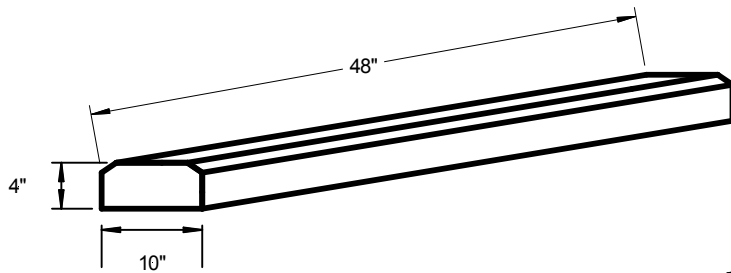

BSB01S

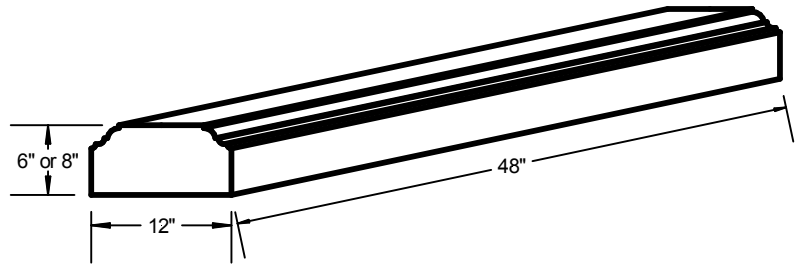

EBB48

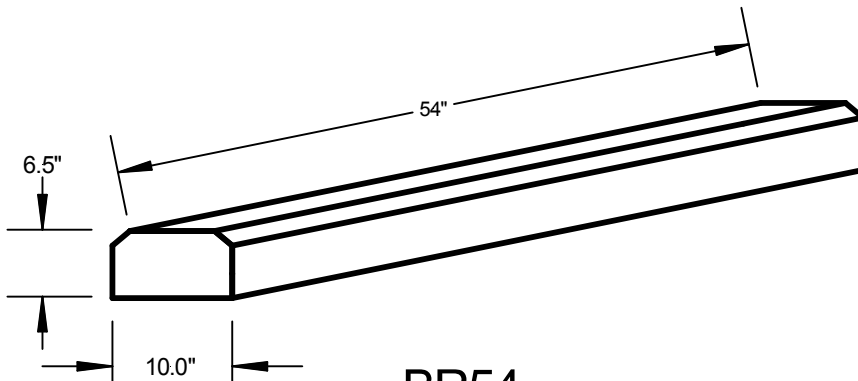

BR54

EBR48 and EBB48 also  
available in radius pieces;  
203 5/8" Radius  
1311 1/4" Radius

BR48, BSB01S and BR54  
also available in radius pieces;  
4' Radius  
7' Radius  
12' Radius  
19' Radius  
39' Radius

# CAST STONE BALUSTRADE TERMINAL POSTS

TC

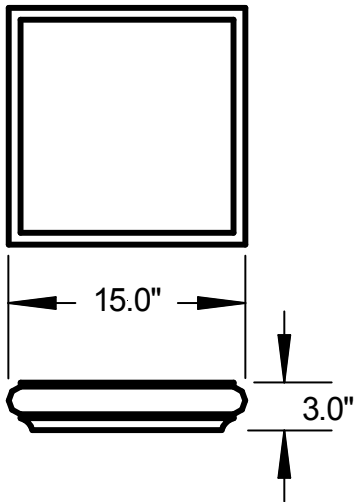

TCN

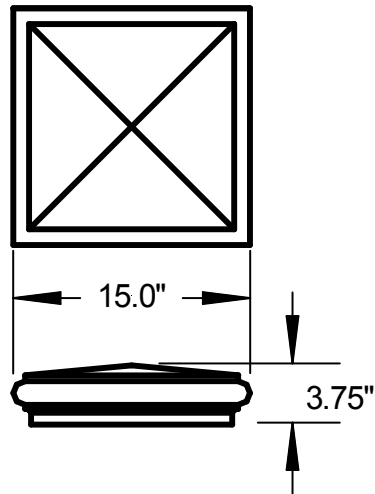

TCN - 14

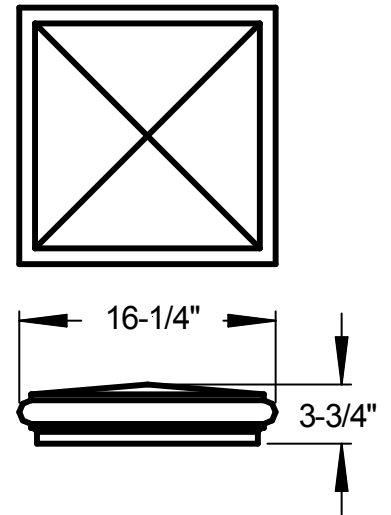

TB

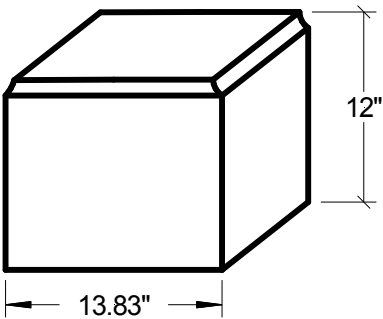

Variable height base  
for terminal base

TERM

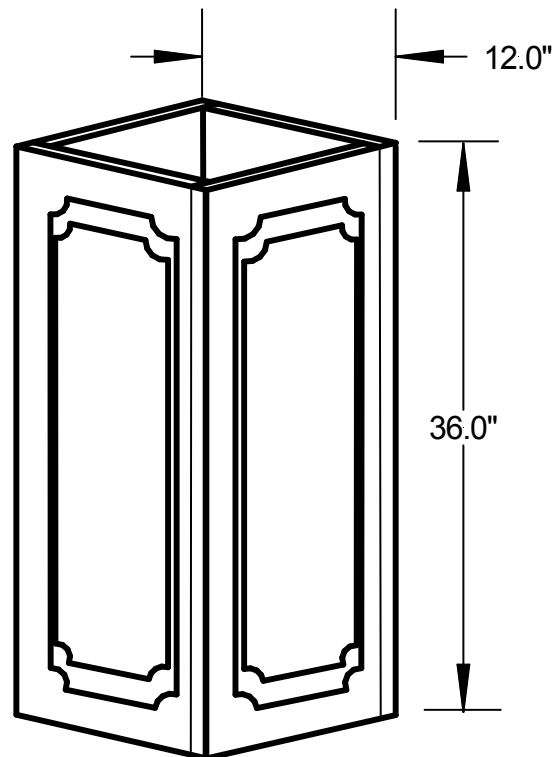



# CAST STONE COLUMNS TAPERED

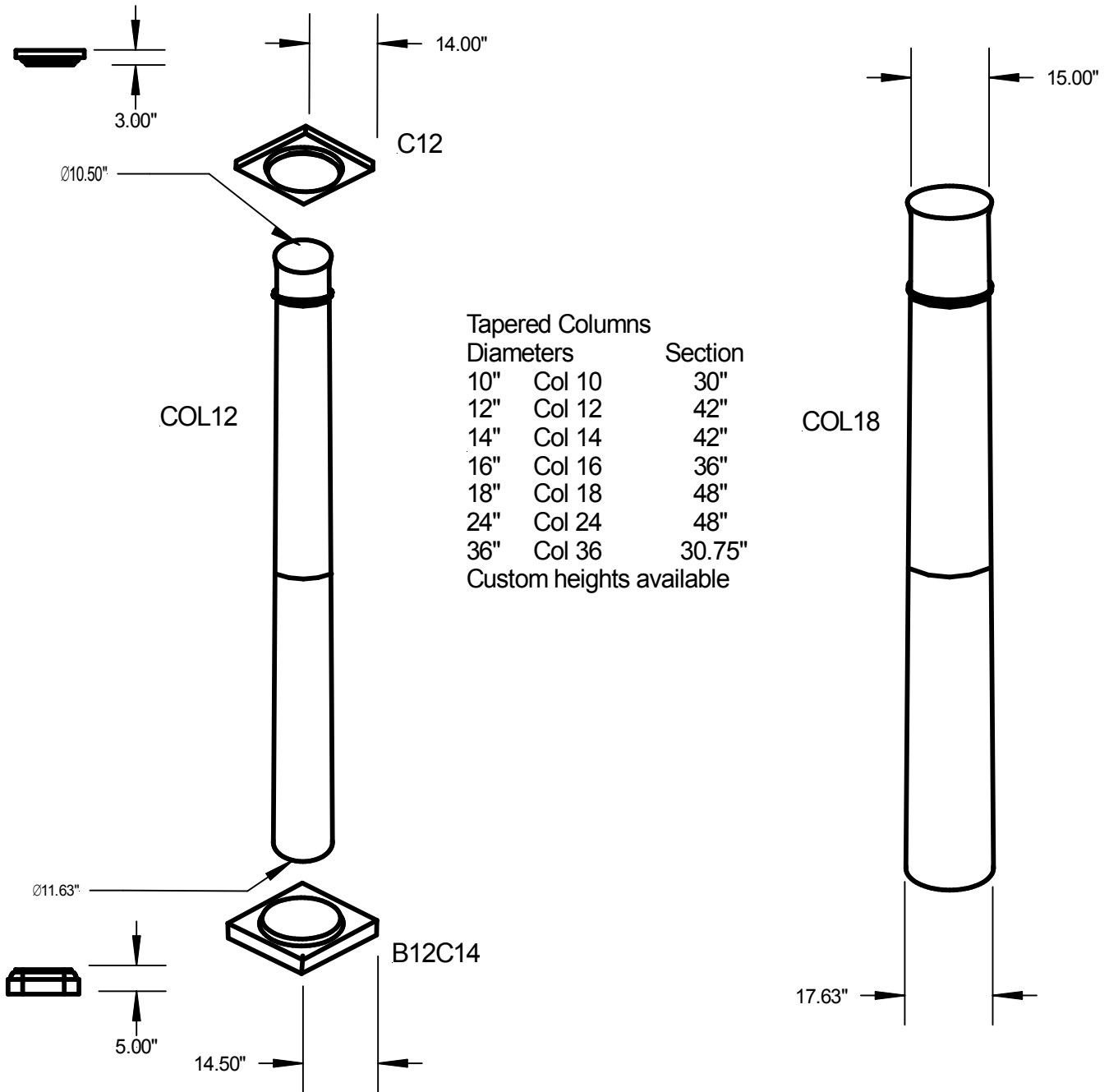

Not Shown: Base for 18" column 24.5"x24.5" with 5.5" height. Stock# B18

# CAST STONE COLUMNS BASE & CAP FOR TAPERED COLUMNS

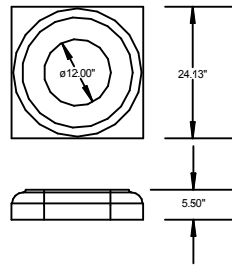
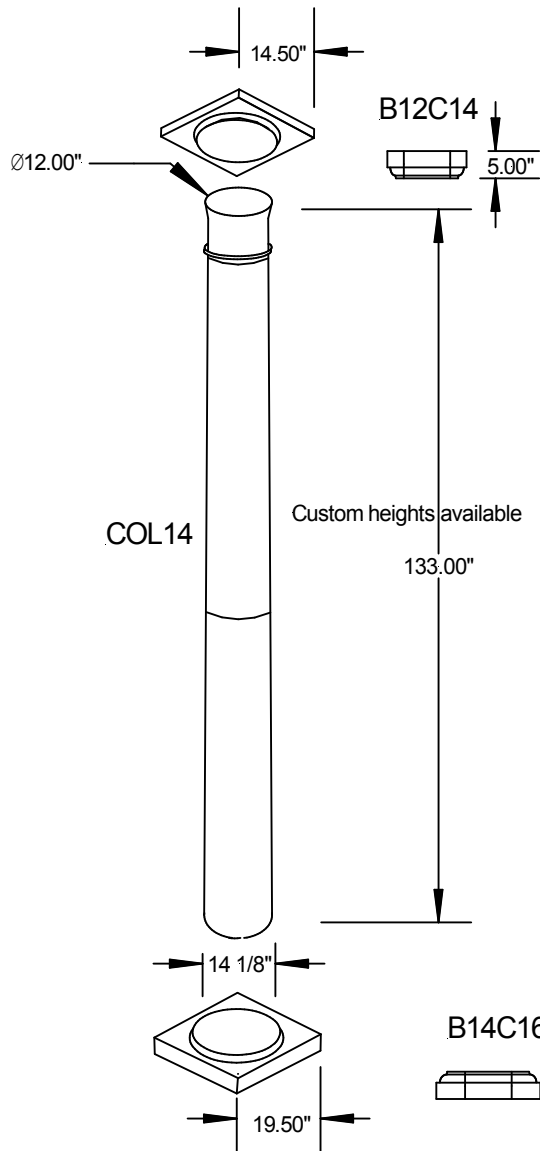

**B18**

Base for 18" column

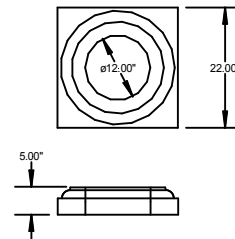

**B16C18**

Cap for 18" column and  
base for 16" column

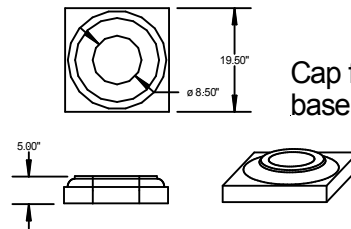

**B14C16**

Cap for 16" column and  
base for 14" column

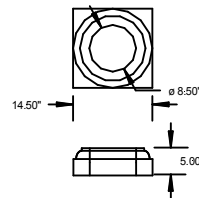

**B12C14**

Cap for 14" column and  
base for 12" column

**CB - 62408**  
Base for 12" column

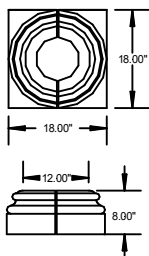

**CC - 62008**  
Cap for 12" column

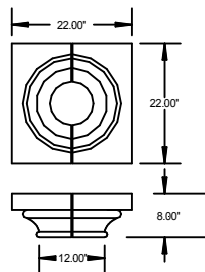

**B24**

Base for 24" Column

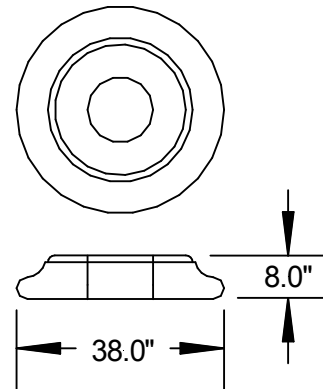

# CAST STONE COLUMNS

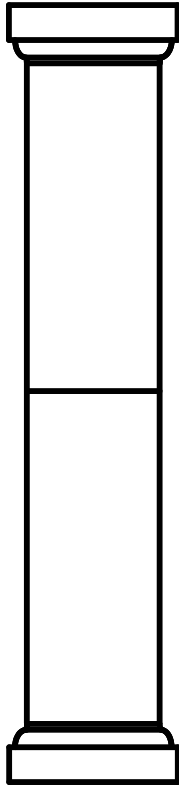

## Straight Columns:

### Available Diameters

8" Col S8

10" Col S10

12" Col S12

14" Col S14

16" Col S16

18" Col S18

24" Col S24

Standard Sections 48" tall

Col S10 section 42" tall

Custom heights available

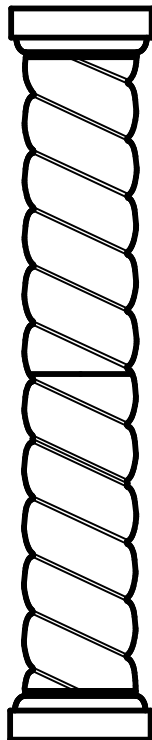

## Rope Columns:

10" Diameter - 46" Sections

16" Diameter - 42" Sections

Custom heights available

# CAST STONE COLUMN BASE and CAPS

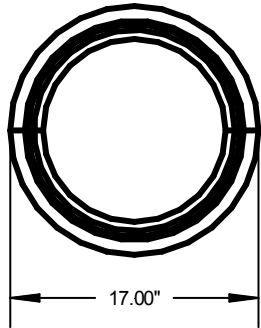

RB12

Round Base and Cap  
For 12 " Column  
In 2 Pieces

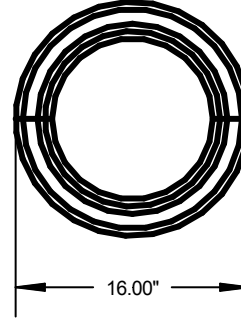

RC12

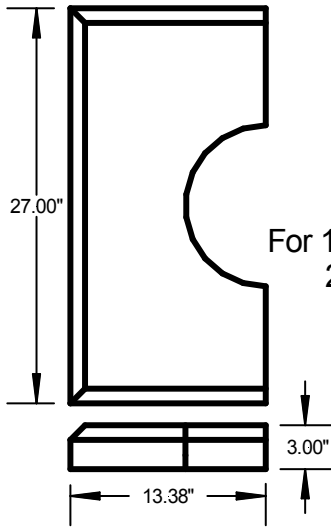

CR18  
Riser  
For 18 " Column  
2 Piece

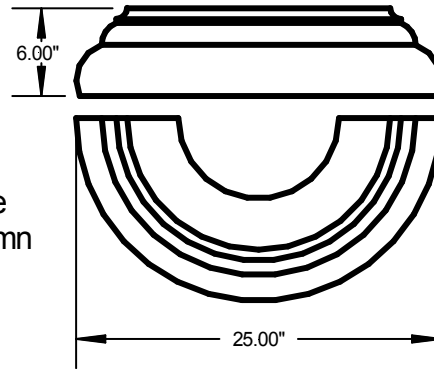

RB18  
Round Base  
For 18 " Column  
In 2 Pieces

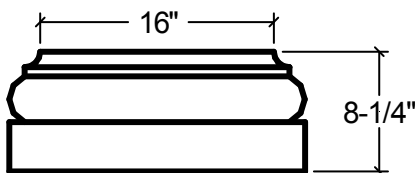

RB16T

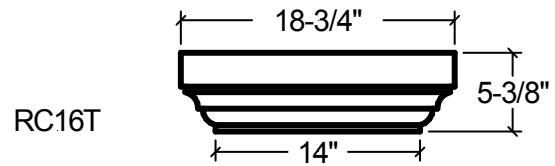

RC16T

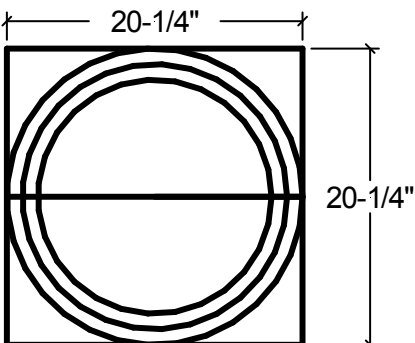

Base and Cap For  
16" Tapered Column

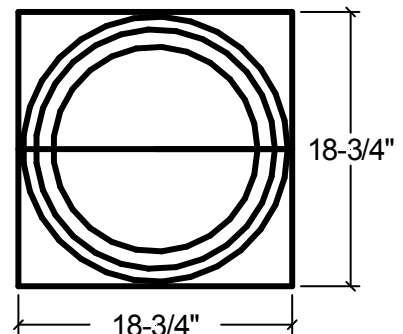

# CAST STONE COLUMN BASE and CAPS

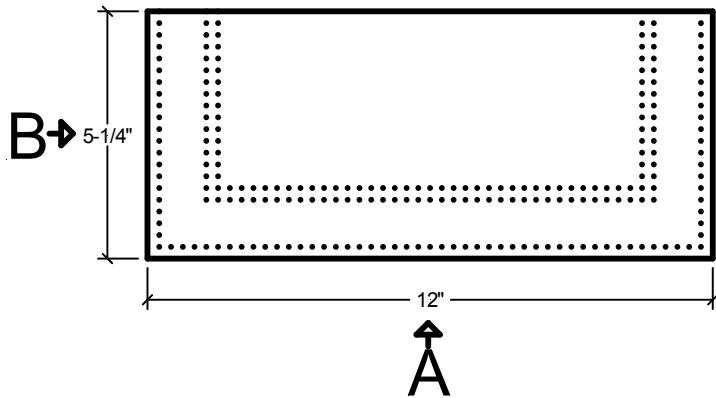

Pilaster Cap  
CS9

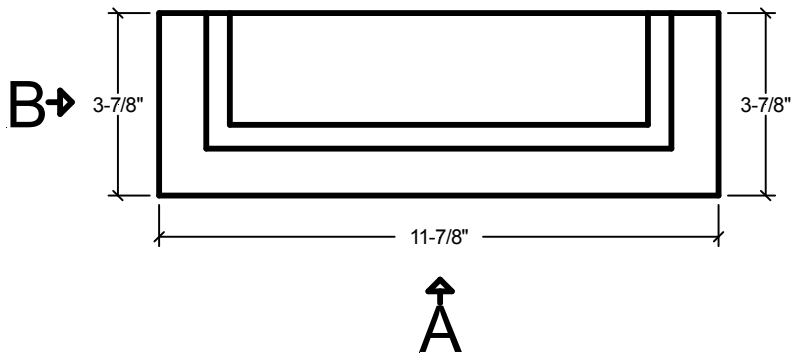
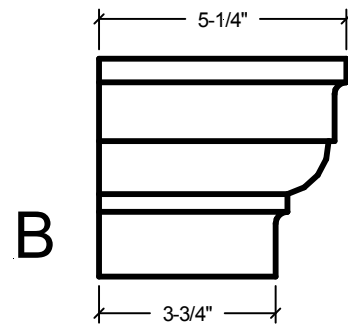
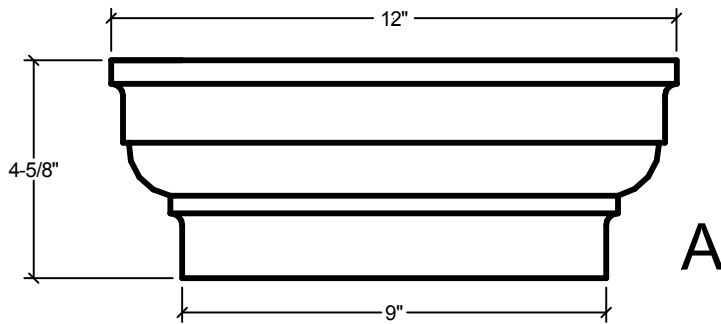

Pilaster Base  
BS12

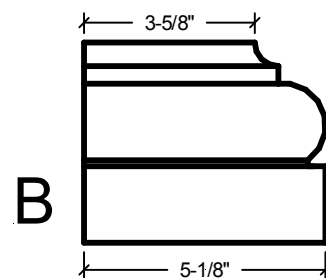
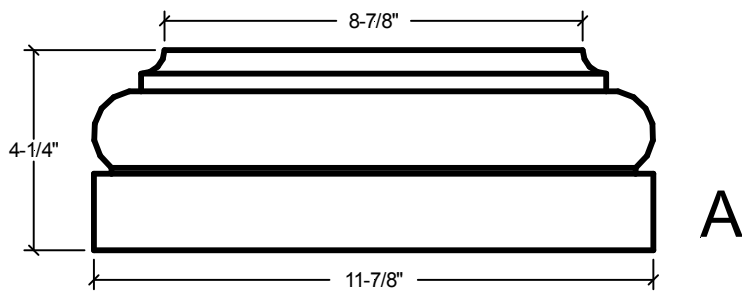

# CAST STONE COMMERCIAL PRODUCTS

Planter

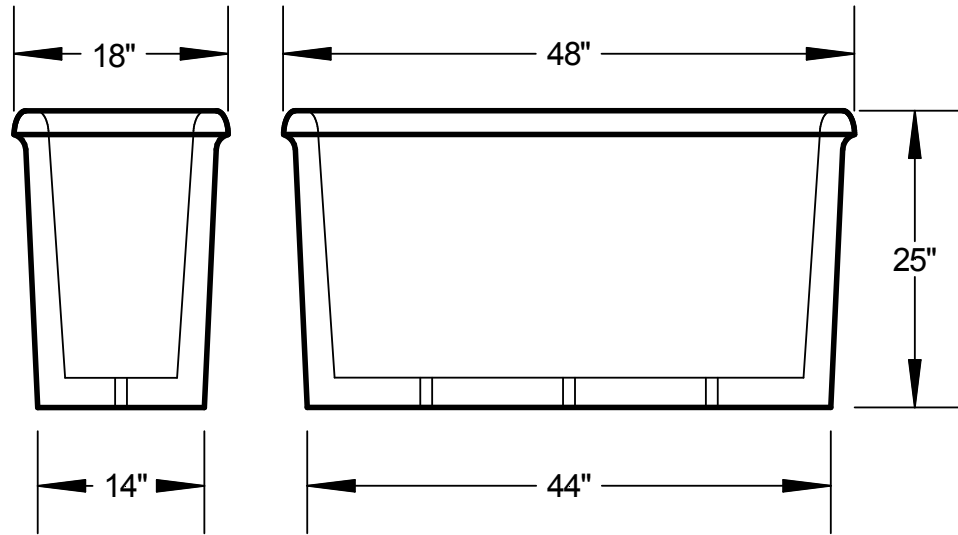

Bollards

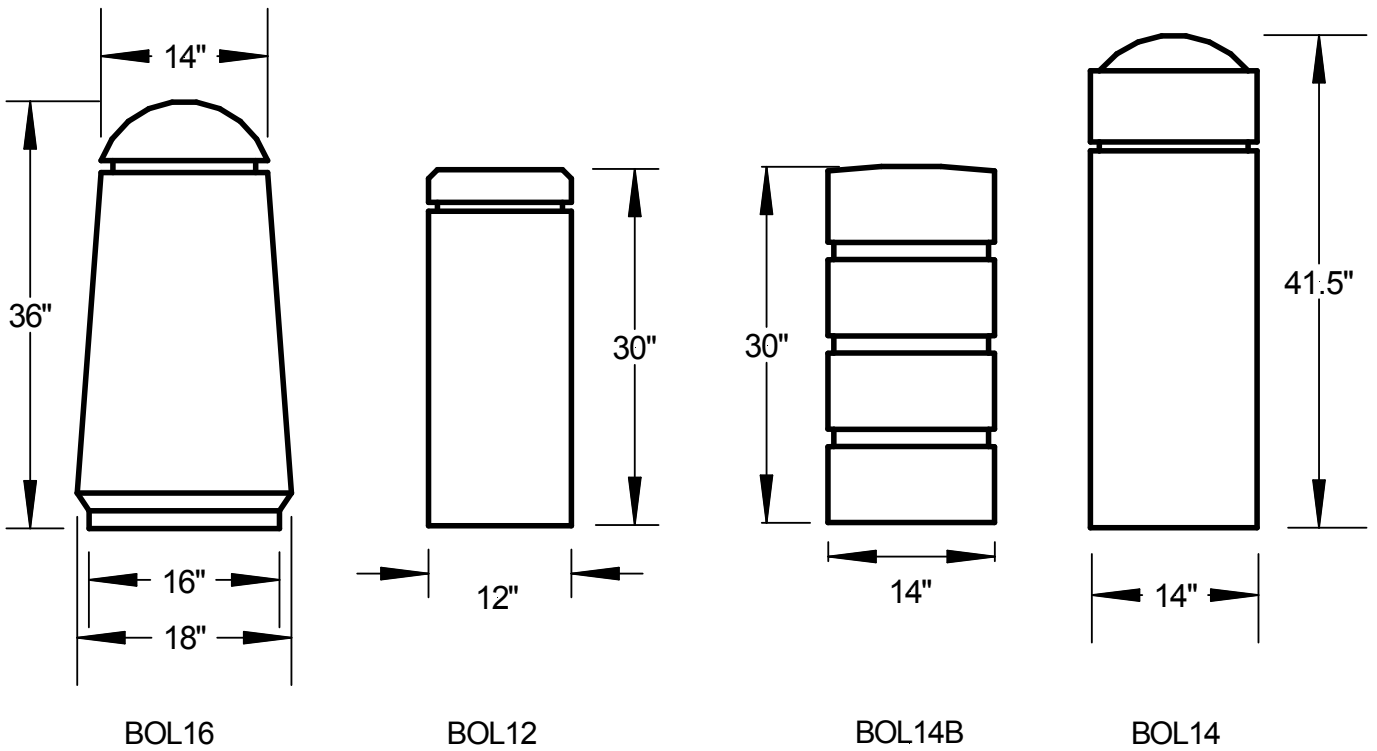

# CAST STONE CORBELS

CB1

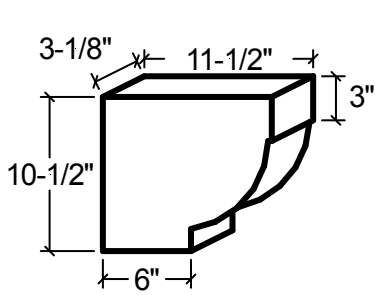

CB2

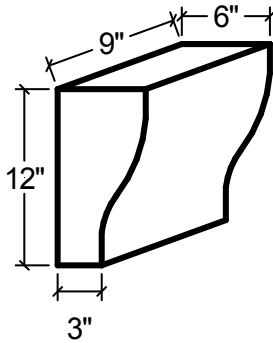

CB3

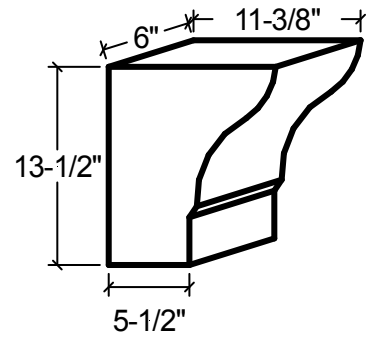

CB4

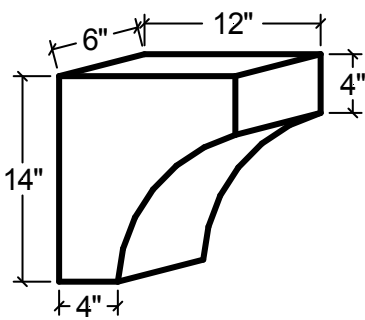

CB5

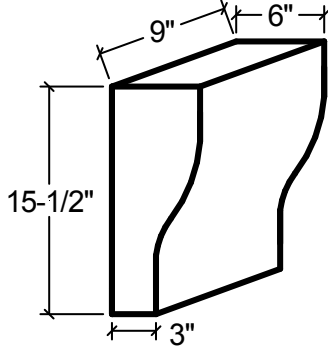

CB6

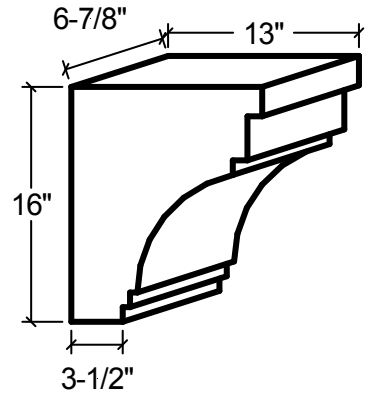

CB7

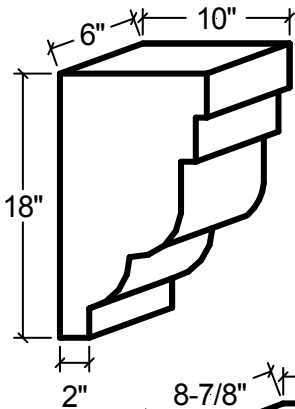

CB9

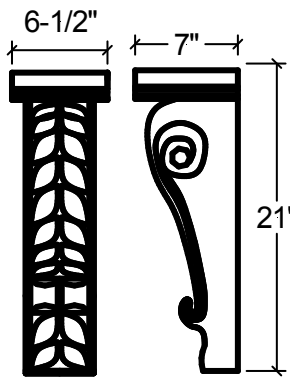

Drawing is approximate

CB10

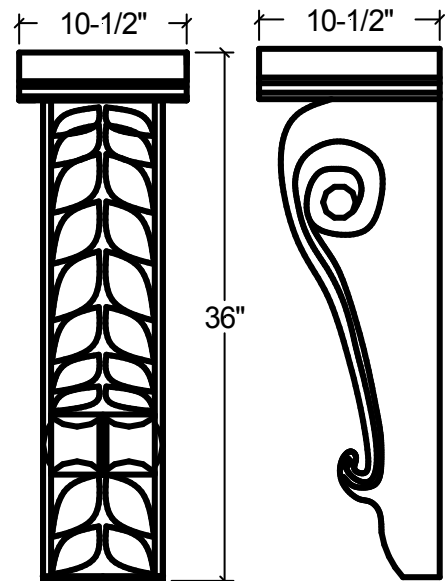

Drawing is approximate

CB8

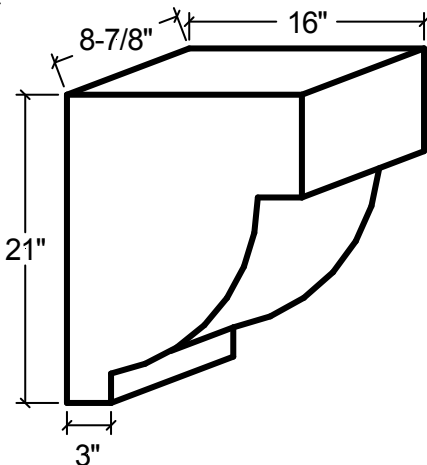

# CAST STONE CROWN MOLDING and BRACKET

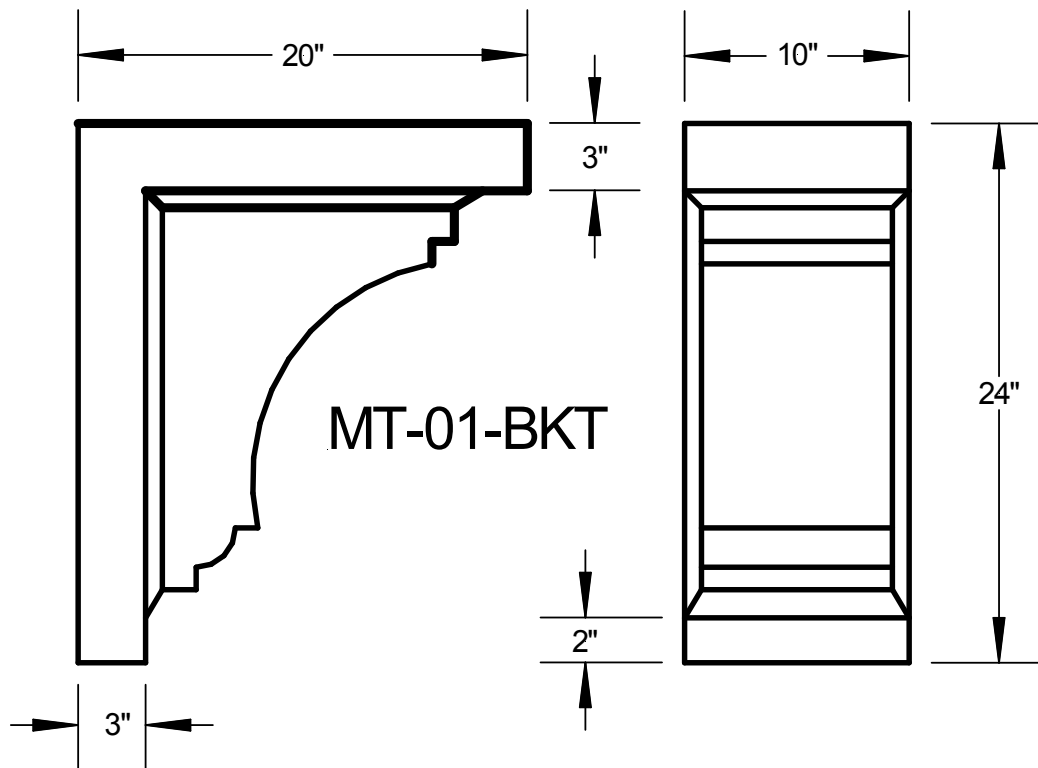
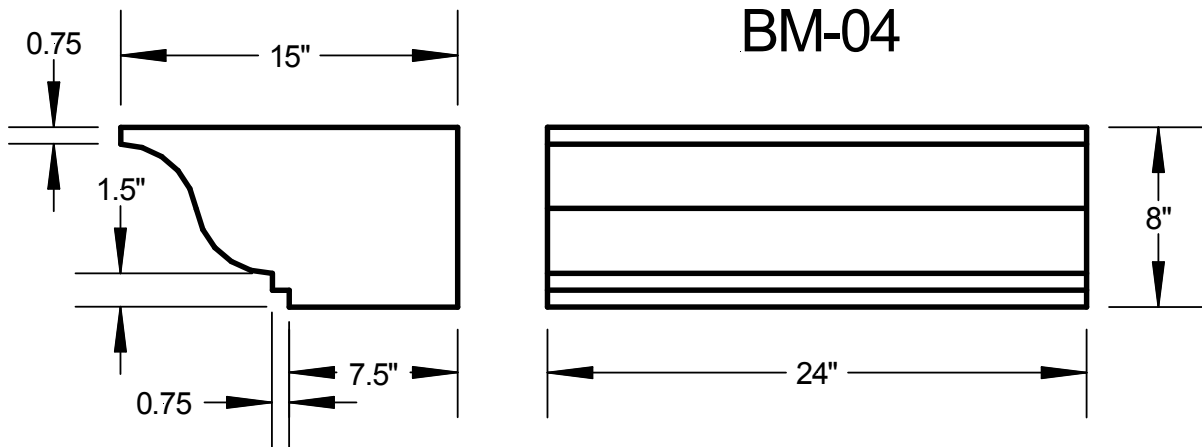



# CAST STONE ENTRY SURROUNDS

## ES - 01

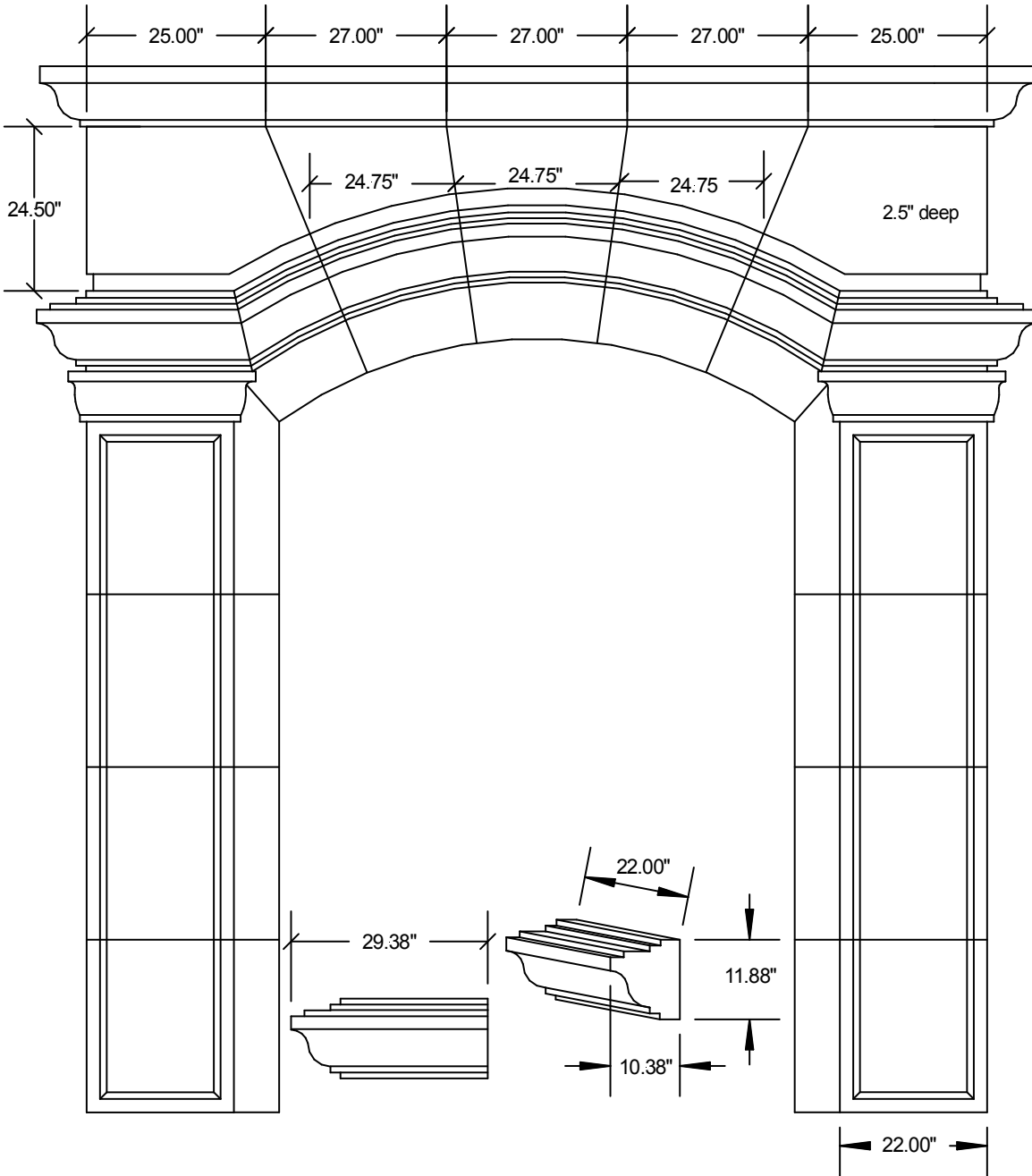

We can custom manufacture different size blocks for your needs.  
Call for pricing.

**The Ark Concrete Specialties, Inc. 713-695-2001**

Aug. 2012

# CAST STONE ENTRY SURROUNDS

## ES - 02

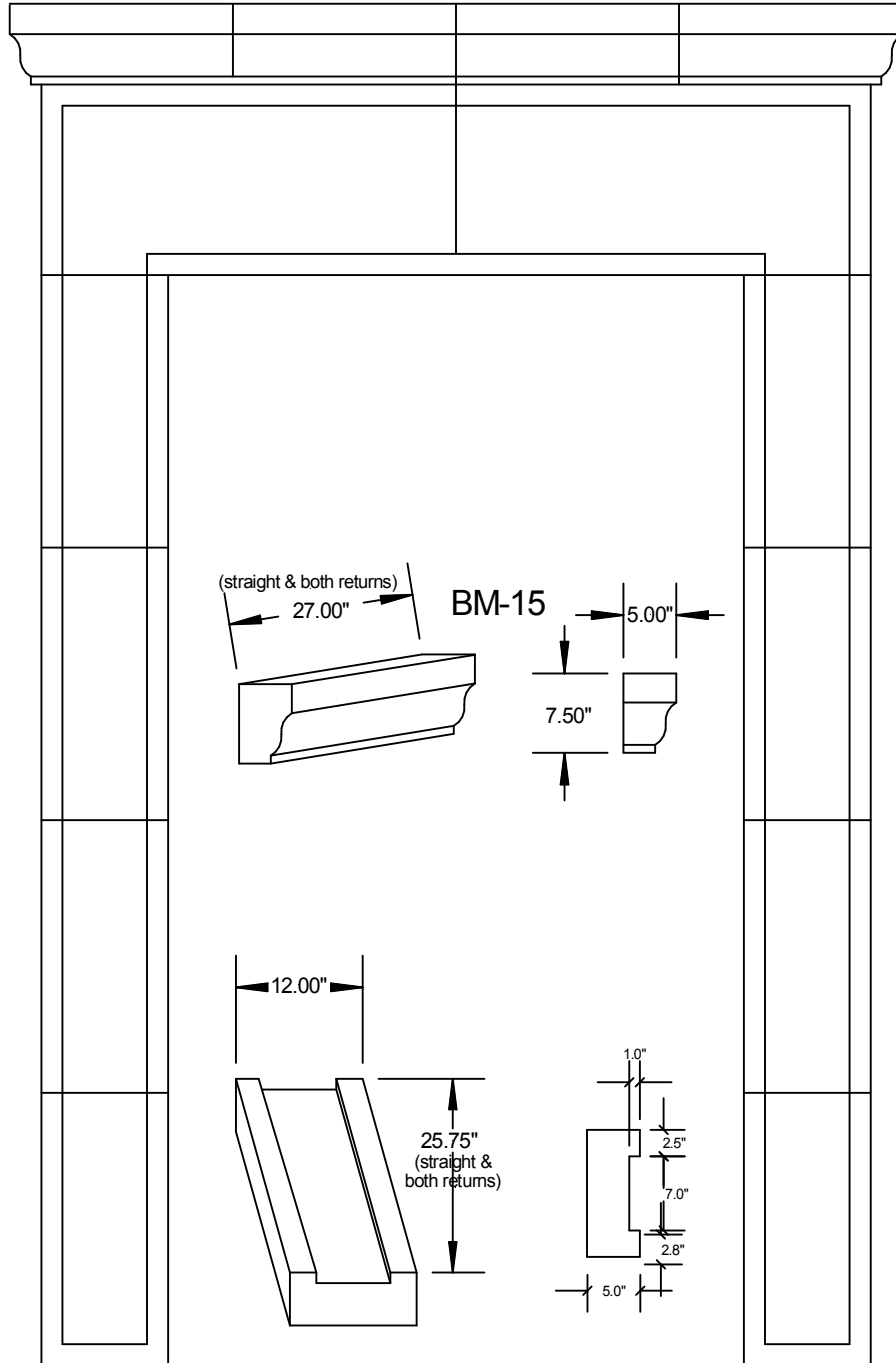

We can custom manufacture different size blocks for your needs. Maximum lengths shown on molds.  
Call for pricing.

# CAST STONE ENTRY SURROUNDS

ES - 03

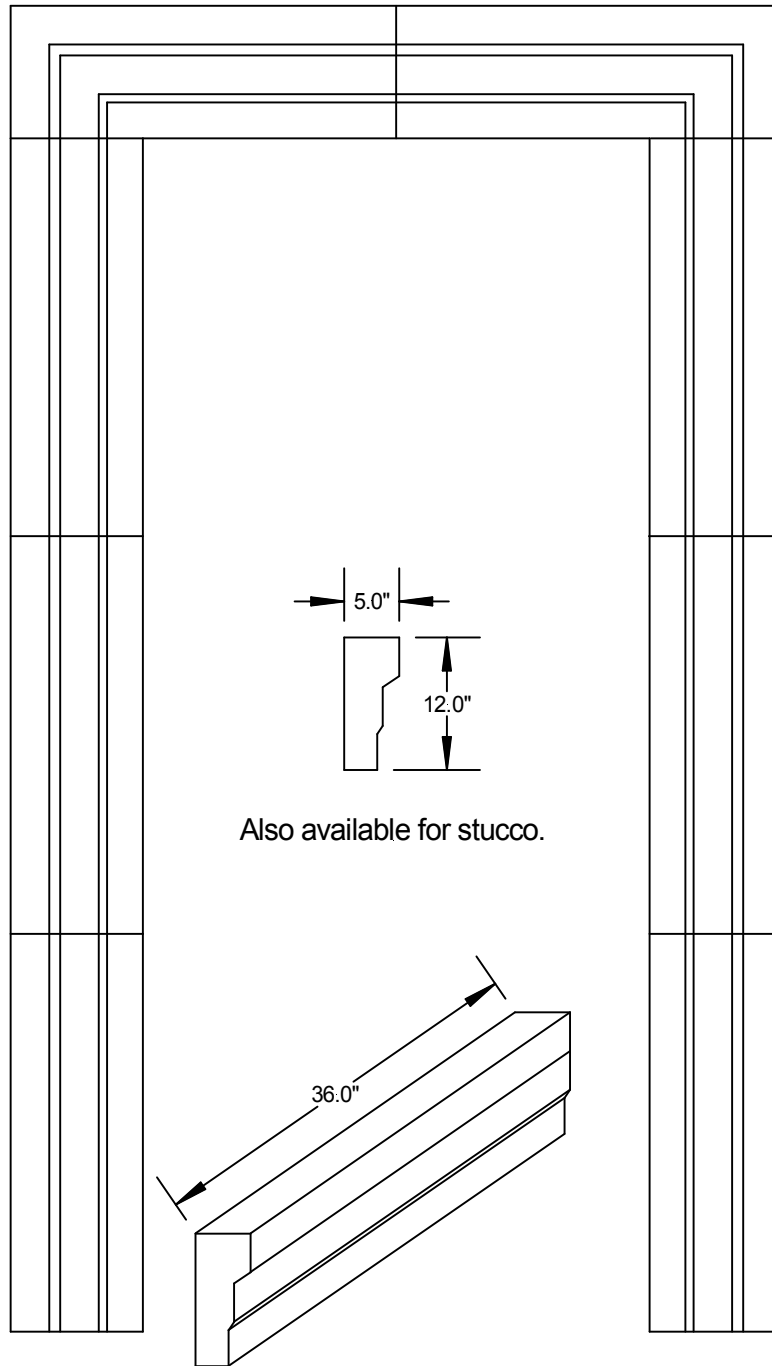

We can custom manufacture different size blocks for your needs.  
Call for pricing.

# CAST STONE ENTRY SURROUNDS

ES - 04

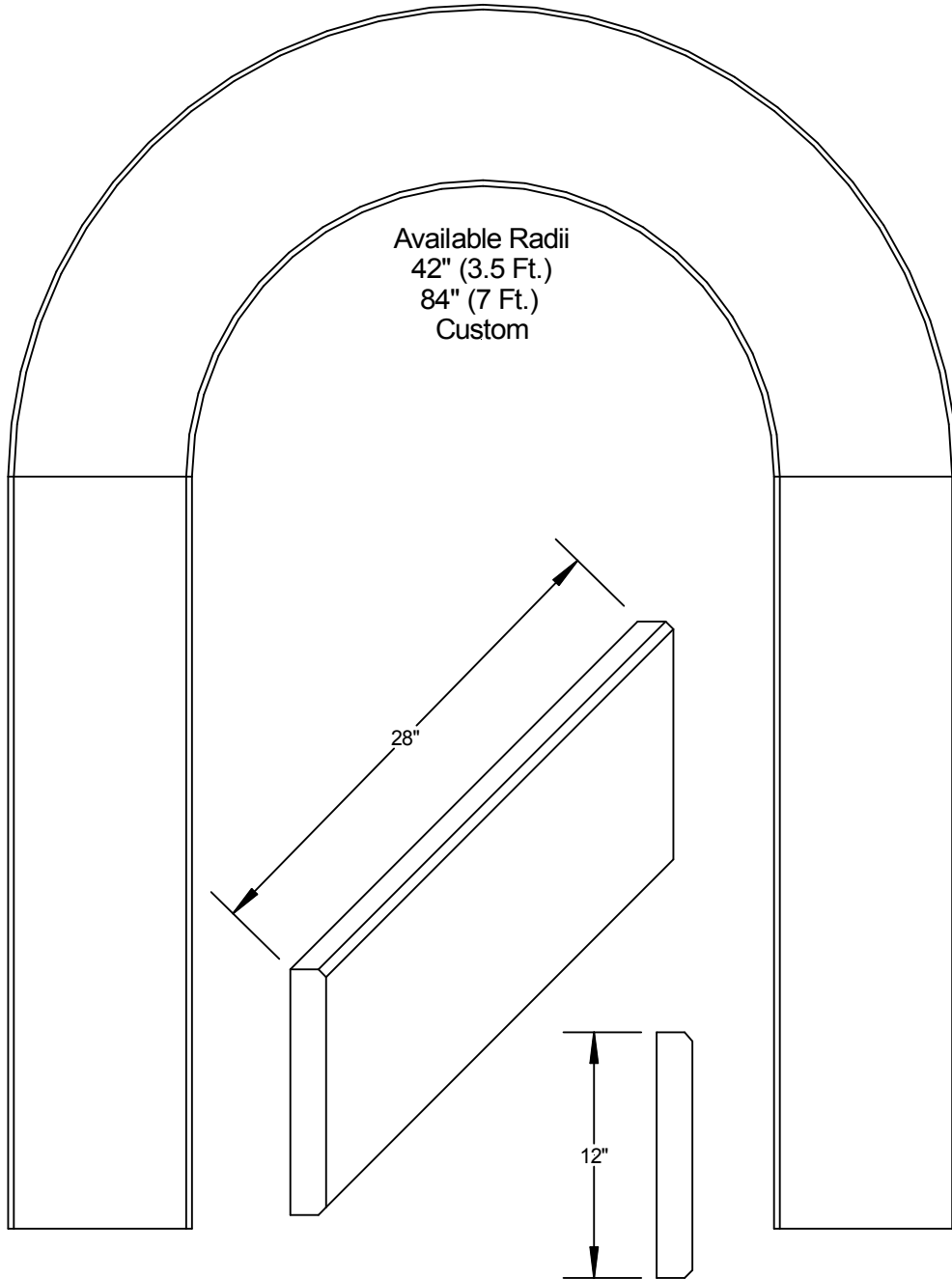

We can custom manufacture different size blocks for your needs.  
Call for pricing.

# CAST STONE ENTRY SURROUNDS

## ES-05

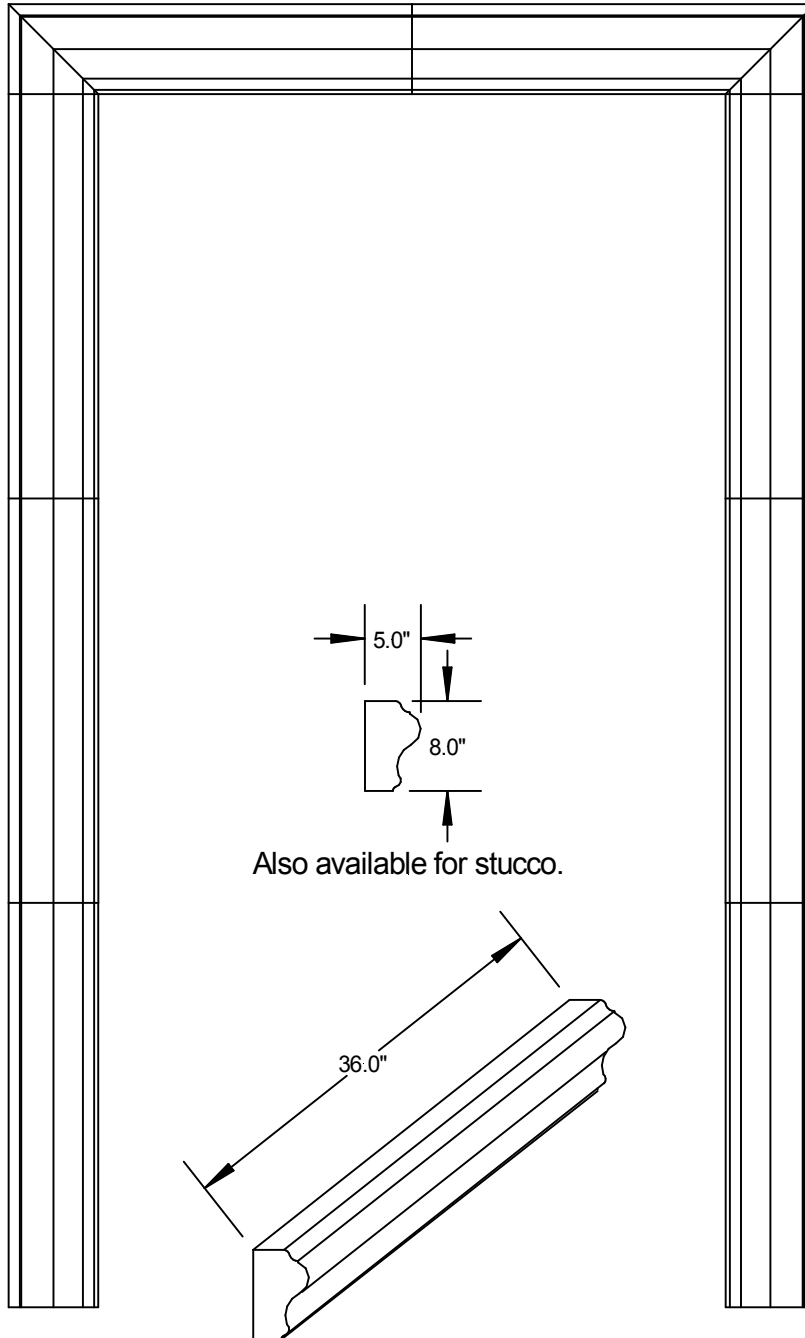

We can custom manufacture different size blocks for your needs.  
Call for pricing.

# CAST STONE ENTRY SURROUNDS

ES - 06

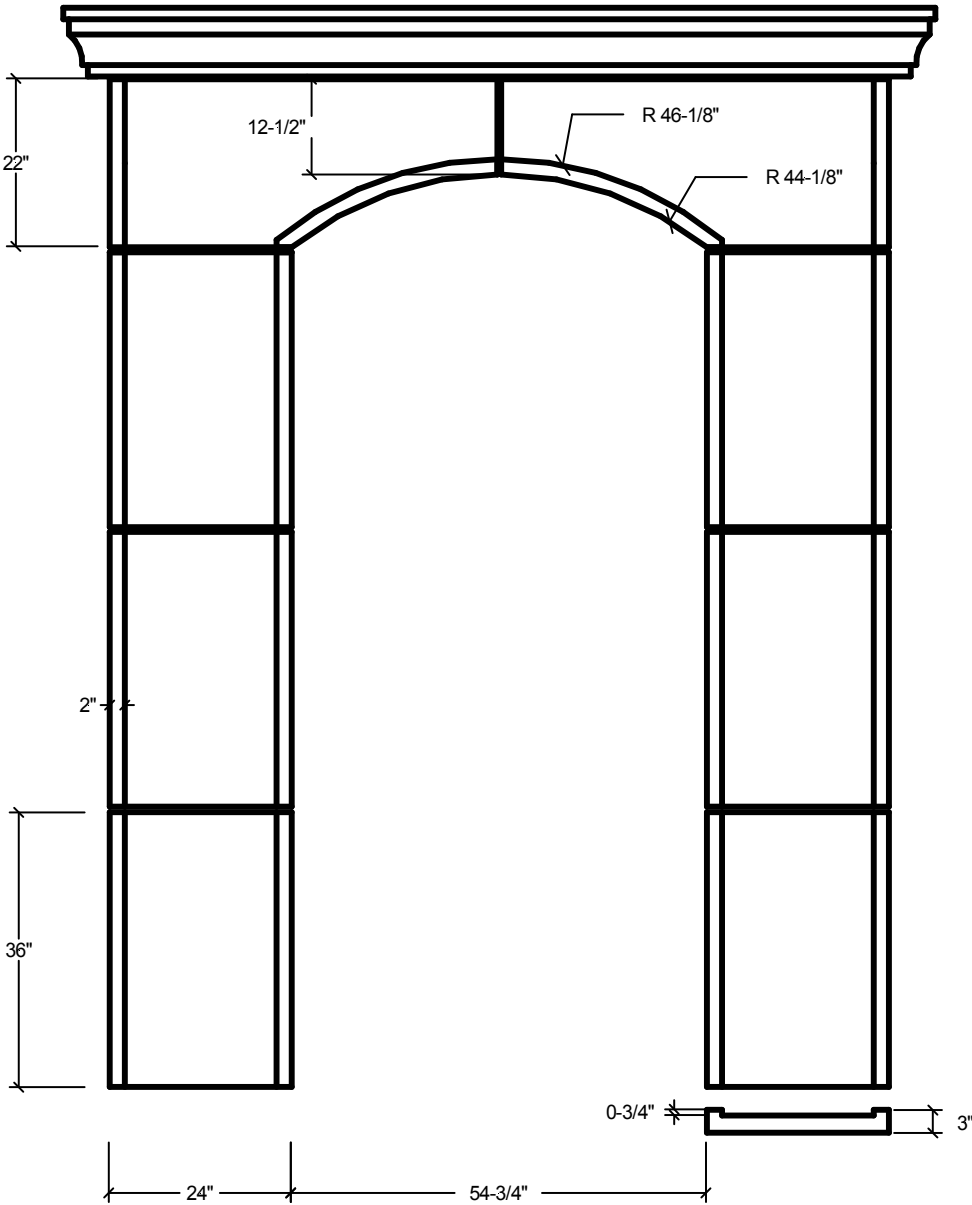

We can custom manufacture different size blocks for your needs.  
Call for pricing.

**The Ark Concrete Specialties, Inc. 713-695-2001**

Aug. 2012

# CAST STONE ENTRY SURROUNDS

## ES - 07

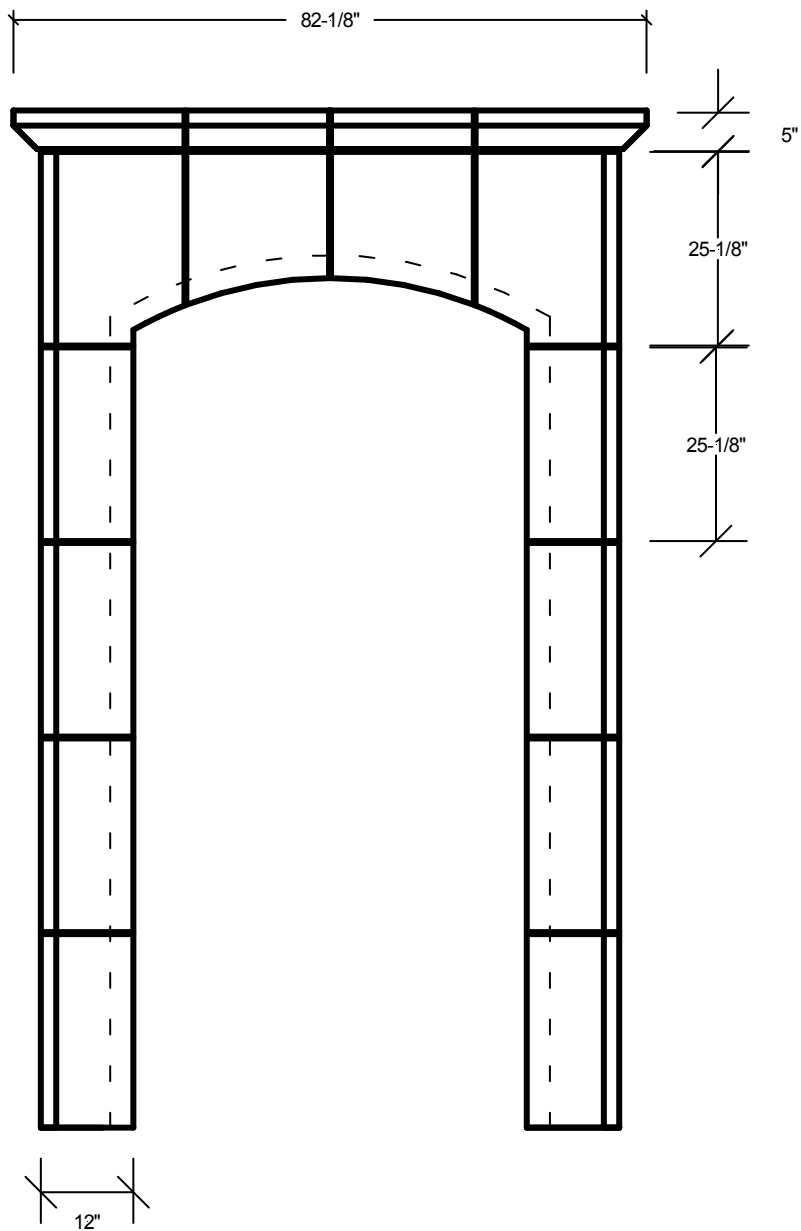

We can custom manufacture different size blocks for your needs.  
Call for pricing.

**The Ark Concrete Specialties, Inc. 713-695-2001**

Aug. 2012

# CAST STONE FIREPLACES

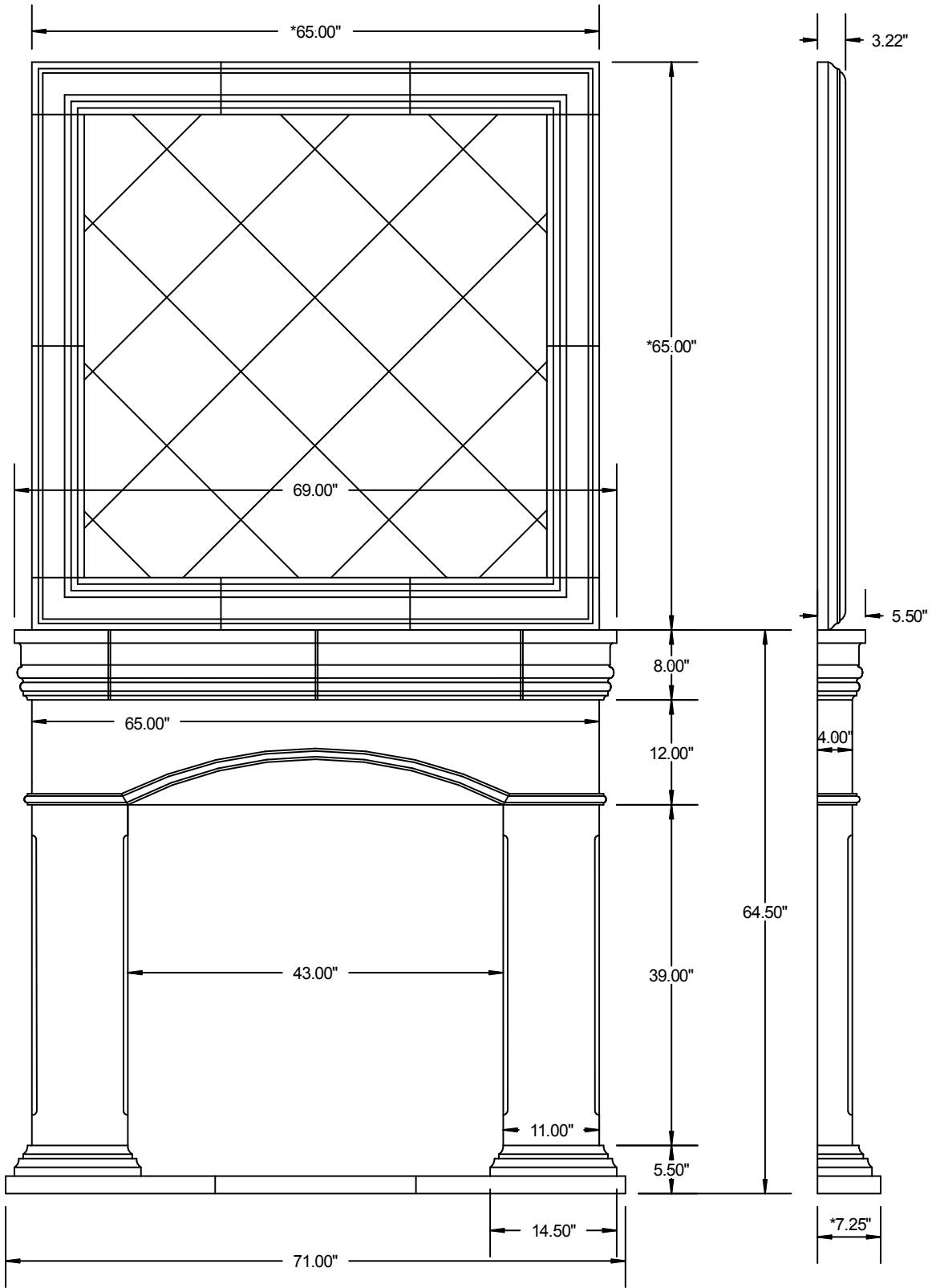

\* Adjustable

**FP - 1**

Cladding can be added to surround the firebox

**The Ark Concrete Specialties, Inc. 713-695-2001**

Aug. 2012



# CAST STONE FIREPLACES

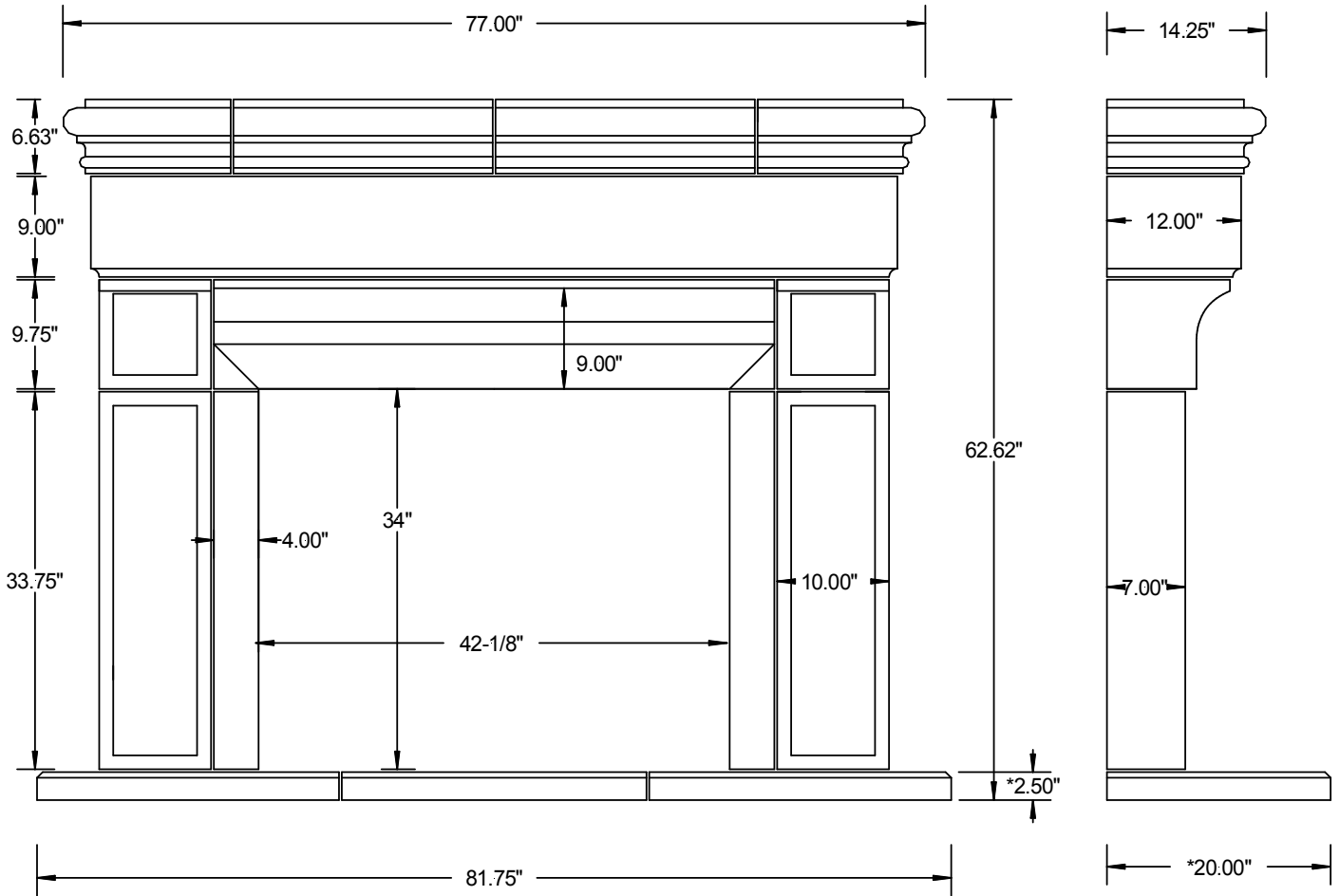

\* Adjustable

## FP-2

Cladding can be added to surround the firebox

# CAST STONE FIREPLACES

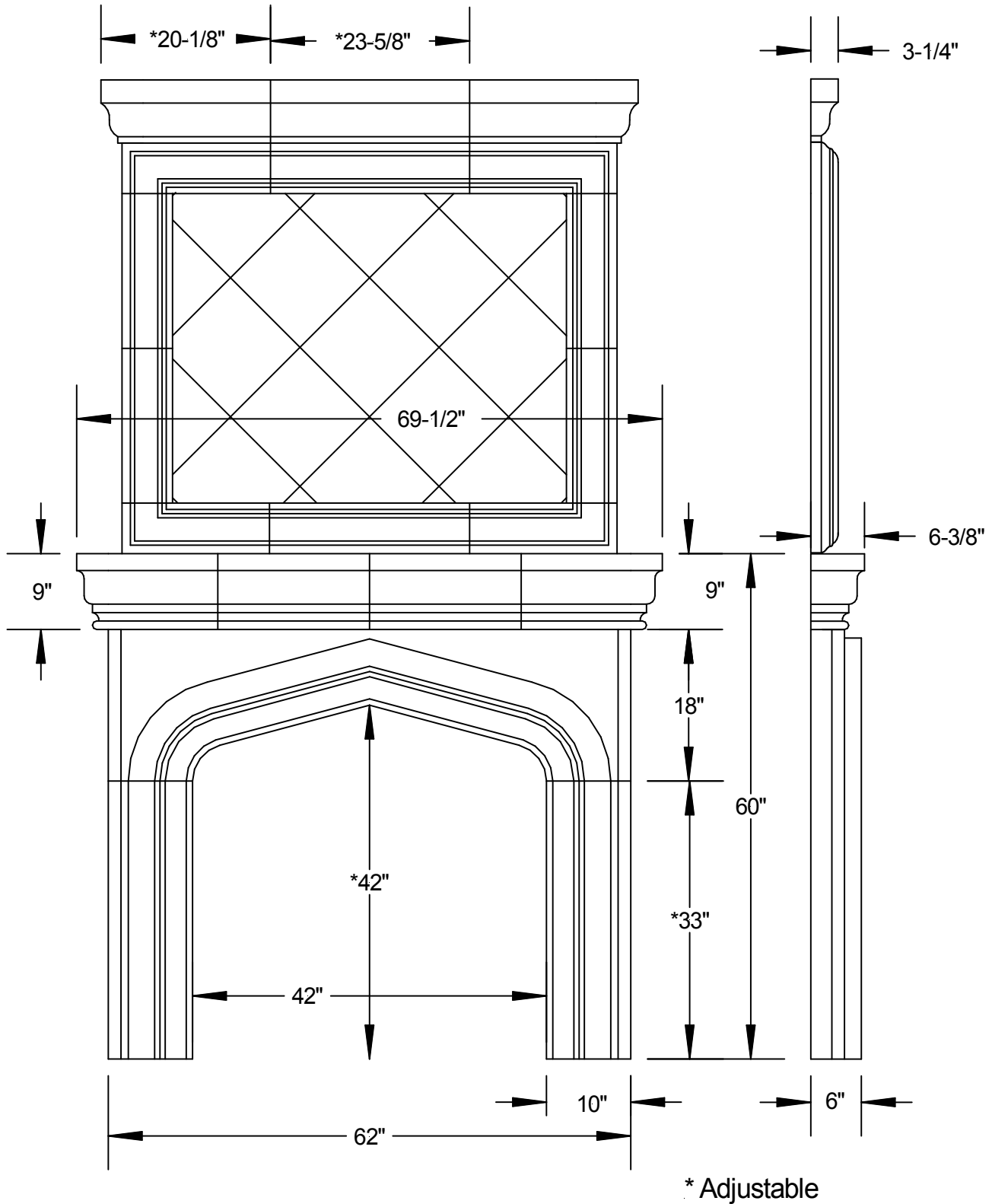

**FP - 3**

Cladding can be added to surround the firebox

# CAST STONE FIREPLACES

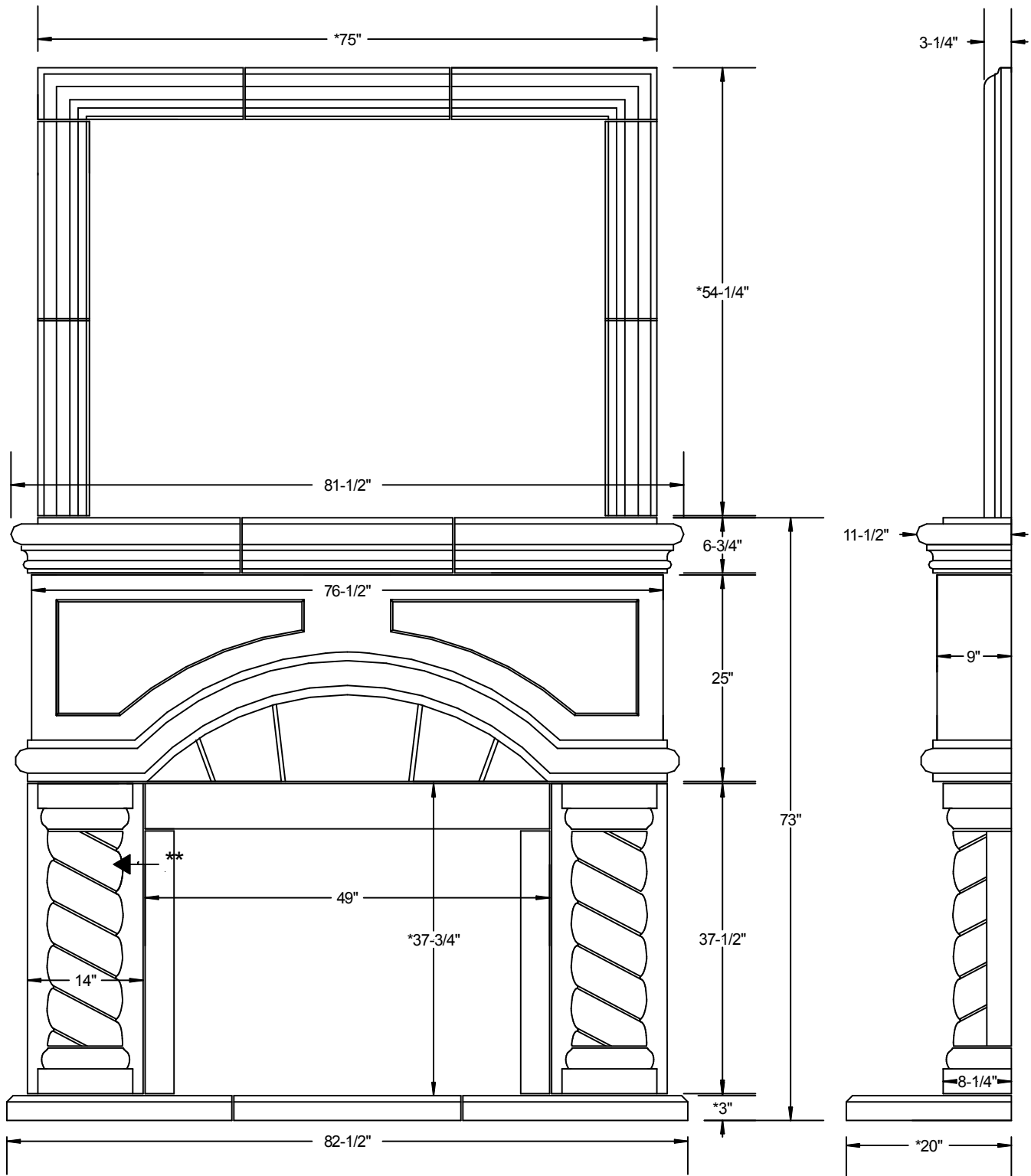

**FP - 4**

\*\*Option: straight or tapered columns

\* Adjustable

# CAST STONE FIREPLACES

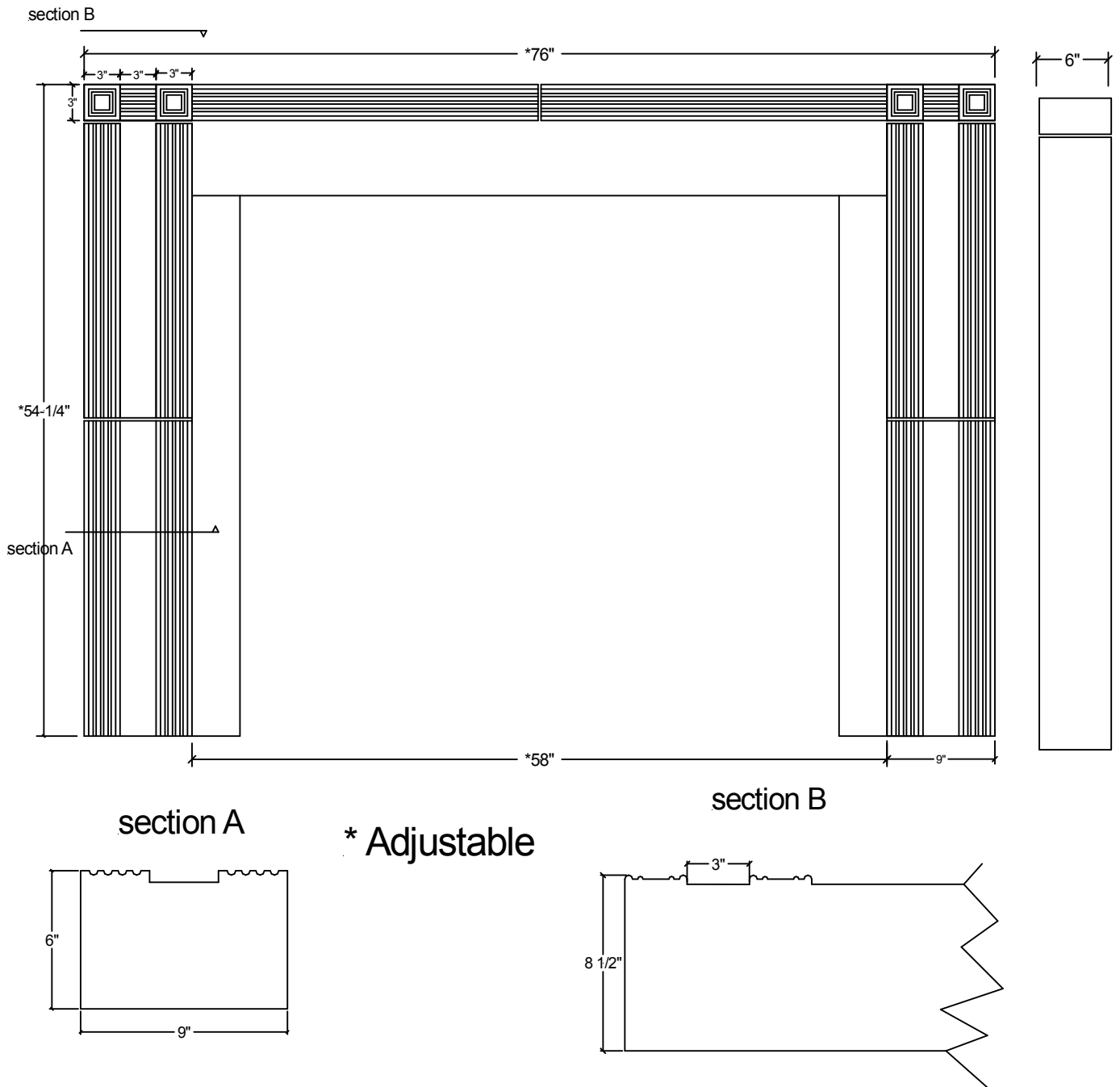

## FP - 5

Cladding can be added to surround the firebox

# CAST STONE FIREPLACES

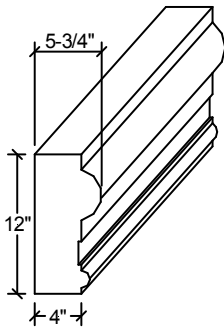
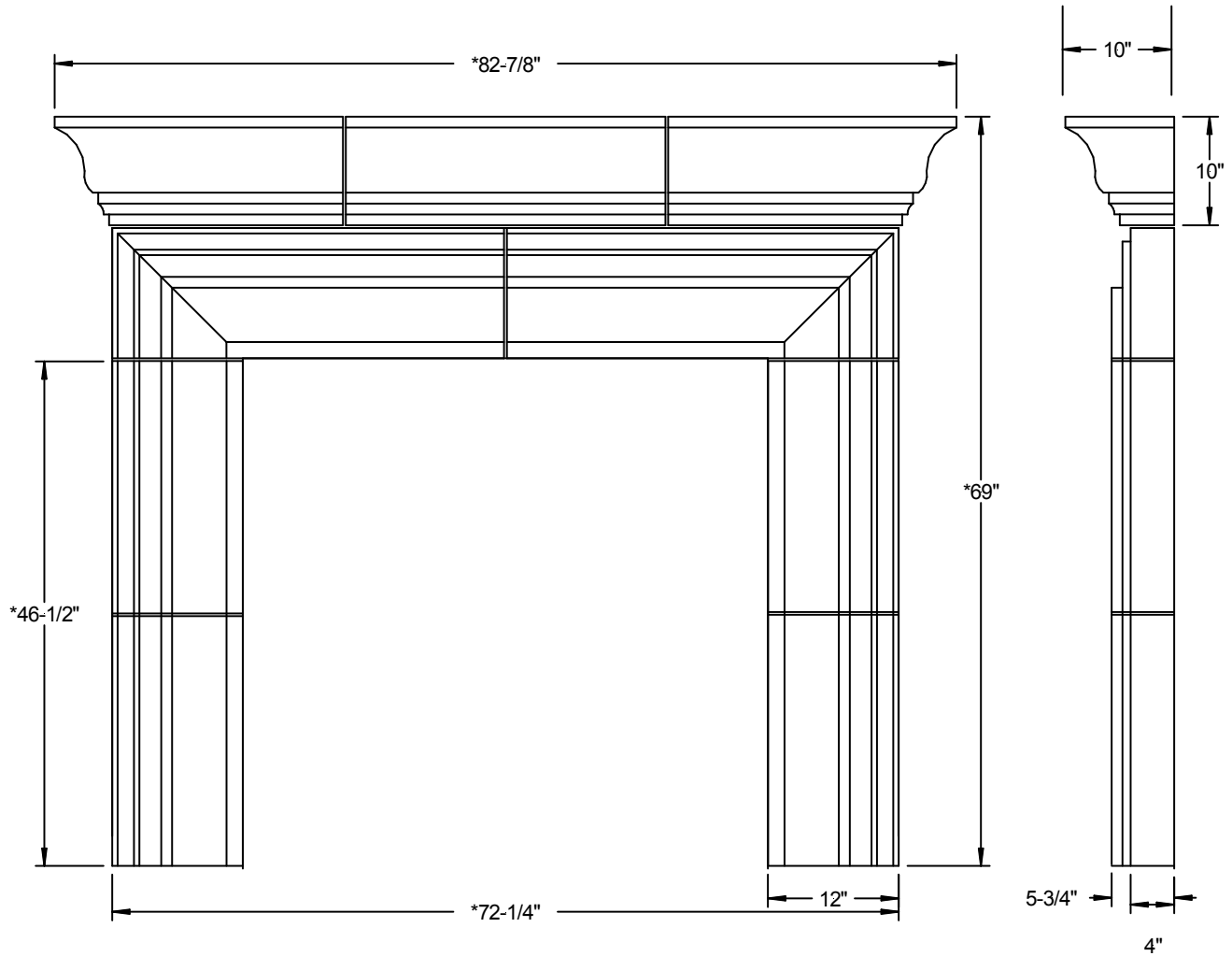

\* Adjustable

## FP-6

Cladding can be added to surround the firebox

The Ark Concrete Specialties, Inc. 713-695-2001

Aug. 2012

# CAST STONE FIREPLACES

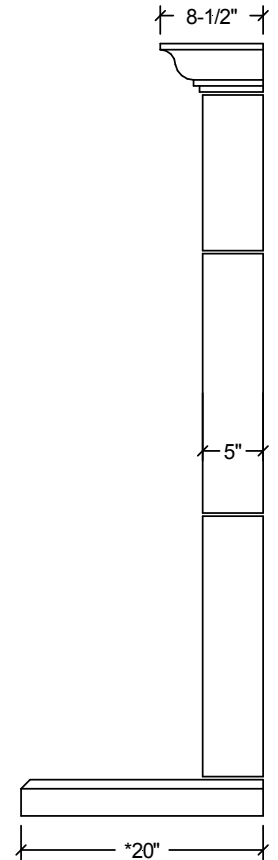
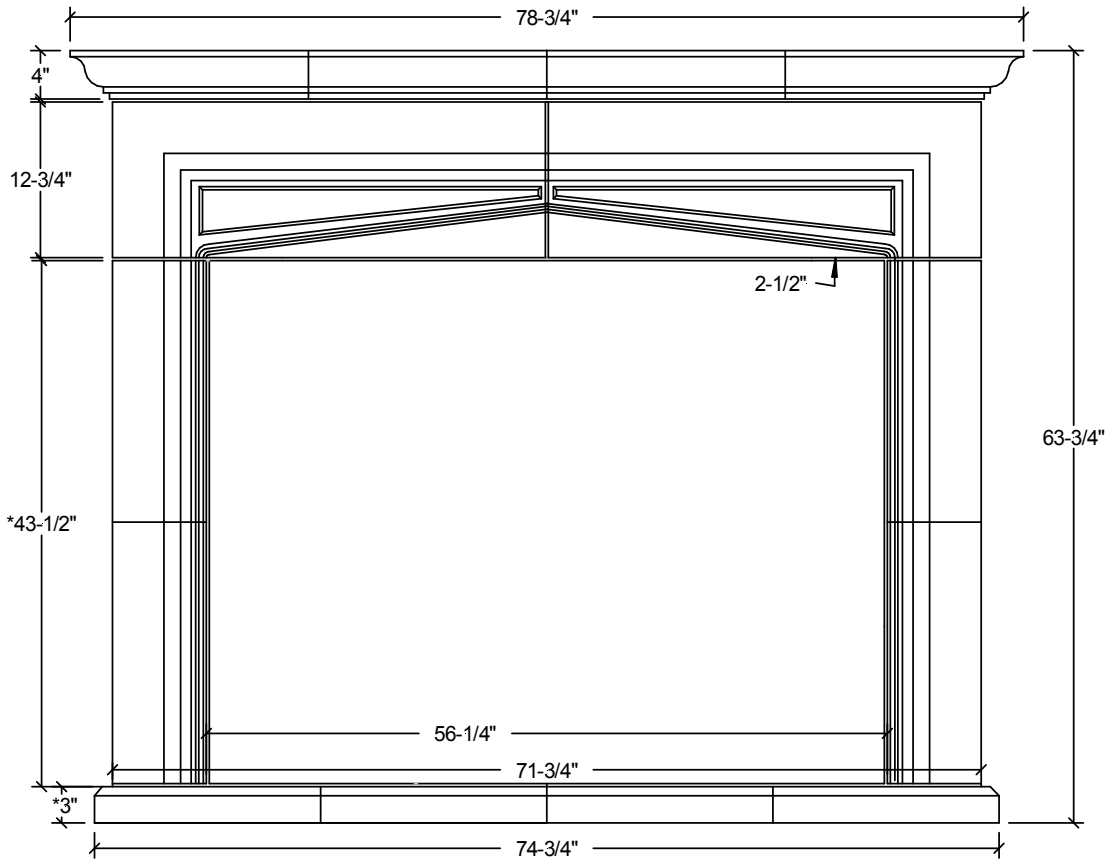

\* Adjustable

Leg Profile

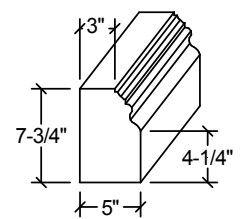

## FP - 7

Cladding can be added to surround the firebox

# CAST STONE FIREPLACES

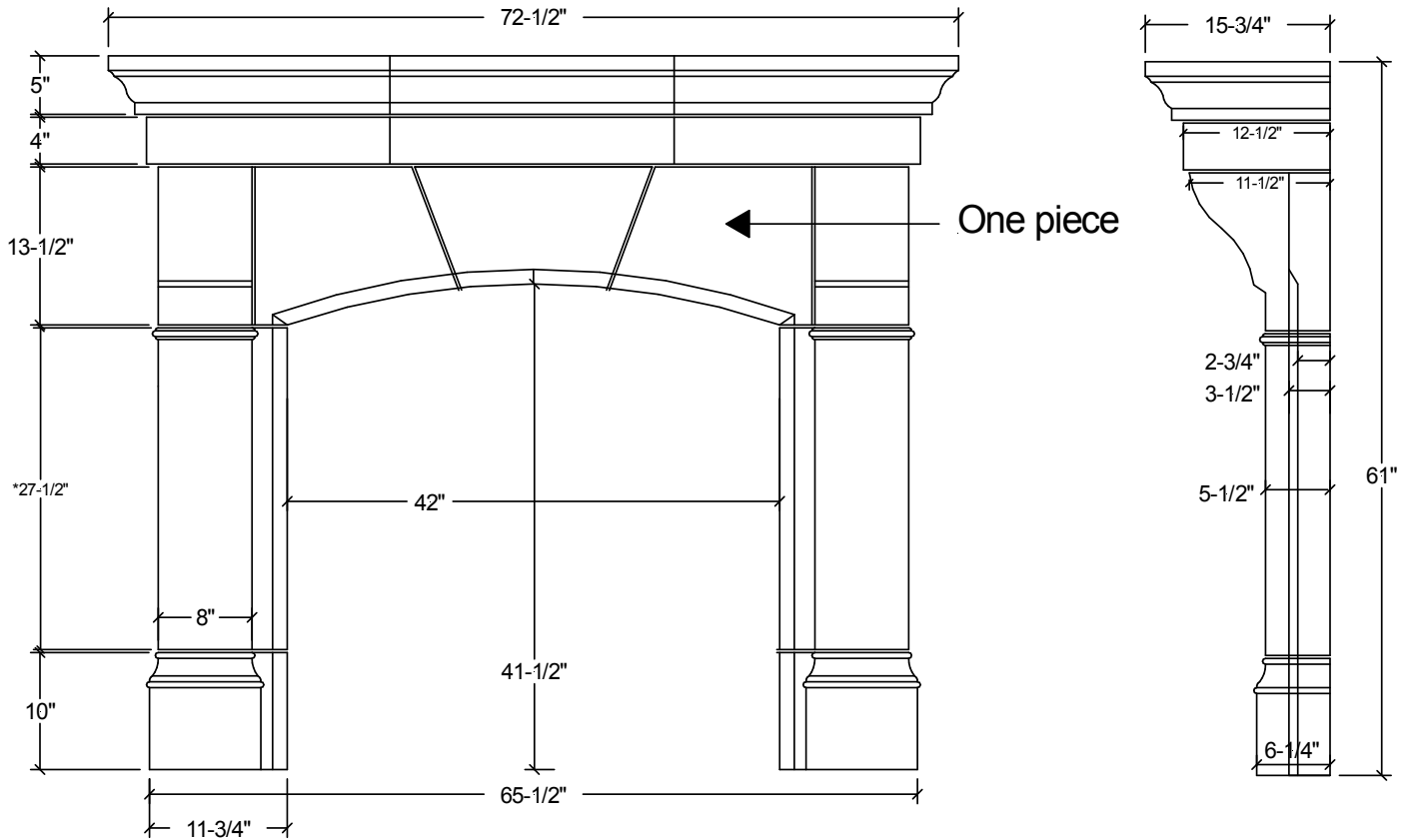

\* Adjustable

## FP - 8

Cladding can be added to surround the firebox

# CAST STONE FIREPLACES

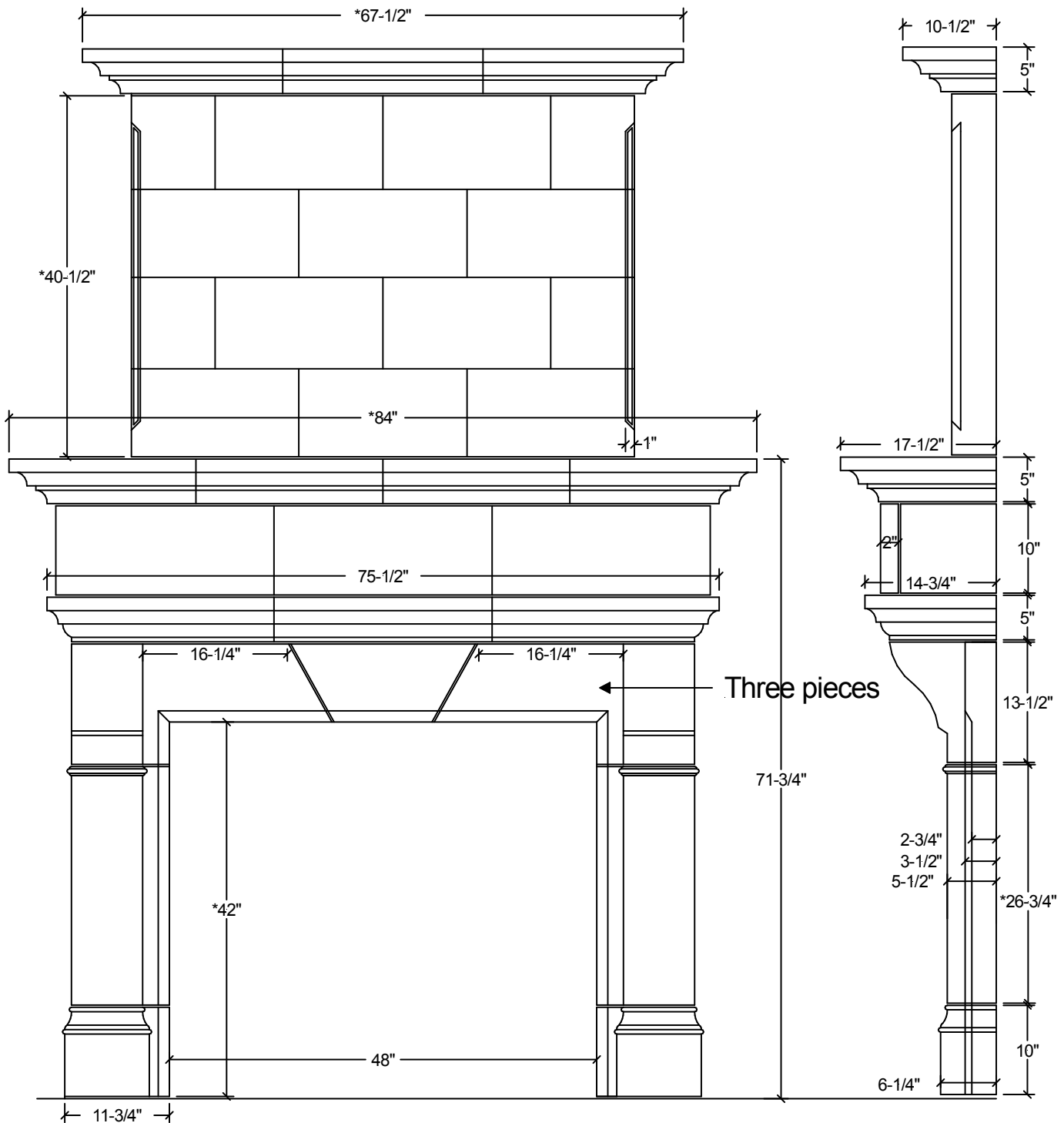

FP - 9

\* Adjustable

Cladding can be added to surround the firebox

The Ark Concrete Specialties, Inc. 713-695-2001

Aug. 2012



# CAST STONE FIREPLACES

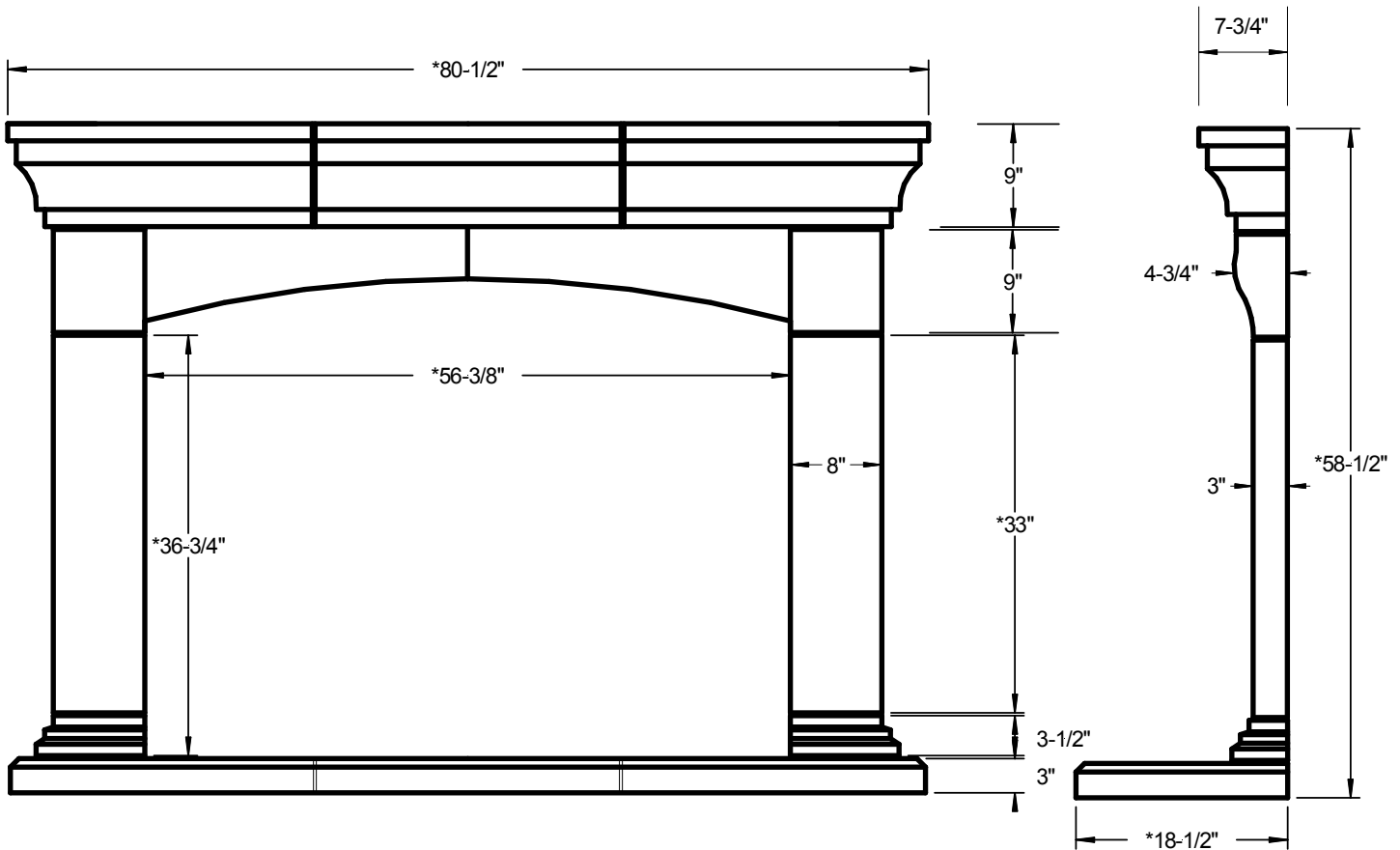

\* Adjustable

## FP-10

Cladding can be added to surround the firebox

# CAST STONE FIREPLACES

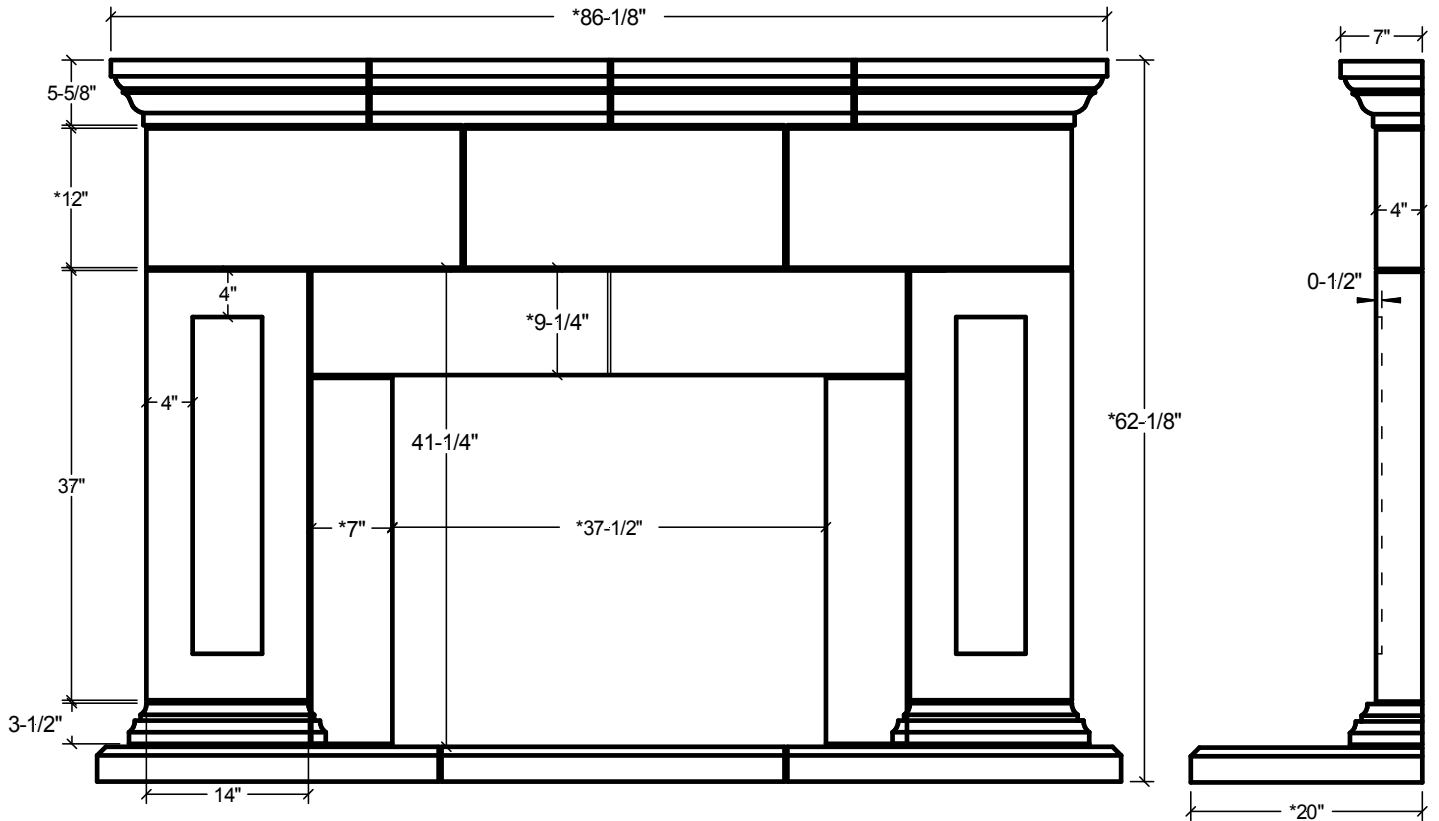

\* Adjustable

FP-11

# CAST STONE FIREPLACES

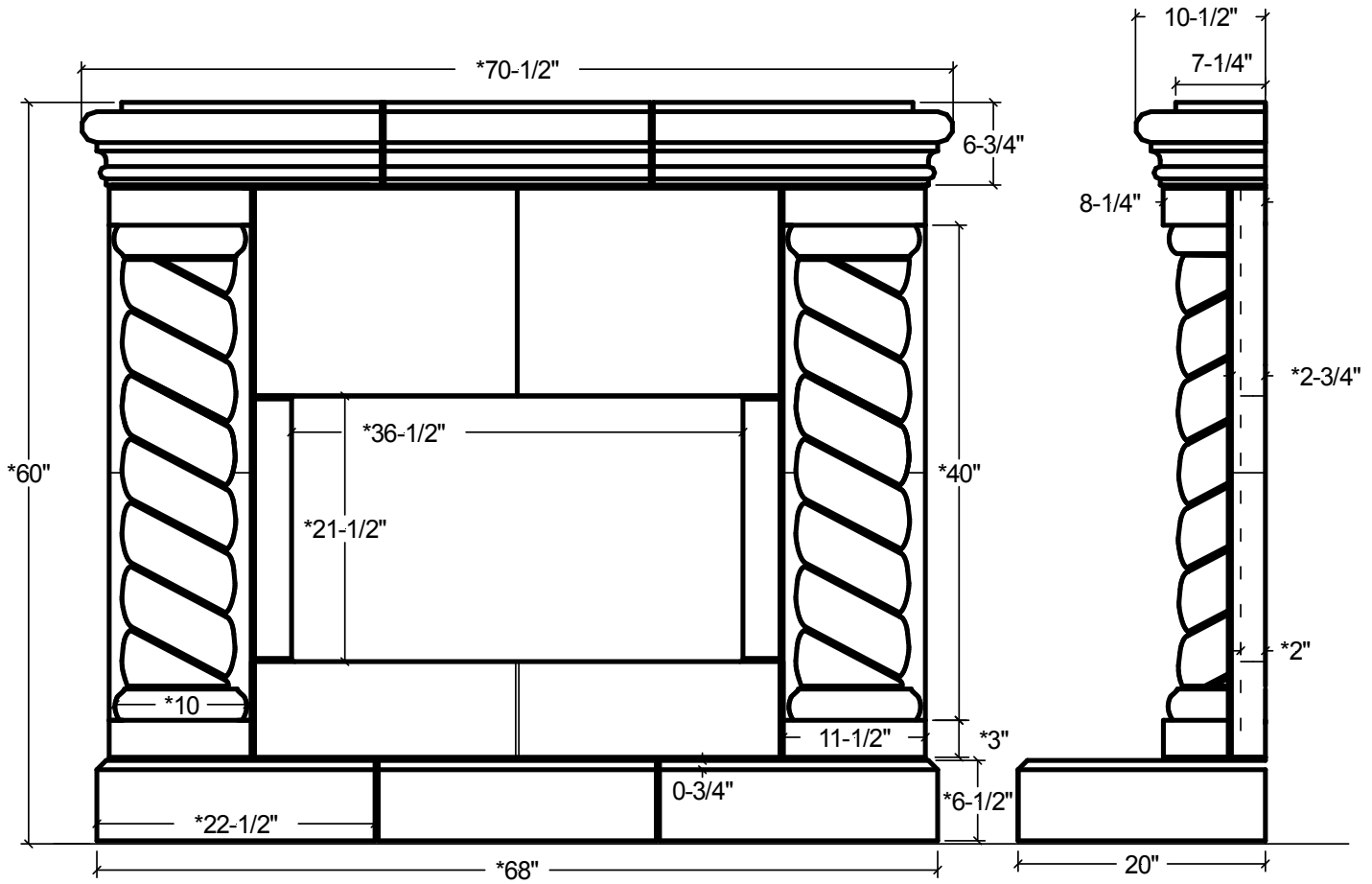

\* Adjustable

FP-12

# CAST STONE FIREPLACES

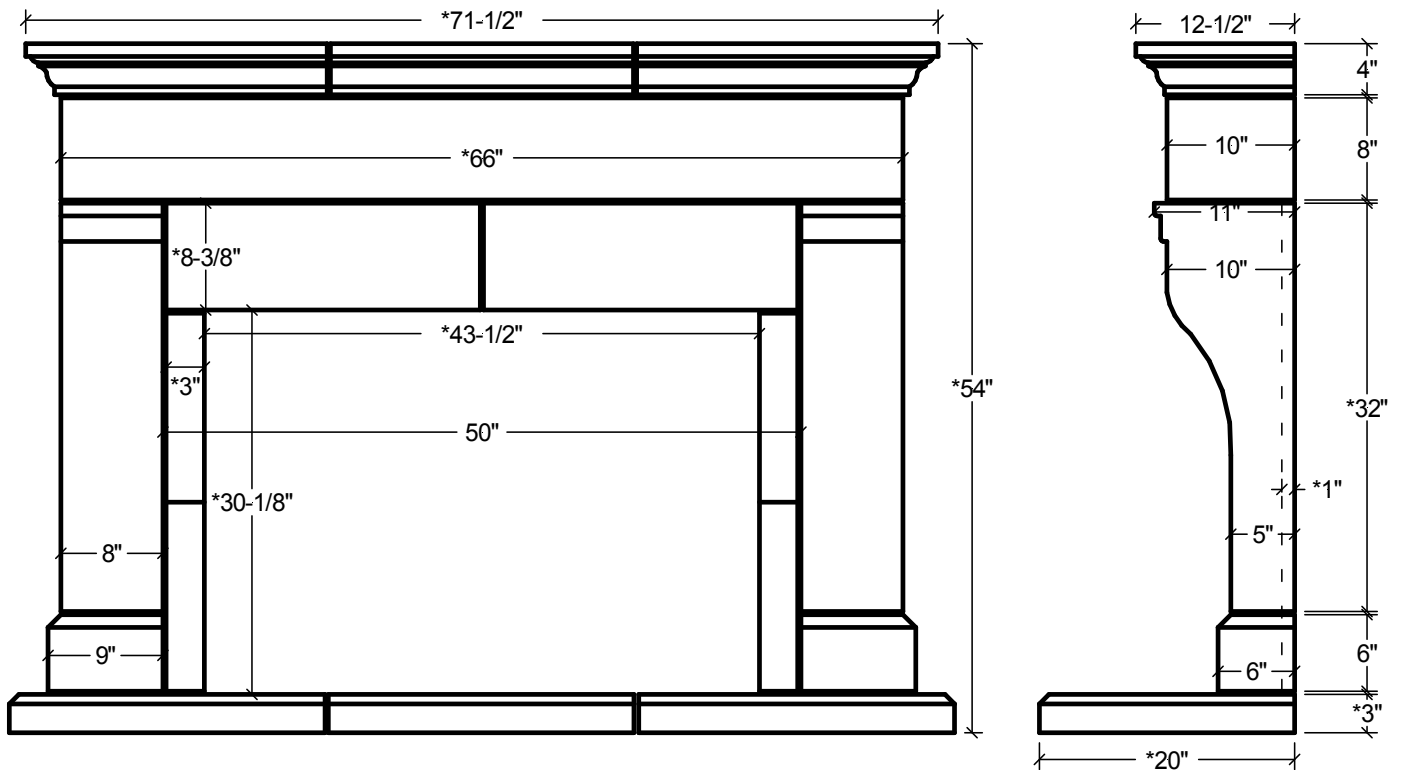

\* Adjustable

## FP-13

# CAST STONE FIREPLACES

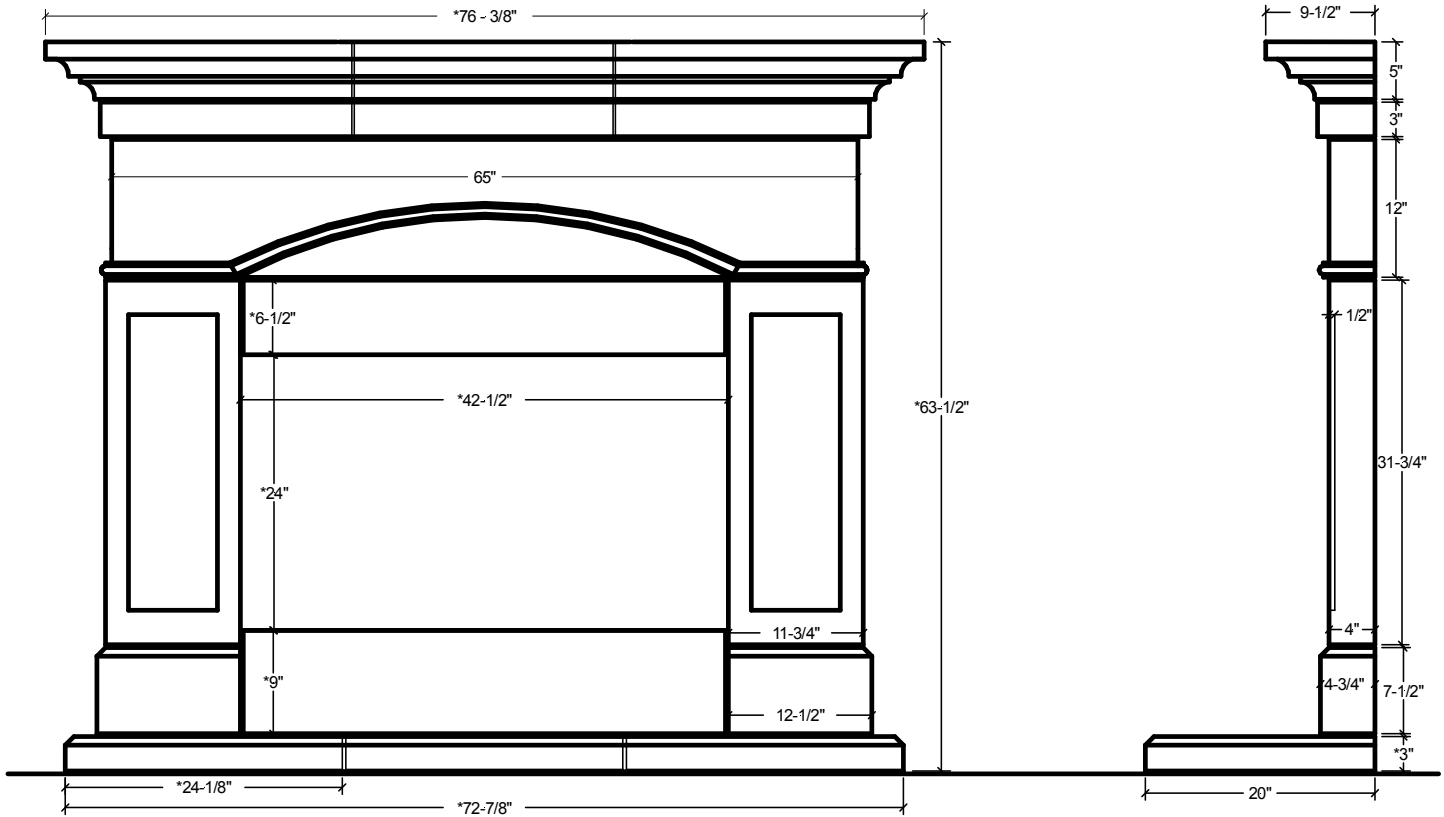

\* Adjustable

## FP-14

# CAST STONE FIREPLACES

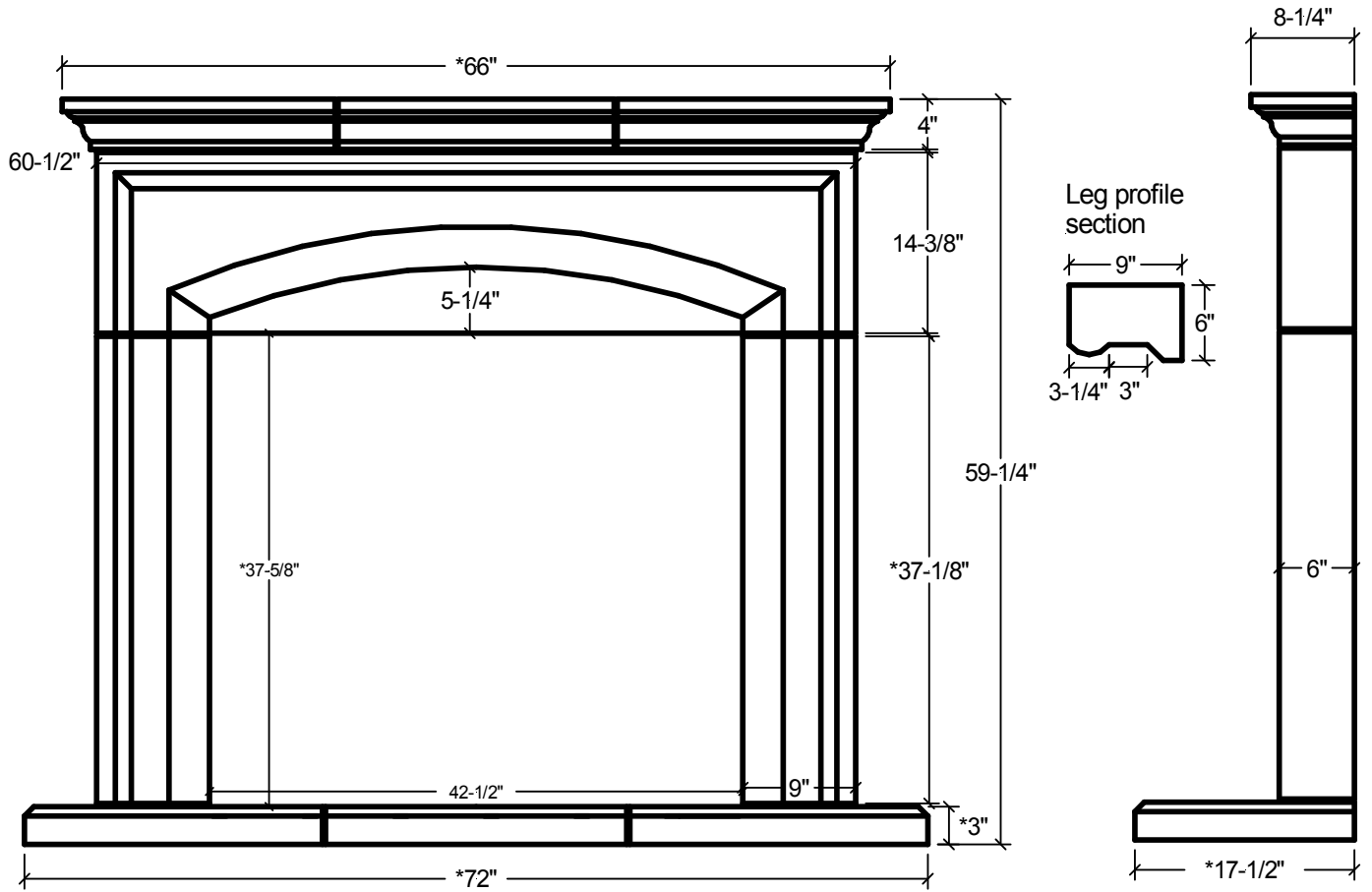

\* Adjustable

## FP-15

Cladding can be added to surround the firebox

# CAST STONE FIREPLACES

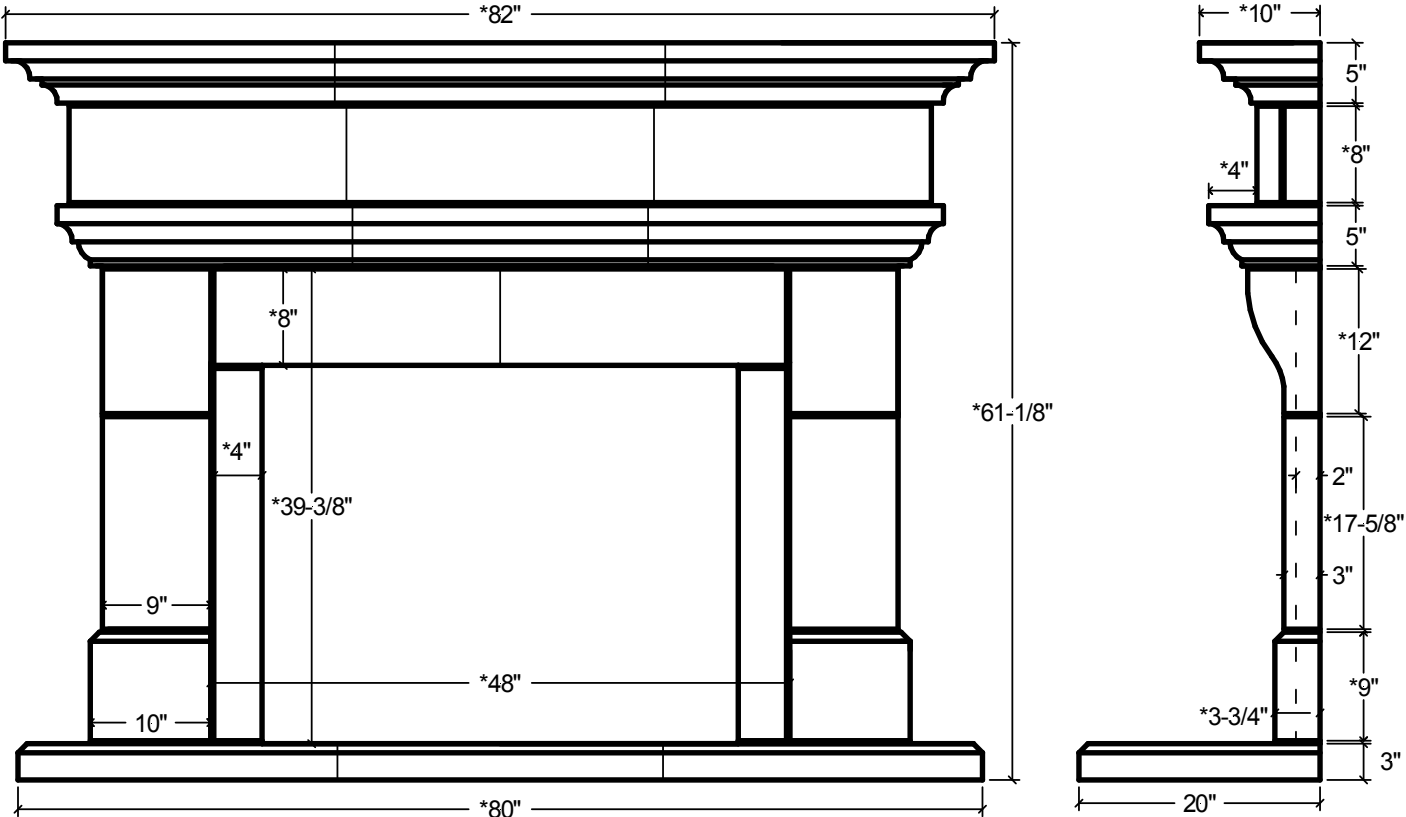

\* Adjustable

FP-16

# CAST STONE FIREPLACES

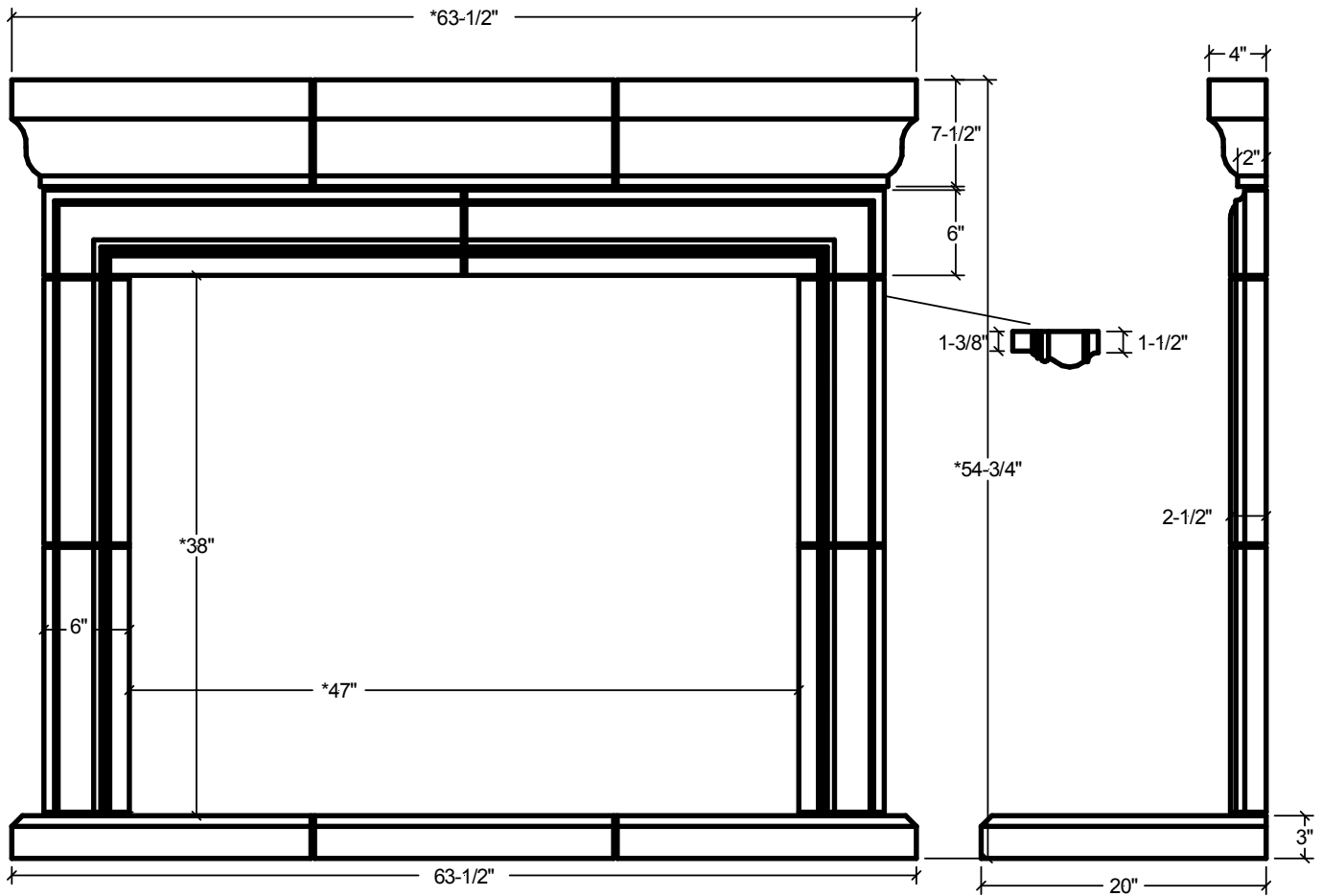

\* Adjustable

## FP-17

Cladding can be added to surround the firebox



# CAST STONE FIREPLACES

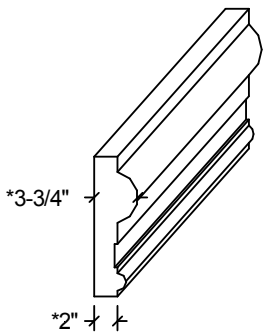
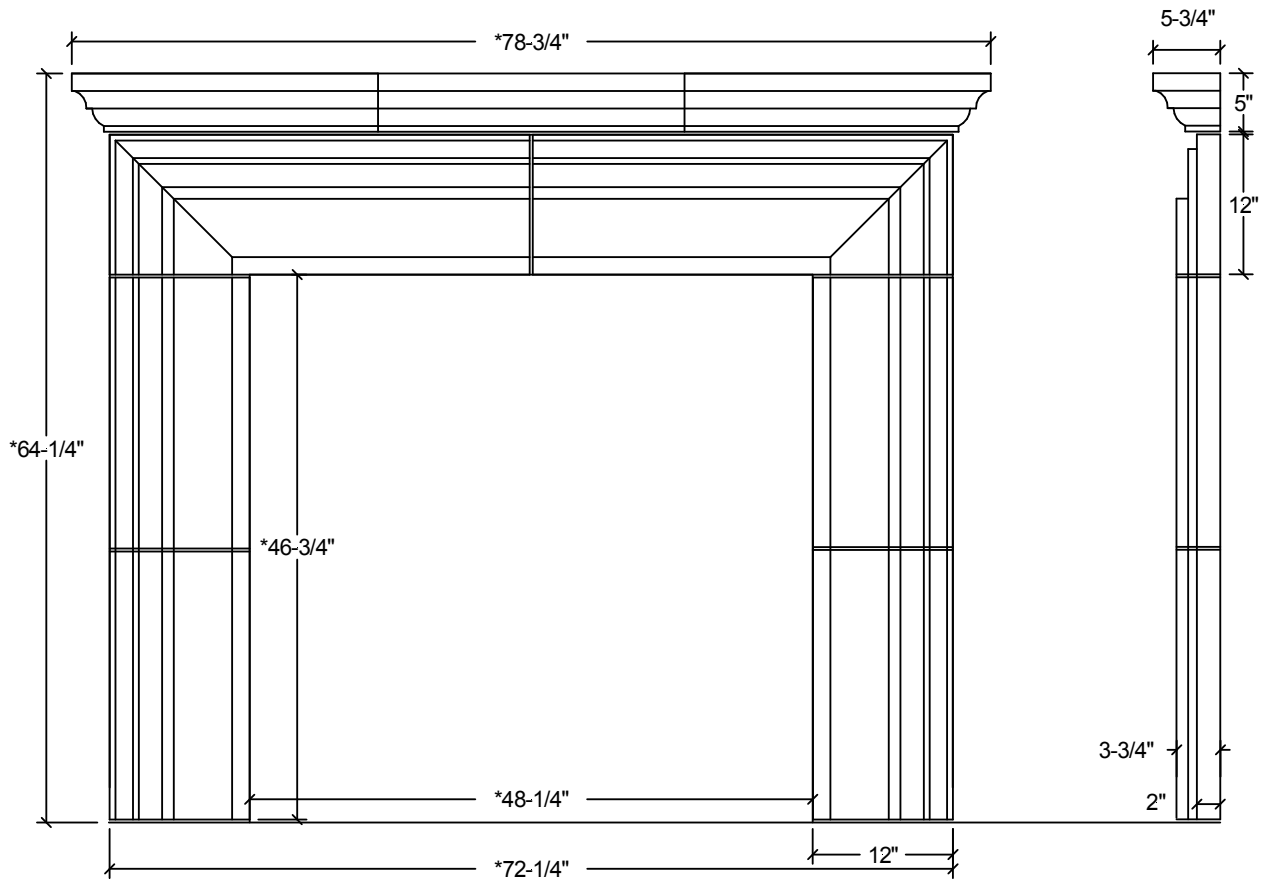

\* Adjustable

Cladding can be added to surround the firebox

## FP-18

# CAST STONE FIREPLACES

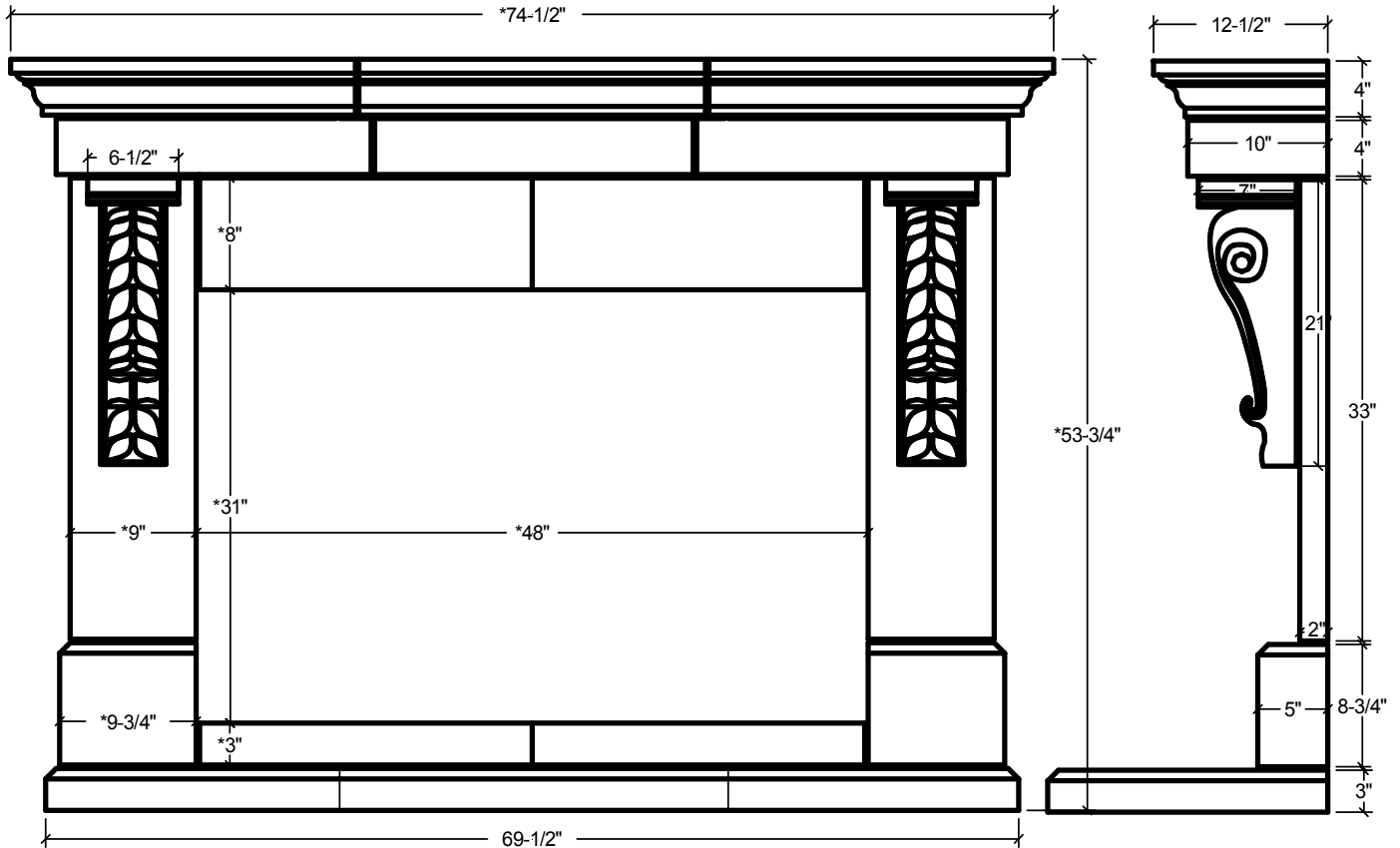

\* Adjustable

Corbel drawing is approximate

## FP-19

Cladding can be added to surround the firebox

# CAST STONE FIREPLACES

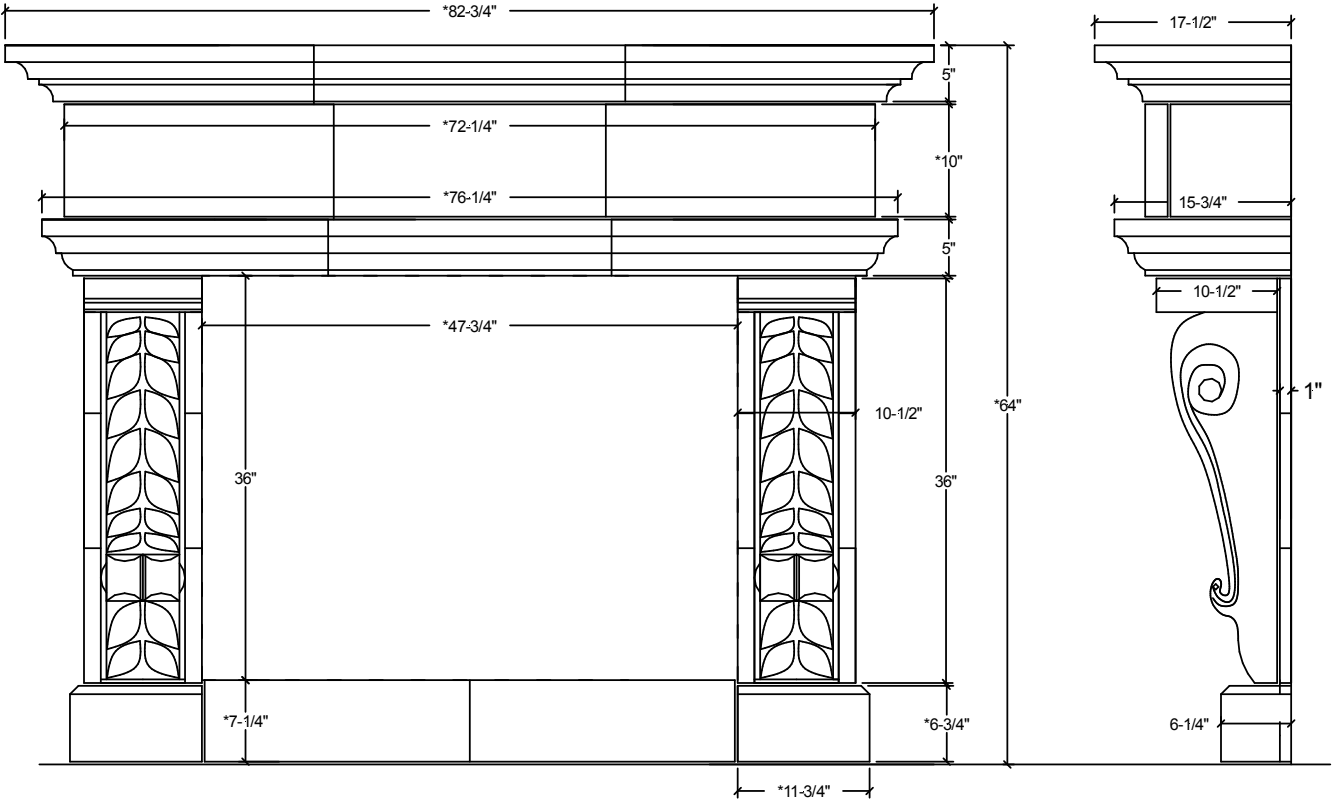

\* Adjustable  
Corbel drawing is approximate

## FP-20

Cladding can be added to surround the firebox

# CAST STONE FIREPLACES

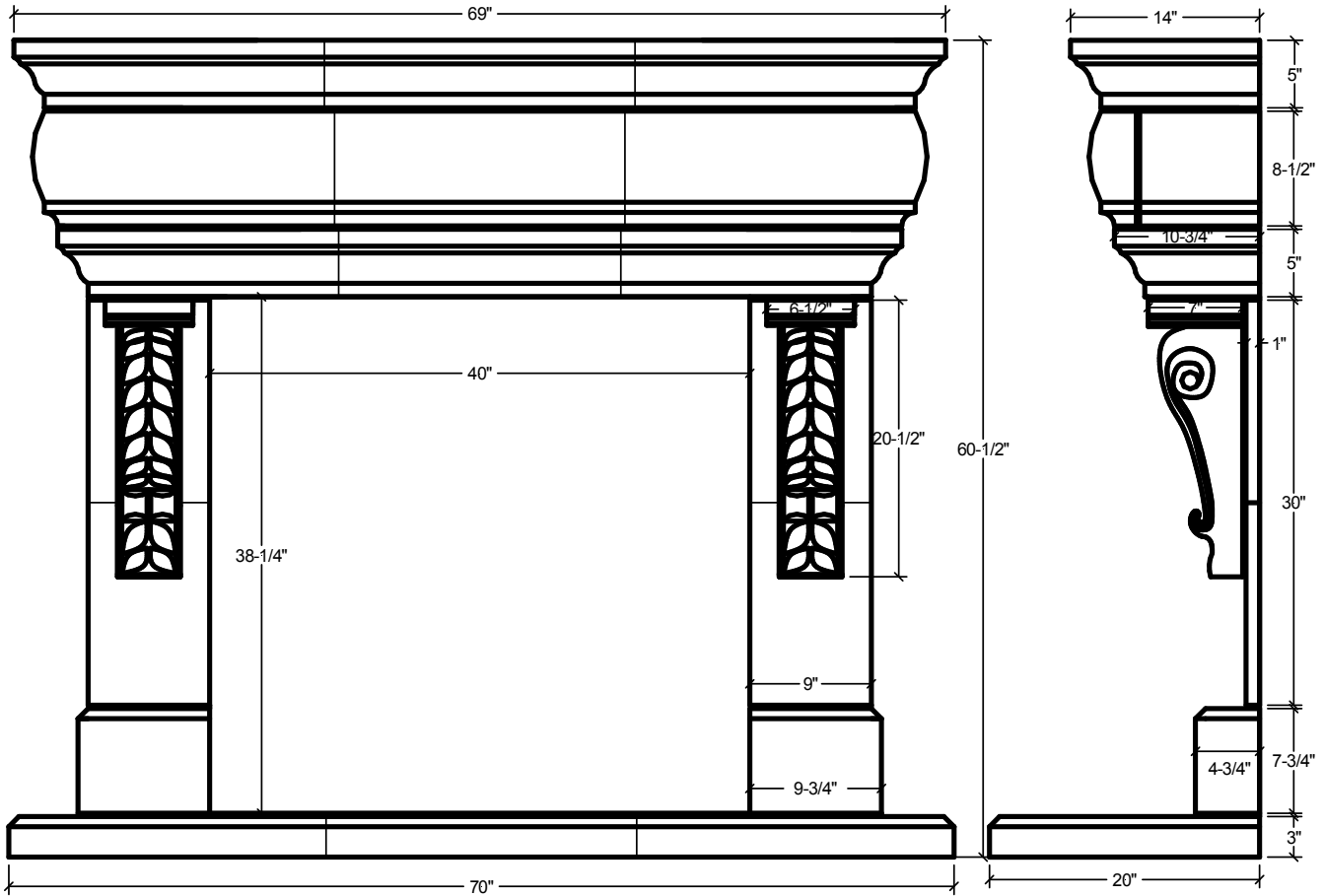

\* Adjustable

Corbel drawing is approximate

## FP-21

Cladding can be added to surround the firebox

# CAST STONE FIREPLACES

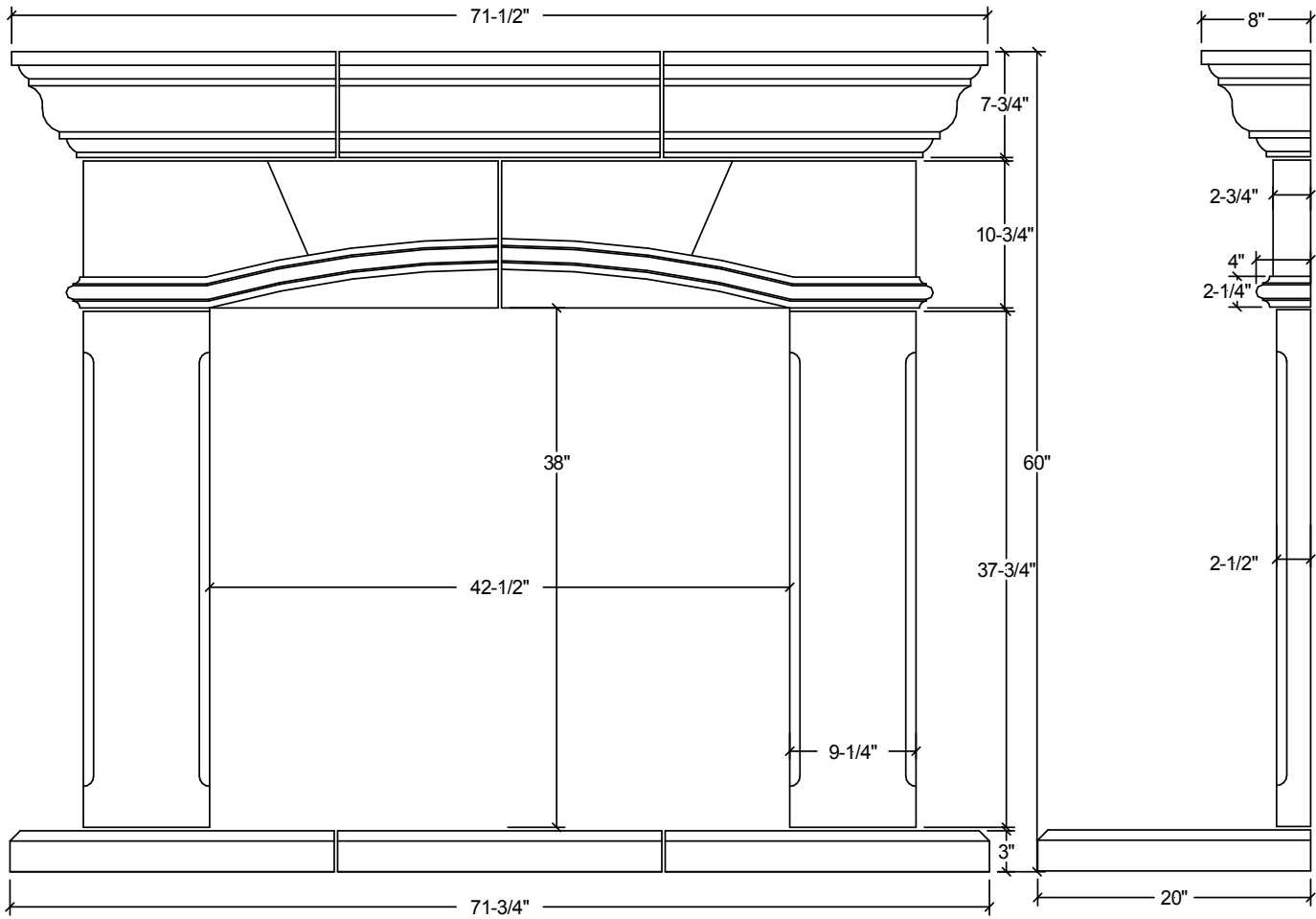

## FP-22

Cladding can be added to surround the firebox

# CAST STONE FIREPLACES

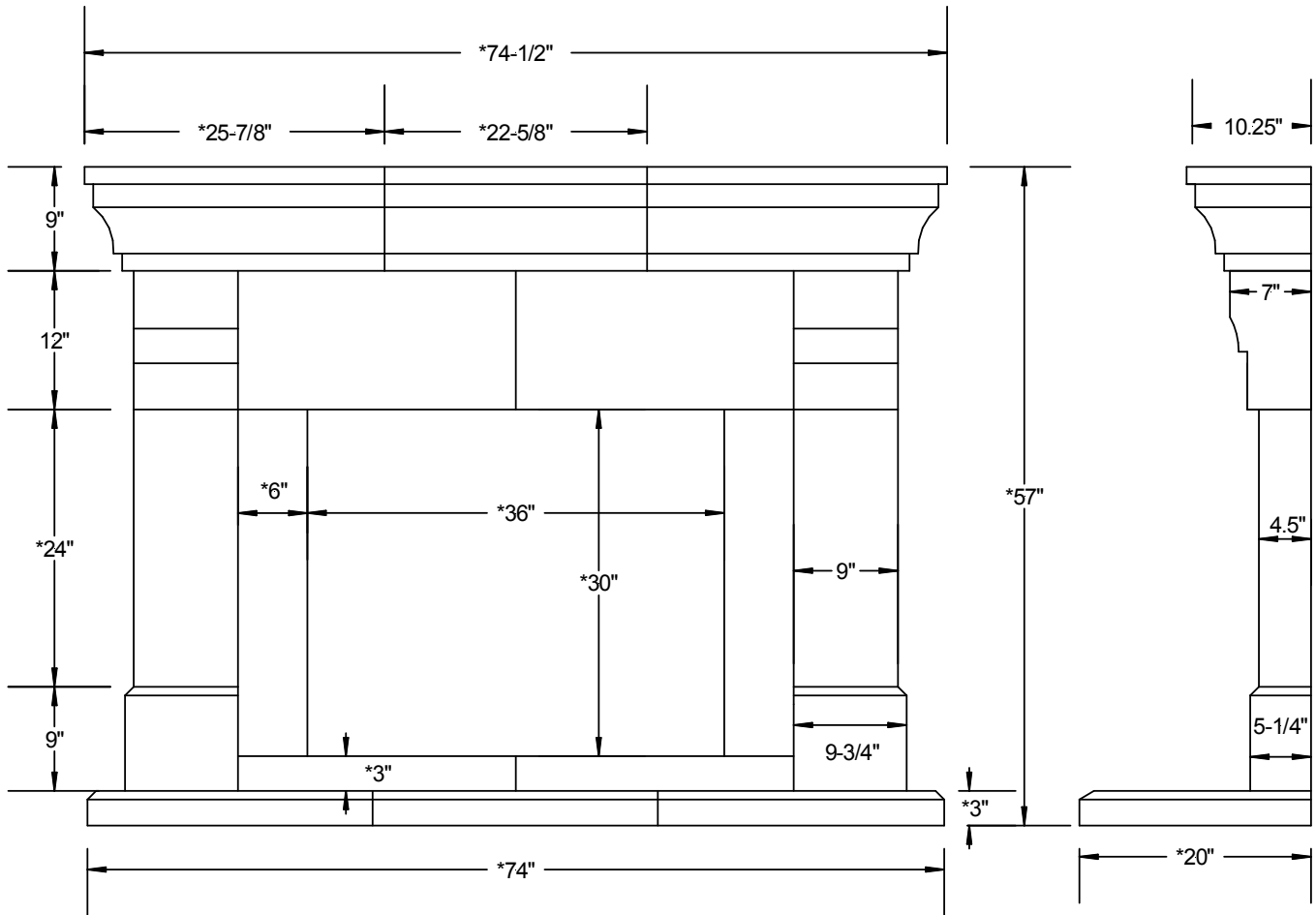

\* Adjustable

**FP-23**  
FPPB - 1

# CAST STONE FIREPLACES

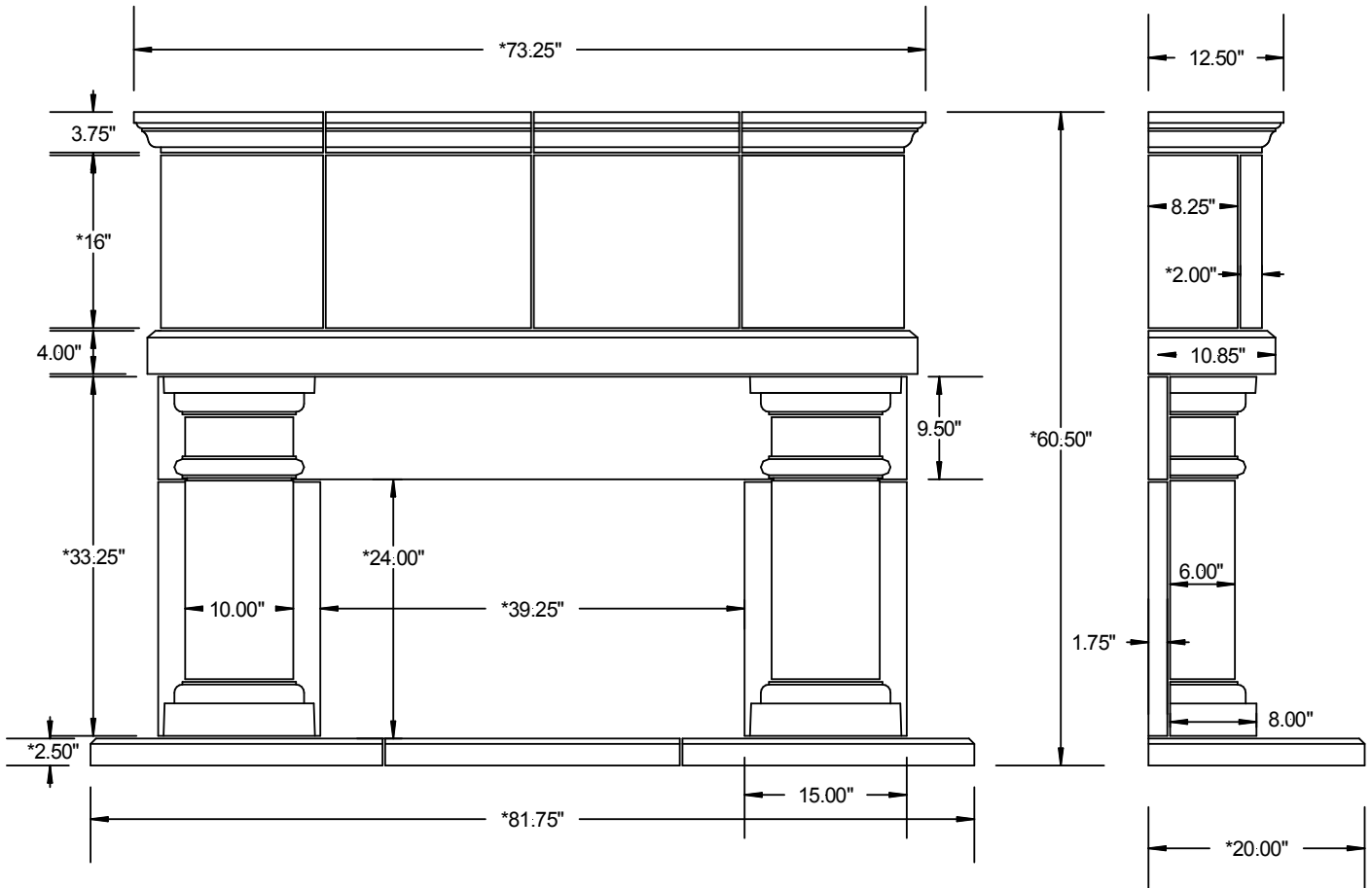

\* Adjustable

**FP-24**  
FPSH

Cladding can be added to surround the firebox

# CAST STONE FIREPLACES

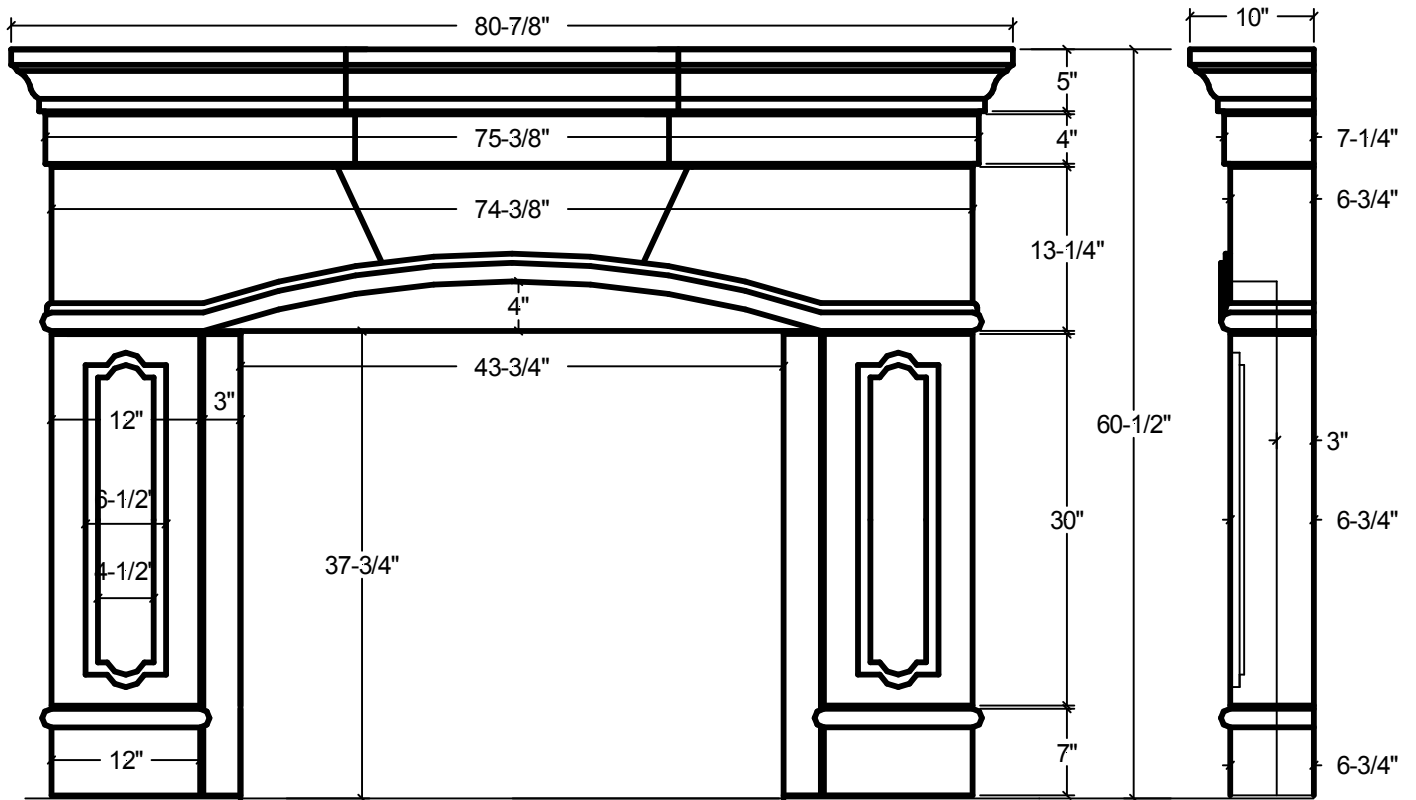

## FP-25

Cladding can be added to surround the firebox



# CAST STONE OVER MANTELS

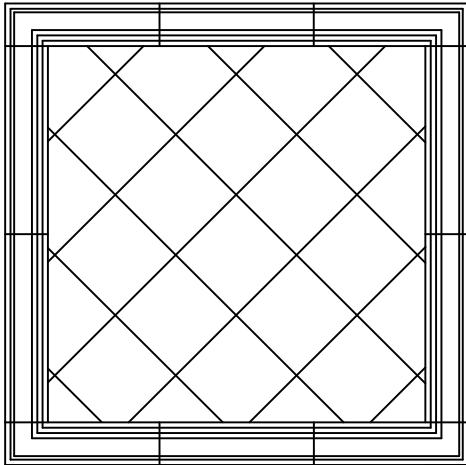

Full Square Frame with Diamond Cladding  
(TDC)

## Frame Profiles:

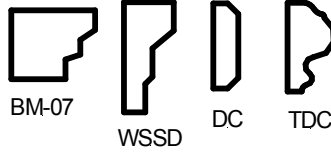

See Tables at end of catalog  
for sizes and available radii

See Headers pages  
for alternate Headers

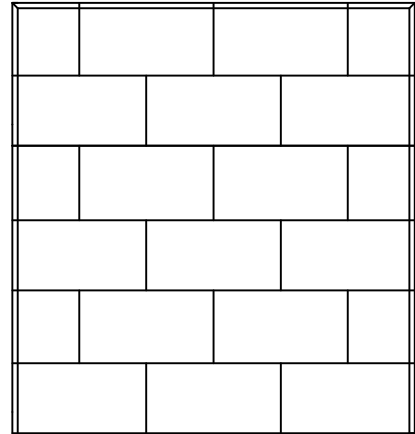

Square Cladding with Chamfer

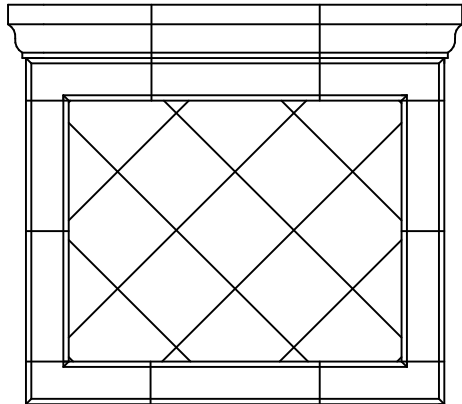

Full Frame with Header and Diamond Cladding  
(DC, BM-15)

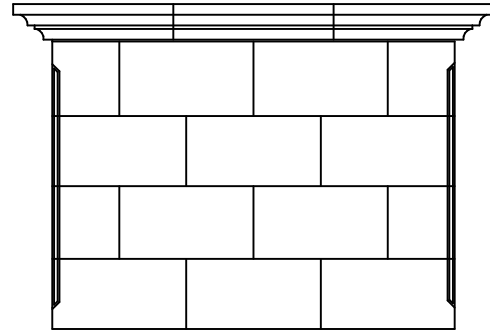

Header on Square Cladding with Decorative Edge

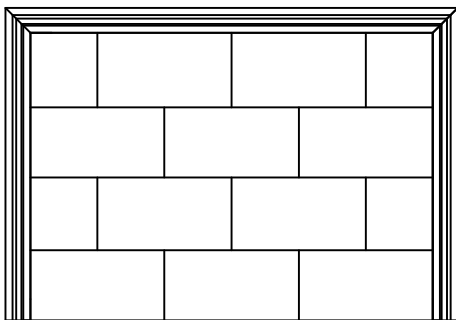

3/4 Frame with Square Cladding  
(BM-07)

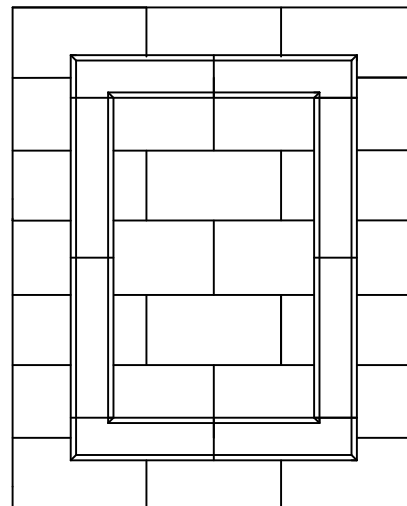

Full Square Frame over Square Cladding  
(DC)

# CAST STONE HEADERS & MANTELS

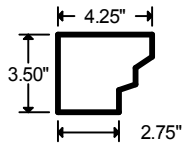

BM - 07

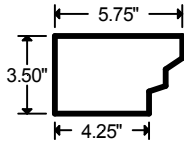

BM - 07 A

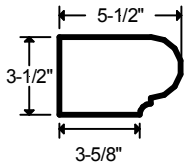

DNLG - 1

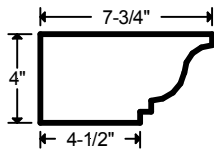

BM - 02

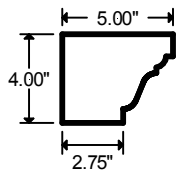

BM - 08

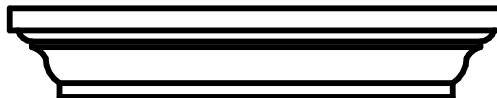
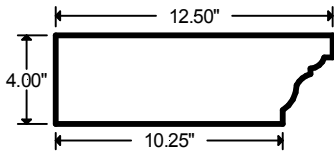

BM - 09

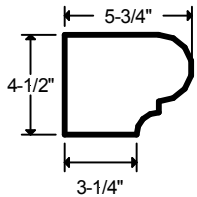

DNLG - 2

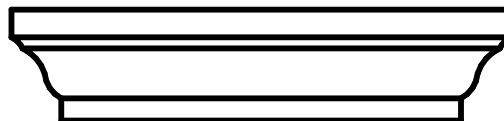
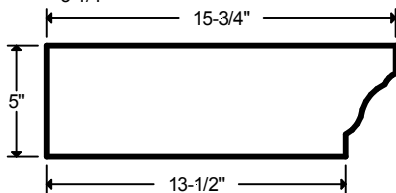

BM - 21

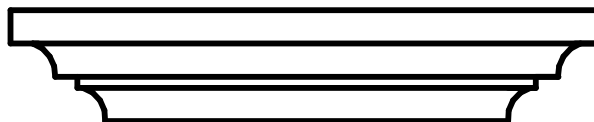
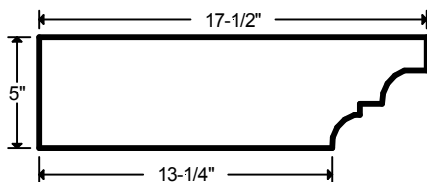

BM - 20

# CAST STONE HEADERS & MANTELS

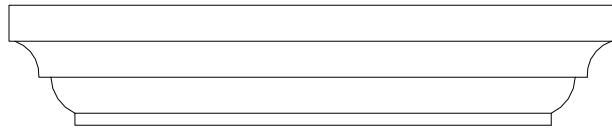
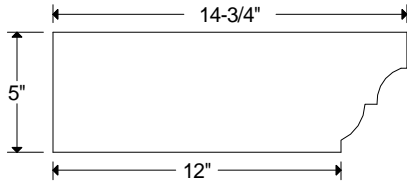

BM - 23

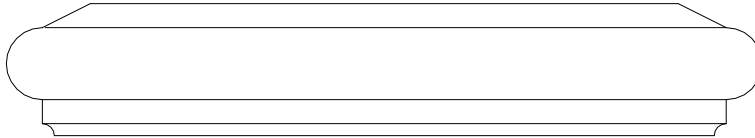
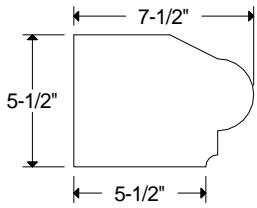

DNLG - 3

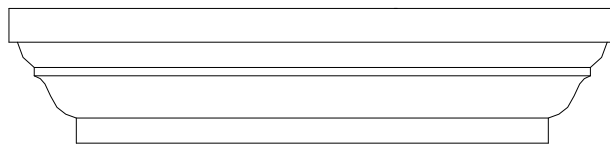
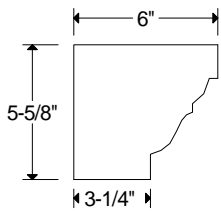

BM Tapia

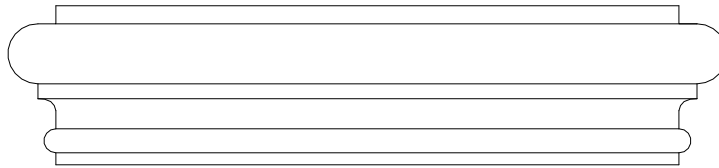
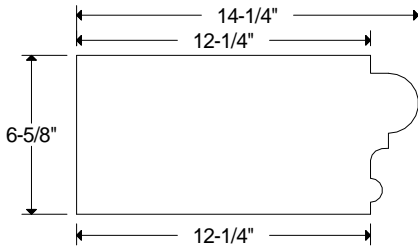

BM-27

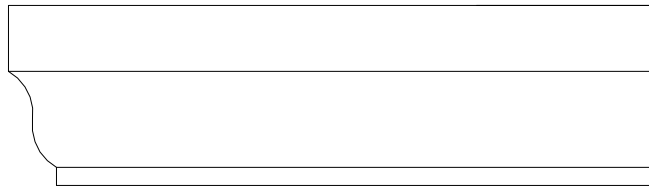
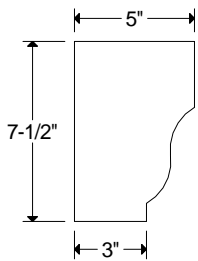

BM - 15

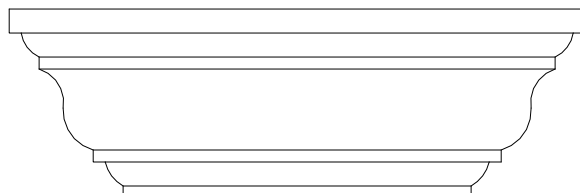
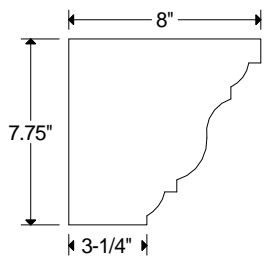

BM - 19

# CAST STONE HEADERS & MANTELS

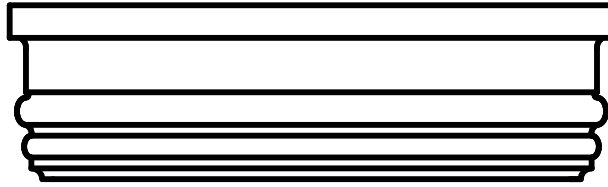
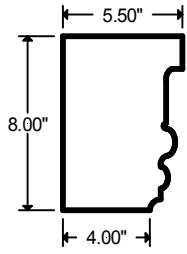

BM - 26

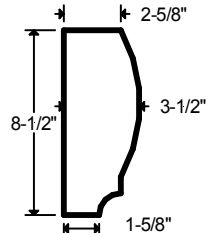

BM - 22

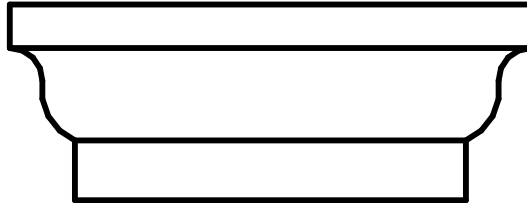
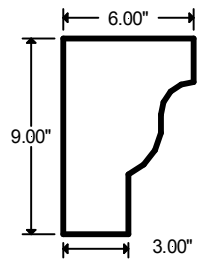

BM - 13

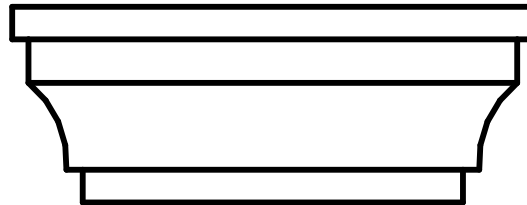
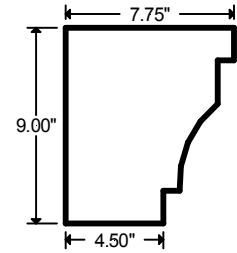

BM - 14

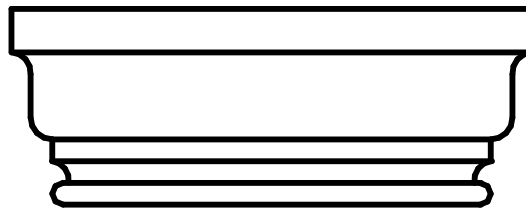
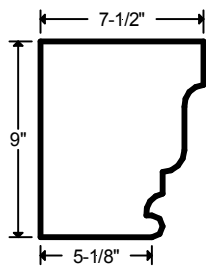

BM - 16

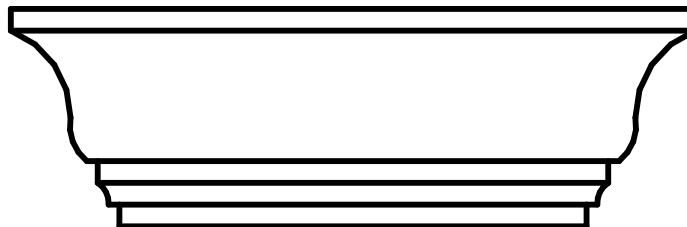
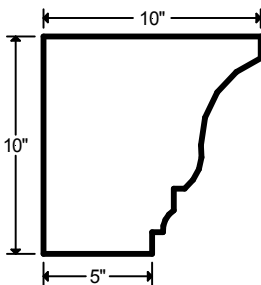

BM-28

# CAST STONE HEADERS & MANTELS

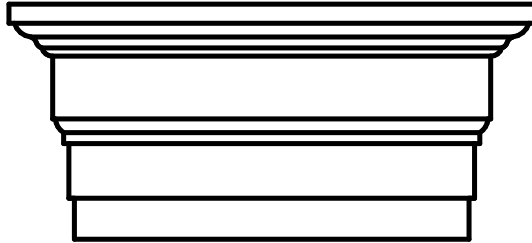
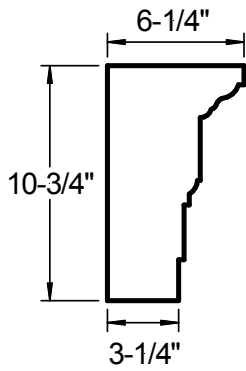

MO - 01

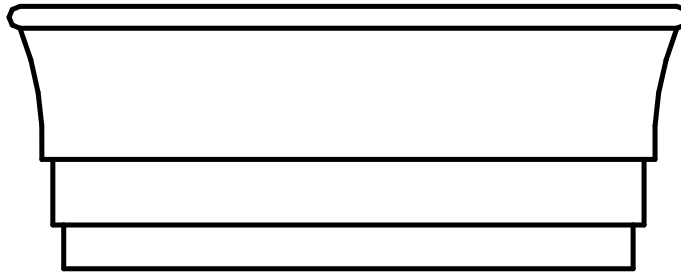
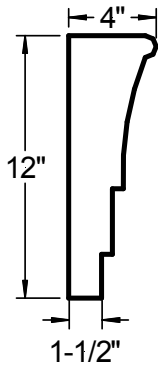

ZM-01  
R&L Returns  
Length 36"

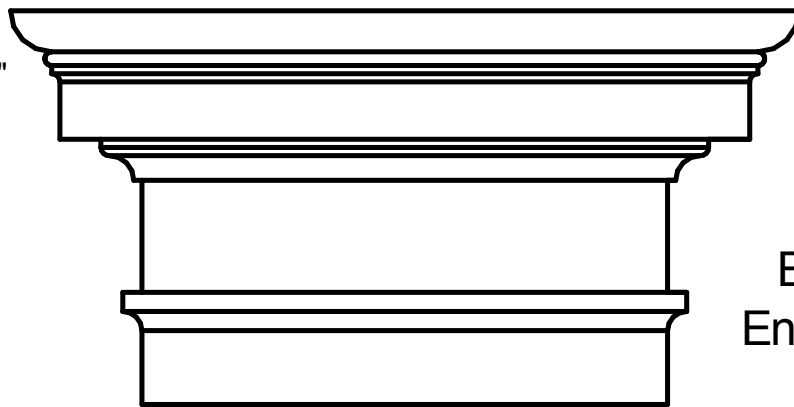
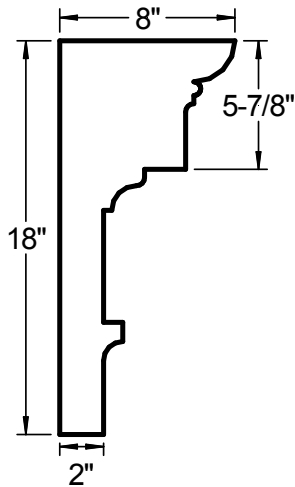

BM - 17  
Entablature

# CAST STONE KEYSTONES

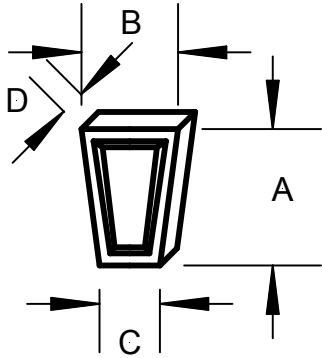

RECESSED KEYSTONES				
Item Number	'A'	'B'	'C'	'D'
KSR9	9"	8"	4.5"	3"
KSR12	11.25"	8"	5"	3"

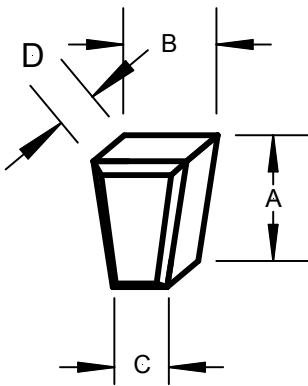

BEVELED KEYSTONES				
Item Number	'A'	'B'	'C'	'D'
KS16	16.0"	11.0"	5.5"	3.5"
KS14	14.0"	10.5"	5.5"	3.5"
KS12	12.0"	8.5"	5.0"	3.5"
KS9	9.0"	7.75"	4.5"	3.5"
KS6	6.0"	4.88"	3.0"	3.5"
KSA	11.63"	9.0"	7.0"	2.0"
KSB	19.63"	12.0"	9.0"	2.0"
KSC	15.63"	10.5"	8.0"	2.0"
KS5	5"	3.5"	2"	3.5"

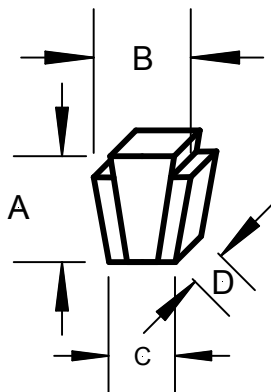

BATWING KEYSTONES				
Item Number	'A'	'B'	'C'	'D'
KSS	14"	10"	6"	4"
KSB12	11.5"	9"	6"	4"
KSB9	8.75"	8"	3.5"	3.5"

# CAST STONE PIER CAPS

PC - 10D

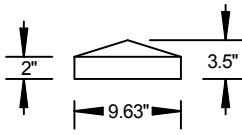

PC - 64

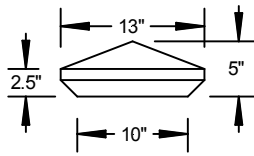

TC

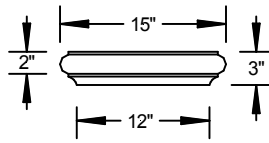

TCN

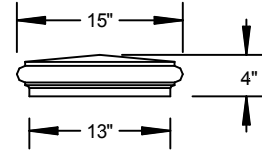

PC - 26

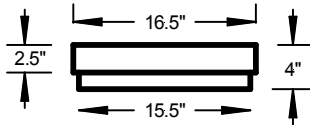

PC - 16

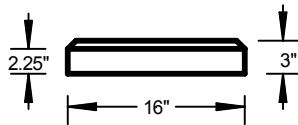

PC - 24

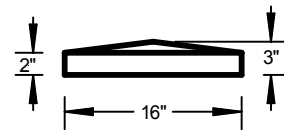

DPC - 16

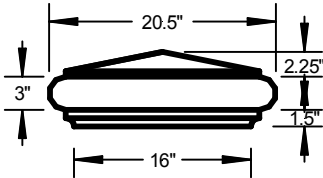

PC - 22

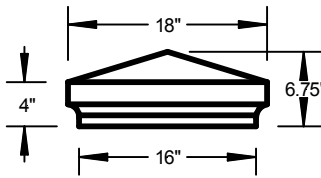

PCD

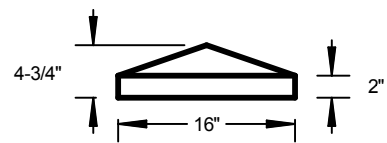

PC - 44

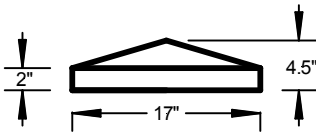

PC - 17-1

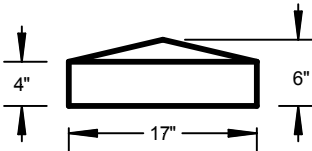

DPC - 16A

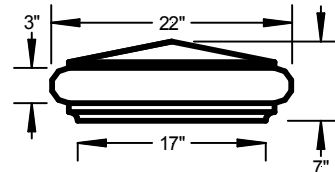

PC - 18D

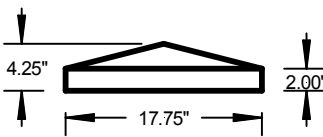

PC - 18

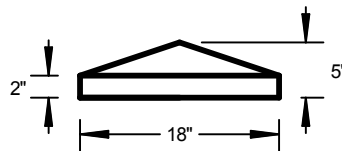

AWPC

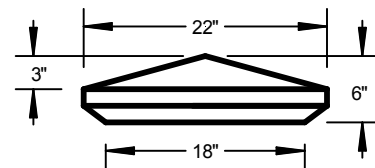

All of our pier caps can be manufactured with holes or flat spots.  
Call for pricing

# CAST STONE PIER CAPS

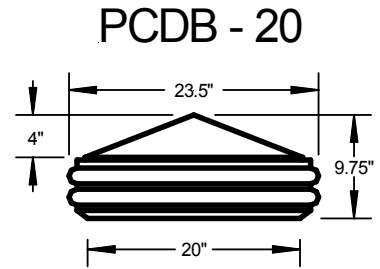
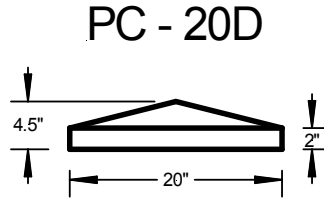
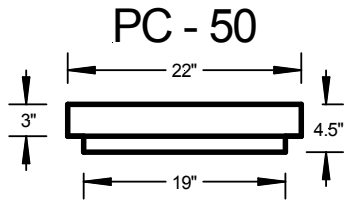

**PC - 01**

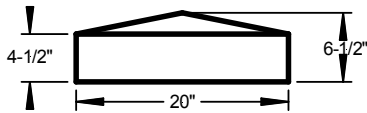

**PCSB - 20**

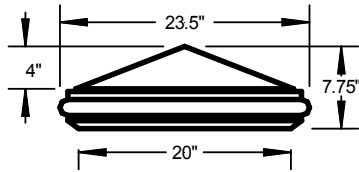

**BB - 100D\***

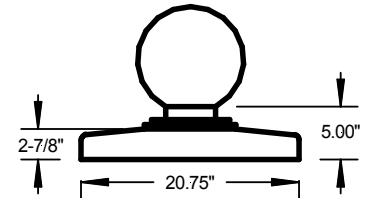

∅ = 8", 10", 12", 18"

\*Connecting neck varies slightly from ball size to ball size. Balls can be installed on flat caps as well as pyramid caps.

**PC - 57**

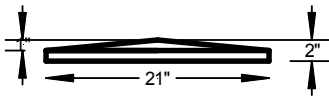

**PCF - 21**

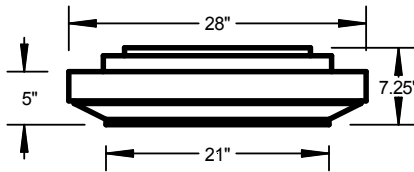

**PC - 54A**

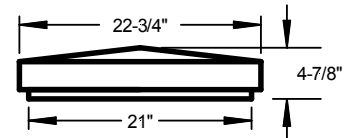

**PC - 28**

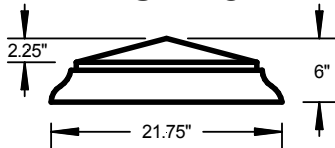

**PCT - 22**

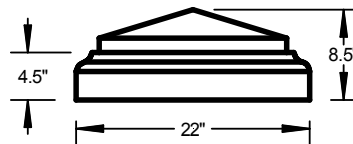

**PC - 22D**

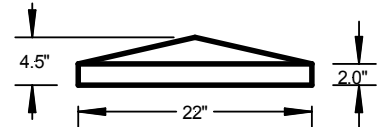

**AWPC - 04**

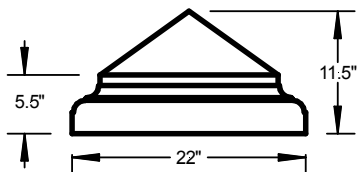

**PC - 12**

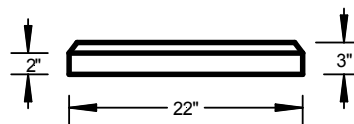

**PC - 46**

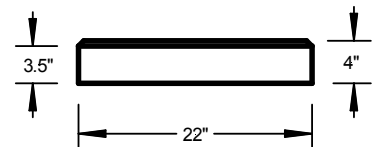

All of our pier caps can be manufactured with holes or flat spots.  
Call for pricing



# CAST STONE PIER CAPS

PC - 29

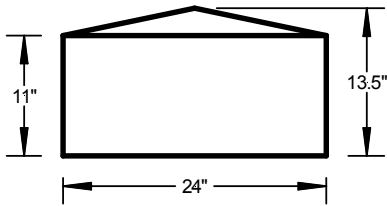

AW - 24

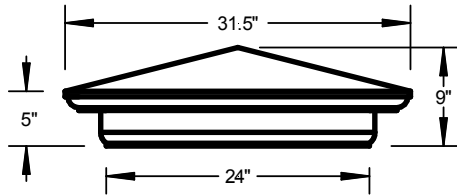

PC - BUL24

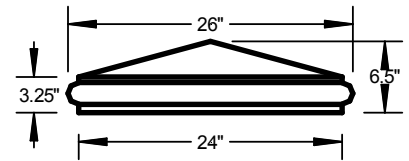

PC - 54

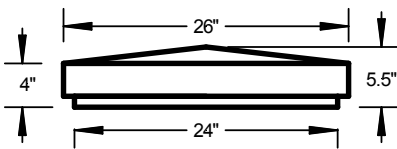

PC - 13

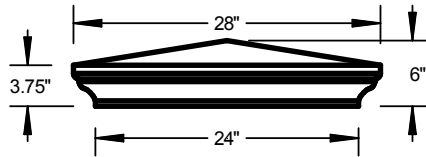

PC - 24D

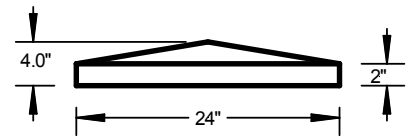

DPC - 25

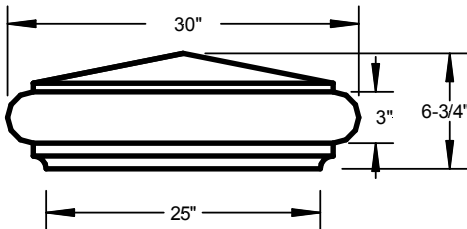

PCF - 21A



PC - 27

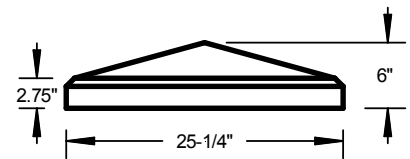

PC - 30

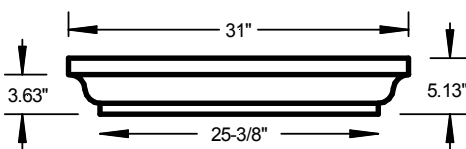

AW - 26\*

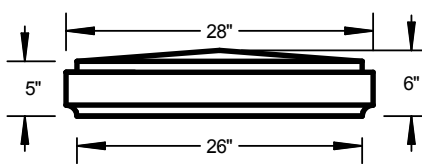

PC - B26D

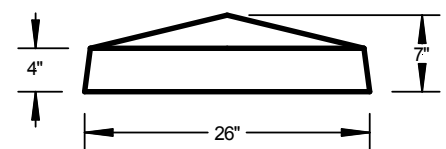

\*Rectangular  
Base 26x28  
Widest 28x30

All of our pier caps can be manufactured with holes or flat spots.  
Call for pricing

# CAST STONE PIER CAPS

PC - BUL26

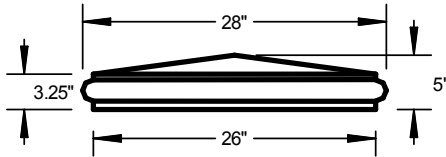

PC-BUL26A

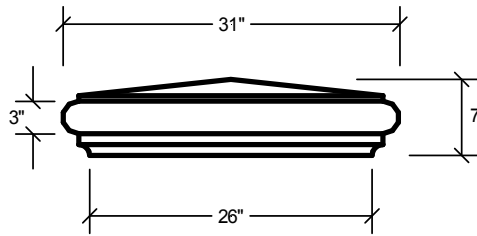

PC - 26D

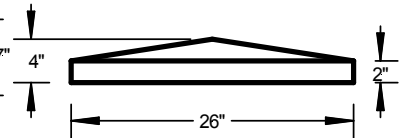

PC - 27D

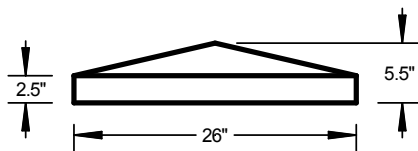

PC - 34

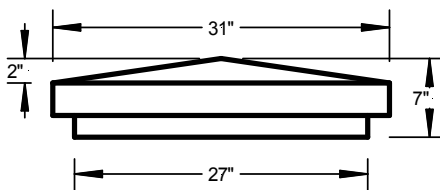

PC - 60

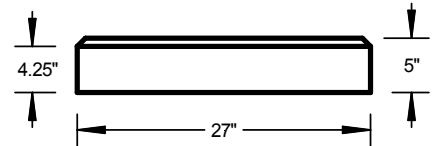

PCFT - 28



PC - BUL28

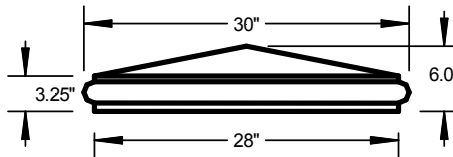

PC - 28D

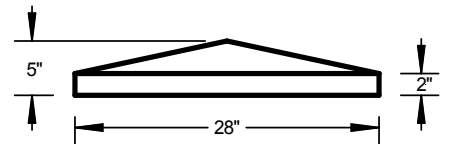

PC - 35

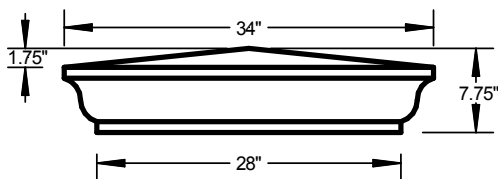

PC - 62

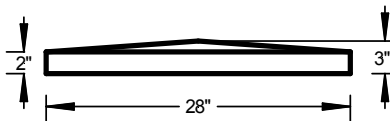

PC - 38

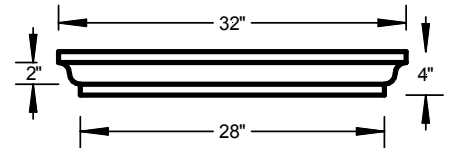

All of our pier caps can be manufactured with holes or flat spots.  
Call for pricing

# CAST STONE PIER CAPS

PC - 31

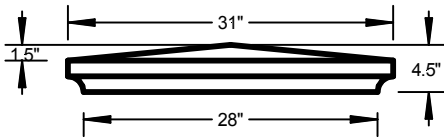

PC - 54B

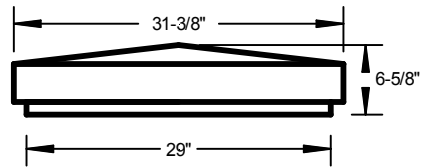

AW - 30

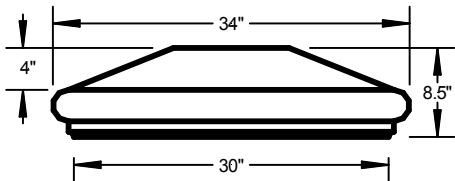

AW - 31

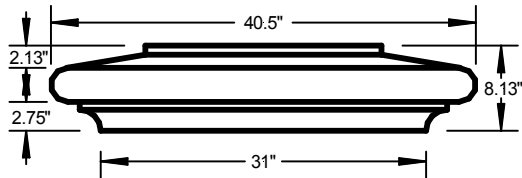

PC - 14

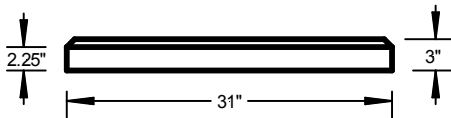

PC - 32D

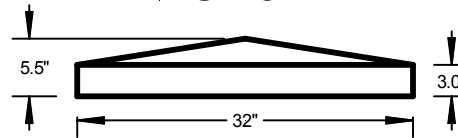

PCT - 33

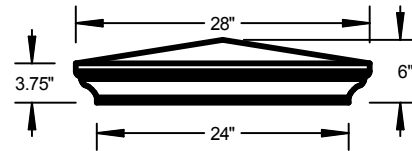
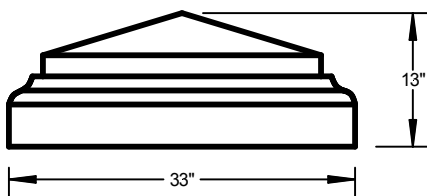

PC - 61

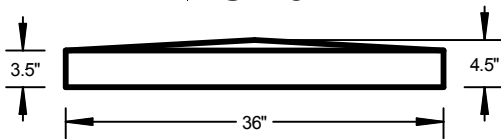

PC - 13 (34")

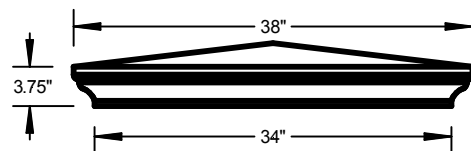

PCF - 36

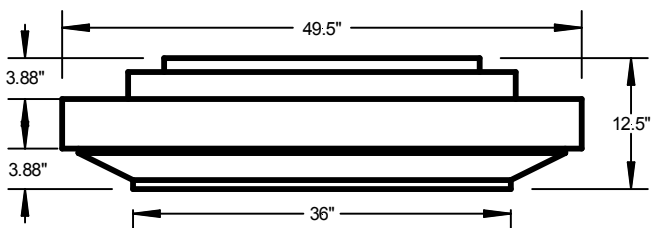

PC-15

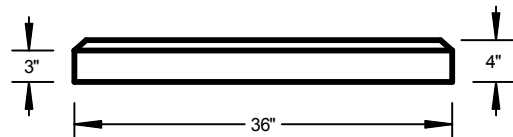

All of our pier caps can be manufactured with holes or flat spots.  
Call for pricing

# CAST STONE PIER CAPS

AW - 40

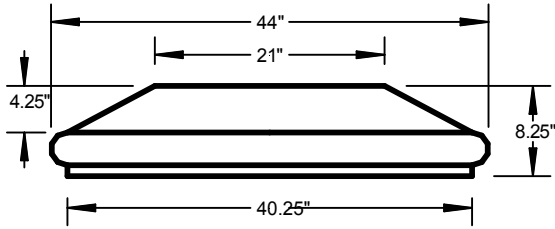

AW - 37

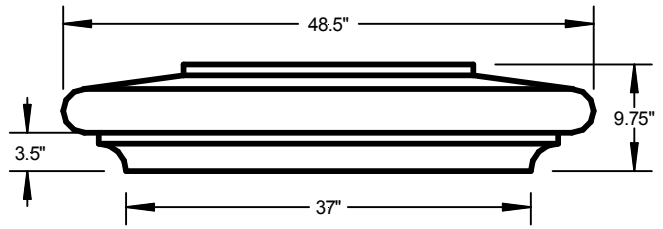

PC - 42D

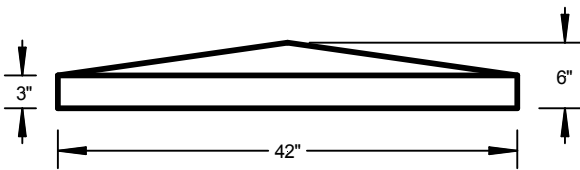

PC - 20

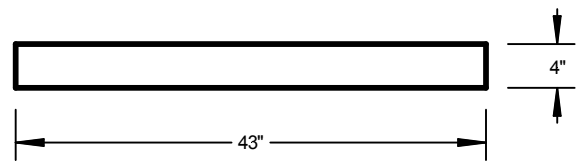

PC - 65

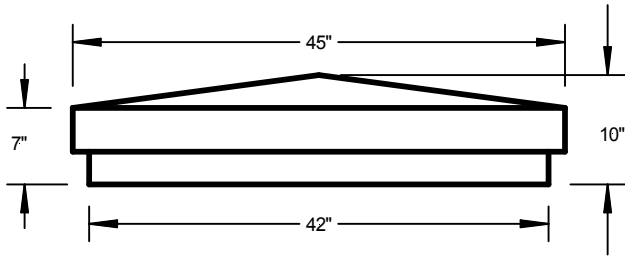

PC - 46T

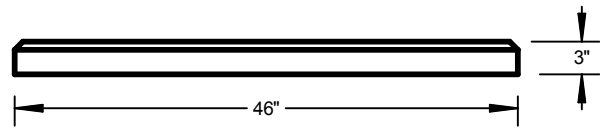

PC-17

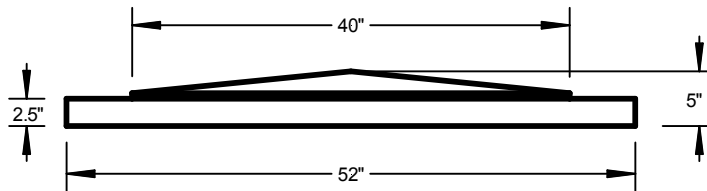

All of our pier caps can be manufactured with holes or flat spots.  
Call for pricing

# CAST STONE RECTANGULAR PIER CAPS

PC - 19

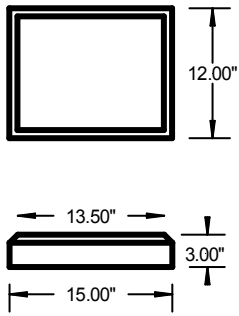

PC - CG1

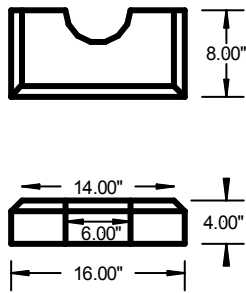

PC - 55

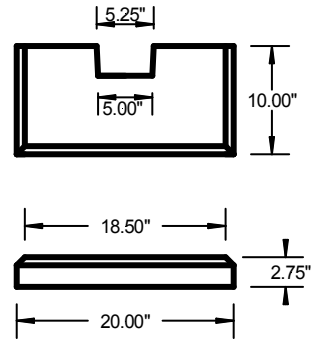

PC - 37

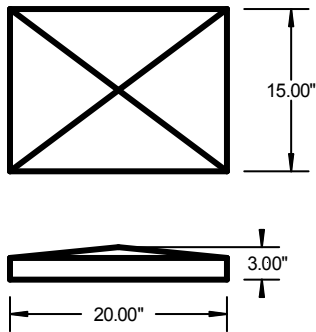

PC - 36

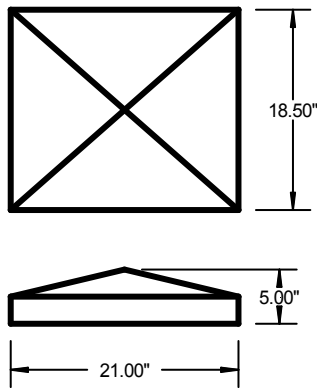

PC - 41

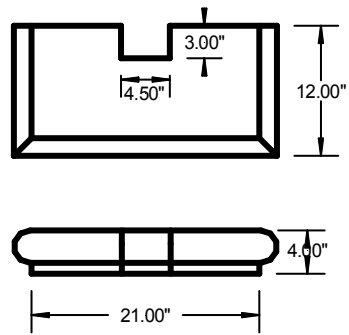

PC - 21

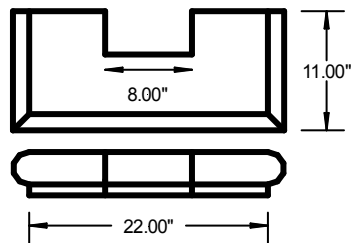

PC - 42

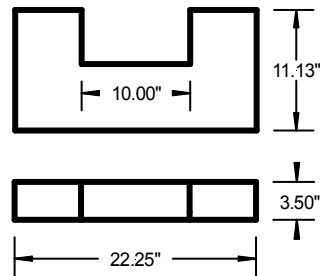

All of our pier caps can be manufactured with holes or flat spots.  
Call for pricing

**The Ark Concrete Specialties, Inc. 713-695-2001**

Aug. 2012

# CAST STONE RECTANGULAR PIER CAPS

PC - 63

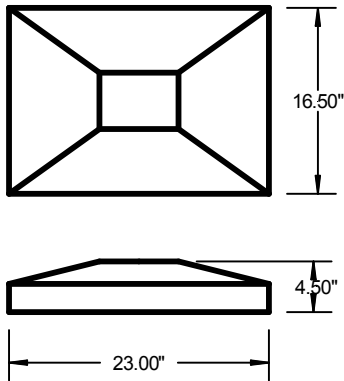

PC - 40

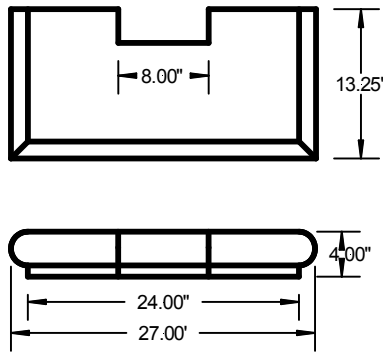

PC - 48

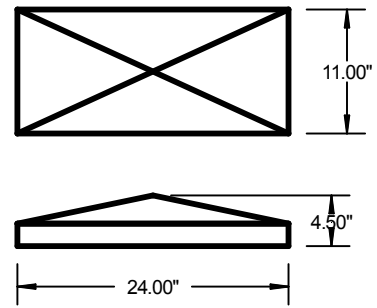

PC - 51

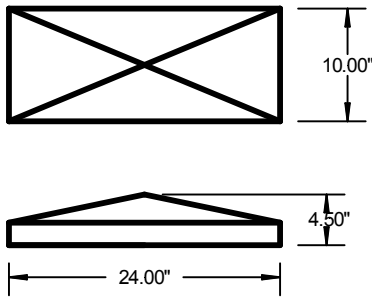

PC - 43

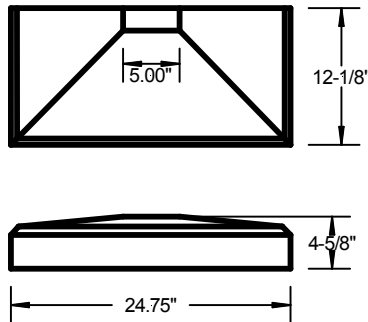

PC - 43 - 1

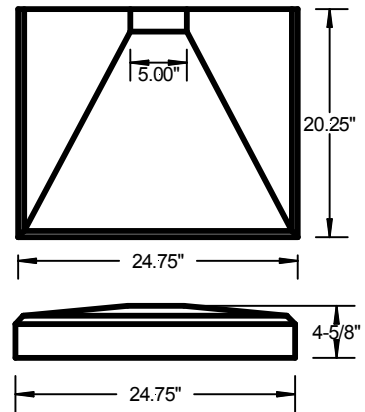

PC-6

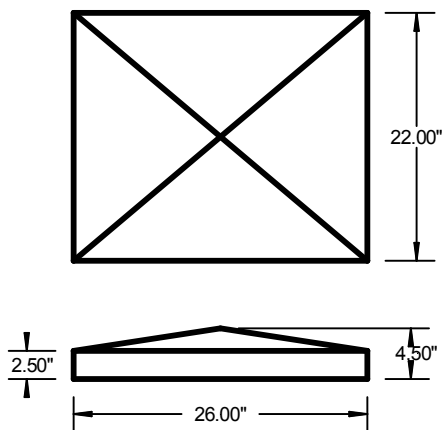

PC - 56

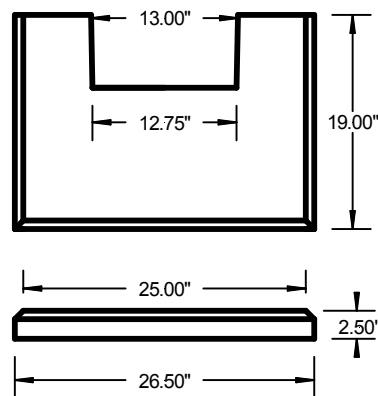

All of our pier caps can be manufactured with holes or flat spots.  
Call for pricing

# CAST STONE RECTANGULAR PIER CAPS

PC - 45

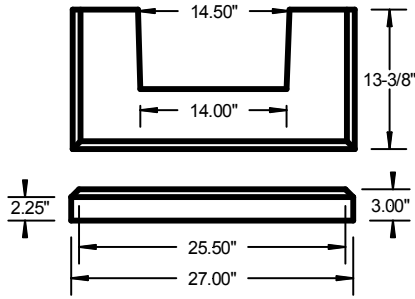

PC - 45B

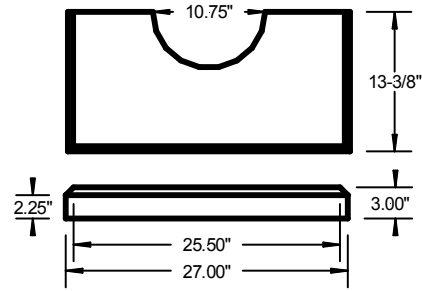

PC - 39

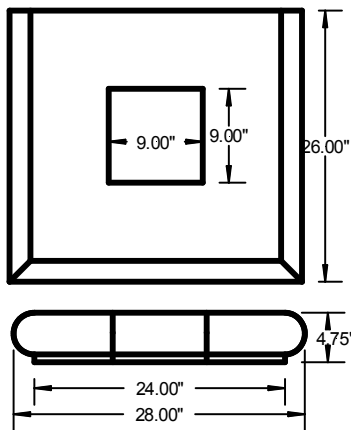

PC - 46R

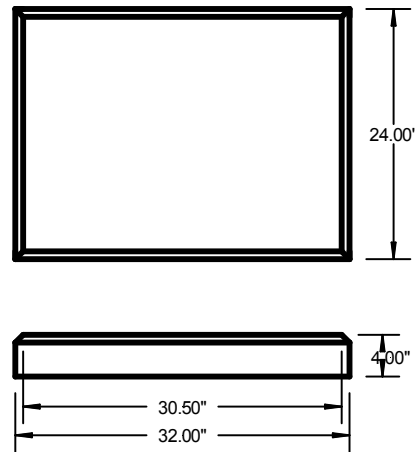

PC - 66

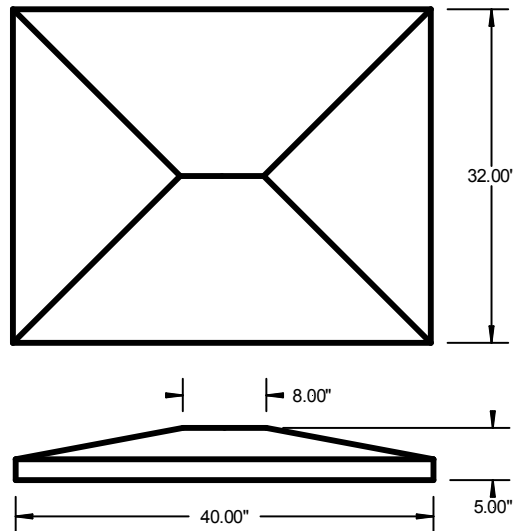

All of our pier caps can be manufactured with holes or flat spots.  
Call for pricing

# CAST STONE POOL COPING

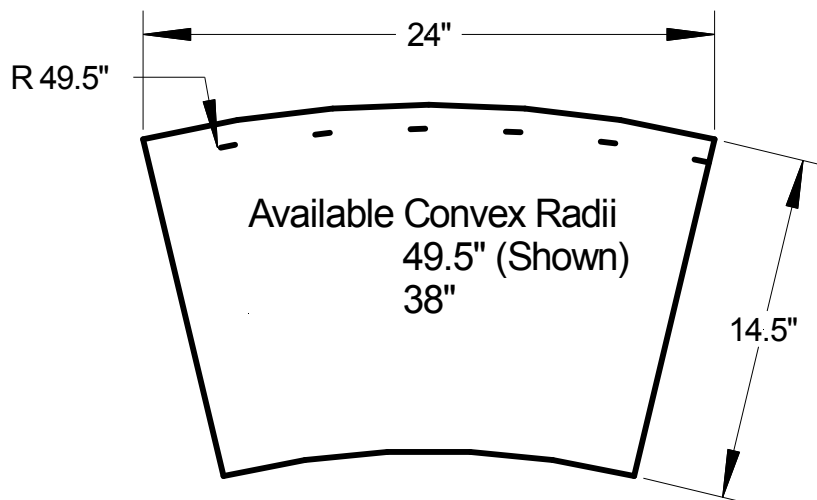
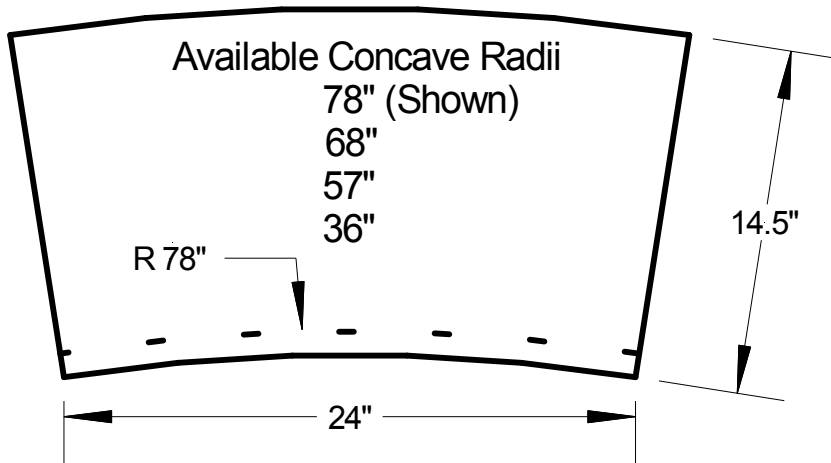
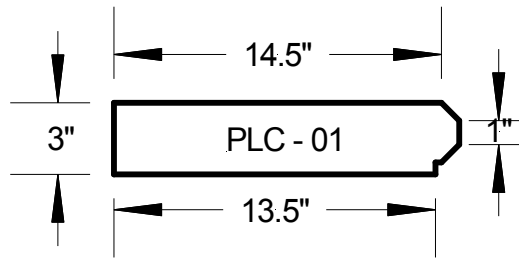



# CAST STONE SQUARE CORNER SIGNS

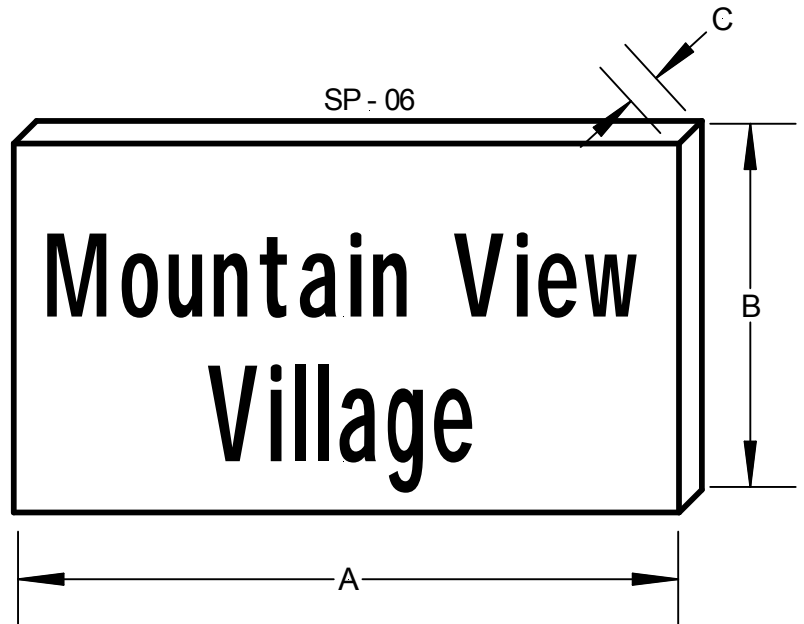
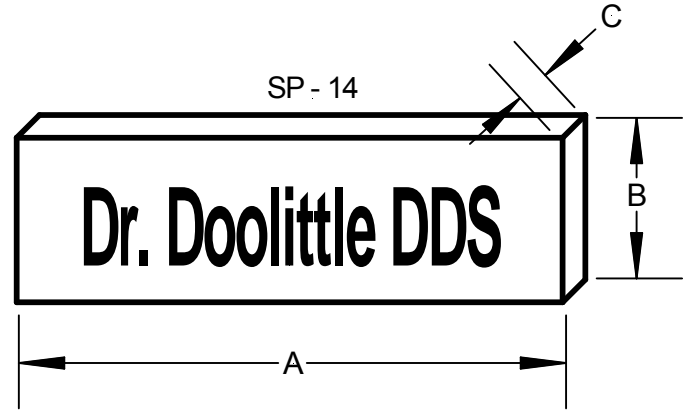
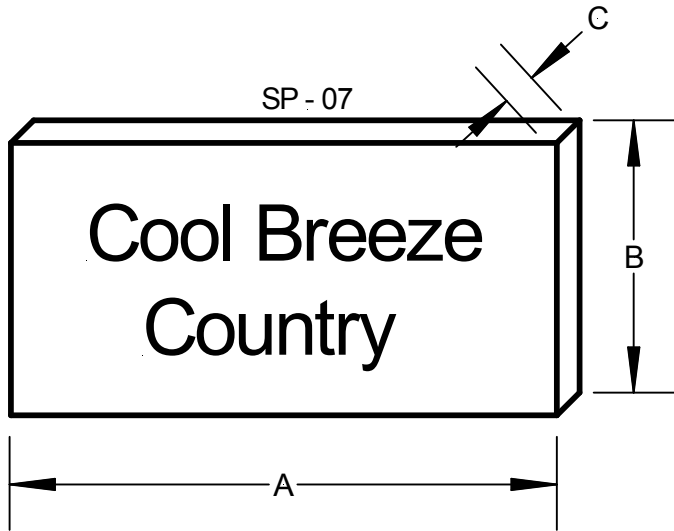

DRY PACK SIGN PANELS			
Item Number	'A'	'B'	'C'
SP - 26	24"	24"	2"
SP - 20	27.25"	27"	4"
SP - 25	30"	30"	4"
SP - 21	36"	24"	3"
SP - 13	44"	12"	3"
SP - 05	48"	11.75"	3"
SP - 14	48"	14.5"	3"
SP - 07	48"	24"	3"
SP - 02	48"	36"	2.5"
SP - 41	48"	48"	3"
SP - 12	50"	20"	2.5"
SP - 03	50"	26"	3"
SP - 09	54"	36"	3"
SP - 08	58.25"	20"	2.5"
SP - 06	58.5"	32.5"	3"
SP - 15	60"	38.5"	3"
SP - 11	70"	18.5"	3"
SP - 16	72"	24"	3"

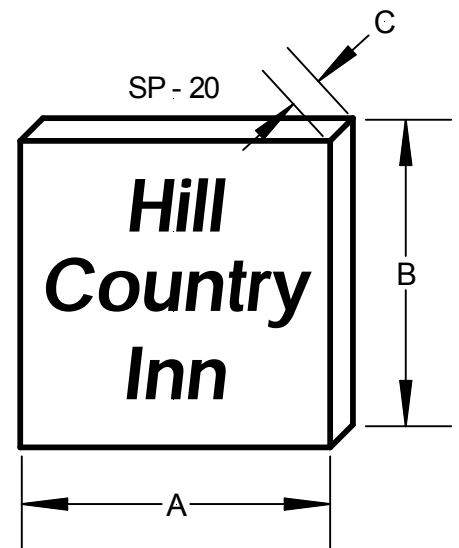
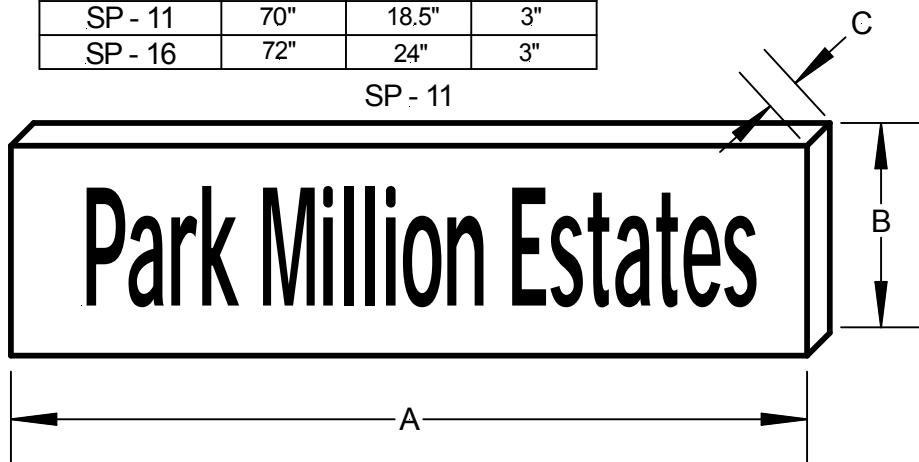

# CAST STONE SQUARE CORNER SIGNS



DRY PACK SIGN PANELS			
Item Number	'A'	'B'	'C'
FP - 119	18"	18"	3"
FP - 106	23"	23"	2.5"
SP - 40	26"	26"	2"
FP - 107	27"	22.5"	2.5"
SP - 38	29.75"	20"	2.5"
FP - 78	30"	10"	2.5"
SP - 39	30"	27"	2.5"
FP - 127	31.5"	24"	2"
SP - 31	33.25"	33.25"	2"
SP - 30	34"	12"	2"
FP - 118	36"	31.25"	2"
SP - 35	40"	19.75"	3"
SP - 37	40"	24"	2"
SP - 29-1	48"	12"	2"
SP - 34	60"	24"	3"
SP - 36	63.5"	39.5"	3"
SP - 33	70"	9"	2"

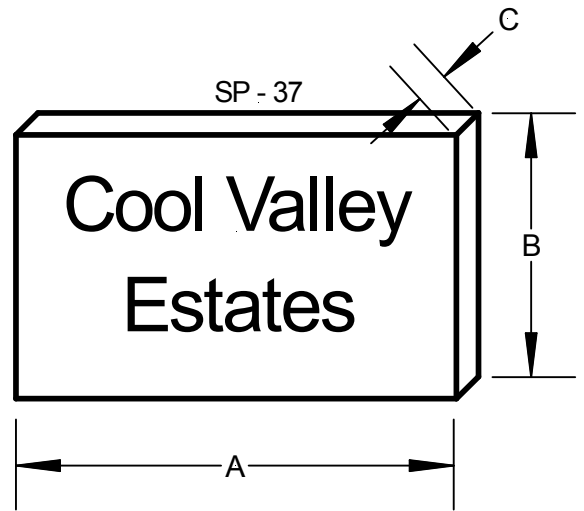
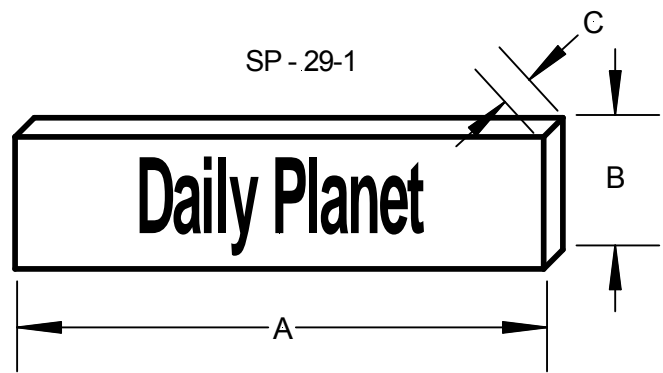
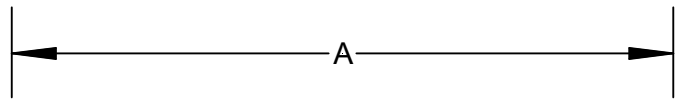

# CAST STONE BEVELED EDGE SIGNS

SP - 28

SP - 28



DRY PACK SIGN PANELS w - 3/4 bevel			
Item Number	'A'	'B'	'C'
SP - 22	24"	12.5"	2.25"
SP - 19-1	24"	13.5"	3"
SP - 23	25"	12"	4"
SP - 19-2	26"	20"	5"
SP - 27	27"	20"	3"
SP - 24	36"	16"	3"
SP - 18-2	48"	30"	3"
SP - 32	52.5"	13.375"	3"
SP - 10	58"	32"	3"
SP - 28	60"	24"	3"

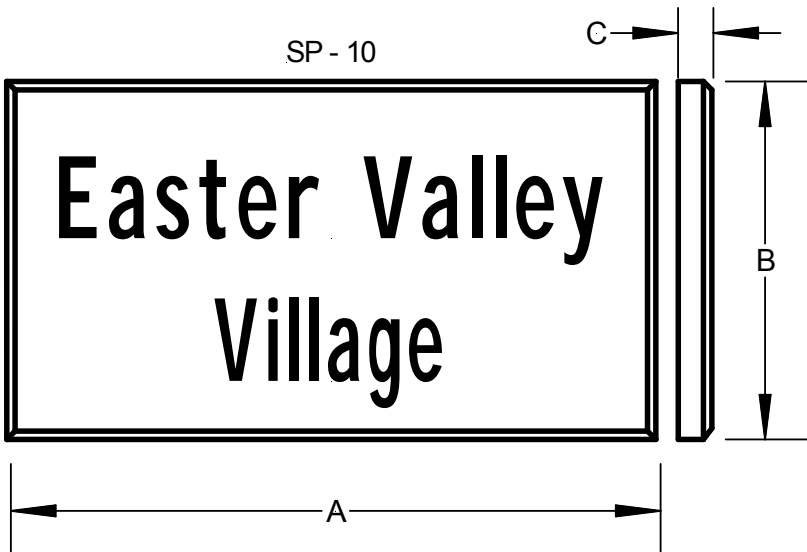
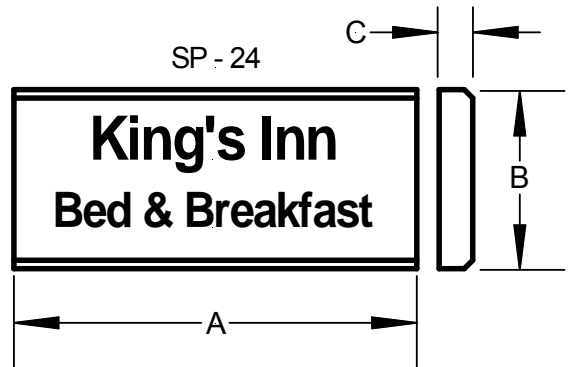
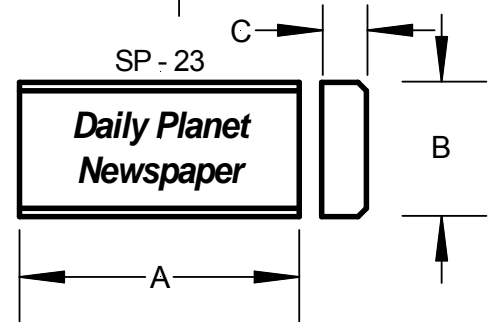
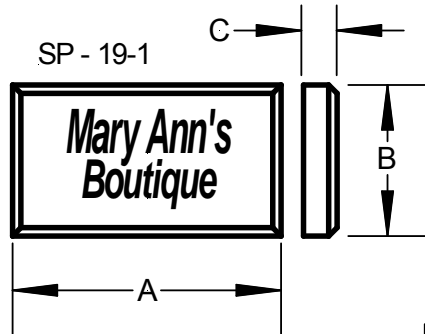

# CAST STONE DESIGNER SIGNS

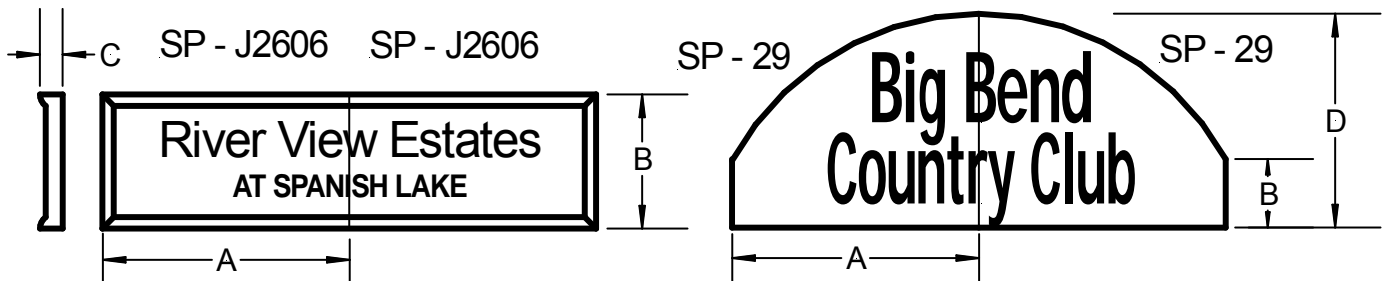
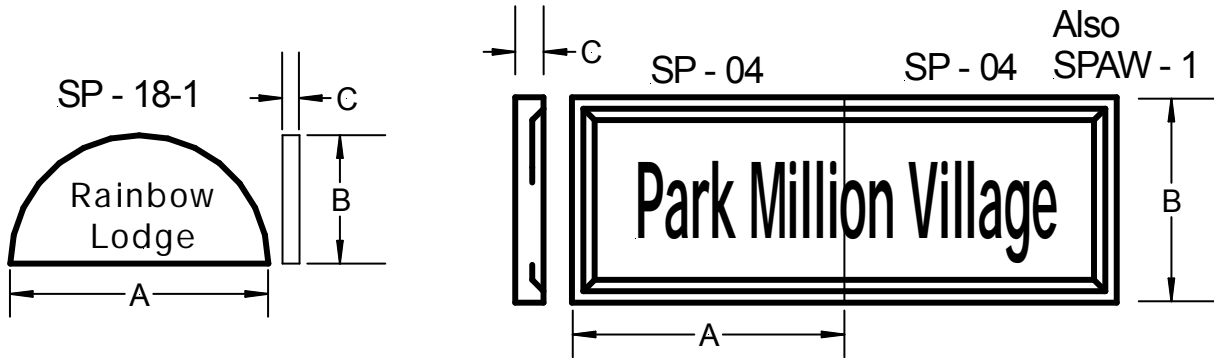

DRY PACK SIGN PANELS				
Item Number	'A'	'B'	'C'	'D'
SP - 29	43.5"	12"	3"	37.5"
SP - 18-1	45.5"	22.5"	3"	
SP - J2606	45.5"	23.5"	4"	
SP - 04	48"	36"	5"	
SPAW - 1	48.75	42"	4"	
SP - 01	60"	38"	3"	50"
SP - 17	67"	12"	3"	30"

# CAST STONE STARS



12" X 12" X 1"  
ACM - 03-SR  
Raised Relief Star



12" X 12" X 2"  
ACM - 04-SR  
Raised Relief Star

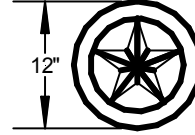

12" X 12" X 1.5"  
ACM - 06-SR  
Raised Relief Star

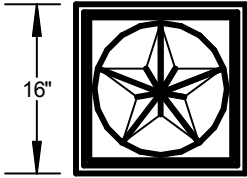

16" X 16" X 3-1/2"  
ACM - 12-SR  
Raised Relief Star

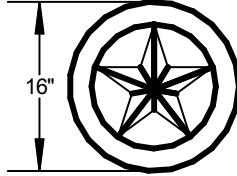

16" X 16" X 2"  
ACM - 07-SR  
Raised Relief Star

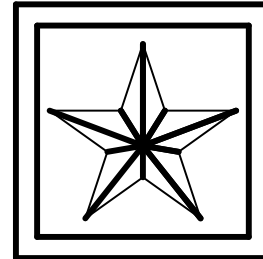

24" X 24" X 2.75"  
ACM - 05-SR  
Raised Relief Star

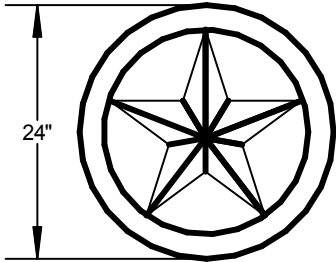

24" X 24" X 2"  
ACM - 08-SR  
Raised Relief Star

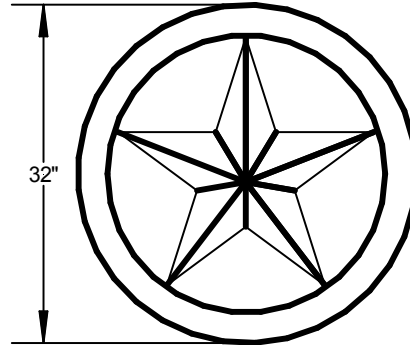

32" X 32" X 2.25"  
ACM - 09-SR  
Raised Relief Star

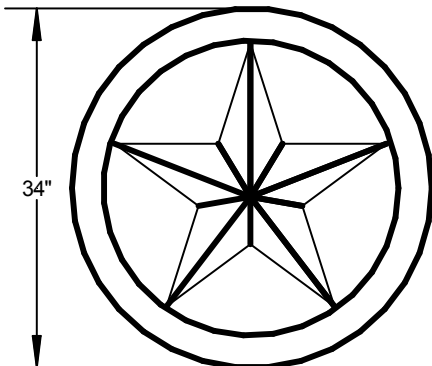

34" X 34" X 3.625"  
ACM - 10-SR  
Raised Relief Star

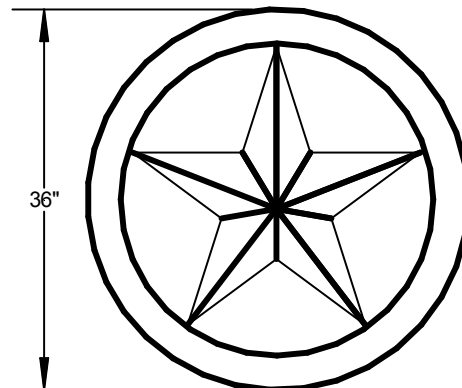

36" X 36" X 3.625"  
ACM - 11-SR  
Raised Relief Star

# Cast Stone Vent Blocks

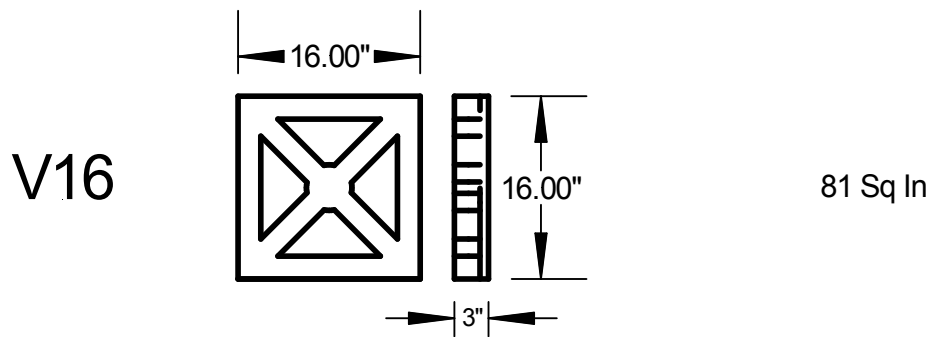
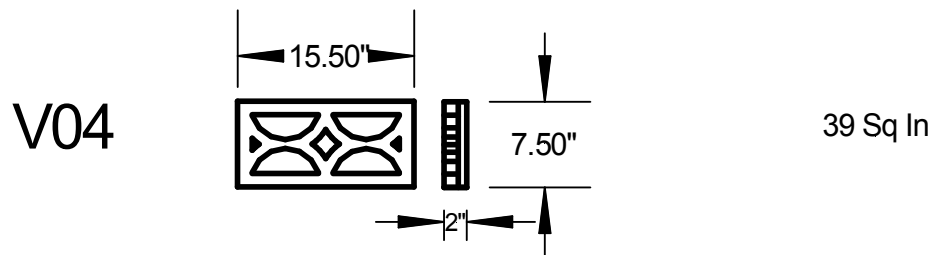
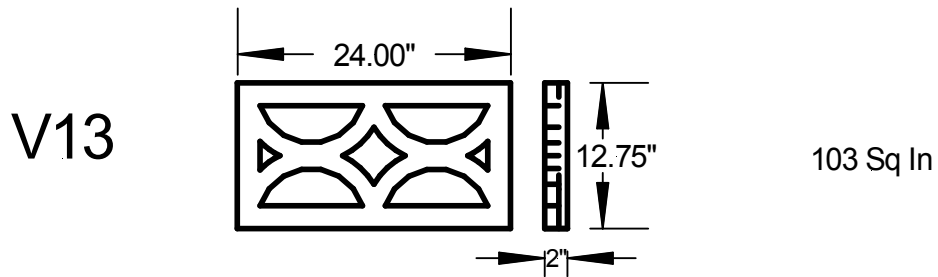
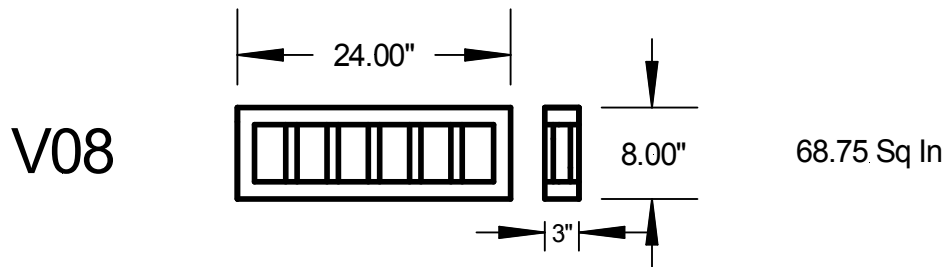
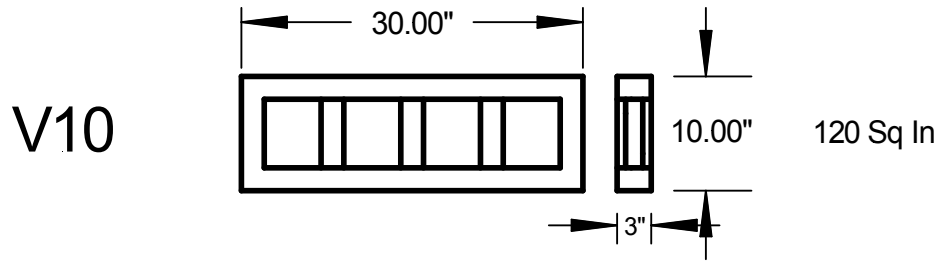

# CAST STONE WALL CAPS

WC - 43  
L = 34.75"

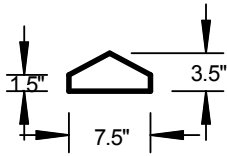

WC - 18  
L = 36"

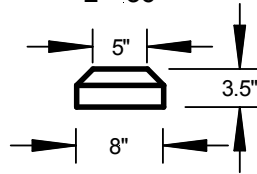

WC - 36  
L = 36"

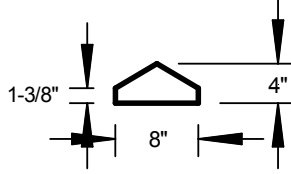

WC-11  
L = 25"

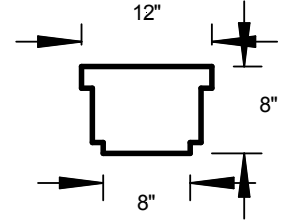

WC - 50T  
L = 30"

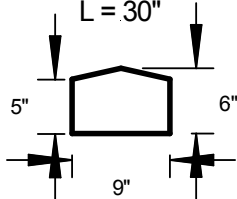

WC - 32T  
L = 24"

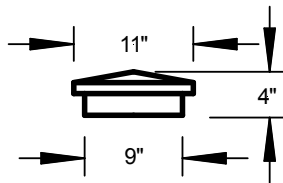

WC - 17  
L = 30"

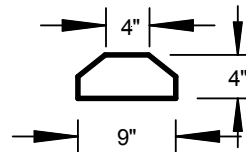

WC - 04T  
L = 24"

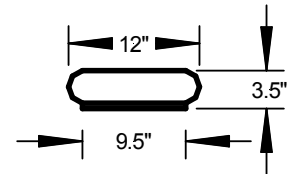

WC - 46T  
L = 24", TL = 32"

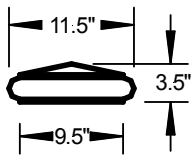

WC - 05  
L = 24"

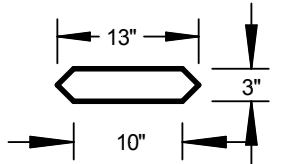

WC - 26  
L = 28"

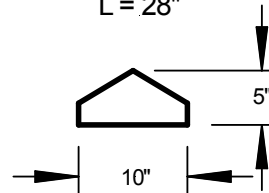

DWC 10T  
L = 32"

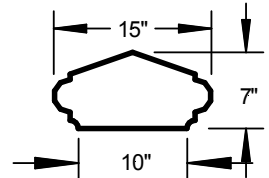

BR - 48  
L = 48"

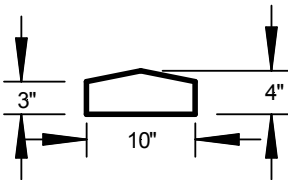

WC - 45  
L = 36  
R = 144", 31"

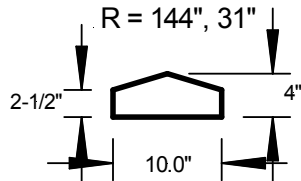

WC - 12  
L = 36"

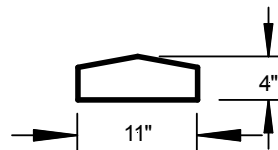

WC - 38  
L = 34.5"

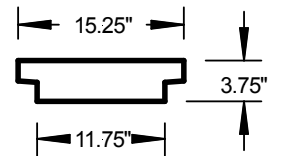

WC - 02  
L = 24"

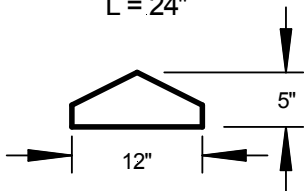

WC - 03T  
L = 24"

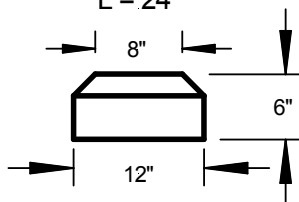

WC - 06  
L = 24"

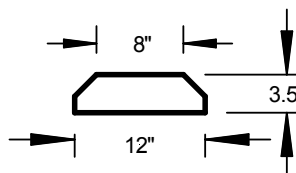

WC - 07T  
L = 24"

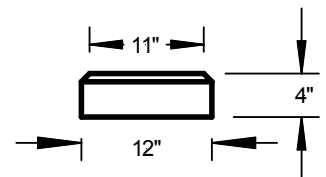

# CAST STONE WALL CAPS

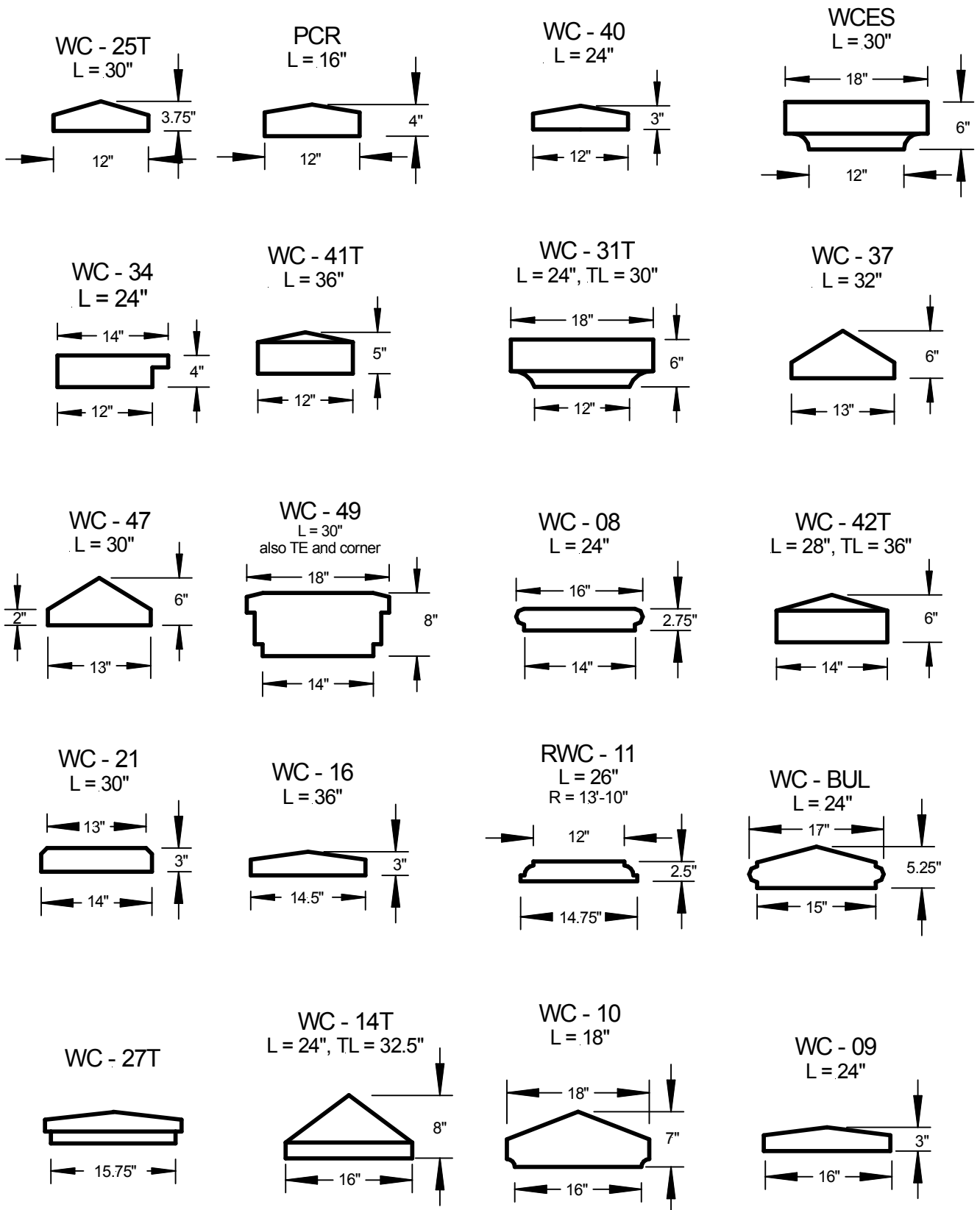



# CAST STONE WALL CAPS

WC - 19  
L = 29.5"

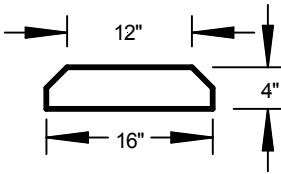

WC - 35  
L = 30"

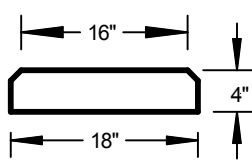

WC - 01  
L = 24"

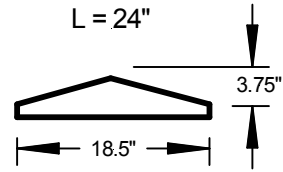

WC - 29  
L = 24"

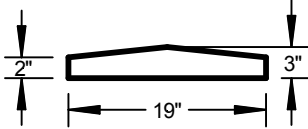

WC - 15  
L = 27"

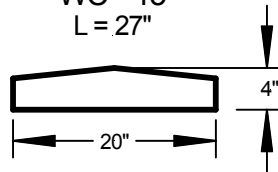

WC - 20  
L = 36"

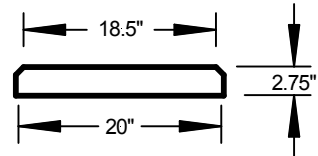

WC - 44T  
L = 38.5"

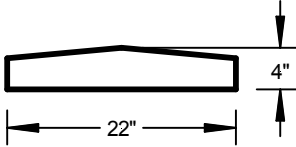

WC - 13T  
L = 46"

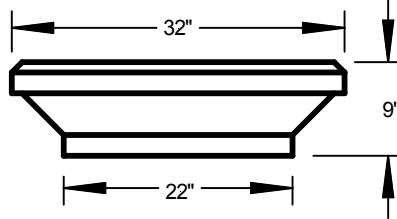

PC - 46B  
L = 36"

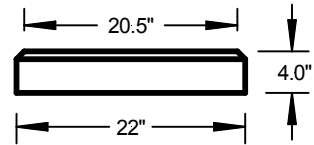

WC - 28

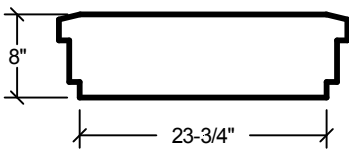

WC - 33  
L = 60"

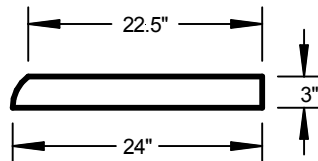

WC - 48  
L = 30.75"

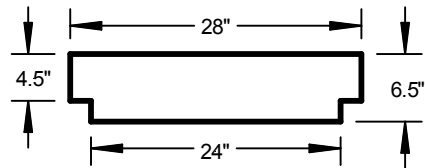

WCB - 24T  
L = 35"

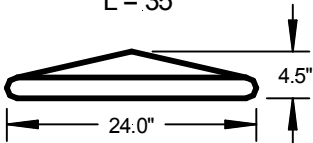

WC - 24  
TE = 36"  
L = 23"

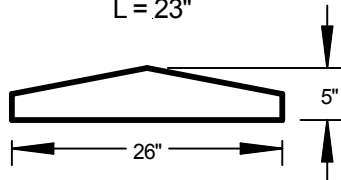

WC - B  
L = 38"

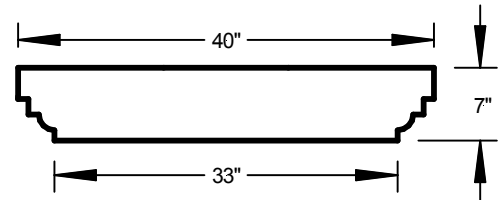

WC - 23  
L = 39", TE

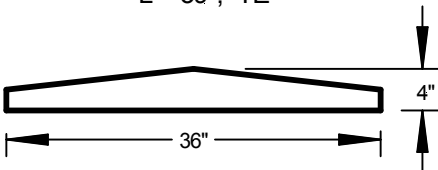

WC - 22  
TE = 49"  
L = 28.5"

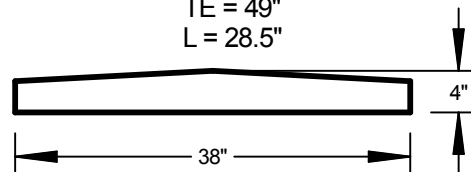

# CAST STONE WATER TABLE

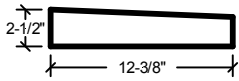

**SL-18**  
L&R Returns  
24" length

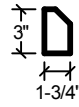

**SL - 12**  
30" Length

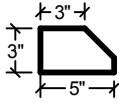

**SL - 14**  
36" Length

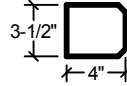

**SL - 23**  
38.5" Length

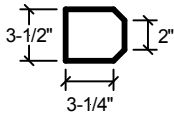

**SL - 34**  
38.5" Length

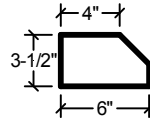

**SL - 03**  
36" Length

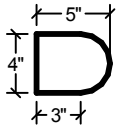

**BN - 4**  
36" Length

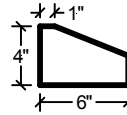

**SL - 06**  
36" Length

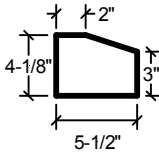

**SL - 16**  
36" Length

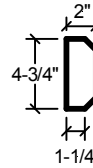

**FP - 53**  
24" Length

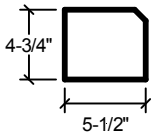

**SL - 26**  
42.5" Length

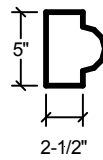

**BM - 03**  
24" Length

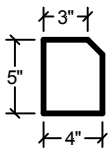

**SL - 13**  
24" Length

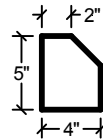

**SL - 07**  
24" Length

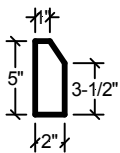

**SL - 11**  
30" Length

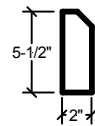

**SL-01**  
no returns  
24" length

# CAST STONE WATER TABLE

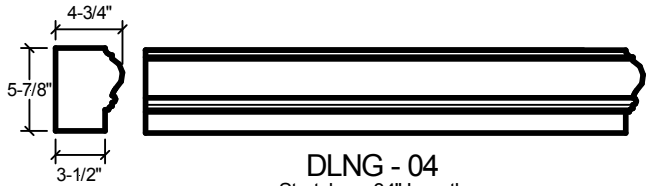

**DLNG - 04**  
Stretcher - 34" Length  
Returns - 31" Length

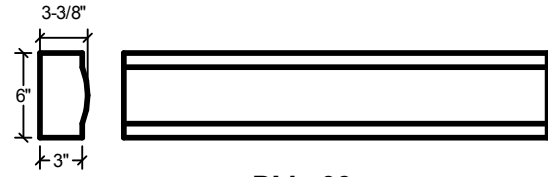

**BM - 06**  
30" Length

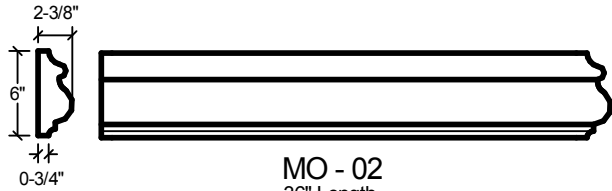

**MO - 02**  
36" Length  
Returns - 30" Length  
Radii available: 28", 30", 29", 19.5"

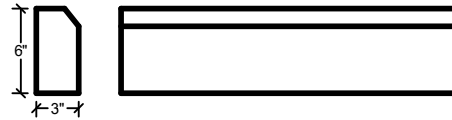

**SL-19**  
L&R Returns  
40" length



**MO - 03**  
36" Length  
Radii available: 40", 39", 37", 66"

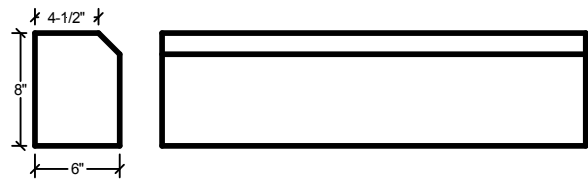

**SL - 20**  
No returns  
Stretcher - 30" Length

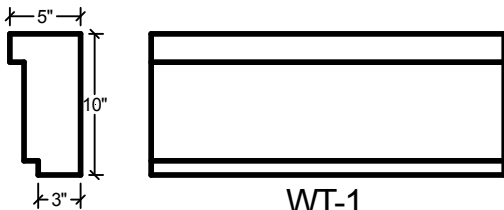

**WT-1**  
L&R Returns  
25" length

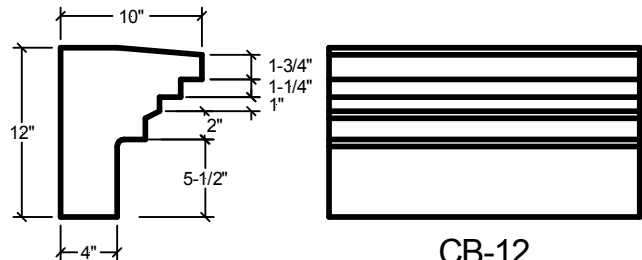

**CB-12**  
L&R Returns  
42" length

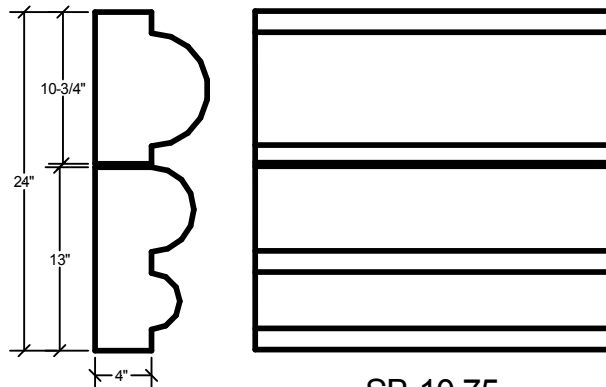

**SB-10.75**  
L&R Returns  
24" length

# CAST STONE WINDOWSILLS

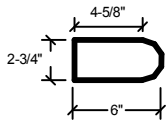

**TDK - 01**  
24" length

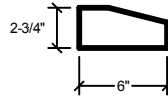

**SL - 24**  
30" length

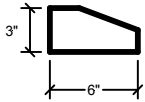

**SL - 24A**  
30" length

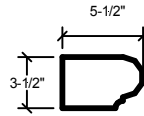

**DLNG 1**  
30" Length  
L & R Return

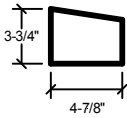

**SL - 09**  
30" length

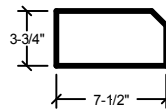

**SL - 27**  
48" length  
aval. radius 136"

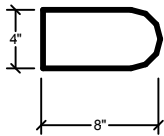

**SER - 01**  
24" length

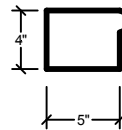

**SL - 17**  
48" length

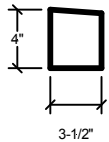

**SL - 08**  
48" length

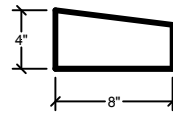

**SL - 04**  
32" length

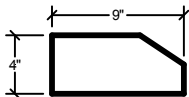

**SHS-01**  
36" Length

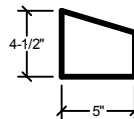

**SL - 05**  
32" length

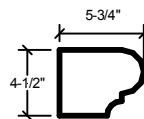

**DLNG 2**  
36" Length  
L & R Return

# CAST STONE WINDOWSILLS

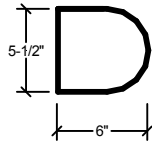

ACM - 01  
48" length

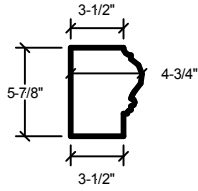

DLNG 4  
31" Length  
L & R Return

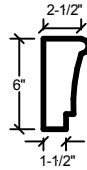

ZM-02  
36" Length  
L & R Return

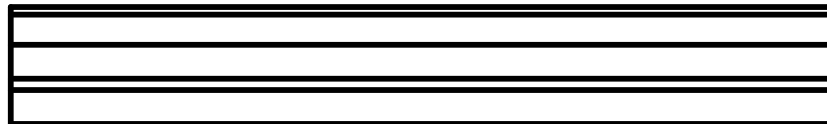
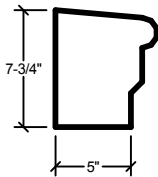

BM - 12  
54.5" length

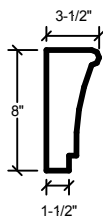

ZM-01 BLOK  
36" Length  
L & R Return

# CAST STONE WINDOW SURROUNDS

WSRD(radius)

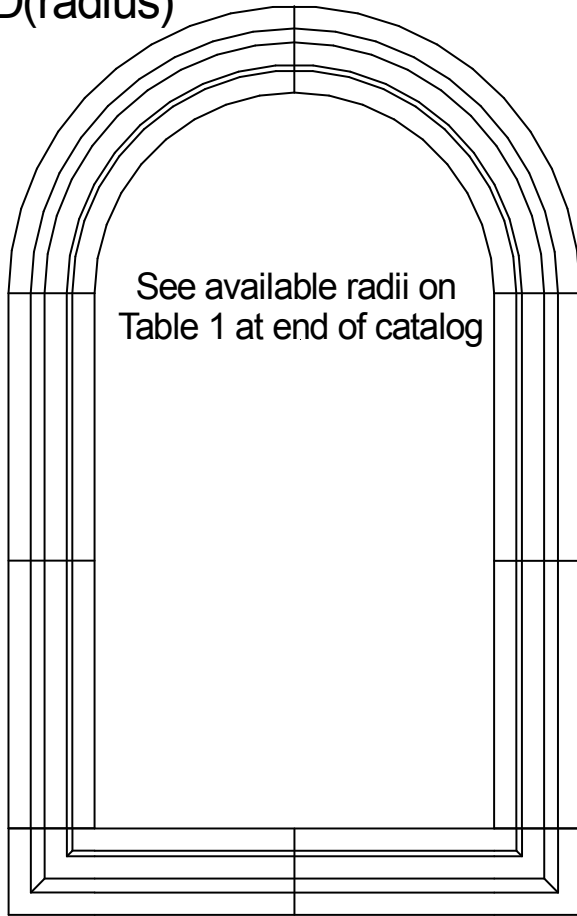

WSSD

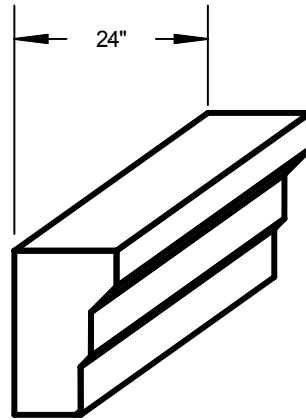

WSSD  
Return

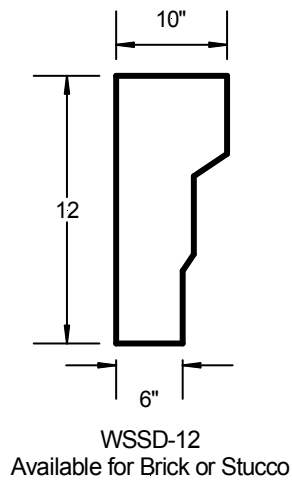
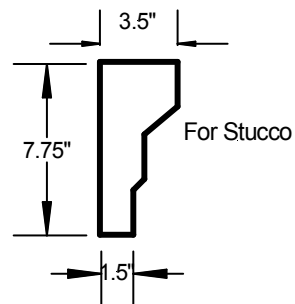
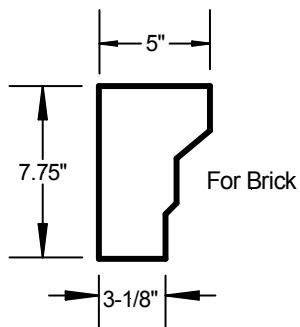
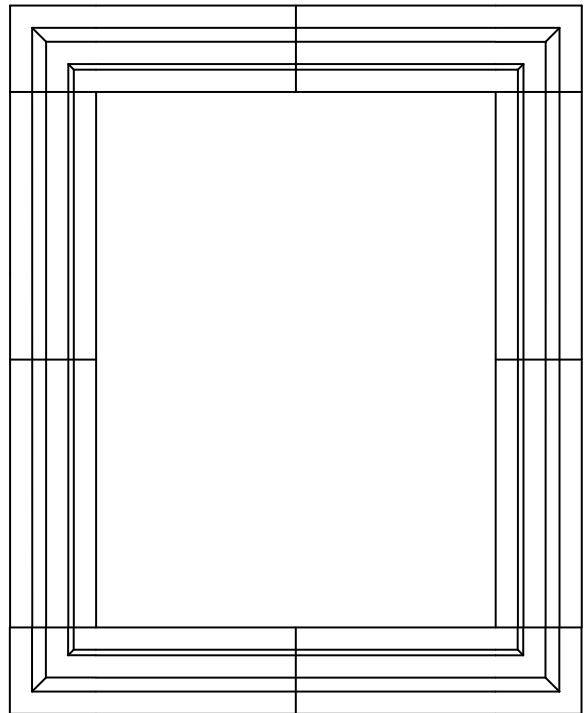

# CAST STONE WINDOW SURROUNDS

## Double Chamfer

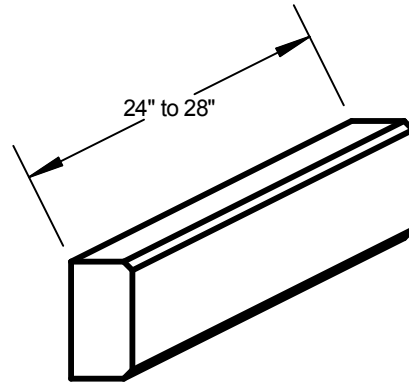
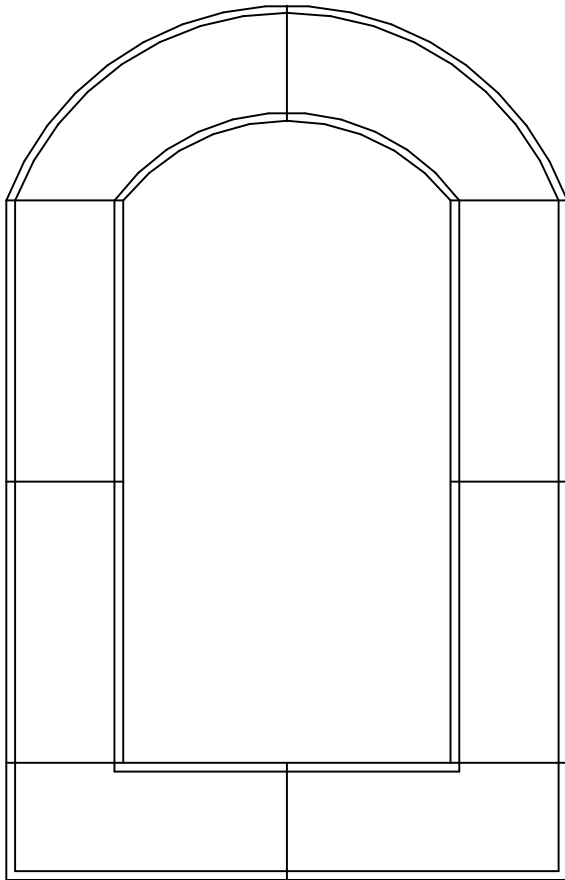

See available radii on  
Table 2 at end of catalog

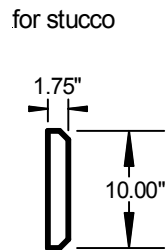
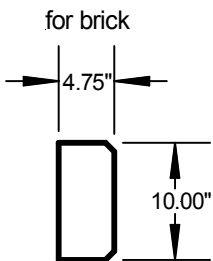
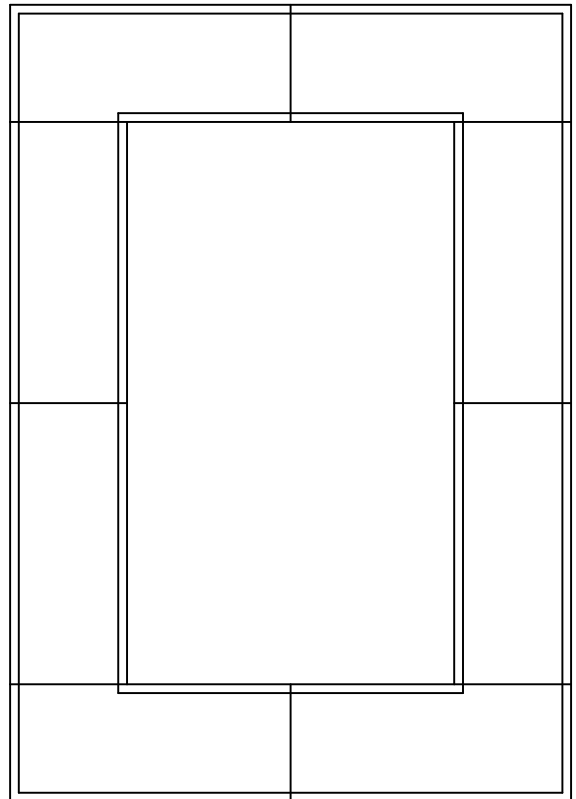

heights available in 4", 5", 6", 8", 10", 12" with 3/4" chamfer  
and same depths as shown

# CAST STONE WINDOW SURROUNDS

See available radii on  
Table 3 at end of catalog

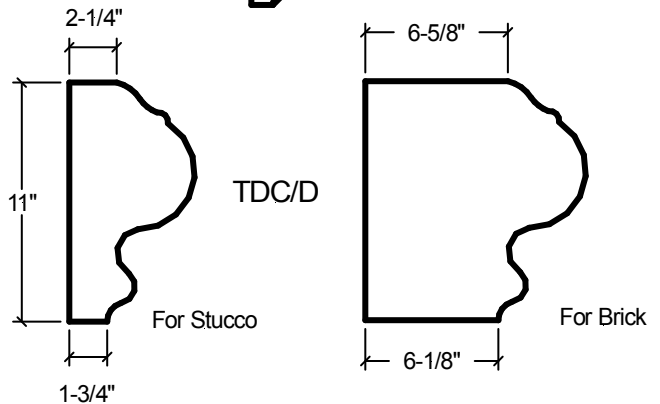
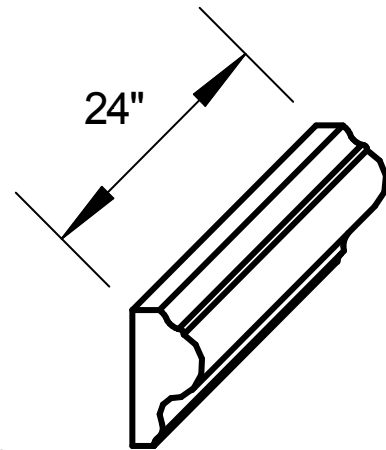
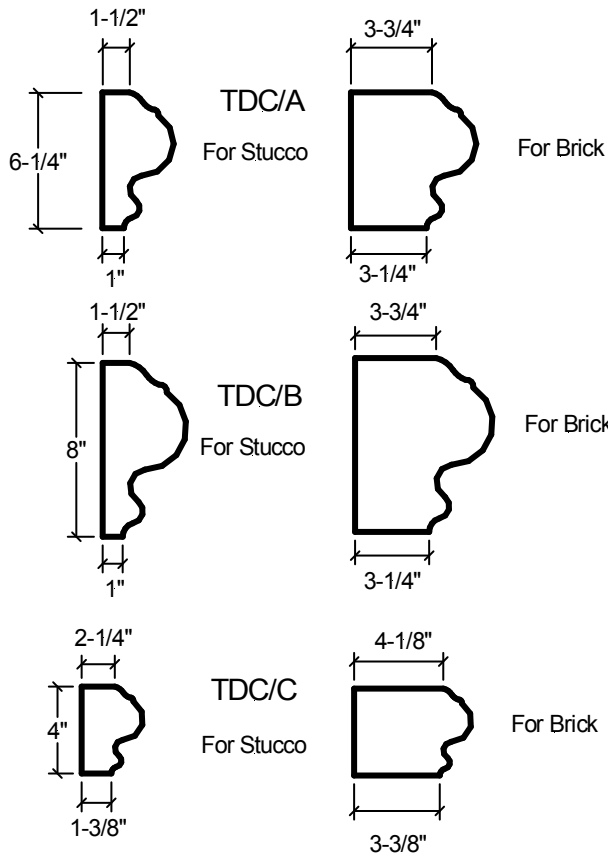
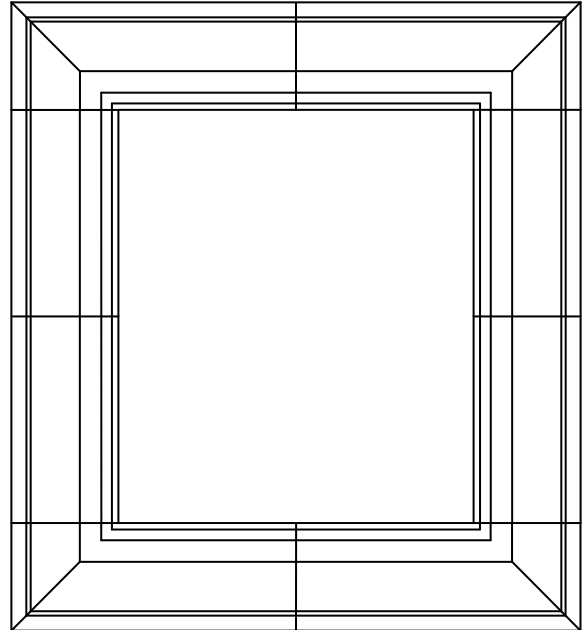
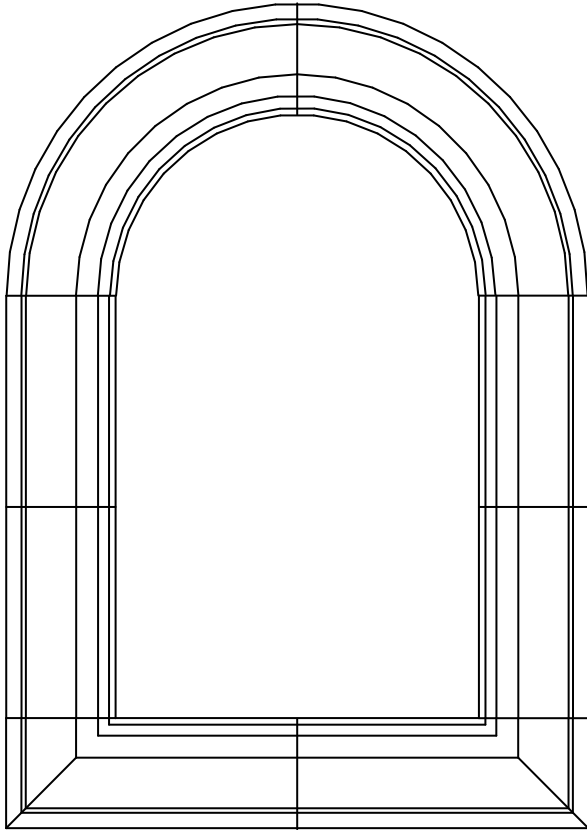



# TABLE 1

## WSRD - WINDOW SURROUND

WSRD 8"		WSRD 12"
Radius	Length	Radius
9"	26"	36"
12"	31 3/4"	44"
15"	36"	48"
17"		66"
18"	40"	72"
20"	43 1/2"	
24"		
28"	28 1/4"	
30"	29"	
33"	32"	
36"	34 1/4"	
39.5"	24"	
42"	33 1/2"	
48"	29 1/2"	
48"	32"	
54"		
60"	35 1/2"	
66"	20 1/2"	
72"	33 5/8"	
84"	32"	
7' 6"	30"	
8' 6"	32"	
9' 6"		
11' 3"	24"	
17'	25"	
54'	34 1/4"	

## TABLE 2

### DOUBLE CHAMFER - WINDOW SURROUND

DC - 4"
Radius
12"
18"
21"
24"
30"

DC - 5"
Radius
25"
29"

DC - 6"	
Radius	Length
6"	
8"	24"
12"	
15"	
17"	23"
18"	
23' 6"	40"
23' 6"	41 3/7"
24"	24"
26"	
36"	
50"	
51 7/8"	
52"	
60"	35"
62 1/4"	
72"	26"
80"	
84"	38"
92 3/4"	

DC - 8"	
Radius	Length
12"	32"
18"	40"
24"	50"
30"	38"
36"	33"
39"	
44"	
50"	41"
54"	38"
64"	
72"	40"
7' 6"	36"
14' 2"	38"
21'	42"
28'	
38'	36"
40' 5 1/2"	
54'	36"

DC - 10"
Radius
18"
24"
27"
36"
44"
14'
50.5'

DC - 12"
Radius
39"
45"
51 7/8"
61 1/4"
92 3/4"

## TABLE 3

### TDC/A, B, C - WINDOW SURROUND

TDC/A				TDC/B				TDC/C
Radius	Length	Radius	Length	Radius	Length	Radius	Length	Radius
10"	22"	42"	36"	6 3/4"		58 3/4"	30"	9 1/2"
10"	23"	42"	47"	11"	26"	60"	35"	12"
12"	25"	42"	48"	11"	30"	60"	36"	13"
13 1/2"	27"	42"	37"	15"	32"	63 1/4"	30"	18"
15"	30"	48"	27"	15"	33"	64 1/4"	36"	21"
17"	32"	51"		18"	36"	65"	33"	24"
18"	34"	56"	33"	18"	37"	65"	50"	69"
19"	35"	60"	34"	20"	39"	65"	51"	
20"	38"	66"	26"	22"	30"	65"	33"	
20"	36"	72"	36"	22"	42"	78"	42"	
21"	38"	72"	39"	24"	45"	84"	30"	
22"	36"	84"	32"	24"	49"	9'	38"	
24"	40"	84"	33"	26"	48"	12' 10 1/2"	36"	
24"	45"	7' 6"	26"	26"	54"	14'	37"	
24"	30"	7' 11"	32"	30"	29"	14' 4"		
27"	33"	9' 6"	31"	33"	41"	54'	36"	
28"	25"	9' 6"	32"	36"	33"			
30"	36"	12'	32"	38"	35"			
33 7/8"	30"	13' 5"		38"	36"			
33"	30"	25'	31"	39 3/8"	36"	1 R	30"	
36"	42"	38'	30"	42"	27"	1 L	30'	
38"	33"	38'	30 1/2"	48"	26"	1 ST	24"	
39"	34"			48"	28"			
39"				53"	31"			
39 3/8"	35"			53"	33"			
39 3/8"	36"							