

CUB

POW WOW BOOK



SCOUTS

Revised Edition

Released on CD only with an improved .pdf of the original 2010-2011 Book and a supplemental file with additional content - August 2011.

Look for Red boxes, like this, that point out new features & content



BOY SCOUTS OF AMERICA®
Utah National Parks Council



THANK YOU AND ACKNOWLEDGMENTS

Give a big hand, a “round of applause” and a cheer”...



for the **Pow Wow Book Committee** and the hundreds of hours they’ve spent putting together this year’s book in a whole new format. (Who after doing their best, do apologize for any typos and other mistakes that may appear in this book)

- Professional Advisor and Cover Design Mark Baldwin (Silver Lake)
- Committee Chair and Research Specialist..... Karole Scott (Hobble Creek)
- Editor and Research Specialist Annaleis Smith (Black Hawk)
- Research Specialist Felice Clements (Hobble Creek)
- Publisher Liberty Press (Springville, UT)
- CD Replication..... CDI Media, (Salt Lake City UT)

Thanks and cheers for the following Cub Scouters who helped update the content in Section 2: Evan Clements (Hobble Creek), Stephanie Peck (Zion), Bobbette White (Millard), and VaLayne Ostler (Alpine).

And a great big “**Thanks**” also to the proof readers: Monica Baldwin and Kathy Worthen.

About the cover— Ever feel like things are spinning out of control around you? This Pow Wow book is designed to give you the ideas and resources so that you as a Cub Scout leader can find, deliver and enjoy the **Fun and Adventure** that IS Cub Scouting.

Copyright ©2010 Utah National Parks Council, Boy Scouts of America

Materials in this book and the accompanying CD may be reproduced and used to provide program materials and to promote the Cub Scout program in your council, district, pack and den. Councils and districts may use these materials otherwise free of copyright or license for their Pow Wow books. Materials in this book and on the CD may not be used by any other individual or group for commercial gain or profit.

WHAT IS AKELA'S COUNCIL?

This is an exciting 4-1/2 day Cub Scout Leader training course for those who have completed the Cub Scout Leader Basic Training. This fast-paced and inspiring training covers den doodles, den yells, relationships, Cub Scout forms, resources, insignia, Academic and Sports program, skits, puppets, Internet Advancement, Internet Re-Chartering (charter renewal), BSA and council policies, Webelos Outdoor Experience, and much more.



WHEN AND WHERE DOES IT HAPPEN?

See 2012 dates & locations below

~~In 2011, Akela's Council will be held at Tifie Scout Camp at Mountain Dell on July 5-9.~~ Past participants have deemed Akela's Council to be the most motivating and enjoyable training they have ever completed. Registration is limited so register early for this once-in-a-lifetime experience. **This training meets the needs of all Cub Scout leaders.**

HOW DO I APPLY?

Register on-line at <http://www.utahscouts.org/akelascouncil> and click on 'Online' under 'How Do You Apply?' Or fill out the application below and enclose a check or money order for the \$65.00 required deposit, or the full \$115.00 fee, and send it directly to:
Boy Scouts of America • ATTN: AC Registration • 748 North 1340 West • Orem UT 84057

QUALIFICATIONS

1. Be registered with the Boy Scouts of America
2. Complete Cub Scout Leader Basic Training before course
3. Provide a complete adult medical form

Partial scholarships may be available. Contact your district Cub Scout Trainer or call Council Services at (801) 437-6222 for more information.



Utah National Parks Council, Boy Scouts of America

AKELA'S COUNCIL 2012 APPLICATION

July 24-28, 2012

Scofield Scout Camp
at Frandsen Scout Reservation

September 11-15, 2012

Tifie Scout Camp
at Mountain Dell

First Name _____ Last Name _____

Phone _____ Address _____

City _____ State _____ Zip _____ Current Position in Scouting _____

_____ Email _____ Current BSA _____

registration with Pack # _____ or _____ District _____

Amount PAID with application \$ _____ (\$65.00 deposit must be paid at time of application)

PLEASE CIRCLE YOUR T-SHIRT SIZE: Medium Large X Large XX Large XXX Large

**All fees must be paid 30 days prior to the course.
 There will be no refunds issued after 30 days prior to the course.**

The Magic of Scouting

P P

QUIZ!!

How much do Scouts make on their popcorn sale?

(You may be surprised)

Actually, Scouts make a whopping 70% from the popcorn they sell. And all of it stays local for the packs and troops and council right in your Utah community. Kids have a great time in Scouting, and the popcorn you purchase makes it possible.



Thank you.



2011 POPCORN SALE SIGN-UP FORM

“Yes, we’re ready to get started so we can Fund our Ideal Year of Scouting Adventure! Sign us up for the 2011 Scout Popcorn Sale!”

Unit type _____ Unit Number _____ District _____

Unit Popcorn Kernel (Unit Contact) _____

Address _____ City _____ Zip _____

Phone Number _____ Email _____

2011 Popcorn Sales total: \$ _____ 2011 Popcorn Sales Goal \$ _____

For additional details get this information to your District Popcorn Kernel or contact your District Executive

Camp Jeremiah Johnson

Cub Scout Day Camp - Webelos Camp - Activity Days Girls

Join us in 2011 for:

Adventure on the High Seas

For current flier see the Aug 2011
Supplemental File on this CD.



Register online at utahscouts.org or call 801-437-6222

Located just outside of Springville up Hobbles Creek Canyon

Family Camp



"What's UP?"

(Discovering the World above us)

**July 2-4, 2012 or July 5-7, 2012
at Maple Dell Scout Camp**

Family Camp is an exciting, three day camp for the entire family at Camp Maple Dell. The camp offers fun-filled activities for all age groups including shooting sports, crafts, hiking, swimming (*There will be NO swimming pool available this year*), row boats and canoeing, games and evening campfire programs. Mothers, do you ever wonder what your boys do at Scout camp? Now you can find out and participate in the same activities that your sons do. Come and make family memories that will last a lifetime.

Bring your tent or trailer, and your camping gear for a wonderful time on the mountain.

The most current information can be found online at

Additional information available at: utahscouts.org/camps/familycamp

CUB SCOUT FAMILY FREEZE



Watch www.utahscouts.org for dates and location.

Family Freeze is a day activity for Cub Scouts, Webelos, Tiger Cubs, their Parents, and brothers and sisters age 6-11.

Join us for this “Winter Funderland” with hours of Sledding, Snowballs, Hot Chocolate, Snow sculptures, snowmen, obstacle courses races and more This will be the ultimate Winter event for Cub Scouts and their families in the Utah National Parks Council.

Your day will be spent outside in the Fresh winter air playing in the SNOW!

Hot chocolate will be available between some of the events to keep everyone warm.

Why: To provide a winter outdoor experience for Cub Scouts

Fee: \$10 “not refundable” to cover cost of Food and serving supplies, Equipment, Sanitation, Program supplies, first aid supplies, Oh yeah! did I mention food and all the hot chocolate you could possibly drink.

For information go to: utahscouts.org/familyfreeze



Every commemorative issue of Boys' Life will be
SPECIAL! VALUABLE! COLLECTIBLE!



**SUBSCRIBE
TODAY
GET ALL
12 SPECIAL
ISSUES!**



2011 is the **BEST YEAR** to subscribe to **Boys' Life!**

Boys' Life turns 100 next year, and as part of our exciting plans, we're cramming each issue with even more of the cool stuff you've come to expect – plus extra special surprises each month that are sure to please!

You won't want to miss a single, collectible issue...

...especially the one that comes out in **March** - the official anniversary issue... filled with **100 PAGES OF FUN!**

Boys' Life



YEARS OF FUN!

Congratulations!

New to the Aug. 2011 CD - Clicking on the page numbers and titles here now take you to that specific

TABLE OF CONTENTS

How to use this Pow Wow Book	2
Core Values and Assigned Months	3
<u>SECTION 1 - PARTS OF A MEETING</u>	
Gathering Activities	5
Opening Ceremonies	17
Recognition Ceremonies (Tips and Ceremony Props).....	39
Games and Activities	75
Audience Participation.....	101
Skits.....	121
Crafts (Includes recipes)	147
Cubmaster Minutes	169
Closing Ceremonies.....	181
<u>SECTION 2 – ADDITIONAL INFORMATION</u>	
Derbies (Pinewood, Regatta, Space, Bike Rodeo, and more).....	195
Blue and Gold (Songs and Cheers are here too)	227
Character Connections.....	267
Academics and Sports Program.....	275
Tiger Cubs	281
Webelos Scouts	289
ADVICE FROM AKELA – (Misc. tips, ideas and resources for the following :)	
New Leaders	334
Den Leaders	337
Den Discipline	339
Den Chiefs.....	342
Pack Committee,.....	344
Cubmasters.....	347
Pack Communication and Online Resources for Packs.....	348
Parents and Families	352
\$\$\$ and Budgets	357
Pack Trainers	360
Cub Scout Leader Training.....	361
Unit Commissioners (Charter Presentation Ceremonies too).....	366
Scouting with Disabilities (Includes games).....	372
Patches and Awards (Including Leader Awards)	375
Where can I Find Scout Stuff?	403
INDEX – by Core Value.....	404

HOW TO USE THIS POW WOW BOOK

With the release of the new *Den and Pack Meeting Resource Guide* earlier this year from the National Council, we as Cub Scout leaders now have an enhanced emphasis on the 12 Core Values of Cub Scouting – 1 each month (See next page). We as a Pow Wow Book committee felt the need to change the way the Pow Wow Book looks and works as well. We want it to be a resource that fills the gap between what National has given us, by way of the new den and pack meeting plans, and the theme based fun Cub Scouters have been used to for many years. Remember KISMIF – Keep it Simple, Make it Fun! They made it easy – we need to make/keep it fun!

How do I find what I need with this new Pow Wow book format?

1. **“PARTS OF A MEETING” (SECTION 1)** - Ceremonies, Games, etc. are all grouped together in a section. These sections are placed within this book in roughly the same order that they are done in a den or pack meeting. Gathering Activities and Opening Ceremonies at the beginning, Cubmaster Minutes and Closing Ceremonies at the end with games, skits, and all the rest in between.
2. **LABELED AND INDEXED BY CORE VALUE** – on the outside column of most sections you will find associated Core Values beside the Ceremonies, Cubmaster’s Minutes etc... and they are also all listed and indexed by core value in the INDEX at the end of this Pow Wow Book. Use extra space for notes.
3. **ASSIGNED CORE VALUES** – we have assigned core values to many of the ceremonies and such within this book however, many of them are very adaptable and with just a little imagination you could make them work for any month or activity. Don’t let our individual thinking processes limit yours.
4. **FUN, FUN, FUN!** – Initially the thought of focusing on a core value at a pack meeting instead of a theme caused some of us to worry that it would stifle the fun we have all been used to – there is still lots of room for fun. In fact you can still use a theme if you choose to. This book is a resource to make it easy to find core value related activities and help us make it simple and fun for everyone.

2 WAYS TO USE IT - AN EXAMPLE: Let’s say you need to plan an opening ceremony for a meeting that is focusing on the core value of Cooperation. You may choose to start browsing thru the Opening Ceremonies section to find one you like (which may or may not have cooperation printed in the outer column) or you may choose to start with the index and look at the specific pages listed there after the core value of Cooperation - Opening ceremonies. It’s up to you.



Volunteers Wanted! UNPC 2011-2012 Pow Wow Book

If you’re willing and able to help with next year’s Pow Wow Book please contact Mark Baldwin at mabaldwi@bsamail.org



CUB SCOUTING'S 12 CORE VALUES



Character can be defined as the collection of core values possessed by an individual that leads to moral commitment and action. Character is "values in action."

The Cub Scout Character Connections[®] Program identifies 12 Core Values. The following definitions are from the Cub Scout Leader Book.

Citizenship: Contributing service and showing responsibility to local, state, and national communities.

Compassion: Being kind and considerate and showing concern for the well-being of others.

Cooperation: Being helpful and working together with others toward a common goal.

Courage: Being brave and doing what is right regardless of our fears, the difficulties, or the consequences.

Faith: Having inner strength and confidence based on our trust in God.

Health and Fitness: Being personally committed to keeping our minds and bodies clean and fit.

Honesty: Telling the truth and being worthy of trust.

Perseverance: Sticking with something and not giving up, even if it is difficult.

Positive Attitude: Being cheerful and setting our minds to look for and find the best in all situations.

Resourcefulness: Using human and other resources to their fullest.

Respect: Showing regard for the worth of something or someone.

Responsibility: Fulfilling our duty to God, country, other people, and ourselves.

Month and Assigned Core Value

(As found in the *Den and Pack Meeting Resource Guide*)

August – Honesty	December – Respect	April – Faith
September – Cooperation	January – Positive Attitude	May – Health and Fitness
October – Responsibility	February – Resourcefulness	June – Perseverance
November – Citizenship	March – Compassion	July – Courage

This AUG 2011 CD has a new section with ideas and information on how to correlate the monthly Core Value with the *Resource Guide* as well as the achievements and electives in the boys handbooks.

RESOURCES EVERY LEADER NEEDS:

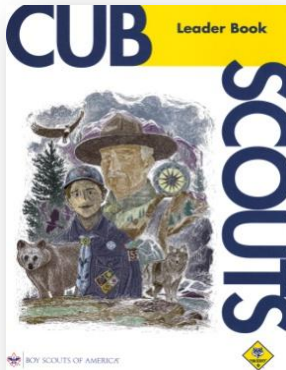

Cub Scout Leader Book

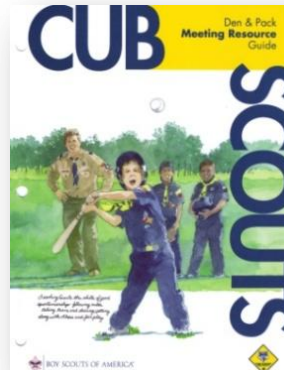

Den and Pack Meeting Resource Guide

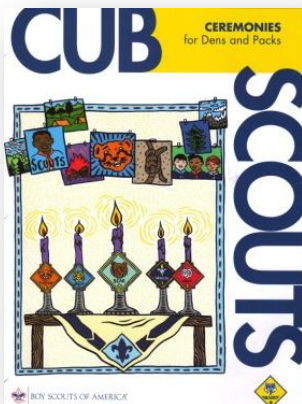

Ceremonies for Dens and Packs

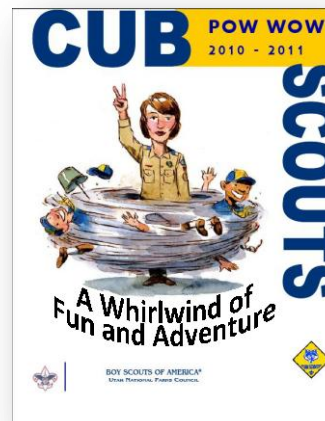

This is the original printed book. But you are browsing the August 2011 Revised edition available on CD only.

This Pow Wow Book

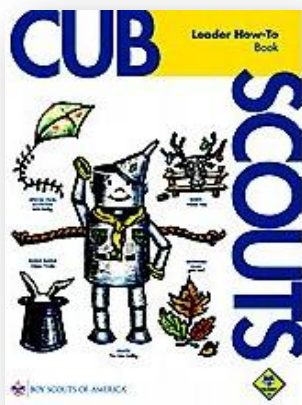

Cub Scout Leader How-To Book



Cub Scout Academic and Sports Program Guide

Cub Scout

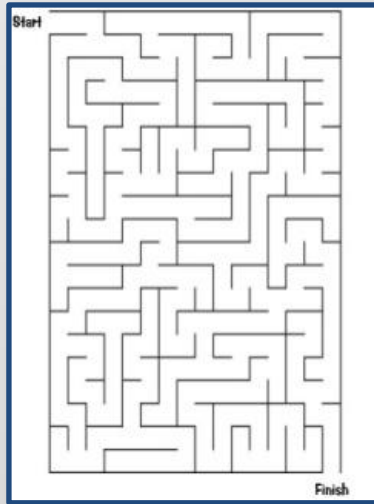

Gathering Activities

Gathering Activities (also called Pre-Openers) are done **BEFORE** the official start of the meeting to keep the boys (and families) occupied while waiting for everyone to arrive. These are games or activities that can easily be done alone (like a maze or word search) or with just a few people (does not require a large group). Sometimes you may choose a craft for them to make during this time and either finish or use it later during the main portion of the meeting. Your Gathering Activity can help set the tone and focus also.

<p>Citizenship Resourcefulness Respect</p>	<p>DIGGIN' DEEP - Quiz</p> <div style="display: flex; justify-content: space-between;"> <div style="width: 48%;"> <p>1. Thomas Jefferson was never . . .</p> <ol style="list-style-type: none"> The third president of the United States. an archaeologist. an English general. the author of the Declaration of Independence. <p>2. Archaeology is . . .</p> <ol style="list-style-type: none"> The science of learning about the future. the science of learning about the past by studying artifacts. the science of learning things from dinosaur fossils. the science of learning how to irritate your den leader. <p>3. When the ancient Egyptians mummified bodies, they pulled a dead person's brains out through..</p> <ol style="list-style-type: none"> their mouth. their belly buttons. their nose. their ears. </div> <div style="width: 48%;"> <p>4. A natural disaster that destroyed the city of Pompeii in A.D. 79 was . . .</p> <ol style="list-style-type: none"> an earthquake. a Cub Scout den meeting. a flood. a volcano erupting. <p>5. Another name for an ancient Egyptian coffin is . . .</p> <ol style="list-style-type: none"> sarcophagus. casket. mausoleum. Murray. <p>6. I am not a definition for the word dig. . .</p> <ol style="list-style-type: none"> the excavation of an archaeological site. making a critical remark to someone. a person's house or apartment. a star in the Glork galaxy. <p>Answers: 1.c 2.b 3.c 4.d 5.a 6.d.</p> </div> </div>
<p>Honesty Faith Perseverance Respect</p> <p><u>Answers:</u> 1. singing, 2. dancing, 3. listening, 4. trumpet, 5. music, 6. opera, 7. guitar, 8. performing, 9. show, 10. piano, 11. acting, 12. kazoo, 13. humming 14. drums 15. whistling</p>	<p>TALENT MIX-UP</p> <p>Unscramble these talents.</p> <ol style="list-style-type: none"> gngnisi _____ cangidn _____ estinilgn _____ muttrep _____ simuc _____ arepo _____ urgtai _____ mgnferropi _____ wsoh _____ oinpa _____ ingcat _____ zooak _____ uhimnmg _____ dsmur _____ wihstglin _____

<p>PARENT QUESTIONNAIRE</p> <p>This questionnaire is to help you learn about your parents when they were your age. See how many questions you can answer on your own and then ask your parent to help you with any answers you don't know.</p> <ol style="list-style-type: none"> 1. Where did you grow up? 2. What kind of house did you live in? 3. What was the name of your elementary school? 4. How did you get to school in the morning? 5. Who was your favorite teacher? 6. How did your parents earn a living? 7. What did you like to do for fun? 8. Who were some of your best friends? 9. When you were young, what was your favorite movie? 10. What was your favorite TV show? 11. What sport did you enjoy playing? 12. What did you want to be when you grew up? 13. What was your most embarrassing moment as a child? 14. What were some of your favorite family activities? 15. What type of things scared you when you were a child? 	<p>Honesty Positive Attitude Responsibility Respect</p>
<p>WHO'S UP MY FAMILY TREE</p> <p>Find the following words:</p> <ul style="list-style-type: none"> ancestor uncle aunt birthday brother grandma grandpa holidays mother sister family father genealogy cousin reunion 	<p>Compassion Perseverance Positive Attitude Respect</p>

<p>Compassion Courage Perseverance Resourcefulness</p>	<p>THEY BUILT THE SHIP TITANIC</p> <p>The Titanic was called "unsinkable" and yet it sank on its very first voyage. See if you can answer these questions about this fascinating ship.</p> <table border="1" data-bbox="454 346 1388 1417"> <tr> <td data-bbox="462 357 909 1407"> <p>1. How many people from the Titanic died? a. All of them. b. None of them. c. 42 d. Approximately 2200</p> <p>2. What was the name of the ship that carried the Titanic survivors to New York? a. Tom b. Dick c. Harry d. Carpathia</p> <p>3. What caused the Titanic to sink? a. An iceberg b. A tropical storm c. A whale d. Someone pulled the plug.</p> <p>4. The Titanic set sail from _____, heading to _____. a. Russia, Iceland b. Salt Lake City, St. George c. England, New York City d. Mexico, Hawaii</p> </td> <td data-bbox="917 357 1380 1407"> <p>5. A shortage of what item on the Titanic caused many people to perish? a. Candy bars b. Lifeboats c. Slippers d. Easter bunnies</p> <p>6. Why did Mrs. Margaret Brown become known as the "Unsinkable" Molly Brown? a. She floated all the way to New York. b. She helped row a lifeboat. c. She cared for survivors aboard the rescue ship. d. Both b and c.</p> <p>7. The Titanic was the first ship to send out what distress call? a. SOS b. Help, I've fallen and can't get up. c. Brrr, its cold out here. d. Everything's okelee dokelee.</p> <p>Answers: 1-d, 2-d, 3-a, 4-c, 5-b, 6-d, 7-a</p> </td> </tr> </table>	<p>1. How many people from the Titanic died? a. All of them. b. None of them. c. 42 d. Approximately 2200</p> <p>2. What was the name of the ship that carried the Titanic survivors to New York? a. Tom b. Dick c. Harry d. Carpathia</p> <p>3. What caused the Titanic to sink? a. An iceberg b. A tropical storm c. A whale d. Someone pulled the plug.</p> <p>4. The Titanic set sail from _____, heading to _____. a. Russia, Iceland b. Salt Lake City, St. George c. England, New York City d. Mexico, Hawaii</p>	<p>5. A shortage of what item on the Titanic caused many people to perish? a. Candy bars b. Lifeboats c. Slippers d. Easter bunnies</p> <p>6. Why did Mrs. Margaret Brown become known as the "Unsinkable" Molly Brown? a. She floated all the way to New York. b. She helped row a lifeboat. c. She cared for survivors aboard the rescue ship. d. Both b and c.</p> <p>7. The Titanic was the first ship to send out what distress call? a. SOS b. Help, I've fallen and can't get up. c. Brrr, its cold out here. d. Everything's okelee dokelee.</p> <p>Answers: 1-d, 2-d, 3-a, 4-c, 5-b, 6-d, 7-a</p>
<p>1. How many people from the Titanic died? a. All of them. b. None of them. c. 42 d. Approximately 2200</p> <p>2. What was the name of the ship that carried the Titanic survivors to New York? a. Tom b. Dick c. Harry d. Carpathia</p> <p>3. What caused the Titanic to sink? a. An iceberg b. A tropical storm c. A whale d. Someone pulled the plug.</p> <p>4. The Titanic set sail from _____, heading to _____. a. Russia, Iceland b. Salt Lake City, St. George c. England, New York City d. Mexico, Hawaii</p>	<p>5. A shortage of what item on the Titanic caused many people to perish? a. Candy bars b. Lifeboats c. Slippers d. Easter bunnies</p> <p>6. Why did Mrs. Margaret Brown become known as the "Unsinkable" Molly Brown? a. She floated all the way to New York. b. She helped row a lifeboat. c. She cared for survivors aboard the rescue ship. d. Both b and c.</p> <p>7. The Titanic was the first ship to send out what distress call? a. SOS b. Help, I've fallen and can't get up. c. Brrr, its cold out here. d. Everything's okelee dokelee.</p> <p>Answers: 1-d, 2-d, 3-a, 4-c, 5-b, 6-d, 7-a</p>		
<p>Citizenship Cooperation Honesty</p>	<p>FLAG EVOLUTION</p> <p>Gather up different pictures of the US flag since its creation. Number each picture. Hang the pictures on a wall in mixed-up order. Give each person a piece of paper, a pen or a pencil and let them try to put the flags in order from oldest to newest.</p>		

<p>SPORTS ANAGRAMS</p> <p>The word or words in capital letters can be rearranged to make the name of a sport.</p> <ol style="list-style-type: none"> 1. This sport IS KING. (One word) 2. MIND BATON in this game. (One word) 3. There's a KEY CHOICE in this team sport. (Two words) 4. WIN GLOB at this sport. (One word) 5. Ride horses through LOOP at this sport. (One word - the word "horses" in the clue is a hint.) 6. SENT IN from this game. (One word) 7. SNUG FIR board needed for this sport. (One word) 8. KIT SANG about this sport. (One word) 9. At this sport LOB ALOFT. (One word) 10. LOLL BY VALE to watch this sport. (One word) <p>Answers: 1-skiing, 2-badminton, 3-ice hockey, 4-bowling, 5-polo, 6-tennis, 7-surfing, 8-skating, 9-football, 10-volleyball</p>	<p>Health and Fitness Perseverance Responsibility</p>
<p>SPORTS TEAMS QUIZ</p> <ol style="list-style-type: none"> 1. What sport do the L. A. Lakers play? A. Golf B. Soccer C. Hockey D. Basketball 2. The Yankees are a baseball team from which city? A. Omaha B. Houston C. Atlanta D. New York 3. What is the name for the football team in Dallas, Texas? A. Cowboys B. Canadians C. Avalanche D. Kings 4. True or false, the Tampa Bay Buccaneers play ice hockey? True False 5. What is the basketball team that Michael Jordan played for in Chicago? A. Sharks B. Mets C. Patriots D. Bulls 6. What sport do the Detroit Red Wings play? A. Bowling B. Football C. Hockey D. Tennis 7. What sport do the Philadelphia 76's play? A. Basketball B. Arena Football C. Baseball D. Soccer 8. True or False, the Miami Dolphins are a football team? True False 	<p>Health and Fitness Perseverance Responsibility</p> <p>Teams: 1 D, 2 D, 3 A, 4 F, 5 D, 6 C, 7 A, 8 T</p>

<p>Citizenship Cooperation Responsibility</p>	<p>TO THE RESCUE</p> <p><u>Words to Find:</u> ambulance bandaid doctor fireman fire truck first aid help nurse police rescue</p> <div style="border: 1px solid black; padding: 5px; width: fit-content; margin: 10px auto;"> <p>j p b z y g m q o b u i p w j o d d v d p h v y c j c v x k b a n d a i d s k b o r c c p t k g p o l i c e v y u u l z p k f e s y v r s b k r e p i q h m p f c y m q r t h n i e f i r s t a i d f e y y s s p y u z k m t p e r t r h r a m v f t m l j l i l l x u p k f w q m a u f f d g z n z r d i d a p b w a d h v t c x e o r g d o a m b u l a n c e s c e k t m e y h d l i j k x c t m f q z i f v h q l r p w u o a l y z w y t q k u e y y e r n</p> </div>
<p>Citizenship Resourcefulness Respect Responsibility</p>	<p>FAMILY PLEDGE TREE</p> <p>Cut colorful leaves from construction paper. This can be done by dens in den meeting. Have each member of the Cub Scout's family write conservation pledges on them. For example, "I pledge to turn off the lights when I leave a room" or "I pledge to make sure newspapers get recycled." Display the pledges by taping them to a poster board drawing of a tree trunk. The more pledges, the bigger the tree. Remove leaves and give them to family members to take home after pack meeting, so they can be reminded of their pledges.</p>
<p>Courage Health and Fitness Perseverance Honesty</p>	<p>CLOTHESPIN MIXER</p> <p>Equipment: Clip-on clothespins - 3 or 4 for each person. Give everyone 3 or 4 clothespins. Tell them that the object of the game is to get rid of their clothespins without having anyone else pin THEIR clothespins on them. With everybody trying to get rid of his or her clothespins at the same time, as fast as possible, this is a rowdy and fun way to start a meeting.</p>

PILGRIMS CROSSWORD PUZZLE

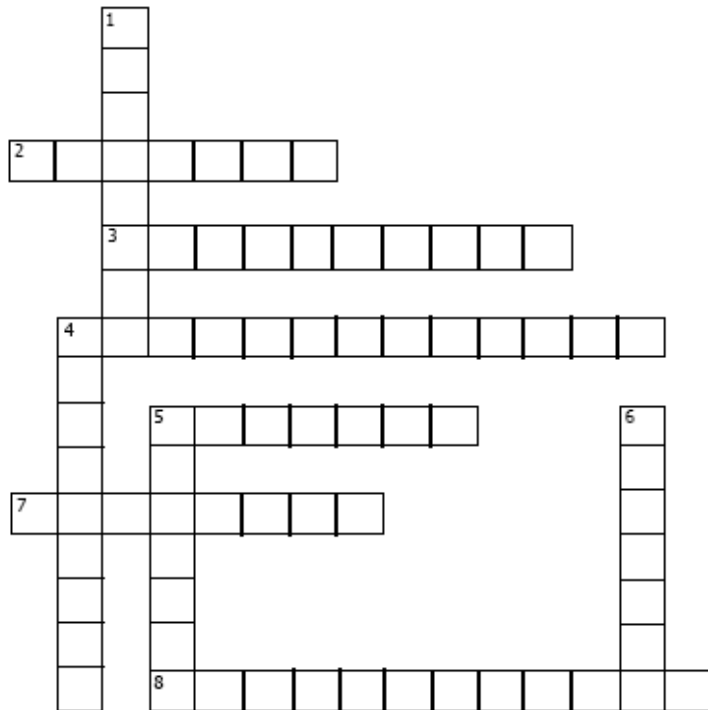

Across:

- 2 - The Pilgrims originally came from this country
- 3 - The part of the country where the Pilgrims settled eventually became known as this, in honor of the home country
- 4 - The Pilgrims settled in what would eventually become this state
- 5 - The colony is close to this large peninsula
- 7 - Name of the Pilgrim colony
- 8 - The holiday celebrated by the Pilgrims and Indians

Down:

- 1 - Originally the Pilgrims were supposed to start their colony in what would later become this Mid-Atlantic state
- 4 - Name of their first ship
- 5 - Agreement that was signed on their trip
- 6 - Another name often used for a Pilgrim





Perseverance

GO FORTH

Give everyone a pencil and paper when they arrive. Tell them to “Go forth” and get acquainted with 20 people, to ask them their names, and to write them on their paper. When all have their 20 names, ask everyone to tear them off and give each slip of paper to the person whose name is written. Check up to see how many can rid themselves of all their names. You can adjust the number according to the size of your pack.

- Compassion**
- Cooperation**
- Honesty**
- Resourcefulness**
- Responsibility**

<p>Faith Cooperation Faith Positive Attitude Respect</p>	<p style="text-align: center;">HOLIDAY WORD SEARCH</p> <div style="border: 3px double black; padding: 10px; text-align: center;"> <p>J F O W C H R I S T M A S O D N N U R X A Q C A Z P M H T I A F O V U O V Q A A Z N A W K I A F L T C G S I N W I U C K N S H U A U F G Y T D X G N I D D E L S R F K G G G Y S H A N U K K A H Z Z O F L E C R R X E K T D J Y P U R K I A A E S E G O B O J L W Z N H R R N T C T B J E Q K C O H A F I H E R A Y N M K U Y R N A M T F B R A T L S E E F K O S R E P O H Z I V A S Y S C I R O O N B I N R A N T T S L E E I N N T K A A R T I R U D E L R D Z E S W H L A H S E S T I C O P M M K C U Y E U A E Q P Y K I H</p> </div> <table style="width: 100%; text-align: center;"> <tr> <td>SKI</td> <td>CHARITY</td> <td>PRESENTS</td> <td>ORNAMENTS</td> </tr> <tr> <td>SNOW</td> <td>DECEMBER</td> <td>SANTA</td> <td>CANDYCANE</td> </tr> <tr> <td>TREE</td> <td>CHRISTMAS</td> <td>HANUKKAH</td> <td>ELF</td> </tr> <tr> <td>SCARF</td> <td>KWANZAA</td> <td>SLEDDING</td> <td></td> </tr> <tr> <td>FAITH</td> <td>HOLLY</td> <td>ICE</td> <td></td> </tr> <tr> <td>HOPE</td> <td>MENORAH</td> <td>FROST</td> <td></td> </tr> </table>	SKI	CHARITY	PRESENTS	ORNAMENTS	SNOW	DECEMBER	SANTA	CANDYCANE	TREE	CHRISTMAS	HANUKKAH	ELF	SCARF	KWANZAA	SLEDDING		FAITH	HOLLY	ICE		HOPE	MENORAH	FROST	
SKI	CHARITY	PRESENTS	ORNAMENTS																						
SNOW	DECEMBER	SANTA	CANDYCANE																						
TREE	CHRISTMAS	HANUKKAH	ELF																						
SCARF	KWANZAA	SLEDDING																							
FAITH	HOLLY	ICE																							
HOPE	MENORAH	FROST																							
<p>Citizenship Cooperation Honesty</p>	<p>FAMOUS AMERICANS</p> <p>Label index cards with names of well-known Americans like Abraham Lincoln, George Washington, Betsy Ross, etc. As each boy comes in, attach the card to his back. The boy must ask the other boys yes or no questions to figure out who he is.</p>																								

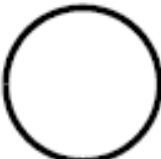
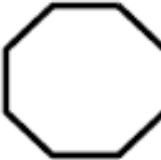
<p>TRAFFIC SIGNS</p> <p>Signs have different shapes and colors. Signs have messages for you. You must understand what signs mean. Match the sign shapes with their meanings.</p> <p>1. </p> <p>2. </p> <p>3. </p> <p>4. </p> <p>5. </p> <p>6. </p> <p>___ A. These signs require a complete stop.</p> <p>___ B. These shapes warn you what to look for. Read the messages on them.</p> <p>___ C. Most of these signs are yellow and black.</p> <p>___ D. These signs always mean railroad.</p> <p>___ E. These signs tell you not to enter until you can do it safely without interfering with traffic.</p> <p>___ F. These signs warn you of school areas.</p> <p>___ G. These signs require you to stop before entering the crosswalks or intersections.</p> <p>___ H. These signs are called regulatory signs.</p> <p>___ I. These signs warn you to slow down and listen for the train whistle.</p> <p>___ J. Be prepared to stop when you see these signs.</p> <p>___ K. These signs guide you. They tell you where to go.</p> <p>___ L. These signs mean you must slow down or stop, if necessary, before merging with traffic.</p> <p>___ M. Orange signs of this shape are placed where roads are being built or repaired.</p> <p>Answers: A-6, B-3, C1&2, D-5, E-4,F-1,G-6,H-3&4&6, I-5, J-4&6,K-3,L-4,M-2</p>	<p>Citizenship Respect Responsibility</p>
<p>NAME THAT PRESIDENT</p> <p>Players try to list as many US Presidents as they can before the meeting is called to order.</p>	<p>Citizenship Cooperation Honesty</p>

<p>Citizenship Respect Responsibility</p>	<p>RECYCLING SCRAMBLER</p> <p>Unscramble names of products or materials that can be recycled.</p> <p style="text-align: center;">Sasgl _____</p> <p style="text-align: center;">Erapp _____</p> <p style="text-align: center;">Munalimu _____</p> <p style="text-align: center;">Mtael _____</p> <p style="text-align: center;">Oodf _____</p> <p style="text-align: center;">Tpanls _____</p> <p style="text-align: center;">Wtera _____</p> <p style="text-align: center;">Answers: glass, paper, aluminum, metal, food, plants, water.</p>
<p>Citizenship Respect Responsibility</p>	<p>TREE TEST</p> <ol style="list-style-type: none"> 1. What is the double tree? 2. What tree is nearest the sea? 3. What is the languishing tree? 4. What is the calendar tree? 5. What tree will keep you warm? 6. What is the Egyptian plague tree? 7. What tree do we offer friends when meeting? 8. What tree is used in kissing? 9. What tree is used in a bottle? 10. What tree is a symbol of strength? 11. What tree is an emblem of grief? 12. What is the sweetest tree? <p style="text-align: center;">Answers: 1-pear, 2-beech, 3-pine, 4-date, 5-fir, 6-locust, 7-palm, 8-tulip, 9-cork, 10-oak, 11-weeping willow, 12-maple</p>

Trees in our Neighborhood

G	R	C	H	E	S	T	N	U	T	L	I	N	D	E	N
I	C	H	I	H	Y	D	F	X	E	O	I	C	E	C	W
N	N	C	C	Q	C	O	D	J	U	N	I	P	E	R	G
K	A	P	K	U	A	U	P	A	P	P	L	E	S	R	A
G	P	E	O	A	M	G	O	P	O	P	L	A	R	C	H
O	R	A	R	K	O	L	M	A	H	O	G	A	N	Y	B
O	I	C	Y	I	R	A	P	N	L	O	C	U	S	T	E
P	C	H	I	N	E	S	E	E	L	M	E	N	P	L	E
A	O	E	O	G	E	F	C	S	A	L	D	E	R	J	C
P	T	R	O	A	K	I	A	E	W	A	L	N	U	T	H
E	T	R	A	S	H	R	N	P	L	M	S	A	C	S	E
R	O	Y	E	P	W	P	O	A	C	Y	P	R	E	S	S
B	N	W	E	E	P	I	N	G	W	I	L	L	O	W	T
I	W	P	O	N	D	E	R	O	S	A	P	I	N	E	W
R	O	R	B	O	X	E	L	D	E	R	L	O	H	N	O
C	O	C	O	N	U	T	P	A	L	M	A	P	L	E	O
H	D	O	G	W	O	O	D	U	R	E	D	W	O	O	D

- | | | | |
|----------------|-------------|---------------|-----------------|
| Ponderosa Pine | Poplar | Larch | Spruce |
| Maple | Oak | Chinese Elm | Locust |
| Peach | Apricot | Apple | Cherry |
| Mahogany | Douglas Fir | Walnut | Japanese Pagoda |
| Coconut Palm | Ginkgo | Quaking Aspen | Linden |
| Alder | Beech | Ash | Paper Birch |
| Box Elder | Cottonwood | Dogwood | Chestwood |
| Pecan | Sycamore | Hickory | Weeping Willow |
| Juniper | Redwood | Cypress | Chestnut |

Citizenship
Respect
Responsibility

TREE TRICKS

Change one letter in each of these words to find the names of a dozen trees:

- MINE _____ FIT _____ POPCAR _____ YES _____
- PILLOW _____ BINCH _____ OAR _____ MATLE _____
- ELK _____ ASP _____ PALS _____ DOGFOOD _____

Answer Key: PINE, FIR, POPLAR, YEW, WILLOW, BIRCH, OAK, MAPLE, ELM, ASH, PALM, DOGWOOD

Citizenship
Positive Attitude
Resourcefulness
Respect
Responsibility

<p>Any Value</p>	<p>VALUE SALUTE</p> <p>Materials: Cards with the letters of the value you are focusing on</p> <p>As people arrive, hand out a card and a pencil. Instruct them to find items whose spelling starts with the letters on the card. They can use any item in the room, including what they wear, but they cannot cite the same item twice. Encourage them to be creative and also to help each other. To ensure that everyone finds something for each letter, plant items in the room. During the meeting, ask the group for sample answers of what they found for each letter. Follow with a cheer.</p>
<p>Any Value</p>	<p>CUB SCOUT QUIZ</p> <p>Create a quiz with about 20 questions on Cub Scouting and your pack. Write answers on index cards and post the cards on walls around the room. Make sure it's clear which answer goes with which question. <i>The Cub Scout Leader Book</i> and the boys' handbooks are excellent sources for questions.</p> <p>As people arrive, hand them the quiz and instruct them to circulate around the room and find the answers. Encourage them to mingle and get to know each other while working on the quiz. Later, during the meeting, go over the quiz and the answers. Give an appropriate cheer for everyone for doing his or her best.</p> <p><i>Examples of questions:</i></p> <p>What country did Scouting start in? Who is the founder of Scouting? What is the anniversary date of the Boy Scouts of America? What year was Cub Scouting in America launched? What is the highest rank in Cub Scouting? What is the Cub Scout motto? How many Webelos activity badges are there? In which year did our pack start? Which district and council does our pack belong to? What is the name of our chartered organization?</p>

To create your own Word Search, Crossword and many other types of puzzles with any list of words go to: <http://puzzlemaker.discoveryeducation.com>



Cub Scout





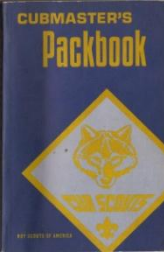

Opening Ceremonies

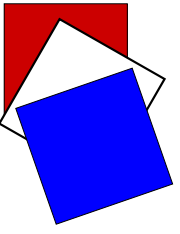

The Opening Ceremony is part of your official start of the meeting. The opening ceremony can help set the tone for the rest of the meeting. It can also help introduce your theme and Core Value. Many of these Opening Ceremonies can easily be adapted to be used as closing ceremonies.

In the Utah National Parks Council's Strategic plan they have asked that we include the Pledge of Allegiance, The Cub Scout Promise and the Law of the Pack at ALL of our meetings and events. Opening and closing ceremonies are an easy way to include these in our meetings.

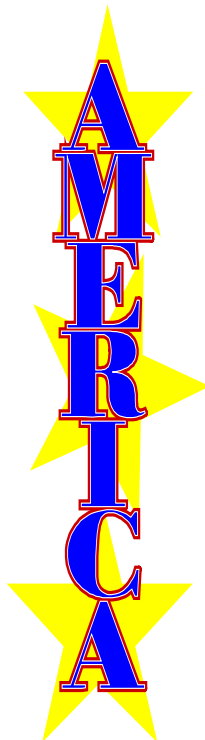

<p>Historical Info. in honor of the BSA's 100th Birthday!</p>  	<p>OPENING AND CLOSING CEREMONIES:</p> <p>In the 1977 printing of the <i>Cubmaster's Packbook</i> - pages 262, 263 we read:</p> <p>"Here are a few ceremonies for opening and closing the main part of the pack meeting. Very little explanation is needed, certainly not a script, for these are very simple ceremonies, usually developed by members of the pack.</p> <p>Remember the best ceremony hasn't been put on yet. Don't rely entirely on lists such as this. Encourage your Cub Scouts and den chiefs to make up their own. Perhaps traditions of your pack will suggest a ceremony that will be as much a part of your pack as your pack flag. The dens might take turns being responsible for the opening and closing ceremonies at the Monthly pack meeting.</p> <p>Teach your Cub Scouts how to use the U. S. flag, to respect it and to display it properly. Refer to <i>Staging Den and Pack Ceremonies</i> for flag etiquette and ceremonies information."</p> <p>The 1964 printing of <i>Staging Den and Pack Ceremonies</i> (page 33) tells us:</p> <p>"The opening ceremony introduces the program and sets the tone of the meeting; it can add dignity and importance as it serves notice to the audience that "now we begin our meeting".</p>
<p>Citizenship Resourcefulness Respect Responsibility</p> 	<p>PROTECT THE EARTH</p> <p>Cub #1: God created the earth and everything on it. (picture of earth.)</p> <p>Cub #2: We will protect the earth and take good care of it. (Holds up picture of beautiful scenery.)</p> <p>Cub #3: We won't litter the roads, fields, streams, or meadows. (Holds up a piece of trash, and puts in a trash bag.)</p> <p>Cub #4: We will practice conservation and not be wasteful. (Holds up newspapers tied in a stack ready to recycle.)</p> <p>Cub #5: We will work together to make our environment more beautiful. (Holds up a potted plant.)</p> <p>Cub #6: As we give the Pledge of Allegiance, please remember the beauty of our country, the United States of America.</p>



<p>RED, WHITE, AND BLUE US Flag is posted by honor guard.</p> <p>Cubmaster has scraps of red, white, blue cloth.</p> <p>Cubmaster: Cub Scouts, what is our flag? You could say it is just a few scraps of red, white, and blue cloth like these in my hand. That would be true. But our flag is really much more than that. We all recognize the flag as the banner of our country. In other words, it stands for our country. We should respect it and treat it as we would want to be treated-with care and love. Let us show our respect by pledging our allegiance to the flag.</p>	<p>Citizenship Respect Responsibility</p> 
<p>CUB SCOUT PLEDGE TO HIMSELF (Mt. Diablo Silverado)</p> <p>Arrangement: American Flag is placed in center of stage. 10 Cubs, in uniform, in turn come on stage stand near the flag and recite one of the lines. Upon finishing he salutes the flag and goes to the rear of the stage, where they form a horseshoe.</p> <p>Cub 1: May I grow in character and ability as I grow in size.</p> <p>Cub 2: May I be honest with myself and others in what I do and say.</p> <p>Cub 3: May I learn and practice my religion.</p> <p>Cub 4: May I always honor my parents, my elders and my leaders.</p> <p>Cub 5: May I develop high moral principles and the courage to live by them.</p> <p>Cub 6: May I strive for health in body, mind and spirit.</p> <p>Cub 7: May I always respect the rights of others.</p> <p>Cub 8: May I set a good example so that others may enjoy and profit from my company.</p> <p>Cub 9: May I give honest effort to my work.</p> <p>Cub 10: May I regard my education as preparation for the future.</p> <p>As last boy joins the horseshoe, invite the audience to join in the Pledge of Allegiance.</p>	<p>Courage Faith Health and Fitness Honesty Positive Attitude Respect Responsibility</p>  

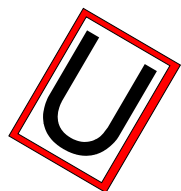
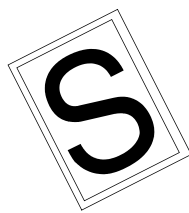
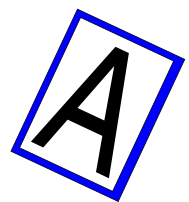

<p>Respect Citizenship Responsibility</p> 	<p>OUTDOOR ADVENTURE (Capital Area Council, Baloo's Bugle July 2008)</p> <p>Cub 1: America and Cub Scouting are just one big outdoor adventure.</p> <p>Cub 2: This is my country. I will use my eyes to see the beauty of this land.</p> <p>Cub 3: I will use my mind to think what I can do to make it more beautiful.</p> <p>Cub 4: I will use my hands to serve it and care for it. And with my heart I will honor it.</p> <p>Cub 5: Many immigrants to America had a really big adventure getting here.</p> <p>Cub 6: And on their adventure in this country they became loyal Americans.</p> <p>Cub 7: Let us be like them, loyal Americans. Please join me in the Pledge of Allegiance.</p>
<p>Citizenship Respect Faith Perseverance</p> 	<p>AMERICA OPENING</p> <p>The word AMERICA is spelled out on cards with a Cub Scout holding up each letter and reading his part.</p> <p>A is for ADVANTAGES. We have so many more because we are Americans. Let us give thanks therefore.</p> <p>M is for MAJORITY; decision by the most. That's the rule we follow from coast to rugged coast.</p> <p>E is for EDUCATION available to all. So every last American stands up straight and tall.</p> <p>R is for RELIGION. We worship as we will. A right we'll always cherish and let no evil kill.</p> <p>I is for INDEPENDENCE that our fathers once declared. Our nation's rise to greatness because these brave men dared.</p> <p>C is for CITIZENSHIP of which we can be proud. So let's proclaim it daily and do it long and loud.</p> <p>A is for ASSEMBLY. To gather as we might. That's another privilege, another precious right. Will all those assembled please rise and recite the Pledge of Allegiance with us!</p>

<p>I CAN (Simon Kenton Council)</p> <p>This can be read as is or split into a few or many parts</p> <p>I can- stand tall in my heritage and believe fully in America! I can- strive for the highest pinnacle, or any other spot I so choose, it is my decision, to be freely arrived at. I can- worship at the church of my choice, read whatever books, articles, or newspapers I choose, select my own home, friends, job and associates! I can- sleep peacefully, free from the fear of midnight persecution, secure in the protection of my rights! I can- fail as well as succeed, this is true freedom! I can- shape my own destiny, have my visions realized, achieve anything I really believe I can! I can- fail and still be counted a man, gain strength and experience through mistakes, lose it all, and start over again as many times as my spirit is willing, until my dreams are reality! I can- grow as large as my dominant aspirations, be as big as I am willing to pay the price to become! I can- own my own home, start a business, invest in my future, climb to the stars by constructing my own staircase! I can- compete and receive in direct proportion to my efforts, thank others for assistance in my success, but look only to myself for my failures! I can- raise my family in freedom, and freely change homes, jobs, friends, tastes, location, vocation, and avocation, but, most importantly, I can change myself! I can- because I am an American! Please join me in pledging allegiance to our flag.</p>	<p>Citizenship Courage Faith Perseverance Positive Attitude Resourcefulness Respect Responsibility</p> 
<p>CANDLE OPENING (or closing)</p> <p>Dim or turn off room lights except for an electric candle or flashlight. The paragraph is read by the Cubmaster or other adult.</p> <p>This is the season of lights and stars, when days are short and nights are long with beautiful stars. Lord Baden-Powell, the founder of Scouting, once said this to his Scouts: "I often think when the sun goes down, the world is hidden by a big blanket from the light of heaven, but the stars are little holes pierced in that blanket by those who have done good deeds in this world. The stars are not all the same size, some are big, some are little. So some men have done great deeds, and some men have done small deeds, but they have all made their hole in the blanket by doing good before they went to heaven." Let's remember when we look at the starry sky to make our own hole in the blanket, by doing good deeds and helping other people.</p>	<p>Positive Attitude Compassion Courage Faith</p> 

<p>Citizenship Cooperation</p> 	<p>BUILDING AMERICA OPENING</p> <p>Materials: U.S. flag on wooden pole with eagle on top</p> <p>CUB SCOUT 1: A woodworker made this flagpole.</p> <p>CUB SCOUT 2: An artist made the eagle on its top.</p> <p>CUB SCOUT 3: A seamstress sewed the flag.</p> <p>CUB SCOUT 4: Citizens give it meaning.</p> <p>CUB SCOUT 5: Please join us in the Pledge of Allegiance to our flag.</p>
<p>Citizenship Faith Respect Responsibility</p>   	<p>USA</p> <p>Equipment: Cards (made of poster board) with large letters U, S, and A on the fronts; corresponding phrases (see below) on the backs.</p> <p>Setup: Post the U.S. flag at the front of the room before the meeting. Three boys holding the cards are seated in a line at the front of the room with the cards on their laps.</p> <p>NARRATOR: Our country’s name expresses the principles that we hold sacred as citizens of the United States of America.</p> <p>CUB SCOUT 1 (stands and holds up card): “U” is for united. We are a country of citizens united under one government and dedicated to the cause of freedom and peace.</p> <p>CUB SCOUT 2 (stands and holds up card): “S” is for states. Our country is a union of 50 states. We are proud of our individual histories, but we come together to defend what is right.</p> <p>CUB SCOUT 3 (stands and holds up card): “A” is for America—a land of promise filled with opportunity and beauty. America is a patchwork quilt of cultures and a stronghold of religious liberty.</p> <p>NARRATOR: Would the audience please stand and join us as we recite the Pledge of Allegiance</p>

<p>TO BE HONEST</p> <p>Each boy gets a card that has a response on it. He reads the response as he is called upon:</p> <p>To be honest is ... telling the truth.</p> <p>To be honest is ... if you find something that belongs to someone you know, you return it.</p> <p>To be honest is ... to admit when you're wrong, instead of blaming someone else.</p> <p>To be honest is ... if you find something and you don't know who it belongs to, you take it to an adult.</p>	<p>Honesty Respect</p> 
<p>GREETINGS</p> <p>The den chief asks the audience to respond by doing what the boys say. The boys hold up cards with letters that spell G-R-E-E-T-I-N-G-S. Each boy shows his card as he speaks his line:</p> <p>G Glad to see you here tonight</p> <p>R Reach out your hand to a friend on the left or the right.</p> <p>E Everyone smile and shake his or her hand.</p> <p>E Everyone smile and nod at another friend.</p> <p>T Together now, stand up on your feet</p> <p>I I'd like for you all to take your seat.</p> <p>N Now that we're all friends, we'll start the show.</p> <p>G Goodwill is a feeling we all like to know.</p> <p>S So now we say "Greetings" to everyone. We've tried to spread goodwill, and that we've done. Cubmaster _____, our program's begun. (Motion to Cubmaster to come onstage).</p>	<p>Any Value</p>  

<p>Citizenship Compassion Honesty Cooperation Perseverance Responsibility</p> 	<p>LADDER OF GOOD CITIZENSHIP</p> <p>Equipment: Ladder, on each rung cards with key words facing toward the audience; pointer; U.S. flag</p> <p>Personnel: Leader, seven Cub Scouts. As each boy reads his part, have him point to the key word on the ladder with the pointer.</p> <p>LEADER: We think of Cub Scouting as a ladder of good citizenship. Let us show you what we mean.</p> <p>CUB SCOUT 1: FRIENDSHIP. We make lots of friends in our school, den and pack, church, and neighborhood.</p> <p>CUB SCOUT 2: TEAMWORK. We learn how important it is to work with others as members of a team.</p> <p>CUB SCOUT 3: LEADERSHIP. We help with den and pack activities.</p> <p>CUB SCOUT 4: HONESTY. We learn to tell the truth and to understand what honesty means.</p> <p>CUB SCOUT 5: GOODWILL. We like to help our school, church, neighbors, and those less fortunate than we are. Goodwill projects make us feel good.</p> <p>CUB SCOUT 6: RESPONSIBILITY. We learn to be responsible for certain jobs our own belongings, things about our home, and for the property of others.</p> <p>CUB SCOUT 7: LOYALTY. We learn to be true to our parents, our friends, and our den and pack. We also learn to honor our country and its flag.</p> <p>LEADER: Audience, please rise and repeat the Pledge of Allegiance.</p>
<p>Courage Positive Attitude Respect</p> 	<p>ANIMAL OPENING (Santa Clara County Council Pow Wow Book March 1998)</p> <p>Cubmaster stands in front and calls, "Tigers." All Tigers come in the room roaring. Cubmaster calls for Wolves. Wolf dens come in the room howling. Cubmaster calls for Bears. Bear dens come in the room growling. Cubmaster calls for Webelos. All Webelos Scouts come in the room yelling, "We-be-los! We-be-los!" When all the boys are in the room, the Cubmaster makes the Cub Scout sign and calls, "Akela welcomes the jungle animals to his pack. Let's see to it that we work and play in peace and become strong and wise Cub Scouts." The Cubmaster then asks everyone to stand and repeat the Pledge of Allegiance.</p>

<p>BOY WANTED</p> <p>Cubs hold up newspapers and pretend to read from the want ads. Tape a piece of paper with the boy's line on the inside of each boy's newspaper. A leader should read/say the last paragraph.</p> <p>"Wanted:</p> <ul style="list-style-type: none"> - A boy who stands straight, sits straight, acts straight and talks straight. - A boy who listens carefully when he is spoken to, and who asks questions when he does not understand. - A boy who looks cheerful, has a ready smile for everybody, and never sulks. - A boy who is polite to every man and respectful to every woman and girl. - A boy who neither bullies other boys nor allows other boys to bully him. - A boy who looks you right in the eye and tells the truth every time. - A boy who makes you feel good when he is around. <p>This boy is wanted everywhere." Cub Scouting helps plant the seeds and nourish their growth that turns Cubs into the boys who are wanted everywhere! These are the boys who will grow into the men who will keep our nation strong. (Quote excerpt taken from "Boy Wanted" by Frank Crane)</p>	<p>Compassion Courage Honesty Positive Attitude Respect</p>  
<p>WATER OPENING</p> <p>W We love to get wet and play in water.</p> <p>A Animals, people, and plants all need water to survive.</p> <p>T Take time to use water wisely.</p> <p>E Everyone is responsible for keeping our water clean.</p> <p>R Rivers, streams, lakes and oceans are some of our national treasures.</p> <p>Please rise and join us in honoring our country by saluting the flag and saying the Pledge of Allegiance.</p>	<p>Citizenship Compassion Respect</p> 

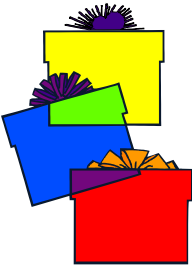
<p>Citizenship Resourcefulness Respect Responsibility</p> 	<p>CONSERVE</p> <p>Eight Cub Scouts hold cutouts of cars made from poster board and painted in bright colors. As each boy speaks his line, he turns over the card to show the large letter. All of the cards will spell out the word CONSERVE.</p> <p>C – Cars and buses and such were invented by man.</p> <p>O – Oil fields were also discovered by them.</p> <p>N – Nobody really worried about the amount of fuel this would take.</p> <p>S – So on no transportation did they put the brake.</p> <p>E – Eventually, the amount of fuel used grew astonishingly.</p> <p>R – Raising on everyone’s mind a great big doubt.</p> <p>V – Very soon the world’s traffic was put to the test.</p> <p>E – Everybody to conserve fuel must now do their best!</p>
<p>Compassion Faith Perseverance Respect</p> 	<p>DECEMBER OPENING</p> <p>Equipment: 5 Index cards with script written on each, US Flag and Pack Flag. Flags are in the front; Cub Scouts enter one at a time and read his script.</p> <p>1st Cub: December is a fun time of the year. It is a time for giving and sharing.</p> <p>2nd Cub: As we gather for the last Pack meeting for 20__, let us remember the good times.</p> <p>3rd Cub: Let us end this year with new determination to keep the Cub Scout Spirit going.</p> <p>4th Cub: As we begin our program tonight, let us keep in mind the true Holiday Spirit.</p> <p>5th Cub: Remember, to give of yourself is more important than any gift you can buy.</p> <p>Cubmaster: Please stand for the Pledge of Allegiance.</p>

CUB SCOUT TREES

(Santa Clara County Council Pow Wow Book, May 2000)

Cubmaster: As a tree grows it gets larger and stronger adding rings to its base each year. So do Cub Scouts. With each activity the Cub Scouts grow in character and become stronger citizens. They learn to serve family, God and country. Their branches will spread and touch many lives. The things they learn will help them to help themselves and others too.



(7 Cubs with letters printed on cardboard cutouts repeat the following each in turn)

- C Stands for Cub Scouts
- U United in having fun
- B Being the best we can be
- T Training to be Boy Scouts
- R Ready to learn, ready to play, ready to help others.
- E Is for the Extra effort it takes to go faster and do more than an ordinary person. A Cub Scout is not an ordinary person. He is a Scout!
- E Is for Earning our Ranks until we obtain the Arrow of Light. We want to be the best and in Cub Scouts, the Arrow of Light is the best!!

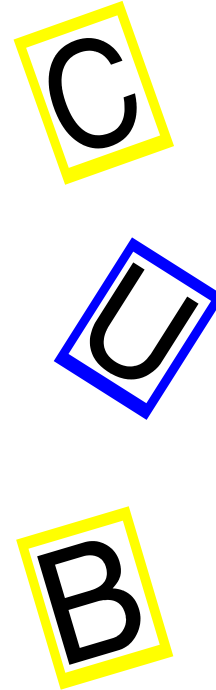

Cubmaster: May each of the boys here become a strong, useful, and fun "Cubtree".

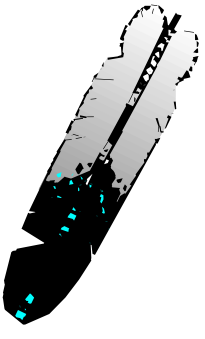

Citizenship
Compassion
Cooperation
Resourcefulness
Respect
Responsibility

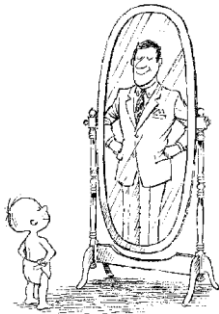

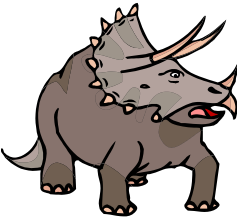
<p>Citizenship Courage Resourcefulness Responsibility</p>   	<p>NATURE'S SECRETS (Santa Clara County Council Pow Wow Book, June 1999)</p> <p>Equipment: Acorn; pine needles; feather. Personnel: 4 Cub Scouts; Cubmaster dressed as Akela.</p> <p>Akela (to 4 Cub Scouts): To test your manhood, I send each of you out into the earth's vast high country to bring back one of nature's secrets. (Cub Scouts exit and return.)</p> <p>Akela (to Cub 1): What secret have you brought and where did you find it?</p> <p>Cub 1: Akela, I return with great hunger, thirst, and painful sunburn. I learned that a young brave must plan ahead.</p> <p>Akela (to Cub 2): What lesson have you brought and where did you find it?</p> <p>Cub 2: Akela, I searched the hills and forests and bring an acorn. Just as a mighty oak grows from a small acorn, if I have faith in myself, I can become strong.</p> <p>Akela (to Cub 3): What secret did you bring?</p> <p>Cub 3: Akela, I climbed high into the distant mountains where the snow is still deep, and the air is cool. I bring green needles from the giant pine trees. Just as the pine needles remain green throughout the year, a brave should always remain true to Cub Scouting--Do Your Best.</p> <p>Akela (to Cub 4): What treasure have you brought and where did you find it?</p> <p>Cub 4: Akela, I traveled to the top of the mountains. From my high perch, I saw the wonders of God's creations. I saw the eagle as it soared high and free in the blue sky. I bring an eagle's feather--a reminder of freedom and the vision we must have to protect and cherish it.</p> <p>Akela (to the audience): These braves have learned well. Nature shared her secrets with them. It is now their responsibility to live what they have learned, to plan ahead, to have faith, to remain true to Scouting, and to cherish freedom. Will everyone now please stand and join me in repeating the Pledge of Allegiance and the Cub Scout Promise?</p>
---	--

<p>IDEAS OF FREEDOM</p> <p>After the Pledge of Allegiance, the audience sits down and the Cubs read or say the following:</p> <p>Cub 1: The ideas of freedom were brought to our land by early settlers who wanted to have the freedom to worship as they pleased.</p> <p>Cub 2: These ideas were planted firmly in our soil and were nurtured by many who came later.</p> <p>Cub 3: Along came many great leaders who fought for our rights and wrote our constitution.</p> <p>Cub 4: It is our responsibility to defend those freedoms and continue to nurture the Ideas that will keep us free.</p>	<p>Responsibility Respect Courage Citizenship</p> 
<p>WHEN I GROW UP (Pacific Skyline, Baloo's Bugle Dec. 2000)</p> <p>Cast: Cubmaster, 4 Cubs in costumes appropriate for the part.</p> <p>Cubmaster: Some of our Scouts have some thoughts about the future and how they might be able to do something positive.</p> <p>Cub 1: When I grow up I would like to use my creativity to find cures for diseases and help people everywhere become healthier.</p> <p>Cub 2: When I grow up I would like to help people from all over develop an understanding of each other so that everyone, old and young, rich and poor, men and women, and east and west will work together.</p> <p>Cub 3: When I grow up I would like to use my self-discipline to contribute to my community, strengthen my family and grow personally.</p> <p>Cub 4: When I grow up I would like to help people learn to grow crops that will feed more people, but use less space.</p> <p>Cubmaster: These boys and the other Cub Scouts here tonight will be the scientists, leaders and trailblazers of tomorrow. I think our future is in good hands.</p>	<p>Compassion Positive Attitude Perseverance Resourcefulness Responsibility</p> 

<p>Courage Perseverance</p> 	<p>DINOSAUR (Baloo's Bugle, June 1997)</p> <p>Personnel: 4 Cub Scouts with pictures of dinosaurs</p> <p>Cub 1: I'm a Brontosaurus with four feet. I eat plants, but don't eat meat. Known as Thunder Lizard, that is true, because when I walked, the Earth just shook.</p> <p>Cub 2: Tyrannosaurus Rex that's my name, King of the Dinosaurs, that I am. I make many run and hide because I'm mean and I like to fight.</p> <p>Cub 3: I'm a Triceratops, with three horns, a big, big head, with three horns. I'm a fierce fighter on four feet, but I eat plants, because they are neat.</p> <p>Cub 4: Dinosaurs, dinosaurs that we know. Some were large, some were small. Fossils tell us this is so because I've not seen one after all.</p> <p>Cub 5: Please stand and join us in the Pledge of Allegiance.</p>
<p>Citizenship Courage Health and Fitness Respect Responsibility</p>  	<p>HIKING AND THE FLAG</p> <p>Set up: Cubmaster, assistant cubmaster, 2 den leaders; Camping gear and outfits for each of the participants; 1 pair of binoculars; US and pack flags. Arrangement: The flags are in front of the audience. The group of leaders is off to one side and slowly walks through the audience to the front.</p> <p>CM: It sure is nice to be here in the outdoors. All these trees, animals and fresh air.</p> <p>ACM: <i>(Looking through binoculars)</i> Hey, I think I see a big red bird up there!</p> <p><i>(DL #1 takes the binoculars while everyone continues to walk slowly to the front.)</i> Here, let me see. Naw, it's a huge white bird of some sort.</p> <p><i>(DL #2 takes the binoculars while everyone continues to walk slowly to the front.)</i> Boy, you don't know what you are talking about. It's not red or white. It's big and blue, and... What's this?!?! It has stars!</p> <p><i>(Cubmaster takes the binoculars and everyone stops.)</i> Here, let me see what you are all talking about. <i>(Looks through the binoculars.)</i> Come on you guys. <i>(Motions everyone to follow as they walk up to the front.)</i> It's not a red bird, or even a white bird. What you were looking at is our nation's flag. <i>(Turns to audience.)</i> Will you please stand and join us in the Pledge of Allegiance?</p>

<p>THE OUTDOOR CODE OPENING (or Closing) (Santa Clara County Council Pow Wow Book June 1999)</p> <p>Have a large poster with the outdoor code hung up in front. (You may want to write additional lines if there are more participants.)</p> <p>Cub 1: We have been observing and studying nature's treasures.</p> <p>Cub 2: We will help to maintain nature's balance.</p> <p>Cub 3: We will help and learn from nature's resources.</p> <p>Cub 4: We will help to maintain nature's resources.</p> <p>Cub 5: We will protect them from harm.</p> <p>Cub 6: We will follow the laws of nature.</p> <p>Cub 7: Will you all join us in reciting the Outdoor Code followed by the Pledge of Allegiance.</p> <p><u>The Outdoor Code:</u> As an American, I will do my best to-- Be clean in my outdoor manners, Be careful with fire, Be considerate in the outdoors and Be conservation minded.</p>	<p>Resourcefulness Respect Responsibility</p> 
<p>FUN IN THE SUN</p> <p>1 - We can have Fun in the Sun because we are Free. Brave men fought for this freedom from sea to shining sea.</p> <p>2 - We can have Fun in the Sun because of Ol' Glory, which flew high so that all could see.</p> <p>3 - We can have Fun in the Sun because our streets are secure. Of this our city police make sure.</p> <p>4 - We can have Fun in the Sun because our neighborhood is clean, the parks and fields and lakes and streams.</p> <p>5 - We can have Fun in the Sun, you and me! Grateful are we to live in a land that is free! Please join me in pledging allegiance to our flag.</p>	<p>Citizenship Courage Respect Responsibility</p> 

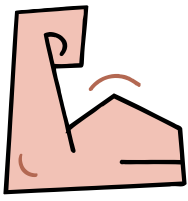
<p>Health and Fitness Respect</p> 	<p>PHYSICAL FITNESS (National Capital Area Council)</p> <p>Six Scouts come on stage, carrying various kinds of muscle-building equipment. They exercise and, in turn, speak the following lines.</p> <p>CUB 1: To keep your body strong and healthy is more valuable than being wealthy.</p> <p>CUB 2: When you are fit, you feel so good, and try to do the things you should.</p> <p>CUB 3: It helps you lend a helping hand, to needy folks around the land.</p> <p>CUB 4: Eating the right foods is always wise, and everyone needs exercise.</p> <p>Cub 5: Stand on tip toes, one, two, three. Come on and practice; run with me!</p> <p>Cub 6: Scouting builds young boys into men, and this is where it all begins. Please Stand and join me in the Pledge of Allegiance.</p>
<p>Courage Health and Fitness Respect</p> 	<p>MY STRENGTH</p> <p>The Cubmaster and four boys are on stage just before the presentation of colors.</p> <p>CM: During this month, our Cubs have been working on their muscles and physical skills.</p> <p>CUB 1: My strength comes from my parents and my ancestors.</p> <p>CUB 2: My strength comes from the exercises and work I do.</p> <p>CUB 3: My strength comes from the foods I eat and the clean air I breathe.</p> <p>CUB 4: We need strength to keep our bodies healthy, but real strength is knowing when and how to use strength wisely in all that we do, especially in helping our own families.</p> <p>CM: As we begin our meeting, let us all stand tall and proud knowing that we are doing our best as the color guard advances.</p>

MY FAVORITE SPORT

(Sam Houston Area Council)

Boys are dressed in appropriate sports outfits.

CUB 1: Baseball is the game for me – mitts and gum and batting tees.

CUB 2: Soccer to me is really neat – shin guards, goals and wearing my cleats.

CUB 3: Swimming is my priority - backstroke, butterfly and swimming the free.

CUB 4: Football is a game renowned - kickoffs, field goals and the touchdown.

CUB 5: Now basketball most definitely has it - dribbling, guarding and sinking that basket.

CUB 6: Volleyball is what I like - serving, rotating, and doing the spike.

CUB 7: Tennis is a game for all - serving, faults and very close calls.

CUB 8: Golfing on the course is fun - especially a stroke that's a hole-in-one.

ALL: The games we play have two things we can brag about, good sportsmanship and our pledge to the flag.

CUB 1: Please stand for the Pledge of Allegiance.

**Cooperation
Health and Fitness
Positive Attitude**

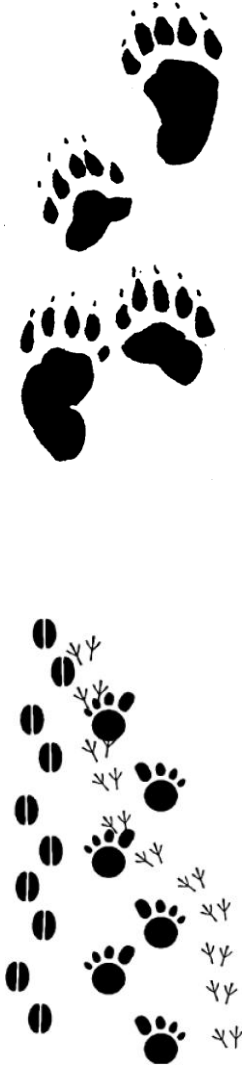

<p>Courage Respect Cooperation Resourcefulness Responsibility Health and Fitness</p> 	<p>TRACKS</p> <p>Props: A compass and map. Several paper paw print cutouts large enough to be seen by the audience. Scatter the paw prints on stage before the meeting.</p> <p>Setting: Cub den wanders around together as a group, following the first Cub Scout with the map and compass.</p> <p>Cub 1: Where are we? Where should we go now?</p> <p>Cub 2: I think we're lost.</p> <p>Cub 3: Wait a minute! I think I found something.</p> <p>All: What is it?</p> <p>Cub 3: (Holds up paw print for all to see) Tiger Tracks!</p> <p>All: Tigers! Oh No! (Resume wandering)</p> <p>Cub 4: Here are some more tracks. (Holds up paw print) It looks like Bobcats'!</p> <p>Cub 2: Do you think they are hungry?</p> <p>Cub 1: I see Wolf tracks. (Holds up many paw prints) There must be a whole den of them around here somewhere.</p> <p>All: Oh, no!</p> <p>Cub 5: The only thing I am afraid of is Bears.</p> <p>Cub 1: Look. Bear tracks!</p> <p>Cub 5: I see footprints from the Webelos tribe. They are a wild bunch.</p> <p>All: Tigers, Bobcats, Wolves, Bears, and Webelos! What will we do? What will we do?</p> <p>Den Leader: (Walks on-stage) Okay boys, come on. Time to start the meeting now.</p> <p>All: Saved by our Den Leader again.</p>
--	---

CAMPFIRE CEREMONY

Setup: Narrator and 7 Cub Scouts and a Campfire (real or artificial)

Cubmaster: Welcome to the Cub Scout campfire. Akela is among us. Let us draw from this campfire all its vibrancy and warmth, the secrets of Cub Scouting and the spirit of brotherhood.

- 1: In its light, we see new chances to be helpful and do our best.
- 2: From its warmth, we strengthen the bonds of fellowship and learn how to get along with others.
- 3: From the stones that ring the fire and keep its power in check, we learn how we can curb our tempers and become good citizens.
- 4: From the smoke that rises out of the fire, we learn to lift our eyes upward and worship God.
- 5: The spark that started this fire reminds us that little Good Turns can lead to greater deeds.
- 6: Just as the fire needs wood to burn bright, so do we need care and the love of our family to burn brightly.
- 7: In its leaping flames, we see the fun of Cub Scouting and the joys of life.

- Citizenship**
- Compassion**
- Courage**
- Faith**
- Resourcefulness**
- Respect**
- Responsibility**



Cub Scout Sign

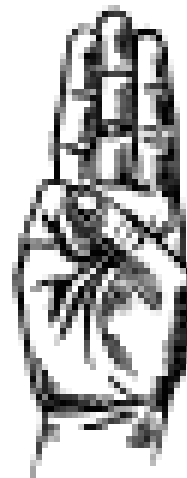

Scout Sign

<p>Citizenship Courage Positive Attitude Resourcefulness Respect</p>	<p>"SOAR": SAVE OUR AMERICAN RESOURCES</p> <p>Setting: At least four Cub Scouts holding cards with the letters S-O-A-R on them. They come on stage one at a time and read their parts.</p> <p>Cub 1: I promise not to break or spoil anything with which I work or play.</p> <p>Cub 2: I will not throw paper, candy wrappers, fruit peelings or other trash on sidewalks.</p> <p>Cub 3: I will keep my playground clean.</p> <p>Cub 4: I will be as careful of other people’s places and things as I would want them to be of mine.</p> <p>All: Save Our American Resources!</p> <p>Caller: Please stand for the presentation of the colors.</p>
<p>Citizenship Compassion Resourcefulness Respect Responsibility</p>	<p>THE OUTDOOR CODE:</p> <p>As this is part of their Webelos badge requirements. They could each state and explain one point and then repeat it all together at the end.</p> <p>As an American I will do my best to:</p> <p>Be clean in my outdoor manners;</p> <p>Be careful with fire;</p> <p>Be considerate in the outdoors;</p> <p>and be conservation minded.</p>



<p>THE JUNGLE SAFARI OPENING CEREMONY</p> <p>Personnel: Den Leader (wearing a safari hat and carrying binoculars) and 5 Cub Scouts (animal costumes or masks optional)</p> <p>Den Leader: (looking around) I'm looking for a cub.</p> <p>Cub #1: What kind of cub?</p> <p>Den Leader: (still looking about) Oh, I don't know, but I'll know when I see it.</p> <p>Cub #1: Is it a lion cub?</p> <p>(Cub #2 crawls along the floor and roars like a lion.)</p> <p>Den Leader: No! It's not a lion cub.</p> <p>Cub #1: Is it a bear cub?</p> <p>(Cub #3 crawls along the floor and growls like a bear.)</p> <p>Den Leader: No! It's not a bear cub.</p> <p>Cub #1: Is it a wolf cub?</p> <p>(Cub #4 crawls along the floor and howls like a wolf.)</p> <p>Cub #1: Well, what other kind of cub is there?</p> <p>Den Leader: (looking through binoculars) There it is!</p> <p>(Cub #5, in full uniform, walks in carrying the American flag and then posts the colors.)</p> <p>Cub #5: Will the audience please repeat the Pledge of Allegiance with me</p>	<p>Citizenship</p> <p>Courage</p> <p>Respect</p>
---	---



The logo for 'CUB SCOUT PACK' is displayed in a large, bold, yellow font with a blue outline. The word 'CUB' is on the left, 'SCOUT' is in the middle, and 'PACK' is on the right. A small blue and white Cub Scout emblem is integrated into the letter 'O' in 'SCOUT'. Below the text, there are faint, light blue wavy lines.

Cooperation**COOPERATION OPENING**

(from <http://ww2.scouting.org/100years/100years/CubScouts.aspx>)

Each boy is given a card with one of the designated letters on the front. Prepare letters using 8 ½ x 11 Card stock with letter on front and what the Cub Scout will say written clearly on the back. Boys will hold cards up one at a time in order and read what is on the back of the card. As they say the word with the highlighted letter, they may raise their card for emphasis.

- C** Cub Scouts **C**ooperate
- O** to do **O**pening ceremonies
- O** to make **O**utdoors activities safe
- P** when saying the Cub Scout **P**romise
- E** to make sure **E**veryone gets a chance
- R** to **R**emind each other to “do your best”
- A** to **A**ct out skits and shows
- T** to **T**reat everyone kindly
- I** to **I**nclude everyone
- O** to help the pack **O**perate smoothly
- N** to help **N**ew cub scouts feel welcome

Without cooperation we would be just individual boys, with cooperation we are a Pack! As a pack let’s all repeat the pledge of Allegiance together.



CUB SCOUT



Recognition Ceremonies

In Cub Scouting boys are constantly joining your pack, advancing through the ranks and earning badges and other awards, and finally they will be graduated into Boy Scouts. All of these steps along the Cub Scout trail are occasions for recognition. Ceremonies are a great way to recognize when a boy has done his best. Don't forget to recognize the leaders, new families, den chiefs and other special members of your pack too.

Courage
Faith
Perseverance
Resourcefulness
Responsibility

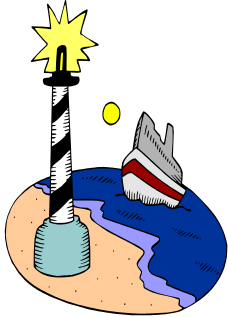

LIGHTHOUSE ADVANCEMENT

Equipment needed: lighthouse, small boats (instructions on next page) wide ribbon, hot glue and glue gun, rocks, scissors and awards.

Set-up:

Place your lighthouse on a table at the front of the room. Place rocks around the base. Place awards inside the boats. Glue your boats to two or three long pieces of wide ribbon using hot glue. The hot glue won't stick to the boats for very long, but that is what you want! Leave a tail of at least one foot before the start of the boats.

Place the ribbons with the attached boats on the table at about a 45 degree angle to the lighthouse. Hopefully this will make it look like the boats were heading toward the lighthouse, but are now turning to avoid the rocks. The lighthouse has done its job.

CUBMASTER: The job of the lighthouse is to warn ships of rocky shorelines where they could meet with potential disaster. As with the sea, our lives can be full of dangerous and rocky situations and choices. It is often difficult to make the right choices, and to see the hidden dangers that could be disastrous to us.

Thankfully, the boys here tonight have many people, who like the lighthouse, can help guide them safely through life's choices. Will the parents and den leaders all stand please?

Cub Scouts, look around you at the people you see standing here. All of these people are like lighthouses in your lives. They care about you, and they want only the very best things for you. If you heed their counsel, just as ships heed the warnings of the lighthouse, you will be safe in your journey of life.

Tonight we honor boys who have been navigating the waters of Cub Scouting. They have been examples to their peers and siblings. Their dedication in working toward their rank advancements is commendable.

The Cubmaster now pulls on the first ribbon, which will pull the first ship in line closer to him. As this first ship comes in, call forward the boy to whom the ship belongs, along with his parents. The ship should be pretty easy to pop off the ribbon. If not, have a pair of scissor nearby, and just cut the ribbon close to the ship.

Take the awards out of the ship and present them to the parents to present to the boy. Talk a little about each award. Ask the boy what was required for this achievement. Hand the entire ship to the boy as a souvenir and give him the Cub Scout handshake. Lead applause. Repeat for each boy.

LIGHTHOUSE ADVANCEMENT - Continued

Leader awards can also be presented. It would be appropriate to draw the awards from inside or behind the lighthouse, since the leaders are guiding the boys in the same way the lighthouse guides the ships. You could make a small hole at the bottom of your lighthouse when you construct it for this purpose.

Materials Needed: Small tomato cage, construction paper or paper mache, a plastic Christmas candle, dish soap bottles, straws, paint, markers, stickers.

Lighthouse Instructions:

Make your lighthouse ahead of time. Use a small tomato cage turned upside down. Cover the bottom half of the cage, up to the smallest ring, with paper maché or construction paper. Color or paint the paper maché and/or construction paper in whatever lighthouse colors or styles you choose.

Cut off the top half of the three wires that are sticking up at the top. (The parts of the tomato cage that are usually stuck in the ground). Make a large cone shape out of construction paper. Rest this on top of the lighthouse. You should have a nice-sized space between the top of the construction paper or paper maché, and the lighthouse top you made from paper. Place a plastic Christmas candle inside the tomato cage so just the bulb is sticking up above the paper maché. You'll need to set it on a wooden block or something similar to make it the right height. Now your lighthouse has a light!



Now make the boats. There should be one boat for each boy and/or leader who is to be recognized. The boats could be made in den meeting, or as a pre-opener for pack meeting.

Small Boat Instructions:

Cut the top part off of dish detergent bottles about 2 to 3 inches from the bottom. This bottom part of the bottle will become your boat. Cut the neck ring from the top of the bottle and glue it inside the center of the bottom of the boat. Let dry. Cut a sail from white or colored paper. Glue the sail to a straw. Press some clay into the neck ring. Press the bottom end of the straw into the clay to mount the sail. Decorate the boat with permanent markers, stickers, plastic paint, etc.

Boats can also be made from small milk cartons or juice boxes. Lay the carton on its side, and then cut off the side facing up so you will have a hollow hull for your boat. Add a sail and decorate as desired.

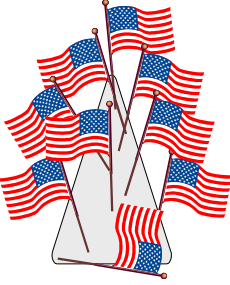
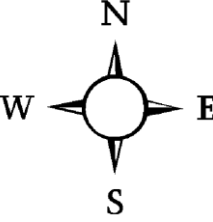

<p>Citizenship Courage</p> 	<p>FLAG TREE</p> <p>PROPS: Small flag for each boy receiving awards, Ribbon, Styrofoam tree shape</p> <p>Attach awards to ribbon, then tie ribbon to flag pole. Stick flags into foam.</p> <p>CUBMASTER: As we celebrate the birth of our great nation, we honor its flag. Our flag is flown to remind us of the honor, strength, dedication and divinity of our nation.</p> <p>As we celebrate our Cub Scouts we recognize within them the same spirit our great nation was built on. To remind them of their honor, strength, dedication, and divinity we present them with our nation's flag and their Cub Scouting emblems of achievement.</p> <p>(Pull flags out one by one and call up each individual boy with his parents and present him his award.)</p>
<p>Courage Faith Perseverance Responsibility</p>  	<p>NORTH STAR ADVANCEMENT CEREMONY</p> <p>Equipment: Pinhole planetarium punched for the Big Dipper and North Star, Flashlight.</p> <p>(The lights are dimmed. Cubmaster or an assistant beams the flashlight through the pinhole planetarium at the ceiling or a wall, showing the stars.)</p> <p>CUBMASTER: For thousands of years, men have known that the North Star is fixed. Shepherds knew it before the time of Christ. Seamen have used the North Star and other heavenly bodies to guide their ships to port ever since they first dared leave the sight of land. Even today, the stars are important in navigation for ships, jet planes and spaceships.</p> <p>Cub Scouts don't need the stars to find their way. But even so, you do have your own guiding stars to help you through life. There is your church, for instance. Your school is another example. So is Cub Scouting. In Cub Scouting, our navigational aids, the Promise and the Law of the Pack, are just like the stars by which the seaman steers his ship.</p> <p>Tonight we honor these Cub Scouts who are navigating straight and true on the Cub Scout trail. With their parents' help, they have advanced and have shown that they live by the Promise and the Law. (Give badges to the parents for presentation to their sons.)</p>

CUB SCOUT TRAIL

Arrangements: Tracks placed throughout the room. The Cubmaster marches out dressed in hiking clothes complete with backpack and an old canvas bag.

CUBMASTER: This is a bear bag. When people go camping in areas where there are likely to be lots of bears, they take all their food and put it in a bag like this. Then they hang it from a tree. This keeps the bears from getting it and ensures that the guy who hung it from the tree gets to keep his goodies. Well, in this bear bag, I've got stuff not only for Bears, but also for Bobcats, Wolves, and even Webelos.

CUBMASTER: The Cub Scouts in our pack have been moving along the Cub Scout trail these past months. They have been finding new things to do along the way; new things have been tried and new places seen. As we come to the end of one path, another is available to continue on. Let's walk among the paths we've traveled.

The Bobcat has alert ears and his movements are swift and sleek. We look forward to all of you traveling this path over the next few months and following the trail to the Tiger/Wolf path. Happy Trails! (All may be seated.)

For some, it began following a Tiger path. (Call forward the Tiger Cubs and parents.) Let's hear what Big Idea they've done during this last leg of their trail. (Recognize boys.) Let's direct them toward the next path of the Wolf!



The Wolf, who is an intelligent and loyal animal, has been traveling a path that has taught him about his country and home. He has learned many ways of nature and skills to help Mother Earth stay healthy. (Call forward the Wolf Cub Scouts and parents. Present awards.) They are ready to take a new path - the path of the Bear, where they will continue to experience and learn new things. Happy Trails to you, as well! (All may be seated.)

Bears have always been a symbol of strength. The Bear has learned many ways to use his strength to improve his body, his mind, and his environment. He has continually explored new ideas and learning new skills. (Call forward the Bear Cub Scouts and parents. Present awards.) You are ready to continue on the Cub Scout trail as Webelos Scouts. You will be preparing yourselves for Boy Scouting over the next few years. Happy Trails! (All sit.)

The Webelos rank may not be named after an animal but it does stand for something special. Webelos means "We'll be loyal Scouts." (Call forward the Webelos Scouts and parents. Present awards.) These young men have traveled far and have learned much. They will become apprentice outdoorsmen, foresters, geologists, and naturalists. They will keep learning on their trail to Boy Scouting. (All are seated)

**Citizenship
Cooperation
Honesty
Resourcefulness
Respect
Responsibility**



<p>Compassion Courage Resourcefulness Respect</p> 	<p>CELEBRATION ADVANCEMENT IDEAS</p> <ul style="list-style-type: none"> - Attach awards to calendar pages, embellished with the picture of the honoree, declaring the day “National Celebrate (insert boy’s name here) day!” or - Attach awards to the strings of balloons used for decorations. Write the recipient’s name on the balloon and let them search for their balloon. Throw confetti and blow noisemakers to celebrate when the boy has found his balloon. - Create your own holiday to celebrate. For example, a boy who has earned his Bobcat can celebrate “National Robert Feline (AKA Bob Cat) day.” A boy who has earned his Wolf can celebrate “Howl at the Moon Day (or Night).” A boy who has earned his Bear can celebrate “Wake Up from a Long Winter’s Hibernation Day.” Webelos awards can be celebrated with the “Loyal Scout Jamboree.” Use your imagination and create “days” that will fit the personalities of your Cub Scouts. - Don’t forget to honor your leaders for all their hard work. (Did you know there is a National Temporary Insanity Day? Perfect for your devoted leaders!) - Dress as Doctor Holiday in a lab coat, crazy wig and silly glasses. See what the doctor can “invent” in his lab to honor the Cubs. Use pots, pans, beakers, etc. for props.
<p>Faith Resourcefulness Respect Responsibility</p> 	<p>LET THE COMPASS GUIDE YOU <small>(Capital Area Council, Baloo’s Bugle July 2008)</small></p> <p>You will need a prop compass made of heavy cardboard placed in front on the advancement table.</p> <p>CUBMASTER: We look to the compass for our guide.</p> <p>To the East, we find a Cub ready for his Bobcat Badge. Will (name) and his parents come forward. (Present award.) He brings his eagerness like the dawn of a new day.</p> <p>To the South is the Wolf with his spirit of adventure. Will (name) and his parents come forward. (Present awards.)</p> <p>To the West is a Bear hunting on the trail of Scouting. (Present awards.)</p> <p>To the North is the Webelos about to realize his boyhood dreams, alive with Scout action. Will (name) and his parents come forward. (Present awards.)</p> <p>Let the compass guide all of you on your trails and may you all carry into your adult lives the ideals of Scouting.</p>

JUNGLE BOOK ADVANCEMENT

(Santa Clara County Council Pow Wow Book Feb. 1999)

When Baden-Powell started the Scouting movement, he felt that any Scout who took the time and trouble to master skills should be rewarded. He gave to each Scout who passed certain tests a badge to wear on his uniform. It recognized the importance of what the Scout had done and let others know of his achievement.

Cub Scouting is based on one of the stories in Rudyard Kipling's The Jungle Book. The story is called "Mowgli's Brothers." We know it as "The Story of Akela and Mowgli." In Kipling's story, the black panther, Bagheera, is the mighty hunter who teaches the cubs the skills of the jungle. In Cub Scouting we use the symbol of the Bobcat.

(Announce boys who have earned the Bobcat rank.)

The next adventure is the Wolf trail. This is a big adventure for a boy. The Wolf trail is much longer than the Bobcat trail. A Cub Scout should "Do His Best."

That's a part of the promise he made to become a Bobcat.

(Announce boys who have earned the Wolf rank.)

In the Bear book, we learn how Baloo, the wise old brown bear, teaches Mowgli the Law of the Pack. The requirements are a little bit more difficult than those for the Wolf badge. Obeying the Law of the Pack is another part of the promise he made to become a Bobcat.

(Announce boys who have earned the Bear rank.)

Webelos Scouting is an integral part of Cub Scouting. It has some distinct differences from the program for younger Cub Scouts, but it shares in Cub Scouting's main purpose. As a Webelos Scout, he learns new ways to "Help Other People," another part of the promise he made to become a Bobcat.

(Announce boys who have earned the Webelos rank.)

The highest award a Cub Scout can receive and transfer over to his Boy Scout uniform is the Arrow of Light. Usually awarded during a special ceremony, it is important to mention this light is at the end of the Cub Scouting trail. This "Light" with all the skills and tools it represents is carried forward to brighten the new world of Boy Scouting. It is in Boy Scouting and after that a boy will keep the promise he made when he became a Bobcat—"Duty to God and Country."

(Congratulate all boys who have earned a rank at this time.)

Compassion

Courage



Honesty



Perseverance

Positive Attitude

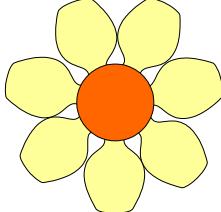
Respect



<p>Positive Attitude Resourcefulness Respect Any Value</p>  	<p>GARDENING THEMED ADVANCEMENTS</p> <ul style="list-style-type: none"> - Put awards in small plastic Ziploc bags. "Plant" awards in a large flowerpot with potting soil and then have each boy dig up his award. Write the boy's name on the flower pot, and then let him take it home as a memento. - Put awards in small plastic Ziploc bags. Bury the bags in a large plastic container, such as a plastic tote or a small wading pool. Let the boys dig for their awards with their hands, small shovels, or even spoons. - As a variation of the above idea, attach the award bag to a dog bone, then bury it. Tell the boys your dog stole the awards and buried them somewhere in this dirt. The boys can pretend to be dogs and dig out the bones with their paws. Since this will probably be very messy, do this outdoors. - Make a large flower with removable petals on a poster board. Awards can be written on the petals or taped to the back of the petals. As each petal is removed, an award is presented. - Dress like Indiana Jones. Tell the Cubs you have been on an exciting expedition where you've found the ancient burial site of the mighty king Mudicus Dirticus. You've brought back some of the treasure you've found there. Pull from a satchel bag, bags of dirt, dirt, and more dirt. Let the boys dig around in the bags of dirt for the treasures. The treasures, of course, will be their awards, suitably protected by Ziploc bags. If you don't have enough dirt, try play sand (available at most home improvement stores) or packing peanuts.
<p>Courage Health and Fitness</p> 	<p>ANIMAL SAFARI ADVANCEMENT <small>(Santa Clara County Council Pow Wow Book Oct. 2002)</small></p> <p>Equipment: Lots of house plants and trees, a stuffed animal from the home of each boy receiving an award. Attach the award to the stuffed animal. The Cubmaster can be dressed as if he is going on a safari, with a net to catch wild animals.</p> <p>The Cubmaster walks in like he is leading a safari. He goes in and out of trees until he comes to a stuffed animal. Then the Cubmaster pretends to catch the animal and find the award attached to it. He then presents the award, along with the animal, to the Cub Scout and his parents.</p>
<p>Any Value</p>	<p>OTHER IDEAS</p> <p>Awards could be hung on a growth chart, pulled off and presented to boys.</p> <p>Awards could be taped onto a BSA advancement chart.</p>

<p>BECOMING HANDYMEN</p> <p>EQUIPMENT: Hammer; nails; carpenter's apron w/awards in pockets; pins.</p> <p>CUBMASTER: Take a few moments to consider the claw hammer. It is a basic tool that should be part of every household. When fastened securely, its head doesn't fly off the handle. When used properly, it can drive a nail straight and true. It is not perfect, though, so on the opposite side is a claw to draw out crooked or misplaced nails and try again.</p> <p>Advancement in Cub Scouting is like this hammer. The boys earn badges after learning basic skills that will be part of their lives forever. As they work together with other Cubs in the den and the pack, they discover how to understand and listen and not get angry. By following Akela they have seen a straight path to walk. And they have made mistakes, but they try again. Tonight we are saluting those boys who are receiving their badges.</p> <p>Will the following boy(s) and their parent(s) please come forward for their Bobcat award. (As the families come up, hand the badge to the parent(s) and let them pin it on their son's shirt.)</p> <p>(Repeat for Tiger, Wolf, Bear, and Webelos badge, arrow points, Webelos activity badges and compass points.)</p> <p>Scouting helps the boys learn to plan a project, fit the pieces of the project together, and to take pride in the finished project.</p> <p>These boys, their parents and pack leaders have planned, fitted and are proud of their advancement tonight.</p>	<p>Honesty Perseverance Resourcefulness Responsibility</p>  
<p>RECYCLE</p> <p>Attach each award to a clean recyclable or reusable item (aluminum cans, plastic, bottles, newspaper, grocery bags, egg cartons, etc.)</p> <p>Call each boy and his parents forward. Ask them how to recycle or reuse the item with their award attached. Praise them for their good ideas. Ask for help from the audience if they are stumped.</p> <p>Present them with the award and the recyclable item, and challenge them to go home and recycle or reuse that item.</p>	<p>Citizenship Resourcefulness Respect Responsibility</p> 

Compassion
Faith
Honesty
Perseverance
Positive Attitude

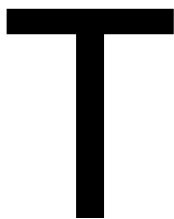

TO GIVE HELP AND GOODWILL

Personnel: Cubmaster

Equipment: Awards for boys (Bobcat awards on a smile, Wolf awards on a helping hand, Bear awards on a "T", and Webelos awards on a greeting card)

CUBMASTER: What do the virtues Faith, Hope and Charity have to do with Cub Scouting? As I repeated to myself the Cub Scout promise - the phrase "to help other people" stuck in my mind. Next I repeated the Law of the Pack and the words "a Cub Scout gives goodwill" came to mind. Helping other people and giving goodwill is what Cub Scouts do.

One small way to do this is to share is to smile and be cheerful to others. A smile is the first step to spreading goodwill. And tonight we have some boys who are taking their first steps along the Cub Scout trail. (Call forward the boys who are to receive their Bobcat award and their parents. Present the badge.)

After a smile, the next step is to lend a helping hand. This helping hand might be to carry in groceries for someone or set the table for dinner or wash the dishes after dinner - and all done with a cheerful smile. By offering this helping hand and cheerful smile we take the next step in living the virtues of faith, hope and charity. Tonight we have some boys who have taken the next step in Cub Scouting. (Call forward the boys who are to receive their Wolf award and their parents. Present the badge.)

What can we do to continue to help others and give goodwill? Our next step might be to do a "Good Turn." A good turn is to do a job without being asked to do it. This good turn might include cleaning our rooms, taking out the trash or shoveling snow without being asked. This good turn is a special step to bringing faith, hope and charity to others. Tonight there are some boys who have worked harder to take the next step along the Cub Scout trail. (Call forward the boys who are to receive their Bear award and their parents. Present the badge.)

To spread more joy, we can go even further to make a gift for a friend. We can make a special card or a small present or a treat for someone without expecting anything in return. With the giving of this special gift to a friend, we can continue to share our faith, hope and charity. We have some boys who are ready to advance along the Cub Scout trail and receive a gift. (Call forward the boys who are to receive their Webelos badge and their parents. Present the badge. Activity badges can be presented as well.)

Tonight we have seen how we as Cub Scouts and we as parents can remember to spread the faith, hope and charity. And by doing so, we will make the world a better place.

WEBELOS ACTIVITY BADGE CEREMONY IDEAS

Any Value

AQUANAUT - If the Pack meeting is held at a pool, have the boys swim across the pool to receive their badge. If inside, have them demonstrate a swimming stroke and pretend to swim to you to receive his badge.

ARTIST - Webelos leader is dressed as an artist and pretends to paint portrait of the Webelos as he is sitting on a stool posing. He puts down his palette and paintbrush and says "Each boy is a masterpiece." He then hands the boy a premade silhouette of the boy and the activity badge he has earned.



ATHLETE - Do a standing long jump and catch badge that the Webelos Leader is holding at arm's length.

CITIZEN - The Webelos Leader dressed as judge, pounds gavel on table and says, "Hear ye, Hear ye, Hear ye. I present to you on this day of in the year of Our Lord. 20_____, (boy's name) as a new citizen of our Pack and community."

COMMUNICATOR - Webelos leader uses sign language to tell what the activity badge is. He gives the badge to the Webelos Scout who thanks him in sign language.

CRAFTSMAN - Webelos leader and boys are busy building crafts and leader says, "Well boys, we've sure had a busy month making all these things, but I think we have made more than just toys. We have come a step closer in making you young men." He then gives them their badge.

ENGINEER - Several boxes with the name of Pack Leaders (Cubmaster, Den Leader, Committee Chairman, etc.) are scattered around. The Webelos Den Leader comes on stage and picks up a box and reads out loud what it says, and then places it back on the floor facing the audience. Start with the committee members first. Build the boxes up in the shape of a pyramid. As the name of a boy is read that has earned the activity badge he comes forward and is given the badge. His leader congratulates him on the achievement and tells him how great it is that he can be part of the Cub Scout pyramid.

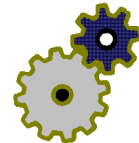

FAMILY MEMBER - The Webelos Leader calls the Webelos Scout and all the members of his family including brothers, sisters, and aunts, uncles, etc. He lines them all up according to size from the tallest one next to him to the smallest one next to the Webelos Scout. He then says "Since this activity badge was earned with the help of all the family, I will give it to the tallest member of the family. Each of you will pass it down the line until it reaches the Webelos Scout."

FITNESS - Do a sit up and reach out and take the badge that is being held at the end of his feet. (Just far enough to give him a good stretch before getting it.) Do a push-up. The boy will pick up the badge with his mouth as he lowers himself to the floor, and as the Webelos Leader is holding the badge near the floor beneath the boy.



Compassion
Courage
Perseverance
Positive Attitude
Respect
Responsibility



A TRIP ACROSS THE COUNTRY

(York Adams Council)

(Note. This ceremony is written so that any particular award can be used or omitted without impacting the whole of the ceremony.)

Tonight we're going to take a trip—a trip across the country—from sea to shining sea. We'll begin in the east and move our way west, like our forbearers did as they settled this great land. When our country first began as a new country, the land on the east coast was settled. People moved from other countries to this land of opportunity.

The trip through Cub Scouting happens in much the same way. When boys first join a Pack, they settle in this new world we call Cub Scouting. And, like the first settlers of the new world, they learn new ideas and new ways to live. The new Cubs have learned about the Pack and about Cub Scouting. They have discovered the Law and the Promise, the Cub Scout Sign, handshake, and salute, and other important things that make being a Cub Scout possible.

(Bobcat) Tonight we have several Cub Scouts, new to the Pack, who have just begun their trip. (List names of Bobcat recipients and call them with their parents to the front of the room. Hand parents the awards to present to the boys and congratulate them with the Cub Scout handshake. Offer applause and ask them to take their seats.)

Once the settlers became comfortable with how to live in the new world, they became more adventurous. They set out from the east to cross the Appalachian Mountains. As they crossed the mountains, they found new adventures and new challenges. In Scouting, the Wolf Cub Scout moves forward too, crossing his own "mountains" to meet new challenges and adventures. He learns about the American flag and his state flag; he begins to work on being physically fit, and he spends time learning more about his family, his home, and his neighborhood.

(Wolf) Tonight we have some Cubs who have crossed the mountains of the Wolf trail and have met the challenges and welcomed the adventures that have brought them. (List names and invite them with their parents to come forward. Hand out badges to parents to give to the boys. Congratulate them and offer a suitable applause. Have them sit down.)

So our trip continues. From the Appalachian Mountains, the settlers moved further west, into the Great Plains. Here they were greeted with challenges they had never imagined. But they also found the room to grow. That's exactly what happens after a Cub Scout leaves the Wolf Den and becomes a Bear. He faces more challenges, but he also learns and grows by facing those challenges

A TRIP ACROSS THE COUNTRY – Continued

(Bear) What does it take to face challenges and succeed in them? We can look to several of our Bear Scouts to find out. Tonight we have several Bear Scouts who have done just that. (List off Bear candidate names and invite them and their parents to the front of the room. Hand parents the awards to present to the boys and congratulate them. Offer applause and ask them to take their seats.)



Across the Great Plains and into the Rockies our settlers traveled. The Rockies presented to them the greatest of challenges. But again, they rose to the challenges, because they knew that with the hard work and hardships came a freedom and a strength that made it worth the effort. What about the Cub Scout's path? The next phase of their trail is the Webelos. Here the Cub Scout begins to let go of the security he has known from working closely with his parents. He starts his climb into a freer, but more responsible and more challenging level. He no longer has his parents sign off his completed requirements, but reports them to the Den Leader himself. He is becoming more responsible—the challenge—but is also growing more independent, learning to handle his freedom well.



(Webelos) Tonight there are several Webelos Scouts who have struggled up their own Rockies and have met the challenges offered. (List names and invite them with their parents to come forward. Hand parents the awards to present to the boys and congratulate them. Offer an applause and ask them to take their seats.)

So the settlers finally crossed the Rockies. Can you imagine what it was like for those that found their way to Yosemite Valley. It was a struggle to cross the coarse terrain, but the sights that awaited them were beyond compare. The settlers who spent their lives crossing the country, one step at a time, received the reward they richly deserved. They saw the golden rays of the sunset along the Pacific Coast and knew that they had done it themselves. And our Cub Scouts who grow into Webelos Scouts and advance the full trail of the Cub Scout program are also rewarded for their great accomplishments. They don't get riches of gold or silver; they don't get a life free of hard work, but they do get to know, deep down within themselves, that they have made it to the greatest reaches, for they have earned the Arrow of Light.

(Arrow of Light) Tonight we celebrate the accomplishments of those Webelos Scouts in the Pack who have reached the summit, the top, the farthest reaches. We recognize and congratulate them for their efforts; efforts that took their greatest strength to complete. (List names and invite them with their parents to come forward. Hand boys the parent's Arrow of Light pins to present to their parents. Then give parents the awards to present to the boys and congratulate them. Offer an applause and ask them to take their seats.)



<p>Cooperation Faith Honesty Positive Attitude</p>  	<p>CHRISTMAS LIGHTS (Santa Clara County Council Pow Wow Book, Dec. 2000)</p> <p>Props: Cardboard Christmas tree with holes for various colored lights or small tree (real or artificial). Unscrew bulbs. Small wrapped gifts under or near the tree, labeled with each boy's name and containing awards and a bulb.</p> <p>Cubmaster: (Invite each boy forward to open his gift, receive his award, and screw his light bulb into the lights of the tree. If there aren't many awards to be given, thus few lights, you may wish to acknowledge the contribution of the pack/den leaders, and call them up to add lights.) This holiday tree was rather bleak and common but as each boy added a bulb, the tree, and indeed the room, became brighter and more cheerful. The spirit of the holiday increases with each new light bulb which represents each boy's advancement. Cub Scouting does for a boy's life what the bulbs do for this ordinary fir tree, making it brighter, more beautiful, and something to behold and enjoy. Ordinary trees and ordinary boys are special in and of themselves, but here we can witness an added dimension. Thank you, parents, for encouraging your boys. Thank you, Den Leaders, for helping them along. Because of all of you, our lives are fuller, richer and brighter.</p> <p>Variation: Add a paper or popcorn chain to the tree.</p> <p>Cubmaster: There are other Cub Scouts in our pack who didn't have an opportunity to add a light tonight. Notice how the lights bring attention to the paper/popcorn chain which represents all the members of our pack families. You can see how each decoration and light makes a difference in the appearance of our tree. In the same way, each member of our pack, boys and adults, makes a difference in our success. Thanks to all of you!</p>
<p>Any Value</p> 	<p>HALLOWEEN ADVANCEMENT</p> <p>Draw awards from a steaming cauldron.</p> <p>Buy or make a cauldron. Place a can of water in the bottom of the cauldron, add a little blue food coloring, and then drop in dry ice. It will appear as if you are drawing the awards out of a steaming cauldron.</p>
<p>Citizenship Resourcefulness Respect Responsibility</p>	<p>JOHN F. KENNEDY</p> <p>President John F. Kennedy said, "It is our task in our time and our generation to hand down undiminished to those who come after us as was handed down to us by those who went before, the entire natural wealth and beauty which is ours." We have someone in our pack that is well on his way in that task. Will (name of boy) and his parents come forward and receive this (name of award).</p>

<p>BOBCAT CAMPFIRE INDUCTION (Santa Clara County Council Pow Wow Book June 1999)</p> <p>Equipment: Artificial campfire; stick for each Cub Scout receiving a badge; Bobcat badges (attached to safety pins)</p> <p>(Cubmaster calls the Bobcats and their parents forward and asks them to form a semicircle behind the fire, with the parents behind the boys.)</p> <p>Cub Scouts, you have learned the things a boy must know to join our pack. Will you show that now by making the Cub Scout sign and repeating the Cub Scout Promise? (Leads the Promise.) Parents, we welcome you into our pack, too. You know that you have a role in Cub Scouting as a guide in your son's advancement and as a participant and helper in the pack's activities. If you accept this responsibility, please say, "We will." (Parents give assent.) This campfire represents the warmth of membership in our pack. Bobcats please show that you wish to join in that warmth by adding your stick to the fire. This symbolizes that you want to do your best and be a friend to the others in the pack. (The boys place their sticks in the campfire.) Now, parents, I will give each of you the Bobcat badge to pin on your son's shirt. Congratulations.</p>	<p>Any Value</p> 
<p>PICNIC ADVANCEMENT (Santa Clara County Council Pow Wow Book May 2001)</p> <p>Props: Picnic basket; items needed for a picnic i.e., paper plates, cups, utensils,</p> <p>Cubmaster: We have several Cub Scouts to honor today for the hard work they have done since our last meeting. With the paper plates, we have the Bobcats. (Call boys and parents forward. Pull from a picnic basket Bobcat badge attached to a paper plate, one plate per recipient. Present awards and give congratulations. Present other badges, activity badges, and arrow points attached to plastic forks, spoons, paper cups, etc.)</p> <p>Cubmaster: You have seen all of the things that help make a picnic meal fun, except the food. These young men and their parents represent the things that make the pack grow and thrive. They are as important to a pack as food is to a picnic. Let's wish them well as they continue on their trail in Cub Scouting.</p>	<p>Cooperation Perseverance Positive Attitude Responsibility</p> 

Cooperation
Health and Fitness
Perseverance
Resourcefulness



THE ATHLETE ADVANCEMENT

(Sam Houston Area Council)

PROPS: Cubmaster can select any sport and use appropriate equipment as props throughout this ceremony.

CUBMASTER: The first thing an athlete learns is the basic rules of his chosen sport. When a Cub first enters the Pack, he learns the Bobcat Trail, which gives him the first knowledge he must know to move up the Cub Scout Path. Will the following boys and their parents please come forward? (Present the Bobcat Awards.)



When a boy has learned the basic rules of his game, he then begins to practice the skills needed to play. He becomes familiar with the sports equipment. Our Wolves have worked on achievements and arrow points as they continue to develop their Cub Scout skills. Will the following boys and their parents please come forward? (Present the Wolf Awards.)

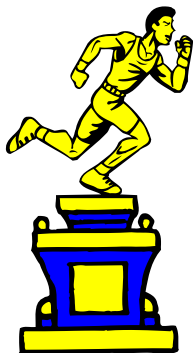

The athlete is now ready to concentrate on improving his athletic skills. Bears are like the athletes who increase their knowledge to become more proficient in their games. Will the following boys and their parents please come forward? (Present the Bear Awards.)

Once the rules have been well learned and the skills have been mastered, the athlete is now ready to advance to a higher level of skill, which involves the mental strategy used to fine tune their playing skills. Both physical and mental skills are part of the learning experience of the boys in the Webelos rank. Will the following boys and their parents please come forward? (Present the Webelos Awards.)

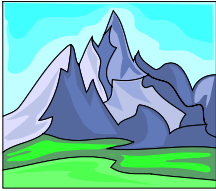

As our ceremony concludes, we recognize the progress our Cubs have made this past month. The athlete who is dedicated to his sport recognizes the many achievements he has made this past month. The athlete who is dedicated to his sport recognizes the many abilities he has developed within himself. He is knowledgeable of the basic rules and he is dedicated to the practices which develop his ability. The mature athlete has become confident in his ability to play the game and becomes a leader who shares his knowledge and skill with others on his team. All these traits belong to the boys in our Pack as we see them progress from month to month and year to year. We are proud of these boys and the leaders who guide them along the Cub Scout Trail.

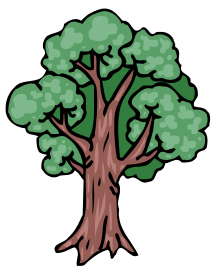
<p>THE ADVANCEMENT TRAIL</p> <p>You will need a poster showing a mountain on which there has been drawn a distinct trail. As each Cub Scout comes up for his advancement, he places the proper Cub Scout sticker in place along the trail. The stickers are available at the Scout office.</p> <p>After all the Bobcats have received their awards have them say, "I am a BOBCAT – a beginner on the Cub Scout trail, now I have passed my Bobcat requirements I am on my way."</p> <p>After all the Wolves have received their awards have them say, "I am now a WOLF Cub along the Cub Scout trail. I've earned my badge and arrow points and I am ready to go another step of the way.</p> <p>After all the Bears have received their awards have them say, "A BEAR Cub Scout I have become, I'm in my second year. Up, up the Cub Scout trail I go- soon to be a Webelos.</p> <p>After all the Webelos have received their awards have them say, "WEBELOS is the name for me. I spend my time earning Activity badges; there's still one more step for me.</p> <p>I, too, am a WEBELOS but I have reached the top. I've earned the ARROW OF LIGHT Award. (Place badge or sticker on the top of the mountain.) But I have one more step. By earning my Arrow of Light, I've studied quite a bit about Boy Scouts. Now I can't wait to become one. (He puts on a Boy Scout hat.)</p>	<p>Courage Faith Positive Attitude Respect Responsibility</p>  
<p>KEYS TO THE CITY</p> <p>Props: Collect a bunch of old, unused keys and tie them on awards with ribbons.</p> <p>Instructions: The Cubmaster, acting as Mayor, explains to the pack the tradition of the town mayor bestowing on honored guests and dignitaries a "Key to the City". He/she then calls up the Cub Scout and his parents to receive the Key to the Bear Rank, etc. for his contributions to his den and pack.</p>	<p>Citizenship Cooperation Honesty</p> 

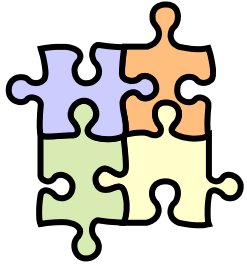
<p>Citizenship Resourcefulness Respect Responsibility</p> 	<p>GROWING TREES AND BOYS</p> <p>Put awards on paper leaves and attach to small tree before Pack meeting. (Show a small tree and a Cub Scout side by side.)</p> <p>This little tree is a symbol of the natural beauty of our land. This tree also represents Scouting. It takes a long time for a beautiful tree to grow and develop. In the same way, a Cub Scout spends a lot of time and effort in advancing from rank to rank. So do his parents who help him. Each of these leaves represents the time and effort put into the advancement work by our Cub Scouts and their parents. Our Den Leaders also played a very important part in the advancement program, for without their support we could not have the opportunity to be in Cub Scouting. Will the following boys and their parents, please come forward when called. (Assemble all of them at the front of the Pack and call up the Scouts' Den Leaders.) Each of you has helped nurture this Cub Scout. Just as trees endure for many, many years, so the values you have gained from working on achievements, electives and activity badges will last you a lifetime. May you always stand strong and tall like a tree - and be a beautiful resource for our land.</p>
<p>Cooperation Positive Attitude Respect</p>  	<p>JIGSAW PUZZLE BOARD</p> <p>The Board: You will need a large drawing, painting, or photo of a Cub Scout or Cub Scout emblem. (Your local council might have suitable pictures from old recruiting materials.) Paste it on a large piece of cardboard or foam board. Cut the board into jigsaw pieces, with one piece for each boy who is to receive an award. Tape the awards to the back of the pieces.</p> <p>Just before the advancement ceremony starts, put a dot of glue on the back of each piece so that it will stick to the easel board. Double sided tape works well</p> <p>Cubmaster: In a way, our pack is like this jigsaw puzzle. It has many pieces—boys and parents—who work together to make the pack go and grow. As we give the awards, we will see how we cooperate and work together to make the big picture of Cub Scouting.</p> <p>The Cubmaster or den leaders hand the boys' parents their puzzle pieces. The parents remove the awards from the puzzle pieces and pin them on their sons' shirts. The boys and parents then work together to put the pieces of the puzzle together.</p> <p>Cubmaster: There, they've finished the puzzle. All of them contributed to make the big picture. That is the story of our pack— people working together to make the whole thing work.</p>

CUB SCOUT BASEBALL

(National Capital Area Council)

Equipment: A small baseball diamond on the floor in front, badges to be awarded.

Personnel: Cubmaster, boys to receive awards and their parents.

Cubmaster: Will (names), our new Bobcats, and their parents please come forward to the "on-deck circle"? As you are standing on the "on-deck circle", you are at the beginning of the "game" just as you are at the beginning of the Cub Scout trail. Parents accept your sons' badges.

Will (names), our Wolf candidates, and their parents please come forward? Stand on first base. This represents the first stop on your Cub Scout trail. You worked hard on earning your Wolf, so keep up the good work. Parents here are their badges.

Will (names), our Bear candidates, and their parents please come forward? Your place on our diamond is at second base. This is the second major stop along the Cub Scout trail. Parents accept your son's badge.

Will (names), the Webelos and their parents please come forward. Your spot is third. You are almost "home", keep up the good work and you will have no problem in finishing your trail. You now wear a badge diamond on your shirt; to complete that game you need to receive your Arrow of Light. Work hard and you should have no problem. (If you have boys earning the Arrow of Light, their spot is home plate.)

**Cooperation
Courage
Health and Fitness
Positive Attitude**

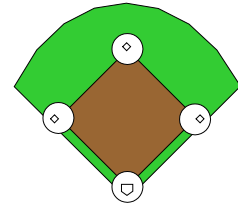

RESCUE ADVANCEMENT





In Cub Scouting the boys learn how to take care of themselves and how to put on a band aid. They also learn what to do in the case of a car accident, bus accident, boat accident and how to stop, drop and roll if they are on fire.

There are many people that help us in an emergency. Like the Cub Scouts, they do their best. This is the Cub Scout motto, "Do Your Best." This is one of the things the Cub Scouts are always trying to do.

Would _____ please come forward. This Cub Scout has worked hard to "do his best" in earning this award. We would like to present it to him at this time. (Give boy award and congratulate him.) We would also like to honor him for this achievement by doing the Grand Howl.

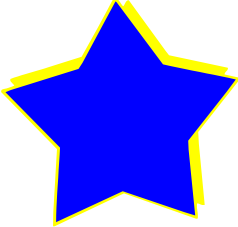
**Perseverance
Responsibility**



<p>Cooperation Courage Health and Fitness</p>  	<p>ALL-STAR ADVANCEMENT</p> <p>Cubmaster: Tonight, we are here to honor the All Stars of Pack _____. These boys have practiced and sweated and deserve recognition for their excellence, their diligence and their accomplishments.</p> <p>We would like to call up All Star _____ and his coaches—his family. He really hit it this month, and earned his _____.</p> <p>Next, we have All Star _____ and his coaches. He was really on the ball this month and is receiving his _____.</p> <p>Now in the lineup is All Star _____ with his coaches. He made a real slam dunk with his _____ award.</p> <p>Then, we have All Star _____ who really tackled a lot this month with earning his _____. Bring your coaches forward, please.</p> <p>Last but not least, we have All Star _____, with his coaches. He really kicked into gear this month and scored a GOOOAAALLL! While earning his _____.</p> <p>Suggestions for additional All Stars: His performance was better than par—he hit a hole-in-one! He made a big splash in the Cub Scout pool. He sprinted to the finish line. He rolled strikes and bowled a perfect game. He really aced the serve.</p>
<p>Citizenship Respect Responsibility</p>  	<p>NATURE AND THE GOOD VISITOR</p> <p>Cubmaster: We are together to think about nature. We can enjoy the great outdoors, but we need to think of others who will follow us. Wherever you go in the great wide world of nature, try to be a "good" visitor who will leave the plants and the creatures for others to enjoy after you leave.</p> <p>Cub 1: The only shots I took were snapshots.</p> <p>Cub 2: I tried to walk on pathways to keep off plants.</p> <p>Cub 3: When I see animals or birds, I try to remember that I am a guest in their living place and I don't do anything to them but look at them.</p> <p>Cub 4: The one big thing I always do when I am ready to go home is to look and see that all fires are out in nature's backyard.</p> <p>Cubmaster: With Cubs and Webelos like you to help keep our friends on the ball, I'm sure that the beauties of nature will be around for years to come.</p>

POCKET CEREMONY

(Southern NJ Council, Baloo's Bugle Oct. 2004)

Most boys begin their collections IN their pockets. Cub Scouts take this a step further and use the pocket on the uniform as a place to build a collection. Here is a pocket - a very plain pocket - not very interesting, and it could belong to anyone. But wait; let's give this pocket to a Cub Scout.

(Narrator places Bobcat badge on pocket.)

Our pocket is turning into something with meaning. It shows a sense of belonging and will soon bring our Cub Scout knowledge, skills, enjoyment and good fellowship. We would like to present the following boys and parents their Bobcat badge.

(Narrator places Wolf badge and arrow points on pocket.)

With the Wolf rank, our pocket turns into something more special. It proudly displays the first symbol of new-found knowledge of the flag, of keeping strong, of tools, of knots, of safety, of books and reading. It means our Cub Scout has mastered feats of fun. Tonight we are privileged to recognize the following Cub Scouts who have achieved the rank of Wolf. Would the following Wolf candidates and their parents please come forward?

(Narrator places Bear badge and arrow points on pocket.)

Adding the Bear badge has increased our pocket's meaning even more. It shows our Cub Scout is completing increasingly difficult achievements which show he is growing in knowledge and skill. Would the following Bear candidates and their parents please come forward?

(Narrator places Webelos badge and Arrow of Light on pocket.)

Our pocket has now had placed upon it the Webelos badge and Arrow of Light, the highest awards which our Cub Scouts can achieve. To receive these awards, our Cub Scouts must dedicate themselves to the hard work necessary in completing the required number of activity badges and prove themselves ready to join the ranks of Scouting. Tonight we wish to recognize these boys who have completed activity areas within the Webelos program. Will the following boys and their parents please come forward?

(With the Webelos Scouts together, a candle ceremony may be added at this time.)

Our pocket is very special now. It is very rich in new possibilities. It opens up a whole new world of challenges. Cub Scouting has taken our plain pocket, and turned it into a pocketful of adventure, fun and excitement. Congratulations to boys and parents!

Perseverance Resourcefulness Responsibility

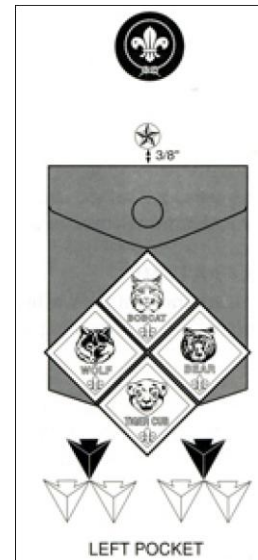

Any Value**JUNGLE BOOK CEREMONY FOR ADVANCING TO BOY SCOUTS**

(Adapted from Original by Edward A. Haluska)

Personnel: Cubmaster, Scoutmaster and Boy Scouts from the troop.

Equipment: Bridge (a small symbolic one is adequate), Boy Scout neckerchiefs, suitable recorded music and something to play it on.

Akela: The moon is full, just as it was long ago on that night in the jungle when Mowgli first joined the Seeonee Wolf Pack. It has been many years since he returned from living with the wolves. After he returned, he taught us many of the lessons he learned while in the jungle. The most important was that the strength of the wolf is the pack, and the strength of the pack is the wolf.

That is why we are here tonight in this council ring. Just as Mowgli had to leave the pack, tonight we also have some man cubs among us who have grown strong and tall. The time has now come when they too must leave the Pack to find their place in the world of men. They have learned many lessons as they have walked the trails of the Bobcat, Wolf, and Bear. Tonight these Cubs are ready to begin their next adventure on their way to manhood. Parents, bring forward these man cubs. *(Akela calls out the names of the Cubs who will be advancing. Parents and Cubs come forward and face the rest of the pack.)*



Akela: Akela of the humans!

Scoutmaster: What is it that you want, Akela of the man cubs?

Akela: We have among us several boys who have grown tall in body and strong in character. They have learned well the ways of the Pack, but now they yearn to run with other boys who are also between their childhood and manhood. They have been with the Pack for many moons and have been a source of pride for us all, but now it is the season when they must leave us.

Scoutmaster: We understand. Bring them to the bridge between us. *(If you have music, start it now. Akela leads the cubs, one at a time, to the center of the bridge between Cub Scouts and Boy Scouts. The boy is stopped at the center of the bridge and Akela then removes the Cub's Webelos neckerchief. The Scouts of the Patrol place a Boy Scout neckerchief on the boy and lead him to their group.)*

Akela: Although these boys are no longer with our Pack, we still ask that the Great Akela watch over them as they learn to soar with the eagles. In the fullness of time, after the great wheel of life has turned full circle, when the season again comes to the time to gather in, and the moon is full, we pray that these boys will return, tall and proud and strong, and present their own man cubs to be accepted into the pack. Until then, let us send them on their way with one last wolf howl. *(Akela leads howl)*

<p>CORN CEREMONY (THANKSGIVING)</p> <p>Equipment needed: Cubmaster and Advancement Chairman, badges and activity pins for boys, kernels of corn.</p> <p>CUBMASTER: Tonight, we are remembering the Pilgrims and the Native American Indians. The Pilgrims came to this country for religious freedom. When they got here, they found new friends, the American Indians. The Pilgrims and the Indians shared many things to survive.</p> <p>ADVANCEMENT CHAIRMAN: Would these boys and their parents please come forward. (Read the name of boys receiving Wolf badge.)</p> <p>You boys have shared with each other the gift of working together in your dens and homes. For this, we present to you your Wolf badge, and also a kernel of corn, as the Indians gave to the Pilgrims.</p> <p>CUBMASTER: Would these boys and their parents please come forward. (Read the names of boys receiving the Bear badge.)</p> <p>Work was one of the things respected by the Pilgrims and Indians alike. The Pilgrims even made it a rule that if a person did not work, he would not eat. For your work, we give you this Bear badge and also a kernel of corn, as the Indians gave the Pilgrims.</p> <p>ADVANCEMENT CHAIRMAN: Would these boys and their parents come forward? (Read the names of the boys receiving Webelos badges/activity pins.)</p> <p>You boys have been working for a long time, and you have learned many skills that the Pilgrims had to learn in order to survive. They helped build this great country where we live today. For these skills we give you your badge/activity pins and a kernel of corn, as the Indians gave to the Pilgrims.</p> <p>CUBMASTER: Good work, Cub Scouts. Continue to work together to build and even better America. Use the skills you have learned here in Pack _____. And remember, always do your best.</p>	<p>Citizenship Compassion Perseverance Respect</p>  
<p>PLANT</p> <p>Attach each award to a small plant. Give a plant to each award recipient and challenge them to go home and plant it in their yard. These plants help clean the air and will remind the boys of the awards they earned in Cub Scouts.</p>	<p>Citizenship Resourcefulness Respect Responsibility</p>

Citizenship
Resourcefulness
Respect
Responsibility



PLANT A TREE

(Baloo's Bugle April 2000)

Make a large tree from cardboard, or paint one on an appliance box. Attach awards to paper leaves. Cubmaster recites the following poem.

What do we plant when we plant a tree?
 We plant the ship which will cross the sea.
 We plant the mast to carry the sails,
 We plant the planks to withstand the gales;
 The keel, the keels on, the beam, the knee,
 We plant a ship when we plant a tree.

What do we plant when we plant a tree?
 We plant the houses for you and me.
 We plant the rafters, the shingles, the floors;
 We plant the studding, the lath, the doors,
 The beams and siding, all parts that be;
 We plant a house when we plant a tree.

What do we plant when we plant a tree?
 A thousand things that we daily see.
 The paper for books from which we learn,
 Tools to help us to do a good turn,
 The wood for a Pinewood Derby car,
 For model planes that we can fly far,
 We plant the staff for the flag of the free,
 Yes, we plant all these when we plant a tree.

But what do we plant when we plant a lad?
 With the help of his mother and his dad.
 We plant a Cub who'll become a Scout,
 We plant ideas that will round him out,
 The skills, the games, the joy to be had.
 We plant a Scout when we plant a lad.

(Boys tape their leaves onto the tree branches.)

You have all helped make this tree more beautiful. It is a part of you. Just as Mother Nature's trees endure for many years, the things you have learned from your achievements and badges will last you a lifetime. May you always stand straight and tall like a tree, and be a worthy resource of our country.

IMMEDIATE RECOGNITION DEN CEREMONY

(Heart of America Council)

Here is one the Den Leader can use when her Cubs earn their first Immediate Recognition beads.

As a Cub Scout completes achievements for Wolf and/or Bear, the den leader should make sure that a simple recognition Ceremonies is held in the den meeting. Use the Cub Scout Immediate Recognition Kit which contains enough materials for a den of Cub Scouts for two years. This is a motivational device used to encourage each boy to complete the rank for his age. Use a brief ceremony related to the monthly theme, or the one below:

DEN LEADER: We would like to tell you the story behind these wonderful beads. The custom of awarding beads started in the ancient tribes of the Webelos. They were given to braves who did their best to help the tribe and others.

DEN CHIEF: Many moons ago, when the animal world was ruled by wolves and bears, the braves of the Webelos tribe feared these strong beasts.

DEN LEADER: But some braves (names of boys being recognized) still untried, decided that the best way to live without fear was to learn to understand the creatures of the forest.

DEN CHIEF: So they went, disguised as animals, to live with the wolves and bears. The animals accepted them and all their brothers and called them 'cubs' just as if the braves were their own. This was according to the Law of the Pack.

DEN LEADER: For their bravery and friendliness to the beasts, they were given a thong with colored beads on it. It signified that he knew the ways of the tribe and did his best at everything without worrying if someone else did better. This is the Law which the tribe borrowed from the animals and had the 'cubs' learn. (Ask den to form a living circle and repeat Law of the Pack.)

DEN CHIEF: For doing your best in completing three achievements toward your (Wolf/Bear) badge, I award you (names) this thong and this bead. May you always obey the Law of the Pack.

Any Value

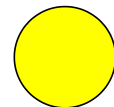

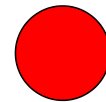

Wolf



Bear

There are many different things that you can use to paint on the boys faces for "painted" ceremonies. One of the easiest to use are the small make-up "crayons" that you can find easily at Halloween time.

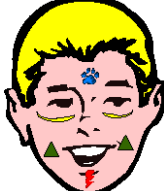
Check with the boy and his parents before doing a painted ceremony. If a boy does not want to have his face painted some of these painted symbols can be done on the back of his hand instead.

<p>Any Value</p>  	<p>PAINTED BOBCAT</p> <p>Will _____ please come forward and take on the colors and spirit of Scouting?</p> <p>(BLUE paw on forehead) Blue is from the sky. The mark on your forehead is the spirit of the bobcat. This reminds you to “Do Your Best” on the Cub scout Trail.</p> <p>(YELLOW curves under both eyes) Yellow is from the Sun. The marks under your eyes will help you see the light of the Cub Scout Trail. They also symbolize the bright spirit of cub scouting.</p> <p>(WHITE line on nose) White is for purity. The mark on your nose helps you to know right from wrong as you go along the cub scout trail.</p> <p>(RED zig zag on chin) Red is for courage. The mark on your chin reminds you to always speak the truth.</p> <p>(Green triangles on cheeks) Green is for nature. The marks on each cheek will guide you to live in harmony with the great outdoors.</p> <p>Remember your markings this night new bobcat, and have fun along the Cub scout trail. (Present Bobcat Award)</p>
<p>Any Value</p>  	<p>PAINTED WOLF</p> <p>Will _____ please come forward and receive the mark of the wolf. Do you seek the rank of Wolf? (Yes) Repeat with me the Cub Scout promise: (Repeat promise)</p> <p>I can see by your knowledge of the Cub Scout promise and the achievements that you have completed that you have worked hard. You are now ready to receive the mark of the Wolf.</p> <p>1 – The first toe of the wolf paw is for your growth thru feats of skill and having fun with your family. (Draw toe on forehead)</p> <p>2 – The second toe of the wolf represents what you have learned about your home, community, and country and religion. (Draw next toe)</p> <p>3 – The third toe of the wolf paw stands for the skills you have gained in handling tools, tying knots, using books, and making collections. (Draw next toe)</p> <p>4 – The fourth toe of the wolf represents your new appreciation for conservation as well as safety at home and in traffic. (Draw last toe)</p> <p>Pad – The pad of the wolf paw represents your growth as a Cub Scout, and the increased responsibility you are now capable of handling.</p>

PAINTED ARROW OF LIGHT CEREMONY

Have one person read while another does the "painting". as each part is mentioned; draw a blue arrow pointing to the right on their forehead. Draw a yellow sun/half circle above the arrow (be sure to leave room for the rays) Then draw one ray for each of the virtues - 7 yellow rays total coming off the sun.

The Arrow of Light symbol is made up of an arrow which is straight and true, just as you should be in your life and it points the way to a good and happy life. The sun shines light on all that we do, as a reminder that you should be a light for those around you. It is a rising sun which symbolizes the constant new challenges provided by Scouting and by life itself. The seven rays represent the seven days of the week, as a reminder to do your best every day.

This first ray represents **Wisdom**. Having wisdom doesn't mean that a person is smarter than others. It means that he uses what he knows to live a better life.

This ray represents **Courage**. Courage does not mean you have no fear of danger. It means that you can face danger despite your fear.

The third ray stands for **Self Control**. Self-Control means being able to stop when you have had enough of something and being able to choose your own path instead of merely following others.

The fourth ray stands for **Justice**. Justice means being fair with others we play and work with, regardless of who they are.

The fifth ray represents **Faith**. Faith is a belief in God, and in those things that we can't see, but know are true.



This ray represents **Hope**. Hope means to look forward to good things you believe will happen. You hope for better things tomorrow, but at the same time you work hard today to make them happen.

The last ray of the sun of the arrow of light symbol stands for **Love**. There are many kinds of love. Love of family, home, fellow men, God, and country. Every kind of love is important for a full and happy life.

You will find that living by these seven virtues can lead to a good and happy life. The Arrow of Light is a significant achievement. It is recognized as such by the Boy Scouts of America. When you become a Boy Scout, you will continue to wear the Arrow of Light on your uniform. Follow where the Arrow of Light points - toward the trail of the Boy Scout and eventually to soar to great heights and obtain the Eagle Scout Award. Strive to live by the ideals you have learned in Cub Scouts, especially the Cub Scout motto: "DO YOUR BEST"

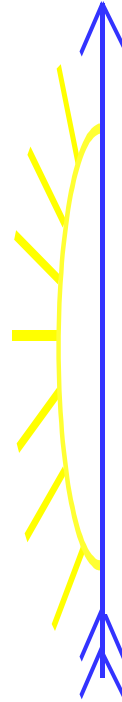
Any Value



<p>Any Value</p> <p>New Cub Scout Induction</p>  	<p>THE DESIRE TO JOIN THE PACK</p> <p>CUBMASTER: Do we have any boys who desire to join the Pack?</p> <p>DEN LEADER: (Comes forward) Akela, I have a boy who has shown his desire to join the Pack.</p> <p>CUBMASTER: Does he come alone?</p> <p>DEN LEADER: No, his family wishes to join the Pack also.</p> <p>CUBMASTER: Please present them to the pack here at the council fire. (Den Leader escorts the boy and his family to the front).</p> <p>CUBMASTER: What is your name? (Boy Answers) I understand you wish to become a member of our Pack? (Boy Answers) Do you know the Cub Scout Motto? (Answer) Are you prepared to work hard, advance in rank and have fun? (Boy Answers) Are you willing to do your best? (Boy Answers)</p> <p>CUBMASTER: (Addressing parents) Cub Scouting is a family program. Parents have certain responsibilities too. They are expected to help their son advance in rank. They are expected to attend Pack Meetings with their son, and help at other times when called upon. Are you willing to do these things to help your son achieve the goals and fun that will be his in Cub Scouting? (Parents Answer)</p> <p>CUBMASTER: (To boy and parents) You are all starting on the Cub Scout trail which leads to the great game of Scouting. May each of you be happy in our Pack.</p> <p>CUBMASTER: Will the Pack all stand and join with me in a welcome cheer for the newest member of our pack. (Lead Cheer _____)</p>
---	---



Bear in His Cave

Equipment / Preparation: One person (the "bear") is hidden behind a curtain or in an adjacent room. The Cubmaster and 2 adults are recruited to participate and given their parts.

Note: If there are any concerns that the boy will be frightened by the ceremony, he is told what will happen beforehand, but no one else knows what is happening until the ceremony starts. All of our scouts look forward to earning the privilege of "proving his bravery". Adults always play the part of the bear so no excessive roughness enters the ceremony.

Cubmaster is presenting the Bear badge to the Cub Scout.

1st adult interrupts and asks: "Has this scout met all the requirements for the Bear rank?"

Cubmaster answers "Yes" and again starts to present badge.

2nd adult interrupts and asks: "Has he proven his bravery by facing the bear in his den?"

Cubmaster asks scout who states "No".

2nd adult then states: "Then I insist he do so before he receives his badge."

The Cub Scout then goes behind curtain or in next room to "face the bear."

The "bear" growls pulls off the boy's shoes, scarf, etc. and throws them out. Act like there is a big fight going on.

The Cub Scout then comes out to the applause of the audience and receives his award.

Any Value



Any Value

AKELA'S TEST

(Rick Clements, Suffolk County '95 Pow Wow Book)

For: Akela (Cubmaster), Baloo (Asst. Cubmaster or Com. Chair).

Baloo: Akela had to pass a test to prove himself worthy of becoming chief. In Akela's tribe, all braves desiring to be chief were given four arrows. These were special arrows: once used, they shattered. Braves could eat only food they caught themselves. The brave who stayed out the longest would become chief. Let's listen to Akela relate his tale.

Akela: I walked far from camp and stopped at the side of a clearing. I waited all night for a deer to come by. When one appeared, I took careful aim and shot. The meat of the deer provided me with food for many days. It's hide provided me with clothing.



Baloo: This showed that Akela had learned the basic skills to survive. It also showed the virtue of patience. The rank of Bobcat indicates the Cub Scout has learned the basic skills. Will our newest Bobcats come join us by the fire? Parents will join you later. (Names) have earned their Bobcat badge.

Akela: I walked along the trail near the stream. There, I came upon a friend laying in the trail. He had used up all his arrows and was starving. I saw a squirrel in a nearby tree. I wanted to save my arrows for bigger game, but my friend was starving. So, I shot the squirrel for my friend.

Baloo: This showed that Akela learned the value of friendship and that he was unselfish. The Wolf badge indicates the Cub Scout has learned these new values on the trail of Scouting. Will our new Wolf Scouts join us by the fire? (names) have earned their Wolf badge.



Akela: As I followed the trail by the stream, I came face to face with a huge bear. It growled and started running toward me. I strung my bow, took careful aim, and when he was near, I shot and killed him. He provided me with food for many more days. His heavy coat provided me with shelter from the cold nights.

Baloo: This showed that Akela was brave. This is also why we honor the Cubs with the next level of accomplishment ... the Bear badge. Will the new Bear Scouts join us by the fire? (Names) have earned their Bear badge.

Akela: The meat from the bear lasted for many days, but soon I had to continue on in search of more food. I came upon a wolf that had just killed a deer. The wolf saw me and ran off. I was hungry, but I had promised to eat only food that I had killed, so I continued on.

AKELA'S TEST - Continued

Baloo: This showed that Akela was honest. To earn the Webelos badge, the Cub Scout must learn the Boy Scout law which includes honesty. Will the new Webelos Scouts come join us by the fire? (names) have earned their Webelos badge.

Akela: I was many days from camp. I needed food to give me strength, so I tracked the wolf I had seen before. I strung my last arrow, took careful aim, but missed. I was scared because I had no food or arrows. As I started back to camp, I prayed to the great spirit. Suddenly, I saw the arrow; it was still whole! I followed the wolf's trail again. I took aim, pulled back the arrow and let it fly. This time the arrow found its mark! I now had enough food to return home.

Baloo: Akela learned that sometimes you have to ask for help. Our Cub Scouts sometimes need help also. Their Den leaders and parents provide that help. Will the parents of all these Scouts please come up and stand behind their son? (Provide time for the parents to assemble with the scouts.)

Akela: Congratulations to you scouts on achieving this difficult rank. You will now receive the symbol representing your new rank. (Akela presents the badges to the parents of the Cub Scouts and gives the Cub Scout handshake to each Cub Scout.) Would the parents place the cloth badge on the uniform upside down as is the custom of our tribe? (Parents attach badge upside down.) It may be attached right side up, permanently, after a good deed has been done by the scout. The pin is worn by you parents to signify the help you have given your son.

Baloo: Please join Akela and I in the Law of the Pack:
The Cub Scout follows Akela.
The Cub Scout helps the Pack go.
The Pack helps the Cub Scout grow.
The Cub Scout gives goodwill.



<p>Any Value</p> <p>Arrow of Light</p> 	<p>ARROW OF LIGHT CEREMONY</p> <p>Equipment: Arrow of Light Ceremonial Board cut out as a large Arrow of Light, four red candles, three white candles, Arrow of Light award and certificate People: Akela, Webelos Den Leader, and two Webelos Scouts.</p> <p>WEBELOS SCOUT #1: (Lights the four red candles, as he says the name of each of the ranks.) The four candles represent the Bobcat, Wolf, Bear and Webelos rank in Cub Scouts. WEBELOS SCOUT #2: Webelos means "We'll Be Loyal Scouts." Loyalty is one of the most important things a Cub Scout stands for. (He lights the 3 white candles as he says) He is loyal to God, his country, and his home.</p> <p>AKELA: (speaking to the Arrow of Light candidate) _____, will you give me the Cub Scout sign and repeat the Cub Scout Promise. (After he does) To your parents, I give the Arrow of Light Award and Certificate. The badge is worn on the uniform, centered on the left shirt pocket flap. This is the only emblem that can be earned, besides the religious award, which can be worn on the Boy Scout uniform yet earned as a Cub Scout. On the Boy Scout shirt, it will go on the bottom of the left pocket.</p> <p>WEBELOS DEN LEADER: _____, I salute you as a Webelos Scout. (Salutes the boy.) Continue to work hard as you go further along the Scouting trail. I leave you the wish of Sir Robert Baden-Powell, the founder of Scouting, as he said "Good Scouting to you."</p>
<p>Any Value</p> <p>Arrow of Light</p>	<p>OUTDOOR ARROW OF LIGHT CEREMONY</p> <p>Around a prepared council fire, the crowd sits in a circle. String a flare to a wire and suspend it on an angle from a high object to the fire. As the boy is presented to the audience, as having earned the Arrow of Light, the flare is lighted and allowed to slide down the wire. This is the arrow, and when it touches the council fire, it is the light.</p>
<p>Any Value</p>	<p>OTHER IDEAS</p> <p>Awards could be hung on a growth chart, pulled off and presented to the boys.</p> <p>Awards could be taped onto a BSA advancement chart.</p> <p>Awards could be drawn out of a magician's hat or out of a racer's helmet, a witches' hat, lots of pockets, a tool belt, an apron, artist' smock, anything...</p>

TIPS FOR CEREMONIES

Ceremonies are an important part of Cub Scouting because they bring **recognition** to a Cub Scout for his accomplishments. He feels important, and he feels the work he has done toward his advancements and awards is important too. Ceremonies should be positive and should be a highlight to every boy's Scouting career. Use your resources - Ceremonies for Dens and Packs, the Den and Pack Meeting Resource Guide and this Pow Wow Book, contain ceremonies of all kinds. None of them are set in stone. If the ceremony seems too serious or too frivolous, look for or **adapt** a ceremony to meet your needs. What works in one pack may not necessarily work in another pack. Your first ceremony or even your 100th ceremony may not be perfect. Ask for help or delegate parts to other leaders. Just remember to **do your best**.

SPOTLIGHT THE BOY: If a ceremony doesn't end with the boy on cloud nine, you didn't choose the right ceremony. Don't choose ceremonies and then think of the boy. Put the boy's needs first.

APPROPRIATENESS: If the ceremony is outdoors. . . if the audience is large . . . if nine boys are receiving the award, not one . . . all affect which ceremonies will work and which ones won't.

COSTUMING: Appropriate, fun costuming adds to the pomp and circumstances of a ceremony.

REHEARSAL: Adults probably need one rehearsal. Boys absolutely need two or three run-throughs. Assign parts early so lines can be learned and there is adequate time for rehearsal.

STAGING: Design the setting. Will we stand or sit? Where will we stand or sit? If awards are to be given out, have them laid out on a table, labeled and easy for leaders to retrieve.

PROPS: A good prop will make a ceremony shine. Be sure it is sturdy and ready for use. There are some ideas for building ceremonial props throughout this section. Check with other leaders at Roundtable to see if they have any props you can borrow.

LIGHTING: A darkened room, or a campfire, or a spotlight can be very dramatic. Use lighting to control what the audience sees and focus attention on what's important.

SOUND: Unusual, appropriate sounds, from a tom-tom to a "Grand Pack Howl" can add a dramatic touch.

PUBLIC SPEAKING: Make sure people performing can be heard and are easy to understand. Use a microphone if necessary. Be sure speakers are

facing the audience so their voice goes to the audience, not the back of the stage or into the curtains.

AUDIENCE MUST SEE: Elevate boys if possible.

Make sure the audience sees the star of the show!

INSPIRATION AND IDEALS: Help the participants and audience understand the Spirit of Cub Scouting and the theme by your preparation of the ceremony.

INVOLVING PARENTS: Most parents are happy to support their son on stage, but may not appreciate doing more than that. Ask them first.

ACTION: Use as many people as possible. Encourage them to move about by having them use ceremonial props.

ADVENTURE: Relate the ceremony to the theme of the month, if possible. Have the participants identified with the theme through action, narration and costume.

DELEGATION: Don't try to do everything yourself. Rely on others to help, but be sure to have a handle on the entire planning.

IMAGINATION: Get showmanship into the act. If the Cubmaster doesn't have a flair for the dramatic, rely on someone else to produce the ceremonies.

SYMBOLISM: The proper use of props can provide symbols of deeper meaning and values you want to instill. A lighted candle can represent the ideal, an individual, the light of Cub Scouting, etc. A paper chain can represent unity and strength. Twelve beads can represent the twelve achievements.

SIMPLICITY: Keep it simple, make it fun

CEREMONY PROPS

The right props for your ceremony can really make a big difference. A campfire (even a fake one) can be a great addition to many ceremonies. Here are a few ideas:

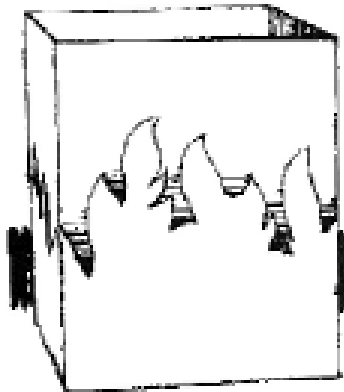
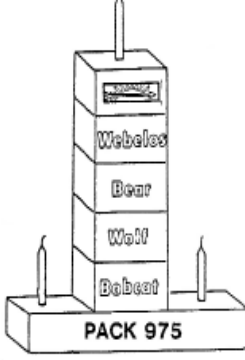
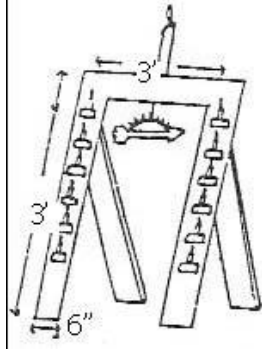
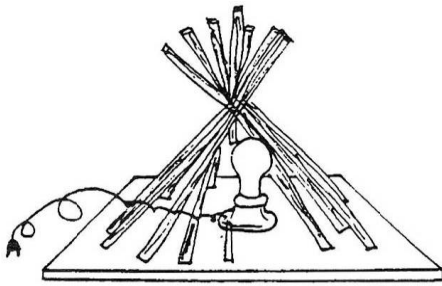
<p>SIMPLE CEREMONIAL FIRE</p> <p>Cover a large cardboard box with red or orange paper as shown. Place a blinking flashlight or Christmas lights inside the box. You can cut the box off around the flame patterns or place slits in the box so lights can be seen. You can also pile logs around the box "fire" to give it a more authentic campfire look.</p> 	<p>PACK TOTEM</p> <p>8- 2 quart milk cartons 5 small flashlights 3 candles x-acto knife glue flat black paint</p> <p>Cut out ranks in the cartons and glue together as shown. Cut out back of cartons to insert flashlights. Paint totem flat black so it will remain almost invisible. The candles on the side represent the Cub Scout Promise and the Law of the Pack. The candle on top represents the spirit of Scouting.</p> 
<p>See the Cub Scout Leader How To Book for more ideas and instructions for Ceremony Props, Advancement Boards, Den doodles and more.</p>	<p>This ceremony board is made from 1 x 6 inch lumber 3 foot across the top and 3 foot high. Two inch squares are mounted to hold candles, or can be used to hold boys' names or rank emblems. Legs are hinged for easy storage.</p> <p>Ceremony Equipment (</p> 
<p>TEEPEE FIRE</p> <p>Use 1" x 16" square for the base. Fire layout is from small branches in teepee-style.</p> <p>Use electric light inside.</p> 	

Here are some ideas for advancement boards and other ceremonial props.

ADVANCEMENT BOARDS



BRIDGES

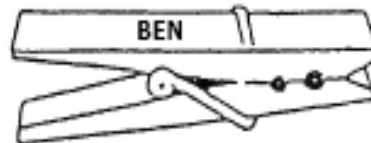
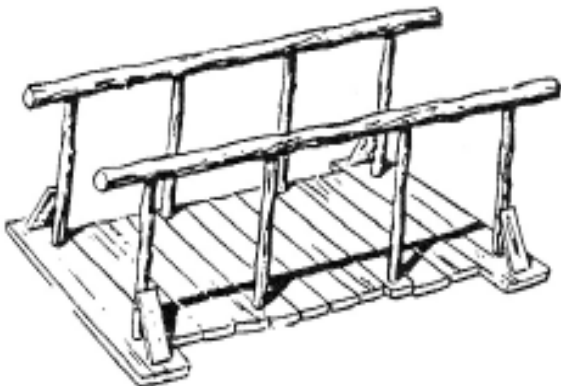

ARROW OF LIGHT

Materials:

- 1" x 16" x 18" piece of wood for base
- 1" x 7" piece of wood for arrow
- Stands from 1" x 3" piece of wood 3" long
- 3 - 2" squares 1" thick of wood for candles

Drill holes in bottom of board for candles

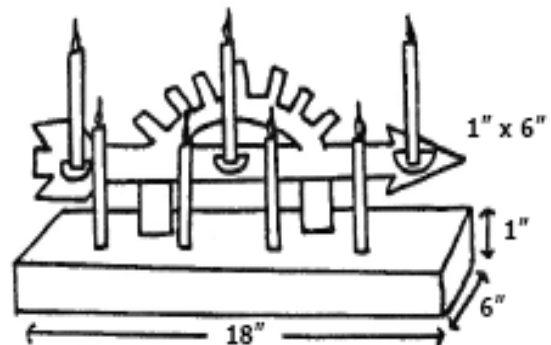
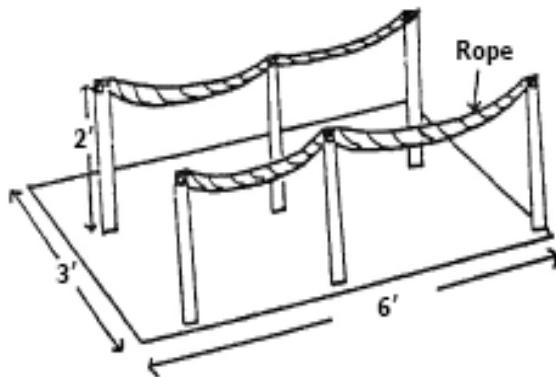

Log Cabin Fire Materials:

- Birch logs
- A few wood dowels -8" dia.,
- cardboard carton
- 3/4" x 7-3/4" dia. wood disc
- A surface electrical outlet
- 10' of lamp cord and plug
- 2-1/2" and 3" finishing nails
- Aluminum foil
- Light bulb

1. Log lengths and diameters are not critical but the pile should taper in thickness and length.

Build the fire so logs can be dismantled for storage. The bottom four layers are doweled together. The top three layers are nailed together with finishing nails. The shingles used for the tinder effect are not fastened in place permanently but are placed teepee-style around the container.

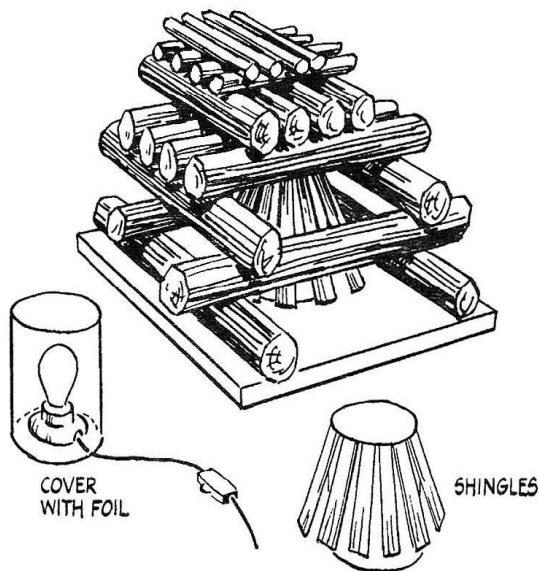
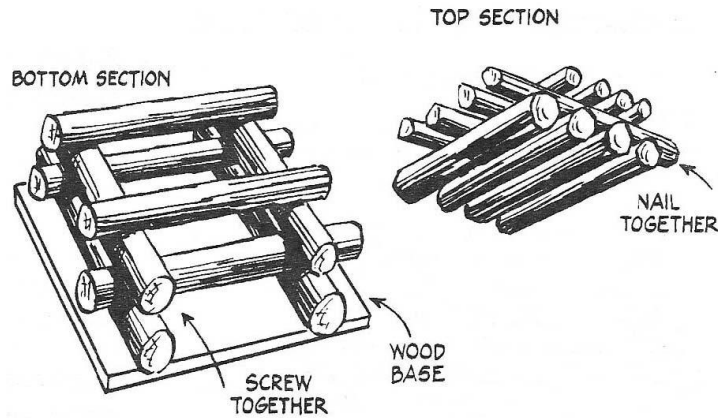

2. Assemble and wire the lamp base. Insert it in the cardboard carton which has been covered with aluminum foil.

3. Build the log pile, doweling the joints. To locate dowel centers, drive a small brad in the lower log, then press the upper log over the brad to mark the center, and then bore holes.

4. Use a 60-100 watt red or orange bulb for illumination (a white bulb can be painted). The light will filter through the slots in the shingles. Blinking Christmas lights will give a flickering effect.

CANDLES – Many Ceremonies call for candles. Often the churches and schools and other buildings that we meet in do not allow us to use/light candles (be sure to check). Try using battery operated candles, flashlights or light bulbs.

When you do have an outdoor meeting, take this opportunity to try one of the ceremonies with real candles if you can. A real fire can make a big difference too.

STORAGE – When building or buying ceremony props, consider the space it will take to store them between uses. Who will store it? Where will it be stored? How easy/hard will it be to get when we need to use it? And make sure that multiple people know about it so it doesn't get forgotten or lost.

Cub Scout

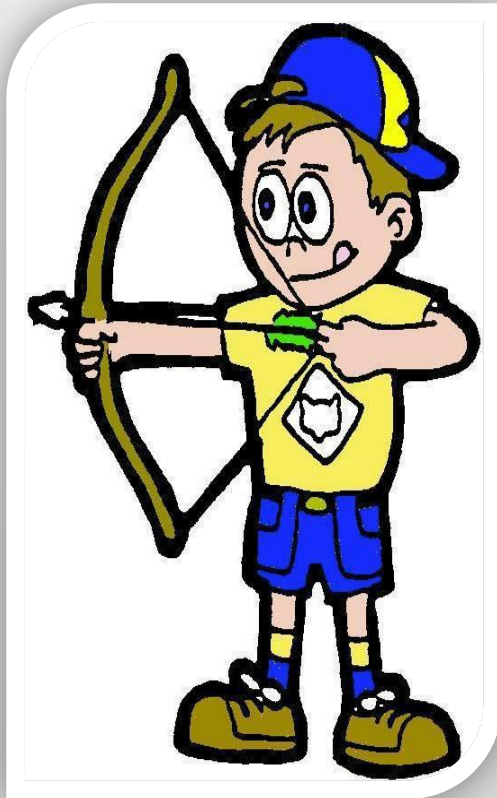

(Archery done at Day camps ONLY)



Games and Activities

Games and activities are one of the fun elements of Cub Scouting - Fun with a Purpose. Cub Scout age boys love to run, jump, throw, kick, bend, crawl, yell, balance and hide. All these actions help develop skill and coordination. Games can also help them develop quick thinking, mental alertness, and strategy. Some of the games in this section have a very specific purpose or learning objective and some are just for fun.

**Any Value
Depends on the
props, and such.**

RELAY GAMES

(Sam Houston Area Council)

Over the Top - Play with a medicine ball or basketball. Boys stand in line in straddle position. Ball passed overhead from boy to boy. Last boy receiving ball vaults over the line as they stand in stooped position. Others continue until first boy finishes.

Through the Tunnel - Boys in same position. Ball is passed between legs and last boy crawls through, pushing ball ahead with head and hands. Others continue.

Over and Under - Same formation except the balls are alternately passed overhead and between the legs. Last boy vaults over one and crawls between legs of next boy. Others continue.

In and Out - - Ball is passed between legs and overhead. Last boy runs in and out through the line and others continue.

Kangaroo - Ball is passed through line between legs. Last boy tucks ball between knees, jumping on side of line to front, and others continue.

Goat - - Same as above, except that last boy butts ball alongside of line with head, not being allowed to use hands.

Leap Frog Race - Players stand in stoop stand position as first boy straddle vaults over backs, when he gets down to the end of the line and second boy begins to leap frog jump over line, so continuing until all boys have had their turn jumping over backs of others.

Skin the Snake - All boys in line stoop over, grasping the left hand of player with his right between legs. Last boy lies down. Line continues backing until all are lying. Return to starting position, all standing. (This should be executed as quickly as possible.)

Checker Relay - You will need: 6 wooden checkers playing pieces per den. Scouts race up and down the hall in relay fashion, with a pile of 6 checkers balanced on the back of one hand. They are not allowed to steady the pile with the other hand. The only time they can touch the checkers with the other hand, is either when they have dropped them and are picking them up, or when they are transferring the checkers to another Scout in their team.

Crawling Race - Each Scout crawls to a turning line 30 feet away and returns similarly. Crawling must be on hands and knees; a contestant may not rise to the toe to propel himself.

RELAY GAMES – Continued

Clothespin Relay - Divide into teams. Each team member must run from the starting line to a team bottle placed a distance away, attempt to drop a wooden clothes pin into the bottle (Each boy has only one attempt to get the clothes pin in the bottle) and run back to tag the next team member, who then repeats the action. The rules are to hold the clothespin with a straight arm at shoulder height or with a bent arm at waist height (as long as all do it the same way). When all the teams are done, the team with the most clothespins in their bottle wins the game.

Cotton Ball Race - - Each person has to pick up a cotton ball with a spatula, keeping it balanced while running to a specified goal and back. If the cotton ball is dropped, the player must start over. When he returns with the cotton ball, he places it in a carton.

Driving the Pigs to Market - The first person in line receives a wand (stick, yardstick, or broom handle) and a pig (soda bottle or egg). On signal the player drives the pig to market and back pushing the pig with his wand.

Eskimo Race - Each contestant advances, holding the feet together and knees stiff, by quick toe springs. The turning line is about 30 feet distant.

Fifty Yard Swim - Each boy hops on one foot carrying a paper cup of water. First one over the finish line wins. (Could also be done as a relay.)

Bottle Fill Relay - Fill a large pop or milk bottle that is held on a player's forehead with a non-bendable cup filled with water.

2 Ball Hockey Game - You will need: 2 hockey sticks, 2 balls or sponge pucks, 4 chairs, 6 skittles or liquid dishwashing soap squeeze bottles. Two equal sized numbered teams on each side of the hall. Two chairs at each end for a goal, with a hockey stick and puck in each goal's mouth. A line of skittles between each goal mouth. When a number is called, the two Scouts with that number race to their goal mouth, pick up the stick and then dribble the puck between the skittles slalom fashion until they reach the end of the line where they can shoot at the opposing teams goal.

Animal Relay - The players progress to the goal and back in the way animals walk. Have them vary. Some variations may be: 1) Donkey's walk: traveling on all fours to the goal and imitating the donkey's bray, 2) Duck walk: walking on two feet in squat position squawking without stopping, 3) crab walk: walking on hands and feet with back towards the floor.

Barefoot Marble - Divide the Scouts into teams. First boy runs to a line 15 ft. away. He grasps and carries one marble with the toes of each foot, returns to tag the next Scout.

Bat round relay - Each player runs to the other end of the field of play, puts their head to the bat (held vertically by the leader), runs around the bat 10 times in that position, and then must return to his team without falling down.

Perseverance Resourcefulness Respect	WILDERNESS SURVIVAL This game shows how animals in the wild that are weaker or slower will lose to those who are stronger. Each player needs a three-inch bolt with two nuts screwed onto it, and twenty pieces of candy. Let the boys challenge each other to a race. To start, the nuts must be screwed to the top of the bolt. On a signal, the boys must unscrew the nuts all the way until they come off the bolt. The boy who gets the nuts off first gets two pieces of the other Cubs candy.
Perseverance Positive Attitude Resourcefulness	PING-PONG BALL SHOOT OUT Fill several 2-liter bottles with water to weight them down. Place them on a flat surface. Put a Ping-Pong ball on top of each bottle. Have a contest to see how fast each Cub can shoot the ball off the bottle with a squirt gun.
Cooperation Health and Fitness Perseverance Positive Attitude Resourcefulness	RECYCLED LID FRISBEE TOSS Collect a variety of plastic lids from containers such as margarine tubs, yogurt containers, shortening cans, etc. With a permanent marker, mark half the lids with the letter "C" for Cubs and the other half with the letter "S" for Scouts. Divide the group into two teams, the "Cubs" and the "Scouts." Give each team the appropriate set of lids. Using tape or string, mark two target circles about 15 feet away from the base line. Each team must stand behind the base line and sail their lid, Frisbee-style, into their target. A point is awarded for each lid that lands in the target. A point is taken away if a lid lands in the other team's target.
Cooperation Honesty Perseverance Resourcefulness Respect	SHAMROCK STOMP <small>(this can also be done with any other shape)</small> You'll need: Irish jig music and large green shamrocks, one for every child, taped to the floor. This is a variation of Musical Chairs. Every child begins by standing on a shamrock that has been taped to the floor. When the music starts, the children must walk (or dance) around the room. When the music stops, the children must be standing on a shamrock or they're out. Remove one shamrock each time the music plays.
Health and Fitness Perseverance Resourcefulness	ORANGE PEEL AND EAT Boys pick an orange from a pile. The first to peel and eat their orange wins.

<p>BROOM SWEEP RELAY</p> <p>Supplies for each team: 1 broom 1 balloon (inflated) 1 plastic cone</p> <p>Divide your den or pack into equal teams. Line up each team behind a starting line. Place a plastic cone about 40 feet from the starting line for each team. Give the first person in each team a broom and an inflated balloon.</p> <p>On the start signal, the first person in each team puts the balloon on the floor and proceeds to sweep the balloon to the cone. He circles the cone and continues sweeping the balloon back to his teammates. He hands the broom to the next teammate and walks to the end of the line. The next player sweeps the balloon to the cone, circles it and sweeps back to his team. The balloon is to remain on the ground at all times. If the balloon pops, the player must restart from the starting line. The first team to have all players complete the clean sweep with the balloon is declared the winner. Have extra balloons (inflated) on hand in case one should pop. This game can also be played outdoors - fill the balloons with water for some wild fun.</p>	<p>Cooperation Health and Fitness Perseverance Resourcefulness</p>
<p>HOUSE A-FIRE RELAY</p> <p>Equipment: Bucket of water, spoon, and a red cup (one for each team)</p> <p>Starting at the bucket, get a spoon of water and run to the red cup. Fill it one spoon at a time by one person at a time. First team to fill their cup wins.</p>	<p>Cooperation Courage Honesty Perseverance Resourcefulness Responsibility</p>
<p>COUNT YOUR BLESSINGS</p> <p>Boys sit in a circle. The first boy starts out by saying "I am grateful for apples" or something beginning with the letter A. The next boy is grateful for something starting with the letter B. Continue around the circle and through the alphabet. If a boy fails to think of a word beginning with the proper letter, he drops out. The one remaining in the circle the longest is the winner.</p> <p>Variation: The first boy says "I am grateful for apples" then the second boy says "I am grateful for baseballs and apples." The third boy says "I am grateful for cookies, baseballs and apples." Each boy must add his word starting with the next letter then repeat the words already said in descending order.</p>	<p>Faith Honesty Positive Attitude Resourcefulness Respect</p>

Cooperation Courage Resourcefulness Responsibility Respect	<p>LEAN-TOO</p> <p>This is a good game for pack meeting to get parents involved. The boys and parents stand in a circle by dens holding hands. Everyone numbers off alternately one or two. On the signal, keeping legs and backs as straight as possible, the players who are "ones" lean forward toward the center of the circle, while the "twos" lean outward. Players counterbalance each other for support. Once the group has gotten its balance, slowly reverse the leaners. Then have the players see how smoothly they can alternate.</p>
Cooperation Honesty Perseverance Positive Attitude Resourcefulness Respect	<p>PASS THE PARCEL (Great for Christmas Time)</p> <p>This is a traditional game from England. Before the party, place enough treats (candy, chocolate kisses, erasers, etc.) for all of the guests in a small box and wrap it. Place the parcel into a bigger box and wrap that as well. Then again and again until there are several layers of wrapping.</p> <p>To play the game, everyone sits in a circle. Play music while passing the "parcel" around from player to player. When the music stops, the player holding the parcel unwraps one layer. Then, play the music and begin passing again. Continue to play until the last layer is unwrapped and the treats are handed out.</p> <p>TIP: We've found it easier to have the players only partially unwrap the box during their turn. That way every player is sure to get a turn. We also use a few boxes but several layers of paper.</p> <p><u>Variations</u> UNWRAP THE PRIZE You will need a small gift, wrapped in 8-10 layers of wrapping paper and oven mitts. This game is like Hot Potato, but you want to be left holding the present. The boys pass the gift while the music plays. When the music stops, the boy holding the gift gets to unwrap one layer, but he has to wear oven mitts while doing it. The winner is the one who unwraps the actual gift.</p>
Cooperation Honesty Perseverance Resourcefulness	<p>EAT AND WHISTLE</p> <p>Players are divided into two teams and each person is given a cracker. At the signal, the first player on each team starts eating his cracker. He must finish it and whistle before the next player in line can start eating. The first team to finish, wins.</p>
Cooperation Perseverance Positive Attitude	<p>POTATO RACE</p> <p>Each team member tosses the potato into the air and catches it on the fork, takes it off, and hands them to the next player.</p>

<p>NOSE-CONE RACES</p> <p>Divide the den into teams. For each team, stretch a 15 foot length of string between two chairs. Before tying to the second chair, insert a paper cone cup with the tip cut off onto the string. Each boy on a team blows the cup the length of the string and returns it. Continue in relay fashion until all have raced.</p>	<p>Cooperation Courage Health and Fitness Honesty Perseverance Respect</p>
<p>WHAT IS IT?</p> <p>Put different items, one at a time, in a paper bag or a pillow case. Each boy reaches into the bag and tries to identify the item inside by feeling its shape. If the boys are quite knowledgeable, more exact names should be required and less common items can be used.</p>	<p>Any Value <i>depending on what you put in the bags.</i></p>
<p>TOOTHPICK PICK-UP</p> <p>Dump a pile of cocktail toothpicks on the table. Each player tries to pick up five toothpicks using the two corresponding fingers from each hand: right thumb and left thumb, right index and left index, etc.</p>	<p>Honesty Perseverance Positive Attitude Resourcefulness</p>
<p>PASS IT ALONG</p> <p>Collect odd objects and place them on a tray. Make a duplicate set for each relay team. Have the boys sit in a line (on chairs or the floor). Make a written list for each team that indicates the order of items to be passed. On "go" each team passes back the requested item, one boy to the next. When the item reaches the back, the last boy calls "more" at which time, the first boy starts the next item on its way. Continue until all the items have been passed.</p>	<p>Any Value <i>depending on what you use on the tray</i></p>
<p>WHO BLEW?</p> <p>Players line up in a straight line. "It" stands at the front of the line with his back to the others. One of the players in the line suddenly whistles or blows a note on a harmonica. He quickly puts his hands behind his back (if he has the harmonica), while "It" spins around to see who made the noise. If "It" guesses wrong, he turns around and play begins again. If "It" guesses correctly, he changes places with the boy who he caught in the act.</p>	<p>Cooperation Honesty Resourcefulness Responsibility</p>
<p>WHEEL ROLLING</p> <p>See who can roll a wheel the farthest across the parking lot.</p>	<p>Health and Fitness</p>

<p>Any Value depending on the pictures you use.</p>	<p>PICTURE PIECES</p> <p>You will need at least one full color picture from a magazine for each player. Cut each picture into five pieces. Keep one and stick the remaining four pieces of each picture at random around the walls with blue tack or tape. Give each person one of the reserved pieces and tell them to go and find the other four pieces. This isn't as easy as it sounds.</p> <p>You can play this game in two ways: 1. The first person with a complete picture, correctly fitted together, wins. 2. As people complete their picture, give them another piece. The person with the greatest number of complete pictures -- when you blow the whistle -- wins. You will need to cut up a lot more pictures than you have players.</p>
<p>Cooperation Courage Health and Fitness Honesty Perseverance Positive Attitude Resourcefulness Respect</p>	<p>IT'S A BLAST</p> <p>Players scatter around the room.</p> <p>The leader blows a number of short blasts on a whistle. If there are four blasts, all players try to get into groups of four before the leader counts to ten. Players left out of the groups are eliminated. The leader continues to whistle different number of blasts. The game ends when only two players are left.</p>
<p>Cooperation Perseverance Resourcefulness</p>	<p>HATS AWAY</p> <p>The players form a standing circle. Give each a hat to place on his head (the funnier the hat the better). Tell the players to place their right hands behind them. On the command "ready, change!" each player grabs the hat from the one at his right (with his left hand, mind you) and places it on his own head. Repeat the command and just when the group gets fairly good at it, change hands, or have them take the hat from the player at the left, or put the hat from their own head on the neighboring players head.</p>
<p>Courage Cooperation Perseverance Positive Attitude Resourcefulness Respect Responsibility</p>	<p>TRASH TO TREASURE CROQUET</p> <p>Add an easy, yet unexpected, event to your celebration by playing Trash to Treasure Croquet. You'll need croquet mallets and balls, but skip the standard wire wickets. Instead, look for household items and recyclables that a croquet ball could pass under or through, such as an oatmeal container with the top and bottom removed, a cereal box with a hole cut on each side to make a tunnel, a child's plastic chair, or a laundry detergent bottle with an arch cut from the bottom. Set up a course that circles the yard and uses at least a dozen creative wickets, including one brave parent with his or her feet spread wide.</p>

<p>FLAG RACE</p> <p>ITEMS NEEDED: 8 - 9" x 2" strips of red paper 6 - 9" x 2" strips of white paper 6 -18" x 2" strips of red paper 6 -18" x 2" strips of white paper 2 - 14" x 9" rectangles of blue paper 100 white stars (50 need to fit on blue paper)</p> <p>Divide into two teams. On signal, each team tries to assemble their paper flag before the other team. Variation: Do individual time trials. The boy with the fastest time overall wins.</p>	<p>Citizenship Cooperation Positive Attitude Respect Responsibility</p>
<p>THE GREAT FOOT FREEZE</p> <p>Fill a child's plastic wading pool with water, then add lots of ice cubes. Supply each Cub with a plastic bowl. (All bowls should be roughly equal in size.) Players sit around the edge of the pool with their feet poised over the water. At Go!, they race to move ice cubes out of the water and into their bowls within a designated time period. The catch is, they can only use their feet. The winner - by a foot, of course - is the person who has the most ice cubes in his bowl when the time is up.</p>	<p>Compassion Courage Health and Fitness Perseverance Resourcefulness</p>
<p>SKIN THE SNAKE From Games Games Games</p> <p>Divide the group into two teams.</p> <p>Each team lines up single file. At the signal to start, each person reaches backward between his legs with his right hand and reaches forward with his left hand to clasp the right hand of the person in front of him. The person at the front of the line only has to reach backward. Everyone else should be clasping hands forward with his left and under and backward with his right, forming one long snake.</p> <p>No one may let go of hands throughout the following steps. The person at the end of the line lies down on the floor, pointing his feet up the line between everyone's feet. The entire line starts to walk slowly over the top of the end person. After the second-to last person has passed over the last person, he also lies down, and lets the line continue walking over him. As soon as a person passes the last person lying down, he lies down too. When the last person lies down, the "snake" is "skinned". The last person to lie down now gets up, and the process is reversed. The line walks slowly forward, hands still joined, pulling up the people on the end one at a time.</p> <p>The first team to complete the two parts is the champion snake skinner.</p>	<p>Cooperation Courage Perseverance Respect</p>

Citizenship Cooperation Courage Honesty Perseverance Resourcefulness Responsibility	WOLF DEN adapted from Games Games Games Draw a large circle on the ground fifteen to twenty feet across. This is the den. Pick someone to be the head wolf and stay inside the den. The other players taunt the head wolf by daringly stepping into the den. If the head wolf bites (tags) someone who is completely or partially in the den, then he also becomes a wolf and helps the first wolf catch others. The last person caught becomes the head wolf for the next round of play.
Compassion Honesty Perseverance Resourcefulness	LIONS AND TIGERS AND BEARS Blow up several yellow, orange and brown balloons. Put all of the balloons on the floor. Have Cubs separate the lions (yellow balloons), from the tigers (orange balloons), from the bears (brown balloons) by putting each "animal" in a separate corner. Try it using hands, using feet only, or blowing on the balloon.
Health and Fitness Perseverance Resourcefulness	ELEPHANT SOCCER Cubs get into a circle with legs wide apart and their hands down in front of them with hands clasped together for trunks. Roll a ball across the circle trying to get it between someone's legs. Use only trunks to keep the ball from going through legs.
Health and Fitness Positive Attitude	KANGAROO RACE Cubs pretend they are kangaroos with pouches. Give each Cub a bean bag to use as a pouch. After dividing into two teams, Cubs race each other across the floor on hands and feet with stomachs in the air (also known as a crab walk) with "pouches" perched on their stomachs. If the pouch falls off, the boy must put it back on before continuing.
Cooperation Positive Attitude	OCTOPUS RACE Divide the den into two teams of three or four boys each. Team members line up back to back with elbows linked. On signal they race to a turning line and back.
Courage Perseverance	KNOT-TYING CHALLENGE Scouts to tie knots using bits of rope or from licorice laces. Bonus: it's both a snack and a game.

<p>DESTINATIONS</p> <p>You will need a rolled-up section of newspaper, and chairs.</p> <p>To play, place the chairs in a circle, facing the center. Assign one person to be "it." "It" stands in the center of the circle. Give each player an opportunity to name a destination they would like to sail to. Do not duplicate destinations. After each player has stated his destination, "It" calls out one of the destinations.</p> <p>That player stands up, yells out another player's destination as quickly as he can, and sits down before "it" whacks him on the knee with the newspaper. (Note: It is VERY important to stress that players may only be softly whacked on the knee. No other body part may be whacked, and no hard hitting is allowed. Don't be afraid to stop the game if these rules are not followed.)</p> <p>If "it" whacks before the player yells another player's destination, then "it" takes a seat, and the person who was whacked becomes "it." If the player responds correctly and sits back down before "it" whacks him, then play continues with the new person whose destination was yelled trying to avoid being whacked by yelling another person's destination. If a destination is called that is not in the game, or if a player yells his own destination, then he is "it." Play continues as long as everyone is still having fun.</p>	<p>Compassion Cooperation Courage Health and Fitness Honesty Perseverance Positive Attitude Resourcefulness Respect</p>
<p>GET YOUR HEADS TOGETHER</p> <p>Supplies: paper cup for each pair of boys.</p> <p>Preparation: Divide the players into relay teams, paired according to height. A paper cup is given to each pair of players. The object of the game is to hold the paper cup between the player's heads without the use of hands and move the preselected distance to the finish line. The distance is selected according to the size and coordination of the players. Once one pair has crossed the finish line, the next set goes. Play continues until all of the teams have crossed the finish line. If the cup is dropped or touched by the player's hands, the players must return to the starting line and try again.</p>	<p>Cooperation Positive Attitude Resourcefulness</p>
<p>TABLETOP HOCKEY</p> <p>Cut a plastic berry basket in half. Invert one half and set it at one end of a table. Cubs can line up at the opposite end and try to score by flicking button pucks into the net.</p>	<p>Health and Fitness Perseverance Resourcefulness</p>

Compassion Cooperation Perseverance Positive Attitude	CIRCLE CATCH Supplies: Several balls or beanbags, appropriate for boys age and abilities. Boys stand in a circle facing inwards, about arm's length apart. The leader stands outside the circle and throws a ball to one of the boys who then throws it to another in the circle. When the ball is being passed back and forth across the circle, the leader throws in a second ball, then a third and so on. The object is to see how many balls the group can handle without it turning into utter chaos.
Health and Fitness Perseverance Positive Attitude Resourcefulness	SOCCER GOLF Set up a golf course around a yard or field using empty trash cans, traffic cones, boxes and other targets. Just as in real golf, players must try to kick the ball to each hole in the lowest number of shots.
Honesty Perseverance Resourcefulness	BUCKET BOUNCE Place an empty bucket in the center of the room. Each boy gets five tries to bounce the ball into the bucket from a spot six feet away. Ball must stay in the bucket. Repeat if time allows.
Cooperation Health and Fitness Perseverance Positive Attitude	JUMP ROPE GAMES Practice jump roping first. Relay - Use one rope for each team. Run and jump down to a line and back, handing the rope to next player. Variations: Jump backward; run to line, jump 10 times and then run back; see how long you can jump; jump 2 boys in rope at the same time.
Cooperation Perseverance Resourcefulness	FOOTPRINTS RELAY Using heavy cardboard, cut out footprints 15" long and 8" wide. Two footprints are needed per person or team. Play game as a physical skill (let's see if you can do it) or as a competition (2 or 3 teams as a relay race at a set distance). Place both footprints one in front of the other. Step on the first with one foot and on the second with the other foot. Now lift rear foot. Pick up footprint and move it ahead. Move lifted foot into new position. Do the same with the other foot and continue, step by step, to the finish line.

<p>EGG RACE</p> <p>Line up the dens for a relay race. Have the contestants carry an egg in a teaspoon held with the arm extended. The first in each line runs 20 yards and back to the next one in line.</p>	<p>Cooperation Courage Perseverance Resourcefulness</p>
<p>WHAT'S IN THE BAG?</p> <p>Fill the pillowcase with assorted sports items (golf ball, tennis ball, Frisbee, tennis racket, baseball glove, etc.). Using a timer, allow each person 15 seconds to reach inside and feel what is in the pillowcase. Each person then writes down as many of the items that he can identify and remember. Remind players to be specific, don't just write "ball," but write "golf ball" or "basketball." Suggest they not share their findings with other players. The person with the most right wins a small prize.</p> <p>Variation: Fill the pillow case with different fruits and vegetables (ones that are not too squishy). Or fill it with game pieces (dice, domino, cards, marker, chess piece, checker, spinner, etc...) Fill it with stuff from nature (rock, bark, twig, leaf, etc...)</p>	<p>Honesty Perseverance Positive Attitude Resourcefulness Respect</p>
<p>SPORTS MIX-UPS</p> <p>Make 12 sets of sports cards using the words listed below. Write each word on a different color of paper, then cut out each letter. Mix up the letters to a word, then place them in a baggie. Divide the boys into small groups, and give each group a sports card baggie. On a signal, each group is to open their baggie and unscramble the letters to reveal what the sport is. All members of the group shout out the name of the sport (or, ask each team to be silent until they have spelled out their word). The winning group gets a small prize.</p> <p>*Badminton *Bowling *Cricket Volleyball *Table Tennis *Swimming *Softball *Gymnastics *Track and Field *Rugby *Baseball *Hockey</p> <p>Variation: Make two sets of cards. Give each group the same word and see who can unscramble it first. Give points for the correct answer and award a small prize to the group with the highest number of points.</p>	<p>Cooperation Honesty Perseverance Resourcefulness</p>
<p>MOVING TARGET</p> <p>Have the contestants throw beanbags, sticks, stones, or anything for that matter, through a rolling hoop.</p>	<p>Perseverance Resourcefulness</p>

<p>Any Value</p>	<p>C.U.B.S. (The MacScouter's Big Book of Games --Volume 1, for Younger Scouts; p. 23, 1997) Equipment: 1 beanbag</p> <p>The Cubs sit in a circle with the beanbag in the center and the leader gives each a letter C, U, B or S all the way around the circle. The leader calls out one of the letters and all the Cubs with that letter run around the outside of the circle and back through their places into the center where they try to snatch the beanbag. The Cub who get the bag is the winner.</p>
<p>Compassion Honesty Perseverance Positive Attitude</p>	<p>PACKAGE (Good at Christmas time) (York Adams Area Council, Baloo's Bugle Nov. 2002)</p> <p>Begin by saying that Uncle Henry cannot come home for the holidays and his gift must be mailed. Have the Cubs form a circle and place their hands behind them. With eyes blindfolded, pass the articles needed to mail the package around the circle. Begin with the gift (gloves or tie) and then the box, wrapping paper, ribbon, mailing paper, string, sticky tape, mailing label and stamp. After all things have been passed around, put them away. The boys are un-blindfolded and asked to write down all the things they remember that they felt. The one remembering the most is the winner.</p>
<p>Compassion Respect</p>	<p>PRESENTS (SHAC, Baloo's Bugle Nov. 2002)</p> <p>Each boy thinks of a present he would like to give a make-believe friend (or a real friend) and then decides how to act out movements for his chosen present. (For example, if he chose a dog, he could chase his tail around in a circle, give a paw to "shake", or roll over with paws up in the air.) There are no limits on the price, or availability of this pretend present. The leader should consult with each boy as needed to choose a present and work out the movements. When all the boys have decided on the presents and movements, have each in turn act out his present and see who can guess what it is.</p>
<p>Cooperation Perseverance Resourcefulness</p>	<p>STICK RELAY</p> <p>Have the relay runners roll lemons or hard-boiled eggs with a stick down the course and back and touch off the next player in line.</p>
<p>Citizenship Perseverance Positive Attitude Resourcefulness Respect</p>	<p>OLD FASHION GAMES</p> <p>Teach the boys to play jacks, kick the can or hopscotch.</p> <p>A good old fashion game of kick ball especially children --vs- adults is fun too.</p>

<p>TREE DECORATING (York Adams Area Council, Baloo's Bugle Nov. 2002)</p> <p>Players are seated in rows with an equal number in each row. They are numbered consecutively from front to back and each No. 1 is given a piece of chalk. On signal, No. 1 players run to a blackboard or poster board and draw the base for a Christmas tree. They return to their seats and hand the chalk or crayon to the No. 2 player, who must draw the branches. No. 3 draws the candles. No. 4, certain number of ornaments. No. 5, add star to top of the tree. No. 6, write Merry Christmas under the tree. Team to complete their picture first wins.</p> <p>Variation – You could do this with other simple object/pictures that relate to another Core Value.</p>	<p>Cooperation Faith Positive Attitude Responsibility</p>
<p>DOMINO</p> <p>This is a game that is as fun to watch, as it is to play. It's also easy to play and requires no props.</p> <p>Teams line up in single-file lines parallel to each other. The lines should have the same number of people, and everyone should be facing toward the front of the line. At a signal, the first person in each line squats, and then each person in turn squats, all the way to the end of the team's line. (You cannot squat until the person immediately in front of you squats first.) The last person in line squats and then quickly stands up again. Then, in reverse, each person stands up in the line. The first team with the person standing at the front of the line is the winner.</p> <p>This game works best with at least twenty people in each line (the more the better). Have the teams try it several times for speed.</p>	<p>Cooperation Honesty Perseverance Positive Attitude Responsibility</p>
<p>NECKERCHIEF RELAY (Greater St. Louis Area Council, Baloo's Bugle July 2005)</p> <p>Boys line up in relay formation. The first Cub Scout in each line holds a neckerchief and a neckerchief slide in his hands. At the other end of the room opposite each line is another boy or parent. At the starting signal, the first boy runs to the boy or parent, places the neckerchief around their neck, puts the slide on, salutes, takes the slide off, removes the neckerchief, and returns to his team. He then gives the neckerchief and slide to the next boy in line who repeats the process. This continues until each boy has had his turn.</p>	<p>Citizenship Respect Responsibility</p>

<p>Cooperation Courage Honesty Perseverance Resourcefulness Respect Responsibility</p>	<p>ARCHAEOLOGY DIG</p> <p>Cub Scouts love the thrill of the hunt. This is an activity they will really enjoy. Fill a large box, a wheelbarrow, or a small wading pool with damp sand or sawdust. Mix in a bag of small plastic dinosaurs, and possibly a handful of change (it keeps it interesting). Pat the sand or sawdust down tight and let it dry overnight. When the boys come let them have a miniature dig with paintbrushes and toothpicks. The idea is to not disturb any item until after that item has been catalogued by the den leaders.</p>
<p>Courage Faith Honesty Perseverance Resourcefulness</p>	<p>STEAL THE PINE CONE</p> <p>The object of this game is to steal a pine cone without being caught. Choose one boy to guard the cone. He is blindfolded and sits down cross-legged behind, but not touching, the cone. Other players sit quietly about 10 feet away opposite the cone guard. They take turns, one at a time, sneaking up to the cone. When the cone guard hears someone sneaking up to the cone, the guard must point toward the noise heard. If the guard points directly at the approaching player, then that player is out. The player who succeeds in stealing the cone becomes the next cone guard.</p> <p>Variation: Instead of taking the cone away, try placing the cone in front of the blindfolded person without being caught.</p>
<p>Faith Honesty Respect Responsibility</p>	<p>COMPASS POINTS <small>(From "Scouting Games", Sir Robert Baden-Powell)</small></p> <p>With a piece of chalk, draw eight lines, intersecting in "star" fashion, all radiating from the center, to indicate the points of the compass. One line should point due north. One Scout now takes up his position at the outer end of each line to represent one of the eight principal points of the compass. The leader now calls out any two points, such as SE and N. The two Scouts at those points must immediately change places. Anyone moving out of place without his point being named, or moving to a wrong place, should lose a point. When changing places, Scouts must not cross the lines, but must go outside the circle of players. When a Scout loses three points, he is out.</p> <p>Variation: You could make the points of the compass different core values always making sure that Faith is North. Being the thing that guides us. Shout out different values and have the boys change as above.</p>

<p>EARTH, WATER, AIR and FIRE (York Adams Area Council, Baloo's Bugle May 2002)</p> <p>Equipment: 1 bean bag</p> <p>The boys sit in a circle with one Cub in the center holding the bean bag. He throws the bag at someone and shouts "Earth", "Water", "Air" or "Fire". If it is "Earth", the chosen Cub must reply with the name of an animal before the center Cub counts to ten. If it is "Water", he must think of a fish, if "Air", then a bird and if "Fire" a whistle for the Fire Engine. Once a creature has been named, it may not be called again. If the Cub cannot reply in time, he changes places with the thrower.</p>	<p>Cooperation</p>
<p>BALLOON BALANCE</p> <p>Equipment: Per team: 1 big balloon; 1 small balloon.</p> <p>Divide the group into teams of six to eight players. Each team is given one large and one small balloon. The first player of each group, on the word 'Go', balances the smaller balloon on top of the larger one and races to the other end of the playing area. If the top balloon falls off, the player must return to the starting line and begin again. When the 'run' (or walk) is complete, the player takes both balloons in his hands and runs back to the starting line, where the second player is waiting to race. The first team finished, and sitting down, wins.</p>	<p>Health and Fitness Perseverance Resourcefulness</p>
<p>FISH RUN!</p> <p>Need: 1 beanbag or paper or sock ball</p> <p>One boy is selected to be the 'fish.' He may run freely about the room. The rest of the Cubs each choose a position and since they are "rocks in the sea," they may not move. The aim is to tag the 'fish' by hitting him with the ball. Whoever hits him, takes his place as the next 'fish.'</p> <p>The skill of the game lies in passing the beanbag from "rock to rock" in an endeavor to corner the 'fish,' rather than the Cubs taking random shots. This is good training in playing for the team rather than for the individual.</p> <p><i>Note - With all games where they are throwing something at someone else make sure the object is relatively soft and that they aim for chest or below.</i></p>	<p>Cooperation Courage Health and Fitness Perseverance Positive Attitude Resourcefulness</p>

<p>Honesty Positive Attitude Resourcefulness Respect</p>	<p>WHAT'S IN THE PICNIC BASKET? (Sam Houston Area Council, Baloo's Bugle July 2008)</p> <p>(Sit in a circle or around a picnic table. The game begins by imagining you have a very large picnic basket. The first player recites the sentence "I'm going on a picnic and I'm bringing _____." The first player must fill in the blank with an appropriate word that begins with the letter A, such as "apples" or "American cheese." The second player must repeat the sentence just as the first player said it and add an item that begins with B. For example, "I'm going on a picnic and I'm bringing apples and bread." The game continues around and around with each player repeating the complete list of items and then adding something with the next letter of the alphabet. As the list becomes longer, it is more difficult to remember. (If players agree beforehand, the letter X and other difficult letters like Q and Z, can be left off the list or the items for those letters can be chosen by the group.) If a player makes a mistake, he is "out." The winner is the last person left, providing he can repeat the whole basketful of items without a mistake.</p> <p>A simpler version of this game would not require alphabetizing. Instead, kids can pack the picnic basket with any appropriate item. When a player misses an item, the next player starts the list over.</p> <p>Players are out of the game after making 3 mistakes. The last player remaining is the winner.</p>
<p>Cooperation Courage Health and Fitness Positive Attitude</p>	<p>CIRCLE STRIDE BALL (Crossroads of America)</p> <p>Equipment: Volleyball or soccer ball.</p> <p>Have players form a circle with their feet spread apart comfortably and touching the feet of those around them. Have one Cub as the person who is "IT" standing in the center with the ball. The Cub tries to roll it between the legs of one of the Cubs in the circle.</p> <p>The Cubs in the circle can only use their hands to stop the ball. If the ball goes through the legs of a boy or if a Cub falls down, they take the place of the Cub in the middle.</p>

<p>ICE-CUBE TOSS</p> <p>Grab an ice-cube and stand facing a friend. Toss the ice-cube to each other. Then both boys take one step backward. Toss the ice-cube back and forth, again. Repeat this until one of the boys drops the ice-cube. The winning team is the ones who have tossed the farthest! (You can also use water balloons, but make sure you are outside)</p>	<p>Cooperation Courage Health and Fitness Perseverance Resourcefulness Responsibility</p>
<p>SPONGE RELAY</p> <p>You will need: two buckets and sponges (different sizes are fun) Fill one bucket with water and put the sponges into it. Line up all the boys and place the other empty bucket at the end of the line. The goal is to get 2 inches of water into the empty bucket by passing the soaked sponge down the line. Each boy squeezes the sponge into the bucket and runs to the back of the line. * If there are more boys, do two lines * Use the sponges for a water fight. They work better than balloons because they refill, and don't hurt as much.</p>	<p>Compassion Cooperation Courage Health and Fitness Positive Attitude Responsibility</p>
<p>NAME BINGO</p> <p>Each Boy has a sheet of paper marked off in a grid (five across, five down). The boys then go around to other guests and ask them to sign a square. At a designated time, everyone stops and puts their own name on a piece of paper and puts them in a "hat". The leader pulls names out of the hat and reads them out loud. If a guest has that name on their paper, they put an X on that square. The object is to get a straight line, horizontally, vertically or diagonally.</p>	<p>Compassion Cooperation Honesty Perseverance Respect</p>
<p>PAPER AIRPLANES</p> <p>Let them make paper airplanes of their own design. Have a contest to see whose plane goes the farthest, the highest, the craziest etc... Have them try it with and without a paperclip on the nose for a weight. For Webelos talk about Bernoulli's Principal and why airplanes are able to fly.</p>	<p>Citizenship Perseverance Positive Attitude Resourcefulness Responsibility</p>

<p>Citizenship Cooperation Faith Honesty Respect</p>	<p>GET ACQUAINTED GAME</p> <p>Gather one signature for each line. Make up more questions based on the location of your meeting.</p> <ol style="list-style-type: none"> 1. Had poison ivy this summer. _____ 2. Went to day camp. _____ 3. Can lay a log cabin fire. _____ 4. Knows the name of the Cubmaster. _____ 5. Was a Cub Scout when young. _____ 6. Can tell the recipe for S'Mores. _____ 7. Knows the words to Tap. _____ 8. Can identify a tree nearby. _____ 9. Knows the law of the Pack. _____ 10. Can Say the Cub Scout Promise _____
<p>Cooperation Health and Fitness Perseverance Resourcefulness</p>	<p>CIRCLE CATCH</p> <p>You need: several balls, preferably different sizes and weights.</p> <p>Boys stand in a circle facing inwards, about arm’s length apart. The leader stands outside the circle and throws a ball to one of the boys who then throws it to another in the circle. When the ball is being passed back and forth across the circle, the leader throws in a second ball, then a third and so on. The object is to see how many balls the group can handle without it degenerating into utter chaos.</p> <p>Balls should be chosen to accommodate the abilities of the den. Tigers or Wolves may do better with something like bean-bags. With Webelos II, you may want to try an occasional football or Frisbee. Outdoors in the summer screams for a water balloon.</p> <p>You can also label your balls with the values for the month</p>

<p>WE FOUGHT HARD FOR THOSE 50 STARS</p> <p>Divide the group into equal teams lined up a few feet away from the table. Place a bowl on the table for each team. Lay 50 cutout paper stars (approximately 2 inches in diameter) out on the table beside each bowl. Give each player his own straw.</p> <p>On a signal, the first player in each team runs forward and picks up one star, or as many as he can with one breath, by sucking on the straw, thus holding the star to the end of the straw. No hands! He releases the stars into the bowl, and then runs to tag the next player and gets at the end of the line. (He may need to run again.)</p> <p>The first team to have all 50 stars in the bowl is the winner. (The game could be varied with the original 13 stars for a smaller group of boys.)</p>	<p>Citizenship Cooperation Health and Fitness Perseverance Resourcefulness</p>
<p>FAITH WALK</p> <p>Blindfold all of the boys and have them stand in a line, each boy holding onto the shoulders of the boy in front of him. Tell the boys they have to keep their hands on the Scout before them. Scout leader gives instructions such as turn right, step over log, duck under tree branch, etc. It is fun to get this on video and have them duck or step high when nothing is there.</p>	<p>Courage Faith Honesty Perseverance</p>
<p>ACHIEVEMENTS INTO GAMES</p> <p>Just about anything you need the boys to learn can somehow be turned into a game or physical activity. Here are just a few examples:</p> <p><u>Webelos</u> - Write the parts of the Boy Scout Oath on masking or painters tape on the floor and have them jump over each one as they say them. A Scout is...(jump) trustworthy (jump) loyal, (jump) helpful... and so on.</p> <p><u>Bear</u> – Achievement 22 Tying it all up. Have them run from one station to the next before tying the required knots. Or run to the first, run backwards to the second, crawl to the third etc...</p> <p><u>Wolf</u> – Achievement 12 Making Choices – have them shoot a basketball and if they miss they answer a question/make a choice if they make a basket they get to choose someone else to answer one.</p> <p><u>Bobcat</u> – Write parts of the Cub Scout Promise on index cards or popsicle sticks. Give them to the group or individual all mixed up and have them put them in order. If you want to add more action turn it into a relay race and have them run to grab a part from somewhere first and return.</p>	<p>Any Value</p>

<p>Citizenship Courage Health and Fitness Perseverance Positive Attitude Resourcefulness Responsibility</p>	<p>ARROW CHASE BB, Denver Area Council</p> <p>Object is for two teams of Cubs to follow colored arrows over a course around the neighborhood. Before boys arrive, mark two paths, one with white and one with blue chalk. The first arrows should be right outside your front door; the others should appear about every ten feet. It's more fun if you put some on the sidewalk, some high on a telephone pole, some on a rock, etc.</p> <p>Though difficult to find, they should always be in plain view of a child standing on the ground. It doesn't matter if the paths cross and re-cross, but try to make both the same length and have both finish close to your house. The first team back to the den site wins the game.</p>
<p>Cooperation Perseverance Resourcefulness Responsibility</p>	<p>TRACTOR</p> <p>All you do is get a few large corrugated cardboard boxes and remove the tops and bottoms so you only have a tube. Lay the box on its side and get inside. You will have cardboard above and below and the sides will be open. Crawl inside the box and make it move like the treads on a bulldozer.</p> <p>Put two kids in boxes side by side and race. They will have a ball. If your box is large enough, you can team up parent/Cub inside one box and do teamwork. This is a real hoot. Fun to play and fun to watch.</p>
<p>Cooperation Health and Fitness Positive Attitude Responsibility</p>	<p>LAME CHICKEN</p> <p>Divide the boys into two teams and give each team 10 sticks about 10 inches long. The sticks are placed about 10 inches apart like the rungs of a ladder.</p> <p>On signal the first boy in each team hops on one foot over all 10 sticks. He then reaches down and picks up the 10th stick and hops back over the other 9 to his team. The second boy then begins, hopping over the 9 sticks, picking up the 9th and returning. Continue until all have raced. The last boy in line hops over all remaining sticks and then picks up all of them as he hops back to the finish line. If a player steps on any stick, he must start over from the starting line. First team done wins</p>
<p>Cooperation Health and Fitness Perseverance Positive Attitude Resourcefulness</p>	<p>DO THIS, ADD THAT</p> <p>First person does something (pats head). Next in line Pats head and adds something (stomps foot). The next person does the first action, the second then adds a third. The game continues until someone skips a step.</p>

<p>SENTRY POSTS</p> <p>The prize goes to the quietest team in this game. Set up two chairs about seven feet apart. These are the sentry posts and two blindfolded players are seated in them, facing each other. The other players divide into two teams. At a signal from the leader, the first player in each line sneaks forward on tiptoe and tries to pass between the two sentries without a sound. If either sentry hears anything, he calls out and points in the direction from which the sound came. If he's right, the player is "captured" and out of the game. If he points in the wrong direction, the player sneaks ahead. Each team goes through just once. The winner is the team that gets the most players past the sentries.</p>	<p>Citizenship Courage Honesty Perseverance Resourcefulness</p>
<p>MULTIPLES</p> <p>Players sit in a circle and start counting round the circle from "one." If the agreed figure for the game is seven, each time the number being called includes the figure seven or is a multiple of seven, the player keeps quiet and clasps his hands together. If anyone makes a mistake the leader records a point against him. When the boys become good at this game, add one or two other numbers, so they will have to keep very sharp not to get caught with more than one number going on at once. For one number the player clasps hands. For the second number he will put both hands above his head. For the third number he can nod his head.</p>	<p>Honesty Perseverance Positive Attitude Responsibility</p>
<p>SHOE RACE:</p> <p>Divide the children into two equal teams. Each child removes one shoe and all shoes are placed in a pile at the end of the room. The Scouts must race to the end of the room, find their shoe, put it back on and race back to their team. The first team to get all their shoes back is the winner.</p>	<p>Cooperation Health and Fitness Honesty Perseverance Respect Responsibility</p>
<p>PAPER HOOPS</p> <p>A pile of newspapers for each team is placed at one end of the room with the teams lined up at the other end.</p> <p>When the whistle blows they race up to the newspapers. The object is to cut the newspaper sheet in the middle and then step through the paper without ripping it right through to the edge. If that happens they have to start again. When they have stepped through, they race back so that the next team member can go. The winners are those who are all sitting down with their arms folded. Use newspapers that are not too big.</p>	<p>Citizenship Cooperation Health and Fitness Positive Attitude Resourcefulness Responsibility</p>

<p>Any Value (depending on the questions)</p>	<p>CUB SCOUT BASEBALL</p> <p>This idea has been developed in various ways. The following rules have worked out very well wherever they have been played:</p> <p>A list of questions is made up beforehand and divided into the different ranks in Cub Scouting.</p> <p>Four chairs are placed to represent four bases, also a chair for a pitcher's box if desired. Of course the players' benches must not be forgotten. The fielders are placed as in baseball.</p> <p>A Cub Scout comes up to bat. The pitcher asks him a question according to his rank. If he fails and the catcher answers it, it is a strike. If the catcher fails also, it is a ball. If he answers correctly he is allowed to ask a question of the baseman. These questions to basemen start at first and go right around the diamond in order as different men come up, but start at the first baseman every inning. If the baseman misses the Cub Scout goes to first. If he answers correctly it constitutes a put out.</p> <p>Cub Scouts advance around the bases by being forced, but if a man wants to steal he can obtain permission from the umpire to put a question to the next baseman. If the baseman fails the runner takes one base, but if he answers correctly the runner is out. In like manner if a baseman wants to try a put out on a runner who has an imaginary "lead" he can put a question to the runner. If the runner answers correctly he advances one base, if not he is out.</p> <p>The Cubmaster (or other) will act as umpire</p>
<p>Cooperation Courage Perseverance Respect Responsibility</p>	<p>NAIL DRIVING RELAY</p> <p>Stand one 4x4 block for each team on edge and start two or three 16 penny nails to the same height in the edge. Place the blocks about fifteen feet from the starting line and put a hammer next to each of the blocks. On "GO!" one boy from each team races to the block, picks up the hammer, and swings ONE blow to drive the nail into the block. He then lays the hammer down and returns to his team, tagging the next boy in the relay. The race continues, with each boy in turn going as many times as it takes for one team to drive all of its nails flush into the block. Be ready to straighten bent nails. Variation: Drive tent pegs with a mallet.</p>
<p>Health and Fitness Perseverance Positive Attitude Responsibility</p>	<p>NEWSPRINT RACE</p> <p>Each scout is provided with two sheets of newspaper, which he uses to run the race. He can only step on the newspapers; this is done by: stepping on one, lay the other in front of him, steps on it, retrieves the paper behind him, which he places in front of him moving forward in this fashion.</p>

<p>PASS AND TOUCH</p> <p>Equipment: Nature objects such as leaf, stone, twig, shell, corn, etc.; pencil and paper (optional)</p> <p>Divide players into groups of six to eight. Form a circle with hands in back. The game leader gives a nature object to one player. The player tries to identify the object by feel, but he does not reveal his answer. The object is then passed from hand to hand around the circle, giving each player a chance to identify it. Once the object has passed all the way around the circle, the game leader chooses one player to name the object. If the person is incorrect, the leader chooses another player to guess. After several items have been passed, see who can repeat or write down the most items correctly.</p>	<p>Honesty Perseverance Resourcefulness Respect</p>
<p>DISABILITY AWARENESS</p> <p>There is a listing of some Disability awareness games in – Section 2 of this Pow Wow Book in Advice from Akela , Scouting for the differently-abled</p>	<p>Compassion</p>
<p>FEATHER FRENZY</p> <p>Equipment: Craft feathers and paper plates</p> <p>Divide players into two teams with about six or eight each. Mark a starting line and a turning line about 20 feet away. Give each team a feather and a paper plate.</p> <p>On signal, the first person in each team starts fanning the feather toward the turning line, reversing direction upon arrival and returning to the start. Then the next one in line repeats the action, fanning the feather with the paper plate, until everyone has raced. No one can touch the feather at any time.</p>	<p>Cooperation Health and Fitness Honesty Perseverance Respect</p>
<p>COUNT TO TEN</p> <p>All players stand on one line except one player who is it. "It" stands with his back to the other players on a goal line about 30 to 35 feet from the starting line. "It" counts to ten as fast and as clearly as he can. While he is counting, the other players advance as fast as they can by putting one foot directly in front of the other (heel, toe, heel, toe). At the count of ten, "It" turns around. Everyone freezes. If someone moves he starts all over again. The first player across the goal line wins and becomes the next "it"</p>	<p>Health and Fitness Perseverance Positive Attitude</p>
<p>RUNNING HIGH WHISTLE</p> <p>The boy who can hold a whistled note the longest with one breath wins the event.</p>	<p>Perseverance</p>

<p>Cooperation</p>	<p>USING GAMES TO TEACH COOPERATION <i>Wendy, Chief Seattle Council</i></p> <p>Advantages of Cooperative Games: No losers, only winners; Age, size, strength do not matter, so any one can play, whole dens, packs, and families.; Rules can be changed to fit the abilities of the group, even mid-game; True cooperative games have all players working together to achieve a goal.</p> <p>Modifications: Play against time – Try to complete a challenge before a given time expires.</p> <p>Example:</p> <ul style="list-style-type: none"> • Try to get a certain number of points, or actions done before time expires • Try to complete the task in the shortest time possible, improving the time with each repetition. • Play to earn maximum points in a certain number of turns. <p>Everyone gets 1 turn</p> <p>Examples:</p> <ul style="list-style-type: none"> • Group takes turns jumping to get maximum distance; • Bat badminton bird between teams trying for maximum number of hits. <p>Game Modifications to make it easier for Boys</p> <ul style="list-style-type: none"> -Use bean bags or soft squishy balls instead of regular balls – easier to catch. -Simplify the rules. -Play a practice game so everyone becomes familiar with the rules. -Write the directions down. -Tone down action and contact (for timid players)– practice skills as group, - more stationary play. (pass basketball around circle of players) -To get more involvement, require a certain number of passes, or players to handle ball before scoring. Or, after catching ball/frisbee, players must freeze in place and pass the ball/Frisbee. <p>Choosing Teams -Here are some innovative ways to choose teams -</p> <ul style="list-style-type: none"> By Birthday (even vs. odd); Alphabet (last or first name, first half of alphabet vs. last part of alphabet); Randomly draw names; Line up group by height, then count off 1, 2, 1, 2. Ones and twos are teams <p>Encouraging Good Sportsmanship</p> <ul style="list-style-type: none"> -Boys earn reward (treat, bauble) if they demonstrate good sportsmanship. -Emphasize fun – not score. -Teach boys to use rock, paper, scissors to solve disputes quickly so they get more time playing. <p><u>Some Favorite Cooperation Games:</u></p> <ul style="list-style-type: none"> Blow Ball (How-to Book p. 3-32) Find the hidden alarms (bombs) Tag variations (How-to Book p. 3-16 & 3-17) Capture the Flag Inchworm race (Julie Reed): boys sit in-between each other’s legs in a line. Boys rock side to side, scooting forward on their butts.
---------------------------	--

Cub Scout



Audience Participation

It's good to get everyone involved in your meeting. It may be planned for ahead of time or you may just feel the need to "liven up" the meeting. Most Audience participations are stories where every time a certain word(s) is read in the story then in response a specific phrase, word or sound is made by the audience or section of. Others are fill-in-the-blank or "madlib" type stories. They are usually humorous and bring a fun spirit to the meeting. Some of them can be acted out and used more as skits. For more Audience Participation stories (as well as cheers, applauses, run-on and other fun things to liven up your meetings) buy a copy of *Group Meeting Sparklers* available at your local scout shop.

<p>Cooperation Perseverance Resourcefulness</p>	<p>HOW TO BUILD A THINGAMAJIG (York Adams Council, Baloo's Bugle Aug. 2000)</p> <p>DOODADS: Clickety-clack, clickety-clack DINGFORD: Whiz, bang, boom FREEDISTANT: Whoosh, whoosh HIGORICKY: Snap, crackle, pop SCATEREEKUS: All sounds together</p> <p>Very few families these days can get by without a thingamajig. Sure you can buy one at the local hardware and appliance store in all sorts of colors, sizes, shapes, makes and models. But as easy as they are to build yourself, you should just get a kit and put it together. Here is a simple set of instructions for building your own thingamajig.</p> <p>The DOODADS of the thingamajig kit are stored in the bubble-wrap gizmo and are stapled with the purple assembly DINGFORD to the left-handed FREEDISTANT. The assembly DINGFORD should be placed in an upright position on any corrugated doomafatchy or FREEDISTANT to complete assembling the DOODADS.</p> <p>Carefully remove the gizmo from its containeration of the DOODADS from the FREEDISTANT and lay out the DOODADS in parallel with the assembly DINGFORD and assemble the DOODADS in the order listed. You will need two fringhoppers with a 4/3" gagglehump for the HIGORICKY, and you'll have to use penpoppers to complete the riggeration. Using a witchiffigle, carefully punch 1/2" what-nots through the assembly DINGFORD and FREEDISTANT, where the HIGORICKY will attach. The what-nots are there to capitrate the hoosie HIGORICKY that will beefling the DOODADS together.</p> <p>Next, framemis the chingus to the FREEDISTANT, making sure the whatchamacallits are catiwompus to the hootnanny and the HIGORICKY, as shown on the assembly DINGFORD. If it is reversed, the thingamajig will not work properly. Tighten two fist around valves underneath the FREEDISTANT using the hickeys from the DOODADS to freehopper one dingus from the other.</p> <p>Now refracker a jigger to the demisantis and the doorfunkey near the whatchamacallits. Put a dingus on each loose enough so that the thingamabob can discombobulate and rotate easily, or it might buzz and fly off and hit someone in the doohickey.</p> <p>That finishes the instructions. If you've followed them carefully, you should have a well running thingamajig when you turn over the SCATEREEKUS.</p>
--	---

ROBINSON CRUSOE'S DIARY**Any Value**

Copy the following phrases on slips of paper and drop them into a container. As "Mr. Crusoe" reads his diary, each "sailor" takes a turn drawing words from the container to fill in the blanks. Or you can pass them out ahead of time in random order and just go right down the rows for answers.

A dove	A bonfire	A big tree
Dandelions	A wild goat	30 cannibals
Gunpowder	My tent	A strong fence
A chest of gold	A goatskin	A pile of straw
Piece of canvas	My field glasses	Coconuts
All my belongings	A table and chair	A cup of goat's milk
The top of the hill	A loud noise	Seashells

"This morning I woke up and ate my breakfast, which consisted of _____ and _____. Afterward, I took my saw and hammer and built _____. Since I was shipwrecked and alone, I had to go hunting in the woods for my lunch. I forgot my gun, so I had to capture _____ with my bare hands. I also tried to catch _____ too, but could not run fast enough. I went home to my cave, sat down in _____ and ate my lunch.

Since my clothes were all lost at sea, I decided to make myself something to wear. I made a pretty neat hat from _____ and a coat out of _____. I wrapped my feet in _____. Suddenly I heard a _____ and ran out and climbed into a _____. I looked through _____ just in case I might see _____. I didn't, but there on the beach I saw _____ dancing in wild glee around _____.

Running up the trail toward my hideout was _____ crying out and looking frightened. I hid the poor thing behind _____. I found my gun, loaded it with _____ and stood guard over _____. When it seemed safe, I got busy and built _____ all around _____.

Then I finally lay down in my comfortable bed made of _____ and slept soundly."

<p>Citizenship Cooperation Responsibility</p>	<p>HERITAGE LOST</p> <p>NARRATOR: Our American heritage is filled with heroes. Everyone has heard of Paul Revere and his heroic ride to warn the people of Lexington and Concord, Massachusetts about the approach of the British army. His famous ride took place during the Revolutionary War, on April 18, 1775. Paul was able to take his ride because he was signaled by a sentry, who watched for soldiers from the tower of the Old North Church in Boston. Paul and his sentry worked out a simple set of signals. The sentry would light one lantern if the soldiers were approaching by land and two lanterns if they were arriving by sea. Paul, mounted on his horse, would be watching for the signal and ride to warn the people about the impending arrival of the soldiers. Have you ever thought what a hard time Paul and his sentry would have today? Just think of all the ways those soldiers could come now! Let's rewrite a little American history to see just how confusing it would be today.</p> <p>Just follow these directions. (hold up # on fingers to help them if you want) Stomp once when I say the word LAND. Stomp twice when I say SEA. Stomp three times for AIRPLANE. Stomp four times for TRAIN. Stomp five times for SUBMARINE. Stomp six times for ROCKET.</p> <p>Now we are ready to take another look at history: In a steeple of the old North Church in Boston, a sentry looked out over the SEA(2). His eyes strained as he looked across the LAND(1). All was very still. It was late at night. Next to him was a lantern. He took a sheet of paper from his pocket. It read "Signal with your lantern when you see the British army approaching. The signals are: one if by LAND(1), two if by SEA(2), three if by AIRPLANE(3), four if by TRAIN(4), five if by SUBMARINE(5), six if by ROCKET(6)."</p> <p>After reading it, the sentry began to put it in his pocket. Just then a gust of wind blew the paper out of his hand. Out across the LAND(1) and into the SEA(2) it went. The sentry thought, "I'm sure I can remember it." Just then he saw a SUBMARINE(5) surface a short distance from LAND(1). He grabbed his lantern to wave it four times. "Oh no!" he thought. "Four times for ROCKET(6), or is it for LAND(1)? No, it's one for LAND(1), so it must be two for SUBMARINE(5). No, two is for AIRPLANE(3). It must be three." As he started to raise his lantern, he remembered that two was for SEA(2), not AIRPLANE(3). "Oh dear, what is a SUBMARINE(5)? Let's see, SUBMARINE(5) comes after TRAIN(4) but what's ROCKET(6)? Oh, now I remember. ROCKET(6) is six and TRAIN(4) is four so SUBMARINE(5) must be five.</p>
--	---

<p>HERITAGE LOST – Audience Participation – Continued</p> <p>While the sentry was trying to remember his signals, the British SUBMARINE(5) had loaded it passengers onto launches and hundreds of British soldiers were now on LAND(1). "Oh my," thought the sentry. "They are not in a SUBMARINE(5) anymore, they are on LAND(1). I'll have to signal that." But he couldn't remember what the signal was for LAND(1). "I remember ROCKET(6) and TRAIN(4). That leaves SEA(2), AIRPLANE(3) and LAND(1). Oh now which is it?" He sat there hopelessly confused. He couldn't unscramble ROCKET(6), AIRPLANE(3), LAND(1), SUBMARINE(5), SEA(2) and TRAIN(4).</p> <p>Since all the people were sound asleep, the soldiers had no trouble capturing them. The only person they met was a man sitting on a horse. Who he was or why he was there, no one seemed to know.</p>	
<p>MY FATHER WAS A MERCHANT</p> <p>Get your den involved in this skit. Let them stand up front and lead the actions as one person reads the story. Of course, everyone in the audience has to stand and participate too. Each action continues till the end of the skit with new actions being added.</p> <p>My father was a merchant. He used to bring me many fine presents from his store. One night, he brought me a peacock feather fan. <i>(Everyone starts fanning themselves.)</i></p> <p>My father was a merchant. He used to bring me many fine presents from his store. One night he brought me a pair of ivory handled scissors. <i>(Snip with two fingers of other hand and continue fanning.)</i></p> <p>My father was a merchant. He used to bring me many fine presents from his store. One night he brought me an antique pedal sewing machine. <i>(Pedal with one foot, and continue snipping and fanning.)</i></p> <p>My father was a merchant. He used to bring me many fine presents from his store. One night he brought me a fine hickory rocking chair. <i>(Rock and continue pedaling, snipping and fanning.)</i></p> <p>My father was a merchant. He used to bring me many fine presents from his store. One night he brought me a golden Swiss cuckoo clock. <i>(Rock, pedal, snip, fan and yell "Cuckoo! Cuckoo!")</i></p>	<p>Health and Fitness Cooperation Perseverance</p>

<p>Compassion Cooperation Honesty Perseverance Positive Attitude Resourcefulness Responsibility</p>	<p>HOMEOWNERS (Mt. Diablo Silverado Council, Baloo's Bugle Dec. 2000)</p> <p>MR. and MRS. HOMEOWNER: Honey, I'm home PLUMBER: Get a mop, get a mop TOOLS: Clank, clank, bang ELECTRICIAN: Bzzzt! How shocking TV SET: We'll be right back</p> <p>One day, MR. and MRS. HOMEOWNER came home from work to find their kitchen flooded with water. "Whatever shall we do?" asked MRS. HOMEOWNER. "We'll call a PLUMBER!" said MR. HOMEOWNER. "He'll know what to do." Quick as a wink, the PLUMBER arrived with his bag of TOOLS. "Don't worry," said the PLUMBER. "This looks like a simple leak. I'll just get my TOOLS and have it fixed in a jiffy." Then he crawled under the sink and began banging on the pipes. MR. and MRS. HOMEOWNER covered their ears and left the room.</p> <p>But suddenly, all the lights in the house flickered and then went out! "Oh no!" cried MR. and MRS. HOMEOWNER. "Now we'll have to call the ELECTRICIAN!" Soon the ELECTRICIAN arrived with his bag of TOOLS and began to check the wiring. "Here's the problem," he said, as he stuffed his TOOLS back into their case. "There's something wrong with your TV SET." "The TV SET?!?" said MR. HOMEOWNER. "How much will it cost to fix?" "Oh, about a thousand dollars," said the ELECTRICIAN, smiling broadly at the thought of all that money. "A thousand dollars just to fix a TV SET? Said MRS. HOMEOWNER. "We can't afford to pay that much!</p> <p>MR. HOMEOWNER thought about missing his favorite TV shows, then shook his head and slowly took out his checkbook. Just then the PLUMBER came into the room and handed his bill to MRS. HOMEOWNER. "Wait a minute dear," she said. "You might miss your favorite shows, but I have to wash my hair tonight! You know we only have enough money to pay one of these bills, and you know what they say - TV or not TV, water's the question!</p>
--	--



SMOKEY BEAR (A TRUE STORY)

(Simon Kenton Council, Baloo's Bugle Oct. 2001)

BIG TREE - I am SO big!

MIDDLE-SIZED TREE - See my pretty leaves

BABY TREE - I'm just a bush

BABBLING BROOK - One person gets up and run through the group, babbling

CAMPER - I love this beautiful forest

FIRE - Crackle, crackle

SMOKEY - Only YOU can prevent forest fires

Once upon a time, in a beautiful lush green forest, there stood three trees, the BIG TREE, the MIDDLE-SIZED TREE and the BABY TREE. A BABBLING BROOK coursed its way through the forest. A CAMPER made a FIRE for his breakfast without clearing the area for 10 feet and then went for a hike without making sure the FIRE was dead out. The FIRE threw some sparks into some dried grass. It started smoldering. The BABBLING BROOK was not close enough to put out the sparks.

In a short time, the dry forest was ablaze. The animals heard the sounds of the FIRE, smelled the smoke, and tried to flee. A bear cub couldn't see where his mother had gone so he did what she had taught him when there was danger. He climbed the BIG TREE. The FIRE roared by. It burned up the BABY TREE and MIDDLE-SIZED TREE. It singed the BIG TREE with the bear cub clinging to the top.

After the FIRE, a ranger found the bear cub still in the top of the BIG TREE and got him down. He was singed and scared. The ranger healed his burns and raised him. He called him SMOKEY. He became the symbol to remind CAMPERS and hikers to be careful with FIRE and protect the BIG TREES, the MIDDLE-SIZED TREES and the BABY TREES so we can enjoy the forest with the BABBLING BROOKS running through them. Remember, "Only you can prevent forest fires!" The one who says that is SMOKEY BEAR.

Citizenship
Compassion
Cooperation
Courage
Resourcefulness
Respect
Responsibility



Compassion
Health and Fitness
Perseverance
Resourcefulness

MOST EMBARRASSING DAY TO PLAY BASEBALL - MADLIB

(Baltimore Area Council, Baloo's Bugle Jun. 2005)

Give everyone a copy of the list below during Gathering Time. Have them fill in the types of words required. Parents may help boys understand what types of speech are required.

- | | |
|---------------------------------|---------------------------------|
| 1. _____ (name) | 2. _____ (adjective) |
| 3. _____ (name) | 4. _____ (noun) |
| 5. _____ (adjective) | 6. _____ (past tense verb) |
| 7. _____ (clothing) | 8. _____ (verb ending in -ing) |
| 9. _____ (past tense verb) | 10. _____ (noun) |
| 11. _____ (clothing) | 12. _____ (verb ending in -ing) |
| 13. _____ (animal) | 14. _____ (body part) |
| 15. _____ (past tense verb) | 16. _____ (past tense verb) |
| 17. _____ (verb ending in -ing) | 18. _____ (body part) |
| 19. _____ (verb ending in -ing) | 20. _____ (number) |
| 21. _____ (adjective) | 22. _____ (adverb) |
| 23. _____ (adjective) | 24. _____ (noun) |
| 25. _____ (name) | 26. _____ (adjective) |

Read the following story. When you reach a number, point to someone in the audience and have them read their answer for that number. Have extra copies of the story to hand out to the families at the end of the evening, so they can see how their whole lists of words complete this silly story.

Hi, my name is (1), but you may call me (2) (3). That's what my (4) calls me. But anyway, would you promise to keep a (5) secret? Today, at baseball practice as I was trying to catch the ball, it (6) into my (7). I was very embarrassed to take it out because everyone was (8) at me.

When I (9) a few times trying to catch the ball, I got a (10) in my (11). Now everyone was (12) at me really hard. The next time I tried to catch the ball, a (13) landed on my (14) and I couldn't concentrate on catching the ball. When it was my turn for batting, I (15) the baseball bat in half! The coach was so (16) that he was (17) on my (18).

I was really embarrassed now, especially since everyone was (19) at me. I also had to pay the coach (20) dollars for a new baseball bat. The (21) coach made me leave early since I was doing so (22). Now people call me (23) (24) (25). Just remember it's a (26) secret!!!!

THE WONDERFUL CELLAR BAND

DUSTY OLD CELLAR: Cree-eek, Ah-choo
 EMPTY GLASS JUG: Boop, Boop
 RUSTY SAW: Whaan, whaan
 BEAT UP TRASH CANS: Crash-bam
 FADED OLD HAT BOX: Rat-a-tat-tat

Once upon a time, as many stories begin, in a DUSTY OLD CELLAR, there lived a group of very good, very old and very outdated friends. There was an EMPTY GLASS JUG, a RUSTY SAW, two BEAT UP TRASH CANS, and a FADED OLD HAT BOX. Now, these old friends had been in the DUSTY OLD CELLAR for a very long time, and except for being moved from time to time, they were left alone to rust or turn to dust. Needless to say, they were very lonely.

One day, the EMPTY GLASS JUG, in a deep low voice said: "It's too quiet here. I wish something would happen." "Now, really, JUG, what could possibly happen here?" asked the RUSTY SAW. "Why," said the FADED OLD HAT BOX, "I've been sitting on this DUSTY OLD CELLAR shelf for 20 years and all I've seen is two mice and a daddy long leg spider." "The EMPTY GLASS JUG is just getting older and emptier," said the BEAT UP TRASH CANS. "Don't pay him any mind."

Suddenly, there was a sound of footsteps on the DUSTY OLD CELLAR stairs. Four young boys, all dressed alike, came cautiously down the DUSTY OLD CELLAR steps. They were talking in hushed voices. "Are they twins?" asked the FADED OLD HAT BOX. "I think they're Pygmies!" said the RUSTY SAW in a lofty voice. "Nonsense," said the EMPTY GLASS JUG. "They're Cub Scouts," said the BEAT UP TRASH CANS. By now, the old friends were very curious and excited. They listened as the boys talked.

"Boy, it's spooky down here in this DUSTY OLD CELLAR," said Patrick. "Don't be a fraidy cat," said Nathan. "Aw heck, let's go," said Steven. "No, wait!" said Jourdan. "I've got an idea. We have to do a stunt for pack meeting, don't we?"

"Yes, that's right," the other three boys chorused. "Well," said Jourdan, "Let's have a band....a CELLAR band." "A band!" They yelped. "Sure," said Jourdan. "I'll play that RUSTY SAW. Patrick, you take that EMPTY GLASS JUG. Nathan, that FADED OLD HAT BOX will make a great drum. And Steven, those BEAT UP TRASH CAN lids would make sweet cymbals."

Well, of course, you know the rest. Den Three made new friends with the old friends right there in the DUSTY OLD CELLAR. They played a sweet tune with the EMPTY GLASS JUG, the RUSTY SAW, a FADED OLD HAT BOX, and two BEAT UP TRASH CANS. For all we know, they may be playing yet!

Cooperation
Compassion
Resourcefulness
Respect

Compassion
Cooperation
Health and Fitness
Perseverance
Positive Attitude
Resourcefulness

WINTER SONGS

As each part comes along, the group stands and sings the first line of song.

WINTER: "Dashing Through The Snow"

SANTA: "Jolly Old Saint Nicholas"

SLEIGH: "Sleigh bells ring, are you listening"

REINDEER: "Rudolph the Red Nosed Reindeer"

Once upon a time, on a cold, dark WINTER night, SANTA sat in his workshop trying to decide what to do. His SLEIGH had a broken runner, his elves were behind schedule on toy production, his REINDEER were weak from lack of exercise, and he, SANTA, had a cold. With Christmas only days away, and the WINTER weather cold and snowy, SANTA was so depressed.

Rudolph, his most famous REINDEER, was unable to get his nose recharged, so that it barely glowed at all. In a practice run, the SLEIGH with the broken runner scarcely got off the ground. The elves were stopping early to watch the Power Rangers despite the number of toys that still needed to be made. "Goodness me!" cried SANTA. "How will I ever get everything complete by Christmas Eve?"

Out in the cold WINTER night trudged a cold, hungry old man. "SANTA," cried the cold, old, hungry man. "If you will give me a hot meal and a warm place to sleep, I'll fix your SLEIGH, cure your REINDEER, fix Rudolph's nose and get the elves to work faster." SANTA quickly agreed. After he had eaten and had a nice night's sleep, the old man went to work.

First, he plugged the nose of Rudolph, the red-nosed REINDEER into the television set. This charged Rudolph's nose so that it glowed more brightly than ever, and it also blew a fuse on the TV set. This enabled the elves to work later, since they couldn't watch the Power Rangers. They quickly caught up to schedule.

In the meantime, the old man used parts of the TV set chassis to fix the runner on the SLEIGH. The REINDEER, not able to watch TV, began to run in the snow, and quickly regained their strength. SANTA slept better and got rid of his cold.

Because the old man knew the true value of the TV, everything was ready and on December 24th, SANTA hitched his REINDEER to the SLEIGH and rode off into the WINTER sky!



TOY STORE UPROAR

(York Adams Area Council, Baloo's Bugle Feb. 2002)

DOLL: Bend forward at the waist and say, "Wahhh"

SOLDIER: Stomp feet and say, "March, march, march"

BIRD: Flap 'wings' and say, "Tweettweet"

JACK-IN-THE-BOX: Stand up and say, "boing"

TRAIN: Punch the air rhythmically and say, "Choo choo"

The DOLL had seen it all. The absentminded shopkeeper had really done it this time! He had closed up shop for the night and never locked the toy shop door! Now what would become of them – unprotected for a night! If someone decided to rob the store, none of the toys were safe. The DOLL knew something had to be done. But what? She tried to get the attention of the SOLDIER. She inched her way to the very edge of the shelf. "Help," cried the DOLL, but the SOLDIER never looked her way. "The cuckoo BIRD!" thought the DOLL. "A bit flighty perhaps, but nonetheless helpful." The DOLL called him, but the BIRD was so busy chirping out the hour, he never heard her.

By now, the DOLL had worked herself so near the edge of the shelf that when the JACK-IN-THE-BOX suddenly popped up, he frightened the poor DOLL who lost her balance and toppled off the shelf right into the engine car of the TRAIN. As she landed, she hit the throttle of the TRAIN, setting it in motion. As it rounded the first bend, the top of the TRAIN bumped into the JACK-IN-THE-BOX, knocking him off his shelf and into the next car of the TRAIN.

At the second bend, the JACK-IN-THE-BOX popped up when he was just beneath the SOLDIER. The startled SOLDIER fell head first into the BIRD. They both tumbled over and over each other—first the BIRD, then the SOLDIER, the BIRD, the SOLDIER, BIRD, SOLDIER—until they landed in the last car of the TRAIN. The DOLL cried out in disbelief! What a horrible night this was turning out to be! A TRAIN pulling a DOLL, a JACK-IN-THE-BOX, a SOLDIER and a BIRD—all going round and round in an unlocked toy shop in the middle of the night!

Just then, the door slowly opened. The DOLL held her breath. "Why, you naughty toys." It was the absent-minded shopkeeper! "I came back because I realized I hadn't locked the door, and what do I find? All of you playing after hours!" Then the shopkeeper set the BIRD in the sentry box which belonged to the SOLDIER, the DOLL where the TRAIN belonged, the SOLDIER on the shelf where the DOLL usually sat, and the JACK-IN-THE-BOX in the clock where the BIRD was supposed to be.

"This is all wrong," the shopkeeper said. So he put the BIRD in the TRAIN, the DOLL on top of the JACK-IN-THE-BOX, and the SOLDIER in the clock. "That can't be right," he squealed, and he put the DOLL in the TRAIN, the TRAIN in the clock, the BIRD in the sentry box and the SOLDIER in the JACK-IN-THE-BOX. And when he saw the confusion he created, he gave up. And so do I!

Any Value

<p>Any Value</p>	<p>THE TRANSCONTINENTAL TRAIN (West Mich. Shores Council BSA Pow Wow Book)</p> <p>TRAIN - "Toot! Toot!" CONDUCTOR - "All Aboard" NEW YORK DOCTOR - "New York City!?" PENN STEEL WORKER - "Man of Steel" SOUTHERN BELLE - "Hi, y'all" TEXAN - "Remember the Alamo!" KANSAS FARMER - "The World's Breadbasket"</p> <p>Just before the transcontinental TRAIN was ready to pull out of Grand Central Station, the CONDUCTOR held the door for one more passenger, a NEW YORK DOCTOR who hurried aboard. The TRAIN moved slowly between the tall buildings, out of New York, through New Jersey and on to Pennsylvania. The CONDUCTOR checked the ticket of the NEW YORK DOCTOR as the TRAIN pulled into the Pittsburgh Station. A PENN STEEL WORKER boarded the TRAIN and sat across the aisle from the NEW YORK DOCTOR. The train wound through the Appalachian Mountains, by rivers and through forests down to Atlanta. The CONDUCTOR greeted a SOUTHERN BELLE who boarded the TRAIN. She smiled at the PENN STEEL WORKER, and sat behind the NEW YORK DOCTOR.</p> <p>The TRAIN picked up speed as it left the mountains and crossed the delta lands of Mississippi. The CONDUCTOR paused to look out the window with the SOUTHERN BELLE, as the TRAIN traversed a long bridge over the Mississippi River. It arrived at the hot springs in the midst of the Ozark Mountains of Arkansas, as the NEW YORK DOCTOR and the PENN STEEL WORKER played cards. The TRAIN crossed into Texas and stopped at Dallas, where a young TEXAN boarded the TRAIN, showed his ticket to the CONDUCTOR, tipped his hat to the SOUTHERN BELLE, and took a seat.</p> <p>The TRAIN moved north through the rolling hills of Oklahoma and through the wheat fields of Kansas, stopping in Wichita where a KANSAS FARMER and his wife boarded the TRAIN. The KANSAS FARMER shook hands with the NEW YORK DOCTOR, and sat beside the young TEXAN, as his wife smiled at the PENN STEEL WORKER, and sat next to the SOUTHERN BELLE. The TRAIN turned west, moved up steep mountain passes and through the snow-covered Rocky Mountains of Colorado and Utah.</p> <p>The CONDUCTOR checked his watch as the TRAIN sped out of the mountains and into the desert of the Great Basin in Nevada. The TEXAN and the NEW YORK DOCTOR admired the large trees, as the TRAIN wound through the Sierra Nevada Mountains and the Redwood Forests. The TRAIN pulled into its final destination of San Francisco, California, where the CONDUCTOR said goodbye to the NEW YORK DOCTOR, the PENN STEEL WORKER, the SOUTHERN BELLE, the TEXAN, and the KANSAS FARMER.</p>
-------------------------	---

THE DEN PICNIC

Divide the audience into five groups. Assign each group a word from the story and its response. As the story is read, the group must respond to their word.

PAUL - I love summer.

CUB SCOUTS - We'll do our best.

DEN LEADER - Now, boys.

CAT - Meo-o-ow.

PICNIC - Yum, yum, let's eat!

PAUL was really excited. Today was the day the CUB SCOUTS were coming to PAUL's house for the den PICNIC. True, PAUL's mother was the DEN LEADER and the CUB SCOUTS came to his house every week for their den meetings, but today was extra special. PAUL had never had a PICNIC in his backyard before, and to have the CUB SCOUTS there too made it even more special.

PAUL went into his backyard to make sure everything was ready for the PICNIC. There he saw his CAT sleeping under the swing set. "Come on, CAT," said PAUL. "You can help me get ready for the CUB SCOUTS." CAT rolled over and purred. She liked helping PAUL and she liked the CUB SCOUTS. They always played with her until the DEN LEADER put CAT outside so the meeting could begin.

PAUL and CAT walked around the yard, All the leaves had been swept out of the yard. All the outside toys had been put away. There was plenty of room to play games and the PICNIC table was ready for the food. CAT jumped up on to the PICNIC table. "No, CAT," said PAUL. "The CUB SCOUTS don't want to eat where you have been walking. And you know what the DEN LEADER will do." CAT jumped down and went back to the swing set to snooze some more. She wanted to be wide awake and ready when the CUB SCOUTS arrived.

PAUL went inside to help with the food. Soon it was time for the CUB SCOUTS to arrive. PAUL heard CAT meowing loudly at the back door. "What's the matter, CAT?" he asked as he opened the door. He didn't even have to wait for CAT'S answer. PAUL could see the darkened skies outside and feel the strong wind that had sprung up suddenly. Soon, great drops of rain were splashing all over the PICNIC table. The doorbell rang as the CUB SCOUTS arrived for the den PICNIC. PAUL was horrified. How could the CUB SCOUTS have a PICNIC out in that rain storm? Luckily, the DEN LEADER knew what to do. She had been to training and knew she must have a "plan B" for times just like this.

Soon, the PICNIC was spread out on a blanket on the family room floor. Paul and the CUB SCOUTS and the DEN LEADER ate happily. Even CAT was happy as she stole some food from PAUL'S plate.

Cooperation
Health and Fitness
Perseverance
Resourcefulness

<p>Citizenship Compassion Cooperation Courage Respect</p>	<p>CHRIS MEETS MISS LIBERTY</p> <p>AMERICA, AMERICAN - Salute and sing "My Country 'Tis of Thee" FRANCE, FRENCH - Wave and say "Bonjour!" STATUE - Raise hand as if holding a torch and declare proudly "Liberty!" CHRIS - Point to yourself and say "That's me!"</p> <p>CHRIS stepped off the ferry. He looked up. There it was - the STATUE of Liberty. "Wow," CHRIS exclaimed. "I have waited so long to come here. You are beautiful, Miss STATUE of Liberty."</p> <p>"Thank you," said a cheery voice. "Who's that?" asked CHRIS. "Why, it's me." CHRIS looked around. "Up here," the voice whispered. He looked up. The STATUE winked. "Wait a minute! You're a STATUE! You can't talk." CHRIS exclaimed. "Every once in a while, I like to talk. Even with all the people who come to visit me, I still get lonely," sighed the STATUE. "Miss STATUE of Liberty, may I ask you some questions?" asked CHRIS. "Call me Libby. Sure, ask away." "Libby, where did you come from? How did you get here? Why . . ." "Slow down," the STATUE laughed. "One question at a time." "Years ago, the people of FRANCE wanted to show they were friends with the AMERICAN people. So a STATUE was built. Mr. Bartholdi, a FRENCH sculptor, created me. The FRENCH people gave centimes and francs, like your dollars and cents, to pay for the STATUE. That's how I came to be.</p> <p>In May 1884, I was packed in 214 crates and sent over the ocean on a ship named the SS Iser. That's how I got here." "But I had to stay in those crates for a while, once I got to AMERICA. Here was an island to live on, but no place to stand, without getting my feet all muddy." "So what happened next?" asked CHRIS. The STATUE of Liberty smiled. "Mr. Pulitzer, a newspaper editor, asked for donations in his newspapers. This time, the people of AMERICA sent dimes, nickels and pennies until there was enough to build this lovely pedestal. "The workers got busy, took me out of those crates and carefully riveted me together. The last rivet was driven on October 28, 1886. You could say that was the birthday of the STATUE of Liberty. I've stood here ever since, shining my lamp for all to see." CHRIS was amazed. "What else . . ."</p> <p>"CHRIS. . . CHRIS. . . !!!!" "What is it Libby?" "Libby? I'm not Libby, I'm your mom." CHRIS opened his eyes. He was in his room, and his mom was standing by his bed. "Mom, Mom! The STATUE of Liberty talked to me! Her name is Libby and she's from FRANCE and . . ." "Come on, CHRIS. Better get going or you'll miss the trip to the STATUE of Liberty! You are such a dreamer. Libby, indeed."</p>
--	---

THE HAPPY HIKERS

(Long Rivers Council Pow Wow 1992)

NARRATOR: We're going on a hike. Just do what I do and listen carefully.
 (Begin walking in place) Here we go on a hike through the woods and over
 the mountains. Come along with me. (smile, wave and hike in place)

We're coming to a steep hill. (bend over as if climbing) Now we're on top.
 What a lovely view! (shade eyes and look around) Now, we'll have to go
 down. (move hand like going down a roller coaster and say "swoosh") Boy,
 we're out of breath. (breathe heavily) Now, we're passing through a
 meadow. (hike in place)

What's that I see? (stop, look to one side) It's a rabbit! And a meadowlark.
 (look up) And a bumble bee! (run swiftly in place, waving arms as if fighting
 off a bee) We're happy hikers. (hike in place) We're happy because of the
 beautiful mountains we see, (shade eyes and smile) and because of all that
 clean fresh air we are breathing, (breathe heavily) and especially because
 we got away from the buzzing bee. (smile, turn head to look behind you
 and wave "bye" to bee)

Now we're getting tired. (slow pace, walk droopily) There's what we need!
 (point) A cool refreshing drink from the river. (pick up pace, kneel down and
 scoop water to mouth) Ahhh, how refreshing. Let's be on our way. (hike in
 place) Now let's try to jump over the river without getting our feet wet.
 (take big step, get feet wet, shake them off) Oh, well, don't feel too bad
 about not making it. That was a wide river. At least we have cool toes.
 (shake feet again)

We'd better stop for lunch. (stop, reach in pocket, bring out sandwich, start
 eating, take handkerchief from pocket, wipe mouth, replace handkerchief,
 resume hiking in place) Mmmmm, that feels better. Look, there's a lovely
 lake. (point) Let's swim across. (swim strokes) That was great! (resume
 hiking in place) Look at that crooked trail ahead. (point) It's nothing but
 twists and turns. (continue hiking -- twisting and turning)

I'm glad that's over. I was getting dizzy. (stagger) Looks like we have come
 to the end of the trail. (stop) What do we do now? Are you tired? (shake
 head YES!) So am I. (sit down, wipe brow.)

Courage
Health and Fitness
Perseverance
Positive Attitude
Resourcefulness
Respect



<p>Health and Fitness Perseverance Positive Attitude</p>	<p>A DAY AT THE BALL GAME</p> <p>JOHNNY – Cheer, cheer! UMPIRE – What an eye! DEN LEADER – Happy, happy! BARNEY (MCGOOGLE) – Our hero!</p> <p>One fine day, JOHNNY’s DEN LEADER decided to take the den to a ball game. JOHNNY was excited because his idol, BARNEY MCGOOGLE, was playing that day. The DEN LEADER and some of the parents loaded all the boys into their cars and headed for the ballpark.</p> <p>On the way to the game, the DEN LEADER pointed to a man in another car and asked, “Why would a person put on such a dark suit on such a warm day?” JOHNNY looked at the man and exclaimed, “He’s an UMPIRE! I wonder if he’s going to the game, too.” Sure enough, when BARNEY MCGOOGLE and the other players ran onto the field, out strolled the same UMPIRE who JOHNNY and his DEN LEADER had seen on the way to the game.</p> <p>When BARNEY ran out to his position, JOHNNY and all the other people cheered, for they knew BARNEY was a great player. The UMPIRE called, “Play ball!” Everyone was on the edge of their seats as the pitcher took his sign, wound up, and delivered his first pitch. “Cr-rack” went the bat and a towering fly ball headed toward BARNEY. Back BARNEY MCGOOGLE ran, nearer and nearer to the fence, until he was right up against it. At the last second, he made a great leap into the air and the ball thudded into BARNEY’s glove. JOHNNY, his DEN LEADER, and all the fans cheered as the UMPIRE signaled, “He’s out!” The pitcher then struck out the next two batters, with the UMPIRE calling the strikes very loudly.</p> <p>Now it was BARNEY’s team’s turn at bat. JOHNNY was hoping BARNEY would hit a home run. The first man up cracked a single. The next man also singled, and now, BARNEY MCGOOGLE stepped up to the plate. JOHNNY, his DEN LEADER, and all the other fans were cheering for BARNEY to hit a good one. “Strike one,” called the UMPIRE, and JOHNNY’s heart sank. The pitcher took his sign, checked the runners, wound up, and delivered. “Crack!” went the bat and JOHNNY knew BARNEY had hit a long one. Back, back, back went the fielder, clear to the wall. He leaped, but the ball hit the wall above him. BARNEY was churning his wheels around first, around second, heading for third. In came the ball and BARNEY hit the dirt. “Safe!” yelled the UMPIRE. JOHNNY, his DEN LEADER, and all the fans in the stadium cheered.</p> <p>JOHNNY was happy because, although his idol hadn’t hit a home run, he had hit a triple—the next best thing. JOHNNY, his DEN LEADER and all the rest of the den and parents went home smiling.</p>
---	--

IT'S ALL IN YOUR MIND

(Baloo's Bugle, July 2002)

JUMPING JACK: Stand up and jump once, say "Boing" and sit back down.

RUNNING RALPH: Stand up, run in place, "Zip!" Sit back down.

COMPUTER CHARLIE: Stand up, swing arms back and forth (like the robot from "Lost in Space") and say, "It Computes, It Computes." Sit back down.

This is the story about a boy named **JUMPING JACK**, and another boy named **RUNNING RALPH**, and still another boy named **COMPUTER CHARLIE**. These three boys were close friends and they went everywhere together. **JUMPING JACK** got his name because everywhere he went he was always jumping over things for no apparent reason except that he liked to jump. You could see all three boys walking around town with **JUMPING JACK** jumping over benches, curbs, bushes, fences and almost anything that wasn't too high.

As you may have guessed, **RUNNING RALPH** got his name because he was always running. Maybe his legs were shorter than his two friends and he had to run to always keep up, or maybe he just liked to run.

COMPUTER CHARLIE got his name because he was a very intelligent boy who excelled at mental skills. Everyone always teased **COMPUTER CHARLIE** because **COMPUTER CHARLIE** wasn't very good at sports or as strong as **JUMPING JACK** and **RUNNING RALPH**. But this never seemed to bother the three friends because they stuck together no matter what.

One day, **JUMPING JACK**, **COMPUTER CHARLIE**, and **RUNNING RALPH** were on their way to the store when they saw a local bank being robbed. The robber was making his getaway. **JUMPING JACK** jumped over the bushes and a fence to get to a neighbor's house to call the police. **RUNNING RALPH** was right behind him. But **COMPUTER CHARLIE** just stood there, watching the whole thing.

Thanks to **JUMPING JACK'S** jumping and **RUNNING RALPH'S** running, the police arrived at the scene in no time at all. They started to ask questions, but **JUMPING JACK** and **RUNNING RALPH** didn't know what to say because they had been too busy running and jumping to see what had really happened. But **COMPUTER CHARLIE** began telling the police everything they needed to know. He knew the model and color of the getaway car, the license plate number, the direction the robber went, and a description of his clothes and size. His mental skills were a great help to the police.

After reading about the theft in the newspaper, all of the children were so proud of **COMPUTER CHARLIE**. They never teased him again about his mental skills. They came to realize that **COMPUTER CHARLIE** was just as important as **JUMPING JACK** and **RUNNING RALPH**. Together, by pooling their talents, they were able to accomplish many great things.

Compassion
Cooperation
Courage
Health and Fitness
Perseverance
Positive Attitude
Respect

Citizenship**GEORGE AND THE APPLE TREE**

from www.scoutingbear.com, and Wendy, Chief Seattle Council

Divide the group into four smaller groups and assign each group one of the words listed below. Read the story. After each of the words is read pause for the group to make the appropriate response.

GEORGE "By George"

APPLE TREES "Mmmmm good"

ORCHARD Stand and wave arms like branches blowing in wind. Make noise like wind.

PATCHES "Ruff, ruff"

As presidents go, GEORGE __ Washington lead an interesting life. All of you have heard about the Cherry Tree incident, but have you ever heard of the one about the APPLE TREE __? The story goes like this.... One spring day, GEORGE __ and his constant companion, his dog PATCHES __, were walking around the home place, kicking rocks and what-not. It was a lazy afternoon between the morning chores and evening chores. PATCHES __ would bring GEORGE __ a stick to throw, so he could return it. Sometimes PATCHES __ would just run up to GEORGE __ with the stick in his mouth, dance around GEORGE __ and run away down the road.

Off to the right of the road was an ORCHARD __, with various fruit trees such as APPLE TREES __, cherry trees, peach trees and pear trees. This ORCHARD __ was a large one and was close to the house. This being Monday, the washing was hung out on the line to dry between the two huge APPLE TREES __. The wash -- shirts, linens and such -- was flapping in the breeze. Boys being what they are and dogs being the same, a game of tag developed around the laundry so carefully hung in the sun to dry. First PATCHES __ ran between Papa Washington's shirts and Momma Washington's best pillowcases, then around then came GEORGE __. Past the long johns, around the sheets, stirring a bit of dust, flapping the wash and popping the clothes line. Around the ORCHARD __ they raced, behind a cherry tree, under the peach tree and back again. Momma Washington came out of the back door yelling "GEORGE __! PATCHES __! What do you think you are doing?"

Poor GEORGE __. Everything happened at once. He looked toward the door where his mother stood, kept on running...smack into the APPLE TREE __! Kaboom! He grabbed the air, but got the clothes line instead. The wash fell, the clothes line came loose ... what a mess for GEORGE __! PATCHES __ didn't help either, because in the excitement PATCHES __ left paw prints on the shirts, pillowcases, long johns and such. Well ... mothers being mothers, after GEORGE __ was examined and found to be okay, with only a nice bump on the head to show for his little run-in with the tree, Momma Washington had GEORGE __ climb the APPLE TREE __ and re-hang the clothes line. But even worse ... GEORGE __ got to rewash all of the clothes. He invented a machine to help him with the laundry, but it didn't work very well, and he had to wash it all by hand. Which is probably why nobody ever heard about the day that PATCHES __ ran through the ORCHARD __, and GEORGE __ climbed the APPLE TREE __, and invented the George Washing Machine.

<p>TOMMY JOINS A CUB SCOUT PACK</p> <p>Greater St. Louis Area Council</p> <p>Cubmaster: Tonight, I would like to tell you a story about a boy named Tommy and how he became a Cub Scout. I need your help to tell this story. Would you supply a part of the story by being one of its characters, when you hear the name of your character, call out your part.</p> <p><u>Characters:</u> Tommy or Tiger Cubs - "Go Tigers" Bobcats - "Give a Roar" Wolfs - "Give a Howl" Bears - "Give a Growl" Webelos - "A Scoutin' we will go" Mother, Father or Parents - "That's my son" All Cub Scouts - "We'll Do Our Best"</p> <p>Our story begins when TOMMY started back to school after a summer of fun. One day his teacher passed out notes saying, "Be a TIGER CUB." All first grade boys and their PARENTS are invited to come to a meeting to hear about this Scouting Program.</p> <p>TOMMY went to the meeting with his MOTHER and they learned that TIGER CUBS, was a Scouting program planned especially for boys in the first grade. The lady at the meeting said that TIGER CUBS was a part of CUB SCOUTS where the boys worked on advancement, starting as BOBCATS and working to earn their TIGER CUB badge, then their WOLF badge, moving on to the BEAR badge and then becoming WEBELOS. As TIGER CUBS, they would team with their MOTHER, FATHER, or adult partner to form a TIGER CUB den. The boys and their adult partners work together on activities. Once a month one of the family teams would plan a special activity for the whole group.</p> <p>She said that their TIGER CUB Den would meet with the Cub Scout Pack for Pack Meeting and also participate in the Blue and gold Banquet and when they moved on to become Cubs, there would be a special graduation ceremony at the Pack Meeting. Each month, the TIGER CUB Den did something special and Tommy and his MOTHER would do the special things suggested in their "TIGER CUB handbook." One month the TIGER CUB Den visited a Veterinarian in the community. February came and the TIGER CUB Den helped at the Pack's Blue and gold Dinner. Each family in the TIGER CUB Den had a chance to meet the boys in the Pack. Joe and Bill were still BOBCATS but had completed the WOLF requirements and would get their badges at the dinner. Jerry and George were working on the BEAR badge; Jim and John would soon become WEBELOS. The Pack made his family feel very welcome and TOMMY knew that he was glad to be a Cub Scout.</p>	<p>Any Value</p>
--	-------------------------

TOMMY JOINS A CUB SCOUT PACK - Continued

As the meeting progressed he watched all of the CUB SCOUTS and their PARENTS go forward to receive their awards. The Cubs were presented with their Badges and Arrow Points. One WEBELOS Scout received his Arrow of Light. He was so proud. Two boys joined the Pack and received their BOBCAT Badges. TOMMY could hardly wait for the time when he would stand in front of the Pack and become a CUB SCOUT.

After the Blue and gold, the TIGER CUB Den met each month as usual. The boys talked about the Blue and gold, the fun they had, and when they would become CUB SCOUTS. They were becoming anxious.

One day, when TOMMY came home from school, his MOTHER had great news for him. Mr. Smith, the Cubmaster, was coming over to talk to them about his graduation into the Pack. He could hardly eat his supper.

When Mr. Smith arrived, he talked to both of his folks about CUB SCOUTS and how the PARENTS of the boys in the Pack were the leaders. He said that when TOMMY became a CUB SCOUT the Pack would count on them for support, too. His MOTHER said that she had enjoyed working with the TIGER CUBS and that she looked forward to CUB SCOUTS. His DAD said that Scouting had become a part of the family and that he would be glad to help, too.

So the Big Day came, the TIGER CUB Den stood before the Pack, each boy was welcomed with his family to Cub Scouting and at last TOMMY was a CUB SCOUT. He was ready to venture forward on the next step in his Scouting Adventure.



Cub Scout



Skits

Cub Scouts need the chance to be creative, to be silly, to be up in front of a crowd and be in the spotlight. They also need to learn how to speak in front of a crowd in a way that they will be heard and understood. Skits can teach them all of this and more! Don't be afraid to let them make up a skit or change one of these. They may surprise you with what they come up with on their own. Don't get too hung up on elaborate costumes, props or scenery. Most of the best skits are very simple.

<p>Cooperation Positive Attitude</p>	<p>THE RAISIN</p> <p>Cub #1 (Comes out and gets down on all fours, pretending to be a table.)</p> <p>Cub #2 (Comes out and looks at the table.) Ahhh, a fly! I think I'll pull its wings off. (Picks up the imaginary fly, plucks off wings, puts fly back on table and exits.)</p> <p>Cub #3 (Enters and looks at the fly on the table.) Oh, a fly with no wings! I think I'll pull its legs off. (With great precision and animation, he picks up the fly, removes its legs, puts it back on the table and exits.)</p> <p>Cub #4 (Enters and looks at the fly.) Say, a fly with no wings and no legs. I think I'll pull its head off. (Picks up imaginary fly and plucks off head.)</p> <p>Cub #5 (Enters, looks at the table, and carefully inspects the object without picking it up.) A RAISIN! (He quickly picks it up and puts it in his mouth.)</p>
<p>Resourcefulness</p>	<p>WATER CONSERVATION</p> <p>You will need a cup, water, an Announcer and four or more Cub Scouts. Preparation: Put half a mouthful of water in the last person's mouth. Don't swallow, and don't let the audience see this. Fill another cup with water and give it to the first person.</p> <p>Have all the Scouts except the Announcer stand in a straight line facing the audience. The last Cub is the boy with the water in his mouth. The announcer begins talking about water conservation and how water is very heavy to carry on hikes, but that these Cub Scouts have found a way around that. The announcer asks for a demonstration of one of the ways to conserve water.</p> <p>The first Scout says okay and all start brushing their teeth with their finger. (The last person in line needs to practice beforehand so water doesn't spill out). Let the announcer accidentally spill some water out of the cup to show the audience there's real water in there. Give the water to the first boy, he takes a drink to rinse his mouth out. He quickly swallows the water as he turns to the next boy. He "transfers" the water to the next boy's ear. Cover the transfer with hand covering both his mouth and the ear of the other boy. Repeat action down the line until the last Cub, with great showmanship, spits the water out.</p>

<p>THE GOOD SAMARITAN</p> <p>A Scout walks out from backstage, stumbles, and falls on his face. He struggles noisily to get up, but keeps his forehead on the floor. He sometimes succeeds in getting into a position with his feet and his forehead on the floor, and his butt in the air. He rotates in this position, keeping his forehead in one place. He calls for help, repeating, "My forehead is stuck!"</p> <p>As he struggles, other Scouts walk casually past. They ignore him, or look with curiosity, but they do not help.</p> <p>Finally, a Scout comes running up and heaves the victim to his feet. The victim is effusively grateful, but the rescuer just looks at his face. He reaches out, plucks something from the victim's forehead, and pops it into his mouth. "Thanks," he says, "I knew I'd lost my gum somewhere around here!"</p>	<p>Compassion Courage Positive Attitude</p>
<p>THE INFANTRY IS COMING!</p> <p>3-4 people and one person carrying a sapling</p> <p>#1: (Runs in yelling) The Infantry is coming! Go to the bomb shelters!</p> <p>#2: (A moment later, runs in yelling) The Infantry is coming! Save yourselves!</p> <p>#3: (A moment later, runs in yelling) The Infantry is coming! Let's help them!</p> <p>#4: (A moment later, runs in yelling) The Infantry is coming! Let's watch the tanks!</p> <p>(A moment later the last person runs in and proudly announces) And here it is, the Infant Tree!</p>	<p>Cooperation</p>
<p>STAR GAZING</p> <p>A Scout walks to the center of the stage looking up at the sky, keeping his head and neck very still. Soon he is joined by another Scout and then another and so on. Each Scout looks around and then begins to look toward the sky. The last Scout enters and asks the Scout next to him, "What are we looking at?". He answers "I don't know". That Scout asks the next, then that Scout asks the next until the question gets to the original Scout. The original Scout replies: "I don't know. I've got a stiff neck!"</p>	<p>Any Value</p>

<p>Responsibility Positive Attitude</p>	<p>GREAT AMERICANS</p> <p>NARRATOR: America, as you know, was founded by great people. No one here can remember them all or what they said. Let me tell you of a few of them. There was an astronaut called Armstrong who said, "One small step for man, one giant leap for mankind." And don't forget Benjamin Franklin, Daniel Boone or Pocahontas. The list could go on forever, but that is enough from me. It just so happens that I was able to contact a few of these great people from history and they consented to be with us tonight.</p> <p>First there is Paul Revere. You remember what he said the night of that famous ride.</p> <p>PAUL: The British are coming, the British are coming! They're being led by Lord Baden Powell.</p> <p>NARRATOR: Then there was George Washington. Remember what he said as he crossed the Delaware River in his row boat?</p> <p>GEORGE: Take heed and make haste gentlemen. On yonder banks of this water will soon be the site of our future Cub Scouts.</p> <p>NARRATOR: There was Betsy Ross. Do you know what she said?</p> <p>BETSY: General Washington, shall I sew a star on for Lord Baden Powell or shall I let him make his own mark in history?</p> <p>NARRATOR: How about Abraham Lincoln. Remember that immortal speech of his?</p> <p>ABRAHAM: Four score and 20 years from now, we shall set forth a small band that we will call Cub Scouts.</p> <p>NARRATOR: This brings us closer to date. I'm sure you all remember John F. Kennedy and what he said.</p> <p>JOHN: Ask not what Cub Scouts can do for me, ask what can I do for Cub Scouts.</p> <p>NARRATOR: Now that brings us to your den (or pack) leader, _____.</p> <p>DEN OR PACK LEADER: If I have but one life to give, let it be with Cub Scouting. (or If I help one boy in this life, then it has all been worthwhile.)</p> <p>NARRATOR: Yes, great Americans all. And Cub Scouts is a great American organization!</p>
---	--

<p>THE SOUND</p> <p>You will need noisemakers such as drum, bell, whistle, kazoo, guitar, etc. carried by each Cub Scout. You will also need a triangle or dinner bell.</p> <p>(Main Cub Scout (MC) comes on stage.) MC: I've just got to find THE SOUND. I've got to!</p> <p>(First Cub Scout comes on stage, carrying his noisemaker) MC: Have you got THE SOUND?</p> <p>(First Cub Scout demonstrates sound.) MC: No, that's not the right sound. That's not it at all.</p> <p>(Each Cub comes on stage and is asked by the Main Cub about his sound. Each demonstrates. Main Cub Scout rejects all sounds.</p> <p>Suddenly, there is the sound of a triangle or dinner bell being rung offstage or a boy wearing a cook's hat enters ringing the triangle or dinner bell.)</p> <p>MC: (excitedly) That's it! That's THE SOUND!</p> <p>All other Cubs: What is it? What is THE SOUND? MC: Why, it's the sound that's calling me to dinner. What better sound than that?</p>	<p>Health and Fitness Honesty Perseverance Positive Attitude</p>
<p>THE MOTORCYCLE DRIVER (Otetiana Council Pow Wow 1981)</p> <p>Characters: Cub Scout and 2 ambulance attendants Props: Helmet, motorcycle (toy, battery operated or pedal), ambulance (made from wagon), stretcher</p> <p>Cub Scout on motorcycle rides across the stage, as he gets half way across the stage he falls over. Ambulance enters with two Cubs as ambulance attendants. They run over and pick up the motorcycle very carefully and put it on the stretcher, leaving the Cub Scout laying on the stage. They put the motorcycle in the ambulance and drive off stage with the Cub Scout running after them.</p>	<p>Citizenship Compassion Cooperation Resourcefulness Responsibility</p>



Cooperation
Perseverance
Positive Attitude
Resourcefulness
Responsibility

THE GO CART

Need: 2 Scouts (1 participant is on hands and knees as the 'Go Cart').

Driver: Oh, this darn Go Cart is always giving me trouble ! Now the front wheel has come off. (Selects member of audience) Would you come over and give me a hand. Thanks. (Selected person may have some comments to respond to – then they are led to the cart.)

Driver: Here, if you would just be the wheel I need. That's right, get down on your hands and knees up there and be the front wheel. Now let me try it again. (Driver gets on car, tries to start it up.)

Go Cart: (Makes sputtering noises, starts, moves forward, then sags and sputters out.)

Driver: Now what is it? (Driver moves to rear, lifts cart, lets go and cart sags again.)

Driver: Now that old suspension has gone, I need more help. (Selects someone else) Please come over here and be the suspension. That's right, just hold the back end up there. Now I'll try it again. (Gets on car, starts engine.)

Go Cart: (Sputters to life, moves forward, wobbles, and stops.)

Driver: (Getting off) Oh, no. Now the rear wheel is loose. I'll go and get more help. (Selects more help. New help is positioned at rear wheel.)

Driver: This wheel is loose. If you will just hold the wheel (indicates leg) tightly so it doesn't fall off, you'll be a big help. Thanks. (Driver gets on cart, starts engine.)

Go Cart: (Starts up, runs fine, moves forward.)

Driver: (Braking to halt) Oh, that's perfect now! All I needed was a few NUTS to get it going!



WHEN I GROW UP

(SHAC, Baloo's Bugle Dec. 2000)

Props: A large box the Cubs can step into and out of, decorate front with knobs and dials. Cast: Eight Cub Scouts.

Cub 1: Ladies and gentlemen, this is the fantastic, terrific, magic, future machine. By entering this machine, you will know your future career.

Cub 2: Let me try it first.

Cub 1: OK, enter the chamber. (Turns dials on the front.) Come out and reveal your future. (Repeat this with each Cub.)

Cub 2: Wow, I'm going to be a truck driver. 10-4 Good Buddy.

Cub 3: (Enters then exits.) Hey, I'm going to be a Chef, dinner anyone?

Cub 4: (Enters then exits.) I'm going to be a doctor, want a shot?

Cub 5: (Enters then exits.) A lawyer, I'm going to be a lawyer. I think I'll run for District Attorney.

Cub 6: (Enters then exits.) Yea, yea, yea! I'm going to be a rock star, where's my guitar?

Cub 7: (Enters then exits.) An astronaut, look at Mars!

Cub 8: I'm not so sure about this, but here it goes.

Cub 1: This way. (Turns dials.)

Cub 8: (Enters then screams.) No! No!

Cub 1: What's the matter? What will you be?

Cub 8: No, I'll be a (pause for silence) Cubmaster! (Runs off the stage screaming.)

Citizenship
Courage
Positive Attitude
Respect



<p>Compassion Honesty Responsibility</p>	<p>HAPPINESS IS - MISERY IS</p> <p>2 to 8 Cub Scouts, or more. Cubs alternate;</p> <p>First boy says: "Happiness Is" second boy says : "Misery Is" Each holds up a card or cardboard cutouts (painted) of smiling and sad faces that boys can make themselves.</p> <p>1ST CUB: Happiness Is . . . hearing your Dad has won an all-expense paid trip to Hawaii.</p> <p>2ND CUB: Misery Is . . . when you find out that the trip is for two and you have to stay home with a baby-sitter.</p> <p>1ST CUB: Happiness Is . . . when your Dad drives you to school in his brand new car and all your friends are there to see you.</p> <p>2ND CUB: Misery Is . . . when you get out and the door falls off and lands on your toes.</p> <p>1ST CUB: Happiness Is . . . when your Mom takes you and your friends for a ride in her new convertible with the top down.</p> <p>2ND CUB: Misery Is . . . when it starts to rain cats and dogs and the top won't go up.</p> <p>1ST CUB: Happiness Is . . . when you're flying in outer space in a big space ship and you are in command.</p> <p>2ND CUB: Misery Is . . . waking up with a big headache after you've fallen out of bed from the top bunk.</p> <p>1ST CUB: Happiness Is . . . getting a bike for your birthday.</p> <p>2ND CUB: Misery Is . . . when you find it has three wheels.</p>
---	--



MAGIC MUD

You will need a den of 6 Cub Scouts and a sign that says "Magic Mud".

Setting: Boys are gathered around the sign in the center of the stage.

All: Did you ever wonder as you pass a little stretch of mud and grass, what nature may be hiding there, within this spot a few feet square? Let's gather round and take a look, and like the pages in a book, we'll study it with open eyes. Can soil like this hold a surprise?

Cub 1: Here's a freshly patterned animal track where a rabbit hopped across.

Cub 2: I see a stream of busy ants, carrying tidbits as they dance.

Cub 3: Look! A feather blue and gray dropped off by a screaming Jay.

Cub 4: Sprinkled here are sprouting seeds from lofty elms and sprawling seeds.

Cub 5: A pebble smoothed by action slow, formed a million years ago.

Cub 6: In a puddled spot not yet dried out, a water beetle swims about.

Cub 1: And here an eager plant is set, an early blooming violet.

Cub 2: A wiggle worm comes up to twitch; no one knows which end is which.

Cub 3: The mud itself, with food stores vast, from life that grew in ages past.

Cub 4: It's not all nature mud reveals: here's a candy wrapper and two toy wheels.

Cub 5: There's something moving-what's that now? I'll pick it up. A bee, oh!
Ow!

Cub 6: Quick, here's some mud upon the spot, to take away the soreness hot.

All: In mud there's stone and living things, healing power for bitter stings.
Through it flows the earth's lifeblood and evidence of a Creator. Our soil is really Magic Mud.

Cooperation
Faith
Positive Attitude
Resourcefulness
Respect
Responsibility

Compassion
Cooperation
Courage
Positive Attitude
Resourcefulness
Responsibility

LOST IN THE WOODS

(Santa Clara County Council Pow Wow Book May 2001)

Characters: Six Cub Scouts in uniform and a Martian. Adjust the number of Cub Scouts according to the size of the den.

Props: Lights, sound effects of a crash.

Scene: Wooded area, where several Cubs are sitting around.

Cub 1: Gee, I'm tired. I really think we're lost.

Cub 2: Yea, I wish we had stayed with _____ (Den Leader's name).

Cub 3: She was going too slow, looking at all those boring leaves.

Cub 4: Do you think we'll ever get out of these woods? We could be here forever.

Cub 5: Don't be silly. They'll organize a search party for us soon.

Cub 6: I sure hope so. I'm getting hungry and it's getting dark.

(Stage lights begin to dim and a light appears from offstage.)

Cub 1: Hey look! See the lights!

Cub 2: Yea, I see it. Looks like they've got a helicopter out looking for us. That's neat. Just like on TV.

All Cubs: (Jumping up and down, yelling and waving their arms.) Over here! Over here! Come help us! We're lost! Over here!

(More lights appear from offstage. A loud crash is heard.)

Cub #3: They've landed! Someone is coming through the trees over there.

(Points offstage.) and (Martian enters.)

Martian: Could you tell me how to get back to Mars? I was out exploring with my den leader, and I got lost!

(The skit can end here. For those who wish the boys get home safely, add:)

All Cubs: Well, we are lost too.

Martian: What should we do?

<p>LOST IN THE WOODS – Continued</p> <p>C Den Leader: Here you are. I was looking all over for you.</p> <p>Cub #4: We sure are glad to see you.</p> <p>Cub #5: Now we can go home.</p> <p>Cub #6: What about him? (Points to the Martian) He's lost too.</p> <p>Den Leader: No problem, just follow my directions; First go to our moon, turn left and go a couple of light minutes, then turn right followed by an immediate left. You'll find your home.</p> <p>Martian: Hey. That sounds right! Thanks.</p>	
<p>SUMMER IS BEGINNING</p> <p>Cub #1: Another summer is starting and we'd like to talk to you. We'd like to tell you what our purpose is, And what we hope to do.</p> <p>Cub #2: Pack ___ is a group of Cub Scouts. It helps us grow up strong. And teaches us to do what's right and fight against what's wrong.</p> <p>Cub #3: It shows us how much we can do, if we work as a team; then we'll have fun and jobs won't be as hard as they first seem.</p> <p>Cub #4: We'll go on hikes and field trips, to learn of nature's wonders, so we'll respect her when we're grown and not make any blunders.</p> <p>Cub #5: And we'll be shown in many ways that each man is our brother; and we will see the joy there is in helping one another.</p> <p>Cub #6: We'll learn to be good citizens and, hopefully, we'll see that laws are made for all the men so each man can be free.</p> <p>All: To do all this, the pack needs good leaders and Parents too, that means we need the help of all Of you -- and You -- and YOU!!</p>	<p>Citizenship Compassion Cooperation Faith Honesty Resourcefulness Respect Responsibility</p>



<p>Courage Health and Fitness Perseverance</p>	<p>THE TRAIN!</p> <p>Cast: 2 BOYS tracking animals, rest of den acts as TRAIN Props: 3 flashlights, other props as desired Setting: 2 boys are walking across the stage shining their flashlights on ground as if they're looking for something.</p> <p>Cub 1: Look! Bear tracks!</p> <p>Cub 2: There aren't any bears around here. These are raccoon tracks.</p> <p>Cub 1: Those are bear tracks.</p> <p>Cub 2: They can't be!</p> <p>Cub 1: I know what bear tracks look like and those are bear tracks.</p> <p>Cub 2: Raccoon tracks!</p> <p>Cub 1: Bear tracks!</p> <p>Cub 2: Raccoon tracks!</p> <p>(Boys grab each other and start to wrestle. As they are rolling around on the ground, the other boys enter making train noises the first one carrying a flashlight to simulate the headlight of the train. Boys stop wrestling.)</p> <p>Cub 1 and 2: (Look at each other and speak in unison.) Train tracks! (They jump up and start running as the train chases them offstage.)</p>
<p>Any Value</p>	<p>NO SKIT</p> <p>1st Cub walks on stage crying.</p> <p>2nd Cub enters and asks, "What's wrong?"</p> <p>1st Cub whispers in his ear, then the 2nd begins to cry as well.</p> <p>3rd Cub enters and asks, "What's wrong?"</p> <p>1st Cub whisper in his ear, then the 3rd begins to cry.</p> <p>This pattern continues until the last Cub enters and says, "Why is everyone crying?"</p> <p>The others answer, "We don't have a skit!"</p>

<p>THE MARKED TRAIL (Santa Clara County Council Pow Wow Book May 2001)</p> <p>Scene: All are approaching a mountain trail for a day hike.</p> <p>Den Chief: This sure is a good day for a hike.</p> <p>Cub #1: Sure is.</p> <p>Cub #2: Just right for walking in the woods.</p> <p>Cub #3: (Speaking to lagging Cub Scouts) Hurry up or you'll get lost.</p> <p>Cub #4: We don't want to miss a thing.</p> <p>Cub #5: I'm glad our Den Chief knows the trail.</p> <p>Cub #6: Why, do you think we could get lost?</p> <p>Cub #7: No, the trail is marked. Saturday hikers always mark the trail.</p> <p>Cub #8: Just like the pioneers and Indians, right?</p> <p>Den Chief: Not exactly. They drop candy wrappers, tissues, bandages and soda cans.</p>	<p>Health and Fitness Honesty Positive Attitude Resourcefulness Respect Responsibility</p>
<p>OUR 4 FATHERS Adapted from Boys' Life</p> <p>One Cub acts as teacher, others as students.</p> <p>TEACHER: Today class, we are going to learn about the American Revolution.</p> <p>More than 200 years ago, our forefathers defeated the British army in the Revolutionary war.</p> <p>STUDENT 1: They defeated the whole army?</p> <p>TEACHER: Yes!</p> <p>STUDENT 2: Our four fathers?</p> <p>TEACHER: Yes! Isn't that exciting?</p> <p>STUDENT 3: Yeah! They must have been really strong if it only took four of them to defeat a whole army!</p>	<p>Citizenship Courage Honesty Positive Attitude Respect Responsibility</p>

<p>Compassion Health and Fitness Resourcefulness</p>	<p>MOSQUITOES</p> <p>Cast: Any number of boys as Indoor Group, Outdoor Group and Mosquitoes Boys are out on a camping trip.</p> <p>Boy 1: Hey this is a good spot, let's pitch a tent here! (He goes out and gets two people from the audience to form a London Bridge type tent.)</p> <p>Boy 2: Oh, wow, that's great. (Other boys also make appropriate comments.)</p> <p>Boy 3: I'm ready for bed. I think I will sleep outside in the beautiful mountain air. You guys go ahead and sleep in the tent. I'm going to sleep under the stars. (Use "we" if more than one.)</p> <p>Indoor group: All right, go ahead, but don't bother us if you get scared.</p> <p>Outside group: Oh, we won't. It's going to be great!</p> <p>(All settle down to sleep when a giant band of mosquitoes come into camp. Mosquitoes have arms extended in front to represent stingers.)</p> <p>Mosquitoes: Buzz, buzz, buzz. Wow, a yummy meal. (Run over and attack boys sleeping outside.)</p> <p>Outside group: Help, help, we've been bitten by giant mosquitoes. (They all jump up and run in to wake up the others.)</p> <p>Indoor group: Oh, go back to bed. We told you not to bother us! (Boys go back to bed. Just when they get to sleep, the mosquitoes come back.)</p> <p>Mosquitoes: Hey, those guys were so yummy let's have another bite, buzz, buzz, buzz. (Run over and attack boys sleeping outside.)</p> <p>Outside Group: Help, help! We got bitten by the giant mosquitoes again. Let us sleep with you. (They all jump up and run in to wake up the others again.)</p> <p>Indoor group: No way. You sleep in here. We'll go out there. (Everyone agrees.)</p> <p>(Just as everyone is asleep the mosquitoes return. They go to bite the outdoor sleepers, then change their minds.)</p> <p>Mosquitoes: No, not them. We've got them twice already. Let's get the ones inside the tent. Buzz, buzz, buzz.</p> <p>Indoor group: Help! Help!!</p>
---	--

<p>DIRTY SOCKS (Santa Clara County Council Pow Wow Book June 1999)</p> <p>(About a 5 on the Gross chart.)</p> <p>Need: 4 Cub Scouts; one large can (gallon can) with water placed in the center of the stage; a pair of socks in the can; 3 mugs.</p> <p>Cub 1: (Walks to can carrying his mug. Dips his mug in and brings it up to his lips for a drink.) This camp coffee is getting worse!</p> <p>Cub 2: (Walks to can carrying his mug. Dips his mug in and brings it up to his lips for a drink.) This camp tea is getting worse!</p> <p>Cub 3: (Walks to can carrying his mug. Dips his mug in and brings it up to his lips for a drink.) This camp chocolate is getting worse!</p> <p>Cub 4: (Walks to can, dips his hands in and takes out a pair of wet socks and wrings them out.) I thought that would get them clean!</p>	<p>Any Value</p> <p>(Just for Fun)</p>
<p>KAYAK SKIT</p> <p>SETTING/PROPS: Two Cubs sitting in a (cardboard) kayak with double-bladed oars.</p> <p>CUB 1: Boy, it sure is pretty here, but I'm getting cold.</p> <p>CUB 2: Me too. (Peers into the distance.) It's too far to shore. Let's build a fire here in the kayak. That'll heat us up.</p> <p>CUB 1: Good idea. (They mimic building a fire, saying, "Aah, that feels good," etc.)</p> <p>CUB 1: (suddenly) Hey, we're sinking! (Both try to bail out water frantically, then turn to the audience.)</p> <p>CUB 1: Well, that just goes to show you.</p> <p>CUB 2: You can't have your kayak and heat it too!</p>	<p>Compassion</p> <p>Cooperation</p> <p>Honesty</p> <p>Positive Attitude</p> <p>Resourcefulness</p> <p>Responsibility</p>

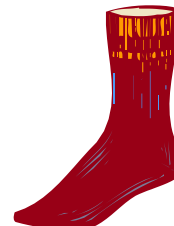
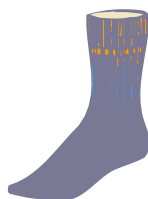

<p>Honesty Positive Attitude Responsibility</p> <p>(Just for Fun)</p>	<p>CUB SCOUT SOCKS</p> <p>CHARACTERS: Den leader, 3 Cub Scouts PROPS: A pile of socks on a table. Den leader sits behind table.</p> <p>DEN LEADER: Boys, I'm pleased to announce that our new Cub Scout socks have arrived! Please step up for your supply of clean socks.</p> <p>CUB 1: I need four pairs.</p> <p>DEN LEADER: What do you need four pairs for?</p> <p>CUB 1: I need them for Monday, Wednesday, Friday, and Sunday.</p> <p>DEN LEADER: O.K. Here are your socks. Next please.</p> <p>CUB 2: I need seven pairs.</p> <p>DEN LEADER: What do you need seven pairs for?</p> <p>CUB 2: For Sunday, Monday, Tuesday, Wednesday, Thursday, Friday, and Saturday.</p> <p>DEN LEADER: O.K. here are your socks.</p> <p>CUB 3: I need 12 pairs.</p> <p>DEN LEADER: Wow, you must really be a clean guy! So why do you need 12 pairs?</p> <p>CUB 3: Well, there's January, February, March, April...etc.</p>
<p>Resourcefulness Positive Attitude Perseverance Courage Cooperation</p>	<p>THE PAPER BAG SHOW</p> <p>Everything is good that comes in a Brown Paper Bag!</p> <p>Use 8-10 large paper bags, depending on how large your audience is. Go around and collect different items from them and place them in the bags (hats, ties, shoes, books, toys and other objects). If time is a factor, have the bags already prepared.</p> <p>Divide the boys up into groups of 3-4 depending on your numbers. Give each group of boys a bag and 5 minutes to come up with a short skit using as many items from the bag as they can.</p> <p>Present the skits.</p> <p>The audience can vote on which skit had the best use of their props, which one was the funniest, which had the biggest "hams". This can be used as an activity to take up the whole evening. Serve with a picnic for your Pack.</p>

<p>LOST MONEY</p> <p>Cast: Several Cub Scouts</p> <p>Setting: 1st Cub is circling around and looking down at the ground.</p> <p>2nd Cub: What are you doing?</p> <p>1st Cub: I dropped my money and I'm looking for it.</p> <p>2nd Cub: Well, I'll help you look</p> <p>(Other Cubs come up one at a time and ask</p> <p>1st Cub what he is doing. He tells them he lost his money and they agree to help look. Use as many boys as you would like.)</p> <p>Last Cub: What are you doing?</p> <p>1st Cub: I'm looking for the money I lost.</p> <p>Last Cub: Where did you lose it?</p> <p>1st Cub: Down the street by those houses.</p> <p>Last Cub: Then why are you looking for it here?</p> <p>1st Cub: Because this is where the street light is.</p>	<p>Cooperation Honesty Perseverance Positive Attitude Resourcefulness Responsibility</p>
<p>INVISIBLE DUGOUT BENCH</p> <p>CHARACTERS: 4 (or more) Cub Scouts.</p> <p>First boy is squatting as though sitting on an invisible bench. The second boy comes in and asks what the first is doing.</p> <p>"I'm sitting on the invisible bench."</p> <p>"Can I join you?"</p> <p>"Sure, there's plenty of room."</p> <p>Second boy pretends to sit. A third boy comes along, and the scene repeats. Go on for as many boys as you want. When the last boy comes along, asks and is answered, he says "But I moved it over there this morning!"</p> <p>"AAAAHHHHH!!!!" All seated boys fall down.</p>	<p>Any Value</p>

<p>Cooperation Courage Positive Attitude Resourcefulness Responsibility</p>	<p>HOW TO WASH AN ELEPHANT</p> <p>(Before introducing this stunt, choose three good-natured adults and have them led from the room. They must not overhear the narrator. The narrator then tells the following story and pantomimes the motions as he goes.)</p> <p>Narrator: One morning, Farmer Friendly went out to the barn to begin his chores. (Pantomime walking.) He threw open the barn door and imagine his surprise to find an elephant in his barn. (Pantomime opening door and seeing an elephant.) The farmer did not know what to do with the elephant, so he decided that the first thing he should do was to wash it. He led the elephant from the barn. (Pantomime picking up the elephant's trunk and walking with it over your shoulder.) He left the elephant near the pump, got a bucket and scrub brush and pumped the bucket full of water. (Pantomime actions.)</p> <p>Narrator: Now he was ready to begin, first he scrubbed the right side. (Pantomime scrubbing, lift up ear and wash.) Now he was ready for the stomach. (Lie on the floor and wiggle under elephant then scrub the underside.) Now the left side. (Repeat pantomime for left side.) He scrubbed the elephant's face. (Pantomime scrubbing between eyes and down the length of the trunk.) Almost done! (Walk to rear of the elephant, gingerly lift up tail and hastily scrubs rear.)</p> <p>Narrator: There, that's done. (Pantomime throwing out rest of water and putting brush in bucket and setting bucket beside the pump. Then take the elephant by his trunk, lead him back into the barn, open the barn door, lead the elephant in, go out, shutting the door behind you.)</p> <p>The narrator now tells the audience that he is going to call one of the persons back into the room and pantomime the stunt for him. He, in turn, will pantomime it for the next absentee, who will then pantomime it for the last person, who will then pantomime it for the audience. The Narrator calls in the first person.</p> <p>NOTE: Narrator pantomimes only! He does not explain what he is doing, so, of course, the absentee has no idea what the motions mean. The first absentee repeats what he can remember of the pantomime for the second absentee. Second absentee repeats what he can remember for the third absentee. By now, it is so distorted that it bears little resemblance to the original version and it is very funny indeed.</p> <p>The narrator congratulates them on a good job and tells them he will explain what they were doing after the meeting if they would like to know!</p>
--	---

<p>FIREWORKS</p> <p>A Cub Scout stands looking up into the sky.</p> <p>CUB 1: Ooh, ahh. . .</p> <p>CUB 2: (Walks up to Cub 1, looks up) What are you looking at?</p> <p>CUB 1: Fireworks! Want to watch with me?</p> <p>CUB 2: Yeah!</p> <p>CUBS 1 and 2: Ooh, ahh...</p> <p>CUB 3: (Walks up to Cubs 1 and 2, looks up) What are you looking at? (While Cub 1 continues "Ohh, ahh...")</p> <p>CUB 2: Fireworks! Want to watch with me?</p> <p>CUB 3: Yeah!</p> <p>CUBS 1, 2, 3: Ooh, ahh...</p> <p>CUB 4: (Walks up to Cubs 1,2 and 3, looks up) What are you looking at? (While Cubs 1 and 2 continue "Ohh, ahh...")</p> <p>CUB 3: Fireworks! Want to watch with me?</p> <p>CUB 4: Yeah! (Repeat until only one Cub remains)</p> <p>LAST CUB: (Walks up to group) What are you all looking at?</p> <p>ALL: Fireworks!</p> <p>LAST CUB: Those aren't fireworks, they're fireflies.</p> <p>CUB 1: Oh. I just thought they were really far away. (Walks off)</p>	<p>Citizenship</p> <p>Compassion</p> <p>Cooperation</p> <p>Honesty</p> <p>Positive Attitude</p>
--	--



<p>Cooperation Courage Health and Fitness Perseverance Resourcefulness Responsibility</p>	<p>SIT-DOWN HIKE</p> <p>The leader explains that he is taking the group on a hike. They are to do as the leader does and say what the leader says. In the following, the lines are repeated twice at first to show the audience participation. Throughout, the audience should repeat all lines and do all the actions.</p> <p>LEADER: Do you want to hike in the mountains?</p> <p>GROUP: Do you want to hike in the mountains?</p> <p>LEADER: All right, let's go.</p> <p>GROUP: All right, let's go.</p> <p>LEADER: Let's start walking. (Makes walking sounds with feet on the floor.)</p> <p>GROUP: (Repeats above words and actions; continues to repeat leader's words and actions throughout the story.)</p> <p>LEADER: We'll have to cross a bridge. (Hits palms on thighs to sound like feet on a bridge.)</p> <p>LEADER: Here we are across the bridge, and horses are waiting to take us up the steepest part of the mountain. (Holds "reins" with hands, bounces up and down on chair while making a clucking sound with tongue against roof of mouth to sound like hoof beats.)</p> <p>LEADER: This is the end of the horse trail. We'll hike from here to the glacier. (Make walking sounds with feet on the floor.)</p> <p>LEADER: Oh, dear, we've run into a swarm of mosquitoes. (Start slapping face and neck, and scratching.)</p> <p>LEADER: Let's walk faster and get away from these mosquitoes. (Walking sounds speed up.)</p> <p>LEADER: See over there? There's our glacier. (Shade eyes with one hand and points with the other.)</p> <p>LEADER: Let's run. (Makes running rhythm, slapping hands on thighs.)</p> <p>LEADER: And now for some fun: we'll slide down the glacier. (Give a whooshing sound ending with "Wheee!")</p> <p>LEADER: We came down a lot faster than we went up. Keep tramping - we will soon be back home. (Walking sounds become softer and softer then stop.)</p>
--	--

<p>CAMPING WITH SHERLOCK HOLMES By David Laredo</p> <p>Two Scouts play roles of Sherlock Holmes and Dr. Watson as they sleep under the stars.</p> <p>HOLMES: Watson, what do you see?</p> <p>WATSON: Why Sherlock, I see millions and millions of stars.</p> <p>HOLMES: Yes, but what does it MEAN, Watson?</p> <p>WATSON: Well, I suppose it means the sky is clear, it won't rain, and tomorrow will be a good day.</p> <p>HOLMES: Yes, but does it mean anything else?</p> <p>WATSON: Well, I suppose that with all those stars, there is the possibility of other life, even other intelligence. Perhaps some creature is lying on some planet looking at us.</p> <p>HOLMES: Interesting. But does it mean anything else?</p> <p>WATSON: Well, the majesty of the stars brings to mind the awe of life. In some ways, the heavens are evidence that we are not alone in the universe. Uh, Sherlock, what does this all mean to you?</p> <p>HOLMES: Somebody stole our tent.</p>	<p>Courage Honesty Positive Attitude</p>
<p>ROW HARDER!</p> <p>Four Cubs sit on the floor and pretend to be on a boat rowing together. Another Cub stands at the front of the boat and yells "Harder men! Row harder!" One of the rowing Cubs says "Captain! Captain!" The captain says "Not now Johnson, I am busy!" Captain then returns to looking worried and saying "Row harder men, row harder!"</p> <p>Once again the Cub yells "Captain! Captain!" The captain says "Johnson! I said BE QUIET!" The Cubs continue rowing for a few seconds. And then the Cub tries one more time "Captain! Captain!" The Captain yells "What Johnson, WHAT?" The Cub then says "Do you think I should untie the boat from the pier?"</p>	<p>Cooperation Courage Health and Fitness Perseverance Respect</p>

<p>Any Value</p>	<p>RIDDLES</p> <p>Use as many as you need for each Cub in den or pack. Boys can run on the stage two at a time, one asking the question and the other answering. Or, have the boys draw a poster of the answer, ask the question to the audience, then display the poster for the answer.</p> <p>What has a face but no mouth? A clock. What has legs but can't walk? A table. What has eyes but can't see? A potato. What has a head but no hair? A pin, nail or hammer. What has teeth but can't eat? A comb. What has an eye but never sees? A needle. What has hands but no fingers? A clock. What has a mouth but can't talk? A river. What ear can't hear? Ear of corn. What keeps the moon in place? Its beams. What can run but can't walk? Water. When will a net hold water? When it turns to ice. What has 18 legs and catches flies? A baseball team. What can fall down and never get hurt? Snow. What is the best way to keep a skunk from smelling? Hold its nose. What do we often return but never borrow? Thanks What kind of coat should be put on when it's wet? A coat of paint. What has a foot on each end and one in the middle? A Yardstick. What is bought by the yard and worn by the foot? Carpet. What can a person wear that never goes out of style? A smile. Why is a joke like a coconut? It isn't any good until its cracked. Can you drop a full glass and spill no water? Yes, when the glass is full of milk. Why does a hummingbird hum? Because it doesn't know the words</p>
<p>Cooperation Honesty Positive Attitude Resourcefulness</p>	<p>ICE FISHERMAN</p> <p>Two men are fishing through a hole in the ice, but are having no luck. A boy fishing through a nearby hole keeps pulling in one fish after another. The men ask is they might trade places, but still the men have no luck, while the boy continues to catch fish. One man asks the boy what his secret is. The boy mumbles an incoherent answer. The man can't understand him, ask boy to repeat answer. Finally the boy spits something into one hand and repeats loudly: "You've got to keep your worms warm!" (Works great with gummy worms!)</p>

PLANNING FOR THE FUTURE

(Baloo's Bugle April 2000)

Setting: An old man is digging in his garden. Beside him on the ground is a young sapling tree, which he is preparing to plant. Two men come up to him, stop, and watch what he is doing.

Man #1: What kind of tree are you planting?

Old Man: (Stops digging and wipes his brow) It is an apple tree.

Man #2: (astonished) AN APPLE TREE? Well, how old are you?

Old Man: I'm 90 years old.

Man #1: You're 90 years old! And you're planting a tree that will not give fruit for many years?

Old Man: Why not?

Man #2: Well, you'll probably not be around when that tree finally bears fruit.

Old Man: Tell me, did either of you eat any apples when you were little boys?

Both: Of course we did. Why?

Old Man: Then tell me this - who planted the trees that you got those apples from?

Man #2: Well it must have been, HMMM?

Man #1: I don't know.

Old Man: You see, someone planted the trees before you were born for you to enjoy and now I'm doing the same for those who come after me. How else can I repay those who planted trees before I was born?

Man #1: You are a very wise man.

Man #2: And we have been very foolish.

Old Man: Thank you, and remember that what we do for our land today will be around for many years from now. So make sure you leave something that you will be proud of in the future.

Citizenship
Compassion
Cooperation
Courage
Positive Attitude
Respect
Responsibility

<p>Compassion Cooperation Faith Honesty Respect Responsibility</p>	<p>CUB SCOUT GARDEN</p> <p>You will need large pictures of peas, lettuce and squash and word strip descriptions as indicated below. Cubs can read their word strip at the appropriate time, if desired. If your den or pack is small, the word strips can be displayed by the boys, then hung on a wall or large poster board.</p> <p>LEADER: <i>(Enters holding a garden tool, such as a hoe.)</i> Today I will plant my Cub Scout Garden. First, I will start with five rows of peas.</p> <p><i>(Boys enter carrying word strips and picture of peas. Display each word strip as the leader says the words.)</i></p> <p>LEADER: My rows of "P's" are: preparedness, promptness, perseverance, politeness, and praise.</p> <p>Now I will plant my five rows of lettuce.</p> <p><i>(Boys enter carrying word strips and picture of lettuce. Display each word strip as the leader says the words.)</i></p> <p>LEADER: My rows of "Let us" are: Let us be faithful, Let us be unselfish, Let us be loyal, Let us be truthful, Let us help one another.</p> <p>LEADER: Now I will plant my three squash plants.</p> <p><i>(Boys enter carrying word strips and picture of squash. Display as above.)</i></p> <p>LEADER: My squash will: squash impatience, squash criticism, squash indifference.</p> <p>LEADER: We need the help of everyone in our pack to make our garden grow.</p>
---	--

<p>Compassion Cooperation Honesty Perseverance Resourcefulness</p>	<p>MEASUREMENT PROBLEMS</p> <p>Two Webelos Scouts carry a long pole on stage and prop it up.</p> <p>WEBELOS 1: Now, there are several ways we can figure out the height of this pole. How do you want to start? (They unsuccessfully try various methods of estimation.)</p> <p>WEBELOS 1: According to my calculations, that pole is about 6 feet high.</p> <p>WEBELOS 2: There's no way! It's shorter than that! Just look at it! (They continue arguing, becoming more exasperated.)</p> <p>CUB: (Enters, watches a bit.) Hi! What are you guys trying to do?</p> <p>WEBELOS 1: We're trying to measure the exact height of this pole.</p> <p>CUB: Why don't you lay it down and measure the LENGTH with a measuring tape?</p> <p>WEBELOS 1: (scornfully) Cubs!</p> <p>WEBELOS 2: I'll say. (To the Cub) Didn't you hear right? We want to know how TALL the pole is, not how LONG it is! (Cub shrugs and exits.)</p>
<p>Cooperation Perseverance Positive Attitude</p>	<p>YA-POO-CHA</p> <p>Boy stands and addresses pack, telling of the great solar happening of Ya-Poo-Cha. (Make up a bunch of stuff about stars/planets/earth alignment, etc... make it sound good.)</p> <p>Each Cub comes up, one at a time, and asks "is it Ya-Poo-Cha" time yet?"</p> <p>The first Scout says "Not yet young man, please wait quietly", (he has them stand in a circle with him.)</p> <p>When the final Cub is in line, the leader says "Finally, Ya-Poo-Cha time has arrived. Are you ready?"</p> <p>Cubs answer "Yes!"</p> <p>Leader - "ah-1, and ah-2, and ah-3.... (all Cubs join in) Ya-Poo-Cha right hand in, Ya-Poo-Cha right hand out, Ya-Poo-Cha right hand in and Ya shake it all about.....etc, etc You can get everyone to join in once you finish the first round</p>

GRAPES

Items needed: webbed feet/flippers and a phony disguise, like silly glasses with a nose and mustache.

(Duck walks up to the store clerk)

DUCK: Got any grapes?

CLERK: No. Sorry.

(Duck smiles, walks out the door, pauses a minute and walks back in)

DUCK: Got any grapes?

CLERK: I already told you no!

(Duck smiles, walks out the door, pauses a minute and walks back in)

DUCK: Got any grapes?

CLERK: No! I still don't have any grapes!

(Duck smiles, walks out the door, pauses a minute and walks back in)

DUCK: Got any grapes?

CLERK: No! We didn't have any. We don't have any and we are not going to have any. If you come back in here again, I will nail your webbed feet to the floor!

(Duck smiles, walks out the door, pauses a minute and walks back in in a phony disguise)

DUCK: Got any nails?

CLERK: No.

DUCK: (takes off disguise) Good. Got any grapes?

CLERK: AAARRGGGHHH (runs out screaming)

Compassion
Courage
Honesty
Perseverance
Positive Attitude



Cub Scout

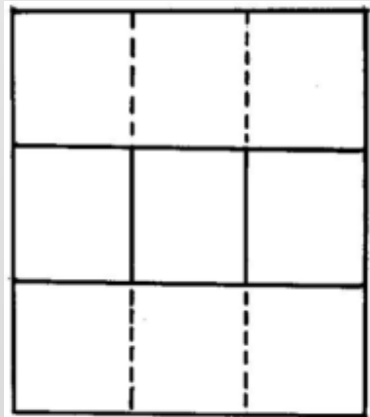

Cut along all dotted lines.



Crafts

Crafts can be an important part of Cub Scouts. Boys like the satisfaction that comes from learning to make and build something with their own hands. It gives them something to show off and its FUN too. Some boys' fine motor skills are better developed than others so be aware and don't make something that is too hard or too detailed for the boys. When planning a craft for Pack Meeting be sure to have something easy enough for little brothers and sisters to do or at least get to help with also. Crafts should be fun, challenging and not too hard or too easy.

CRAFT STICK FISH

From: Look What You Can Make With Dozens of Household Items!" Edited by Kathy Ross, by Boyds Mills Press.

Items needed:

Colored craft sticks,
googly eyes,
glue

Glue two craft sticks together at one end, fanning the opposite ends out. Glue three sticks underneath the top stick and parallel with the bottom stick. Add three dots of glue, 1 inch apart, to the top of those sticks. Place three sticks into the glue, forming a crisscross pattern. Place one more stick across the entire pattern. Glue on a googly eye.

If you want to hang your fish, glue on a piece of yarn

Variation: To make a fishy neckerchief slide, use mini colored craft sticks, and glue a piece of rubber tubing on the back for the slide.

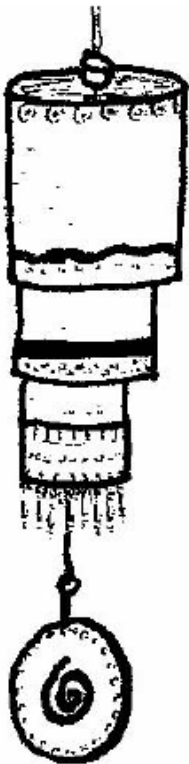
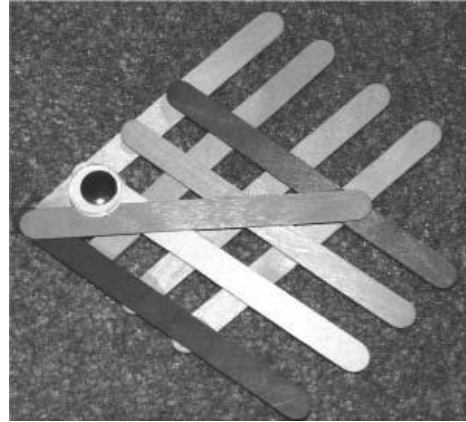

FOOD CAN WIND CHIMES

Items needed:

3 food cans (in graduated sizes)
assorted beads
spray paint (various colors)
clear acrylic spray sealer
nail

one lid from can
white primer spray
paint-brushes
hammer
heavy gauge craft wire pliers

Apply primer to cans and both sides of can top. Spray cans and top, desired color(s).

Use acrylic paint, to paint designs on cans if desired. (i.e. stripes, dots, wavy lines and spatter paint.) Apply two to three coats of sealer to cans and top.

Use hammer and nail to punch holes at 1/2" intervals 1/4" from rim around open edge of smallest can, one hole in center bottom of each can, and one hole 1/4" from edge in can top.

For hanging beads, thread several beads onto wire and secure. Thread through holes in the small can, bend wire to secure to can. For clapper, thread 2" of wire through hole in can top. Twist wire end to secure. Thread several beads onto wire. Working inside to outside, thread wire through bottom of smallest can. Mark wire at desired placements for top of can; remove can. Thread one

bead onto wire. Holding bead on wire where marked, wrap wire around and back through bead (as shown) Replace can over bead. Repeat to add medium and large cans on wire. Thread two beads onto wire. For hanger, bend wire end into a loop.

HOME-MADE MUSICAL INSTRUMENTS

MARACA

Items needed:

balloon (water balloon size)	paper mache glue
newspaper strips	1/4 inch dowel

Blow up the balloon to about the size of a grapefruit and cover with newspaper dipped in paper mache glue. Let dry. Punch two 1/4 inch holes in the paper mache. Insert a few pebbles, dried beans or rice. Insert the dowel handle into the holes and glue the dowel in place.

CASTANETS

Items needed:

nails or glue	bottle caps
stiff cardboard	

Nail or glue bottle caps to a piece of folded, stiff cardboard. Play by clicking the caps together.

CYMBALS

Items needed:

2 pie plates	1/2 inch wood screws
small piece of wood	

Screw a 1/2 inch screw into the back of plate then into a small piece of wood for a handle. Hit the plates together to create sound.

TAMBOURINE

Items needed:

nail and hammer	12 bottle caps
ice pick	large darning needle
4 heavy paper plates	yarn or heavy string
colored ribbon or feather	

Set four heavy paper plates one inside the other. Punch holes, 1 1/2 inches apart, around the rim of the plates. Place two plates (one inside the other) face to face with the other two plates.

Lace and tie the plates together with yarn or heavy string.

With a nail and hammer, punch holes in the centers of twelve pop bottle caps. String the bottle caps, four to a group, on heavy string or yarn. Tie groups of bottle caps to the tambourine so they will jingle.

Paint or color the tambourine with bright designs. Then tie streamers of ribbon or feathers to the rim as a final decoration.

Shake the tambourine and beat it with a closed fist.

TIN CAN BIRD FEEDER

Items needed:

large juice can (with top removed)
 enamel paint and paintbrush
 2 aluminum pie tins
 3' of clothesline
 hammer and large nail
 beverage can opener

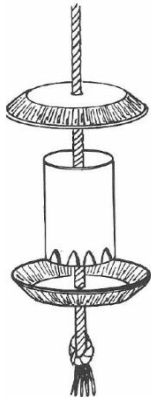
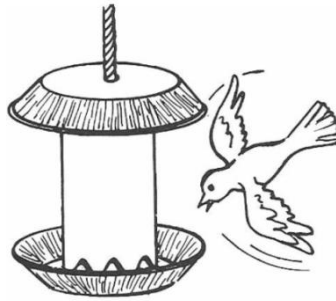

Paint the juice can in the color(s) of your choice. When it is dry, punch a large hole through the middle of the bottom of the can, using the hammer and nail. Create a series of openings around this same end (bottom) of the can using the beverage can opener. This is where the bird seed will come out. Punch holes in the middle of the two pie tins, using the large nail and hammer. Now, tie a knot in the end of the clothesline and run the rope up through one pie tin, the juice can, and finally the other pie tin. See illustration for details.

Fill the can with birdseed by lifting up the top pie tin and pouring it in the open end of the can. Hang it in your yard or on an open porch. Enjoy the birds that visit.

HOVERCRAFT

Items needed:

plastic lid from a cottage cheese container
 push-pull squirt cap from a bottle of dishwashing liquid
 12" round balloon
 Scissors
 glue



Cut a hole $\frac{3}{4}$ inch in diameter in the center of the plastic lid from the cottage cheese container. Center the push-pull squirt cap over the hole and glue it to the lid, with the lid's writing facing up. Use enough glue so that no air spaces are left between the plastic surface of the cap and the plastic of the lid. Let the glue dry completely.

Blow up the balloon and slip the opening of the balloon over the opening of the closed squirt cap.

Place your craft on a smooth surface, such as a table top, or you can launch it in water. Lift the squirt cap opening so that the air escapes from the balloon. Your hover craft will glide effortlessly.

CAPS ON! CAPS OFF! CLIPPER!

(DesPlaines Valley Council, Baloo's Bugle Nov. 2000)

Materials:

Wooden yard stick

5 wooden clothes pins

Wood glue or glue gun

Markers



1. Glue one clothespin at each of the 6", 12", 18", 24", and 30" marks. Use either wood glue (for greater strength) or hot glue (for faster drying time) depending on your needs. Body of pins should line up on the centerline of the stick. Jaws should line up with numbers.

2. Paint or draw a funny face on each pin.

3. Clip a baseball cap at each pin and hang on wall.

Tips: This is very popular with boys because it is both practical (holds five baseball caps) and fanciful (chomping monster faces). They can be made quickly if no decorating is done. Some boys will really get into painting and decorating the faces so allow time for it. Be sure the pins are glued down so that jaws are at opposite end of stick from the hanging hole or the chomping monsters will be hidden by the caps when the stick is hung on a wall.

Other ways to use this idea:

You could turn it into a card holder for Christmas or Valentine's day just by decorating it for that holiday. Or it could be a mother's day gift by turning it into a picture holder. Alternate the clothes pins facing left and right and place them every 3 inches. Have spots for a small school photo and write "watch me grow" above it. Then they could place their Kindergarten picture on the bottom, then 1st grade above that, 2nd above that etc... A grandparent might like this too.

SHOOT FOR THE STARS

These stars are great for Blue and gold banquet centerpieces.

Items needed:

Plaster of paris

Glue

One 2 or 3 liter pop bottle

Yellow or gold spray paint

6 coat hangers

Blue construction paper

Yellow or gold foil paper

Cut pop bottle half way down. Spray with paint and let dry. Cut coat hanger wire into four 10" pieces and two 12" pieces. Cut four strips of paper 10" long and 1 1/2" wide, and two strips of paper 12" long and 1 1/2" wide. Glue paper onto the wire covering both sides of wire.

Mix plaster of paris with water according to package directions. Pour plaster of paris into bottom of bottle and place long wires in the middle and short ones on the outside. When plaster has set up, cut stars out of foil and glue onto end of wires. Add a ribbon around bottle, if you'd like.

SPARKLE AND SHINE JOB JAR









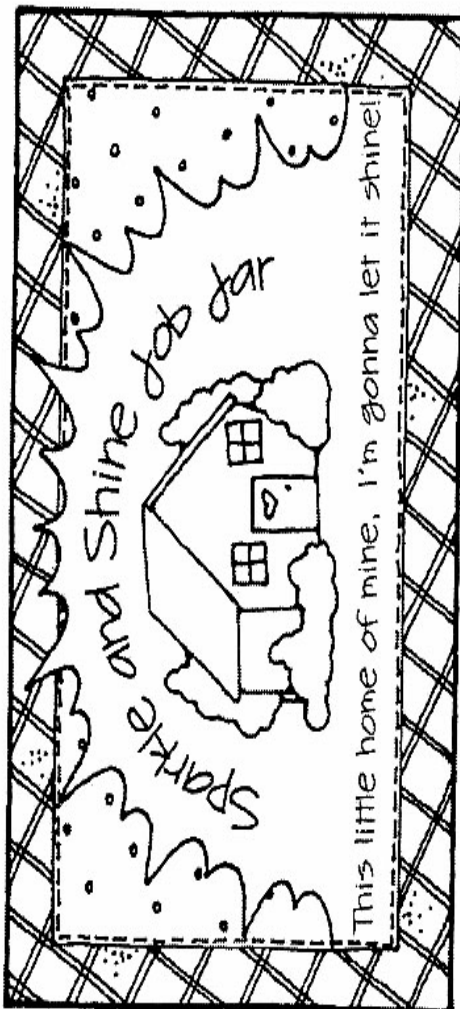



























Make a Sparkle and Shine job jar and fill with jobs. Then draw at least five jobs from the jar and complete them.

To make job jar:

Copy, color and glue the Sparkle and Shine Job Jar label on a jar or put it all in a plastic bag. Cut up jobs strips or have your parents create some jobs to place in the jar.

Work with your family each day to make your home sparkle and shine.



Dust an entire room.		Clean one toilet inside and out.	
Shine two mirrors.		Wash all light-switch covers.	
Dust all pictures in the house.		Empty the trash in three rooms.	
Wash mopboards in one room.		5-minute cleanup on 4 rooms.	
Clean two windows.		Wash sinkful or batch of dishes.	
Wipe off five window sills.		Put 25 things away.	
Wash all doorknobs.		Sweep all the floors.	
Sweep the front and back steps.		Mop the bathroom floor.	
Vacuum all the stairs.		Fold & put away 3 batches of laundry.	
Clean all sinks in house.		Iron for 30 minutes.	
Sweep and vacuum entry.		Clean and organize a drawer.	
Straighten all clothes in a closet.		Wash all the spice containers.	
Clean a closet shelf.		Shake all the rugs.	
Shine three pairs of shoes.		Help make a plan for family's work.	
Sweep one-half of the garage.		Shine one shelf in refrigerator.	
Clear a cluttered countertop.		Find and match all odd socks.	
Clean & organize under a sink.		Help Mom or Dad for 30 minutes.	
Unload and load the dishwasher.		Polish a piece of furniture.	

FAMILY TREE

Items needed:

- A rock about the size of a cantaloupe or a piece of driftwood (referred to as base)
- 18-gauge wire or larger (Remember - the lower the gauge number the thicker the wire. The amount of wire will vary depending on the size of the boys' family and the size of the rock or driftwood.)
- needle nose pliers
- family photos or names of family members written on cardstock

Measure around your base
Add about 8 inches to both
of wire according to these

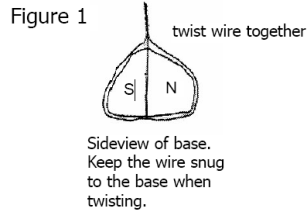

both lengthwise (n-s) and widthwise (e-w).
those measurements and cut two lengths
measurements.

Take these two pieces of wire and place them along their correct line (n-s, e-w), twist all ends together at the top center leaving about 1" straight. (Figure 1)

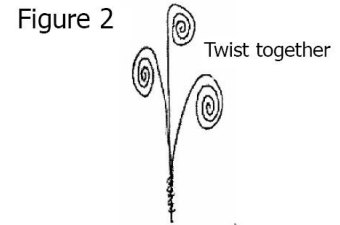

You will need to cut additional wire at varying lengths, depending on number in your family. With needle nose pliers, begin by taking one end

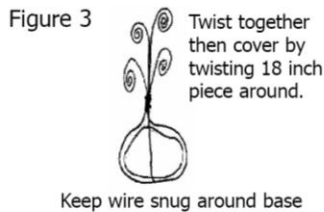

and make a spiral. Continue making about 1-2" spiral. If the wire is soft enough this may be easier to do with your fingers. (Figure 2) Set each aside and continue with other wires until you have enough spirals for each member of your family, each with different length stems.

Once all these wires are done, twist one wire around all of them to make a single stem. Attach to base wires by twisting 1" wires around stem. Take 18" of wire and wrap it around the stem to conceal your connections. (Figure 3) Place photos or names of family members in the spirals. May be attached permanently with thin wire or thread.

SEED MOSAIC

From 838 Ways to Amuse a Child

On a square piece of cardboard draw a simple scene or a design. Get a variety of seeds (sunflower seed, barley, wheat, and birdseed, for example) from a pet or feed store. Be sure they are packaged separately. Only a handful of each kind is necessary.

With a layer of glue, coat all parts of the design to be covered with one type of seed. Arrange large seeds individually, or sprinkle small ones. When this is dry, repeat with another part of the design, and so on until it is covered.

Variation: This same type of thing can be done with pasta, or colored sand.

FIRE EXTINGUISHERS

Items needed:

Small clear plastic containers with snap-on lids
Labels
Baking soda
Spoon
Large bowl
Pan

Have the boys fill their containers with baking soda. They can use the spoon and hold the container over the large bowl.

Snap the lids securely onto the containers. Print "Fire Extinguishers for Grease Fires" on the labels and attach them to the side of the container.

Discuss with the boys about using the extinguishers in case of a grease fire. Make sure they know never to use water on a grease fire. Have the boys take their fire extinguisher home and put it in the kitchen or by the grill where they will be handy in case of a fire.

SUPER SCOOPS/ BALL CATCHERS

Give empty bleach bottles or empty milk jugs a purpose!

Cut off the bottoms, and then cut out the side portion below the handle, angling down toward the bottom. You can then use the scoops for tossing and catching balls or bean bags.

NOISE MAKERS

Items needed:

Empty toilet paper rolls
Bells, rice, beans, etc.
Packing tape
Construction paper
Stickers, markers, crayons, etc.

Tape one end of tube with packing tape. Fill a third full of noise-making items (bells, rice, beans, etc.). Tape other end shut. Wrap in construction paper and decorate with stickers, markers, crayons, etc.

COLORING PAGES

Having pictures and crayons or markers is always a good stand by. Especially near the holidays.

FRIENDSHIP BRACELET

(Santa Clara County Council Pow Wow Book Nov. 2003)

Materials: For each, you will need two pony beads and a leather lace.

Step 1: Cut lace 5" longer than measurement around wrist. Trim lace ends at an angle.



Step 2: Tie a knot in one end of the lace. Thread on 2 pony beads.

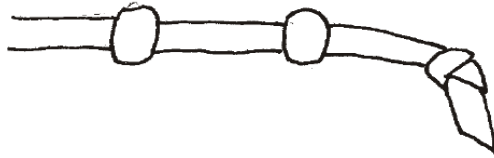

Step 3: Thread the other end of the lace through the beads from the opposite direction. Tie a knot in this lace end. Adjust size of bracelet by pulling on knotted lace ends.

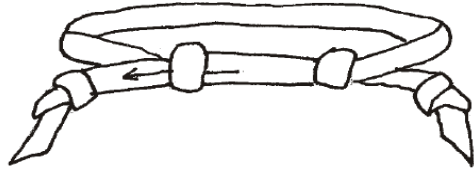

PAINTED POTS

Use tempera paints to paint clean, dry terra cotta pots. Themes could be Cub Scouting, Mother's Day, gardening or free style abstract designs. After the pots have dried, fill with potting soil and plant seeds or a small plant.

EGG HEADS

Material needed:

- 6 eggshells, clean, with the top third of the shell removed,
- Potting soil
- Alfalfa seed
- Markers

Draw a face on the outside of the egg with the markers. Carefully fill the eggshell half full of potting soil. Sprinkle alfalfa seeds in the dirt. Water lightly. Wait and watch the eggs, watering them each day, and soon you will have eggheads with green hair.

BASKET MOBILE

Materials needed:

Styrofoam egg carton
Scissors
Yarn
Seedlings or flowers
Plastic ring cut from bleach or milk jug

Cut cups from the Styrofoam egg carton. Poke two holes opposite each other near the top of each egg-cup and tie on a yarn handle. Suspend the yarn from the plastic ring. Fill the baskets with seedlings or flowers. The egg-cups will hold water and keep the flowers fresh. Suspend the mobile from four pieces of yarn attached to the top of the plastic ring.

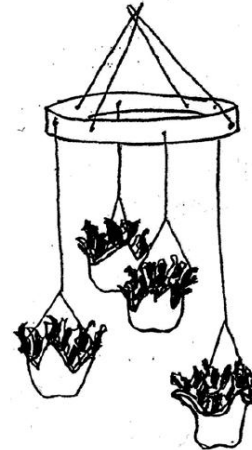

BALLOON LAUNCHER

Materials:

Scissors
Plastic lid (like from butter or cottage cheese container)
Push/pull squirt cap (like from dishwashing liquid bottle)
Glue
Round balloon

In the center of the plastic lid, cut a round hole $\frac{3}{4}$ inch in diameter. With the lid's writing facing up, center the squirt cap over the hole and glue into place. Use enough glue so that no air can escape. Allow glue to dry completely. Blow up a round balloon and slip the opening of the balloon over the opening of the closed squirt cap. Place your creation on a smooth surface. Lift the squirt cap opening so that air escapes from the balloon. Your launcher will glide effortlessly!

SELTZER ROCKETS

Items needed:

Empty Film canisters lids that snap inside work best – not the ones where the rims snap on around it)
Alka-Seltzer tablets (generics work too)
Permanent markers (if decorating)
Water

Decorate the outside of the canisters if desired. Fill film canister $\frac{1}{4}$ full with water. Drop in half a seltzer tablet, snap on the lid, and set it on the ground, lid side down. Do this fast and back up! Watch your rocket soar! The boys really love this and could do it for hours!

HOMEMADE TOP

You will need:

eight or 10 paper or plastic plates (9" or 12")
 a sharpened pencil
 two 1 inch sewing thread spools
 and two rubber bands.

To avoid leaving a trail of pencil lead marks,
 you could use instead a pencil thick dowel,
 pointed at one end by a pencil sharpener.

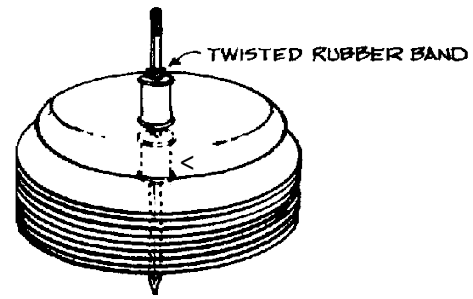

Find the exact center of the plates by balancing each one on the pencil's eraser head. Use a knife or scissors to cut small hole in the centers. Slip all plates on the pencil and push together low on the pencil. Slip the spools on the pencil above and below the plates. To hold the spools snug, twist rubber bands against them. Decorate top as desired.

LAUNCHING WITH RIBBONS

Wrap two 12 inch ribbons, one on top of the other, around the top's axle. Wind until two or three inches remain free. Keep the top vertical and pull the loose ends of the ribbons in opposite directions to set the top spinning.



TIN CAN LANTERN

Materials:

Large tin cans, label removed
 Markers
 Towel
 Hammers
 Nails
 Small screw-in hook
 Stick or wooden dowel (about 20" long)
 Coat hanger (for hanging loop)
 Votive candle

Fill cans with water and freeze for two days. (The ice keeps the sides from collapsing while hammering.) On the outside of the can, have Cubs draw a pattern for the lantern holes. Place can on its side on top of a towel and use the nail tips to hammer in holes according to the design. Make two holes near the top on opposite sides for stringing a handle. Remove any ice chunks from can. Screw hook into one end of stick or dowel then string length of wire through hook. Thread wire through handle holes made in can. Crimp closed until secure. Use melted wax to stick votive to bottom of can. Use a long match or spaghetti noodle to light.

MARBLE RACER

Materials:

- paper
- Paste/tape
- Small marble

Copy the image below onto paper. Fold flaps toward the center strip. To form the sides, place flaps together and paste. Insert the marble between the sides then paste ends together to form a bean-shaped roller with the marble inside. To operate the racer, release it on an inclined flat surface. Use carpeting on the surface for better traction. The racer will roll down end over end in an erratic motion. They are very fun to race and to watch. If they want to color/decorate them it's easiest to do so before cutting them out.

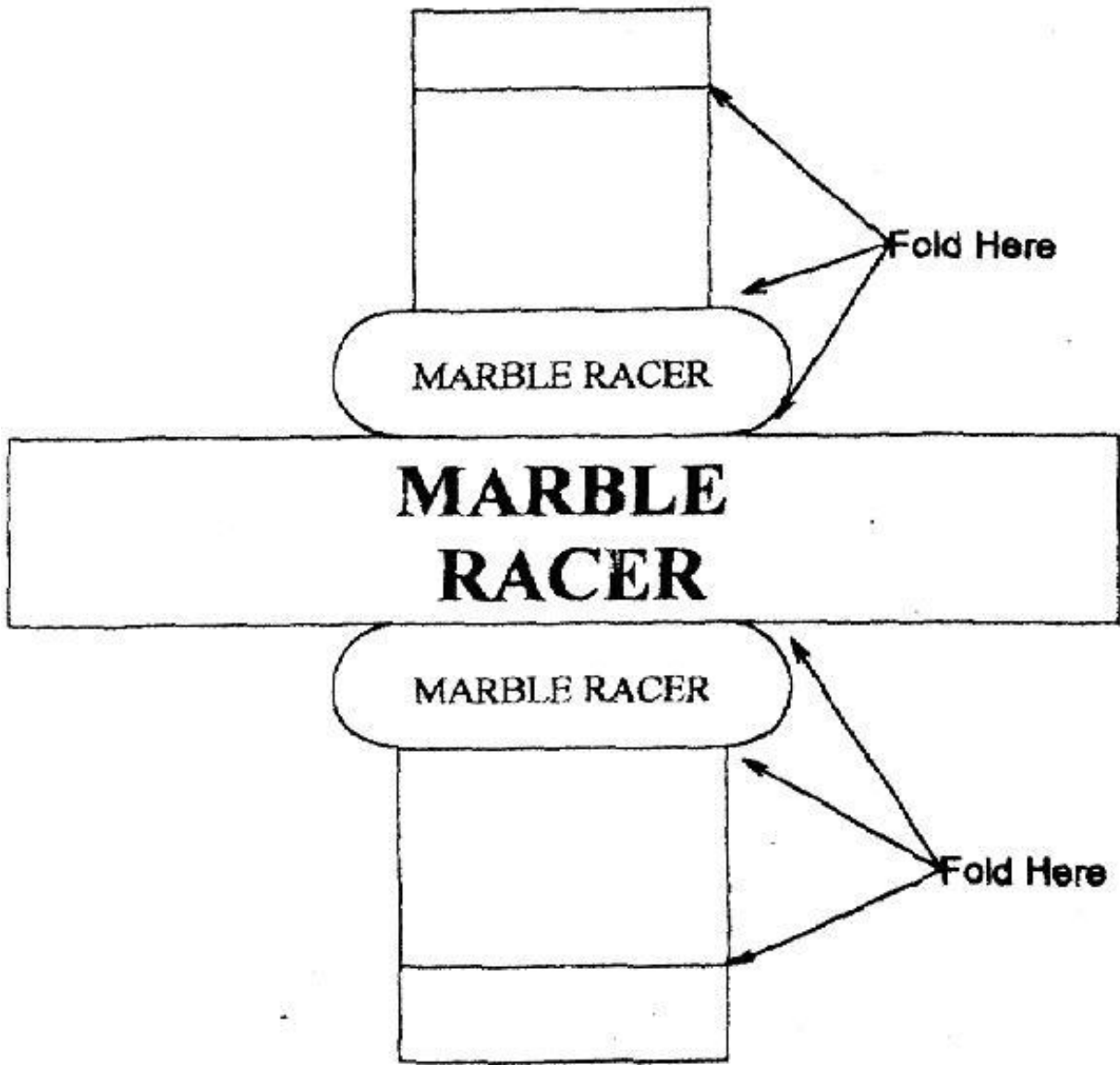

POPSICLE STICK FRAMES

Items needed:

Eight clean Popsicle sticks Scissors
 Paint or magic markers Pencil
 Tacky craft glue Cardboard (use an old cereal box)
 Yarn (if you want to hang your frame)

Photograph of yourself that it is okay for you to cut (get permission!)

Magnet (if you want to put your frame on a refrigerator or a filing cabinet)

Any items to decorate the frame:

sequins, buttons, construction paper, yarn, stickers, nuts and bolts, fishing lures, buttons, ribbons, tiny fake flowers, golf tees, puzzle pieces, lace, stamps, wrapping paper, fabric, magazines, etc.



Arrange the Popsicle sticks as follows:

Put two side-by-side vertically (up and down). Put two more (arranged the same way) next to them.

Take the photograph and slide the edges under the four sticks so that neither of the sides (right or left) show. Place two more Popsicle sticks, side-by-side, so that the top edge is covered.

Do the same with the bottom edge using the last two sticks. (The top and bottom parts will cross over the side parts of the frame.) Use the pencil to lightly mark where the frame will attach. You may need to trim the picture if it is too big. Use the glue to put the frame together. Let it dry overnight.

While you are waiting for the frame to dry, put the picture on a piece of cardboard and trace around it. Trim the cardboard to be just a little larger than the picture (about 1/4" all the way around). Glue the picture to the center of the cardboard. Decorate the frame using paints or markers. Let that dry (if you used paint) and then further decorate it with the items you've collected. Once the frame is dry (paint or glue), glue the picture to the frame. If you want to hang the frame, glue a 4" piece of yarn to the back of the frame. (Glue one end to each top corner.) If you would rather it be a magnetic frame, glue a magnet to the back. You can also make a stand using a stiff piece of cardboard. Cut a 4" by 2" rectangle. Bend the cardboard at one end about 1/2" from the top. Glue the bent part to the back so that the frame can stand up (you may need to trim it a little if it's too long.) Wrap it up, and give someone a special Surprise!

HOLIDAY TREAT HOLDERS

Fold a square piece of paper in thirds one direction-then the other. This will result in 9 squares. From two of the sides, cut 1/3 of the way in (until you reach the cross-ways fold) along both of the fold lines. Fold in the sides and glue or staple to create a square basket. The larger the piece of paper the larger the end box will be. Decorate the sides for the season (does not have to be Christmas) and add a paper handle if you want make it a basket. Note – Decorating may be easier to do while it is still flat.

Fill it with candy and/or nuts. The finished products can be given to a senior center or soup kitchen.

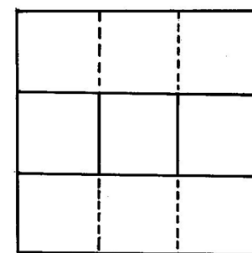

Cut along all dotted lines.



MARBLE RACEWAY

Materials:

paper tubes (toilet paper, paper towels, wrapping paper)
sharp scissors or small saw or serrated knife
tape
marbles
pencil

Gather together as many paper tubes as you can find. The tubes can be all different lengths but they should all be about the same diameter. The marble raceway is assembled in any configuration you like using components made from the straight connectors, angle connectors, and chutes.

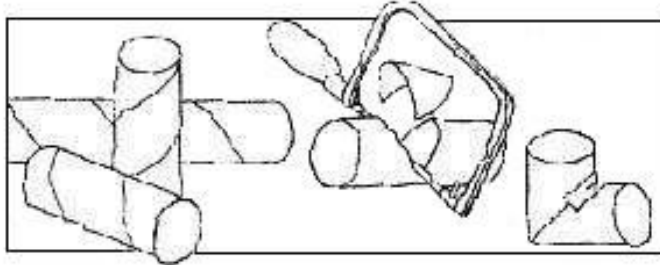

A straight connector is just a length of tube. Straight connectors do not need to be very long and toilet paper tubes or sections cut from longer tubes will work just fine.

Make angle connectors by cutting out a piece of the tube with a saw blade or sharp serrated knife so that the tube will fold to form an angle. Follow the example in the illustration, drawing cut-lines on the tube. Cut out the section very carefully. Put a piece of tape at the joint of the folded tube to hold it together.

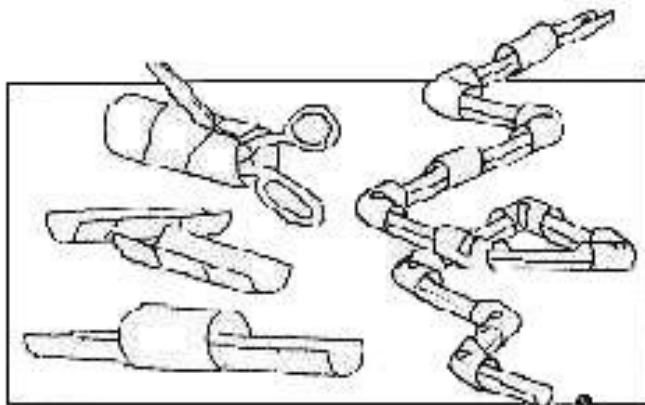

With some experimentation you will be able to make these connectors in several different angles.

Make chutes by cutting a length of tube in half the long way with scissors. Each length of tube will make two chutes.

After you have made several connectors and chutes, you can assemble them in any raceway pattern you like. Push the chutes into the connectors only as far as they need to go to hold them firm in order for the marble to

roll smoothly down the raceway.

All the chutes and connectors, starting from the top, must slant downward to some degree. You will also need a way to support the raceway or to lean it against something. Be inventive.

When adding chutes and connectors, keep testing it by rolling a marble through it. This project can be done by individual boys or by dens. If all the dens in the Pack do it, they could each be brought to the Pack Meeting for display and races.

NATURE CRAFTS

TREE RUBBINGS

Get in touch with nature and the trees all around you. To make tree rubbings, you need a sheet of lightweight paper and a wax crayon (dark colors show up best). Peel the paper-covering off the crayon and hold the crayon horizontally. Smooth barks are easiest to rub, and steady strokes in one direction work best. If the paper keeps shifting, tie it or tape it to the tree. You can bind your rubbings in a scrapbook, or frame them to hang on the wall. Include rubbings in the diary you are keeping of a single tree. Compare it with other tree rubbings that you have made or other kids have made.

Note: Never strip bark from trees, as that may damage or even kill a tree. You can collect bark off of fallen branches and stumps. You can collect bark off of fallen branches and stumps.

LEAF RUBBINGS

Go on a nature walk and gather leaves of different shapes and sizes. Teach the boys that only one leaf is needed, not an entire hand full. Leaf rubbings are simple art projects and teach the boy to see the different shapes of leaves and veins that run through the leaves. Notice that the primary vein divides the leaf into two equal halves. These two halves are alike but not identical, especially at the base. If they are offset they are termed asymmetrical. Lay the leaves face down on a hard surface, cover with a sheet of paper and rub back and forth with a crayon (peeled and used horizontally) until the shape of the leaf and its veins shows clearly. Use this concept to create cards for Mother's Day with sweet messages inside.

WALKING STICK BUG

Transform a twig into an interesting insect. To make this craft project you will need a short twig which is forked at the end, a number of brown pipe cleaners, and a marker. The forked end of the twig will become the head of your walking stick insect. Add eyes to this end with your markers. Now add pipe cleaner legs by wrapping the pipe cleaners around the twig to form V sections. Make three sets of legs. Bend the ends up to create feet for your walking stick to stand on.

MAKE A YUMMY TREAT FOR YOUR FEATHERED FRIENDS!

Take a long piece of yarn and dip one end in glue and let it harden, that will be your needle. Now string together circular treats like Cheerios and Fruit Loops, dip in some peanut butter. Hang it outside on a tree branch for the birds to feast on. You can collect bark off of fallen branches and stumps.

CUB SCOUT FAVOR

Use yellow cellophane-wrapped lollipops (or wrap your own)
Use clay or wood block for base
Cut a cap and neckerchief from construction paper and draw markings with crayon or pen



NECKERCHIEF SLIDES

What, why, and how?

by Susan Jones, Silver Lake District, UNPC

What: A neckerchief slide is a decoration with a ring, loop, etc., attached at the back or incorporated into the design of the slide, which keeps the ends of the neckerchief together in a “uniform” manner. A neckerchief slide is the only part of the Scout (Cub or Boy) uniform that is not standardized. Other than the standardized slides sold by the BSA, the only requirement attached to the neckerchief slide is that it be “hand made.” These slides are limited only by the imagination of the maker.

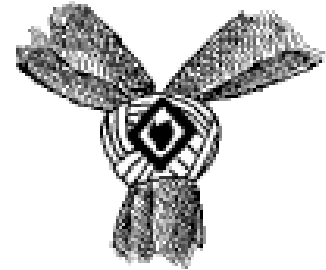

Why: A neckerchief slide can be used for many purposes. It can be used as a reward for a job “well done.” It can be used to help someone remember an important principle or activity (a fish to remember a fishing trip). It can and should be used as a “fun” part of the Cub Scouting program along with such things as den doodles and boondoggles. I have used neckerchief slides for all the above reasons, plus one more. In the Wolf and Bear books, there is either an achievement (Wolves #6 – Start a Collection) or an elective (Bear #22 – Collecting Things) that requires a “collection.” With at least one neckerchief slide created in the den each month, and a neckerchief slide display created at about the same time each year, these requirements can be signed off (if they haven’t been already).



What: Of what is a neckerchief slide made? Literally **ANYTHING** you want. That’s what this story is about. My goal is to help you see a neckerchief slide in everything around you. Just ask my kids. They will testify that they have often heard me say, “Don’t throw that away, (in unison) IT WOULD MAKE A GREAT NECKERCHIEF SLIDE! Groan! (You’ve got to have the groan in there.) When designing a neckerchief slide, remember the “ring” or back part of the slide. Here is a list of slide backing ideas to refer to when you create a neckerchief slide.

PVC pipe
garden hose
plastic plumbing
tube
metal tubing
wire
shoelace
leather strip
elastic

leather lace
twist tie
plastic
garbage bag
tie
string
ribbon
coat hanger
wire
chain rope

milk jug
handle
washers
curtain ring
plastic lace or
rex lace (also known as
boondoggle)
copper wire
pipe cleaner
metal “wedding” rings

When selecting a back, make sure that it is strong enough to handle the slide you are making.

How: How do you create a neckerchief slide?

First, you start with the theme or idea behind the neckerchief slide. Is it an award or part of the monthly theme? Now that you have that in mind . . .

Second, start looking for ideas to match the theme. Sources for ideas can be the old Program Helps, the Cub Scout How-to Book, Pow Wow Books (old and new), Roundtable, Pow Wow, other Scouters, etc. Other sources are magazines such as Family Fun (www.familyfun.com) and Pack-o- Fun (www.pack-o-fun.com or 1-866-222-3621). One word of warning: don't wait until the day before to start wondering about a neckerchief slide for "tomorrow's" meeting. It will rarely work out well. It is my habit to know the themes for the next four months and as I am out and about, I keep my eyes open for the "idea" for each of the themes. Once I hit upon an idea, I take the time to create one slide. I can tell very quickly whether the slide is do-able for 8 or 9 year old boys, or if it is one that will be a loner in my collection. (I have a lot of those.)

Third, you start asking yourself questions. How many do I need? How much money do I have for this project? What supplies do I have on hand? What supplies can I afford to get?

Fourth, once a do-able neckerchief slide is decided upon, and I have answered the above questions, I start gathering the stuff to create as many slides as needed. Usually, it takes more than just a day or two to gather the things needed to create a neckerchief slide for each of the 10 boys in my den. (See why you plan ahead? It can take a while to empty 10 Tic Tac containers.)

The places to look for supplies are: Craft stores, party supply stores, cake and candy supply stores, your own cupboards, mail order catalogs (see about planning ahead), hardware stores, etc.

Fifth, now set aside time and make the slides. Whether you will be making a few or many, by yourself or with help, or you let the boys make their own (they like this one best), this will take time. I have never had a slide take more than 15 minutes for the boys to do during den meeting, with the advance preparation I have done.

NOW FOR SOME OTHER HINTS: Plaster of Paris cast in candy molds make great, inexpensive (less than \$2.50 for 4.5 pounds or about \$6.00 for 25 pounds) neckerchief slides. The formula for a plaster slide is one part water to two parts plaster. Always add the plaster to the water and use paper cups and craft sticks for stirring the plaster mixture. When you are done, just throw away. Don't wash the plaster off in your sink. The plaster will settle to the bottom of your pipes and eventually fill them up. Go outside and use the garden hose at the curb. Once the plaster in the mold is starting to set, push the slide backing into the plaster. With the plaster coming up over the edges of the backing, it will be very secure. Also, regular Plaster of Paris is very soft, so once the slide is totally dry (at least 24 hours), prime the slide with white flat paint, front and back. Then you can paint or decorate the slide. If you have a delicate mold which needs a stronger plaster, "Hydrocal" can be obtained at masonry supply stores. It dries harder than Plaster of Paris, so it doesn't need to be primed. If the cast breaks, the Hydrocal can be glued back together, and it will set up a whole lot faster. You need to put the ring for the backing in very quickly. It only takes one to two hours before the cast can be removed from the mold. Hydrocal costs about \$40.00 for 100 pounds. The new "Fun Foam" is great for fun neckerchief slides. I have seen some slides made from wood and then recreated them in Fun Foam. It is not very expensive and goes a long way. Extra tacky glue is great for gluing this stuff and it isn't heavy, so light backings work well on these things. Low temperature hot melt glue guns also work well with Fun Foam. Other resources are the other people who are involved in Cub Scouting. Sometimes, just talking with people helps you to get ideas, and get supplies that they were going to throw away anyway.

NECKERCHIEFS – continued

NECKERCHIEF SLIDE DISPLAYS

Having a variety of slides is no fun unless you have a way to display them. In both the Wolf and Bear Books, having the collection “displayed” is part of the requirement. Two easy and inexpensive displays are: 1) the bottom section of a milk jug. Decorate it and have clothespins attached around the outer edge to hang the slides from. This one is nice, because the center of the jug is a great place to store the boy’s neckerchief and book. 2) A square board that has been decorated and has nails pounded into it, at a slant. Let the boys do the nail pounding. This one is hung on the wall.

WIRE NECKERCHIEF SLIDE BACK MAKER

This is a pattern for a wire neckerchief slide back maker. It is made of a piece of 1” wood and a 1/2” in diameter pipe. You use the pipe to bend the wire into the U shape curve that is cut into the wood. Then put the ends of the wire into the two little holes, press down on the wire and the wood to make a curve on the ends of the wire to have something to slide into the plaster or glue to the back of the slide. You’ll want to cut three or four grooves a little wider and deeper than the thickness of the wire in the top of the jig where you cut the hole for the pipe. These grooves will help keep the wires in place when you push the pipe down on top of the wire. This handy little gadget is used with 12 or 14 gauge wire and makes short work if you need to make a lot of slide backs.

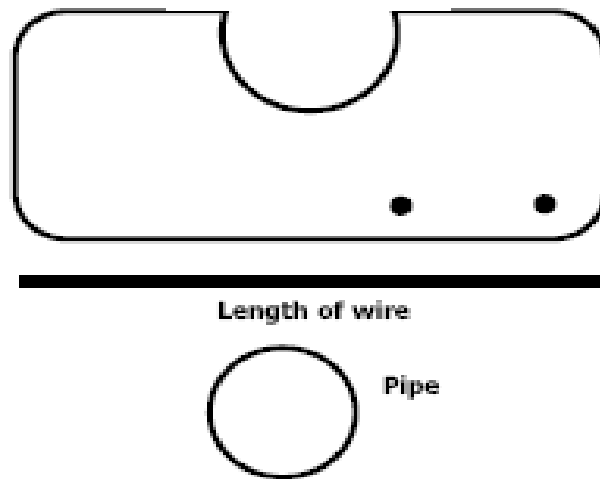

RUBBER MOLDS FOR PLASTER CASTING

First you need to buy a product such as “Mold Builder Liquid Latex Rubber.” This can be found at craft stores. Then, just follow the instructions on the jar for building a rubber mold. This will create a permanent mold that can be used over and over. It is very simple but time consuming. It takes an average of two days to make a mold. This is a great way to duplicate a great neckerchief slide.

FILM CANISTER BUBBLE BLOWERS – Neckerchief Slide

Materials:

- A film canister
- A pony bead
- 1/2” x 1 3/4” rectangle plastic canvas
- String or cord (to hang the blower around the neck)
- Glue gun
- Bubble solution

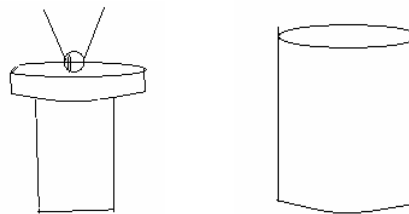

Glue long ends of plastic canvas to make a tube (don’t use too much glue). Glue the tube to the inside of the lid. Glue the side of the bead to the top of the lid. Thread the string through the bead. Tie ends to form a necklace. Fill the film canister with your favorite bubble solution. Dip the plastic canvas into the bubble solution. Blow. Enjoy! Store around your neck with lid tightly closed.

FILM CANISTER FIRST-AID KIT NECKERCHIEF SLIDEItems needed:

- Empty film canister
- Pipe cleaner (to make loop)
- 2 bandages
- 2 small safety pins
- 1 individually packaged wet wipe or alcohol swab
- Hole punch
- Red paint or nail polish

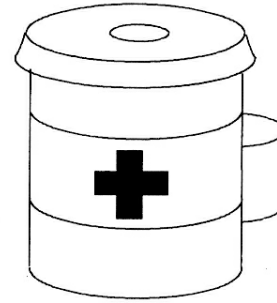

Punch 2 small holes on the back of the container, about ¼ inch apart (near the top). Thread each end of the pipe cleaner through the holes, and tie a knot on the inside. Let the boys decorate the outside as desired. They can paint a red plus sign along with their name. Fill the canister with the first-aid items, and seal with the lid.

PUZZLE PIECE REINDEER SLIDE

This technique could be used to make a Moose also.

1. Glue 3 jigsaw puzzle pieces together as shown.



2. Glue a piece of 1/2" PVC pipe (flattened on one side) to the back of the center puzzle piece.

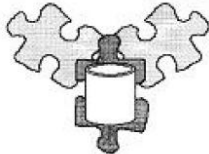

3. Paint both sides dark brown.

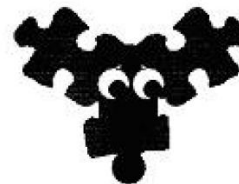

4. Attach 2 eyes and a red nose pom.

**BARBELL NECKERCHIEF SLIDE**Materials:

- Two 20mm wooden beads,
- 5/16" dowel (or size to fit inside beads)
- hot glue
- black, silver and white paint,
- thin strip of vinyl for the slide itself

Measure and cut the dowel rod about 2 ¼" long. Paint it silver. Paint the beads black. Put a dab of glue in the bead and insert the dowel. Paint the ends to match the bead. Paint a weight number on each barbell with white paint. Hot glue a narrow strip of vinyl to the back of each barbell to make the loop.

RECYCLE FOR CRAFTS

Making things from common household “items” can be fun and save you money. Start saving now-you may need 100 TP tubes for next week’s den meeting, and that’s a lot of TP to use in a week! Send a list of commonly used items home with your Cubs and let them start saving too. Look in your workplace or in retail stores for things that are usually thrown away that would make great crafts. Have several large boxes to store your recyclables, and make sure they are clearly marked. Be creative and the possibilities are endless. Here is a list of junk worth saving to get you started.

(Make sure everything is clean before you store it.)

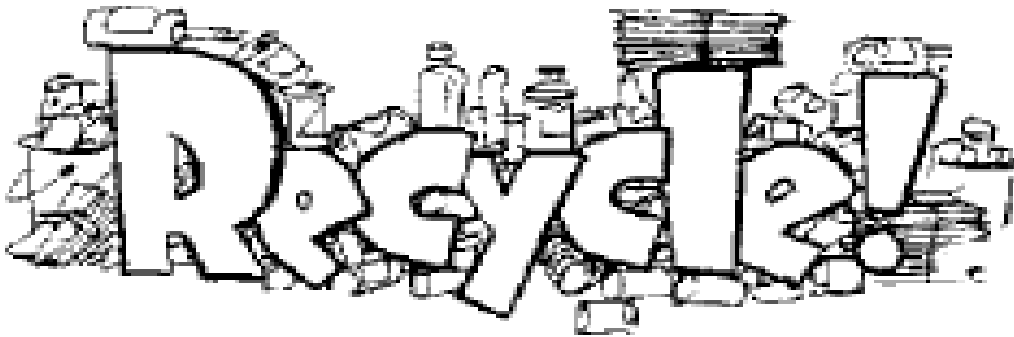

Aerosol can tops	Egg cartons	Packing Peanuts
Aluminum food containers	Fabric	Paper, plastic shopping bags
Baby food jars	Feathers	Paper of all kinds
Beads	Felt	Paper towel or TP rolls
Bottle caps	Fruit baskets/cartons	Pie tins
Boxes	Gift wrap	Plastic bags
Bubble Wrap	Gloves	Plastic bottles (1-, 2- or 3 liter)
Buttons	Ice cream containers	Plastic food containers
Calendars	Jar/frozen juice can lids	Rope, string, thread
Cans	Lace	Shells
Cardboard	Leather	Socks
Chenille stems (pipe cleaners)	Margarine Tub lids	Spools
Christmas cards	Magazines	Straws
Cloth scraps	Milk cartons	String
Clothespins	Milk “chugs”	Toothpicks
Coat hangers	Mirrors	Wood scraps
Cookie cutters	Nails, tacks, screws	Yogurt Containers
Corks	Newspaper	Yarn
Craft foam	Oatmeal, cereal, pizza boxes	
Crayon stubs		

DO IT YOURSELF CRAFT RECIPES

The following recipes may be used to make material for modeling objects instead of using clay. Most projects will air dry to a hard finish. The length of time for drying depends on the thickness of the object. All recipes may be stored indefinitely in plastic bags in the refrigerator. (Be sure to label them so some hungry family member doesn't try some.) All may be colored with food coloring or tempera, or painted after model is completely dry

<p>RUBBERY PLAY DOUGH 2 cups baking soda 1 1/2 cups water 1 cup cornstarch Mix with a fork until smooth. Boil over medium heat until thick. Spoon onto plate or waxed paper.</p>	<p>SAWDUST MODELING DOUGH 4 cups sawdust 1/4 cup plaster 1 1/2 cups wheat paste (wallpaper paste) Mix ingredients together and add water until moist enough to mold and stick together. Store in the refrigerator.</p>
<p>PLAY DOUGH 4 cups flour 1/4 cup powdered tempera 1/4 cup salt 1 1/2 cups water 1 Tablespoon oil Mix together flour, tempera, and salt. Mix water and oil, and food coloring if desired. Gradually stir the water and oil mix into the flour mix. Knead the mix as you add the liquid. Add more water if too stiff, more flour if sticky</p>	<p>PLAY DOUGH FOR BAKING 3/4 cup flour 1/4 cup white glue 1/4 cup Ivory liquid Food coloring Blend ingredients in a bowl. Knead the mixture together thoroughly, dusting with flour. Roll dough out flat. Make it thin because it expands when baked. Cut the dough with small cookie cutters. Bake on a cookie sheet for 2 hours at 200 degrees. When cool, decorate with acrylic or tempera paint.</p>
<p>SAND DOUGH 2 cups sand 1 cup cornstarch 1 cup water Mix all ingredients together and cook over low heat until thick. When cool, use to build sand castles and other shapes.</p>	<p>STARCH FINGER PAINT 2 Tablespoons liquid starch 1 Tablespoon powdered tempera Put starch and tempera in a bowl. Use a separate bowl for each color. Mix until evenly blended.</p>
<p>FLOUR FINGER PAINT 1/2 cup flour 1/2 cup water 1 Tablespoon liquid detergent food coloring Combine flour, detergent, and water in mixing bowl. Stir until they form a smooth paste. Divide and add food coloring.</p>	<p>CORNSTARCH FINGER PAINT 1/4 cup cornstarch 3/4 cup water food coloring or a little tempera paint Combine cornstarch with a little of the water in a pot. Stir until a smooth paste is formed. Stir in the rest of the water. Cook over low heat, simmering until clear and thick. Cool, blend in food coloring.</p>

<p>JUST LIKE REAL PLAY DOUGH 1 cup flour 1 cup water 1 Tablespoon oil 1 Tablespoon powdered alum 1/2 cup salt 2 Tablespoon vanilla Food coloring Mix all dry ingredients. Add oil and water. Cook over medium heat, stirring constantly until reaching the consistency of mashed potatoes. Remove from heat and add vanilla and food coloring. Divide into balls and work in color by kneading.</p>	<p>OATMEAL DOUGH 1 cup flour 2 cups oatmeal 1 cup water Gradually add water to flour and oatmeal in bowl. Knead until mixed. This dough is sticky but unique in texture. Model as with clay. Add cornmeal or coffee grounds in small quantities for different textures.</p>
<p>MODELING "GOOP" 2/3 cup water 2 cups salt 1/2 cup water 1 cup cornstarch Beads, colored macaroni, or other small objects (optional) Add 2/3 cup water to the salt in a pan. Stir and cook over medium heat, stirring 4-5 minutes until the salt is dissolved. Remove from heat. In a separate container, gradually mix 1/2 cup water with the cornstarch. Stir until smooth. Add the cornstarch mixture to the salt mixture. Return to low heat and stir and cook until smooth. The goop will thicken quickly. Remove from heat and use for modeling objects. Objects made from this goop can also be hardened in the sun. This mix will not crumble when dry. Objects like beads, macaroni etc. can be added to the goop, and adhered to the models.</p>	<p>SIDEWALK CHALK 2 cups water 2 cups plaster of paris 2 Tablespoons tempera paint (wet or dry) Toilet paper tubes (with duct tape over one end) Combine ingredients and stir together. Let stand a few minute. Place tubes on cookie sheet lined with foil or waxed paper. Pour mixture into tubes, let stand until semi-firm. Remove holders and let dry completely. The chalk is ready to use in about 1 to 1 1/2 hours. (Remember, never pour plaster down the sink.)</p>
<p>BREAD CRUMB DOUGH 3 slices of white bread 1-3 tsp. white glue 1/2 cup liquid detergent or 1 tsp. glycerin Remove bread crust. (Give them to the birds.) Crumble bread into tiny crumbs by tearing it apart in your hands. Work over a mixing bowl. Add liquid detergent or glycerin and one teaspoon glue. Mix well with your hands. Add more glue if it is needed to hold the dough together. (Different breads hold together differently.) Gather the mixture together and knead. The more you knead, the less sticky the dough will become. Wrap unused dough tightly in plastic to store, because it hardens quickly. Let finished art air dry on waxed paper. Turn from time to time so art doesn't stick to paper.</p>	

Cub Scout



Cubmaster Minutes

A Cubmaster minute is a short story, poem or thought that relates to the core value being focused on at the meeting. It is powerful way to bring close a meeting and leave them with something to think about. It might also involve a challenge to do your best, be a better cub scout, smile more etc... Den leaders can end their den meetings with a den leader's minute. Some of these can easily be used as a closing ceremony (You will find some repeated in both sections in this book)

<p>Cooperation Honesty Respect Responsibility</p>	<p>EVERYBODY, SOMEBODY, ANYBODY and NOBODY</p> <p>There is a story about four people. Their names are EVERYBODY, SOMEBODY, ANYBODY, and NOBODY. The story goes that there was a very important job that needed to be done. EVERYBODY was asked to do this job. Now ANYBODY could have done this job but NOBODY was willing to do it. Then SOMEBODY got angry about this because it was EVERYBODY'S job to do. Well, EVERYBODY thought that ANYBODY could have done it! But NOBODY realized that. EVERYBODY blamed SOMEBODY for not doing the job. Still NOBODY did it. The arguing got worse and finally NOBODY would talk to ANYBODY and EVERYBODY blamed SOMEBODY. What a shame that ANYBODY could have done the job and EVERYBODY could have helped SOMEBODY but yet NOBODY did it! If there is something you know must be done, don't wait for ANYBODY else to do it or hope that SOMEBODY else will do it because NOBODY else will do it unless you show EVERYBODY else how to do it.</p> <p>Translating to Scouting terms -</p> <p>Once there were four Scouters. Their names were: Tom Somebody, Dick Everybody, Harry Anybody, and Joe Nobody. They were very active and busy people; but what they accomplished was a shame and Everybody knew it. For example, Everybody had a good idea. Everybody thought Somebody would follow it through. Somebody thought Anybody would work on it. Anybody thought Everybody should do it. So Nobody ended up working on it. Now they all belonged in the same district and a great contest was on. Who could produce the best pack? Everybody thought Anybody would win the prize. Anybody thought Somebody would win it. Somebody thought Everybody would win it. Nobody was the most qualified of the four. Nobody was very faithful. Nobody worked very hard. Nobody won the contest. Which of the four received the prize? Nobody - - But Nobody!</p> <p>RIP - Someone Else</p> <p>The pack was saddened this week to learn of the death of one of our most valuable members, Someone Else. Someone's passing creates a vacancy that will be difficult to fill. He had been with us for years and for every one of those years, Someone did far more than a normal person's share of the work. Whenever leadership was mentioned, we looked to this wonderful person for inspiration as well as results: "Someone else can do that job." When there was a job to do, a need to be filled, or a place of leadership, one name always mentioned was Someone Else. It is common knowledge that Someone Else was among the largest givers of time and money in the pack. Whenever there was a financial need, everyone assumed that Someone Else would make up the difference. Now Someone Else is gone. We wonder what we are going to do. No longer can we say, "Let Someone Else do it." If it is going to be done, one of us will have to do it.</p>
--	--

<p>FIREWORKS (Scott Thayer, Sequoia Council, California)</p> <p>BOOM!! SIZZLE!! Oooh! Aaah! Don't you just love a good fireworks display on the Fourth of July? The colors are so beautiful, lighting up the night sky, but did you ever stop to think how boring it would be if all the fireworks were exactly the same? You'd have to sit there in your lawn chair for 20 minutes watching one after the other, every single one being red or yellow or green. You'd be ready to go home in just a little while. What really makes a fireworks show interesting is its variety, when you never know what's coming next. That's true for our wonderful United States, too. Americans come in all sizes and shapes and colors. We have different religious beliefs, different family customs, and different ideas about everything. But our differences are good, because they make it possible for us to learn new things from one another. Our differences make us a better people. If everyone were just like us, life would be boring. But when people are different, and when they respect each other's differences, then life is rich and exciting, just like a good fireworks display.</p>	<p>Citizenship Compassion Respect</p>
<p>STAR SPANGLED SUCCESS (Baloo's Bugle, Aug. 1997)</p> <p>Success means doing the best we can with what we have. Success in doing, not the getting - - In the trying - - not the triumph. Success is a personal standard - - reaching for the highest that is in us - - becoming all that we can be.</p> <p>If we do our best, we are a success.</p>	<p>Courage Perseverance Resourcefulness Respect Responsibility</p>
<p>SUNSCREEN</p> <p>Props: A bottle of sunscreen</p> <p>Cubmaster: Remember the last time you got a bad sunburn? It caused you much pain for several days, didn't it? You probably didn't even realize that it was happening. Sunscreen could have prevented it. Our parents are like sunscreen. They can be used in situations we don't even know can hurt us. It pays to listen to our parents.</p>	<p>Respect Responsibility</p>
<p>CHEERFUL</p> <p>We have a choice. We can be pleasant or unpleasant. Which do you choose? You can be grouchy and grumpy, happy and cheerful. Which would you rather be? It's up to YOU.</p>	<p>Positive Attitude</p>

<p>Compassion Courage Faith Positive Attitude</p>	<p>COLLECTIONS (Scott Thayer, Sequoia Council, Baloo's Bugle Aug. 2000)</p> <p>Many people of all ages have discovered the fun of collecting things. Whether you collect rocks or stamps or model cars, it's exciting to be on the watch for a new item to add to your collection and to see that collection grow. Some collections, such as rare sports cards, can be worth a lot of money. Other collections have no great dollar value.</p> <p>But there is one thing that you can collect which is worth more than anything else - good turns. In the Cub Scout Law of the Pack, we say, "The Cub Scout gives goodwill." That means that a Cub Scout is always on the lookout for ways to be helpful and kind to other people. When you accumulate acts of goodwill toward others, you are the wisest collector of them all.</p>
<p>Citizenship Courage Respect</p>	<p>FREEDOM</p> <p>We shouldn't take freedom for granted. Our right of free speech, to worship as we choose, and to enjoy the freedoms we have as Americans. There was a time in our history when men could only hope for these freedoms. And now they have become reality. Our freedom is a result of courage and sacrifice of thousands of our forefathers. Let us remember what it cost these men to provide our freedoms today and help keep our land free for those citizens of tomorrow.</p>
<p>Honesty Perseverance Positive Attitude</p>	<p>WORK</p> <p>Life never stands still. If you don't advance, you go backwards. In Cub Scouting you have many opportunities to learn and to advance as you do achievements, electives and activity badges. Do them well so that you are proud of the badges you wear. Work while you work, play while you play; one thing at a time, that is the way. All that you do, do with all your might, things done half-way are not done right.</p>
<p>Compassion Cooperation Positive Attitude</p>	<p>SMILE</p> <p>A smile costs nothing but creates much. It happens in a flash but the memory sometimes lasts forever. It cannot be begged, bought, borrowed, or stolen, but it is something that has no earthly value to anyone unless it is given away. So, if you meet someone who is too weary to give you a smile, leave one of yours. No one needs a smile quite as much as a person who has none to give.</p>

<p>CONTRIBUTIONS</p> <p>As we leave this evening, let us remember all the people who have helped shape this great land. The scientists and engineers, the farmers and factory workers, the writers and artists, the men and women of our country who gave of their talents and hard work to make this land what it is today. The fabric of our society is interwoven with all their contributions, both great and small. What contributions can you make?</p>	<p>Citizenship Cooperation Courage Perseverance Respect Responsibility</p>
<p>EACH DAY</p> <p>At the close of each day, remember: Each day is a new beginning. Another chance to learn more about ourselves. To care more about others. To laugh more than we did. To accomplish more than we thought we could. To be more than we were before.</p>	<p>Compassion Faith Perseverance Positive Attitude</p>
<p>POCKETKNIFE</p> <p>Cub Scouts, I hold in my hand a pocketknife. This is a valuable tool because it can be used for many useful things. It is a dependable tool as long as the blade is kept sharp and free from rust, and the working parts are in good condition. But if it is neglected and becomes dull and rusty, it can be dangerous. The same principle will serve well for us. We have a body, which when kept in good condition, will work well for us. But if we fail to take care of ourselves, we can become rusty and dull like a neglected knife. Do your best to keep fit!</p>	<p>Health and Fitness Perseverance Respect Responsibility</p>
<p>ACCOMPLISHMENTS</p> <p>Every Cub Scout should accomplish something worthwhile every day. And each day's accomplishment should be a little better than the previous day's. Tonight, stand at your window and look out into the darkness of night and ask yourself: "Have I done my best today?" Then each day, promise to do better than the day before. If we all do that, we'll have the best pack in the country!</p>	<p>Citizenship Courage Honesty Perseverance Respect Responsibility</p>
<p>WORKING TOGETHER</p> <p>These are some of the things that make working together and playing together easier—to tell the truth, to be honest, to be courteous, to have respect for leaders, and to think of others as well as ours selves.</p>	<p>Cooperation Honesty Respect Compassion</p>

<p>Compassion Cooperation Positive Attitude Respect Responsibility</p>	<p>BACKYARD BIRD FEEDER</p> <p>Have you ever counted the different types of birds at a backyard bird feeder? Some of you might have as a requirement or elective for your rank. At the bird feeder you will find birds of different types and different characteristics. There are birds that may be loud, those that hop around a lot, some may be show offs, and even a few that may not like to be in the crowd. Despite all of the differences, all the birds are joined together to eat.</p> <p>Just like at the bird feeder, you will find different types of people all over and even in your pack. Remember to like these others for who they are and learn from their differences. When you join with the others around you, you can accomplish many things and make new friends at the same time!</p>
<p>Courage Faith Honesty Perseverance Positive Attitude Resourcefulness Respect Responsibility</p>	<p>NATIVE AMERICANS AND THE EAGLE</p> <p>Most all Native American Indian people attach a special significance to the eagle and its feathers. Eagles represent honesty, truth, majesty, strength, courage, wisdom, power and freedom. As eagles roam the sky, they are believed to have a special connection to God.</p> <p>To be given an Eagle feather is a great honor. It shows you stand for all of the things the eagle represents and you want to live your life accordingly. As we go out tonight, think of the things that could earn you an eagle feather. Choose to do the things that eagles stand for and remember, in a few years, when you become Boy Scouts you too can earn your Eagle rank!</p>
<p>Compassion Courage Honesty Perseverance</p>	<p>DO YOUR BEST</p> <p>Have you ever hear the phrase "Winning is everything." Some people have decided that they must win whatever game they're playing, no matter what it takes. Sports coaches and even parents sometimes put a lot of pressure on their kids to win. But there is something much more important than winning. That something is doing your best.</p> <p>As we get ready for a new school year, let's all decide that we're going to make this a year when we do our best, whether it's in the classroom, on the playing field, at home with our families, or at our place of worship. Never forget that if you do your personal best, then you are a winner, no matter what the final score happens to be.</p>

<p>A GOOD SPORT</p> <p>The world is full of people who think it is a calamity if they lose a contest. They lose their temper and act like bad sports. A good sport will do his best, and if he loses, looks to the next game to do better and try to win. In Cub Scouting, we learn to be good sports, and to do our best, whether we win or lose.</p>	<p>Compassion Cooperation Courage Positive Attitude</p>
<p>ONLY WINNERS HERE TONIGHT</p> <p>At the end of our Pinewood Derby night, I would like to say that we were all winners here tonight. Dad has more respect for his son whether he was a humble winner or graceful loser. Mom was proud of her son whether she gave him a hug of congratulations or comfort. Each boy gained a better knowledge of competition; how to win, how to lose, how to be happy for a friend who is taking home the trophy he wanted. The leaders, in the pride they felt, knowing each of their boys had done his best. Building the car helped bring families together and cheering for our den members helped bring the den closer together. No, there are only winners here tonight. Thank you all for helping to make the pack go. Good night and CONGRATULATIONS TO ALL OF US WINNERS!</p>	<p>Compassion Cooperation Courage Perseverance Positive Attitude Respect</p>
<p>WORLD BROTHERHOOD</p> <p>To understand people, we need to learn how they live, how they play, what they make, what they wear, and what they eat. Fears and misunderstanding come from lack of knowledge. Through Cub Scouting and World Brotherhood of Scouting, boys can become more understanding. As we leave tonight let's try to judge less, and understand more.</p>	<p>Compassion Courage Positive Attitude Respect</p>
<p>HONESTY</p> <p>Lord Baden-Powell, the founder of Scouting said: "Honesty is a form of honor. An honorable man can be trusted with any amount of money or other valuables with the certainty that he will not steal it." When you feel inclined to cheat in order to win a game, just say to yourself: "After all, it is only a game. It won't kill me if I do lose." If you keep your head this way you will often find that you win after all. It's great to win, but if you can't win, be a good loser.</p>	<p>Honesty</p>

Citizenship Resourcefulness Respect Responsibility	MAKE A DIFFERENCE <p>We have learned a lot this month about taking care of our environment that we live in. Let us put to use the conservation techniques that we have learned this month. Let us treat the environment responsibly. Take one or two things that you have learned this month and put them into practice in your families. Each of us can make a difference. Do a good turn daily, especially in the area of conservation.</p>
Compassion Cooperation Courage Honesty Perseverance	MAGIC OF CUB SCOUTING <p>To take a little boy and help him grow into a man, that's magic. To teach him how to make things and let him know he can, that's magic. To watch him learn the Promise and apply it to his life, that's magic. To see him grow in mind and body, overcoming strife, that's magic. To watch his family beam with pride at everything he'll do, that's magic. And love him even if things don't go as he wanted them to, that's magic. As his Scouting leaders, we also beam with pride, Because we know he's learning and growing up inside, That's Cub Scout Magic.</p>
Any Value	MAGIC OF THE WORLD <p>(Baloo's Bugle April 2002)</p> <p>As parents, we want to show our sons the wonders of the world. In the eyes of a child, there are not just eight wonders of the world but eight million. We want him to be able to look at the stars, sunrise, sunset, and feel their beauty. We want them to see a world of love, laughter, and compassion. We want them to build strength within themselves of strong character and sensitivity to the needs of others. We want them to be the best they can be.</p> <p>Unfortunately, no one can wave a magic wand so that they will receive these things. We as leaders and parents must set the example to show the guidance so they may see the way to accomplish all of these things. This is the magic—our example and guidance. So as we leave, let's be aware of our actions and how loudly they speak to our youth.</p>
Courage Perseverance	DON'T GIVE UP <p>To be good at anything, you have to believe that you can do it, and then practice it until you can. There's no easy way to become an expert. You just have to keep at it, over and over. There will be times you'll think that you just can't make it. But don't give up a task because it seems hard. There are few things worth doing that are easy to do at first.</p>

<p>MAGIC WORDS CLOSING (Santa Clara County Council May 2002 Pow Wow Book)</p> <p>CUBMASTER: There is a very special kind of magic. This magic will open the coldest heart and win wonderful friends for us. (Cub Scouts come on stage, each one carrying a different sign, such as Please, Thank you, Pardon me, Excuse me, You're welcome, How nice you look, I admit I made a mistake.)</p> <p>CUBMASTER: Simple words, but important words that tell someone else that you are appreciative, courteous and thoughtful. Add kind deeds to the magic of words, and the possibilities are unlimited. A smile happens quickly, but the memory of it lasts a long time.</p>	<p>Any Value</p>
<p>WE'RE ALL WINNERS</p> <p>Some people have decided that they must win whatever game their playing, no matter what it takes. Sports coaches and even parents sometimes put a lot of pressure on their kids to win. But there is something much more important than winning. That something is "Doing Your Best."</p> <p>As we get ready for summer, let's all decide that we're going to make this a year when we do our best, whether it's in the classroom, on the playing field, at home with our families, or at our place of worship. Never forget that if you do your personal best, then you are a winner, no matter what the final score happens to be.</p>	<p>Compassion Courage Faith Health and Fitness Perseverance Positive Attitude Respect</p>
<p>STARFISH</p> <p>A friend of mine was walking on a beach one day, when he saw a native bend down and throw a starfish back into the ocean. He asked the native why he was doing it.</p> <p>"You see, it's low tide right now and all of these starfish have been washed up onto the shore. If I don't throw them back into the sea, they'll die up here from lack of oxygen."</p> <p>"I understand," my friend replied, "but there must be thousands of starfish on this beach. You can't possibly get to all of them. There are simply too many. And don't you realize this is probably happening on hundreds of beaches all up and down this coast? Can't you see that you can't possibly make a difference?"</p> <p>The local native smiled, bent down and picked up yet another starfish, and as he threw it back into the sea, he replied, "Made a difference to that one!"</p>	<p>Compassion Cooperation Courage Faith Perseverance Positive Attitude</p>

<p>Compassion Faith Honesty Positive Attitude Respect</p>	<p>HAVE YOU EVER WATCHED THE CAMPFIRE? (From The Gilwell Camp Fire Book)</p> <p>Have you ever watched the campfire, When the wood has fallen low, And the ashes start to whiten Round the embers' crimson glow?</p> <p>With the night sounds all around you Making silence doubly sweet, And the full moon high above you That the spell might be complete?</p> <p>Tell me - were you ever nearer To the land of heart's desire Than when you sat there thinking With your feet before the fire?</p>
<p>Any Value</p>	<p>DO YOUR BEST Inland NW Council</p> <p>When you give the Cub Scout Promise, the words "Do Your Best" often are lost in all of the other very important words. Let's stop for a minute and carefully consider those words.</p> <p>"Do" signifies effort and action.</p> <p>"Best" describes effort and action above our usual performance.</p> <p>"Your Best" is just that—the very best.</p> <p>You are the only person who can possibly know whether or not you have done your best to do certain things.</p> <p>Think about the meaning of the Promise and decide that you will always do your very best, no matter what the job facing you might be.</p>
<p>Any Value</p>	<p>SMILE CLOSING</p> <p>A smile costs nothing, but creates much. It happens in a flash, but the memory sometimes lasts forever. It cannot be bought, begged, borrowed or stolen, but it is something that is of no earthly good to anyone unless it is given away. So, if in your hurry and rush you meet someone who is too weary to give you a smile, leave one of yours. No one needs a smile quite as much as a person who has none left to give. What better way to spread good will. I challenge you this next month to look for someone who needs a smile every day and give them one.</p>

<p>SCOUT BEATITUDES</p> <p>Blessed are the Scouts who are taught to see beauty in all things around them, for their world will be a place of grace and wonder.</p> <p>Blessed are the Scouts who are led with patience understanding, for they will learn the strength of endurance and the gift of tolerance.</p> <p>Blessed are the Scouts who are provided a home where family members dwell in harmony and close communication, for they shall become the peacemakers of the world.</p> <p>Blessed are the Scouts who are taught the value and power of truth, for they search for knowledge and use it with wisdom and discernment.</p> <p>Blessed are the Scouts who are loved and know that they are loved, for they shall sow seeds of love in the world and reap joy for themselves and others.</p>	<p>Faith</p>
<p>WHAT CUBS ARE MADE OF</p> <p>Cub Scouts are made of all of these, Scarves of gold, patches on sleeves, Trousers of blue and well-worn knees, That's what Cub Scouts are made of.</p> <p>They're partly Indians, of fringe and feather, And beads and buttons and bits of leather, With war-paint and freckles mixed together, That's what Cub Scouts are made of.</p> <p>They're made of a promise, a pledge, and a prayer Of hands that are willing, of hearts that play fair, With something inside them that God put there, And that's what Cub Scouts are made of.</p>	<p>Faith</p>
<p>THE VALUE OF A BADGE</p> <p>A badge in Cub Scouting is a piece of embroidered cloth. If you were to try to sell one of these badges, you'd find that it wouldn't bring much money. The real value of the badge is what it represents ... the things you've learned to earn it. How to keep healthy, how to be a good citizen, good safety practices, conservation, and many new skills. Does your badge truly represent all these things? Were you prepared to meet each test at the time you passed it, or did you try to get by? Maybe you were prepared when you passed the test, but through laziness and neglect, you have forgotten the skill now. If this is true, then the badge you wear has little value. Don't wear a cheap badge. Wear one that has real value - one that represents what you can really do and know.</p>	<p>Any Value</p>



<p>Compassion</p>	<p>THE DOLLAR BILL</p> <p>(Have two crisp, new dollar bills. Hold one up to show) Can you all see this dollar bill? Pretty nice looking, isn't it? See how its crisp, clean, and neat? Who would like it? I'm going to give it away to someone, so raise your hand if you'd like it. OK, before I give it away, let me do this. (crumple the bill up into a small ball) Who still wants it?</p> <p>OK, just a second.(drop it on the ground and grind it with your foot)Who still wants it? (hold the crumpled bill in one hand and the second clean bill in the other) One of these bills is good looking, clean, and nice to look at. The other is kind of grimy, crumpled, and not too pleasant.</p> <p>But, neither is more valuable than the other. Their worth is not based on how they look. Like these dollars are valuable because they are dollars, people are valuable just because they are people, not because of how they look.</p>
<p>Health and Fitness</p>	<p>A BALANCED DIET FOR LIFE</p> <p>I expect you all know the 6 food groups. What are they? Bread and Grain, Vegetables, Fruits, Dairy, Meat, Sugar and Fat</p> <p>Great! And we all know it's important to include a mix of foods from all those groups in our diets. Why? So we have a well-rounded diet that keeps our bodies healthy.</p> <p>I believe the same sort of thing is true for our lives, not just our bodies. I can think of 6 'life groups' kind of like the 'food groups' - Academics, Athletics, Family, Music, Religion, and Social</p> <p>If you spent all your time just doing schoolwork, but no social or religious activities, you might get very good at science. But, you wouldn't have the skills to share your knowledge with others. If you just hang around with friends and listen to music, but no athletics, you might be a fun guy but you couldn't throw a ball or swim in a lake.</p> <p>If you look at famous figures that have had personal problems plastered on the front page, maybe you can see what I'm getting at. Some of them have invested all their effort into one activity and neglected the other areas of life. When they make it big, they are not prepared for the rest of life and it all falls apart.</p> <p>Take a big helping of Academics, a side-dish of Athletics, pour some Family time on top, garnish with Music, have a big glass of Religion, and finish with a Social dessert. Now, THAT's a balanced diet that will give you a healthy body AND life.</p>



Cub Scout



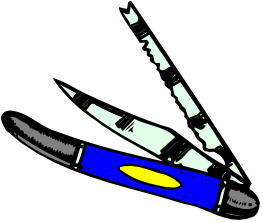

Closing Ceremonies



Closing Ceremony is the official end of the meeting. Often it involves retrieving the flag. It is also a good time to remind them of the Core Value focused on at that meeting. Some of these could also be used as a Cubmaster Minute. Most of these closing ceremonies can be easily adapted to be used as an opening ceremony also.

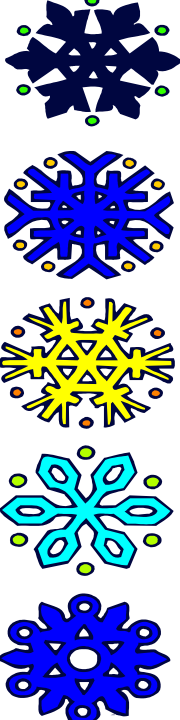

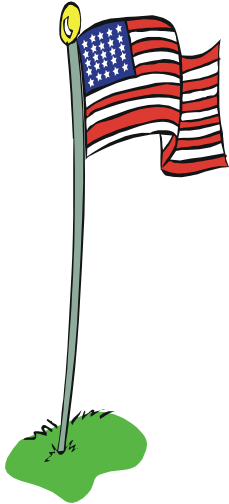
<p>Citizenship Courage Respect</p> 	<p>AMERICAN BOY</p> <p>A uniformed Cub Scout stands blindfolded, gagged and bound before the audience. The Cubmaster stands nearby.</p> <p>Cubmaster: This is an American boy. The American Revolution won him freedom. (Cubmaster unbinds him). The Constitution guarantees him free speech (remove gag). A free education gives him the ability to see and understand (remove blindfold). Let us help Cub Scouting teach him to preserve and enjoy his glorious heritage and to become a good citizen.</p>
<p>Health and Fitness Respect Responsibility</p> 	<p>SHARP KNIFE CLOSING (Santa Clara County Council Pow Wow Book June 1999)</p> <p>Cubmaster (showing a pocketknife): Cub Scouts, this is an ordinary pocketknife. Maybe you own one. If you don't, you probably will want one when you get into Boy Scouting. It's a very useful tool around camp. IF! Do you know what the "if" is? If you keep it clean and sharp. If you let a knife get dull and rusty, it's not only useless, it's dangerous because it won't be able to do what you want it to do. It's very easy to cut yourself when you try to force a dull knife to do something it can't do. The same idea applies to our bodies. If our bodies are clean and sharp--if we are really fit--we won't become dull and rusty like a knife that has not been given good care. That's why we exercise and play strenuous games. And that's why you want to keep your body fit now and in the years to come.</p> <p>Will you do your best? Please give the Cub Scout motto. (The boys shout, "We'll do our best!")</p>
<p>Citizenship Positive Attitude Respect Responsibility</p> 	<p>I WILL USE</p> <p>(This closing can be done in three ways. A Cub or leader can read the entire narrative. Copies of the ceremony can be handed out to the audience and they can read it in unison or have five Scouts each read a line.)</p> <p>Cub 1: This is my country. I will use my eyes to see the beauty of the land.</p> <p>Cub 2: I will use my ears to hear its sounds.</p> <p>Cub 3: I will use my mind to think what I can do to make it more beautiful.</p> <p>Cub 4: I will use my hands to serve it and care for it.</p> <p>Cub 5: And with my heart, I will honor it.</p>



<p>I MADE A PROMISE</p> <p>Five boys are needed for this ceremony. Each should have his part printed on a small card he can conceal in his hand or have the part memorized.</p> <p>Cub #1: I made a promise... I said that whatever I did I would do the best I could.</p> <p>Cub #2: I made a promise...to serve my God and my country the best I could.</p> <p>Cub #3: I made a promise...to help other people the best I could.</p> <p>Cub #4: I made a promise...to obey the Law of the Pack the best I could.</p> <p>Cub #5: I have done my best, and I will do my best because I am the best... I am a Cub Scout.</p> <p>Cubmaster: Will everyone now join us in repeating the Cub Scout Promise.</p>	<p>Compassion Faith Honesty Perseverance Respect</p> 
<p>PEACE</p> <p>CUBMASTER: It has been said that there are six kinds of peace and that a person who is given all of these will never want for anything else - neither for health or wealth, for love, for happiness, for beauty.</p> <p>The six kinds of peace are:</p> <ul style="list-style-type: none"> the kind of peace that comes from goodwill among nations; the peace that comes when neighbors help each other; the peace that a man draws from nature; the peace that he finds within his family; the peace between himself and God; and finally the peace he finds within himself. <p>To all you many friends may such peace be yours throughout the coming year.</p>	<p>Compassion Faith Perseverance Respect</p> <p>PEACE</p>  

<p>Citizenship Cooperation Courage Faith Health and Fitness Honesty Perseverance Respect</p> 	<p>SNOWFLAKE CLOSING (Or Opening) (Santa Clara County Council)</p> <p>Have Cub Scouts and family members cut out snowflakes when they enter the pack meeting, and put their names on them. (Six sided snowflakes can be made by folding a square sheet of paper in half, and then into thirds.) Tape or fasten to a wall, curtain, blackboard or window.</p> <p>“Have you ever caught a snowflake on a black piece of paper and studied it? It is so delicate and fragile that it melts almost before you can pick out its unique shape and structure. And it is unique, because each snowflake forms its own pattern of crystals in a six-sided shape. No two are exactly alike. There may be some that are similar, but none are the same. Each of you created a snowflake tonight. Look at the variety and differences. Each of you started out with the same materials, but you created something that is truly unique.</p> <p>Every person is unique, too. You may have your Mom's eyes, or your Dad's sense of humor. You may even be a twin and look so much alike that people have trouble telling you apart, but you are different in the things you like, the things you think, and the way you live your lives. You have your own unique contribution to make to the world. You have you own unique gifts and talents that will benefit you and those around you. You have your own unique style, laugh, dreams, and strengths.</p> <p>One snowflake will melt in an instant, but think of what happens when all those snowflakes are together in one place at one time. A pile of snow can make a ski jump, block a highway, or collapse a roof. A mountain of snow can provide water for a town for the whole summer, to carve the sides of a canyon. A lot of snow can accomplish things one snowflake can't, but it takes all of them working together to be successful.</p> <p>Let's unite ourselves, each unique individual, and work toward the common goals of citizenship, service, physical and spiritual strength, and brotherhood, and see what a contribution we can make to the world. Let's stand and repeat the Cub Scout Promise and the Law of the Pack.”</p>
<p>Compassion Courage Faith Positive Attitude Respect Responsibility</p>	<p>AT THE END OF THE DAY</p> <p>Every Cub Scout should accomplish something worthwhile every day. And each day's accomplishments should be a little better than the previous day. Tonight, stand at your window and look out into the darkness of night and ask yourself: " Have I done my best today?" Then each day, promise to do better than the day before. If we all do that, we'll have the best Cub Scout pack around.</p>



<p>THE FLAG SPEAKS www.wtsmith.com/rt/ceremonies</p> <p>Arrangements: The flag stands alone. Lights are dimmed with a spotlight on the flag. Speakers are offstage.</p> <p>CUB 1: I am your flag. I have special meaning to the Boy Scouts of America. The Scout Promise emphasizes duty to God and country and I am your country.</p> <p>CUB 2: I am a symbol of America. I suppose you might say I am America. I am great cornfields in the Midwest, throbbing industries in the great cities, orchards and vineyards in the great valleys of the west. I am mountains, rivers and lakes.</p> <p>CUB 3: I am the citadel of democracy and the vanguard of freedom in the world. Both are being threatened with annihilation.</p> <p>CUB 4: I am the opportunity for any boy to become most anything if he has the skill and the will to scale the heights. I am most things to everyone, and everything to most people. As a matter of fact, I guess that's what I am most people... free people... YOU!</p> <p>CUB 5: Let us rededicate ourselves to our duty to keep American people and our country great and free. Please rise and join in singing (patriotic song of choice).</p>	<p>Citizenship Courage Respect</p> 
<p>HELPING HANDS</p> <p><i>Have five different sized hands on cards with these messages on the back of them.</i></p> <p>TIGER CUB: My hands are small and I cannot do much on my own, but I have a big pair of hands to help me.</p> <p>BOBCAT: My hands are also small, but I am learning to do my best because the pack helps me grow.</p> <p>WOLF: My hands are getting bigger. Akela is teaching me to follow him and to use my hands to help other people.</p> <p>BEAR: My hands are also growing. Baloo the Bear is teaching me to use them to help others by obeying the Law of the Pack.</p> <p>WEBELOS: As my hands grow bigger I am learning new skills that will help me as I grow older.</p>	<p>Cooperation Courage Honesty Respect</p> 



<p>Resourcefulness Responsibility</p> 	<p>LEAVE NO TRACE PLEDGE (Opening or Closing)</p> <p>Tonight we have learned more about how much we use the world around us. Keeping the world around us beautiful and using it wisely is important.</p> <p>Please join with me to repeat the No Trace Pledge: I promise to practice the Leave No Trace frontcountry guidelines wherever I go:</p> <ol style="list-style-type: none"> 1. Plan Ahead 2. Stick to Trails 3. Manage Your Pets 4. Leave What You Find 5. Respect Other Visitors 6. Trash Your Trash <p>Let's try to live by these words whenever we are in the great outdoors. Good night Cub Scouts!</p>
<p>Courage Faith Honesty Perseverance Resourcefulness Respect Responsibility</p> 	<p>SMALL SEEDS</p> <p>Thomas Jefferson gave the following observations as to what would aid us in a practical and productive life.</p> <ol style="list-style-type: none"> 1. Never put off till to-morrow what you can do today. 2. Never trouble another for what you can do yourself. 3. Never spend your money before you have it. 4. Never buy what you do not want because it is cheap. 5. Pride costs us more than hunger, thirst and cold. 6. We never repent of having eaten too little. 7. Nothing is troublesome that we do willingly. 8. How much pain has cost us the evils which have never happened. 9. Take things always by their smooth handle. 10. When angry, count to ten before you speak; if very angry, to a hundred. <p>Small seeds, like these small observations, grow into great trees. Think of how great we would be if we would incorporate just a few of these seed principles into our lives. I challenge you to pick one , plant it, then see what grows.</p>

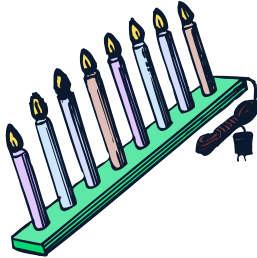

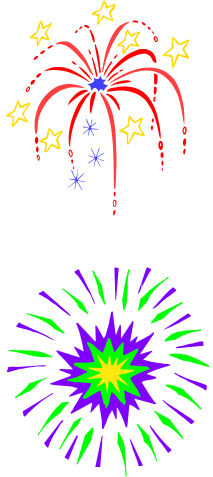

<p>DO MORE</p> <p>We have dreamed of and spoken of the future tonight. We always think of the wonders of technology and all the changes that will take place. But, in the future, one thing will remain the same - the human spirit. Tonight, let us pledge to be the best we can as we listen to these thoughtful words.</p> <p>Do more than belong... Participate.</p> <p>Do more than care... Help.</p> <p>Do more than believe... Practice.</p> <p>Do more than be fair... Be kind.</p> <p>Do more than forgive... Forget.</p> <p>Do more than dream... Work.</p> <p>Do more than teach... Inspire.</p> <p>Do more than live... Grow.</p> <p>Do more than be friendly... Be a friend.</p> <p>Do more than give... Serve.</p> <p>Here's to a wonderful future. Good night Cub Scouts.</p>	<p>Compassion Cooperation Courage Faith Honesty Perseverance Positive Attitude Respect Responsibility</p> 
<p>DO YOUR BEST</p> <p>CUBMASTER: We've had a lot of fun today, With families together in fun and play, And now before we each go our way, Let's have each family take part in 'Our closing for the day'. Leader then instructs all families to stand in a family Brotherhood Circle with hands on each other's shoulders as all in unison says:</p> <p>FAMILIES: As a family, we pledge to do our best!</p> <p>LEADER: Good night!.</p> <p>If desired, the families can stand in their own family brotherhood circle while a portable tape recorder or CD player plays some appropriate song such as "Taps," or "Vespers."</p>	<p>Compassion Cooperation Perseverance Positive Attitude Respect</p> 

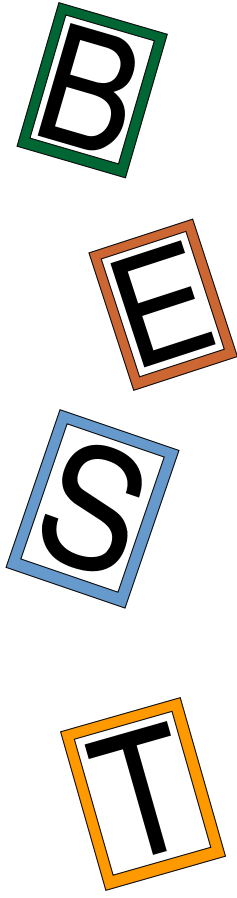
<p>Citizenship Courage Faith Honesty Perseverance Resourcefulness Respect</p> 	<p>AMERICA THE BEAUTIFUL</p> <p>(In the background, play a recording of the song "America the Beautiful.")</p> <p>I'm sure we are all familiar with this song. We thrill to see America's spacious skies, its amber waves of grain, and purple mountains majesty. We often think of this song as a song of praise to America's physical beauty.</p> <p>Have you ever sung the other verses to this song? They tell us a little something about the history of America. "Oh Beautiful for pilgrim's feet" celebrates the people who bravely left their homelands to settle this country. "Oh, beautiful for heroes proved..." helps us to remember all those who fought and died so that we can be free. "Oh, beautiful for patriot dream that sees beyond the years..." reminds us that America was founded on a dream and continues to grow and prosper with that dream. These verses remind us of the beauty and strength of character of the Americans who came before.</p> <p>Next time you hear, or sing this song, listen to the words. Listen to the praises for the great men and women who built this beautiful America. Pledge to be an American who helps to "crown thy good with brotherhood..." Remember the beauty of America - its physical beauty and the beauty of all of its people. (Sing all four verses of "America the Beautiful")</p>
<p>Citizenship Courage Faith Respect Responsibility</p> 	<p>TRAILS</p> <p>NARRATOR: Our pioneer forefathers found and followed many trails. The Native Americans explored the country first. European settlers followed, and so did those from the Orient and Africa. With each new person came new experiences and new challenges.</p> <p>CUB 1: Our trail is the Cub Scout trail.</p> <p>CUB 2: Our experience is the fun and adventure of Cub Scouting.</p> <p>CUB 3: Our challenge is to be good Scouts, friends and neighbors.</p> <p>CUB 4: Our future is to explore the world around us, moving up the trail from Cub Scout to Webelos Scout and then to Boy Scouts!</p> <p>CUB 5: May we always remember the experiences of those who came before us as we move up our trail.</p> <p>NARRATOR: Good night.</p>

<p>CIRCLE OF KINDNESS</p> <p>On pieces of cardstock, one for each Cub, write kind words (i.e., loving, smile, happy, sharing, giving, respect, reverence, etc.). Have the Cubs stand in a circle holding these cards raised above their heads in their left hand while repeating the Cub Scout Promise.</p>	<p>Compassion Positive Attitude Respect</p>
<p>YEAR'S END – CLOSING CEREMONY (Santa Clara County Council Pow Wow Book, Dec. 2000)</p> <p>Setting: House lights are dimmed. Ceremony board or log contains 7 small candles(or electric candles) and one tall candle representing the Spirit of Cub Scouting.</p> <p>Cubmaster: (lights candles) This last ceremony for 20__ is one of rededication. Tonight four candles represent the Bobcat, Wolf, Bear and Webelos Cub Scout ranks. Will all Bobcat Cub Scouts and their parents please stand? Bobcats, do you promise in the year 20__ to do your best to help other people and obey the Law of the Pack, and to advance one rank?</p> <p>Bobcats respond: We'll do our best. (Extinguish Bobcat candle.)</p> <p><i>Follow same procedure for Wolf and Bear Cub Scouts.</i></p> <p>Cubmaster: Will all Webelos Scouts and their parents please stand? Webelos Scouts, do you promise in the year 20__ to do your best to help other people and obey the Law of the Pack and to earn the Arrow of Light Award, if you have not already earned it?</p> <p>Webelos respond: We'll do our best. (Extinguish the Webelos candle.)</p> <p>Cubmaster: Three candles and the Spirit of Cub Scouting candle remain burning. The three candles stand for FOLLOWS, HELPS and GIVES, which means 'We'll be loyal'. Will you be loyal Cub Scouts in 20__ and beyond?</p> <p>All respond: We'll do our best! (Three candles are extinguished.)</p> <p>Cubmaster: The Spirit of Cub Scouting still burns as it does in the hearts of Cub Scouts everywhere. May it continue to burn brightly in your hearts during the year 20__ as we go upward and forward in Pack _____. Goodnight, Cub Scouts.</p>	<p>Faith Honesty Perseverance Positive Attitude Respect Responsibility</p>  

<p>Citizenship Respect</p> 	<p>FIREWORKS CLOSING (Scott Thayer, Sequoia Council, California)</p> <p>BOOM!! SIZZLE!! Oooh! Aaah! Don't you just love a good fireworks display on the Fourth of July? The colors are so beautiful, lighting up the night sky, but did you ever stop to think how boring it would be if all the fireworks were exactly the same? You'd have to sit there in your lawn chair for 20 minutes watching one after the other, every single one being red or yellow or green. You'd be ready to go home in just a little while. What really makes a fireworks show interesting is its variety, when you never know what's coming next. That's true for our wonderful United States, too. Americans come in all sizes and shapes and colors. We have different religious beliefs, different family customs, and different ideas about everything. But our differences are good, because they make it possible for us to learn new things from one another. Our differences make us a better people. If everyone were just like us, life would be boring. But when people are different, and when they respect each other's differences, then life is rich and exciting, just like a good fireworks display.</p>
<p>Citizenship Faith</p> 	<p>HAVE YOU EVER WATCHED THE CAMPFIRE? (The Gilwell Camp Fire Book, National Area Capital Council, Baloo's Bugle May 2002)</p> <p>Have you ever watched the campfire, When the wood has fallen low, And the ashes start to whiten Round the embers' crimson glow?</p> <p>With the night sounds all around you Making silence doubly sweet, And the full moon high above you That the spell might be complete?</p> <p>Tell me - were you ever nearer To the land of heart's desire Than when you sat there thinking With your feet before the fire?</p>
<p>Courage Perseverance Resourcefulness Respect Responsibility</p>	<p>STAR SPANGLED SUCCESS (Baloo's Bugle, Aug. 1997)</p> <p>Success means doing the best we can with what we have. Success in doing, not the getting - - In the trying - - not the triumph. Success is a personal standard - - reaching for the highest that is in us - - becoming all that we can be. If we do our best, we are a success.</p>

<p>DO YOUR BEST (Detroit Area Council)</p> <p>Narrator: Whatever we want to be in the future, keep in mind:</p> <p>Cub 1: "D" stands for doctor. I'll try to help sick people.</p> <p>Cub 2: "O" stands for operator. I want to operate a big crane.</p> <p>Cub 3: "Y" stands for youth. When I grow up I want to work with young people.</p> <p>Cub 4: "O" stands for outdoors. I want to work outdoors when I grow up. I could be a lifeguard or a forest ranger.</p> <p>Cub 5: "U" stands for under. Strange, but I like submarines. I will try to work under water.</p> <p>Cub 6: "R" stands for reporter. I like to write and I want to work for a newspaper.</p> <p>Cub 7: "B" stands for baseball. I hope to be a ball player.</p> <p>Cub 8: "E" stands for engineer. I would like to build. That's the job for me.</p> <p>Cub 9: "S" stands for sailor. I want to sail on a ship.</p> <p>Cub 10: "T" stands for teacher. I hope to grow up to be a teacher.</p> <p>Narrator: So Cubs, "Do Your Best" whatever you do.</p> <p>All answer: "We'll do our best!"</p>	<p>Perseverance Positive Attitude Responsibility</p> 
<p>LIGHTS ON THE FLAG</p> <p>Arrangement: The American flag is posted on the stage or the center of the room. Each Cub Scout in the audience has a flashlight or light stick. At a signal all the Scouts turn on their light and point them to the flag. The lights in the room are turned out or dimmed.</p> <p>Narrator: From the four corners of our great nation, from the depth of the rivers and the top of the mountains, the sun shines all around. Bringing light and warmth to all, no matter where they are found. Our nation's flag provides us freedom and rights to all, no matter where it flies. May we always be as thankful for it as we are for the sun that shines! Please join in as we sing "God Bless America."</p>	<p>Citizenship</p> 

<p>Citizenship Compassion Cooperation Faith Honesty Perseverance Respect Responsibility</p>   	<p>AMERICA'S ANSWER (Santa Clara County Council Pow Wow Book Jan. 2001)</p> <p>America needs men with a concern for the common good . . . men who have the understanding and insight to help solve her problems and those of the changing world around us. She needs citizens of integrity who value their great heritage and who are determined to pass on to others an enduring faith in the ideals and methods of our free society.</p> <p>How does a boy come to know and to appreciate his heritage as a citizen of this nation? How does his sense of responsibility and his concern for others unfold?</p> <p>Begin with him when he is a Cub Scout as he promises with all the solemnity of an eight-year-old ". . . to do my best to do my duty to God and my country . . ." Watch the pride and loving care with which he holds the flag as he is taught to fold it. He may not fully understand all that it stands for, but someday he will, with your help.</p> <p>Observe him later, as he stands tall, alert, and proud in his khaki uniform as the flag is lowered at Scout camp. He is living every day as a good citizen and is showing concern for the needs of others. He is growing and practicing the fundamentals of citizenship. All of this time he is under the friendly guidance and companionship of leaders who care about him.</p> <p>Now he is grown tall in high school, a Venturer. He ponders the words of the Venturing Oath. There is conviction in his voice as he says, "I will treasure my American Heritage and will do all I can to preserve and enrich it."</p> <p>And so this young American comes to manhood. He has grown through his Scouting experiences and through the influences of many men and women who have helped him. He has a job and a family and is making himself count in his community. He is a citizen of a great nation. He understands his heritage and cheerfully accepts his future obligations to all men. He has been a Scout. He is America's Answer!</p>
<p>Compassion Respect Responsibility</p> 	<p>SUNSCREEN</p> <p>Props: A bottle of sunscreen</p> <p>Cubmaster: Remember the last time you got a bad sunburn? It caused you much pain for several days, didn't it? You probably didn't even realize that it was happening. Sunscreen could have prevented it. Our parents are like sunscreen. They can be used in situations we don't even know can hurt us. It pays to listen to our parents.</p>

YOUNG ATHLETE’S BILL OF RIGHTS

(Santa Clara County Council Pow Wow Book Aug. 2002)

This ceremony can be read by the Cubmaster, by various boys assigned to present the points, or by parents and leaders.

Thank you for coming to our Pack Meeting! I would like to share with you the Young Athlete’s Bill of Rights. Cub Scout athletes are all protected by this Bill of Rights, which has been prepared by physical education experts and should be an integral part of every pack program. The Bill of Rights was created to insure that all Cub Scout athletes have a positive experience while learning new skills and doing their best in some of our nation’s favorite sports activities.

Each Cub has:

1. The right to participate in sports.
2. The right to participate at his own ability.
3. The right to qualified adult leadership.
4. The right to a safe and healthy environment.
5. The right to share in leadership and decision-making.
6. The right to play as a child, not as an adult.
7. The right to proper preparation.
8. The right to equal opportunity to strive for success.
9. The right to be treated with dignity.
10. The right to have fun.

Health and Fitness

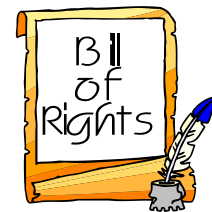

COLLECTIONS

(Scott Thayer, Sequoia Council, Baloo’s Bugle Aug. 2000)

Many people of all ages have discovered the fun of collecting things. Whether you collect rocks or stamps or model cars, it’s exciting to be on the watch for a new item to add to your collection and to see that collection grow. Some collections, such as rare sports cards, can be worth a lot of money. Other collections have no great dollar value.

But there is one thing that you can collect which is worth more than anything else - good turns. In the Cub Scout Law of the Pack, we say, "The Cub Scout gives goodwill." That means that a Cub Scout is always on the lookout for ways to be helpful and kind to other people. When you accumulate acts of goodwill toward others, you are the wisest collector of them all.

**Compassion
Faith
Respect**



<p>Citizenship Compassion Cooperation Positive Attitude Resourcefulness Respect Responsibility</p> 	<p>A TREE IS A GOOD SCOUT (Baloo’s Bugle April 2000)</p> <p>Cub 1: Did you ever pause to think about how helpful a tree is?</p> <p>Cub 2: It provides a nesting place for birds, shade from the sun, and protection from the rain.</p> <p>Cub 3: It discards it's dead branches, thus providing wood for building fires and for cooking food.</p> <p>Cub 4: A tree adds beauty to the countryside and to camping areas.</p> <p>Cub 5: We must admit that a tree gives a lot more than it receives.</p> <p>Cub 6: We can learn a lesson from the tree, by doing our best to always be helpful to others and by putting our fellow Scouts first and ourselves second.</p> <p>Narrator: Remember the lesson we learn from the tree - To give to others more than we receive.</p>
<p>Citizenship Compassion Cooperation Courage Faith Health and Fitness Honesty Positive Attitude Respect Responsibility</p>	<p>MAY I</p> <p>Cub 1: May I grow in character and ability as I grow in size.</p> <p>Cub 2: May I be honest with myself and others in what I do and say.</p> <p>Cub 3: May I learn and practice my religion.</p> <p>Cub 4: May I always respect my parents, my elders and my leaders.</p> <p>Cub 5: May I develop high moral principles and the courage to live by them.</p> <p>Cub 6: May I strive for a healthy body, mind, and spirit.</p> <p>Cub 7: May I always respect the rights of others.</p> <p>Cub 8: May I set a good example so that others will enjoy and benefit from being around me.</p> <p>Cub 9: May I work hard and do my best in everything I try to do.</p> <p>Cubmaster: Cub Scouting will help the boys learn these things, prepare them for Boy Scouting, and show them that they’re always winners if they do their best.</p>

Cub Scout



Derbies

The most well known derby is of course the Pinewood Derby but there are others such as the Space Derby and Raingutter Reggatta. There are also Bike Rodeos, Cub Scout Olympics and more (See Chapter 6 in the Cub Scout *How to Book*) Most Derbies fall under the “Special Events” category and need a bit of extra planning. Good planning makes for a great Derby. Here are just a few tips and ideas to help you plan your next Cub Scout Derby.

PLANNING SPECIAL EVENTS

Begin planning at your yearly planning conference. Decide if your event needs a special committee or not. If the event requires a committee, begin early to select and train people for this committee.

If the event requires a committee, another person's help or materials, a special building or room at your meeting place, or rental of equipment, CALL EARLY! Three months prior to the event is not too early. Get the basics planned out—when, where, what and who.

Three months before the activity, make sure all scheduling (building, equipment rental, etc.) has been taken care of. If there has been an event committee chosen, make sure the chairman comes to the pack planning meeting the three months leading up to the event to report the progress of the committee and ask for any help needed.

If trophies are needed, at least two months advance planning is required. This can be an event committee responsibility. Decide what trophies will be awarded, how much money should be budgeted for trophies, and where you would like to purchase the trophies.



PLANNING A PINEWOOD DERBY

Decide the following:

- Type of race (Cubs only, Parents and Cubs, Adults, Cubs and Siblings, open race, etc.)
- Is an open class going to be allowed so anyone who wants to can race?
- How many and what kind of awards will be given out?
- Who will purchase or make awards?
- What are the rules? (It's helpful to hand out a copy of the rules when handing out the car kits)
- Who will judge the participation awards?
- Who can help set up and take down?
- How sophisticated of a track and timing do you want?
- Who will schedule the room and equipment needed?
- When will weigh-ins be?

DERBY RELATED ACHIEVEMENTS and ELECTIVES

Tiger: Electives 17- Make a Model: Make a Pinewood Derby car or a Space Derby model rocket, etc.

Wolf: Achievement 5- Tools for Fixing and Building - use tools to build a Pinewood Derby car, Space Derby Rocket, etc. Wolf Electives 3e- Make something else. Make a Derby car, Space Derby Rocket, etc.

Bear: Achievement 21a- Build a model from a kit or 21f- Make a model of a rocket, boat, car, or plane. Make a Pinewood Derby car, Space Derby Rocket, etc.

Webelos: Craftsman 2- Construct wooden objects - one might be [Pinewood Derby] car, Space Derby Rocket, etc. Artist 9 - Make an art construction, using your choice of materials. - Make and decorate a Pinewood Derby car, Space Derby Rocket, etc.

OPENING CEREMONIES

PINEWOOD - Opening

- P** Pinewood Derby is fun for all. But the whole family must answer the call.
- I** I entered the competition to win or lose, or whatever my doom.
- N** Neatly I painted my car with dad's expert help, but I ran it myself.
- E** Excitement ran all through the night. No matter who won, it will be all right.
- W** We would all like to come in first, but if not, our bubble won't burst.
- O** On with the races, don't hesitate. The Pinewood Derby didn't wait.
- O** Open the gates, down the track, then we rest. For, being Cub Scouts, we've done our best.
- D** Don't mind tonight, where your car places, Cub Scouting will help you through life's races.

PINEWOOD DERBY TIME

Each boy should read his line from a card which has the first letter of the sentence on the front side.

- D** Dads and sons this month have had some fun
- E** Everyone working to make their pinewood derby car run
- R** Races will be held right here tonight
- B** Boys and dads hoping they built theirs just right
- Y** Yearning to WIN a race or two
- T** Thinking hard about the competitions our car must go through
- I** In just a short while the races will begin
- M** May all the best cars win
- E** Everybody please rise. Let us say the pledge to the flag.



FLAG CEREMONY - OPENING CEREMONY

Tonight our Cub Scout Car Race has a green flag that tells us when to start. We race and challenge all the other boys within our very heart. Who will be the winner no one knows until the racer comes across the mark and the checkered flag is waved. Our country has a Red, White and Blue Flag, but with this flag we all are winners no matter the outcome. May we all have patriotism in our hearts. Please stand and say the Pledge of Allegiance to the flag.

A HISTORY OF TRANSPORTATION

(Good for Raingutter Regatta and Space Derby too)

MATERIALS: Narrator and 6 boys with a model or picture of the following: foot, wheel, boat, engine, airplane and rocket.

FIRST BOY: (Foot) Man learned to get from place to place, running set a faster pace.

SECOND BOY: (Wheel) Then he invented the wheel to show, how much further he could go.

THIRD BOY: (Boat) The boat helped us carry more. Now we traveled from shore to shore.

FOURTH BOY: (Engine) Engines helped us travel far, almost everyone owns a car

FIFTH BOY: (Airplane) With airplanes we travel fast, the jet age has arrived at last.

SIXTH BOY: (Rocket) Rockets fired into space, have taken us past the moon's face.

NARRATOR: Transportation has changed and so have the vehicles used. These vehicles play an important part in our lives, either taking us places or bringing us goods and services. Cub Scouting is also a vehicle. It takes us places by inspiring us to look, for new adventures outside of our homes. And just as planes and engines need fuel to go, so do we. We need new ideas, new incentives and new opportunities. Trains, planes and ships need crews to keep them going. We do too. We need our parents and leaders to work together to keep the dens and pack going. I'm glad you're on board. We have a wonderful trip in store for you.

DO YOUR BEST

Our lives are made up of many different acts or parts. As young boys, you act the part of a Webelos, Bear, Wolf or Bobcat. In school, you act the part of the student. At home, you act the part of a son and maybe a brother.

Tonight you will act the part of race car driver (sail boat captain, astronaut). Whatever part you act, do what is right and do your best. Let's all do our best to be good sports tonight, to have fun and to be good citizens too. Please join me in the Pledge of Allegiance.

TWAS THE NIGHT BEFORE PINEWOOD

'Twas the night before Pinewood,
 his car still needed lead,
 he had done his very best,
 when his mom yelled "Get to bed!"
 He climbed under his blanket,
 his car wasn't ready to race,
 the pinewood derby was tomorrow,
 there was a frown on his face.

Just as his eyes closed,
 he heard something spin,
 it was Scout Saint Nick,
 coming to help him win!

As he peeked from under the covers,
 Scout Saint Nick started to drill,
 to help his car speed,
 on its way down the hill.

He splashed on some paint,
 and stuck on some wheels,
 he put the car on its stand,
 and clicked his boot heels.
 This woke the young scout,
 he had a smile on his face,
 a happy Pinewood to all,
 and to all a good race!

A PINEWOOD DERBY READING

When I make my car,
 I hope that I can win.
 Everything is ready,
 the weight and shine and spin.
 The first race is the real test,
 to see how good it is.
 My helper is happy too,
 you'd think the car is his!
 Eventually I lose a race,
 and it is hard to take,
 But my helper and I sure had fun,
 a Pinewood Derby car to make!

**ADDITIONAL IDEAS**

Add a special station to have the boys take an eye test or written exam prior to getting their driver's license. You can download an eye chart, a written exam and lots more on this downloads page: <http://bunchofoldguys.home.comcast.net/Downloads.htm>. Printable certificates too.

Have a coloring table for little ones. Get racing themed coloring books or find pictures from online. Have a prize for the winner of the coloring contest.

Have someone with a digital camera photograph each scout posing with his car with an appropriate background (trophies, banners, flags, etc.).

Feature an adults or open class race for parents, leaders, siblings, etc. to allow them to race. Why should the boys have all the fun?

Consider hosting a car-building clinic. Ask an adult to open up his or her workshop/garage to assist boys with limited resources. Offer assistance with design, cutting, and finishing the cars. Have extra parts available.

If you search the Internet you will find more information than you know what to do with. Find the ideas that will work for your pack and leave the rest. Each pack is different and will run a derby its own way.

ADVANCEMENT CEREMONY

PINEWOOD DERBY TRACK-

Put decals or actual badges of rank on stiff cardboard and attach to eight inch long sticks. Tape or tack these to side-rails of the pinewood derby track in ascending order - Bobcat near bottom, then Tiger (if your pack has Tiger Cubs) Wolf, Bear Webelos badge and Arrow of Light. If you have a boy graduating into a Scout troop, have a Scout badge at the top. At appropriate places on the track, tape badges and arrow points to be presented.

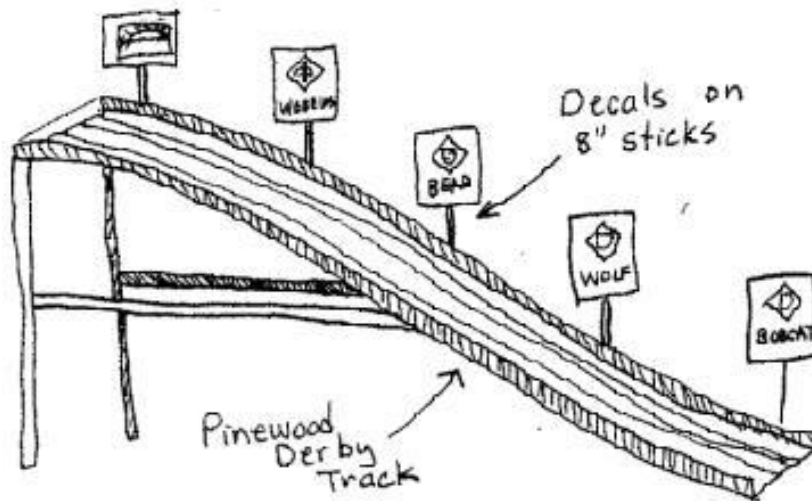

Cubmaster: "We've all had a great time tonight watching the pinewood derby cars race down this track. They really speed downhill don't they? Well you can go uphill on this track too. It's a little harder, but it's worth the climb. From Bobcat to Wolf, to Bear to Webelos and to the Arrow of Light. Some of our Cub Scouts have been climbing this course and now we're going to show how far they've gotten. Will the following Cub Scouts who have made the climb to Wolf please come forward with your parents?" When the boys have assembled, remove their awards from the track and have the parents pin badges on. Do the same for Bear badges and arrow points. Have the Webelos den leader take over for Webelos activity badges, Webelos badges, and Arrows of Light. Cubmaster resumes if you have a boy graduating into a troop.

Victory Lap

Have the boys run around the track area as their "Victory Lap" before giving them their awards.

CRAZY FANS

Have the den leaders and other pack leaders pretend to be the press, the paparazzi, or crazy fans trying to get an interview, picture or autograph of the "winners" of tonight's race. Have them do this (or rotate thru ideas) with every boy because every boy IS a winner! Don't forget to do some great cheers too.

CLOSING CEREMONIES

TO FINISH IS TO WIN – Closing (or opening) Ceremony

Cubmaster: If you take a moment tonight to contemplate these cars, you will realize that an awful lot of painstaking work went into each one. There is much creativity and ingenuity represented here. I don't know, but I imagine that each car was designed to be the fastest. Of course, not all cars will win. As we begin our pack meeting, keep in mind that in Cub Scouting, as in life, the victors are those who put forth earnest effort. As a great marathon runner from Kenya, a country in Africa, once said "To win is to finish. To finish is to win." Please join me in the Cub Scout Promise (or Pledge of Allegiance if opening)

PINEWOOD CLOSING

Form a circle around the derby track

Cubmaster: "Coming together is a beginning. Keeping together is progress. Working together is success" This is a quote from the famous carmaker, Henry Ford. All of the dens come together to form the beginning of our pack. Keeping together at our monthly pack meeting is progress. Working together in Cub Scouting is surely a success story of which you can have a great part. Let's remember this in the coming months. Please repeat with me the Law of the Pack. Thanks for coming out for our Pinewood Derby tonight. We've worked together and made every boy in Pack ____ a winner!

Starting Line!



Finish Line!

CUBMASTER MINUTES

WHEN THE GOING GETS TOUGH

(Hold up a tire advertisement) Cub Scouts, tire manufacturers are constantly working to make a better tire -- one that can withstand the pounding and abuse that high-speed driving demands. In other words, a tire that 'can take it.' Like the tire, you and I are put to the test every day. When things are going along smoothly, it is not hard to get along. The real test is how well we do when the going gets rough -- when things don't turn out the way we want them to. At times like these, the Cub Scout Promise can help you carry on with the right attitude and to do your share without grumbling or griping. It will help you meet the test. Can you take it?

GOOD SPORT

The world is full of people who think it is a calamity if they lose a contest. They lose their temper and act like bad sports. A good sport will do his best, and if he loses, looks to the next game to do better and try to win. In Cub Scouting, we learn to be good sports, and to do our best, whether we win or lose.

AIM FOR THE STARS

The words, "Aim for the Stars" have an important meaning to Cub Scouts. Think of Thomas Edison who tried and failed hundreds of times before he perfected the electric light bulb. He never quit trying. A Cub Scout, who tries to do his best and keeps trying, is preparing himself for greater responsibilities when he becomes a man. What you do and how well you do it becomes your launching pad to "Aim for the Stars."

HONESTY

Lord Baden-Powell, the British general who started Scouting had a lot of good advice for Scouts, and I'd like to read what he had to say about honesty.

"Honesty is a form of honor. An honorable man can be trusted with any amount of valuables with the certainty that he will not steal it. Cheating at any time is a sneaking, underhanded thing to do. When you feel inclined to cheat in order to win a game, or feel distressed when a game in which you are playing is going against you, just say to yourself, "After all, it is only a game. It won't kill me if I do lose. One can't always win though I will stick to it in case of a chance coming. "

"If you keep your head in this way, you will very often find that you win after all from not being over anxious or despairing. And don't forget, whenever you do lose a game, if you are a true Scout, you will at once cheer the winning team or shake hands with and congratulate the fellow who has beaten you. "

WINNING ISN'T EVERYTHING

Some years ago a hard-nosed coach said, "Winning isn't everything, but it sure beats whatever's second" There's some truth in that. Everyone likes to win. Very few people enjoy losing. The trouble is that in every type of competition, there must be losers as well as winners. That's true in sports, Cub Scout Derbies, and in life. You and every other human being find that sometimes you have to lose. Perhaps your sports team loses a game on an unlucky break. Or maybe you work hard in school but get low grades. Should we win without trying hard? We know inside if we have truly done our best or not. As long as we have done our best we are winners. No, winning isn't everything. We can learn from our losses, too.

SKITS

I AM WHAT I AM

Setting: Boys wear large cardboard cut-outs of various cars. They come on stage one by one and speak their lines.

TOYOTA: I am a Toyota, oh so small; wind me up and I can crawl. Drive me out to the end of town then pick me up and turn me around.

CADILLAC: I am a shiny Cadillac driving to the store and back. I can purr so quietly Grandpa can sleep while riding in me.

V.W.: I am a little VW bug, so lovable...just give me a hug. Drive me up the hill so slow then down the other side I'll go.

DODGE: I am a Dodge with lots of class, built for many a lad and lass. I can go most any place and hold my own in any race.

OLDSMOBILE: The merry Oldsmobile I'm called. With all the latest, I'm installed. Shiny things are here and there so you can drive without a care.

CHEVROLET: I'm a Chevy, nice and plain, but in the world I can reign. Giving service for all who ask performing every little task.

THE BIG RACE - Audience Participation Skit

Narrator reads the following like a radio announcer with a lot of enthusiasm!

The audience is divided into groups. As their assigned word is read in the story, they make the sound:

WHITE = Whiz!

RED = Zoom!

YELLOW = Zip!

BLUE = Ca-Chunk!

The cars are ready. The flag is up. The race is set to go. The flag goes down, The cars are off... They're running toe to toe! The WHITE is ahead. The RED goes by. Here comes the YELLOW now. Here comes another one - it's BLUE. Whew, it sounds bad, wow!! The last lap now. The RED is leading, The YELLOW and WHITE close behind. I'm looking hard -- I see the BLUE. So far back, it's hard to find! The finish line is just ahead. That BLUE is coming up fast, I can't tell why ... The crowds on its feet ... They're yelling - The WHITE, the RED, The YELLOW, the BLUE, **have all finished in a tie!!**

SONGS

<p>RACE YOUR CAR (Tune: Row, Row, Row Your Boat)</p> <p>Race, race, race your car, Swiftly down the track, If we don't place first this year, Next year we'll be back!</p>	<p>IF YOU'RE GONNA BE (Tune: If You're Happy and You Know It)</p> <p>If you're gonna be a driver, Honk your horn. If you're gonna be a driver, Honk your horn. If you're gonna be a driver Then your honks are gonna show it. If you're gonna be a driver, Honk your horn</p>		
<p>THE DERBY'S TONIGHT (Tune: The More We Get Together)</p> <p>Our Boxmobile' s the greatest, The greatest, the greatest. Our boxmobile's the greatest, The derby's tonight. For your car and my car, And his car and all cars. Our boxmobile's the greatest, The derby's tonight.</p>			
<p>PINEWOOD DERBY SONG (To the tune: Camptown Races)</p> <table border="0" style="width: 100%;"> <tr> <td style="width: 50%; vertical-align: top;"> <p>Cub Scouts all join in the song, Do-da, do-dah! Pine car track am mighty long, Oh, do-day-day!</p> <p>Chorus: Going to run so fast, Going to get ahead, Bet my money on a blue pine car, Somebody bet on the red.</p> <p>Black cars, blue cars, green and gray, Do-da, do-da! Are running on the track today, Oh, do-da-day!</p> <p>Chorus: Going to run so fast, Going to get ahead, Bet my money on a blue pine car, Somebody bet on the red.</p> </td> <td style="width: 50%; vertical-align: top;"> <p>Pine cars do have lots of class, Do-da, Do-dah! Even though they don't use gas, Oh, do-da-day!</p> <p>Chorus: Going to run so fast, Going to get ahead, Bet my money on a blue pine car, Somebody bet on the red.</p> <p>They're the pride of all the Dens, Do-da, do-da! Built by Cub Scouts and their friends, Oh, do-da-day!</p> <p>Chorus: Going to run so fast, Going to get ahead, Bet my money on a blue pine car, Somebody bet on the red.</p> </td> </tr> </table>		<p>Cub Scouts all join in the song, Do-da, do-dah! Pine car track am mighty long, Oh, do-day-day!</p> <p>Chorus: Going to run so fast, Going to get ahead, Bet my money on a blue pine car, Somebody bet on the red.</p> <p>Black cars, blue cars, green and gray, Do-da, do-da! Are running on the track today, Oh, do-da-day!</p> <p>Chorus: Going to run so fast, Going to get ahead, Bet my money on a blue pine car, Somebody bet on the red.</p>	<p>Pine cars do have lots of class, Do-da, Do-dah! Even though they don't use gas, Oh, do-da-day!</p> <p>Chorus: Going to run so fast, Going to get ahead, Bet my money on a blue pine car, Somebody bet on the red.</p> <p>They're the pride of all the Dens, Do-da, do-da! Built by Cub Scouts and their friends, Oh, do-da-day!</p> <p>Chorus: Going to run so fast, Going to get ahead, Bet my money on a blue pine car, Somebody bet on the red.</p>
<p>Cub Scouts all join in the song, Do-da, do-dah! Pine car track am mighty long, Oh, do-day-day!</p> <p>Chorus: Going to run so fast, Going to get ahead, Bet my money on a blue pine car, Somebody bet on the red.</p> <p>Black cars, blue cars, green and gray, Do-da, do-da! Are running on the track today, Oh, do-da-day!</p> <p>Chorus: Going to run so fast, Going to get ahead, Bet my money on a blue pine car, Somebody bet on the red.</p>	<p>Pine cars do have lots of class, Do-da, Do-dah! Even though they don't use gas, Oh, do-da-day!</p> <p>Chorus: Going to run so fast, Going to get ahead, Bet my money on a blue pine car, Somebody bet on the red.</p> <p>They're the pride of all the Dens, Do-da, do-da! Built by Cub Scouts and their friends, Oh, do-da-day!</p> <p>Chorus: Going to run so fast, Going to get ahead, Bet my money on a blue pine car, Somebody bet on the red.</p>		

GAMES

AUTO RACE

Acquire 4 small cars. Set some chairs up in 4 long rows so the audience can pass the cars quickly down their lane (row) and back to the start. They need to make 4 laps (passes), the first lane to finish wins.

ASSEMBLY LINE RELAY

Equipment: Pinewood Derby track and Regulation Derby Cars which are carved, weighted properly but with wheels that can be removed fairly easily. Also need graphite and other removable parts desired.

Have a work table and equipment (hammer, pliers, etc.) for each team. Divide group into two teams. Each team member removes wheels, lubricates and replaces wheels at work table, then runs to track and sends car down the track. First team to finish wins.

AUTO ASSEMBLING

Cut auto pictures from magazines, then cut them up into puzzle pieces. Place each puzzle in an envelope and give one to each guest. Instruct them to assemble the car puzzle. Give a prize to the person who does it quickest.

CHAUFFEUR

The names of makes of cars are given to the guests. "It" is the chauffeur. He calls the names of two makes of cars, and they have to exchange places. While the change is being made the chauffeur tries to get one of the places. If he succeeds, the one left standing becomes the chauffeur. When the chauffeur says, "Auto turns over," all must change places, and the one who fails to get a seat becomes the chauffeur.

BLOW-OUT RACE

The group assembles, facing the leader in parallel lines. About thirty-five feet in front of each group a sufficient number of paper bags has been placed so that each person may have a bag. At the sound of the leader's whistle, the person in the front of each line races to the chair, picks up a bag, inflates it, pops it, and races back, touching off the next person in front and taking his place in the rear of the line. The first group to finish, wins.

AUTOMOBILES

Scouts are in a circle and they count off by fours. Automobile names are then substituted for the numbers. (Example: 1's are Model A's, 2's are Mustangs, 3's are Corvettes, etc.) One Cub (or leader) stands in the center of the circle, the leader calls out the name of one of the cars (Mustang) and all the boys with that car name run counter-clockwise around the outside of the circle, back to their place, and into the center of the circle to touch the leader. The first boy to touch the leader wins the race. The game continues until all cars have run once. For final "heat" the winners of each of the car races runs. A final race can be an "all runner" race.

CUBMOBILE DERBY

(Refer to the Cub Scout Leader How-to Book, pages 6-33 thru 6-36, for more information.)

The Cubmobile derby is a colorful, thrilling pack activity that is fun for the whole family. Planning for the derby should begin several months before the race date, so that Cub Scouts and adults from each den will have time to build a racer.

That's right! Each den builds its own Cubmobile, with dads or other adults helping to supervise the construction.

There is no engine; the Cubmobile works by gravity. Follow the guidelines for planning special pack activities. Each pack family should be furnished with an information sheet listing the rules, awards, procedures, building specifications, date, time, and place. This will help prevent any misunderstandings.

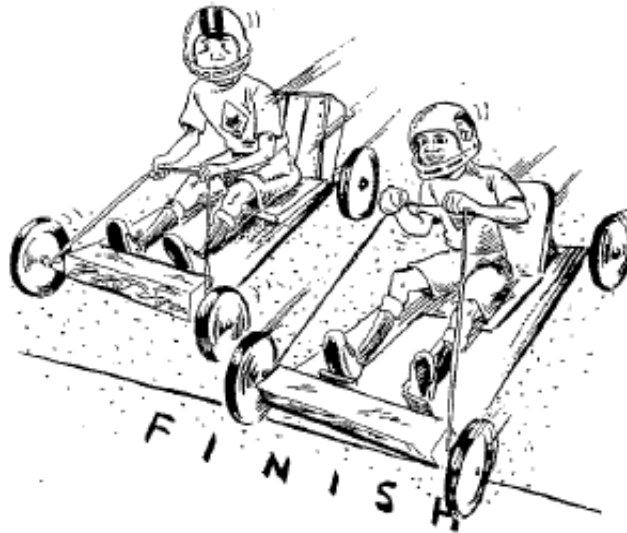

CUBANAPOLIS

(Refer to the Cub Scout Leader How-to Book, page 6-18, for more information.)



This is a race where the boys and families can all have fun. The boy builds a car out of a cardboard box that is big enough for him to pull up around his waist, but small enough for him to easily run while holding on to the sides. The family becomes the "pit crew" for the boy.

Before the race, set-up a course with an area for the drivers to pull over and make a pit stop during each lap. At each pit stop the driver, with their pit crew's help, should do one of the following activities:

- ◆ Wash windshield (squirt then wipe drivers face, glasses or goggles).
- ◆ Fill-up with gas (drink a glass of water, could use a straw to make it tougher).
- ◆ Change the tires (remove shoes and socks, put socks on inside out and put shoes back on).

Use your imagination as to the activities and number of pit stops the boys have to make, but don't make too many

Prizes or ribbons are awarded for first, second, and third places in each heat. Just as in Pinewood Derbies, there may also be a contest for most original designs, best workmanship and other categories.

AWARD IDEAS

Here are over 100 ideas for some awards that you can give besides just 1st, 2nd and 3rd place:

Paint Job Awards:

1. Best Paint Job
2. Shiniest Paint Job
3. Best Use of Color
4. Best Detail
5. Most Decals
6. Most Sparkles
7. Smoothest Finish
8. Yellow Submarine
9. Fire Engine
10. Black Night
11. Blue Bomber
12. Lean Green Machine
13. Silver Streak
14. Black Widow
15. Orange peeler
16. Radical Red Racer
17. Red Hot Hot Rod

Looks/ Design Awards:

18. Most Realistic
19. Coolest Design
20. Best Funny Car
21. Most Original Design
22. Low Rider
23. Best flames
24. Best Stripes
25. Most Flashy
26. Most Glossy
27. Most Sleek
28. Most Graceful
29. Sportiest Looking
30. Best Workmanship
31. Best Use of Imagination
32. Most Humorous Car
33. Most Futuristic
34. Most Patriotic
35. Most Accessories
36. Best Use of Kit
37. Best Design

38. Most Graphic Covered
39. Coolest Design
40. Most Unique Shape
41. Most unique design
42. Best Block of Wood
43. Most Ingenious
44. Most Vibrant
45. Most Elaborate
46. Most Intricate
47. Most Inventive
48. Best use of coins
49. Most Innovative
50. Most Authentic
51. Most Massive
52. Most Miniscule
53. Most Comical
54. Most Detailed
55. Most Original
56. Most Creative
57. Most Artistic
58. Most Multicolored
59. Most Classic Design
60. Most Luxurious
61. Knight Rider
62. Best use of Theme
63. Best use of Decals
64. Best use of Weights
65. Most sporty
66. Most Decorative
67. Mighty Midget
68. Most Unconventional
69. Best use of Materials
70. Most Unique
71. Most Unusual

Fastest Cars/Boat/Rocket:

72. Fastest in the Pack
73. Fastest in the Den
74. Most Aerodynamic
75. Lightning Bolt

76. Fastest Looking
77. Best Turbo
78. Fastest Take-off
79. Most likely to fly
80. Fastest Start
81. Fastest Finish
82. Speeding bullet
83. The Eliminator
84. Velocity
85. Warp Speed
86. Star Chaser
87. Jet mobile
88. Speedster
89. Underdog

Judges Favorites Awards:

90. Best of Show
91. Most Destructive
92. Most spectacular crash
93. Akela's Pick
94. Best Sportsmanship
95. Cubmaster's Favorite
96. Best Pit Crew
97. Smoothest Landing
98. Best Ground Crew
99. Best Skipper
100. Baloo's Pick
101. Den Leader's Favorite
102. Crowd's Pick
103. Wheelie Machine
105. Most Likely to Launch
106. Judges Pick

Regatta Specific Awards:

107. Most Sea-Worthy
108. Topsy-Turvy
109. Sportsman "Ship"
110. The Big Wind

CHEERS AND APPLAUSES

Checkered Race Car Flag: - Wave arm in figure 8 motion in front of you.
Model T Horn: - "Hooga, hooga, hooga!"
Model "T" – Push nose with finger, "Beep, Beep", then with hand, "Honk, Honk" and finally push stomach, "AH-U-GAH, AH-UGAH".
Pinewood Derby - Hold your right hand above your head and bring it down with the hand pulling in front of you like a pinewood car racing down the track. Say, "swish, swish, swish!"
Go Cart: - Move hands in a downhill motion and shout, "swish, swish, zoom!"
Flat Tire Cheer: - Pretend you're driving a classic car, "Chug, Chug, Putt, Putt, BANG!!" then "PSSSSSSS" like air coming out of a tire. Start out loud then as you slowly sit down go softer.
Flat Tire Fix - Bend down and pretend to attach a pump to a tire. Lift and push on pump three times, then say, "Boom" and jump back in surprise.
Race Track Cheer: - Move your head left and right, back and forth and say "Zoom, Zoom, Zoom!"
Car Applause: make motion of turning key in ignition and sound of reving up engine. End with screech for brakes. (Step on brakes)
Boat applause: Make motion of rowing boat repeating "heave ho". Then sight land and shout "Land Ahoy"
Supersonic: Silently wave arms, open mouth as if cheering... Wait several moments, then yell loudly
Race Car Cheer: Say "Varooooom" 5 times starting quietly and increasing in loudness each time.
Blast-off: Start counting backwards from 6 to 1. Bend the knees a little more on each count until you are in a squatting position. Then, while saying, "BLAST OFF!", jump straight up in the air.
Dip Stick Applause – Pretend to check the oil in your car and yell, "You're a quart low."
Start your Engines – The Cubmaster yells "Gentlemen, start your engines!" Everyone makes engine sounds. Do it a few times asking them to get louder each time. Add the action of turning a key to start the engine and/or stepping on the gas pedal to rev the engine.
Motorcycle cheer: Hold your hands like you're gripping handlebars. Raise a foot and kick downward 3 times while making a sputtering sound. On the third try, the engine starts with a "Varoom!"

CRAFTS

Here are a few ideas for ways to make a display stand for the cars and boats:

Make a Stand/Trophy with some scraps of molding and a spark plug or out of wood painted. Either paint the date/year on them or adhere a label (see photos below)

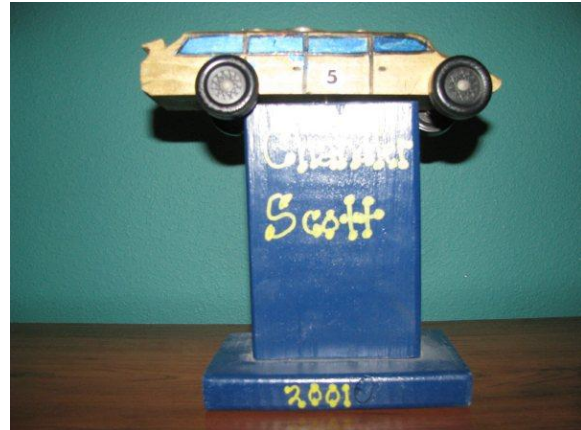

For Raingutter Regatta boats you can just cut a slit in the top of a wide piece of wood (like a 4x4) and place the keel and rudder inside. Then decorate as you want (see photos below)



DERBY COLORING PAGES

Have some race or car/rocket/boat themed coloring pages for the little ones to keep themselves busy with. You could even have awards for them and their pictures.

NECKERCHIEF SLIDES

Make a special Derby Neckerchief slide from a sliver of molding for the Pinewood Derby. Or cross two checkered flags.



You could also glue a hot wheel to your choice of back (see Neckerchief slides in the Craft Section of this Pow Wow book for ideas) or just attach an extra wheel or other related item.

PINEWOOD DERBY PLAQUE

Enlarge the pattern below to the desired size. Cut out of wood and let the boys sand and paint them. Drill holes and glue 1/4" dowels in the holes to hold their pinewood derby cars. Put a saw tooth hanger on the back to hang it on the wall.

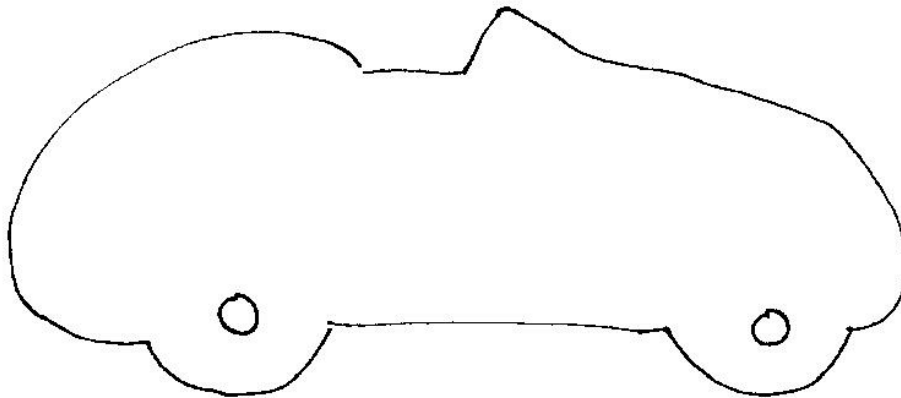

You could also leave a spot for a picture of the boy and his car to be inserted later.

INSPECTION BOX

A useful item to make for your Pinewood Derby is a wooden box whose inside measurements are exactly that of the maximum height, length and width of a car. Place a car inside to see if it fits within the regulations.

RAINGUTTER REGATTA

Raingutter Regatta is perhaps the easiest derby to run in terms of equipment, set-up and racing vehicles. All you need is two raingutters, a water source, and boats that will fit into the raingutter. The race can be held indoors or outdoors—but if you hold it indoors - make sure it is okay to get the floor wet.

Brand new - July 2011 an inflatable Raingutter Regatta track is available. It has 2 lanes and fits on top of 2 standard 6ft tables. - 2 types of boat kits also



You can place the gutters on top of a table, on the floor/ground or in a special holder like the one pictured below or there are instructions in the *Cub Scout Leader How to Book*.

The Cubs build sailboats that can fit into the raingutter. These can be made from the official BSA Raingutter Regatta kit, or fashioned from Styrofoam, balsa wood, or any other floatable material. Each boat needs a sail that boys can blow on to propel the boat through the water. Decide what kind of boats the boys will build. Time and materials could be provided at den meeting

to help boys get started.

There are many ways to craft the boats. Some ideas of modeling the boats are, besides using a pocket knife, to use a potato peeler, others use a very hard grit of sandpaper to shape the boat, once the desired shape has been achieved then a fine grit sand paper can be used to make the boat smoother.

When painting the boat spray paint can be used (acrylic and other water resistant paints can also be used). To get a smooth shiny finish try using a fine grit sand paper and very lightly sand in between coats of paint, it may take 4-5 coats of paint to get it very smooth.

The object of the Raingutter Regatta is to blow your boat to the other end of the raingutter before the other person does. This is tricky, because it is not always the boy who can blow the hardest that wins. Knowing where to blow is 80% of this race. Variations: Blow thru a straw, use a small fan, use a squirt bottle w/water, use squirt guns. There are various ways to get the boat to the other end. Try a few if you wish.

One variation of the Raingutter Regatta is known as the Veggie Regatta. Boats can be fashioned from hollowed out zucchini, cucumber, or potatoes.

Experience has shown that it is best to have one family member designated as the “first mate” (mom or dad preferably) and they are the one that stands the boat back up should it tip over.

For even more tips for building winning boats and other ideas search the Internet (just type in “Cub Scout Raingutter Regatta” in your favorite search engine and you will find lots of information.)

You might let them practice first to learn how to blow. When practicing, have the boys start from opposite sides of the raingutters to avoid racing. Or one at a time. This will help them to focus on blowing techniques rather than racing.

Have the boys remove their hats/neckerchiefs. These can hit the boats and sink them or push them forward

As with any of the derbies the rules should be given ahead of time and posted at the event to help avoid any potential problems. Make sure everyone knows what to expect before the race begins.

SPACE DERBY

The Space Derby can be made to be very *competitive* or very *low-key*. You decide which way fits the needs and personality of your pack.



Many packs use the standard—the fastest rocket wins the race—way of running the race. Another version is to make large cardboard cutouts of planets and place them on the floor under the derby track. The Cubs try to get their rocket closest to a certain planet. You can give awards (ribbons, stars on a ribbon, small candies, etc.) to the closest, then move the planets around and try again.

Use participation awards and recognize boys who have done a great job decorating their rockets. Make sure everyone is recognized. Certificates, neckerchief slides and patches make inexpensive yet fun awards.



You may be able to rent a track from someone in your area, or you could build one. (See the Cub Scout Leader How-to Book for details.)

The Space Derby can be a little tricky, you should let the boys practice before the race. Show them how to attach the rocket to the carrier, which way to wind the rubber band and release the rocket. If you can designate one or two leaders as the “Official winder” with the adapter and a drill – winding goes much faster.

Be sure to have extra rubber bands because they do break. Be sure to have a pre-race inspection to make sure that their propellers are put on correctly. When building their rocket putting the small plastic sleeve on the wire and getting it bent right is usually where the most problems come.

MORE FUN ADDITIONS:

Have them check in with **Mission Control** for a pre-launch inspection and picture. Then have them place their rocket in the **holding area** – clothes pins hanging on one of the lines can easily and safely hold the rockets not being raced. Have “**ground control**” be in charge of who is next and get them to the **launching pad** (starting line) Have fun thinking of ways to make it more like a real shuttle/rocket launch.

- **Speed.** First rocket to reach the finish line wins.
- **Endurance.** Last rocket to reach the finish line wins.
- **Relay.** Use two or more guidelines. Boys form teams of twos. The first boy releases his rocket, and as soon as it reaches the other end of the line, his teammate removes it, rewinds it, puts it back on the guideline, and releases it. The first rocket to return wins.
- **Altitude.** String a guideline which is about 12 inches from the ground at the starting line and 5 feet at the finish line. Gradually, raise the high end of the line until all rockets have been eliminated. The one which climbed the highest wins.
- **Just For Fun.** Have rockets break balloons at the finish line. Do this by inserting several straight pins through a piece of cardboard. Suspend the cardboard from the finish line and place a balloon in front of the pins. The rocket will drive the balloon into the pins.



BIKE RODEO IDEAS

(North Trails District, Detroit Area Council, BSA)

At a bike rodeo boys can easily earn the bicycle belt loop. And there are many different achievements and electives that they can pass off too. Be sure to let parents, brothers and sisters bring their bikes/scooters/tricycles etc. and participate too. Your focus can be on safety, learning and Fun!

Bike Garage

Purpose: To learn how to correctly make a repair to your bike. Parents and Leaders may need to assist at the various mini-stations.

Mini-Station #A - Tire Repair (WEBELOS have priority)

Achievements:

- Webelos Handyman #5 - Fix a flat tire (OR Adjust chain, or seat. DO ONE)
- Webelos Handyman #7 - Properly inflate the tires on a bicycle

Instruction:

1. Tire Changing- Rider removes front tire from a bike. Empty the air from tire. Take tire and tube off from rim. Then place tube and tire back on rim and fill with air. Apply tire patch to practice tube.
2. Properly inflate your bike tires- Using tire gauge and pump inflate tire to correct pressure. Look on tire for what correct pressure should be.

Mini-Station #B – Bike Adjustment (Bikes needing repairs during Rodeo can come here and use the tools)

Achievements:

- Webelos Handyman #5 - Adjust chain, or seat (or fix a flat tire. DO ONE)
- Webelos Handyman #6 - Properly lubricate Bike Chain

Instruction:

1. Bike Saddle (seat) and Handlebar adjustment- Learn the proper way to make adjustments. Using proper tools adjust the seat -Learn how to adjust the handlebars.
2. Bike Chain adjustment - Learn the proper way to adjust your bike chain. If needed make the proper adjustment.
3. Properly lubricate the bike chain - Using Teflon Spray, apply to rear hub and spin chain to spread

Mini-Station #C – Air Pressure Check (Bears)

Achievements:

- Bear: Achievement 14d - Tire Repair

Instruction:

1. Apply tire patch to practice tube.
2. Properly inflate your bike tires. - · Using tire gauge and pump inflate tire to correct pressure
- Look on tire for what correct pressure should be.

Basic Bike Skills Challenge

The Bike Rodeo Basic Skills Challenge is self-guided by Den Leaders or Parent. The purpose of these 13 stations is to help the scout learn the skills needed to control his bicycle. The physical development of the boys in this age range varies widely. These stations may sound simple but performing them can be difficult for the boys. The stations also help them develop their coordination and reflexes.

The instructions for each station are listed below. If you don't have enough leaders to have one at each station just leave the instructions for the leader or parent to read.

Please make sure each boy does his best at the stations and does not just rush through them.

Station#1 - Mounting and Dismounting

Course: 2 parallel lines about three (3) feet apart, each 60 Ft. long.

Purpose: To demonstrate starting and stopping while maintaining control of their bike.

Instructions: Put front tire at one end of the lane with bike at a dead stop. Rider must mount their bike and then steer it to the other end without losing balance or swerving out of the lines, and then dismount at the end of the lane. Many boys will have trouble controlling their bike when starting from a complete stop.

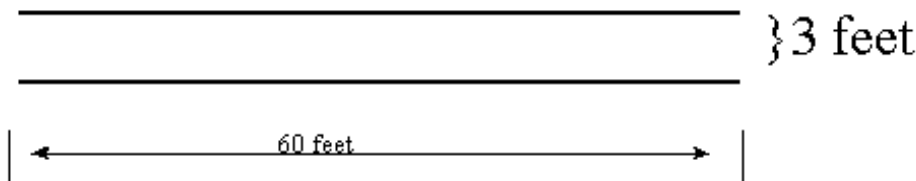

Station#2 - Circling and Changing Direction

Course: A figure 8 course with a 1.5ft lane. Each circle made up of a 12'ft diameter inner circle and 15' ft. diameter outer circle. The entrance is at one end of the figure 8. Exit can be same end or other end. Mark route with chalk arrows drawn on pavement.

Purpose: To test balance and steering control while changing directions.

Instructions: Rider should start to right and maneuver through the circles in a figure 8. This tests the rider's ability to control their bike on simple curved course.

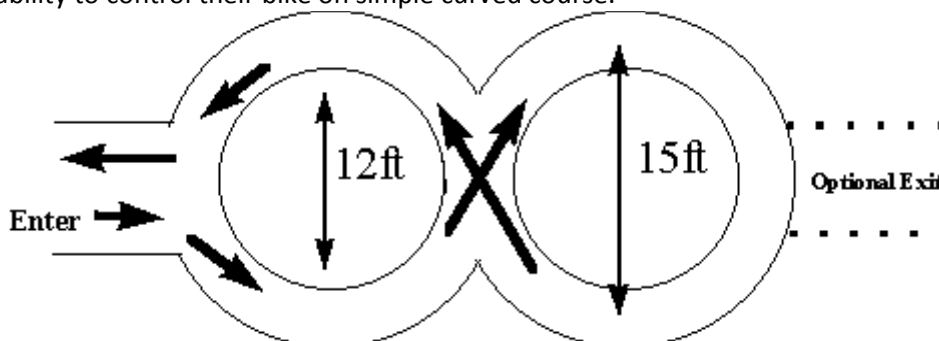

Station#3 - Diminishing Clearance (Straight Line Control)

Course: Two straight lines 60ft long, beginning with 18" width between lines going down to 4" width in the first 30ft. The last 30ft are at the 4" width between the lines. Small cones can be put down every 10 feet or so along the path. Rider can have 20ft before the lines to start, if space is available.

Purpose: To test balance and steering control.

Instructions: Rider starts before lines begin and then rides between the lines to the end without crossing the lines. The narrowing of the lines requires the rider to steer straight and forces them to be more controlled in riding.

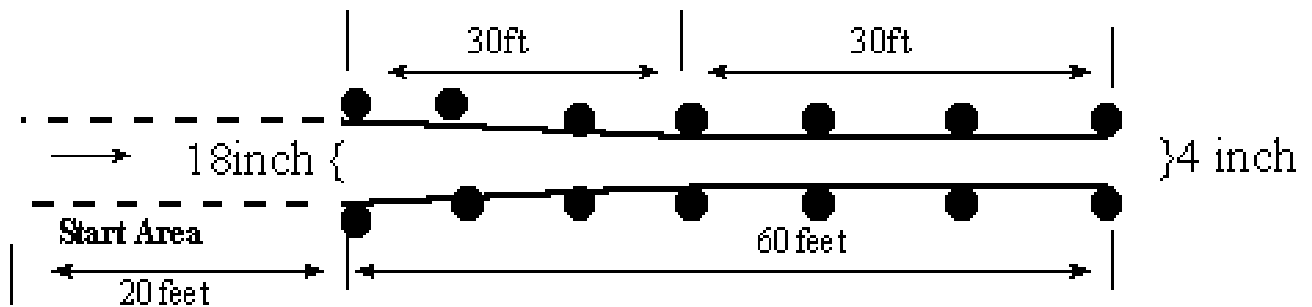

Station#4 - Weaving and Maneuvering

Course: A 40ft course marked about every 8 feet with cones. Mark a starting area before the course for rider to get started. Mark locations of cones with tape or chalk in case they get moved.

Purpose: To test balance, steering control and the rider's ability to judge distance.

Instructions: The rider shouldn't hit any obstacles and should weave alternately to the right and left. This tests the balance of the rider and also helps them to control their bike when they need to navigate past road obstacles such as drain grate, trash, or other things found in the road.

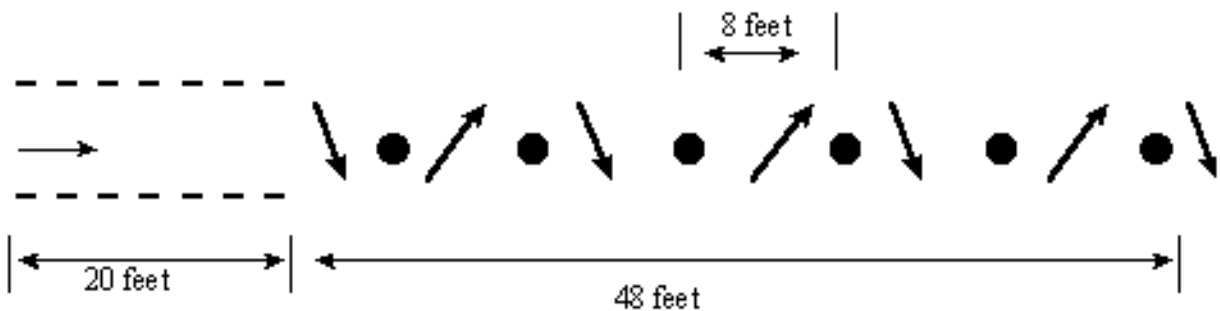

Station#5 - Stopping Ability

Course: Two 60ft lines space 3ft apart. 50ft from the beginning (ten feet from the end), mark a STOPPING line between the two lines. NOTE: The stopping line can be hard for rider to see, a STOP sign placed at the stopping line is a good idea.

Purpose: Test judgment and braking control.

Instructions: Rider should ride through the first 50 feet and be able to bring the bike to a complete stop before touching either foot to the ground within the last 10 feet. Rider starts to brake at first line and tries to stop close to end line. Stop the bike without putting foot to ground. This simulates an emergency stop and helps the rider learn how to control their bike in that situation.

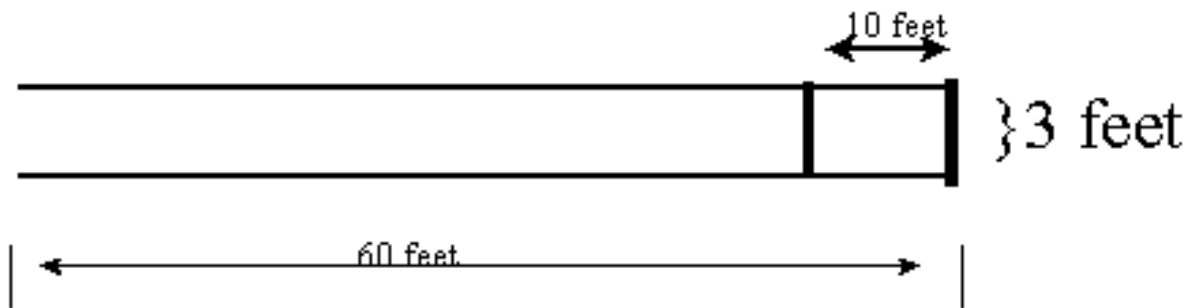

Station#6 - Short Radius Turning

Course: A 3ft wide course that goes straight for 20ft and then turns 180 degrees to another straight 20' section and then turns sharply again into a final 20ft straight section. The straight sections are 4ft apart. (See Diagram below). A good way to mark this out is to use 3 side-by-side parking spaces. The 3ft riding lane and 4ft space are one space, the next lane and space are another space, then use 3ft of the third space. Now connect with circular line drawn in chalk.

Purpose: To test balance, speed control and steering coordination.

Instructions: Rider should maneuver through the course without veering over the lines or putting a foot down balance. We are teaching bike control over a curved course that may also confuse rider.

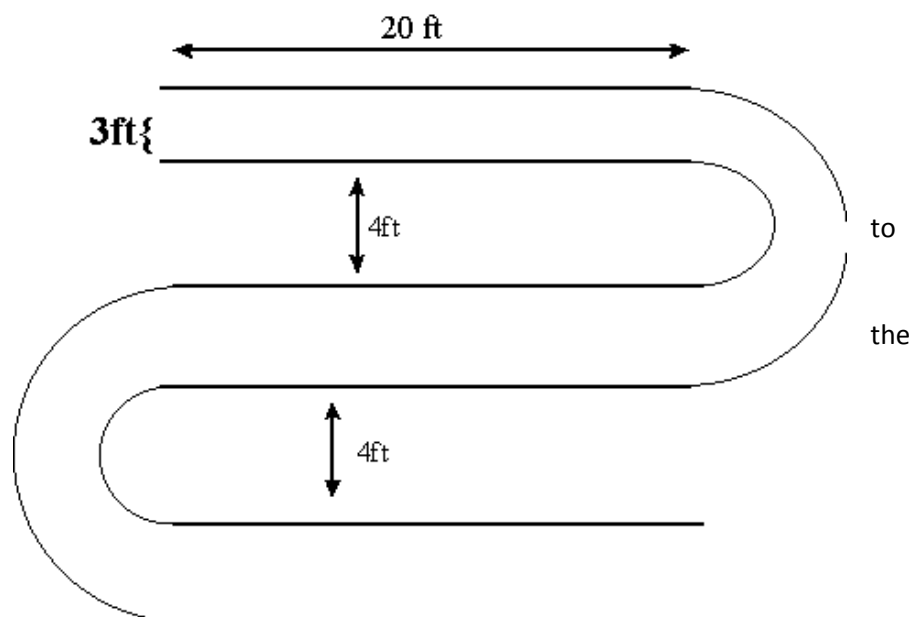

Station#7 – Turtle Crawl (Slow Speed Control)

Course: A 3ft wide straight course that is 60ft long.

Purpose: Rider should maneuver the bike at a slow speed, requiring at least 30 seconds to travel from start to finish.

Instructions: Rider starts and tries to ride to the end under 30 seconds without putting foot to ground or stopping. Rider can begin in runway area. They don't have to start from dead stop at timing line. If a stopwatch is not available have the boys ride as slow as possible. How slow can they go without touching the ground. Ultimate bike control is where it's at.

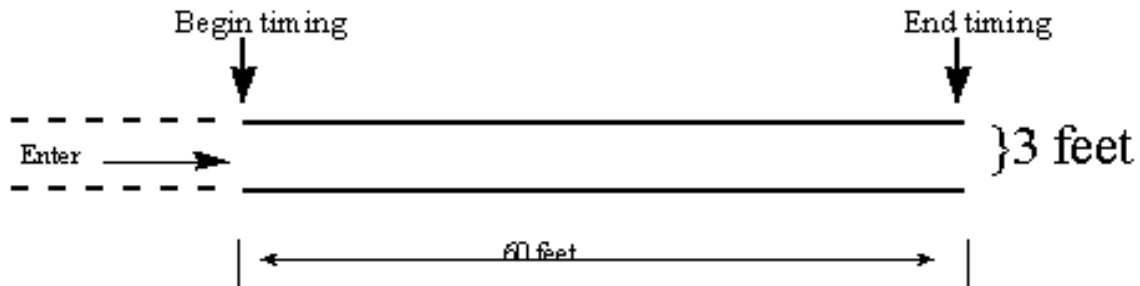

Station#8 – Tight Turns

Course: Four U-shaped bays of diminishing size. Sizes 12'x10', 12'x8', 12'x6', and 12'x4'.

Riders start at top of each bay and ride down and around making the turn.

If successful they proceed to next smaller bay.

Purpose: To enhance balance and control skills

Instructions: The rider will enter the widest bay first. If they successfully make the turn without putting a foot down or stopping, they move on to the next smaller bay and proceed on until they have gone through all 4 bays.

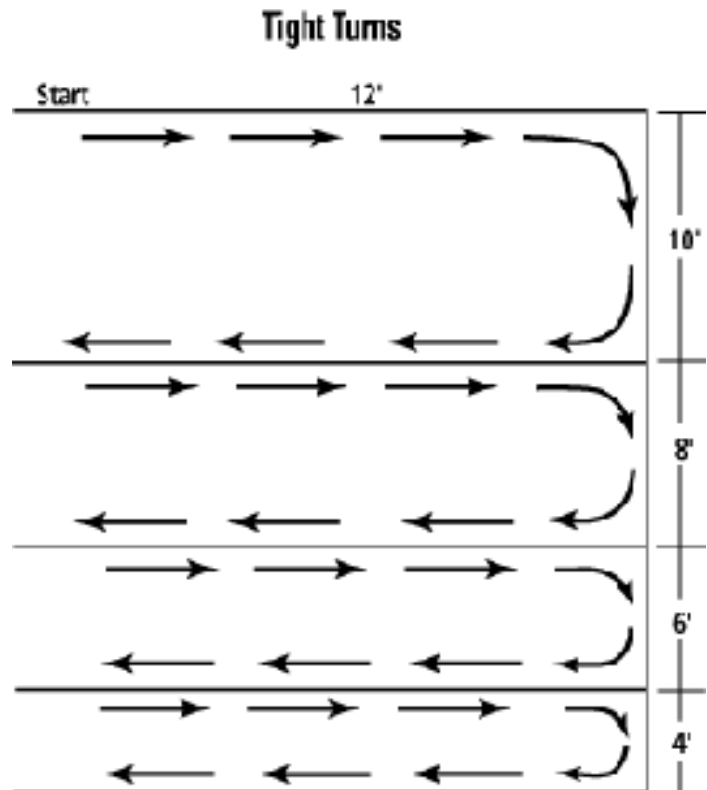

Bike Safety First Challenge

Cub Scout Bike Rodeo Challenge

These stations are designed to provide practical experience for the boys on how to ride safely on the road. From learning how to safely ride out of their driveway, to how to watch for traffic at stop signs, and the correct use of hand signs, these scenarios will reinforce the need for safety. Parents and leaders are expected to assist the station leader at this event.

Station#9 - Scanning (Looking Behind)

Purpose: To teach children to look behind for traffic and not swerve while doing so.

Instruction: Ask kids why they need to look behind them while riding?

(They need to look for cars, trucks and other cyclists, or pedestrians for those who ride on sidewalk).

Explain that this station will help them learn to look behind them without swerving.

Each child will ride next to the line and you will be walking about 10 feet behind them holding the cardboard car sidewise so they cannot see the front of it. Tell them when they hear their name they are to look behind and tell you whether there is a car coming. You will hold the cardboard car in front of you when there is a car coming and sideways when there is no car.

Make sure the kids look over their left shoulder. Watch to see if the child veers when looking behind; if so, have him/her practice again straight using the line as a guide. Call their names several times, sometimes showing the car and other times not showing the car to them.

Materials: One car silhouette made up of cardboard, chalk to mark the start and finish lines.

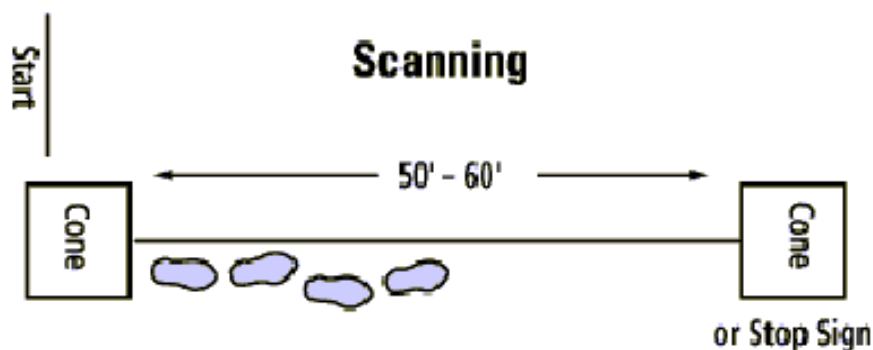

Option 2

Stand behind them while they ride along a straight painted line. Hold **up numbered or colored cards** and have them practice looking back over their shoulder and telling you the number or color of the card -- without riding off the painted line. Next, have your children practice the lane change process: Look back over the shoulder, signal, look again, then change lanes.

Station#10 – Crazy Crossroads

Course: A 4-way intersection with 10' with traffic lanes. Each side runs 20' out from intersection. Stop Sign at intersection where rider starts.

Purpose: To teach children to stop at stop signs and watch for cars.

Instructions:

- Tell kids this is a street intersection. Have them get in line and approach the stop sign, where they stop, look both ways, then proceed, making hand signals as appropriate for left and right turns.
- Have two volunteers hold the cars (car facing means traffic coming; car turned away, traffic is clear). Make sure kids stop at sign then move far enough to see traffic and again look both ways before proceeding.
- Watch for these errors:
 - Child does not stop, or looks only one way before proceeding.
 - Child sees a car and waits, but does not check again before proceeding.
 - Child making left turn places self too far to the right while waiting (or vice versa for right turn).
- Ask what else they should stop for (red lights, yield signs, uncontrolled intersections). Ask what yield means, and explain that stopping means putting both feet on the ground.

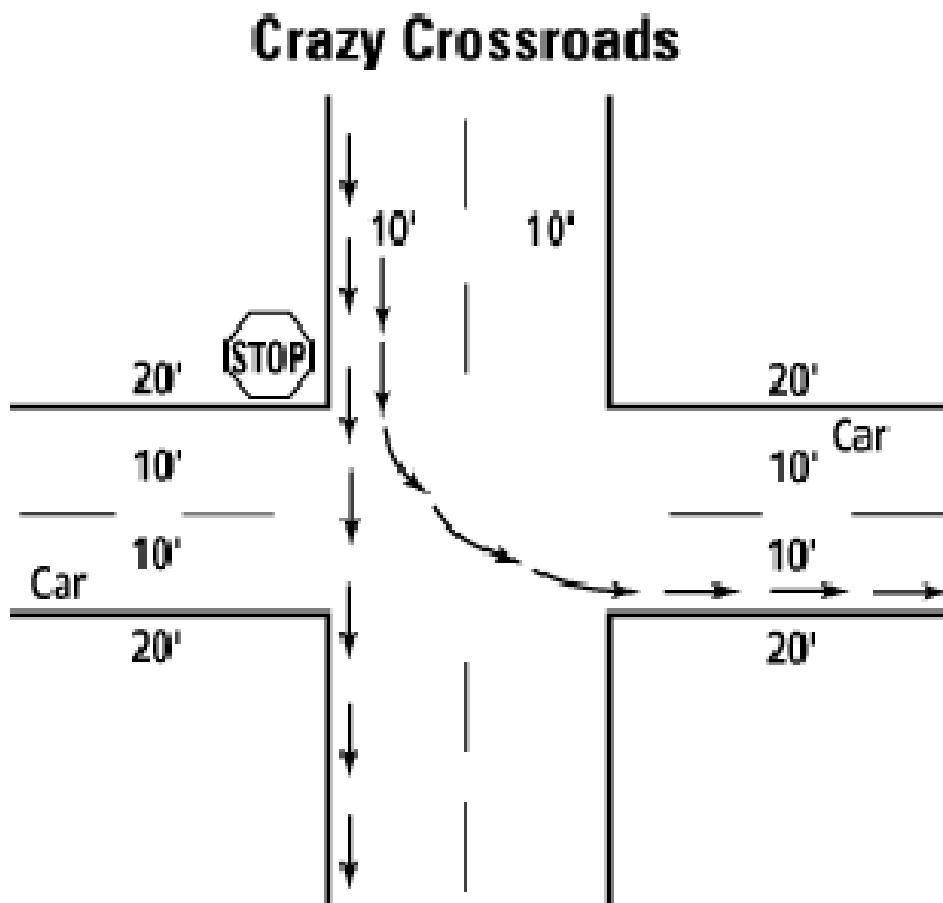

Station#11 – Rock N’ Roll Alley

Course: Set up course similar to diagram below. Use sponges for Rocks and cardboard for a drain grating. Course is approximately 20’ long.

Purpose: To teach children control and balance, and how to avoid hazards.

Instruction:

- Tell kids that this station is to help them practice missing hazards like rocks in the road so they won’t fall from their bikes or swerve in front of passing cars.
- They are to ride between the sponges and avoid the middle sponge by riding around it. The trick is to stay between the sponges and not swerve through them.
- Have them wait at the other end and practice going back in the opposite direction. As they become more skilled (and time and crowd permits), move the side sponges in a little.

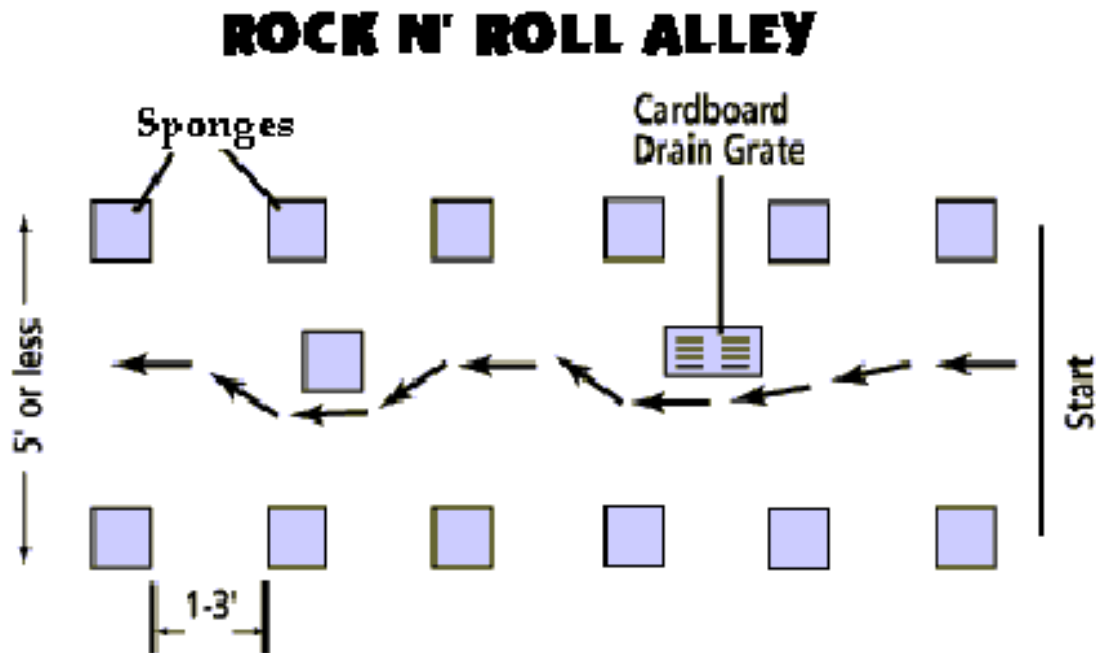

Station#12 – Street Course Maze

Achievements:

Wolf: Achievement 9d, Bear: Achievement 14a&b, Webelos Readyman #7

Course: A 3ft wide course that features right and left turns, a stop sign, and emergency stop. (Try and make corners like intersections and draw in chalk the way the turns should go)

Purpose: Riders must use proper hand signals with making turns, must stop at stop sign, and must make emergency stop when signaled without losing control.

Instructions: Course Leader directs the riders through the course. Riders negotiate the street course making the proper hand signals at the turns. When Course Leader signals, the rider must make a safe emergency stop.

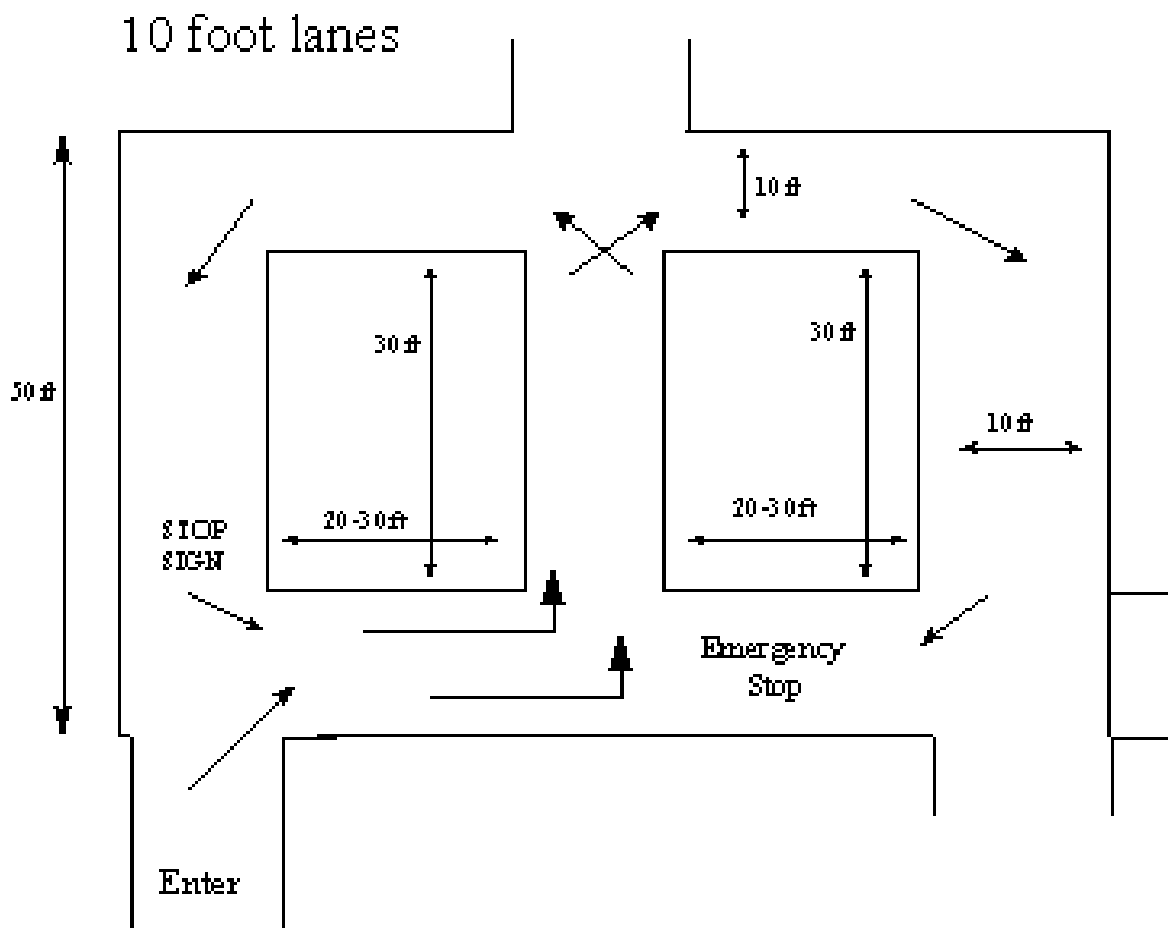

Station #13 – Driveway Rideout

Course: A driveway going out to a street. Driveway is 10' long and has something simulating a bush or fence blocking view to left as you leave the driveway.

Purpose: To teach children to stop at the end of their driveways and safely check for cars before turning onto street or sidewalk, then stopping correctly at intersection.

Instruction:

- Explain to kids that this is their driveway. Ask what they should do at the end before entering sidewalk or street (stop and look both ways). Ask them what to look for; cars, trucks, other bicycles, dogs, cats, and pedestrians.
- They are to ride to the end of the driveway, stop, look both ways, and then give a hand signal for a right turn. (Have the group practice right hand turn signals: either extend the right hand out horizontally or extend the left arm straight, bending the elbow and pointing upward).
- Have a volunteer hold the car (if facing the driveway, traffic is approaching; if turned away, traffic is gone). Use the fence/bush as a sight obstruction: children will have to move forward to see around it.
- Watch for these errors:
 - Child looks only one way.
 - Child gives turn signal while riding out of the driveway, riding with one hand only.
 - Child fails to look for traffic.
 - Child looks to left, then right until clear, then rides out without final check for traffic.
- Ask kids which side of the road they are supposed to ride on. Ask if they ride with or against traffic. Remind them that it is illegal and dangerous to ride against traffic because cars are not expecting them there. Make sure they stay to the right as they proceed into the street.

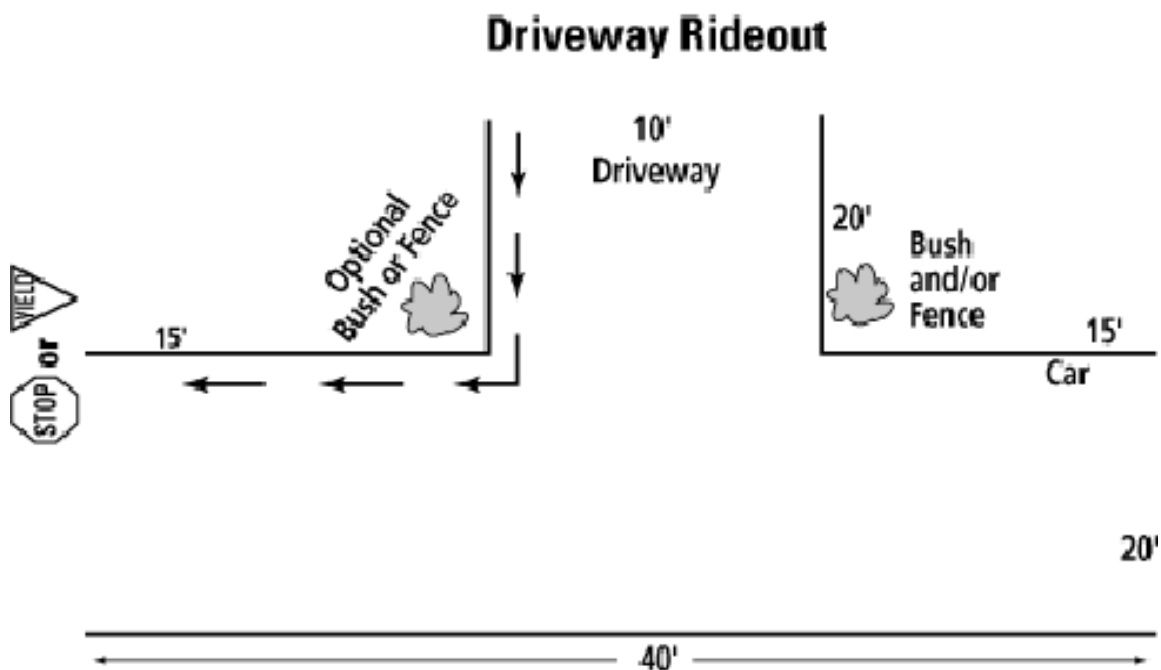

SUPER DEN CHALLENGE

This event for the Bike Rodeo Challenge is designed to quiz the boys on Safety, give them a chance to ride their bikes in races, and test their memory skills. Points will be awarded, but in reality they are worthless except for bragging rights. No official scores will be kept or prizes awarded. It's all for fun.

Please expect these events to be tweaked and adjusted up to and during the event to keep the flow going and eliminate any problems that may come up.

Den Challenge #1 - YOU ARE "THE WEAKEST BIKE CHAIN LINK"!

Purpose: To reinforce the rules for safe bike riding.

Course: 4 stations where teams stand

Instruction: Teams of 4-6 boys will be made. Several Dens (team) will be competing at the same time. Each team will receive 4 large cards with the letters A, B, C, D written on them. The teams will be shown and read a bike safety question with 4 possible answers labeled A, B, C, or D. Each team must then select from their cards the letter that they believe is the correct answer. When all teams have made their selections, they will be revealed at the same time. An Adult Leader must be present for each team to participate.

Scoring: Each correct answer will be worth 5 points. Special Bonus Questions may be worth more. Winning team gets 5000 points, 2nd place 3000, 3rd place gets 2000, and 4th place gets 1000.

Den Challenge #2 - WHERE WAS THAT AGAIN??

Purpose: To help develop memory skills and give the boys a chance to rest. (Old fashioned Concentration or Memory game)

Course: A 10-20 foot chalk circle in which there are 20 pairs of "things" covered in some manner.

Instruction: Teams of 4-5 boys will be formed. Several Dens will be competing at the same time. Each team member will take turns trying to match the items hidden beneath the covers. Turns will rotate between the teams. Each side takes their turn in order, being sure to rotate the team members who are doing the guessing. Team mates can suggest and coax the guesser, but the "you move it", "you uncover it" rule is in effect. Only the boy guessing can go into the circle and uncover the items. When a match is made the covers are carried to the correctly guessing team for scoring. An Adult Leader must be present for each team to participate.

Scoring: Team with most pairs of covers wins. Winning team gets 5000 points, 2nd place 3000, 3rd place gets 2000, and 4th place gets 1000.

Den Challenge #3 - CIRCLE THE WAGONS

Purpose: To have fun.

Course: A group of cones or plastic soda bottles will be set along the edge of a 20' circle marked on the ground. (Note: Mark locations of cones with tape or chalk in case they get moved.)

Instruction: Teams of 4-6 boys will be made. Several Dens will be competing at the same time. One at a time, riders take turns pedaling around the circle as fast as they can. Each rider will go 2 times around the circle, then the next rider will take off until everyone in the team has ridden. An adult will be in the center of the circle and will count how many cones/bottles get knocked down and will reset quickly. An Adult Leader must be present for each team to participate.

Scoring: Team finishes first gets 0 points, 2nd place gets 5 points, 3rd gets 10, and so on. Every cone/bottle knocked down is a 5 point penalty. Team with Lowest score wins. Winning team gets 5000 points, 2nd place 3000, 3rd place gets 2000, and 4th place gets 1000.

CIRCLE THE WAGONS

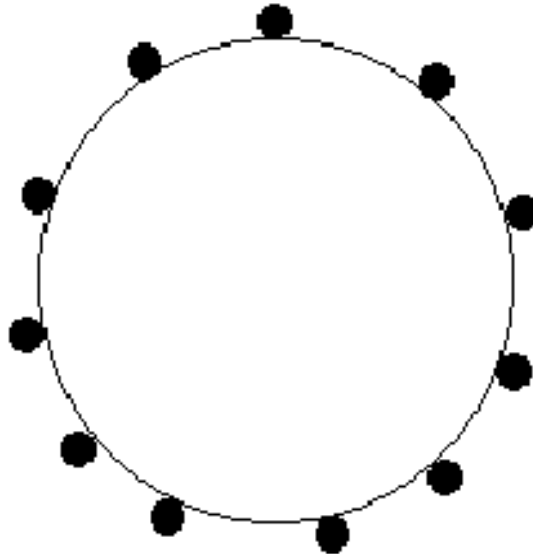

Den Challenge #4 - SNAIL RACE

Purpose: To enhance balance and control skills.

Course: Mark two parallel lines as start and finish (about 50' apart). Make several lanes approximately 3-10' wide between the start and finish (4-5 lanes). 5-6' wide lanes work good as smaller riders cannot control their bikes as well.

Instructions: Teams of 4-6 boys will be formed from each Den. Several Dens will be competing at a time. Explain that the winner is the team who can go the slowest and finish last without weaving out of their lane or putting a foot on the ground. The last team to cross the finish line wins. Riders cannot come to a complete stop and balance on their bike for more than a few seconds. Teams will be divided up equally between the ends of the course. The next rider can start as soon the previous riders back tire has crossed the end line of the lane. Any rider putting their foot down or otherwise touching the ground suffers a 25 point penalty. Riders must keep moving or suffer a 50 point penalty. An Adult Leader must be present for each team to participate.

Scoring: 25 points for fastest team to complete, 50 points for 2nd fastest team, 75 points for 3rd fastest and 100 points for slowest team. 50 point penalty for stopping. 25 point penalty for putting foot to the ground. Winning team gets 5000 points, 2nd place 3000, 3rd place gets 2000, and 4th place gets 1000.

Slow Race

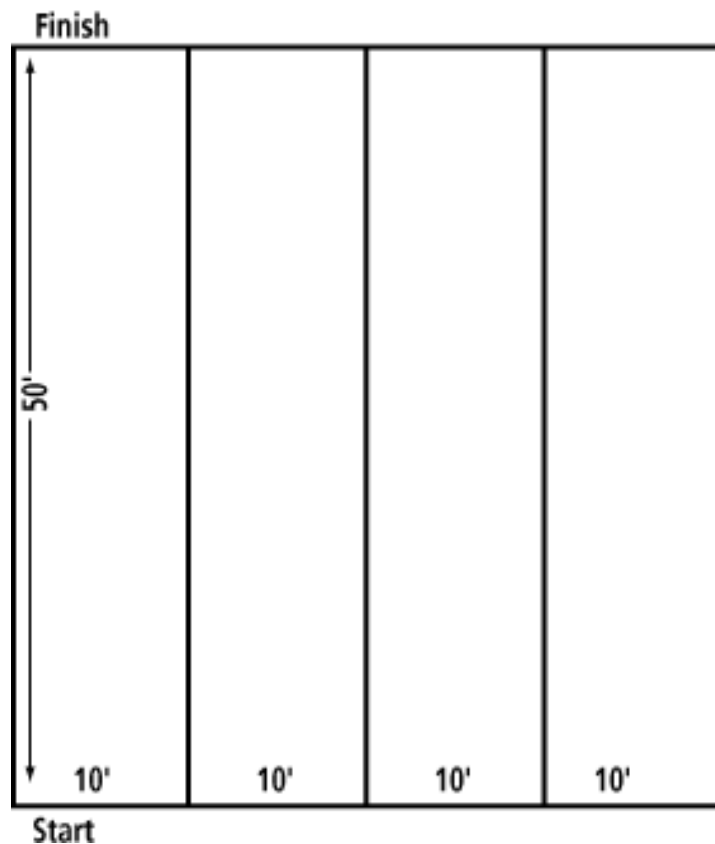

Den Challenge #5 - Newspaper Delivery Race.

Course: A 60ft straight line. 8ft from the right side of the line, starting 10ft from the beginning put a basket/box. Then place 5 more baskets/boxes every 10' down the line. Mark locations of targets with tape or chalk in case they get moved. (Note: This is a right-handed event. Left-handers may have problems.)

Materials: Event sign, Newspapers rolled up and taped so they don't come undone. Newspaper Carrier Delivery Bags

Purpose: Riders must maintain control of their bike while tossing newspapers into target area.

Instructions: Teams of 4-6 riders will be formed. Several Dens will be competing at one time. Each rider will have 5 newspapers to deliver. First rider delivers their load and then rides back down line to team. There the next rider will load his newspapers into the deliver bag and repeat the same process. An Adult Leader must be present for each team to participate.

Riders must stay to left of 60ft line. As they go along line they must throw a newspaper into the target without losing control of bike.

Scoring: 20 points for team who finishes first. 5 points for every delivery at least 3/4's in target area. (Be liberal in scoring). Winning team gets 5000 points, 2nd place 3000, 3rd place gets 2000, and 4th place gets 1000.

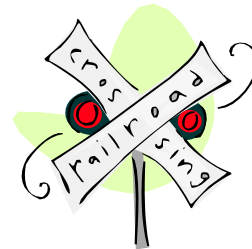

Note – For those in the **Utah County Area** – the Utah County Health Department (Promotions Department) in Provo has sets of minaiture street signs that they loan out for bike rodeos. They even have handouts with station descriptions (similar to those in this book). This really helps the boys feel like it's the "real thing". The signs are very helpful!

For those in other counties, check to see if there is something similar, avialible for your use.

Also - Some Cityies will even have a policeman come and register the bikes if you ask them.

Cub Scout

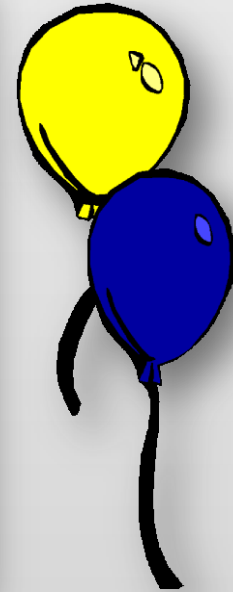
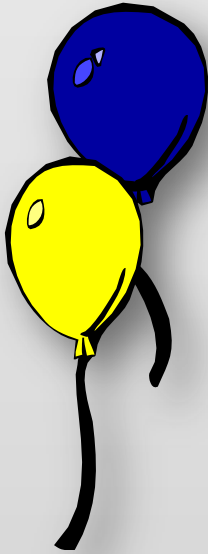

Blue and Gold Banquet

Everyone likes to celebrate their birthday, and Cub Scouting is no exception. A blue and gold banquet is a birthday dinner for Cub Scouting, usually held in February. February is the anniversary month of the Boy Scouts of America (organized in February 1910) and also the birthday of Scouting's founder, Lord Baden-Powell (February 22). The celebration is called the blue and gold in honor of the Cub Scout colors. The following pages have different tips and ideas to help you plan your blue and gold

PLANNING YOUR BLUE AND GOLD

PLAN your blue and gold banquet as early as possible to avoid conflicting with other events. Start planning at your annual program planning conference and follow up at your monthly pack leaders meeting. A good time to hold your banquet is on your regular pack meeting night. If this is not possible, then have calendars available from schools and other organizations affecting the members (such as your chartering organization) so that the blue and gold is not planned on the same night as other functions.

A CHAIRPERSON AND COMMITTEES involve more people and make less work. Ask parents face-to-face and one-on-one to do a definite job. Let them know exactly what you want them to do and how much time their involvement will take. You can also ask people in your chartering organization for help, and even friends and neighbors. Don't forget to say thank you. What kind of committees do you need? You could have a committee for:

- **PHYSICAL ARRANGEMENTS:** Where will we hold the event, how many tables and chairs, do we need special equipment?
- **DECORATIONS:** What is our theme, how can we decorate for that theme?
- **INVITATIONS:** Who do we invite, what should we use for invitations?
- **FOOD:** What shall we eat, how should it be financed, how should it be served?
- **PROGRAM:** What entertainment should we have?

INVITATIONS should be boy-made if possible. Nothing brings a smile to an adult as quickly as receiving an invitation made by a boy. Remember to put all five "W's" on the invitations: who, what, when, where and why. Cub Scouts can make and deliver invitations to their own families with an R.S.V.P. They can invite moms and dads, grandparents, aunts and uncles, family friends. Invitations to special guests should be mailed well in advance and contain an R.S.V.P. Who are these special guests? They can include, but are not limited to, the head of the chartering organization, the COR (chartered organization representative), the district executive, the unit commissioner, Scoutmaster, former unit leaders, and anyone who has made a contribution or an impact upon your pack. Boys who will be joining your pack in the upcoming year should also be specially invited guests.

DINNER – Everyone wants to know what's to eat. Try to center the menu on a theme and make the menu boy-friendly. Decide who will cook the meal and how it will be served. What you serve and how you serve it will be determined by your budget and what your pack prefers to eat. You can try:

CATERED: Meals are prepared through local restaurants or catering services. This is the most expensive form, and may require fundraisers or financing by charging per plate.

SEMI-CATERED: Prepared food can be purchased in large quantities. Pack leaders could serve the food buffet style. Some packs provide the main dish such as fried chicken, lasagna, meat for tacos, etc. and then ask families to contribute the remainder of the meal.

POTLUCK: To arrange a "potluck" meal, each family is asked to provide certain foods, usually one meat dish plus one other (salad, vegetable, dessert, etc.) for the size of their family plus two more people. This type of meal would be served buffet style. If you are relying on people to bring food, remind them plenty of times beforehand (try notes, phone calls, e-mails) so they don't forget.

ONE POT MEAL: Try a pack chili feed. Each family is asked to bring enough chili for their own family and it is all poured into a large pot. Each family brings a salad or dessert and the pack provides crackers, cheese, etc. from the pack budget.

DO IT YOURSELF: The pack can purchase and cook the main dish and ask each family to bring side dishes.

CAKE AND ICE CREAM: Skip the meal and hold a true birthday party with cake and ice cream. Ask each family to bring a certain item, such as cake, ice cream, sundae toppings, whipped cream, etc.

PLANNING YOUR BLUE and GOLD – Continued

Or, ask each family to bring ingredients for homemade ice cream and mix it up in an ice cream freezer. The pack can provide drinks and paper products.

PROGRAM – Your blue and gold should follow a program similar to your normal pack meeting program. Parts may need to be shortened to allow for time to eat.

GATHERING PERIOD: Have displays and exhibits. Also have games and something to keep the younger children busy until the meal is served.

OPENING CEREMONY: The American flag should be used in at least one part of the opening. The opening should introduce the theme and the program and set the mood for the banquet. It should remind Cubs and parents of the purposes and ideals of Scouting.

WELCOME AND INTRODUCTIONS: Welcome guest and Scouts and their families to the banquet. Attention is usually a little better before dinner, an ideal time for introductions of guests and leaders. Introduce last the person giving the invocation (a smooth transition to the next part of the program.)

INVOCATION: A pack leader, a Cub Scout, a parent or a religious leader may give the invocation. Ask the person in advance so there will be no embarrassment.

DINNER: YUM!

ENTERTAINMENT: This is a good time for your Cubs to shine. Let each den perform a skit or puppet show, or tell jokes or do some run-ons. Outside entertainment can also be used. Try to keep the entertainment short and sweet and interesting.

RECOGNITION: Spend most of the program time here. Recognition is the most important feature of the event because recognition of efforts, large and small, is important to boys as well as leaders. Cub Scouts, adult leaders and parents should be recognized by receiving badges, arrow points, certificates, small gifts and warm applause. Remember those who helped drive, assist leaders or go the extra mile. Awards are important to the Cubs and the Cubs are what the program is all about. Make the ceremonies extra special, a real night to remember. Use your imagination and adapt ceremonies to suit the theme or situation.

CLOSING: If the banquet follows the normal course, it will run a little longer than expected. Keep the closing short. At this point in the program, the “tone” of the meeting should become more serious. Close with something inspirational or patriotic.

HELPFUL HINTS: Include activities for all ages of children. Don’t make any one segment too long or your audience will get restless. Don’t start late, children usually eat early. Avoid speeches. Have fun, start on time, have a program. Recognize guests and honor leaders. Make award ceremonies memorable for the boys. Don’t forget applauds, run-ons and songs. Keep things moving-start on time and end on time. Be sure to finish before bedtime for the younger ones. **KEEP IT SIMPLE, MAKE IT FUN.**

GATHERING ACTIVITIES

BLUE AND YELLOW

Give each person or group a pencil and a sheet of blue or yellow paper. Ask them to write down as many things as they can think of that are blue (sky, flowers, sapphires, Cub Scout uniforms, etc.) or yellow (Crayons, taxis, hair, etc.). Prizes can be given for the longest lists or the most unusual items on a list.

MAKE A KEEPSAKE

Take Polaroid pictures of Cub Scouts and their parents, using a scouting backdrop. Glue them into a simple cardboard frame or folder as a special souvenir of the evening.

BLUE AND GOLD BANQUET QUIZ

How much do you know about Cub Scouting? Can you answer these questions?

1. Cub Scouting is ____ years old this month.
2. Scouting is ____ years old this month.
3. _____ is the founder of Scouting
4. _____ is the first rank in Cub Scouts.
5. How many achievements are required to earn the Wolf badge?
6. How many electives are required to earn a Gold Arrow Point?
7. There are (number) Webelos activity badges which can be earned.
8. The _____ of _____ is the highest award in Cub Scouting.
9. We belong to Pack No. ____.
10. We belong to Den No. ____.
11. There are (number) in our den.
12. _____ is our Cubmaster.
13. Our pack is in the _____ District, in the _____ Council.
14. (For parents only) My son is working on his _____ rank.
15. (For boys only) I need (number) more requirements to earn my next rank.
16. The Cub Scout Motto is, "_____."
17. What is the first requirement of a new Cub Scout?
18. How old is a boy when becoming a Webelos?
19. What color is the Bear neckerchief?
20. What are the colors in a Webelos ribbon?
21. Where does the flag go on a Cub Scout uniform?
22. Tiger Cub boys are in the _____ grade.
23. What country did Scouting start in? _____
24. The Cub Scout colors are _____ and _____.
25. Who was responsible for incorporating the Boy Scouts of America?
26. What is the Anniversary date of the Boy Scouts of America?
27. What is the Anniversary date for Cub Scouts in America?
28. What color background is worn with Cub Scout service stars?
29. What color background is worn with adult leader service stars?
30. Boy's Life is (1) an autobiography requirement for the Wolf badge (2) a current movie (3) a magazine for boys (4) a new TV show.

Answers: 1) 79; 2) 99; 3) Robert S. Baden-Powell; 4) Bobcat; 5) 12; 6) 10; 7) 20; 8) Arrow of Light; 16) Do Your Best; 17) Bobcat; 18) 10yrs old or 4th grade; 19) Light Blue; 20) Green, Yellow and Red; 21) Top of right sleeve; 22) first; 23) England; 24) Blue, Gold; 25) William D. Boyce, a Chicago Publisher; 26) February 8, 1910; 27) February 10, 1930; 28) Yellow; 29) Blue; 30) 3

OPENINGS

THE MEANING OF BLUE and GOLD

Have prepared music playing- "America The Beautiful or "This Is My Country." Have the American flag displayed, with lights shining on it. NOTE: You may want to put a fan behind the flag or at the base to create a breeze, if desired. You need a leader and 4 boys to help with this ceremony.

Props: 4 quart-size fruit jars. The underside of the fruit jar lid should have 5 drops of cake coloring placed on the lid and dried onto the lid ahead of time. The four lids need to be marked on the top with either a B-C-Y or R. Fruit jars should be filled 1/3 full of water.

Cub 1 Holds up a quart fruit jar 1/3 full of water. The water will be clear.

CM: "The main color of our Cub Scouts is blue." The first boy shakes the bottle and the water changes to blue as the dried coloring and water mix. Blue represents the color of our sky, clean and pure as does the blue in our flag which stands for justice and pure virtues."

Cub 2 Holds up his jar. The boy shakes the jar. THE WATER WILL BE CLEAR

CM: "The water in the jar is still clear and clean and pure. The white in our flag's stars and stripes also stand for purity and our dreams for a better tomorrow in both thought and deed's a rule of conduct we all should heed. A reminder that all of our lives need to stay clean and pure."

Cub 3 Holds up his jar. Shakes it and the water turns a yellow-gold.

CM: "Yellow or gold is the other main color of our Cub Scout colors. Yellow or gold represents the sunshine and happiness of our lives. Health and happiness in a land of abundance and prosperity."

Cub 4 Hold up his jar and shakes it. The water turns red.

CM: "The color in this jar represents the red stripes of our flag. It reminds us that many people with courage and bravery have given their lives and their blood to protect this land and our freedom."

CM: "Let's now pour the clear water into the gold water. We still have the sunshine of life and happiness. Let's now pour the blue into the gold water. We now have the magic of green. Our country is a country of beautiful green valleys and mountains, a true land of freedom. Blue and gold have blended together to show we can work together for a better world. Now as we pour the red into the green, the jar turns black.

CM: So it is with our lives. If we live good lives that bring us happiness, the sunshine will always be there. The black illustrates that when we do things that are not right, our lives are filled with sadness or unhappiness because of our wrong doings. "Join with us in our Pledge of Allegiance to our Flag."

BLUE AND GOLD

Print large block letters on poster board, one letter to a sheet -- the word "BLUE" in blue, "AND" in black, and "GOLD" in red. Print script on back of each card - cuts memorizations to a minimum.

B is for boys --Bobcats, Wolves, Bears and Webeles

L is for Leader -- The Cubmaster who guides us

U is for Understanding -- We learn to help others

E is for Excellence -- We try to "Do Our Best"

A is for Anniversary -- Cub Scouting is ____ years old.

N is for Neighborhoods -- Where Cub Scout dens meet each week.

D is for Den Chiefs -- Boy Scouts who help us in many ways

G is for Goals -- For which Cub Scouting stands

O is for Opportunities -- For boys to learn and do.

L is for Liberty -- In the years to come.

D is for Den Leaders -- who love us and help us.

BLUE and GOLD WELCOME

PERSONNEL: 8 Cub Scouts

CUB #1: We'd truly like to welcome you, to our banquet of gold and blue.

CUB #2: The food is great, the program grand, and everyone lent a hand.

CUB #3: We're having a party, to celebrate Cub Scouting's birthday.

CUB #4: And we give our thanks to all those who, have helped promote the gold and blue.

CUB #5: Blue and gold are our colors true, no other colors would really do.

CUB #6: Blue is the color of the sky above, gold is for sunshine, warmth and love.

CUB #7: Come join us in our Cub Scout fun, and delight in our colors of sky and sun.

CUB #8: So now we'll say it loud and bold, welcome to our Blue and gold!

BLUE and GOLD FLAG CEREMONY

Narrator: I represent the spirit of Lord Baden-Powell, the founder of Boy Scouting. I am also the spirit of Scouting past and present. Here is our future...Cub Scouts of America.

1st Cub: (carrying a Bible) In the Cub Scout Promise, we say "I promise to do my duty, to God" and religious activities are part of our rank advancement program. I like to wear my uniform to church on Scout Sunday. Nearly half of all Cub Scout packs are sponsored by churches.

2nd Cub: (in complete uniform) I wear my uniform with pride. People know that I am a Cub Scout, growing straight and strong through Cub Scouting. There is only one official uniform. The colors of the uniform have meaning: Blue stands for truth and loyalty; gold for good cheer and happiness.

3rd Cub: (carrying Indian headdress) Early Cub Scout ceremonies were based on Kipling's Jungle Tales. When Cub Scouting was established in America in 1930. Indian themes were used. Akela was the big chief of the Webelos tribe to which all Cub Scouts belong. Chief Akela's father Arrow of Light, stated that all men were brothers and a tribe could be no greater than it's boys.

4th Cub: (carrying wood object) Cub Scouting means FUN! We have lots of fun, but I like making things - real boy projects. Cub Scout arrow points and Webelos activity badges give us many different projects to work on so we make useful things and learn new skills while we progress.

5th Cub: (carrying a collection) I like to go on hikes and collect things for my nature collection. Hikes help us to appreciate the outdoors and help us grow physically.

6th Cub: (carrying an American Flag) I am proud to be an American so I can salute our flag. I also like to see our Pack flag (points to flag) because then I know I am part of over 75 years of Scouting. I belong! When you salute the U.S. Flag you salute a lot of other things too. You salute your family, your friends, your Cub Scout den, your fellow Americans, and this land of freedom, because they are America!!!

Narrator: Yes, I represent the Past and the Present. These boys, Cub Scouts now, are the men of tomorrow. They will be the preservers of our American heritage. (Pause) Please stand and join us in the Pledge of Allegiance.



CLOSINGS

CM: "This has been a great blue and gold banquet. We have united together to be better Cub Scouts, Webelos Scouts, Tiger Cubs, Leaders, parents, and citizens. That is the purpose of Cub Scouting. To do your best."

This ceremony can be used as an opening or a closing. Have cut outs of a sad and happy boy. Read the story and show cut outs as needed in the story.

THROUGH A BOY'S EYES

I'd like to be a Cub Scout His eyes were deepest blue I'd like to learn, and play, and build, Like Jim and Freddy down the way.	"My mom is awful busy. She has lots of friends you see, She'd never have time for a den She hardly has time for me.	A boy is such a special gift Why won't you realize, It only takes a little time To put sunshine in his eyes
--	--	--

I know how to use a hammer. I can drive a nail if I try. I'm eight years old, I'm big and strong, And I hardly ever cry."	And dad is always working, He's hardly ever there. To give them any more to do Just wouldn't be quite fair."
--	---

I gave him the application And parent participation sheet. His eyes were filled with sunshine As he left on dancing feet.	He handed back the papers With a dignity beyond eight years, And smiling bravely, left me. His eyes were filled with tears.
--	--

Next day, my friend was back again, A dejected little lad, "I guess I'll skip the Cub Scouts." His eyes were dark and sad.	Do you see your own boy's eyes As other people may? How he looks when you're "too busy" "Just haven't time today"?
---	---

BOY POWER

Have a small birthday candle at each Cub Scout table setting and have larger candle on all tables. At the proper time, the Cubmaster announced that each Webelos Scout should come forward and receive a lighted candle to take to his table. After he reaches his table all other lights are turned off. (You can also use flashlights instead of candles)

CUBMASTER: America's manpower begins with Boy power. As we light all our candles, you can see the room is growing brighter (Cubs light their candles). That is the way it is in Cub Scouting in our community as we increase our Boy power. One Cub Scout may not be very big, but as our members grow we can light up all our homes and make everyone aware of our Cub Scout spirit. Let's make Cub Scouting really shine with Boy power. (lights come on and candle are blown out). Do your best.

Cub Scout respond: We'll do our best!

BADEN POWELL HAD A VISION

The following closing could be done by a den of boys standing up front and reciting together the first eight lines or have one of them as narrator, take a few steps forward and say:

Baden Powell had a vision,
That he made come true,
So now we can enjoy Scouting,
And have fun while we do.

While he wasn't an American,
He's become famous to us,
Earning though America,
Our admiration and trust.

(Adult leader faces audience and says)

Now may the Spirit of Scouting,
Be with both young and old.
As you remember again,
The meaning of Blue and gold.

May you strive for truth and spirituality,
In the warm sunlight under the sky above,
As you bring good cheer and happiness
With steadfast loyalty brought through love.
Good Night and Happy Scouting!!



Print large block letters with permanent markers on 8"X10" sheets of white poster board, one letter to a sheet -- the word "BLUE" in blue, "AND" in black, and "GOLD" in red. Add silver stars to the letters. Printing script on back of each card cuts memorizations to a minimum.

B is for boys --Bobcats, Wolves, Bears and Webelos
L is for Leader -- The Cubmaster who guides us
U is for Understanding -- We learn to help others
E is for Excellence -- We try to "Do Our Best"

A is for Anniversary -- Cub Scouting is ____ years old.
N is for Neighborhoods -- Where Cub Scout dens meet each week.
D is for Den Chiefs -- Boy Scouts who help us in many ways

G is for Goals -- For which Cub Scouting stands
O is for Opportunities -- For boys to learn and do.
L is for Liberty -- In the years to come.
D is for Den Leaders -- who love us and help us.

A LITTLE HISTORY and TRIVIA

(Santa Clara County Council Pow Wow Book, Feb. 1998 and From *Cub Scouting The first 75 years of Doing Our Best*)

HOW IT ALL BEGAN

On February 22, 1857, the shrill voice of a newborn baby boy was heard from the home of a family of gentlefolk in England. That voice was to be heard around the world. Over the next eighty years, the voice cried out for world friendship, international understanding and fellowship among the boys from every land. This was the voice of Robert Stephenson Smyth Baden-Powell. In his lifetime, Robert Baden-Powell did many things and all of them well. He was a student, illustrator, author, soldier, but most of all, he was a leader of men and boys. Baden-Powell wrote a book called *Aids to Scouting* to train the English Army. Many people were interested in his book, so he began to think that the same ideas might be used to train boys as well as soldiers. To try out these ideas, he held a camp for 22 boys on Brownsea Island, Dorset, in 1907. They swam, signaled, hiked and played games. Scouting had begun! Scouting was seen to be so much fun that before long younger boys were asking to become Scouts. So in 1916 Baden-Powell started the Wolf Cubs to provide fun and adventure for boys aged 8 to 11. Wolf Cubs learned to light fires, use a compass give first aid and keep themselves fit and healthy, as well as many other things. They also played games and went on outings. Cubbing had begun and soon it began to grow and grow.

HOW SCOUTING CAME TO AMERICA

In the fall of 1909 an American publisher, William D. Boyce from Chicago was in London, England on business. A dense fog made getting around in the city difficult and Mr. Boyce stopped under a street lamp to get his bearings. Out of the fog a young boy approached him and asked if he could help. So the boy helped Mr. Boyce find the business office he was looking for. When they had arrived there, Mr. Boyce began to give the boy a tip. "No, thank you, sir. Not for doing a good turn." And why not, Mr. Boyce inquired. "Because I am a Scout--and a Scout doesn't take anything for helping." "A Scout? And what might that be?" The boy, then told the American about the Boy Scouts and even took him later to meet the founder of Scouting, Robert Baden-Powell. Just a few months later on February 8, 1910, Mr. Boyce and some other Americans met in Washington, D. C., and incorporated the Boy Scouts of America. We don't know what happened to that boy because not only did he not take any money, but he did not give his name either. Think what an enormous difference that scout's Good Turn made. One Good Turn to one man became a Good Turn to millions of American boys. Such is the power of a Good Turn. Hence, the Scout Slogan: DO A GOOD TURN DAILY.

CUB SCOUT TRIVIA

Cubbing officially started in the USA in 1930. In 1945 it was changed to Cub Scouting. Originally the boys were called "Cubs", the adults leaders were "Cubbers" and a "Cub Scout" was a Boy Scout who had been a Cub. Dens were originally led by Boy Scouts who were called den chiefs. There were no den mothers. The original program called for them to complete two Bobcat requirements, then advance to Wolf rank (for 9yr olds), Bear (for 10yr olds), and Lion (for 11yr olds). The Webleos badge was created in 1941 for the 11 1/2 yr. old who had already earned his Lion Rank. Originally they held weekly pack meetings. A full Cub Uniform, including shirt, pants, belt, neckerchief slide, socks and cap cost \$6.05 in 1930. By the end of 1935 there were 57,000 boys and 9,500 adults registered in the Cub program.

CHEERS and APPLAUSES

(Some of our Favorite Cub Scout Cheers – Suitable for any occasion)

Big Hand: Leader says “let’s give them a big hand” Everyone holds up one of their hands up high with the palm facing out.

Bigger Hand - After giving a big hand (see above) say "even bigger" then put your mouth on your thumb and blow a couple times as if it were a balloon. Then put up the “bigger” hand.

Stereo Hand - after giving the big hand (see above) leader says “In Stereo” and everyone holds up their other hand also.

Good Turn: Stand up and turn around.

Round of Applause: While clapping hands, move them around in a circle in front of you.

Well Done: Say “well done” then have the audience echo it back to you.

Good Job: Say “Good Job” then pat yourself on the back.

Great Job: Group stands and says "GREAT JOB, GREAT JOB", getting louder each time.

Good Going: Group stands and says "GOOD GOING, GOOD GOING" starting off loud and ending softly.

Grand: Everyone is sitting down in their chairs. All stomp their feet three times loudly, then slap leg three times, then clap hands 3 times. Then stand up all together and shout "Ra, Ra, Ra!"

Stamp of Approval: Take your right hand into a fist and hit your left palm, as if stamping a letter.

“Six” Gun Salute: Point finger into sky and say Bang bang six times, then blow the "smoke" away.

Cracker Cheer: Hold imaginary cracker in hand. Pretend to take a bite. Smile and say "MMMM,GOOD!"

Big Sneeze: Cup hands in front of nose and sneeze in hands. Having nowhere to put it, wipe your hands in your hair.

Bravo: Spell out the letters “Give me a B”... Audience Yells “B” “Give me a R... A... V... O... Then all yell together BRAVO!

Cub Cheer: Call out in unison One Two Three... Go Cubs!

Eskimo Cheer: Brrrrr-rrr, Brrrrr-rrr.

Giant Beehive: Tell the group to buzz like a bee. When your hand is raised, the volume should increase. When you lower your hand the volume should decrease. Practice this at various levels

Relay: First person in row claps next person's hand and so on down to the end of the row.

CHEERS and APPLAUSES - Continued

Reverse Applause: Move hands away from each other.

Seal of Approval: Extend arms, cross hands at the wrist and flap hands several times. and say "Arf, Arf,"

Fire Engine: Divide the group into four sections:

- (1) Rings the bell fast, DING;
- (2) Honks the horn, HONK, HONK, HONK;
- (3) Sounds the siren, Rrrr, Rrrr, Rrrr;
- (4) Clangs the clanger, CLANG, CLANG, CLANG.

Have all four groups do their parts together.

Handkerchief: Tell the group that they are supposed to applaud as long as the handkerchief you throw is in the air, when it hits the floor to stop applauding. Variation: Catch the handkerchief instead of letting it drop. Vary the applauding by using short throws, long throws, throwing to someone in the audience etc.

Watermelon: Hold a piece of watermelon in both hands, (elbows bent, hands in front, palms up) make the motions of taking several bites, turn head and spit out the seeds.

Southern Watermelon Cheer- Say "Ya'll" after spitting out the seeds.

Samurai Warrior Watermelon Cheer –

- Hold the watermelon in both hands
- Toss watermelon into the air (Say swiiiish (or something like that))
- Pretend to pull out your sword hanging from your belt.
- With two hands on sword, slice the watermelon in half in the air above your head (say thooop or similar cutting sound)
- Catch the watermelon (Say Foooomppp or other sound to indicate the catch)
- Do standard watermelon cheer (see above)

Southern Samurai Warrior Watermelon Cheer –

Do the Samurai Warrior Watermelon Cheer (see above) then -Say "Ya'll"

Cantaloupe Applause: (Variation of Watermelon) Cup hands to hold cantaloupe, take one big bite, then spit out only one seed!

Grape Applause: Use in conjunction with the Watermelon and Cantaloupe applauses. Hold an imaginary grape between thumb and first finger. Pop grape into mouth with appropriate sound.

Fruit Salad: Do the watermelon cheer, then cantaloupe, then grape, then a cherry. (for cherry, put finger in cheek and pop out of mouth)

Politician Cheer: Pat yourself on your own back.

Mosquito: Slap all over self "Ouch, ooch, ow!"

Spider Applause: Walk all 4 fingers of one hand up the other arm and scream, "Eeeekkk"

CHEERS and APPLAUSES - Continued

Carpenter Applause: Pretend to be holding a hammer in one hand and a nail in the other. Start pounding the nail with the hammer while saying, "Bang, Bang, Ouch."

Fisherman Cheer: Pretend to reel out some line, let it drift, yank your pretend pole back and start to reel in the fish. Struggle with it for a short time and say: "I've Got It!!! I've Got It!!!"

Big thumb: Hold your arm out in front of your body, double your fist with the thumb up.

Personal cheer: Stamp feet three times, then shout the individual's name.

Pinky: Applause with little fingers only.

Eagle: Lock thumbs and flutter fingers like wing and shout "Cree, cree!"

Train: Tap hand going up arm saying "CHOO CHOO" louder and louder till reaching shoulder then make sound of blowing whistle. WHOO WHOO

Home run Cheer: Simulate swinging a bat at a ball, shade your eyes with your hand and yell (loud) "There She goes!"

The one you never heard -- Fake a clap but miss at the last moment

Stomp and Slap When you raise your right hand, everyone stomps feet rapidly. When you raise your left hand, everyone slaps thighs rapidly. When you raise both hands, everyone stomps and slaps.

Hand and Foot... Applaud with striking hand on foot.

Slow Motion Applause... Cheer and applaud in slow motion.

The Uncoordinated Applause... Clap hands, but miss completely

Abe Lincoln Cheer: "That was great! HONEST!"

Archery Cheer: Mimic shooting an arrow, "Bull's Eye!"

Bobcat Cheer: Stand and say "Meow" loudly three times.

Cub Scout Cheer: "Do Your Best! Be Prepared! Shout! Shout! Shout! Wolf Cub! Bear Cub! Webelos Scout!"

Pony Express Cheer: Have everyone gallop in place and shout, "YIPPEEEEEEEEEEE".

RECOGNITION

BALLOONS

Attach awards to blue and gold helium filled balloons or place awards on card stock that is made to look like a Cub or Webelos neckerchief

ADULT AWARDS

Honor a den leader, Cubmaster or other Cub Scout leader that has served your pack or in your area. Invite them as a special guest to your banquet. Give a short history on them. Include family members, church, community and scouting service, hobbies, etc. You might repeat a story from their Cub Scout service days that was special to them. Present them with a certificate of appreciation and a thoughtful token of Cub Scouting.

BLUE and GOLD BALLOONS ADVANCEMENT

Personnel: Cubmaster, boys and parents receiving awards

Equipment: Blue and gold (Yellow) balloons, one for each boy receiving an award. Fill with helium or attach to balloon sticks. Awards and verses from script need to be attached to balloons. A Decorated container for balloons or a cardboard cut-out of a Cub Scout or Cub Scout symbol to which balloons are attached. This could also be displayed as a centerpiece.

Cubmaster selects a balloon and reads the verse for that award and balloon. Have boys and parents come up. Parents present boy with his badge and boy pins the pin on the parent. Present boy with the balloon and verse that matches the rank he is receiving.

NEW CUB SCOUT FAMILY

This gold balloon is for _____
They are new to our pack.
May it bring you good cheer,
And keep you on the Cub Scout track.

BOBCAT :

A bright blue balloon for _____,
He's earned his badge for Bobcat.
May you stay loyal to Cub Scouts,
And remember "Do Your Best."

WOLF:

Another gold balloon, it's for _____,
The rank of Wolf he will obtain
May happiness shine for you always
As more Scouting knowledge you gain.

BEAR:

A blue balloon this time for _____,
The rank of Bear is his tonight,
May Akela watch over you each day,
As you share your Cub Scouting light.

WEBELOS:

This gold balloon is for _____,
Webelos rank is proudly awarded to him
May good cheer follow you throughout
As you climb to Scouting's highest limb.

ARROW OF LIGHT

Here's a blue balloon for _____,
To him top honors, the Arrow of Light.
May your example like an arrow,
Be straight, true blue and right.

THE DANCE OF AKELA

Need Red, White and Blue face paint and awards.

Personnel: Cubmaster (CM), Committee Chair (CC), Webelos Leader (WL), Den Leader (DL).

CC: Many, many moons ago, a small boy sat outside his teepee watching the stars in the sky, and listening to the rustle of the trees in the night. Somewhere in the distance he could hear the call of the Bobcat, the Wolf, and the Bear. Close by was the sound of the ceremonial drum calling all braves of the tribe to the Council ring. The boy listened and wished he could answer that call.

Quick and as true as an arrow in flight, quiet as the hush of the night, to the beat of that ceremonial drum, before a great fire they gathered, awaiting Akela, their chief. Here in the great Council fire ring, on top of the mountain, they met. Here too, they sought the help of the Great Spirit as they started to do their duty. Here they met Chief Akela, and awaited his words.

Now with the last "boom" of the great drum, all was silent. The night was still. The great ceremonial fire was lit and it began to light up the night. As the fire grew and grew ever larger, the tom-tom started slowly and set the rhythm. Akela stepped into the ring as the tom-tom beat first low and slow and then like thunder. Akela danced and with his movement told of his life. He told of the strength of his father, the one they called the Arrow of Light. He told of how his father taught him the signs of the tribe; how to make a bow and let an arrow fly true to its target. Akela obediently followed the Arrow of Light and gained great knowledge. Akela learned that the arrow for which his father was named was one that pointed upward, truly to the Eagle so high above.

Akela's dance showed how he, as a young brave, was trusted to set out into the forest. There he met the Wolf who taught him the ways of the wild life, of the ground, of the tracks, and ways to find food. He next faced the Bear and learned the meaning of courage and the importance of being brave. And with this Akela stopped his dance!

Akela, the wise, had closed his dance and presented the sign of the tribe and all of the tribe did likewise. No one spoke until Akela said: "Our tribe can only be strong when the boys of the tribe are strong. The future is hidden, but if we are courageous and brave; if we teach our boys truth and knowledge, to aim high like the eagle, to be fair, our great tribe will continue to be strong.

CM: My friends, you are like that small Indian boy wishing that you can answer the call of the great ceremonial drum and be members of the tribe. Every boy who joins Cub Scouts, whatever his age, first earns the Bobcat badge by learning the Cub Scout Promise, the Cub Scout Sign, the Cub Scout Salute, the Cub Scout Handshake, the meaning of Webelos, the Law of the Pack, and the Cub Scout Motto "Do Your Best."

CC: Would the following scouts and their parents please come forward? (List boys earning the Bobcat badge.)

CM: (scout's name), do you see the stars in the sky? That is the constellation Big Dipper and the big star is the North Star. For many years man has used these stars as a guide to show them the way as they traveled. As you join Cub Scouts you are starting a trip. You will experience adventures and excitement, meet new friends and learn new skills. However, as you begin this trip you need a "North Star" to guide you. The "North Star" is Akela ... Akela can be your parents, your Den leader, even I your Cubmaster. It is our responsibility to help you along the way.

THE DANCE OF AKELA CEREMONY - Continued – page 2

CM: (parents' names), I ask of you, will you accept the responsibility to be (scout's name) 'Akela', to help guide him along the Cub Scouting trail?

CM: (scout's name), you've already started your trip by earning the Bobcat badge. Congratulations! *(Present Bobcat badge to parents.)* (scout's name) , here also is a star for you to place in your bedroom. At night this star will shine, reminding you of your start on the Cub Scout trail. Pack ____, would you please join w/me in congratulating (scout's name) and welcome him to our Pack by giving him a "Cub Scout" cheer?

DL: Just as when Akela first went into the forest and learned from the Wolf, a Cub Scout who is 8 years old begins working on the requirements for the Wolf badge. Wolf Cub Scouts learn about Akela and the story of Mowgli and his survival in the Jungle. When a scout has completed twelve Achievements on the Wolf Trail, in such areas as physical fitness, exploring the world around him, fixing, building, collecting, safety, our flag, our family and our Duty to God, he receives his Wolf badge.

CC: Would the following scouts and their parents please come forward? *(List boys earning the Wolf badge.)*

CM: (scout's name), you've completed all the requirements for your Wolf badge and have moved along the Cub Scout trail. Receive now the mark of the Wolf, a red mark, symbolizing strength and valor. *(Mark each boy with RED face paint.)*

CM: It is my pleasure to award your Wolf badge to your parents, who have been your Akela in completing these requirements. Parents please award this badge to your son and congratulate him on a "job well done."

CC: We also have some boys who have earned their Wolf Gold and Silver Arrow points. Would the following boys please come forward to receive them? *(List boys earning Wolf arrow points.)* (Scout's name) has earned his gold arrow point, and (quantity) silver arrow points.

CM: Pack _____, would you please join with me in congratulating these Wolves by giving them a "Grand Wolf Howl" cheer?

DL: When the scout reaches 9 years old he begins working from the Bear book. Just as Akela met the bear with courage, the scout walks the Big Bear trail. On that trail he finds and conquers twelve challenging achievements in the categories of God, Country, Family and Self. He then receives his Bear badge.

CC: Would the following scouts and their parents please come forward? *(List boys earning the Bear badge.)*

CM: (scout's name) , you've completed all the requirements for your Bear badge and have moved along the Cub Scout trail. Receive now the mark of the Bear, a blue mark, symbolizing bravery. *(Mark each boy with Blue face paint.)* It is my pleasure to award your Bear badge to your parents, who have been your Akela in completing these requirements. Parents please award this badge to your son and congratulate him on a "job well done."

THE DANCE OF AKELA CEREMONY - Continued – page 3

CC: Today we are pleased to present arrow points to some Bear scouts too. These scouts have continued on the Big Bear Trail earning Bear arrow points. *(List boys earning Bear arrow points.)*

CM: It is my pleasure to award (scout's name) his gold arrow point and (quantity) silver arrow points. Pack ____, would you please join with me in congratulating these Bears by giving them a "Grizzly Bear Growl" cheer?

WL: When a boy is 10 years old, the boy is brought into the tribe of Webelos. He enters a Webelos Den. The boy prepares himself for Boy Scouting. He works on twenty different activity badges from five skill groups: Physical, Mental, Outdoor, Community, and Technical Skills. After three months in the Webelos Den and after earning three activity pins and learning about the Boy Scout ways, he earns his Webelos badge.

CC: There are Cub Scouts among us tonight who have earned their Webelos badge. Would the following please come forward with your parents to be recognized and honored by the Pack? *(List boys earning the Webelos badge.)*

CM: (scout's name), you've completed all the requirements for your Webelos badge and have moved along the Cub Scout trail. Receive now the mark of the Webelos, a white mark, symbolizing vigilance, perseverance, and justice. *(Mark each boy with White face paint.)* It is my pleasure to award your Webelos badge to your parents, who have been your Akela in completing these requirements. Parents, please award this badge to your son and congratulate him on a "job well done."

CC: We also have some scouts who have earned Webelos Activity Pins. Would the following boys please come forward to receive them? *(List boys earning activity pins.)*

CM: (scout's name) has earned (list activity pins). Pack ____, would you please join with me in congratulating these new Webelos by giving them the "Grand Stomp" cheer?

WL: The final and highest rank of Cub Scouting is the Arrow of Light. To earn it a boy must be a member of his Den for at least six months since turning ten years old and have earned the Webelos badge. He must have earned the Fitness, Readyman, and Citizen Activity Pins and five more for a total of eight. He must know the Boy Scout Oath and Scout Law from memory as well as the Boy Scout slogan, motto, sign and salute. He must have participated in a Webelos overnight campout or a Webelos day hike. He must have visited a Boy Scout troop with his parents and Den and taken part in a Boy Scout outdoor activity.

CM: The Arrow of Light is the only Cub Scout Rank which may be worn on the Boy Scout Uniform. As an Adult he can wear the special square knot badge to always recall his having earned the Arrow of Light.

CC: Tonight we have ____ Webelos Scouts who have earned Cub Scouting's highest award. Will the following boys and their parents please come forward? *(List boys earning the Arrow of Light badge.)* Long ago the Indian braves would collect eagle feathers. Regardless of how an Indian brave accumulated feathers, he was not allowed, according to tribal law, to wear them until he won them by doing a brave deed. He had to appear before the tribal Council and tell or re-enact his deed. If the Council thought the brave was worthy, the brave was allowed to wear the feather in his hair or war bonnet. These honors were called "counting coop." The Indian displayed his honors on his clothing, on a banner, or on a stick.

THE DANCE OF AKELA CEREMONY - Continued – page 4

CM: The Webelos scout "counts coop" by wearing the many rank awards and activity pins on his uniform, but he will soon be a boy scout and will not be allowed to wear them anymore. I want to present these Webelos with a banner displaying their own scouting honors. *(Cubmaster present banners to boys.)* You've completed all the requirements for your Arrow of Light badge and have completed the Cub Scout trail. It is our pleasure to award you this certificate of accomplishment, and award your Arrow of Light badge to your parents, who have been your Akela in completing these requirements. Parents, please award this badge to your son and congratulate him on a "job well done." *(CC awards boys their certificates; WL present the parents with the Arrow of Light badge and ask them to pin it on their son. CM presents the mother's pin to the boy and asks him to present it to his mother or father.)* The Arrow of Light is a significant achievement. It is recognized as such by the Boy Scouts of America. When you become a Boy Scout, you continue to wear the Arrow of Light on your uniform. When you become an adult leader, you wear a square knot which represents the Arrow of Light on your uniform. In view of that significance, I offer my sincere congratulations to each of you. *(Cubmaster shakes the hand of each scout and parent.)*

CM: In Boy Scouts, when they have an Eagle Court of Honor, a charge or challenge is made to the new Eagle Scout. Tonight, I want to offer such a challenge to each of you. You have achieved the highest rank in Cub Scouts. You have shown what you are capable of doing. Tonight you will be crossing the bridge from the Pack to a Boy Scout troop.

I challenge each of you to continue to live by the ideals you have learned in Cub Scouts, especially the Cub Scout motto: "Do Your Best". I challenge each of you to continue your high level of achievement in Boy Scouts. I challenge each of you to look at the Arrow of Light badge and think about what it represents:

The sun shedding its light on all that we do. A reminder that you should be a light for those around you. The seven rays of the sun representing the seven days of the week. A reminder that you should do your best every day.

The arrow which is symbolic of everything which is straight and true. Just as you should be straight and true in your life.

CM: I challenge each of you to follow where that Arrow of Light points: Forward on the trail of Boy Scout ranks. Upward to higher challenges.

I challenge each of you to soar to great heights and obtain the Eagle Scout Award. As your Cubmaster, I will be honored to join you, wherever you may be, to see you receive this achievement. Parents, Guests and Cub Scouts of Pack ____, would you please join with me in giving these boys a standing ovation for achieving the highest award in Cub Scouting? Congratulations and good luck!

Baden-Powell Advancement Ceremony - All ranks*Baltimore Area Council*

You can have one person read this or divide it into sections and have several people present. Minimizing the reading (memorization) always enhances a ceremony.

Tonight we are celebrating the birthday of Scouting and the ____th anniversary of Cub Scouting. Many of you know that Scouting started in England in 1907 when Lord Baden-Powell took seven boys to Brownsea Island for a camping experiment. But the roots go even farther back. In 1899, Baden-Powell was a Colonel in the British Army fighting the Dutch Boers in South Africa. Colonel Baden-Powell was in charge of a town called Mafeking. It was under siege by the Boers. The Boers shelled the town every day except Sundays. When that happened, everyone had to hide in trenches until the shelling stopped. Baden-Powell noticed that the last ones into the trenches and the first ones out were the young boys. He needed to keep these young lads from doing risky things and getting wounded. So he organized them into a Boys Corps. They ran messages from Headquarters to the troops and citizens, and they practiced Army Scouting skills. This helped him enforce discipline on them in a way that they could accept.

The food was running out, the Boer force was ten times the size of the British force, but Baden-Powell used his cunning to hold the town for 217 days, until British reinforcements could arrive and rescue the town from the Boers. When he got back to England, he found himself a National hero and a small book he had written for the Army, "Aids-to-Scouting", was being used by British boys to play games of Scouting. He remembered those boys in Mafeking and what his Boys Corps did for them. He rewrote his book into "Scouting for Boys" in 1908 and Boy Scouting was born.

The tradition Baden-Powell started in Mafeking, we are continuing tonight. When the boys in Mafeking learned their Scouting skills, they were rewarded with a promotion in rank. So too, do Cub Scouts, after showing their abilities in certain skills, earn their ranks of Bobcat, Wolf, Bear and Webelos. Would the following Scouts and their parents please step forward? (read names of award winners) You have learned new skills and have shown yourselves ready for promotion. Wear your new rank proudly like all Cub Scouts have for the last ___ years. (Read the name and award given, exchange the Cub Scout Salute, and let the parent pin on the award.) Lead a cheer after presentation of each award.



JUNGLE BOOK CEREMONY

(Great Salt Lake Council)

Preparation Ideas and Suggestions:

Use a Jungle Book theme for the banquet; and use it in giving the awards.

Seat the group to receive awards in a circle, adults towards the back and boys in front on the floor.

Cubmaster is dressed as Akela, leader of the pack, and the other leaders are dressed appropriately.

Have the pack leaders role play the parts of Bagheera, mother wolf, Baloo, and Webelos leader.

NARRATOR: This month we are celebrating the ____th annual birthday of Boy Scouting in America and Cub Scouting 20 years later, February 22, 1930. Cubs traditionally hold the Blue and gold Banquet to celebrate this birthday. Cub Scouting builds character in boys. The blue stands for truth and loyalty; and the gold, cheer and happiness. In addition, the blue and gold of Cub Scouting helps to build spirit in the pack. And so, you can see how society over the years has benefited from Scouting. Let us all, through our efforts, make this the best celebration yet.

CUBMASTER: Who will speak for the Bobcats?

BAGHEERA: I Bagheera, will speak for the Bobcats. (Call new Bobcats forward with parents). These are the young ones, but they have already begun to show skills. I present them to the pack (present awards).

CUBMASTER: Now it is time for the wolves. Who speaks for the wolves?

MOTHER WOLF: I, mother wolf, speak for the wolf cubs. I have nurtured them and watched them grow as they learn the skills of the wolf. These young ones are ready to be recognized. (Wolves come up and are awarded with parents. Wolf den gathers and gives a wolf howl).

CUBMASTER: Next we are ready for the bears, who speaks for the bears?

BALOO: I, Baloo, will speak for the bears. I have taught them well the Law of the Pack. They have come far and are ready to be recognized by the pack. (New bears come up with parents and are awarded. Den gathers and gives bear growl.)

CUBMASTER: Now we are ready for the most mature members of the pack to be recognized. Who speaks for the Webelos?

WEBELOS LEADER: I speak for the Webelos (same scenario). Recite the meaning of Webelos.

CUBMASTER: I have looked over the members of the pack and I am proud to be their leader; would all of the members of the pack come forward and join in all a Grand Howl

LET'S CELEBRATE

(Circle Ten Council)

Props – Party decorations, streamers, boxed gifts

Awards – Wrap the awards like presents. Have a large gift-wrapped box in which you put all of them.

Cubmaster - “We’re here to celebrate the advancement of (boy’s name(s)) to the rank of (rank). As his (their) efforts to advance has been a gift to us, we present him (them) now with his (their) awards. Let’s all join in singing (to the tune of Happy Birthday)

Happy (actual rank earned) Bobcat to you!

Happy Bobcat to you!

Happy Bobcat dear (name of Cub)

Happy Bobcat to you!

Note – might be fun to have party noisemakers instead of cheers so the audience can raise the roof!

BLUE AND GOLD RHYME - ADVANCEMENT

Baltimore Area Council

Props: All awards have been individually wrapped in blue and gold paper and ribbon as birthday gifts.

Setting: Narrator presents ceremony from front of room with three stacks of “Birthday Gift Awards” on a table in front. *The presentation talk is arranged in rhyming couplets.*

Narrator:

Tonight being Cub Scouting’s ___th Birthday Party, it’s time to give presents so we won’t be tardy. Our first presents go to Cubs that are new. So we would like to award Bobcat badges to these few. *(Read names and give each a “Birthday Gift”.)*

To celebrate their efforts and time, we’d like to award Wolf badges to these Cubs combined. *(Read names and give each his “gift”)*

This next group of Cubs to be recognized tonight, Richly deserve this gift by right. The Bear badge they’ve earned takes time and attention, and work on their part too numerous to mention. *(Read names and give each Cub a gift)*

(After names have been read and gifts given, present Webelos badges in much the same fashion, and then give the closing thought below:)

Enjoy these small gifts from Scouting that you have worked to achieve.
But, remember, a gift is much richer by far when you give instead of receive.
So please give what you have learned of Scouting to others, tonight when you leave.

PROGRAM IDEAS

Skits and/or songs by each of the dens

Honor one or more Cub Scout leaders from the past.

Design or purchase a Pack Flag and present it with a special ceremony.

Do "This Is Your Life Pack" using highlights of your pack's history.

Honor families and/or leaders with Scouting Awards

Have a poster or essay contest and present awards at banquet

Cake auction, just after their banquet, the money is used to help the pack

Have a Charter Presentation Ceremony

Highlight the purposes and methods of Cub Scouting

Have a guest speaker talk about that month's Core Value

Have a Uniform Inspection

Give each cub a birthday gift – (inside it their derby kit for the next month)

Have a pack talent show

Have the Boy Scout troop come and help serve the food

Make up and play a Cub Scout "Jeopardy" type game

Play a Cub Scout "Wheel of Fortune" type game

Make a pack time capsule to be opened at next year's Blue and Gold

Play some of the other games listed in this Pow Wow Book

GAMES

PAC-MAN

Equipment: None

Area needed: Gym or lawn

Activity: Cubs line up on one side of the lawn or gym. One cub is designated to be the PAC-MAN, who stands in the center of the area. On the Den Leader's signal, all the cubs will try to run (or hop, skip, etc.) to the other side of the gym or lawn. All who are touched by the PAC-MAN then become PAC-MEN and help catch the returning boys when the next signal is given. Those not caught on the second attempt become PAC-MAN and you start a new game.

A SEARCH FOR BLUE AND GOLD

Directions: Go around the room and ask people if they have the following objects or fit the descriptions asked for. Have the person sign his or her name next to the statement that fits them.

- | | |
|---|--|
| 1. Do you have a gold watch on? | 11. What does Blue and gold mean? |
| 2. Are you a child wearing a blue shirt? | 12. Are you wearing gold earrings? |
| 3. Are you an adult wearing a blue shirt? | 13. Do you have gold braces? |
| 4. Do you have glasses with gold rims? | 14. Are you wearing a gold ring? |
| 5. Are you wearing gold socks? | 15. Does your belt have a gold buckle? |
| 6. Do you have blue eyes? | 16. Is your belt blue? |
| 7. Do you have golden hair? | 17. Are your shoes blue? |
| 8. Is your last or first initial "B"? | 18. Are you wearing a Blue ribbon? |
| 9. Is your last or first initial "G"? | 19. Are you wearing gold shoes? |
| 10. How many electives does it take to earn a gold arrow point? | 20. Are you wearing blue socks? |

SCOUTING CONCENTRATION

Use pictures from Scouting and Cub Scouting history, ranks, your pack number, Cubmaster's name, and other items having to do with Scouting and Cub Scouting to make a concentration game.

You will need two cards with matching pictures to make a set. You will need one set per boy plus a few extras. Mix up the pictures and lay them face down on a table, the floor, or post them on the wall. Place a number on the opposite side and lay them out in number order five to a row. Have each boy in turn call a number, turn the picture over and have him call another number and turn it over. If the two pictures match he gets another turn. If not, go to the next player; Keep playing until all the sets are matched. The boy with the most sets is the winner.

PLACE SETTINGS, INVITATIONS ETC...

RANK EMBLEMS NAPKIN HOLDERS

Copy the rank emblem on white card stock and cut, color if desired. Hot glue to a plastic garbage bag tie

TENT FAVOR and/or PLACE CARD

Use a piece of paper 6" x 6 1/2" for each tent. Construction paper, brown paper bag, or heavy paper can be used.

Fold the piece in half so that you can have a double piece of paper 3" x 6 1/2". With the fold at the top, fold corners in and fold sides about a quarter inch. Paper should now look like a tent.

Decorate tents with the scout sign, picture or silhouette of Lord Baden-Powell. Or write your guest name on the side. Place a small candy bar inside the tent as a party favor.

CUB GOODIE CUP

Enlarge Cub and feet on a heavier card stock.

Color and cut out.

Mount on the inside of back of goodie(nut) cup and the feet on the front of cup.



NECKERCHIEF PARTY FAVOR

Cut triangle piece of gold material and fold around nut cup; tie to look like Cub Scout neckerchief. Use a baggie twister to hold.

POSTER IDEA

On a piece of poster board or foam board, draw a circle for the plate in a place setting. On the plate, print the menu and other pertinent data. The silverware is cut from foil, after tracing around a real knife, fork and spoon. Glue the silverware in place and attach a foil covered cardboard ring, in this ring place a paper napkin to complete the setting.

OPTIONAL: Use plastic ware and paper plate on poster instead of drawing and cutting.

BANQUET POCKET KNIFE INVITATION

Materials: Card stock Yellow and Blue
two 3/4" paper fasteners
scissors and felt tip pen

Print the necessary information on the card stock and attach to blades of the scissors.

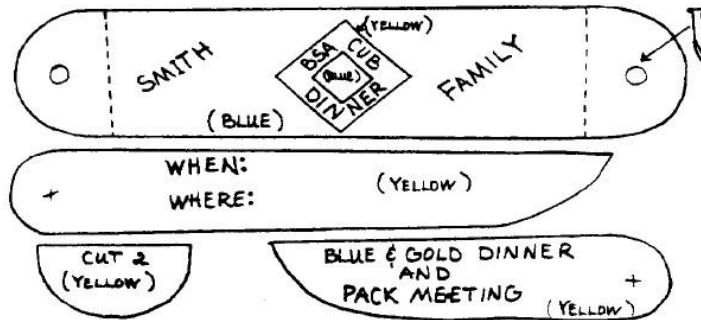

POCKET INVITATION OR THANK YOU

Your message can be either written under the flap or on a separate sheet tucked inside the pocket.

Copy the pocket so that the paper can be folded on one side to form a "back" to the pocket. Enlarge to desired size. Fold paper and trim around the pocket. Open the fold cut a slit (leaders only) under the words "Boy Scouts of America". Don't cut clear through either edge.

Cut out the flap and fold along the top. (Fold forward if you want to use the pocket opening and back if you just want a flap to open.) Insert the folded portion of the flap into the slit. Tape or glue it in place (under the words "Boy Scouts of America" if you want to use the pocket). Now re-fold your paper and glue around the edges of the pocket front and back.

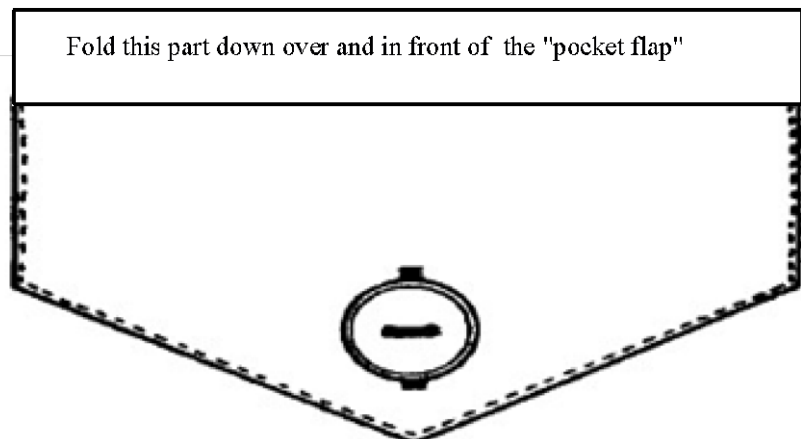
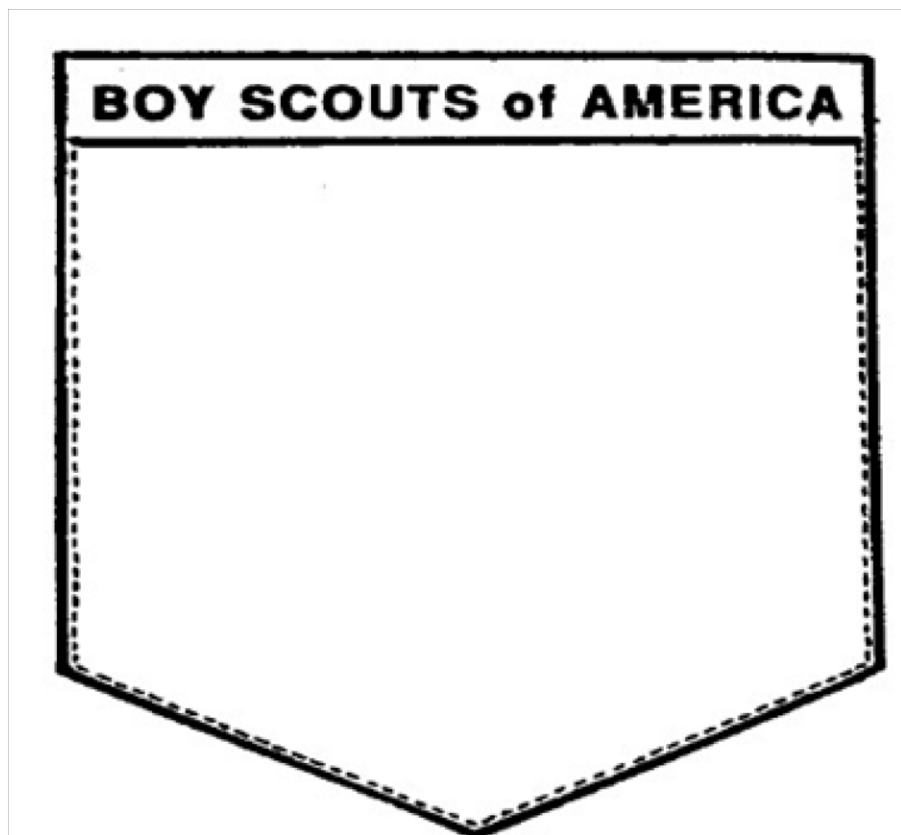

Fold this part down over and in front of the "pocket flap"

SKITS

The Blue and gold banquet is a good time to have a skit from every den. That plus your awards could practically be the whole program.

SCOUTING SPIRIT - Skit

Characters:

- #1 Old man with cane dressed as ghost
- #2 63 year old man with a sign stating age around neck
- #3 34 year old man with sign stating age around neck
- #4, #5, #6 Cub Scouts in uniform

(All enter and stand in order 1 thru 6)

Cubs 4,5,& 6: Who are You?

Cub 3: I am the father of a Cub Scout. I too was a Cub Scout

Cub 2: I was the first American Scout. I became a Cub Scout in 1930 when Cub Scouting came to America in ____ years ago.

Cub 1: I am the spirit of all those boys who with Baden-Powell began the Scouting experiment on Brownsea Island.

ALL: We are the spirit of today's Scouts and Scouting movement. We wish a happy birthday to all Scouts. Won't all of you join us in singing Happy Birthday to Scouting.

BLUE AND GOLD- SKIT TO MUSIC

(Tune: "I've Been Working on the Railroad")

Sing:

I've been working on my Wolf badge,
All the live long day
I've been working on my Bear badge
Just to pass the time away.
Don't you hear the Cub Scouts shouting
A Webelos we'll soon be!
Can't you hear Akela shouting,
Come and follow me!

Action:

Hold up Wolf badge sign
Wipe hand across forehead
Hold up Bear badge sign
Pretend to look at wrist watch
Cup hands around ear
Hold up Webelos sign
Cup hands around ear
Motion for all to come

REPEAT CHORUS TWICE (Sung by all the boys except the one who blows the horn)

Tiger, won't you blow
Wolf, won't you blow
Bear won't you blow your horn?

Blow horn

HAPPY BIRTHDAY

At least five Scouts are needed with one of them selected to be the “singing telegram.” This Scout needs to be sure to wear a hat with a small sign on it that says “singing telegram.” There is a table with a birthday cake on it that notes how old Scouting is. A bright table cloth and balloons can add color and atmosphere. The four Scouts are gathered around talking when the “singing telegram” enters.

Scout (S.T. below) enters, and starts to sing.

S.T.: Happy birthday to you! Happy birthday to you...

Cub 1: Hey! What are you doing? What’s going on?

S.T.: I’m delivering a singing telegram.

Cub 2: To whom?

S.T.: If you would listen to the end of my telegram, you’d find out. (starts to sing) Happy birthday to you! Happy birthday...

Cub 3: Excuse me – what’s going on?

Cub 1: He’s delivering a singing telegram to someone here, but he won’t tell us who.

S.T.: If you’d just be patient a little while longer, you’d find out. (starts to sing) Happy birthday to you!...

Cub 4: Hey! I heard singing. Who’s having a birthday?

Cub 2: He won’t tell us. He says we have to wait.

Cub 3: It’s not my birthday. Is it yours?

Cub 4: Not mine!

Cub 1: Not mine either!

S.T.: (exasperated) If you could just wait, I’m almost done singing (starts to sing) Happy birthday to...

Cub 3: Come on, friend. Tell us who you’re singing for.

Cub 2: Yeah, we really want to know!

Cub 4: Are you sure he’s here tonight?

S.T.: All right! All right! I’ll tell you! (All Scouts gather round and whisper.) Now, all Scouts turn around and face the rest of the group and shout.

ALL sing: Happy Birthday Cub Scouting! Happy Birthday to you!

THE BEGINNING OF CUB SCOUTING - Skit

Personnel: 5 boys

Props: Poster board for signs

NARRATOR: Cub Scouts got its start by hanging around the Boy Scouts. But the Boy Scouts didn't want the younger boys hanging around their troop meeting. The younger boys couldn't see any reason for not being able to stay and join the older boys.

First cub enters room carrying a sign saying Lord Robert Baden-Powell. Cub remains on stage holding sign.

NARRATOR: Lord Robert Baden-Powell was a great Englishman, he started Scouting for boys in England in 1907.

Second Cub enters room carrying sign saying William D. Boyce. Stands next to first cub.

NARRATOR: William D. Boyce is the man who went to England on business, while there he was lost and was helped to find his way by an established Boy Scout, he became interested in this program. Mr. Boyce asked the boy to take him to Baden-Powell. Boyce returned to America with a trunk full of Boy Scouting books and uniforms and other Scouting material from the English program "Scouting for Boys".

Third cub enters room with sign saying Ernest Thompson Seton, stands with others.

NARRATOR: Ernest Thompson Seton was the first Chief Scout of the Boy Scouts of America. He was very talented in Indian crafts and lore.

Fourth Cub enters with sign saying Daniel Carter Beard.

NARRATOR - Daniel Carter Beard was the First National Commissioner and chairman of the National Court of Honor. He also wrote and illustrated articles for the Boy Scouts magazine, BOYS LIFE.

ALL the Cubs carrying signs flip them over and they read HAPPY BIRTHDAY CUB SCOUTS

NARRATOR: Please join us in singing Happy Birthday to Cub Scouting



BLUE AND GOLD - Skit

Preparation: Print large block letters with permanent markers on 8" x 10" sheets of white cardstock---the word BLUE in Blue, AND in black, and GOLD in red. Add silver stars to the letters. Printing parts on back of each card cuts memorization to a minimum. Boys hold up cards and say the parts in turn. 10 boys required

B is for BOYS--Tigers, Bobcats, Wolf, Bears and Webelos

L is for LEADERS--the Cubmaster who guides us

U is for UNDERSTANDING--We learn to help others

E is for EXCELLENCE--we try to "do our best"

A is for ANNIVERSARY--Cub Scouting's____th

N is for NEIGHBORHOOD--where dens meet each week

D is for DEN CHIEFS--Scouts who help us in many ways

G is for GOALS--for which Cub Scouting stands

O is for OPPORTUNITIES--for boys to learn and do

L is for LIBERTY--in the years to come

D is for DEN LEADER--who loves us and helps us

CUB SCOUT STEW- Skit

Characters: Boy in chef's hat, any number of uniformed Cub Scouts, Den Leader.

Setting: On stage is a large kettle made from a cardboard carton. There is a short stepladder at each side for the boys to climb up to get into the kettle. Put an air mattress or other pad in the bottom of the kettle for boys to land on. As curtain opens, a boy wearing a chef's hat is standing on one of the stepladders stirring the pot with a broomstick. He holds large paper with "Recipe" is printed on it.

DEN LEADER: (entering) What are you making?

CHEF: This is a Cub Scout stew. Would you like to watch?

DEN LEADER: Yes, I would. What goes in it?

CHEF (pretends to read recipe): First, add any number of Cub Scouts who do their best. (Uniformed Cub Scouts come on stage and climb into kettle.) Then add a sense of humor. (Grinning Cub Scout wearing sign, "Humor," climbs into kettle.) Next, add a pinch of service to others. (Cub Scout wearing "Service" sign climbs into kettle.) Then add a dash of mischief. (Cub Scout wearing "Mischief" sign climbs into kettle.) And a big helping of sunshine. (Cub Scout wearing "Sunshine" sign climbs into kettle.) And last, add a ton of energy! (Cub Scout wearing "Energy" sign climbs into kettle.)

CUB SCOUT STEW – Continued

CHEF (pretends to stir): Stir well, and you have a Cub Scout stew. (Pretends to take a taste and offers a taste to den leader)

DEN LEADER: That's delicious! I'd like your recipe.

THAT BOY - A HUNDRED YEARS AGO AND A HUNDRED YEARS FROM THEN

Sonia Bartholomew - Hobbie Creek District-UNPC

("A Hundred Years From Now" poem quoted from UNPC 2009-2010 Pow Wow Book p.55)

A hundred years ago . . . on a dark and foggy night, American William Boyce was lost in the London streets. He encountered a young boy who helped him on his way. When he offered a tip, the boy replied, "No, that was my Good Turn today." Impressed by the character of this young British scout, Boyce gathered a trunk full of scouting literature and six months later, on February 8, 1910, incorporated the Boy Scouts of America. Thus, the Boy Scouts of America was inspired by the actions of one boy . . . that boy.

I am a Tiger Cub. With my adult partner I learn about my family, my community, and myself. I will always try to do my best.

I am ... that boy

I am a Wolf Cub. As I complete achievements, I learn to use tools, take care of my body and respect the flag. I am learning to do my duty to God and my country. I will always try to do my best.

I am . . . that boy.

I am a Bear Cub. As I complete achievements, I learn how to worship, what makes America special, how to have fun with my family, and how to build my muscles. I am learning to help other people and to obey the law of the pack.

I am . . . that boy.

I am a Webelos Scout. I earn activity badges to improve my physical and mental skills, to serve my community, and to learn about technology and the outdoors. I forge on to earn Cub Scouting's highest rank: the Arrow of Light. I will be a loyal scout as I learn the Scout Oath and law.

I am . . . that boy.

I am a Boy Scout. As I earn merit badges, I learn new skills and am exposed to new ideas. I strive to be prepared and do a good turn daily. I work hard to keep myself physically strong, mentally awake, and morally straight.

I am . . . that boy.

I will be an Eagle Scout. I will have walked the trail to eagle and will be qualified to help others as well as take care of myself. I am trying each day to be trustworthy, loyal, helpful, friendly, courteous, kind, obedient, cheerful, thrifty, brave, clean, and reverent.

I am . . . that boy.

I am an Eagle Scout. I have walked the trail to eagle and am qualified to help others as well as take care of myself. I am trying each day to be trustworthy, loyal, helpful, friendly, courteous, kind, obedient, cheerful, thrifty, brave, clean, and reverent.

I am . . . that boy.

That Boy - A Hundred Years Ago and A Hundred Years from Then- Skit Continued

I am a young man. As I begin college, military service, a mission, or marriage, I am armed with values and leadership skills that will help me succeed. I continue to do my duty to God and my country.

I was . . . that boy.

I am a scout leader. I am Akela and guide boys on the path to become independent and responsible young men. I am an example of service and obedience as I follow the promise to help other people and obey the law of the pack.

I was . . . that boy.

I am a father. I work hard and do my best to love and care for my children. I am armed with skills to provide the necessities of life for my family and lead them in wholesome recreational activities.

I was . . . that boy.

I am a man. I am a businessman, a doctor, or a lawyer. I lead a company, a congregation, or even a country. Each day I strive to do my best and be prepared. I do my duty to God and my country and certainly try to do a good turn daily. I am trustworthy, loyal, helpful, friendly, courteous, kind, obedient, cheerful, thrifty, brave, clean, and reverent.

I was . . . that boy.

"A hundred years from now
 'Twill not matter at all
 What your bank account was
 Whether large or small
 The kind of house you lived in
 'Twill be immaterial, too
 As will the kind of car you drove
 And the famous folks you knew
 But the world may be a better place
 Because you were involved in Scouting
 And guided future leaders down life's trail
 So keep that Scouting light shining
 As a beacon light for each boy
 Then in years to come you'll see them as men
 Who fill you with pride and joy
 Yes, Scouting is . . . that boy"

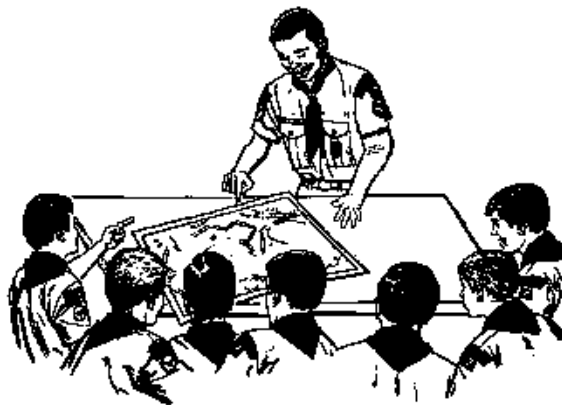

THE STORY OF A PACK -- LIKE OURS?

This skit requires the participation of ALL those in attendance. Each group as identified below is to repeat their "phrase" every time they hear their "name."

TIGER - "Meow, meow"

WOLF - (your best wolf howl)

BEAR - "Grrrr, grrrr!"

WEBELOS - "To the top!"

PARENTS - "I'll help, I'll help"

PACK - "We're number one!" (everyone)

In _____, there is a pretty good PACK that does a lot of things and has a lot of fun. The PACK has some new TIGERS who have just joined. There are also WOLF Cub Scouts, who are eight years old. Another den in this PACK is the BEARS, who are 9 years old, but some of these BEARS are almost 10 years old.

After a Cub has been a TIGER, WOLF, or BEAR, and has turned 10 years old, he becomes a WEBELOS Scout. WEBELOS means, "We'll be loyal Scouts". The WEBELOS program differs from that of the TIGER, WOLF, and BEAR because it prepares the WEBELOS Scout for Boy Scouts. The WEBELOS uniform is different too.

The WOLF and BEAR Cub Scouts, under their PARENTS' guidance, work on achievements to earn their rank badge, then on electives to earn gold and silver arrow points. The WEBELOS work toward activity pins under the direction of their leaders. Every month, awards are presented at the PACK meeting for all the PARENTS to witness.

Our PACK is in OK shape, but we've lost some valuable PARENTS whose sons crossed over to Boy Scouts last year. Now the PACK is in need of PARENTS of the TIGERS, WOLVES, BEARS, and WEBELOS to help out.

The PACK needs help from ALL PARENTS so it can grow and continue to provide lots of fun for the TIGER, WOLF and BEAR Cub Scouts and the WEBELOS Scouts too! The PACK can't do a good job with only a FEW PARENTS doing everything, so PARENTS help your PACK continue its successful program for your TIGER, WOLF, BEAR and WEBELOS Cub Scouts. PARENTS, please help us. What do you say PARENTS?

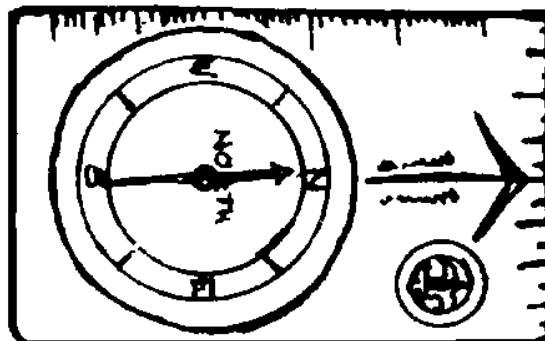

SONGS

At the Blue and gold banquet can be a good time to sing patriotic songs or maybe your pack's favorite songs. Songs can be sung at the beginning, the end or anywhere in the middle. Pick a song with a tune that everyone knows and just have fun with it! Try one of the following or make up your own.

BLUE and GOLD

(Tune: London Bridges)

We're here at the Blue and gold
Blue and Gold
Blue and Gold
We're here at the Blue and gold, to honor scouting.

Now we want to eat our food,
eat our food
eat our food,
Now we want to eat our food, it smells so yummy!

IF YOU'RE A CUB SCOUT

(Tune: If you're happy and you know it)

If you're a Bob cat and you know it, just meow
If you're a Bob cat and you know it, just meow
If you're a Bob cat and you know it, then your smile will surely show it
If you're a Bob cat and you know it, just meow

If you're a Wolf cub and you know it, give a howl
If you're a Wolf cub and you know it, give a howl
If you're a Wolf cub and you know it, then your smile will surely show it
If you're a Wolf cub and you know it, give a howl

If you're a Bear cub and you know it, stand and growl
If you're a Bear cub and you know it, stand and growl
If you're a Bear cub and you know it, then your smile will surely show it
If you're a Bear cub and you know it, stand and growl

If you're a Webelos and you know it, do all three (*meow, howl, growl*)
If you're a Webelos and you know it, do all three
If you're a Webelos and you know it, then your smile will surely show it
If you're a Webelos and you know it, do all three

"MARCH OF THE BLUE AND GOLD"

Tune of: The Ants Go Marching

It started out with Baden-Powell, Hurrah! Hurrah!
It started out with Baden-Powell, Hurrah! Hurrah!
It started out with Baden-Powell,
The Cub Scout Program we have now

CHORUS (Repeat after each verse) ,
And we're all so proud to be,
Blue n gold, blue n gold,
Boom, boom, boom

Our youngest boys begin their trail, Hurrah, Hurrah!
Our youngest boys begin their trail, Hurrah, Hurrah!
Our youngest boys begin their trail
By being Tigers --they won't fail
Chorus

Our boys are eager to make the trek, Hurrah, Hurrah!
Our boys are eager to make the trek, Hurrah, Hurrah!
Our boys are eager to make the trek
The Wolves have passed another step
Chorus

The trail is filled with rocks and hills, Hurrah, Hurrah!
The trail is filled with rocks and hills, Hurrah, Hurrah!
The trail is filled with rocks and hills
But our great Bears know lots of skills
Chorus

And now the trek is steep and hard, Hurrah, Hurrah!
And now the trek is steep and hard, Hurrah, Hurrah!
And now the trek is steep and hard,
Our Webelos earned their next award!
Chorus

And special Cubs have won the fight, Hurrah, Hurrah!
And special Cubs have won the fight, Hurrah, Hurrah!
And special Cubs have won the fight,
They've proudly earned their Arrow of Light!
Chorus

Yes, every Scout has passed the test, Hurrah, Hurrah!
Yes, every Scout has passed the test, Hurrah, Hurrah!
Yes, every Scout has passed the test
We are Cubs who DO-OUR-BEST (*Yell last three words*)

HAPPY BIRTHDAY TO CUB SCOUTING

(Tune: BINGO)

We're at our Cub Scout Blue and gold,
Singing for our parents.
Ha ppy Birth day.. to
Ha ppy Birth day to
Ha ppy Birth day to
Cub Scouting everywhere.

One day a man was lost in the fog
A scout help him find his way.
He was lost in fog
He was lost in fog
He was lost in fog
But someone showed the way.

The boy refused to take a tip,
Because he was a scout.
He refused the tip
He refused the tip
He refused the tip
Just doing a good turn.

I am a Cub Scout, yes indeed
And like that scout I'll be.
I will do my best
I will do my best
I will do my best
To be a good example.

We're at our Cub Scout Blue and gold,
With our friends and family.
Ha ppy Birth day.. to
Ha ppy Birth day to
Ha ppy Birth day to
Cub Scouting everywhere

(Have everyone join in for this last repeat)
Ha ppy Birth day.. to
Ha ppy Birth day to
Ha ppy Birth day to
Cub Scouting everywhere
Chorus

THE 12 DAYS OF SCOUTING

(Santa Clara County Council Pow Wow Book Dec. 2000)

(Tune: 12 Days of Christmas)

On the first day of Scouting, Akela gave to me.....
A Den Leader swinging from a tree!
On the second day of Scouting, Akela gave to me.....
Two Screaming Bobcats,
And a Den Leader swinging from a tree!

You have the idea by now. Here's the rest of these silly verses:

Third Day - Three Skinny Wolves
Fourth Day- Four Hungry Bears
Fifth Day - Five Webelos
Sixth Day - Six Arrow points
Seventh Day - Seven Silly Den Chiefs
Eighth Day - Eight Shouting Scouts
Ninth Day - Nine Warring Eagles
Tenth Day - Ten Derby Cars
Eleventh Day - Eleven Funny Den Skits
Twelfth Day - Twelve Wacky Cheers

DO YOUR BEST

(Tune: I'm a little teapot)

I am at Cub Scout Blue and gold
Here with my friends, new and old.
When we get together on this night
Do your best! is what we're told



AN ALPHABET OF NAMES

(Tune: If You're Happy and You Know It)

This is an audience participation song. Sing it slow enough that those whose names start with the named letters can do the appropriate actions.

If your name starts with A, turn around.
 If your name starts with B, touch the ground.
 If your name starts with C, then stand up and touch your knee,
 Clap your hands if your name starts with D.

If your name starts with E, wink your eye.
 If your name starts with F, try to fly.
 If your name starts with G, blow a kiss up here to me.
 If your name starts with H, say "Hee, hee!"

If your name starts with M, make a smile.
 If your name starts with N, shake a while.
 If your name starts with O, put an elbow on your nose.
 If your name starts with P, say "I know!"

If your name starts with Q, raise your hand.
 If your name starts with R, you should stand.
 If your name starts with S, you should pat your head, I guess.
 If your name starts with T, say "Oh, yes!"

If your name starts with U, touch your eye.
 If your name starts with V, pat your thigh.
 If your name starts with W, with X or Y or Z,
 Then stand up and take a bow and say "That's me!"

BLUE and GOLD

(Tune: Jingle Bells)

Blue and Gold,
 Blue and Gold,
 Colors of Cub Scouting
 Blue is truth and loyalty,
 Gold, sunshine and cheer.

Blue and Gold
 Blue and Gold,
 Colors of Cub Scouting.
 We'll celebrate and have some fun.
 At our Blue and gold Banquet.

RECIPES FOR LARGE GROUPS

SLOPPY JOES

5 lbs. hamburger
2/3 cup water
1/3 cup brown sugar
1 tsp salt
2/3 cup ketchup
1 Tbls dry mustard
3 onions chopped
1 small bunch celery chopped

Brown hamburger with onions. Place in large kettle with water, sugar, salt, ketchup and dry mustard. Simmer. Add celery a half hour before serving so celery will remain chewy. This freezes well. Serve on hamburger buns. Serves 25-30.

SUE'S OVEN BBQ TURKEY STEAKS

30 lbs. turkey steaks
3 liters 7-Up
1 1/4 cup soy sauce
1 cup oil
3/4 cup horseradish sauce
Liquid Smoke

Place turkey steaks in shallow baking pans with steaks slightly overlapping. Mix remaining ingredients in a bowl and pour over turkey. Refrigerate several hours or overnight. Stir marinade occasionally. Bake steaks in marinade at 350 degrees for 2 ½ hours.

CHILI

8 lbs. ground beef
8 cups chopped onions
8-28 oz. cans tomatoes
8-16 oz. cans kidney beans
2-15 oz. cans tomato sauce
1/4 cup sugar
6 Tbls chili powder
3 Tbls salt

Cook and stir ground beef and onion in large heavy roaster until meat is brown. Add the other ingredients and cook uncovered for about 1 1/2 hours stirring occasionally. Makes 40- 1 1/2 cup servings.

HAWAIIAN HAYSTACKS

80 chicken thighs, skinless and boneless or
6 stewing chickens
Water
Chicken soup base
Parsley, sage, rosemary, thyme, pepper,
garlic powder, whole cloves, bay leaves
4 onions
Soy sauce
6 large cans cream of chicken or mushroom soup

Place chicken in a large pot. Add water to cover chicken. Add soup base, spices, onion and soy sauce. Cook until chicken is tender. Remove chicken from broth. Dice chicken and freeze. Strain broth and freeze. Place in refrigerator the day before using to thaw. Make sauce by combining broth with 6 large cans cream of chicken or cream of mushroom soup. Use 1/2 to 3/4 canfuls of broth for each can of soup. Stir until smooth and heat until just boiling. Cook 25 cups of rice in 50 cups of water to make 50 cups of cooked rice. Serve chicken and sauce over rice. While serving, keep sauce, chicken and rice hot in crock pots, electric roasting pans, or electric frying pans. Place bowls of toppings on each table and let each person fix their own haystack. Suggested toppings: diced cooked chicken, chow Mein noodles, green peas, grated cheese, green peppers, diced apples, chopped celery, shredded coconut, sliced almonds, green onions, pineapple tidbits. Serves 100.

CROWD CHICKEN CASSEROLE

10 cups diced cooked chicken
10 cups chopped celery
2 bunches green onions with tops, chopped
2 cans (4 oz each) chopped green chilies
1 can (5 3/4 oz) black olives, drained and sliced
2 cups slivered almonds
5 cups (20 oz) shredded cheese, divided
2 cups mayonnaise
2 cups (16 oz) sour cream
5 cups crushed potato chips
Combine the first six ingredients. Add 2 cups cheese. Mix mayonnaise and sour cream; add to chicken mixture and toss. Spoon into two greased 13" x 9" x 2" baking dishes. Sprinkle with chips. Top with remaining cheese. Bake, uncovered, at 350 degrees for 20-25 minutes.
Makes 24 servings. From Taste of Home Magazine.

MACARONI SALAD FOR 100

5 to 6 pounds cooked ham, cubed
5 to 6 pounds macaroni, cooked and drained
3 pounds shredded cheddar cheese
2 bags (20 oz each) frozen peas, thawed
2 bunches celery, chopped (about 12 cups)
2 large onions, chopped (2 cups)
2 cans pitted black olives, drained and sliced

Dressing –

2 quarts mayonnaise
1 bottle (8 oz) French salad dressing
1/4 cup vinegar
1 cup light cream
1 1/2 tsp onion salt
1 1/2 tsp garlic salt
1 tsp. salt
1 tsp. pepper

Combine first seven ingredients. Combine all dressing ingredients; pour over the ham mixture and toss. Refrigerate. Serves 100. From Taste of Home Magazine.

BAKED BEANS

1 1/2 #10 cans pork and beans
3 chopped onions
about 28 oz. ketchup
3/4 cup brown sugar
3/8 cup dry mustard
Mix and bake at least one hour.
Makes 50 servings.

BLUE AND GOLD MINTS

6 Tbls. margarine or butter
2 tsp. peppermint or spearmint flavoring
3 pounds powdered sugar
7 Tbls. water, colored with food coloring
dash of salt

Cream margarine. Add flavoring, salt and water. Combine with 2 pounds of powdered sugar. Blend with mixer, then knead in remaining sugar. Cut and shape mints. Spread on cookie sheet and refrigerate. When mints are dry, store in covered canister in refrigerator.

FOOD SERVINGS FOR LARGE GROUPS

FOOD	<u>25 SERVINGS</u>	<u>50 SERVINGS</u>	<u>100 SERVINGS</u>
Rolls	4 dozen	8 dozen	16 dozen
Bread	50 slices or 3 1-lb. loaves	100 slices or 6 1-lb. loaves	200 slices or 12 1-lb. loaves
Butter	1/2 pound	1 pound	2 pounds
Mayonnaise	1 cup	2-3 cups	4-6 cups
Mixed Filling for sandwiches	1 1/2 quarts	3 quarts	5-6 quarts
Jams and Preserves	1 1/2 pounds	3 pounds	6 pounds
Crackers	1 1/2 pounds	3 pounds	6 pounds
Cheese (2 oz serving)	3 pounds	6 pounds	12 pounds
Soup	1 1/2 gallons	3 gallons	6 gallons
Salad Dressing	1 pint	2 1/2 pints	5 pints
MEAT, POULTRY OR FISH:			
Wieners (Beef)	6 1/2 pounds	13 pounds	26 pounds
Hamburger	9 pounds	18 pounds	36 pounds
Turkey or chicken	13 pounds	25-35 pounds	50-75 pounds
Fish fillets or steaks	7 1/2 pounds	15 pounds	30 pounds
SALADS, CASSEROLES, VEGETABLES:			
Potato Salad	4 1/4 quarts	2 1/4 gallons	4 1/2 gallons
Scalloped Potatoes	4 1/4 quarts	8 1/2 quarts	17 quarts
Mashed Potatoes	9 pounds	18-20 pounds	25-35 pounds
Spaghetti	1 1/4 gallons	2 1/2 gallons	5 gallons
Baked Beans	3/4 gallons	1 1/4 gallons	2 1/2 gallons
Jello Salad	3/4 gallons	1 1/4 gallons	2 1/2 gallons
Canned Vegetables	1 #10 can	2 1/2 #10 cans	4 #10 cans
FRESH VEGETABLES:			
Lettuce (for salads)	4 heads	8 heads	16 heads
Carrots	6 1/4 pounds	12 1/2 pounds	25 pounds
Tomatoes	3-5 pounds	7-10 pounds	14-20 pounds
DESSERTS:			
Cake	1- 10"x12" sheet cake 1 1/2- 10" layer cakes	1- 12"x20" sheet cake 3- 10" layer cakes	2- 10"x12" sheet cakes 6- 10" layer cakes
Ice Cream-			
Brick	3 1/4 quarts	6 1/2 quarts	12 1/2 quarts
Bulk	2 1/4 quarts	4 1/2 quarts	9 quarts

Cub Scout



Character Connections®

BRAND NEW section (36 pages) of Activities you can use at den or pack meetings for Character Connections on the Aug 2011 CD

From the beginning, the Cub Scouting program was designed to build character. In 2001 Character Connections® was introduced as a way to help the boys connect the core values with their activities and advancements. It replaced the previous “Ethics in Action” program. In 2003 each of the handbooks were revised to include Character Connections® as part of the advancement requirements.

In 2010 we again saw an increased focus on Cub Scouting’s 12 core values in both den and pack meetings as each month was assigned a specific core value to focus on, in the new *Den and Pack Meeting Resource Guide*. Here we have included a review of the Character Connections® program as well as other relative information.

CUB SCOUT - CHARACTER DEVELOPMENT

Since its origin, the Scouting program has been an educational experience concerned with values. In 1910, the first activities for Scouts were designed to build character, physical fitness, practical skills, and service. These elements were part of the original Cub Scout program and continue to be part of Cub Scouting today.

Character development should extend into every aspect of a boy's life. Character development should also extend into every aspect of Cub Scouting. Cub Scout leaders should strive to use Cub Scouting's **12 core values** throughout all elements of the program—service projects, ceremonies, games, skits, songs, crafts, and all the other activities enjoyed at den and pack meetings

CUB SCOUTING’S 12 CORE VALUES

1. Citizenship:

Contributing service and showing responsibility to local, state, and national communities.

2. Compassion: Being kind and considerate and showing concern for the well-being of others.

3. Cooperation: Being helpful and working together with others toward a common goal.

4. Courage: Being brave and doing what is right regardless of our fears, the difficulties, or the consequences.

5. Faith: Having inner strength and confidence based on our trust in God.

6. Health and Fitness: Being personally committed to keeping our minds and bodies clean and fit.

7 Honesty: Telling the truth and being worthy of trust.

8. Perseverance: Sticking with something and not giving up, even if it is difficult.

9. Positive Attitude: Being cheerful and setting our minds to look for and find the best in all situations.

10. Resourcefulness: Using human and other resources to their fullest.

11. Respect: Showing regard for the worth of something or someone.

12. Responsibility: Fulfilling our duty to God, country, other people, and ourselves.

12 Core Values and the Scout Law

Boy Scouts learn and strive to live by the Scout Law:

A Scout is trustworthy, loyal, helpful, friendly, courteous, kind, obedient, cheerful, thrifty, brave, clean, and reverent

Many of the core values of Cub Scouting relate directly to the Scout Law:

Core Value	Scout Law
Compassion	Kind
Cooperation	Helpful
Courage	Brave
Health and Fitness	Clean
Honesty	Trustworthy
Positive Attitude	Cheerful

Character can be defined as the collection of core values by an individual, that leads to moral commitment and action.

Character development should challenge Cub Scouts to experience core values in six general areas: God, world, country, community, family and self.

Character is “values in action”



CHARACTER CONNECTIONS®

The goals of the Cub Scout leader are:

- 1) To seek out and maximize the many opportunities to incorporate character development
- 2) To convince the young Cub Scout that character is important to the individual, to his family, community, country, world, and God.

Character development should not be viewed as something done occasionally as part of a separate program, or as part of only one area of life. For in reality, character development is a part of everything a Cub Scout does. Character development lessons can be found in every aspect of the Cub Scouting experience.

When it comes to developing character, the complete person must be considered. Character development involves at least three critical areas:

- 1 - Know (thought)
- 2 - Commit (feeling)
- 3 - Practice (behavior)

Addressing these three critical areas and relating them to a specific core value is referred to in Cub Scouting as **Character Connections®**.

Character Connections® asks the Cub Scout to:

KNOW - Character development includes moral knowledge—both awareness and reasoning. For example, children must understand what honesty means and they must be able to reason about and interpret each situation, and then decide how to apply the principles of honesty.

*What do I think or know about the core value?
How does the context of this situation affect this core value? What are some historical, literary, or religious examples representing the core value?*

COMMIT - Character development includes attention to moral motivation. Children must be committed to doing what they know is right. They must be able to understand the perspectives of others, to consider how others feel, and to develop an active moral conscience.

Why is this core value important? What makes living out this core value different? What will it take to live out this core value?

PRACTICE - Character development includes the development of moral habits through guided practice. Children need opportunities to practice the social and emotional skills necessary for doing what is right but difficult, and to experience the core values in their lives.

How can I act according to this core value? How do I live out this core value? How can I practice this value at school, at home, and with my friends?



To make Character Connections® an integral part of Cub Scouting, the 12 core values have been integrated throughout the boys' handbooks (see next page) and advancement program. Program support for character development can be found in *Den and Pack Meeting Resource Guide*, in the *Cub Scout Leader Book*, and at your monthly roundtable meetings.

Core values are the basis of good character development.

Character must be broadly defined to include thinking, feeling, and behavior.

Core values should be promoted throughout all phases of life

CHARACTER CONNECTIONS® IN THE HANDBOOKS

Citizenship

Tiger Cub: 2 - Where I Live
 Bear: 3j - What Makes America Special?
 Webelos: Citizen Activity badge

Compassion

Bear: 24f - Be a Leader

Cooperation

Wolf: 10a - Family Fun

Courage

Wolf: 12a - Making Choices
 Bear: 11g - Be Ready
 Webelos: Readyman Activity badge

Faith

Tiger Cub: 5 - Let's Go Outdoors
 Wolf: 11a - Duty to God
 Bear: 1a - Ways We Worship
 Webelos: 8 – Faith

Health and Fitness

Tiger Cub: 3 - Keeping Myself Healthy and Safe
 Webelos: Health and Fitness Activity badge

Honesty

Bear: 18h - Jot it down
 Webelos: Arrow of Light: 7

Perseverance

Webelos: Athlete Activity badge

Positive Attitude

Wolf: 6a - Start a Collection
 Webelos: Scholar Activity badge

Resourcefulness

Bear: 21g - Build a Model

Respect

Tiger Cub: 4 - How I Tell It
 Wolf: 7a - Your Living World
 Bear: 8g - The Past is Exciting and Important
 Webelos: Naturalist Activity badge

Responsibility

Tiger Cub: 1 - Making My Family Special
 Wolf: 9a Be Safe at Home and on the Street
 Webelos: Handyman Activity badge

Tigers - six values

Responsibility - page 38
 Citizenship - page 49
 Health and Fitness - page 58
 Respect - page 65
 Faith - page 73
 Honesty - page 30

Bears -seven values

Resourcefulness - page 156
 Citizenship - page 34
 Honesty - page 140
 Respect - page 72
 Faith - page 26
 Compassion – page 174
 Courage - page 96

Wolfs - seven values

Positive Attitude - page 70
 Respect - page 74
 Responsibility - page 82
 Cooperation - page 88
 Faith - page 94
 Courage - page 100
 Honesty - page 18

Webelos - nine values

Faith - page 50-51
 Honesty - page 42,46
 Perseverance - page 124
 Citizenship - page 144
 Health and Fitness - page 246
 Responsibility - page 300
 Respect - page 318
 Courage - page 366
 Positive Attitude - page 392

QUOTES FOR CHARACTER CONNECTIONS®

“The measure of a man’s real character is what he would do if he knew he would never be found out.”
--Thomas B. MacCaulay

Citizenship

“Ask not what your country can do for you, but what you can do for your country.”
--John F. Kennedy

Compassion

“No act of kindness, no matter how small is ever wasted.” -- Aesop

Cooperation

“United we stand, divided we fall.” -- Aesop

Courage

“The ultimate measure of a man is not where he stands in moments of comfort, but where he stands at times of challenge and controversy.” -- Martin Luther King Jr.

Faith

“Faith is taking the first step even when you don't see the whole staircase.” -Martin Luther King, Jr.

Health and Fitness

“Early to bed, early to rise, makes a man healthy, wealthy and wise. “ --Benjamin Franklin

Honesty

“Honesty is the first chapter in the book of wisdom” -- Thomas Jefferson

Perseverance

“If at first you don’t succeed, try, try again.”

Positive Attitude

“If life gives you lemons, make lemonade”

Resourcefulness

“There are those who look at things the way they are and ask why? I dream of things that never were and ask why not?” -- Robert F. Kennedy

Respect

“Do unto others as you would have them do unto you.” -- The Golden Rule

Responsibility









“The price of greatness is responsibility.” -- Sir Winston Churchill









Note: There are some great Character Connection® activities in the Tiger Cub Section of this Book.





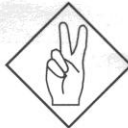



CUB SCOUT

Character Development

Ideas for Connecting Core Values with Outdoor Activities

	Citizenship	Compassion	Cooperation	Courage
Hikes 	Hike to a polling place during an election. Hike to a museum or historical building and learn about the history of your community. Take an historical hike.	Take turns carrying items for each other on the hike. Do an "inch hike" to become aware of small animals we may harm if walking quickly.	Plan a hike that includes opportunities for problem solving by teams (set these up ahead of time). Discuss how following the leader can help the team.	Meet the challenges of the trail. Plan ahead for situations that will challenge the boy's courage, including hug a tree if "lost."
Nature Activities 	Clean up trash in a designated area. Observe a certain species to see how its citizens live together and what "laws" they obey.	Make bird feeders and keep them filled for at least one winter season. Play the Camera Game (Cub Scout Leader How-To Book).	Watch an anthill and point out cooperative behavior. Pair boys to work together when doing an activity.	Study a certain species and how it reacts to danger, paying attention to how adults are courageous when guarding their young.
Service Projects 	Raise the flag at the local school every morning for a specific period of time. Do some community clean-up projects.	Give service to elderly or disabled people, such as helping with trash, filling bird feeders, planting flowers, sweeping, watering, taking in newspaper, etc.	Have den or pack collect recyclable materials to earn money for a good cause.	Arrange for a safe visit to a food kitchen or homeless shelter and talk about how it takes courage to ask for help from others and courage to help those who are different than we are.
Games and Sports 	Play a team sport and discuss how the whole is greater than the sum of the individuals making it up. Relate this to everyday life and our society.	Experience a disability in a game or sport (for instance by being blindfolded or having an arm rendered unusable). Show understanding when others have trouble with a game. Never tease. Show how winning is doing one's best.	Play some games that involve cooperation of team members. (There are many outdoor games involving cooperation in the Cub Scout Leader How To Book.)	Play a game in which a boy has to ask for help from someone else. For some people, admitting they need help is having courage.
Ceremonies 	Hold a ceremony to inaugurate the denner or to graduate Wolf Cub Scouts to Bear or Bear Cub Scouts to Webelos Scouts, complete with "tux," "top hat," and judge."	Hold a ceremony to recognize compassionate behavior, especially to peers.	Demonstrate cooperation in a ceremony. (Example: one boy alone cannot light a candle with a match if the wind is blowing, but can do it when another boy shields the wick from the wind.)	Award the "Lion's Heart" to a boy who shows real courage in any appropriate situation. Place flags at a cemetery on Memorial Day.
Campfires 	Reenact the signing of the Declaration of Independence or other historic event. The boys could even be in costume and use a huge feather pen.	Give a skit showing opportunities for compassionate behavior. Don't laugh if someone makes a mistake. Clap for everyone.	Give a skit showing cooperative behavior. Boys show cooperation by joining in with songs and other campfire elements.	Give each boy a speaking part in the campfire, even if some fear speaking in public; give plenty of praise for their efforts. Do a skit about a hero.
Den Trips 	Visit a local governing body—city council, county commission, school board—to see government in action. Have lunch with the mayor or chief of police.	Visit shut-ins or elderly people at times other than holidays. Be patient and compassionate when waiting for others who need to rest or who are slower.	Visit a grocery store or other business and talk about how the employees cooperate to make the whole enterprise work smoothly.	Visit a dentist's office. Many people are afraid of dentists. Visit with a firefighter, or EMT.
Pack Overnighter 	Boys make up "laws" to govern their "tent city," discussing how good law benefits all citizens.	Bring someone who needs friends (child or adult). Share belongings with others who may have forgotten something. Be kind to those who may feel uncomfortable being away overnight.	Every boy brings one item for a special dessert or breakfast treat or craft project. Careful planning is necessary to ensure the project will not work if not all the parts are there.	Have a story-sharing hour around the campfire where adults share their experiences of being afraid or uncertain, and how they handled it. Plan a camp at military installation.

	Faith	Health and Fitness	Honesty	Perseverance
Hikes 	Conduct a Scouts Own hike. Hike to a place of worship.	Go on an exercise hike with stations to do specific exercises (many local parks have these already set up). Learn to take your pulse when walking to see how your body is reacting to the exercise.	Follow the Outdoor Code when hiking. After a hike, report accurately, what was observed or done.	Plan a hike where boys encounter obstacles similar to those an early explorer might have encountered. Talk about how pioneers and early explorers persevered to reach their destinations.
Nature Activities 	Identify divinity in the big and small things of nature.	Study what a certain species eats and how it lives. Discuss how eating right relates to health. Harvest healthy food (with permission or at a pick-your-own farm) or plant an edible crop.	Listen to boys when they are participating in an activity and praise honesty when you hear it.	Study plants that survive difficult environments. Encourage boys to keep trying when an activity is difficult.
Service Projects 	Help clean up a local place of worship or help with one of their activities (feeding the homeless or conducting a blanket drive).	Make gifts using recycled materials. Make exercise equipment for a local shelter.	Make posters that address being honest with parents about offers of drugs. Make posters discouraging shoplifting. Aim posters at peer group.	Institute a tutoring program. Boys can plan rewards for the students who persevere until they finish.
Games and Sports 	Remind boys that their physical abilities are a gift and reinforce that they should be thankful that they are so wondrously created.	Challenge each boy to compete against himself to become more fit. Record initial abilities and record again at end of a specific period to see improvement. Give a Fit Youth Award to all who improve. Most outdoor games and sports help to make bodies more fit.	Play a game in which each player must apply the rules to himself. Discuss how honesty makes playing games more fun. Discuss how winning feels when you are dishonest.	Play a game related to pioneers and discuss their perseverance to complete their journeys. Tell boys that those who persevere improve their skills.
Ceremonies 	Hold a trail devotion. Hold recognition ceremonies and pack celebrations outdoors in the beauty of nature.	Incorporate exercise equipment (real or prop) into a ceremony. The Cubmaster could jump rope across the room or lift "barbells" to find awards for boys.	In a ceremony, tell the George Washington-cherry tree story or one about Abraham Lincoln.	"Lewis and Clark" could conduct an awards ceremony. "George Washington" could also, after "crossing the Delaware". Pioneers could deliver awards from a covered wagon.
Campfires 	Include an item related to duty to God. Sing a song for the closing ceremony that incorporates faith (applicable to all members' faiths). Tell a story that incorporates the concept of faith.	Plan an entire campfire around this theme. Use songs with physical movements. The opening and closing ceremonies and skits could all use health and fitness themes.	Incorporate some good stories about the benefits of honest behavior.	Pioneer and frontier days are good themes to incorporate.
Den Trips 	Take a field trip to a place of worship. Visit an early church or mission and learn about the history and faith of people who lived in your area earlier.	Visit a local water treatment plant to see how this vital liquid is made safe for the population. Visit a farm or a place where healthy food is processed. Attend a sporting event.	Visit a local bank or courthouse and include a discussion of honesty. Visit a local retail store and talk about security and shoplifting. Turn something in to "Lost and Found."	Visit a local gym and talk with a personal trainer. Visit with a doctor and talk about education. Visit a local outdoor track facility and talk with a long-distance runner. All of these demonstrate perseverance.
Pack Overnighter 	Conduct a Scouts Own service, even if the overnighter does not take place on a traditional day of worship. An after-dark or sunrise Scouts Own could also be planned.	Boys plan the meals, discussing good nutrition. Discuss the need for lots of water.	If the campground is an "honor-system type, have boys fill out envelopes and pay fees. Perhaps set up a camp "store" that operates on the honor system. Involve boys in counting the money so they see whether everyone was honest in paying. Discuss what the result will mean for future overnighters.	Plan some Dutch oven cooking and open campfire cooking so boys experience something like pioneer life.

	Positive Attitude	Resourcefulness	Respect	Responsibility
<p>Hikes</p> 	<p>Have fun even when it is hard to do. If possible, plan a hike that is challenging (lengthy or difficult terrain). Have boys explore how to make this a good experience with positive attitudes.</p>	<p>Take a "search and find" hike. Look for different animal homes and discuss how resourceful they are in finding or making shelter.</p>	<p>Involve boys in getting permission to hike in a city, state, or national park. Work with park rangers in planning hikes on the public lands. Don't pick plants or harm wildlife.</p>	<p>Pair up with a buddy and be responsible for him throughout the hike. Stay on the trail. Leave no trace.</p>
<p>Nature Activities</p> 	<p>Visit a herpetologist or entomologist to talk about how insects and snakes contribute to world ecology. Relate this to having a positive attitude about everyone's place in the world.</p>	<p>Find nature everywhere: in a backyard, a puddle of water, a vacant lot, a flowerpot. Examine different birds' nests and discuss how resourceful birds are in finding materials to use.</p>	<p>Watch nature at work, but do not disturb it. Talk about respect for life.</p>	<p>Each boy brings a specific nature item to the meeting, demonstrating he is responsible to remember his assignment. Also, each boy is to show responsibility by bringing items that can be returned as they were found, and not disturbing any nature preserve or ecology site.</p>
<p>Service Projects</p> 	<p>Make cheery cards for others. Mail these to an "adopted" elderly or shut-in person on a regular basis. Look for opportunities to serve friends or family members who are having a tough time.</p>	<p>Have the boys make a quilt from materials they glean from their closets (with parents' permission) or extra material the families have. Donate the quilt to a local shelter.</p>	<p>Demonstrate respect for family by offering to help family members with tasks before being asked.</p>	<p>Mow the grass for an elderly neighbor for a specified time. Make a duty roster.</p>
<p>Games and Sports</p> 	<p>Bowling and golf are good games that bring the importance of positive attitude to mind. Design a game where boys have to turn "don'ts" and "can'ts" into "do's" and "can's". Always have a good attitude, whether you win or lose.</p>	<p>Play some problem-solving games. Have boys create their own game, or choose a pioneer-style game or a game from another culture.</p>	<p>Play croquet, which is a good game that requires respect for other players—waiting to take turns, conducting oneself in a courteous manner, etc.</p>	<p>Have each boy bring a certain piece of equipment to play a game (bat, ball, glove for baseball).</p>
<p>Ceremonies</p> 	<p>Discuss the positive attitude shown by the recipient of a public recognition, especially when it is for advancement.</p>	<p>Point out the resourcefulness of a boy in accomplishing advancement. Talk about pre-historic people and how they made tools from what they found. Note that we all must work with what we have.</p>	<p>In a ceremony, show respect for parents or leaders who helped teach the skills to meet requirements for the award.</p>	<p>Do a den ceremony where each boy is responsible to act or say his part. Adults model responsibility by having advancement.</p>
<p>Campfires</p> 	<p>Use a story about positive attitude. Talk about why we applaud and join in when others are performing. Discuss why it's important not to grumble or complain about your part in a skit or ceremony.</p>	<p>Have boys build an "indoor campfire" for those times when they want a campfire setting but cannot be outdoors.</p>	<p>Involve boys in planning appropriate activities for a campfire. Discuss the importance of respecting others' feelings while having fun: no put-downs or negative cheers.</p>	<p>Boys could help set up and clean up the campfire area, making sure the fire is completely out.</p>
<p>Den Trips</p> 	<p>Visit with someone who has overcome an adverse situation through positive attitudes. Thank others who show a positive attitude when they have to wait in line, or take second choice on something.</p>	<p>Visit a recycling center. Visit a quilt shop and talk about the history of quilts—how early Americans used everything they had. Discuss how early Americans had to raise and grow all of their own food.</p>	<p>Visit a local courthouse. Talk about the jury system in America and how our law respects each citizen by presuming innocence until guilt is proven. Note that it is not that way in all countries. Conduct a mock trial during the visit or in the den.</p>	<p>Visit a local bank or credit union and talk about how these institutions are responsible for safeguarding other people's money.</p>
<p>Pack Overnighter</p> 	<p>Present boys with obstacles to overcome in order for overnighter to happen (can't get campground we wanted; rain forecast for that weekend; not enough tents or sleeping bags, etc.). Guide them to a resolution, emphasizing a positive attitude.</p>	<p>Have an indoor overnighter—playing board games, cards, or games the boys have made themselves.</p>	<p>Involve boys in setting rules for overnighter (quiet hours, duty roster, who eats first). Discuss how many of these relate to respect for others.</p>	<p>Have boys help plan one of the overnighter activities. Be sure to discuss afterwards how success is related to responsible behavior.</p>

Cub Scout



Academics and Sports Program

The Cub Scout Sports and Physical Fitness Program was introduced to Cub Scouts in 1984. In 1991 the academic belt loops and pins were added and the name was changed. Through the years different sports and academics have been added. At the beginning of 2010 we saw the addition of 13 new belt loops and pins. We have included here a simplified chart of all the three requirements for a belt loop in each category. Earning one of these belt loops helps a boy learn and develop a skill. It focuses on doing ones best.

ACADEMICS AND SPORTS PROGRAM

The Cub Scout Academics and Sports program is a supplemental enrichment program that complements the existing Cub Scout program. Listed below are the Academics subjects and Sports activities available to Cub Scouts and Webelos Scouts. The Cub Scout Academics and Sports Program Guide, belt loops, and pins are available at your local Council Service Center.

The **Shooting Sports** belt loops and pins (Archery and BB Shooting) can only be earned under BSA range trained supervision. The BB Shooting loop and pin **MUST** be earned at a BSA facility range.

BELT LOOPS AND ADVANCEMENT REQUIREMENTS

Wolf and Bear: The belt loops for the Shooting Sports (Archery and BB Shooting) can be used toward Wolf Elective 20 and Bear Achievement 23 and Elective 20. Most of the sports belt loops can count towards Wolf Elective 20, Bear Achievement 15, 23 and Bear Elective 20.

- Citizenship BL Wolf Elective 2, 4, & 9. Bear Achievement 7f & 24
- Collecting BL Wolf Achievement 6
- Communicating B Wolf Elective 1, Bear Achievements 4, 17, & 18
- Language and Culture BL Wolf Electives 1 & 10, Bear Elective 24
- Heritages BL Bear Achievement 8 and Bear Elective 24
- Map and Compass BL Bear Elective 23
- Music Wolf Elective 11. Bear Elective 8
- Science Bear Elective 4
- Weather Bear Elective 2
- Wildlife Conservation Wolf Achievement 7 Elective 13. Bear Achievements 5, 6 and Electives 12 & 15

WEBELOS: To be used for Webelos Activity badges, the belt loops must be earned **WHILE** a Webelos Scout, even if they had already been earned by the Cub Scout while a Tiger Cub, Wolf, or Bear.

Sports - The Swimming belt loop can be used for the **Aquanaut Activity badge**, the Physical Fitness belt loop can be used for the **Athlete and Fitness Activity badges**, and a number of Sports belt loops can be used by Webelos Scouts when working on the **Sportsman Activity badge**. In addition to the other requirements, a Webelos Scout must earn two belt loops in individual Sports, and two more in team sports to earn that Activity badge.

Academics - Many of the Academic belt loops can be used by Webelos Scouts when working on various Activity badges. The **Science belt loop is required for the Scientist Activity badge**, and the **Citizenship belt loop is required for the Citizen Activity badge**, which is required for the Webelos badge. By earning the following belt loops you can also get credit towards the listed **Webelos Activity badges**:

- | | | | |
|-----------------------|----------------------|-------------------------------|----------------------------------|
| Art BL ----- | Artist | Language and Culture BL ----- | Scholar |
| Astronomy BL ----- | Scientist | Maps and Compass BL ----- | Traveler |
| Chess BL ----- | Scholar | Mathematics BL ----- | Scholar, Engineer |
| Communicating BL ---- | Communicator | Music BL ----- | Showman |
| Computers BL ----- | Communicator | Weather BL ----- | Scientist |
| Geography BL ----- | Traveler | Wildlife Conservation BL ---- | Naturalist |
| Geology BL ----- | Geologist | | Forrester and Outdoorsman |
| Heritages BL ----- | Family Member | | |

ACADEMIC BELT LOOP REQUIREMENTS

Additional requirements may be completed to earn the Academic Pins for each of these belt loops. Please see the *Cub Scout Academics and Sports Program Guide*, for full requirements and information on each belt loop and pin. You may also go to: <http://usscouts.org/advance/cubscout/a-sindex.asp>

Academic BL	Requirement #1	Requirement #2	Requirement #3
Art	Make a list of common materials used to create visual art compositions.	Demonstrate how six of the following elements of design are used in a drawing: lines, circles, dots, shapes, colors, patterns, textures, space, balance, or perspective.	Identify the three primary colors and the three secondary colors that can be made by mixing them. Show how and use to create a painting.
Astronomy	Demonstrate how to focus a simple telescope or binoculars.	Draw a diagram of our solar system – identify the planets and other objects.	Explain the following terms: planet, star, solar system, galaxy, the Milky Way, black hole, red giant, white dwarf, comet, meteor, moon, asteroid, star map and universe.
Chess	Identify the chess pieces and set up a chess board for play.	Demonstrate the moves of each chess piece to your den leader or adult partner.	Play a game of chess.
Citizenship	Develop a list of jobs you can do around the home. Chart your progress for one week.	Make a poster showing things that you can do to be a good citizen.	Participate in a family, den, or school service project.
Collecting	Begin a collection of at least 10 items that all have something in common. Label the items and title your collection.	Display your collection at a pack or den meeting.	Visit a show or museum that displays different collections.
Communicating	Tell a story or relate an incident to a group of people,	Write and send a letter to a friend or relative.	Make a poster about something that interests you. Explain the poster to your den.
Computers	Explain these parts of a personal computer: central processing unit (CPU), monitor, keyboard, mouse, modem, and printer.	Demonstrate how to start up and shut down a personal computer properly.	Use your computer to prepare and print a document.
Family Travel	Make a list of things you would take on a three-day trip with your family, then pack these items in a bag or suitcase.	With an adult's help, figure out the cost and miles to complete a trip to a place of interest using the family car or public transportation.	Research at least five places to visit during a trip to a place of interest. Explain what you learned to your family.
Geography	Draw a map of your neighborhood. Show natural and artificial features. Include a key or legend of map symbols.	Learn about the physical geography of your community. Identify the major landforms within 100 miles. Discuss with an adult what you learned.	Use a world globe or map to locate the continents, the oceans, the equator, and the northern and southern hemispheres. Learn how longitude and latitude lines are used to locate a site.

ACADEMIC BELT LOOP REQUIREMENTS – Continued

Academic BL	Requirement #1	Requirement #2	Requirement #3
Good Manners	Make a poster that lists five good manners that you want to practice. Share your poster with your den or family.	Introduce two people correctly and politely. Be sure that one of them is an adult.	Write a thank-you note to someone who has given you something or done something nice for you.
Heritages	Talk with members of your family about your family heritage: its history, traditions, and culture.	Make a poster that shows the origins of your ancestors. Share it with your den or other group.	Draw a family tree showing members of your family for three generations.
Language and Culture	With your parent's or adult partner's permission, talk with someone who grew up in a different country than you did. Find out what it was like and how it is different from your experience.	Learn 10 words that are in a different language than your own.	Play two games that originated in another country or culture.
Map and Compass	Show how to orient a map. Find three landmarks on the map.	Explain how a compass works.	Draw a map of your neighborhood. Label the streets and plot the route you take to get to a place that you often visit.
Mathematics	Do five activities within your home or school that require the use of mathematics. Explain to your den how you used everyday math.	Keep track of the money you earn and spend for three weeks.	Measure five items using both metric and nonmetric measures. Find out about the history of the metric system of measurement.
Nutrition	Make a poster of foods that are good for you. Share the poster with your den.	Explain the difference between a fruit and a vegetable. Eat one of each.	Help prepare and eat a healthy meal of foods that are included in a food pyramid. (With your parent's or adult partner's permission, see http://www.mypyramid.gov .)
Photography	Point out the major features of a camera to your den or family and explain the function of each part. Parts could include film, lens, shutter, power on and off, zoom, battery, flash, display panel, case, settings, etc.	Discuss with your den leader or adult partner, the benefits and contributions photography makes to modern life. Report what you learned to your den or family.	Using a camera, take at least 10 pictures of your family, pet, or scenery; show these to your den.
Reading and Writing	Visit a library and get your own library card. Check out and return a book.	Write a letter or a short story. Read it to your den or family.	Keep a diary of your activities for one week. Read it to your den or family.
Science	Explain the scientific method to your adult partner.	Use the scientific method in a simple science project. Explain the results to an adult.	Visit a museum, a laboratory, an observatory, a zoo, an aquarium, or other facility that employs scientists. Talk to a scientist about his or her work.

ACADEMIC and SPORTS BELT LOOP REQUIREMENTS

Academic BL	Requirement #1	Requirement #2	Requirement #3
Weather	Make a poster that shows and explains the water cycle.	Set up a simple weather station to record rainfall, temperature, air pressure, or evaporation for one week.	Watch the weather forecast on a local television station. Discuss with an adult family member what you heard and saw. Follow up by discussing the accuracy of the forecast.
Wildlife Conservation	Explain what natural resources are and why it's important to protect and conserve them.	Make a poster that shows and explains the food chain. Describe to your den what happens if the food chain becomes broken or damaged.	Learn about an endangered species. Make a report to your den that includes a picture, how the species came to be endangered, and what is being done to save it.

SPORTS BELT LOOP REQUIREMENTS

Sports Belt Loops	Requirement #1	Requirement #2	Requirement #3
Badminton	Explain the rules of badminton to your leader or adult partner.	Spend at least 30 minutes practicing badminton skills.	Participate in a badminton game.
Baseball	Explain the rules of baseball to your leader or adult partner.	In three separate sessions, spend at least 30 minutes practicing baseball skills.	Participate in a baseball game.
Basketball	Explain the rules of basketball to your leader or adult partner.	Spend at least 30 minutes practicing basketball skills.	Participate in a basketball game.
Bicycling	Explain the rules of safe bicycling to your den leader or adult partner.	Demonstrate how to wear the proper safety equipment for bicycling.	Show how to ride a bike safely. Ride for at least half an hour with an adult partner, family, or den.
Bowling	Explain to your leader or adult partner the rules of courtesy and safety for bowling.	Show how to pick out a ball of proper weight and with finger holes that fit your hand.	Play a complete game with your family or den.
Fishing	Review your local fishing regulations with your leader or adult partner. Explain why they are important, and commit to following them.	Demonstrate how to bait a hook properly.	Spend at least 30 minutes trying to catch a fish.
Golf	Explain the rules to your leader or adult partner. Explain the need for caution concerning golf clubs and golf balls.	Spend at least 30 minutes practicing golfing skills at a driving range.	Spend at least 30 minutes practicing golfing skills at a chipping/putting range.
Gymnastics	Explain the six events of men's gymnastics:.	Explain the safety rules you should follow to learn gymnastics.	Participate in an exercise from three of the six events using the proper equipment and techniques.
Hiking	Explain the hiking safety rules to your den leader or adult partner. Practice these rules while on a hike.	Demonstrate proper hiking attire and equipment.	Hike at least 30 minutes with your adult partner, family, or den.

SPORTS BELT LOOP REQUIREMENTS – Continued

Sports Belt Loops	Requirement #1	Requirement #2	Requirement #3
Horseback Riding	Explain five safety precautions for when you are near a horse.	With help from an experienced horse handler, demonstrate how to safely dismount the horse.	Go on a supervised horseback ride for at least 20 minutes. Wear an approved helmet.
Kickball	Explain the rules of kickball to your leader or adult partner.	Spend 30 minutes practicing the skills of kick-ball (pitching, kicking, base running, catching, throwing). This may be over two different practice periods.	Play a game of kickball.
Marbles	Explain the rules of Ringer or another marble game to your leader or adult partner.	Spend at least 30 minutes practicing skills to play the game of Ringer or another marble game.	Participate in a game of marbles.
Physical Fitness	Give a short report to your den or family on the dangers of drugs or alcohol.	Practice finding your pulse and counting your heart beats per minute. Determine your target heart rate.	Practice 5 physical fitness skills regularly. Improve performance in each skill over a month. Skills could include pull-ups, sit-ups, the standing long jump, the 50-yard dash, and the softball throw.
Skateboarding	Demonstrate to an adult the general rules for safe skateboarding by showing that you know how to wear the proper safety gear.	Carefully demonstrate how to fall to help minimize injuries.	Practice skateboarding for 30 minutes. This practice may be done in several periods.
Snow Ski and Board Sports	Explain conditioning, clothing, equipment, and planning needed for snow skiing or boarding.	Explain "Your Responsibility Code," the rules of safety and courtesy for the slopes.	Go skiing or snowboarding. Demonstrate how to stop and turn.
Soccer	Explain the rules of soccer to your leader or adult partner.	Spend at least 30 minutes practicing soccer skills.	Play a game of soccer.
Softball	Explain the rules of softball to your leader or adult partner.	Spend at least 30 minutes practicing softball skills.	Participate in a softball game.
Swimming	Explain the rules of Safe Swim Defense. Emphasize the buddy system.	Play a recreational game in the water with your den, pack, or family.	While holding a kick board, propel yourself 25 feet using a flutter kick across the shallow end of the swimming area.
Table Tennis	Explain the rules of table tennis to your leader or adult partner.	Spend at least 30 minutes practicing table tennis skills.	Participate in a table tennis game.
Tennis	Explain the rules of tennis to your leader or adult partner.	Spend at least 30 minutes practicing tennis skills.	Participate in a tennis game.
Ultimate	Explain the rules of ultimate or disc golf to your leader or adult partner.	Spend at least 30 minutes practicing ultimate or disc golf skills.	Participate in a game of ultimate or disc golf.
Volleyball	Explain the rules of volleyball to your leader or adult partner.	Spend at least 30 minutes practicing skills to play the sport of volleyball.	Participate in a volleyball game.



Tiger Cubs

The Tiger Cub program was first introduced in 1982, they were made an official part of the pack in 1993. The first Tiger Cub Handbook came out in 2001. And in 2004 their official uniforms changed from the orange t-shirts to the blue Cub Scout uniform.

If you are interested in or if you are already involved as a Tiger den leader or as an adult partner there is information in this section just for you.

TIGER CUB BASICS

IT'S GR-R-R-EAT TO BE A TIGER CUB!



Do you know a first grader or a 7-year-old boy who wants to experience the fun of Cub Scouting? Then Tiger Cubs is for him! Tiger Cubs introduces boys and their adult partners to the excitement of Cub Scouting as they "Search, Discover and Share". The basic element of Tiger Cubs is the Tiger Cub-adult partner team. A boy must register with an adult partner. The adult may be a parent, brother, sister, aunt, uncle or even a neighbor. The requirements are that the adult partner be 18 years of age or older, care about the boy, and be strongly committed to his well-being.

Now, many of you are reading this and thinking, "We don't have a Tiger Cub den in our pack." That may be the case. The majority of units in the Utah National Parks Council are chartered by the LDS Church, and the LDS Church does not utilize Tiger Cub dens as part of their packs. Does that mean LDS boys cannot be Tiger Cubs? Of course not. LDS boys and their families interested in Tiger Cubs may join other units that do have the program as part of their pack. Many other religious denominations and community groups in the Council have thriving Tiger Cub dens and are happy to have

boys of any religious affiliation. Check with your local district leaders to find out if there is a Tiger Cub den in your area. The purpose of this section is to provide some resources for Tiger Cub den leaders and adult partners. So, let's Search, Discover and Share some things about Tiger Cubs.

AM I QUALIFIED?

Check out the Cub Scout Leader Book for the qualifications and responsibilities of a Tiger Cub den leader.

UNDERSTANDING THE PROGRAM

The Cub Scout Leader Book and The Cub Scouts Den and Pack Meeting Resource Guide are excellent resources to help you understand the Tiger Club program. Becoming familiar with the Tiger Cub Handbook is also a great way to learn the program. It contains an "Introductory Guide for Tiger Cub Adult Partners" as well as information on advancement and shared leadership. Plus, the better you know the Tiger Cub Handbook, the better you will be able to provide opportunities for fun and advancement in your den.

SHARED LEADERSHIP

The Tiger Cub den leader does not have an "official" assistant den leader. Why? Because, each adult partner functions as an assistant to the den leader. This is known as shared leadership. Each Tiger Cub-adult partner team is responsible for hosting one or more months of den meetings with the den leader. This insures direct involvement of adult partners. It is an expected part of their participation in the program. It is not optional.

UNDERSTANDING BOYS

Never worked with boys before? Want to know why they do what they do? See the Cub Scout Leader Book. The Cub Scout Leader How-To Book section 1, pages 12-14 also gives great management tips.

EARN PRIZES

Okay, it's not exactly a prize, it's an award. As a Tiger Cub den leader, you are eligible to earn the Tiger Cub Den Leader Award. It requires tenure, training and performance. Be an example to your boys and the other leaders in your pack by earning this award. Besides, it comes with a cool orange and black knot to wear on your uniform.

REQUIRED READING - SCOUTING MAGAZINE AND BOYS' LIFE

As a registered leader, you should receive Scouting magazine. Read it. It will keep you up to date on all the new stuff going on in Scouting. You can also get program planning hints by reading the articles about what other packs all over the country have done. Order Boys' Life magazine through your local service center. The "Think and Grin" section is worth the subscription price alone. Plus, there are stories, games, and fun for the boys. Encourage them to subscribe and read it too!

TIGER CUBS ONLINE

There are tons of resources on the internet that deal with Cub Scouts. Here 's a few of our favorites when it comes to Tiger Cubs. www.usscouts.org/usscouts/bbugle.asp (Baloo's Bugle, an internet Roundtable with tons of stuff for all Cub leaders.) www.macscouter.com/cubscouts (Online pow wow books)

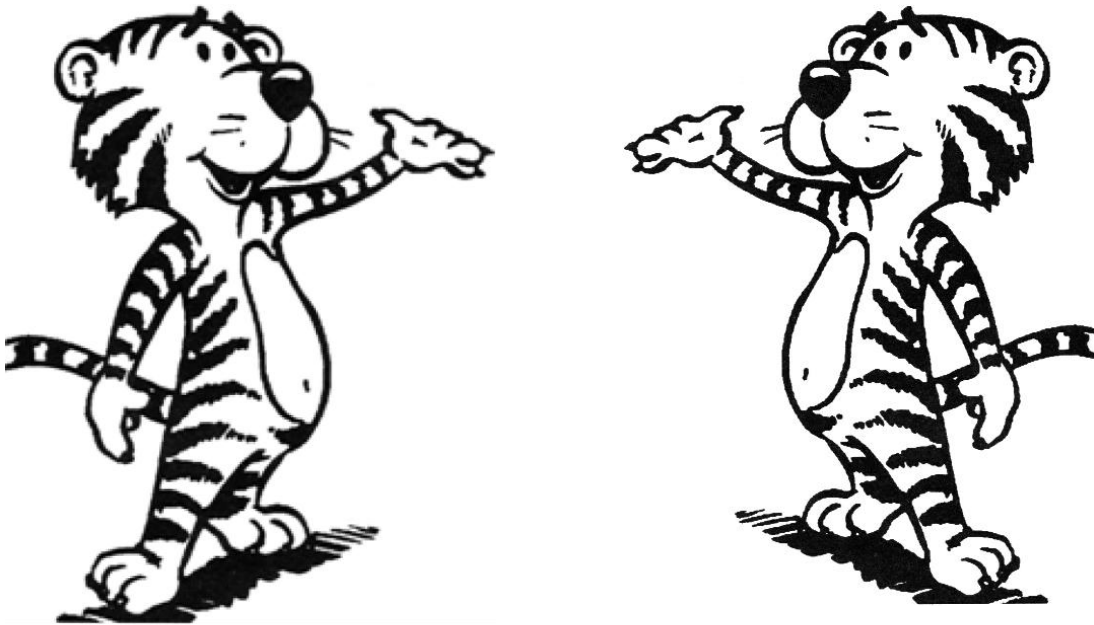

CHARACTER CONNECTIONS® FOR TIGERS

Character Connections® is defined as: "A reflection discussion that addresses the thinking (head), feeling (heart) and behavior (hand) experiences related to 12 core values." Character Connections® is a tool to help our boys to develop into good people. Certain requirements in the handbook are designated as Character Connection activities. Usually this involves discussion, and let's face it - that can be really boring for 7-year-olds. So, here are some ideas to spice up your Character Connections®. This is not meant to replace the discussion, but to supplement it. The games and activities suggested here can be used as an introduction to the Character Connection® discussion (play the game, then talk about how you felt) or as a reinforcement of the discussion (play the game after the discussion). Hopefully, the activities will help the boys remember how they felt during the discussion, and practice lessons taught there.



Tiger Cubs Achievement 1: Making My Family Special

Character Connection® - Responsibility: Fulfilling our duty to take care of ourselves and others. (Brothers taking care of each other)

Divide the Cub Scouts into two groups. Group A forms the inner circle facing outward and group B the outer circle facing inward. Have the players facing each other hold hands to pair off the "brothers". (Or use a boy and his adult partner as brothers.) They drop hands and on signal, the circles march in opposite directions. When you shout "brothers!" the pairs find each other, hold hands and kneel down. The last pair to kneel drops out of the game. Continue until two brothers are left. Keep the Bread Basket Full (Taking care of ourselves and others.) One boy has a box that has 15 to 20 tennis balls (loaves of bread) in it. The boy picks up one "loaf" at a time and rolls it across the ground. The rest of the players race after the "bread" to put them back in the box. The boy rolling the loaves tries to empty out the box, while the other boys objective is to return them as quickly as possible.

Tiger Achievement 2: Where I Live

Character Connection® - Citizenship: Contributing service and showing responsibility to local, state and national communities.

Pledge of Allegiance Relay: Create two sets of word strips containing phrases or words from the Pledge of Allegiance. Scatter each set on the floor in front of each team. The first Tiger Cub/adult partner pair runs to the phrases, selects the first phrase, sets it aside, and returns to their team where they tag the next pair. That pair runs forward and finds the next phrase, then adds it to the first. The game continues until the teams have spelled out the entire Pledge. The first team to finish wins.

American Heritage: Make posters of well-known U. S. buildings, symbols, or people. (Old calendars, newspapers, magazines, and computer clip art programs are good sources for these images.) Number each poster and hang them up around the room. Give each Tiger Cub/adult partner pair a piece of paper which is also numbered. Ask them to identify the posters and write the name by its corresponding number on the paper. Give a point for each correct answer, and give bonus points if they can tell where the building is located, or if they have visited that site. Some suggestions: President and Vice President, Governor, American flag, State flag, White House, Statue of Liberty, Mount Rushmore, Eagle, Uncle Sam, State capital building, City hall, etc.

Tiger Achievement 3: Keeping Myself Healthy and Safe

Character Connection® - Health and Fitness: Being personally committed to caring for our minds and bodies.

Food Find: Before the meeting, hide cans, packages or pictures of food around the meeting place. Divide the group into two teams and let them search for the food. (Keep a list to make sure you find everything that was hidden.) Once all the food is found, provide each team with a copy of the food pyramid and let them place the food on the correct spot on the pyramid.

Fitness Circle Game: Form a circle as large as the room permits with all players facing the same direction. (The Cub Scout Leader *How-To Book* has lots of physical fitness activities in chapter 3.)

Give instructions for various activities such as these:

1. Start walking in a circle and keep walking between these exercises.
2. Start hopping.
3. Make yourself as small as possible and continue walking.
4. Make yourself as tall as possible and continue walking.
5. Bend your knees slightly, grasp your ankles, and continue walking.
6. Walk as if the heel of one foot and the toes of the other were sore.
7. Squat down and jump forward from that position.
8. Walk on hands and one foot, with the other leg held high, imitating a lame dog.
9. Walk forward at a rapid pace (don't run) while swinging your arms vigorously.

Tiger Achievement 4: How I Tell It

Character Connection® - Respect: Showing regard for the worth of someone or something.

Respect for nature: Know your Rock - Each boy finds a fist-sized rock, remembering where he found it so he can return it after the game. All sit in a circle with eyes shut, holding their rocks. Tell them to "get to know" their rock by its feel, texture, smell, etc. After a few minutes, collect the rocks, mix them up, and redistribute them. The boys pass the rocks around the circle and try to identify their own rock with their eyes shut. To help prevent any disagreements, affix a small piece of tape to each rock with the owner's initials. Remember to remove the tape when you leave the rock behind. Chapter 4 of the Cub Scout Leader *How-to Book* has more hiking games and outdoor fun.

Tiger Achievement 4: How I Tell It

Character Connection® - Respect: Showing regard for the worth of someone or something

Respect for others: Who Am I? - With the help of their partners, have each of the Tiger Cubs write a short descriptive paragraph about themselves stating likes, dislikes, things they have done, etc. When all are done, have an adult partner read them out loud and let the boys try to guess who is being described. Chapter 6 page 14 of the Cub Scout Leader *How-to Book* has games for a Disabilities Awareness Day. These games can be used to teach boys to respect those with disabilities.

Achievement 5: Let's Go Outdoors

Character Connection® - Faith: Having inner strength or confidence based on your trust in a higher power.

Circle Race Game: Instruct each team to hold hands to form a circle with all facing out except the "driver." On signal, the teams race to the distance line and back, keeping their circles intact. All the players in a team must cross the distance line. The driver gives directions and orders. When the circle breaks, it must be reformed before a team may continue on. The first team to get all its men across the starting line is the winner.

TIGER CUB GAMES and SKITS

TIGER FEET RELAY - Materials needed: Large piece of cardboard, empty tissue boxes, craft paint or orange spray paint, glue. Make two pairs of feet, one pair for each relay team. Draw the outline of a tiger foot about 14 inches long. Cut out. Use a template to trace all feet the same size. Cut the tissue box in halves and glue them down on the tiger feet with the bottom facing up. Make sure the back of the box is open so your feet can slip into the pocket made by the box. Decorate your tiger feet. To race, divide the group into two teams. The first player on each team puts on the tiger feet, races to a point, comes back and hands the feet to the next racer. The first team finished is the winner.

THE TIGER'S ROAR - This noisy game is played outside. All Tiger Cubs line up side by side. At the signal, they roar as loudly as they can and run as fast as they can. They run as long as they can roar without taking another breath. When they can no longer roar, they must stop. Try variations in the movements: skipping, hopping, giant steps, etc.

THE HUNTER AND THE TIGER - Blindfold two players - a hunter and a tiger. Stand them at the opposite ends of a table, placing hands on it. On signal, the hunter will move at will around the table while the tiger evades him. One hand must be kept on the table at all times. When the tiger is tagged, he becomes the hunter and appoints a new tiger.

THE ROAR – Skit - One Tiger Cub goes to the front of the room and stands alone. Each Tiger Cub enters and then the Tigers 'roar' to one another. This is repeated until all the Tigers have entered. Then the Tiger Cubs turn to the audience and say in unison: "We're having a roaring good time!"

TIGER CUBS ARE GREAT - Skit

Narrator: This is a Tiger Cub den. (Tiger Cubs enter and stand in a line facing the audience.)

Please introduce yourselves.

(Tiger Cub turns to the boy next to him, shakes hands and says "Hi, I'm . . .")

No!! Introduce yourselves to the audience. (Each Tiger Cub in turn steps forward and says his name.)

Narrator: Let me tell you some things about our Tiger Cubs. Tiger Cubs are smart. (Boys look serious, scratch their heads, look deep in thought.)

Sometimes they are giggly. (Boys start to giggle.)

And sometimes they are wiggly. (Boys wiggle.)

Tiger Cubs are strong. (Boys make muscles and pose.)

And fast. (Boys run swiftly in place.)

They love to make noise. (Boys howl.)

But they know when to be quiet. (Boys bow heads and pretend to pray.)

Tiger Cubs love to Search . . . (Boys shade eyes with hands and look all around.)

Discover . . . (Boys pretend to find something and get excited.)

and Share. (Boys pretend to share with others.)

But most of all . . . Boys: Tiger Cubs are GRRRRRRR-EAT!!!!

TIGER CUB SONGS

WE ARE TIGERS

(Tune: Are You Sleeping (Can be sung as a round))

We are Tigers, we are Tigers,
On the go, on the go.
Search, discover, share,
Search, discover, share,
As we grow, as we grow.

TIGER, TIGER, LITTLE SCOUT

(Tune: Twinkle, Twinkle Little Star)

Tiger, tiger, little Scout,
What is Tiger Cubs about?
Having fun and lots of joys,
Making friends with other boys,
Tiger, tiger, little Scout,
That's what Tiger Cubs about.

HOORAY TIGER CUBS

(Tune: If You're Happy and you know it)

We are Tiger Cubs, hooray Tiger Cubs!
We are Tiger Cubs, hooray Tiger Cubs!
We are happy and we show it,
'Cause we want the world to know it!
We are Tiger Cubs, hooray Tiger Cubs!

Verse 2: change the third line to:
We will Search, Discover, Share

Verse 3: Change the third line to:
We will soon be Cub Scouts too,
And we'll wear the gold and blue.



TIGER CEREMONIES

WELCOME, TIGER CUBS

This is a great ceremony to start off the new program year and welcome the Tiger Cubs into the pack.

Personnel: Six Cub Scouts

Equipment: Sign for each Cub as indicated below.

CUB 1: (holding sign with Tiger Cub emblem) Some future Cub Scouts in our pack are here with us today. Welcome to our new found friends, Tiger Cubs, B. S. A.

CUB 2: holding sign saying SEARCH, DISCOVER, SHARE) Please look forward to when you become a Bobcat, Wolf, then Bear. But practice your great motto now SEARCH, DISCOVER, SHARE.

CUB 3: (holding a picture of a Cub in uniform) Soon a Cub Scout you'll become and join our happy fold. We know you'll be as proud as us to wear the blue and gold.

CUB 4: (holding a picture of Bobcat badge) The first step as you join the pack and we hope you'll do just that, is to learn a few requirements that will make you a BOBCAT.

CUB 5: (holding Wolf book) As a Cub Scout you'll have such fun you may even do a dance. So, work hard with Mom and Dad and to a Wolf Cub you'll advance.

CUB 6: holding a sign saying "Do Your Best" But in everything you do, In the time that you invest, Remember as a Cub Scout you will always DO YOUR BEST! All: YEAH CUB SCOUTS!!!!

PAINTED TIGER CUB GRADUATION

Equipment: Orange paint, yellow neckerchief (already rolled), neckerchief slide

Cubmaster: Would the following Tiger Cubs and their parents please come forward? (Reads the names of Tiger Cubs.) For the past few months, you and your family have explored new and exciting things and places. You have taken each part of the Tiger Cub motto "Search, discover, share" and have used it in your home, school and neighborhood. You and your adult partner have discovered that by doing things with family and friends, you are a part of a family, community and country.

(Draw an open hand on left cheek.) The things you have shared with others let them learn about you and the things you saw and did. Remember, in Cub Scouting, your family is important; Support in earning each badge comes from your family as well as your den leader. Your parents will help you each step of the way. I would like to welcome you to our pack with this Wolf neckerchief.

(Tiger Cub den leader places neckerchief around boy's neck and presents a slide to the parents. Parent places slide on neckerchief. Cubmaster follows and shakes hands with each boy and parent.) Let's give them a big "round of applause" (or other appropriate applause) and welcome them into the pack.



Webelos

Webelos Scouts are the oldest and usually the most experienced scouts in the pack. The name Webelos always ends with an S whether we are talking about a single Webelos Scout or a den of Webelos Scouts. It's an acronym that means "We'll be Loyal Scouts. It's been said that without the S there is nothing to be loyal to.

As a Webleos Scout the boys work towards earning their Webelos badge then their Arrow of Light (The highest award given in Cub Scouting) Along the way they have 20 different badges to earn. Here we have included some activities to help them earn the various Webelos Activity badges.

BRAND NEW WEBELOS SECTION - with ideas to help Webelos leaders with all 20 of the Webelos Activity Badges on this Aug. 2011 CD. Includes field trip ideas and themed neckerchief slides.

WELCOME TO WEBELOS

REMEMBER TO PLAN

One of the most important things about being a Webelos Leader is planning. **You will find that the Webelos and Arrow of Light years (and your den meeting plans) require more long-term planning on your part.** Your focus is helping the boys fulfill the requirements and earn activity badges (yes, they look like pins but they are referred to as badges), to prepare them to receive the Arrow of Light Award and transition into Boys Scouts.

The Webelos and Arrow of Light section of the *Den and Pack Meeting Resource Guide* and the *Webelos Leader Guide* will take you and your boys through the achievement activities required for rank advancement. You will find that looking ahead in these resources as well as using the following pages that also contain ideas you can use to make fulfilling activity badge requirements fun and interesting. The ideas for activities to help teach the Webelos Activity badges on the following pages are in the same order that they appear in the Webelos Scout Book (alphabetical).

In addition to the ideas in this Pow Wow Book, there are many other sources that can help you as you plan your Webelos den meetings. Here are a few suggestions:

- Cub Scout Fast Start Training (www.myscouting.org)
- Cub Scout Leader Specific Training (www.myscouting.org)
- This is Scouting (www.myscouting.org)
- Youth Protection (www.myscouting.org)
- Monthly Roundtable Meetings
- Pow Wows and other special events
- *Cub Scout Leader How-To Book*
- Cub Scout Academics and Sports Program
- Troop Webelos resource person (Cub Scout Leader Book page 65)
- Cubcast (www.scouting.org/ScoutCast)
- Craft and family Magazines
- *Boys' Life* magazine
- Special interest library books
- Internet sites - Do not limit yourself to Cub Scout sites. Try using a topical search.
- Parents and grandparents with special skills

In short, just keep your eyes open. The world is full of fascinating things to learn and do. When you become familiar with the activity badges, you will begin seeing things that apply to those badges all around you.

KEEP GOOD RECORDS

There is a brand new section with lots of ideas for keeping records on this Aug 2011 CD

Do not rely on the books the boys carry as your record of what they have earned. You need to keep a current record for each boy as he completes each requirement. This is in addition to signing the book so that the parents can have access to the progress of their son.

Every leader has his or her favorite record keeping method. Some use charts (one for each boy), which can be obtained through a variety of sources. Some use computer programs, which can be downloaded from a number of internet sites. BSA has the Webelos Scout Den Advancement Chart and the Den Advancement Reports available to help with record keeping. Included is a sample Webelos Individual Record. What is important is that you find a method and use it consistently. Keeping track as you go is much easier than trying to sit down once a month and trying to remember which boy earned which award. That type of record keeping is not accurate and is a recipe for disaster. The best method of record keeping is the one you will use.

Another type of record you want to **keep is a record of the activities you do for each badge.** If you serve as Webelos Den Leader for any length of time, you will return to each badge and repeat it with a new crop of boys. Creating an accurate record of the activities you have done gives you a quick reference when it is time to repeat the badge. Using the Webelos Den Meeting Planning Sheet – download from (www.scouting.org/scoutsource/CubScouts/Leaders/Forms) will help with this record keeping as well as following the Den Meeting programs outlined in the *Den and Pack Meeting Resource Guide*. This makes your second year as a Webelos Den Leader a breeze.

You might want to make a file folder for each badge. That will give you a place to file your old planning sheets and items you may have created to enhance the requirements. You will be glad you took the time to do this when you start on that badge again and find the work is almost done.

DOUBLE TAKES

“Double Takes” are activities that can fulfill more than one requirement for different activity badges. Look for these and take advantage of them when you can. If you can fulfill 2 requirements at the same time or with just a little more work – why not. There are some double takes listed on the next few pages with each Webelos activity badge activity. There is also an additional 7 page “Double Takes” at the end of the Webelos Section in this Pow Wow Book that lists multiple double takes for most every Webelos Activity Badge as well as some for the LDS Faith in God program.

Belt loops can also serve double duty by earning them a belt loop while working on an activity badge. See the Academics and Sports Program section of this Pow Wow Book for a listing of how to work on activity badges while earning belt loops too.



AQUANAUT

THROW

Aquanaut Requirement 5 — Demonstrate Reach and Throw.

ITEMS YOU WILL NEED:

- 30-40 foot of rope
- Empty milk jug
- Hula hoop or a length of rope to make a “target”
- Marker for each boy with his name on it. (You could use popsicle sticks with their name on it.)

- Tie the rope to the milk jug. Place the target about 20 feet from where the boys will be standing.
- Have the boys practice throwing the jug into the target area. Let them mark the spot where they threw the jug with their marker. The idea is to get the closest to the target. In a rescue, accuracy is more important than distance.

SWIMMING BELT LOOP

Aquanaut Requirement 8 —

If you have done the Aquanaut before you may need to make some adjustments to the changes in the requirements. The requirements for the Swimming belt loop changed a few years ago and are much more friendly to timid swimmers. You may want to consider doing this requirement so that your non-swimmers will still be able to earn something during this activity.

PFD RELAY

Aquanaut Requirement 3 — If you have enough boys you can turn this activity into a relay.

ITEMS YOU WILL NEED:

- PFD (personal flotation device) for each team
- Stopwatch (optional)

- Divide the boys into two equal teams. Have them complete the relay as described in the Webelos Scout Book, Requirement 3 on page 84. Even groups with non-swimmers will be able to do this. The only concern might be if a boy has a genuine fear of water.
- If your group is small you can challenge the boys by timing the group as they complete the relay. Have them repeat the process and try to beat their previous time. Or you could have them guess how long it will take and then have them complete the relay and check the actual time against their guess.

ARTIST

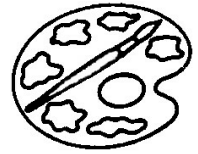

EASY SCRAPBOOK COVER

Artist Requirement 2 — Create a scrapbook. This will not likely become a long-term keepsake, so keep it simple and inexpensive.

ITEMS YOU WILL NEED:

- ___ Inexpensive report folder (Folders with a clear front cover create an automatic display area)
- ___ Markers, stickers, etc.

- If it is an all-paper folder let the boys use the markers, stickers and other art supplies to decorate the outside of the folder. If it is a folder with a clear front, let them put their favorite art project from this badge in the first position. Nothing could be easier than that!

HOPPING BUNNY

Artist Requirement 9 — Make an art construction using your choice of materials. Origami is the art of paper folding. This is a popular art form in eastern Asian countries like Japan. There are many resources for ideas for origami. The library has books you can use or try searching the internet. There are societies that are dedicated to this art form that sponsor web sites. Some of the projects can get quite complicated so be careful to choose an easy project.

ITEMS YOU WILL NEED:

- ___ 3x5 unlined index card for each boy

- Place the card in front of you with long sides left and right and the short sides top and bottom.
- Fold the short top edge down to meet the long left edge. Try to align the edges very carefully and get a nice sharp point at the tip. Run your finger along the folded edge several times to form a triangular flap. Unfold the flap and repeat with the other side. You will see that the creases form an “x”.
- Turn the card over. You’ll see the letter “x”. Put a crease right through the center of the “x” by folding the top edge down to the bottom of the “x” where the creases end. (DON’T fold it all the way down to the bottom of the card.) Make a firm crease. Unfold.
- Turn card over again. Press in the center of the “x”. The sides should gently slope inward. Bring the top edge of the card down to the bottom of the “x” and press to form the shape of a house.
- At the sides of the roof are two loose points. Lift the points to the center, straight up into the air. Now take the sides - first left then right - and bring them to the center, making a crease on each side. Now fold down those arms and you should have something that looks like an arrow.
- Turn the arrow over. Fold the bottom edge to almost to the top of the arrow, leaving a tiny triangle showing. Make a gentle crease. Bring the same edge back down to meet the crease you just made and make another gentle crease.
- Turn your bunny over. Those loose “arms” are now his ears. Lift them straight up. Place your finger on the folded edge behind his ears and push down. Release your finger and watch him hop!
- Let the boys have bunny races or hopping contests.

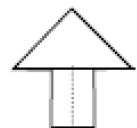
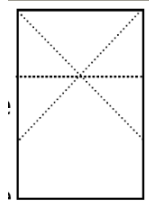

ARTIST ACTIVITY BADGE – Continued

CARDBOARD FRAMES

Artist Requirement 3 (partial) — Frame a picture you have created.

DOUBLE TAKE: Craftsman Requirement 3 — Make a frame.

ITEMS YOU WILL NEED:

___ Heavy cardboard cut to the appearance of a frame. Make the frame a size that will fit the original art project that will go in the frame. Make the sides of the frame at least 2" wide. You may want to give them a base coat of white or you can leave them the natural brown color.

- ___ Red, yellow and blue paint
- ___ Paint brush for each boy
- ___ Popsicle sticks for stirring paint
- ___ Large disposable plate for each boy
- ___ Paper or plastic to cover the work surface
- ___ Plastic lacing
- ___ Large nail
- ___ Scissors
- ___ Masking tape

- You may want to make a protective covering for the boys' clothing by using a large garbage bag
- Give each boy a plate with some red, yellow and blue paint. Explain that these are primary colors and that other colors can be made from these three colors.
- Let the boys mix the colors to make their own original colors. Don't let them stir up all the colors on the plate.
- Using the primary colors and the new colors you have created, paint the cardboard frames. You can get creative here. Use sponges or stencils or any paint technique you think the boys will enjoy.
- When dry, punch two holes in the top of the frame with the large nail. Push the ends of a piece of lacing through each hole and make a knot.
- Fasten your original art on the back of the frame with masking tape. Hang the frame by the plastic lacing.

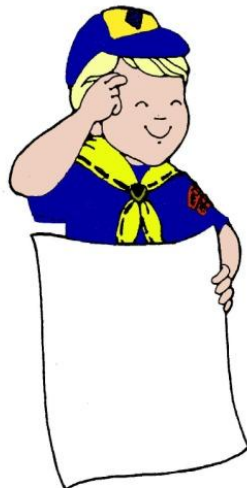

CITIZEN



RIGHTS AND DUTIES GAME

Citizen Requirement 7

ITEMS YOU WILL NEED:

- ___ Word strips that list the rights and duties of a citizen (see Webelos Handbook pg. 155 for examples)
- ___ Two larger word strips. One that says "RIGHTS" and one that says "DUTIES"
- ___ Sticky Tac or masking tape
- ___ Starburst and Fruit-by-the-Foot (opt.)
 - Display the large word strips on the wall side-by-side. Briefly discuss the difference between a "right" and a "duty".
 - Place the other word strips on the floor or a table, face down.
 - Have the boys draw a word strip from the pile. The boys must then decide if the item listed on the word strip is a "right" or a "duty" and place it under the appropriate large word strip. If the item drawn is BOTH a right and a duty (like voting), they should place it between both columns. If the boy is incorrect, return the word strip to the pile and mix it up a bit.
 - Notes: You can divide the boys into two teams and have them work as a group. You could also keep score if you wish. Award the winners "stars" (Starburst candy) and the others will get "stripes" (fruit by the foot).

FOUR ACROSS GAME

Citizen Requirement 5 and Review 4, 7

ITEMS YOU WILL NEED:

- ___ Game board (see sample below)
- ___ 10 each of 2 different game markers
- ___ Question list (attached)
 - Go over the information in requirements 4, 5 and 7. Tell the boys that they will need this information to play a game.
 - Display game board before the group and explain how to play the game. Play the game as directed below. Give prizes if desired. HOW TO PLAY FOUR ACROSS The object of the game is to be the first team to have four markers in a straight line (horizontally, vertically or diagonally).
 - Give each team a set of markers (i.e. you can use red circles and blue squares)
 - Allow the red team to choose a numbered square they want to capture. Read the question with the corresponding number from the question sheet. If the team answers correctly, then they can place their marker on that number. If they are incorrect, then the blue team takes a turn. If they wish, they can choose the same number.
 - Continue taking turns until one team has four markers in a row.

CITIZEN ACTIVITY BADGE - Continued

1	2	3	4
5	6	7	8
9	10	11	12
13	14	15	16

CITIZEN QUESTIONS FOR THE FOUR ACROSS GAME

1. What does "I pledge allegiance" mean? (I promise to be true or loyal)
2. What does "to the flag" mean? (To the sign of our country)
3. What does "of the United States of America" mean? (Our country of 50 states)
4. What does "to the Republic" mean? (A country where people elect their fellow citizens to make laws)
5. What does "for which it stands" mean? (The flag is a symbol of the country)
6. What does "one nation under God" mean? (A single country whose people believe in religious freedom)
7. What does "indivisible" mean? (Cannot be divided)
8. What does "with liberty and justice" mean? (With freedom and fairness)
9. What does "for all" mean? (For every person)
10. How can we help the police? (Lock your house and cars and bikes. Report crimes or suspicious things to police)
11. Name two of your rights as a citizen. (Worship, freedom of speech, right to assemble, own property, choose where to live, go to school, vote, have a trial by jury, no unlawful search of your home, etc...)
12. Name two of your duties as a citizen. (Obey the law, respect the rights and properties of others, help the police, be informed, vote, pay taxes, serve on a jury, help things that are not good)
13. Name two ways to save our resources. (Clean up trash, plant trees, save water and energy)
14. Name a day that you should fly the flag. (see page 164 in Webelos book)
15. Show the proper way to salute the flag when you wear your uniform (Cub Scout sign at brow)
16. Show the proper way to salute the flag when you are in your regular clothes. (Right hand over heart.)

COMMUNICATOR



CAVE WRITINGS

Communicator Requirement 3

ITEMS YOU WILL NEED:

- ___ 3 ft. pieces of craft paper or blank newsprint
- ___ Markers or crayons
- ___ Masking tape or Sticky Tac
- ___ Flashlight

- Explain to the boys that explorers sometimes find writings on the walls of caves and on rocks that were made by people who lived long ago. These writings are frequently pictures that tell a story.

(Sometimes I show a clip from the "Prince of Egypt" where Moses discovers the truth of his past by seeing the story on a wall).

- Give each boy a strip of paper and some markers. Instruct them to draw a story using pictures. No talking during this part of the activity.
- As each boy finishes, take their picture and hang it in a darkened room. Send that boy to play a game or some other activity.
- When all the boys are finished tell them that they are going exploring. Take them to the dark room with the pictures. Walk around the room using only the flashlight for illumination. When you come to a picture try to have the boys guess what the story is about (the boy whose picture is being featured should remain silent). After a few guesses, ask if there is an "expert" who might be able to interpret this picture. Have the boy who drew the picture be the "expert" and tell the group the meaning of his drawing.

DOUBLE TAKE: In addition to Communicator Req. 3, the above activity could also count for Artist Req. 9 (an art construction of your choice)



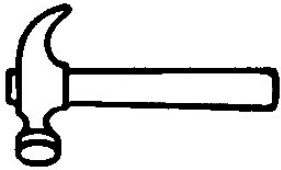

CRAFTSMAN

SNOWMAN SLIDE

Craftsman Requirement 4 (1 of 4)

ITEMS YOU WILL NEED FOR EACH SLIDE:

- One 1 1/2" pom pom
- One 1" pom pom
- Small bit of orange chenille stem
- 3mm brown chenille stem
- Two 4 mm black beads
- Three 6 mm black beads
- 6" piece of 1/4" ribbon
- Tacky glue or low temp hot glue
- Small piece of tubing, PVC or chenille stem for loop back



- Glue pom poms together
- Use the small beads for the eyes of the snowman. Glue these to the smaller pom pom.
- Put a bit of glue onto the tip of the orange chenille stem and press it into the pom pom for the nose.
- Glue the 6 mm beads to the body for the "buttons." Wrap the ribbon around the neck and glue into place for a scarf.
- Use the small brown chenille stem to form "stick arms". Glue into place just like you did the nose.
- Glue the PVC or tubing to the back of the snowman. Let dry if needed.

RING TOSS GAME

Craftsman Requirement 2, (partial)

For each boy you will need:

- Two 12" squares 1/2" MDF or plywood
- Two 3" squares 1/2" MDF or plywood
- 12" length of 1" dowel or broomstick
- Wood screw
- Paint or stain
- Wood glue
- Sandpaper

- Prepare 12" square by cutting to size and drilling a pilot hole in the center. Since the boys need to use a hand saw for this badge you may want to cut the MDF into a 12" strip, mark it off at 12" intervals and then mark and drill the holes.
- Prepare 3" square by drilling a 1" hole in the center that the dowel will fit in snugly.
- Prepare the dowel by drilling a pilot hole in the center of one end.
- Allow the boys to cut the 12" square, using a handsaw.
- Have the boys sand all the pieces.

CRAFTSMAN – Ring Toss – Continued

- Press the dowel into the 3” square (be sure to use the end with the pilot hole). Make sure the end of the dowel is flush with the bottom of the MDF. Put a small amount of glue on the bottom of the MDF.
- Align the pilot holes on the dowel and the 12” square and fasten together with the wood screw. Make sure the dowel is firmly against the 12” square. Wipe away any excess glue that may have squished out from under the 3” square.
- Finish with paint or stain.
- Repeat the process for the other ring toss peg.
- “Rings” can be made by attaching the ends of 12 inches of stiff nylon rope with electrical tape to form a circle.

TIN PUNCH ORNAMENTS

Craftsman Requirement 4 (1 of 4 parts)

DOUBLE TAKE: Citizen Requirement 8 (do a good turn)

Make several of these ornaments. Use them to decorate a tree for a nursing home, or other needy person or group. (Plan ahead if you are going to ask for the corporate donation of a tree.)

ITEMS YOU WILL NEED:

- ___ Lids from frozen juice concentrate cans
- ___ 6” of ribbon or braid for each lid
- ___ 10” of pre-gathered lace per lid
- ___ Scissors
- ___ Low temp hot glue gun
- ___ Hammer (have each boy bring one from home)
- ___ Piece of scrap wood for each boy
- ___ Masking Tape
- ___ Paneling or finish nails
- ___ Tin punch patterns (on next page)

- Remove any ink from the lid by using a small amount of nail polish remover and a cotton ball. Let dry. (Do this in advance at home.)
- Select the pattern you wish to use.
- Attach the pattern to the gray side of the lid using small bit of masking tape, being careful not to cover any of the pattern dots.
- Place the lid with the pattern on the scrap wood. Using the hammer and nail, punch a hole through every dot. It only takes 2-3 strikes per hole. Hammer just until the lid is pierced. Try not to hammer the nail into the wood.
- When you think all the holes are finished, turn the lid over and check for any holes you may have missed or punched incompletely.
- When you are satisfied that all the holes have been punched, remove the pattern and tape.
- Bring the ends of the ribbon or braid together to form a teardrop-shaped loop. Place a small mound of hot glue on the top, center back of the ornament and push the ends into the glue. Hold a few seconds until cool.

CRAFTSMAN – Tin Punch Ornaments – Continued

- Beginning at the ribbon, begin attaching the lace around the back of the ornament with hot glue. Glue in small sections, attaching the lace as you go. HINT: Do not stretch the lace as you go or the lace will have a tendency to “cup” when finished. It is really best to push the lace toward the already glued area as you are attaching it to the ornament. Overlap the ends of the lace as you finish the ornament. Trim as needed.

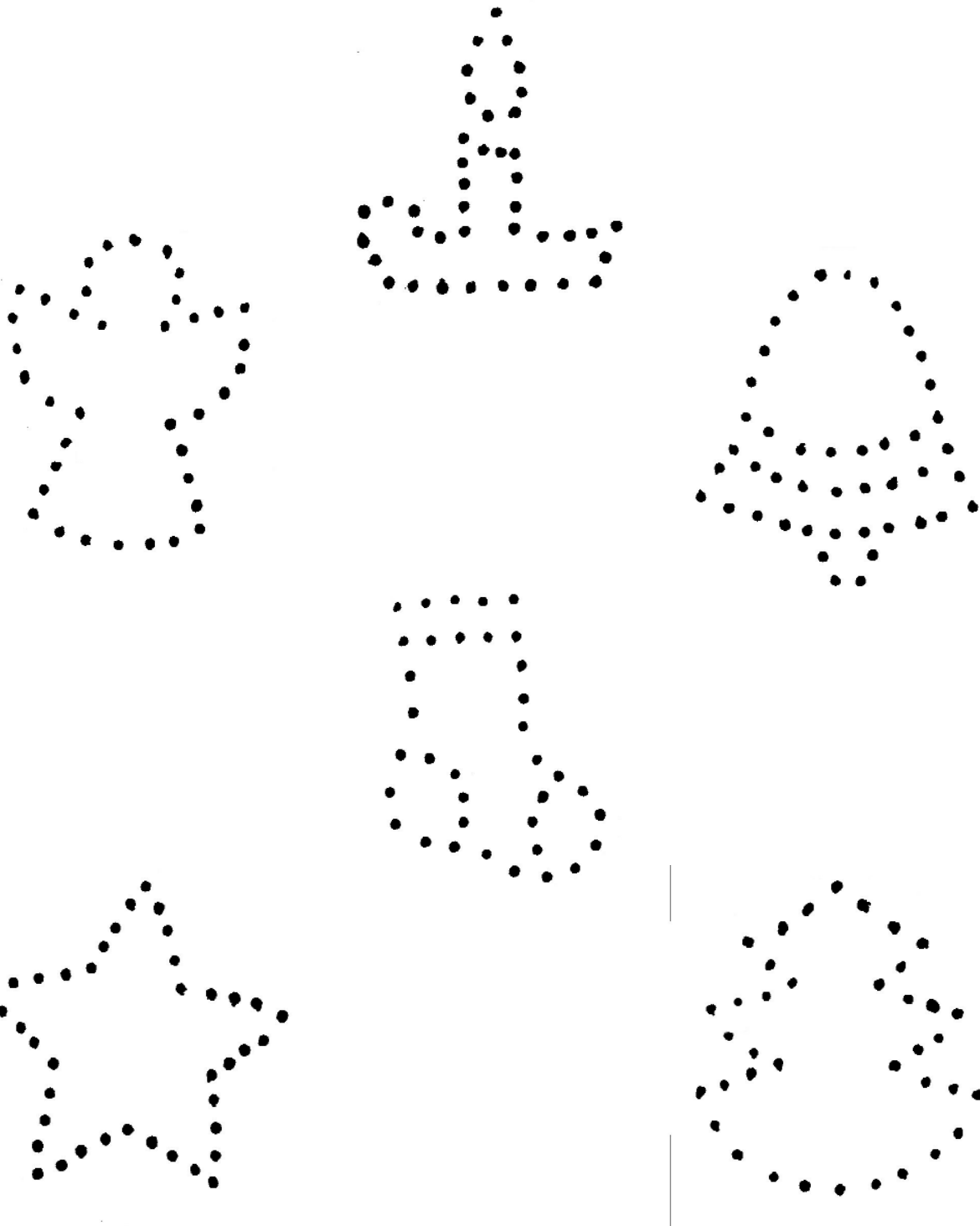

ENGINEER

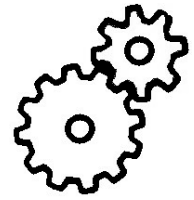

GUMDROP BRIDGES

Engineer Requirement 7 (partial)

ITEMS YOU WILL NEED:

- Several gum drops for each boy (or you can use "Dots")
- Round toothpicks
- Strips of poster board, abt. 1 1/4" wide
- Drop cloth or paper
- Small cars (Hot Wheels), optional

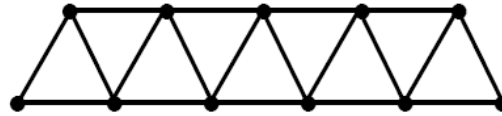

- You can do this badge on the floor or on a table. Just be sure to cover the table or floor. Regular gum drops have large sugar crystals that fall off when handled. If a gumdrop gets stepped on, then you will be very glad that you have taken the time to protect your surface.
- Give each boy several gum drops and some round toothpicks. Use the gum drops and toothpicks to make a Truss Bridge. This is the type of bridge that is made of triangles. Make the triangles by poking the toothpicks into the gum drops. Construct two identical sides like the illustration below (you can make it a bit shorter if you wish). The dots represent gum drops and the lines are the toothpicks.
- Attach the sides with toothpicks to form a bridge.
- Lay strip of poster board along the bottom row of toothpicks to make the road.
- Have the boys place their bridge between two objects (wooden blocks, tables, folding chairs), and drive a car over the bridge.
- Let the boys take home their bridges and eat them. They love this part!

ELECTRIC CIRCUIT TOY

Engineer Requirement 6

DOUBLE TAKE: Craftsman Requirement 4 (partial.)

Don't let the lengthy directions discourage you. The boys LOVE this project and it is worth it!

ITEMS YOU WILL NEED FOR EACH BOY:

- 12" piece of 2x4 (go to the scrap bin at the cutting table at your local lumber yard for free wood)
- 36" bare copper wire (I stripped mine out of the wiring you use in your house —14-2 with a ground. One piece will yield 3 usable pieces of bare copper wire)
- 8" bare copper wire (see notes above)
- 15" of 18 ga. multi-strand wire
- 9 Volt battery snap connector (you can get these at Radio Shack in a package of 5 for \$1.99. Be sure to get the ones with the longest tails, stock number 270-324.) You may need to strip additional insulation from the ends of these wires.
- 12 volt DC Lamp Assembly (you can get these at RS, 2 for \$1.99.) You may need to strip additional insulation from the ends of these wires.
- 6-8 inches of drinking straw
- Two 3/16" screws, 1/2 inch long-- Phillips
- Electrical tape
- Sandpaper (optional)

ENGINEER – Electric Circuit Toy – Continued

- In advance of the meeting, have each boy bring a Phillips head screw driver and a 9-volt battery.
- In advance of the meeting, prepare the following items:

Use needle nose pliers to form a small loop on each end of the 36" bare copper wire.

__ Make the wand by forming the 8" bare copper wire into a 1" circle. The ends should be uneven. Strip the end of the 18 ga. wire and twist it around the end of the copper wire. You can cover this connection with electrical tape or slip the soda straw over your connection. Make sure the Insulation is removed from the bottom 1" of the other end of the 18 ga. wire (see diagram above right)



__ Prepare your board by predrilling holes according to the diagram.

- Give each boy a board and piece of sandpaper and have him sand his board until smooth. This step is optional.
- Give each boy 2 screws, a light assembly, a battery connector, prepared wand, and 36" bare wire with circles in the end.
- Using one screw, have the boy attach the 36" wire to the board at the end farthest from the battery hole.
- Before attaching the second screw, loop the wand over the 36" wire. Wrap the exposed end of the black lead on the battery connector around the loop on the end of the 36" wire. Now attach the other end of the 36" wire with the remaining screw. Be careful not to over-tighten and break the delicate wire on the battery end connector.
- Connect the red lead of the battery connector to ONE of the leads on the light by twisting the bare wires together and then covering the connection with electrical tape.
- Connect the remaining lead on the light to the exposed wire at the end of the wand. Twist and cover with electrical tape.

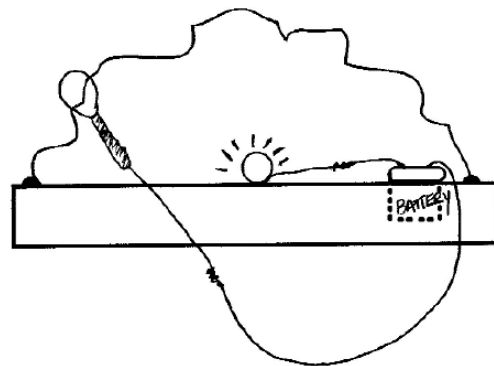
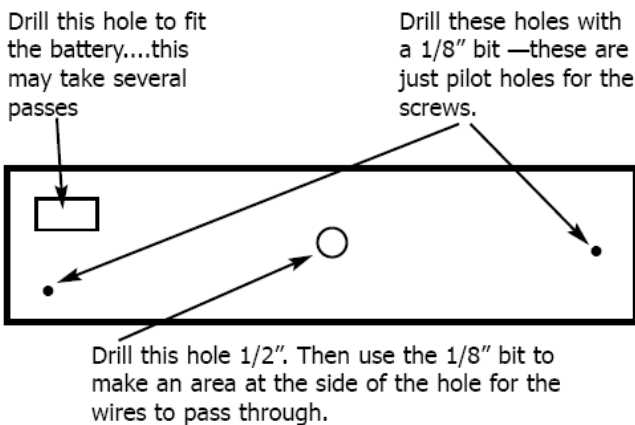

Drill this hole to fit the battery....this may take several passes

Drill these holes with a 1/8" bit —these are just pilot holes for the screws.

Drill this hole 1/2". Then use the 1/8" bit to make an area at the side of the hole for the wires to pass through.

- Push the light into the hole you drilled for that purpose. Be sure to guide the wires through the enlarged area at the side of your hole.
- Place the battery into the hole you drilled for that purpose. Connect the battery and play!
- The object of the game is to form the exposed wire into an interesting shape and then try to move the wand from one side to the other without lighting the light.

ENGINEER ACTIVITY BADGE - Continued

CALL IT!

Engineer Requirement 9

You will make the simplest of catapults and then the boys will enjoy playing a game.

ITEMS YOU WILL NEED:

- ___ Bean Bag
- ___ 1" x 2" board, approx. 18-24" long
- ___ 2" x 4" board, approx. 8-12" long
- ___ Outdoor location with lots of room.
 - Go outside into a large open area that is free of obstacles, such as trees, bushes, etc. An empty parking lot works nicely.
 - Lay the 2x4 board on the ground.
 - Lay the 1x2 board across the 2x4 board, forming the letter "t" (see illustration).
 - Place the bean bag at the end of the longer section of the 1x2 board.
 - When the boys stomp on the shorter end of the board the bean bag will go flying.

TO PLAY THE GAME:

Have one boy be the launcher. The remaining boys will stand in an area a short distance from the catapult. As the boy steps on the catapult and launches the bean bag, he calls out the name of one of the other boys. That boy must then try to catch the bean bag before it hits the ground. If he misses, the launcher repeats the process. Once a boy catches the bag, he becomes the new launcher.

Top View

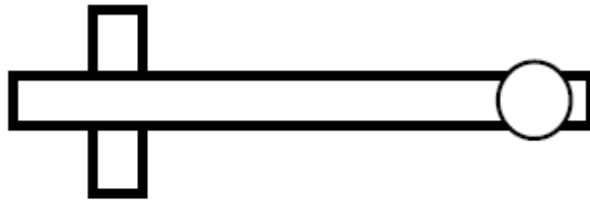

Side View





FITNESS

RANDOM MEALS

Fitness Requirement 3

ITEMS YOU WILL NEED:

- Pictures of various foods (cut from magazines or printed from clip art)
- Brown lunch sack or a lunchbox
- Stick tac or tape.
- Poster board cut to the shape of an over-sized placemat. Draw or paste images of a plate, knife, fork, spoon, and glass onto the placemat. Laminate.
- Handout (Personal Meal Plan sheet from Fitness Packet) for each boy.

- Place the pictures of food items into the lunch sack or box.
- Display the placemat.
- Have the boys take turns reaching into the sack and drawing out the food items. Allow the boys to place the food items on the placemat to create a sample meal. Only draw 5-6 items per meal. This will likely be a pretty silly meal.
- Ask the boys to evaluate the meal. Tell what is wrong or right with it.
- Have the boys write a better version of the meal on their handout.
- You can repeat this process two or three times. That will get the boys started on their seven days of meal planning. They can then take the paper home and finish it with a parent or other family member as the badge requires.

The Fitness Badge cannot be completed in den meetings because five of the requirements contain the words “tell an adult family member” (this translates to work that must be done at home with parents). Because of this, I do not do this badge in den meetings. I have prepared a packet of info that I send home with each boy to help him complete this badge at home. My experience is that every boy to whom I have given this packet completes the Fitness Badge. Following are the parts of the packet so you can make copies if you like.

Note to Leaders —How to Build the Fitness Packet

At the Copy Shop:

- Copy the “Get Off to a Great Start” sheet onto 11x17 cardstock with the image to the far right hand side of the paper
- Copy the “Personal Meal Plan” and the “Evaluating Your Food Choices” sheets onto white paper
- Copy the “Record of Meals” onto a bright yellow cardstock.

At the Scout Office:

- Purchase the booklet Take a Stand Against Drugs!

At Home:

- Fold the “Get off to a Great Start” sheet in half, with the words on the outside front cover
- Glue small magnets to the back four corners of the “Record of Meals” sheet. You can buy these magnets in a strip (at craft stores) and cut them into small pieces with scissors.
- Place the Personal Meal Plan, Record of Meals, Evaluation and drug booklet into the folded 11x17 sheet

Get off to a great Start!

Earn the Fitness Badge in the first month — You Can Do It!

Parents ---

This packet is provided to help your son get the best possible start in Webelos. The Fitness Badge must be done at home and is a badge that is required for both the Webelos rank and the Arrow of Light award. It is not a difficult badge, but will require your assistance. Plan to do this badge during the first month. There won't be an easier time. It is simple -- all you have to do is:

- Review the requirements. You **MUST** do all three parts of Requirement #1 and then choose the six others you want to do. Helps are provided in the packet.
- When each item is complete, sign in the blank provided below. Do not write in the book.
- When you have signed six places, have your son bring the entire packet to his den leaders.
- They will review the packet and sign his book.
- He will receive his Fitness Badge at the next pack meeting!

You must do all three parts of this requirement:

- 1a. **KNOW:** Tell why it is important to be healthy, clean and fit.
- 1b. **COMMIT:** Tell when it is difficult for you to stick with good health habits. Tell where you can go to be with others who encourage you to be healthy, clean and fit.
- 1c. **PRACTICE:** Practice good health habits while doing the requirements for this activity badge.



Assist Your Son To Do Six of These:

- 2. With a parent or other adult family member, complete a safety notebook which is discussed in the booklet "How to Protect Your Children from Child Abuse" (p. 22) that comes with the Webelos Scout Book.
- 3. Read the meal planning information in this chapter. With a parent or other family member, plan a week of meals. Explain what kinds of meals are best for you and why. A sheet is provided to make your plan (see Webelos Scout Book, p. 248-255).
- 4. Keep a record of your daily meals and snacks for a week. Decide whether you have been eating foods that are good for you (see packet for helps).
- 5. Tell an adult member of your family about the bad effects smoking or chewing tobacco would have on your body (see Webelos Scout Book, p. 256).
- 6. Tell an adult member of your family four reasons why you should not use alcohol and how it could affect you (see Webelos Scout Book, p. 257).
- 7. Tell an adult member of your family what drugs could do to your body and how they would affect your ability to think clearly (see Webelos Scout Book, pages 257-258).
- 8. Read the booklet *Take a Stand Against Drugs*. Discuss it with an adult and show that you understand the material. This booklet is provided in this packet.

Sign When Complete

- 1a _____
- 1b _____
- 1c _____
- 2 _____
- 3 _____
- 4 _____
- 5 _____
- 6 _____
- 7 _____
- 8 _____

	Breakfast	Lunch	Supper	Snacks
Monday				
Tuesday				
Wednesday				
Thursday				
Friday				
Saturday				
Sunday				

	Breakfast	Lunch	Supper	Snacks
Day 1				
Day 2				
Day 3				
Day 4				
Day 5				
Day 6				
Day 7				

Evaluating your food choices

This guide is provided to help you evaluate your food choices for requirement #4.

HOW TO USE THIS SHEET

___ Record what you eat for 7 days (these do not have to be consecutive days)

___ Using your food record, fill in a circle for each food you ate

EXAMPLE:

For breakfast one day you ate:

- A bowl of cereal with milk
- A glass of orange juice

Color in:

- One circle in the grain area
- One circle in the dairy area
- One circle in the fruit area

___ Do this for all of your meals.

Does the shape you see look like a pyramid? It might if you begin coloring in the middle of each area and color from the center out in both directions. (To make it more interesting you can use markers or crayons to color each category a different color -- ie, yellow for grains, green for vegetables and fruits, blue for dairy and meat, red for fats and sweets.)

COLOR THIS AREA FOR FATS AND SWEETS

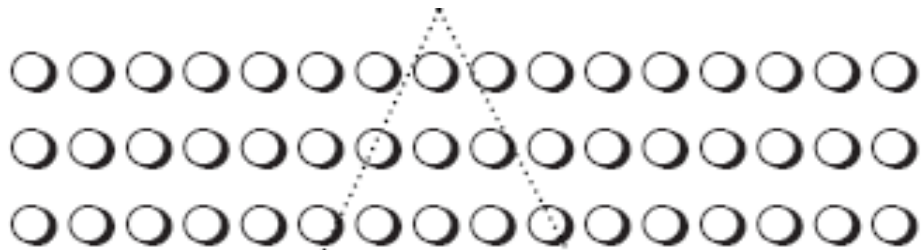

COLOR THIS AREA FOR DAIRY AND MEAT



COLOR THIS AREA FOR FRUITS AND VEGGIES

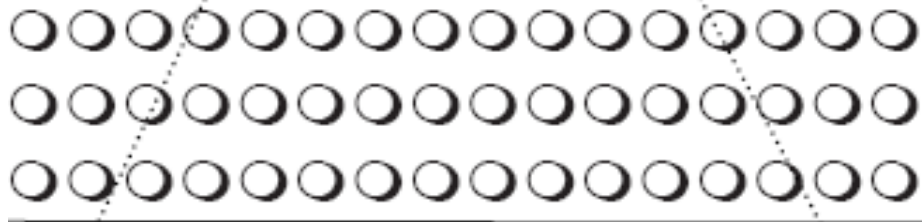

COLOR THIS AREA FOR GRAINS (Bread, cereal, rice, pasta etc...)



FORESTER



PLANT I.D. HIKE

Forester Requirements 3 and 4

DOUBLE TAKE: Arrow of Light Req. 5 (day hike)

First you will need to select a place to hike. Hike prior to taking the boys to be sure you will see the required trees and plants. Note which trees and plants you see. You should be cautious in taking samples of leaves since this is prohibited on government land and violates the spirit of "leave no trace".

ITEMS YOU WILL NEED:

__ Worksheets that show leaf samples (6 each) of the trees and plants you will encounter on your hike.

__ Pencils or stickers

- When you arrive at the selected hiking site give each boy (or team of boys) a worksheet that shows the plants they need to find as they hike. Challenge them to find all the plants you have shown on the worksheet.
- Have the boys mark their sheets as they locate each specimen.

DETERMINE A TREE'S AGE

Forester Requirement 6

ITEMS YOU WILL NEED

__ Poster paper

__ Markers

__ Cross section of a tree stump

- Show how the age of a tree can be determined from the annual rings.
- Explain why some rings are much wider than others (dry and wet spells). If possible, use a cross-section of a real log rather than a picture.
- Have the boys make a poster of the cross-section of a tree and how the rings tell the life history of the tree.



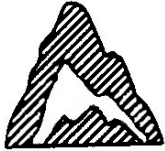

GEOLOGIST

EARTHQUAKE SANDWICHES

Geologist Requirement 6

Items you will need:

- ___ Large paper plate for each boy
- ___ Table knife for each boy (you can use plastic)
- ___ Large, sharp knife for your use
- ___ 2 loaves of bread (one light, one dark)
- ___ Peanut butter
- ___ One or more kinds of jam

- Give each boy a plate, table knife, three pieces of bread (different colors) some peanut butter and some jam. (Remove these from the jar and put them in disposable bowls and let the boys “share”)
- Have each boy make a sandwich by layering bread, peanut butter, bread, jam, bread.
- Using the large knife, cut a “fault line” in each sandwich. Allow the boys to mash their sandwich by pushing from opposite edges.
- Now cross-cut each sandwich to reveal the layers. Discuss the ways that mountains are formed and compare to what you see in your sandwiches.
- Allow the boys to eat their creations if they wish.

GEOLOGIST DISCOVERY

Geologist Requirement 4

Items you will need:

- ___ Paper and pencil for each boy
- ___ Large, brown paper grocery sack
- ___ Several samples of building materials, i.e., nail, screw, wood, sheet rock, concrete, electrical wire, etc.
 - Have the boys take turns drawing an item out of the sack. Discuss whether it is a geologic material or not. If it is, have the boys write it on their lists. Continue until all the items have been used. (Remember, plastic is made from petroleum and would be considered a geologic material).

HANDYMAN



BIKE CLINIC AND RODEO

Handyman Requirements 6, 7 & 8

ITEMS YOU WILL NEED:

- Bike tire pump
- Chain lubricant or can of oil
- Wrenches and screwdrivers
- Sidewalk chalk
- 2 Stop watches
- Four "cones" or other barriers
- Scorecard and pen for each event.

NOTE: You will need to be sure each boy has access to a bike and a bike helmet for this activity.

- Prior to the rodeo have each boy perform the tasks outlined in Handyman Requirements 6, 7 and 8. Organize this effort any way you like. We divide the boys into three groups and have the groups move to three areas: one for inflating tires, one for tightening and lubing the chain and one for adjusting the seat and/or handlebars. You can get a dad or someone who is handy with bikes to help you with this part of the activity.
- After everyone has completed the three requirements, we do the following activities for our "bike rodeo". This doesn't fill a requirement, it is just for fun! We usually do this in the back of the church parking lot. (More Bike Rodeo ideas see the "Derbies" section of this Pow Wow Book.)

HOW SLOW CAN YOU GO?

Mark two lines several feet apart. Have each boy begin at one line and ride toward the other line as slowly as he can without putting down his foot. Time him with a stop watch. Record his time. The boy that goes the slowest wins!

HOW FAR CAN YOU GO?

Mark two lines several feet apart. Have the boy begin pedaling as fast as he can at the first line. He should pedal as hard as he can until he reaches the second line. When he reaches the second line, he stops pedaling and begins coasting. Allow him to coast until he has to touch the ground to maintain balance. Mark the spot where his foot touched with sidewalk chalk and write his name beside the mark. The boy who goes the farthest wins!

HOW FAST CAN YOU GO?

This is just a standard-type obstacle course with about four cones. The boy that completes the course in the quickest time without touching the ground or the cones wins. Add penalty seconds for boys who touch the ground or knock into cones.

DOUBLE TAKE- Handyman Requirement 2 Webelos Requirement e (partial)

You could practice your car washing skills on neighbors. That might include single women or older or disabled people in your neighborhood. This would be a free service to satisfy one of your religious act of service requirements for the Webelos rank. This same concept could also apply **to Handyman Requirement 13** (lawn care).



NATURALIST

BACKYARD BIRD FEEDER

Naturalist Requirement 5

Items you will need:

- Copy of bird watching booklet for each boy
- Backyard bird feeder

DOUBLE TAKE: This is not a true double take, but it does assist in making the requirement more fun and interesting. In addition to helping with the Naturalist Req. 5 it helps with Craftsman Req. 4 (one of the four useful, non-wood items)

ITEMS YOU WILL NEED:

- Plastic gallon jug with screw on lid, clean and dry
- Small washer
- 3 ft. of string
- 1 ft. of 1/4" wooden dowel
- Scissors
- Permanent markers (optional)
- Drill
- Utility knife

- Using the point of the scissors punch two holes on the opposite sides of the jug. Place the holes 1 to 1 1/2 inches from the bottom of the jug. Make the holes a bit smaller than the dowel so that the dowel will fit snugly when you push it through.
- Draw a pattern for the larger opening. Center the opening over the smaller hole where the dowel will be sticking out. Make sure the large opening is at least 1/4" above the small hole for the dowel. Make the large opening any shape you like, but shapes with straight sides are easiest.
- Using the utility knife slash an "X" in the center of the drawing of your large opening. Now you can use the scissors to cut out the complete opening.
- Push the dowel rod through the small holes and make sure it protrudes equally on each side.
- Remove the lid from the jug. Drill a small hole in the center of the lid of the jug.
- Thread one end of the string through the hole in the lid.
- Tie the washer to the end of the string, then pull the string so the washer is on the inside of the lid. Screw the lid onto the jug.
- If desired, decorate the feeder with markers or paints.
- Hang your bird feeder in a tree where you can easily observe the activity of your bird diners. Fill with birdseed or cracked corn.
- For seven days write down what you see. Use your bird watching book.

TO MAKE THE BIRD WATCHING BOOK:

- Copy the following sheets on both sides of a single piece of paper. Using a bright color of paper makes it easier to keep track of the booklet. One copy makes one complete booklet.
- Cut the copies to 5 1/2" x 8 1/2".
- Align cut copies to form the booklet, with the cover on the front.
- Fold to 4 1/4" x 5 1/2".
- Remove inside sheet and place small amount of glue on folded edge. Re-insert into outside section of book and align. Press to seal.

NATURALIST – Continued

ECOSYSTEM MATCH GAME

Naturalist Requirement 9

ITEMS YOU WILL NEED:

___ Pictures of things from nature (Cut these from magazines and laminate them to use next year. Be sure you get pictures that represent each group, i.e., producer, consumer and decomposer)

___ Word strips: Producer, Consumer, and Decomposer

___ Tape or sticky tac

- Display each word strip and briefly discuss the information beginning on page 338 in the Webelos Scout Book.
- Allow the boys to take turns selecting one of the pictures you provided and have them place it under the correct heading. Correct any misconceptions as you go.

2-LITER BOTTLE TERRARIUM

Naturalist Requirement 3

ITEMS YOU WILL NEED:

___ Plastic 2 liter soda pop bottle with cap

___ Very sharp scissors or craft knife

___ Dirt or potting soil

___ Seeds

___ Water

HOW TO MAKE IT:

- Remove the label from the bottle. Discard label. Save cap! (See photo.)
- Wash and rinse out the bottle and cap.
- Cut the bottle close to the bottom. There may be a "line" near the end of where the label was, that's a good place to cut. You can cut it higher if you wish.
- Lightly place dirt or potting soil in the base.
- Plant a few seeds in the dirt.
- Lightly water.
- Put the cap on the bottle.
- Cover the base with the top of the bottle. You will have to fiddle with it a bit to fit back inside the base. (See photo.)
- Place in a sunny spot and watch for your seeds to grow.
-





OUTDOORSMAN

KNOT TYING RACE

Outdoorsman Requirement 2 & 11

This game can be done as part of your evening campfire activity and is a great knot tying review.

ITEMS YOU WILL NEED:

__ Rope and dowel or PVC for each boy

__ Determine and mark start and finish lines.

- Have the boys line up side by side and have their dad stand behind them. Give each team one piece of rope and a dowel.
- Call out the name of a knot.
- The boys begin tying the knot. Their dad can help them.
- As soon as he finishes the knot, he should shout “one” and raise his hand holding up one finger. The other boys continue to try to tie the knot. When each boy finishes he calls out the next number (i.e., 2, 3, 4, etc.) and hold up that many fingers.
- When all the boys have finished their knot, quickly check to see if it is done correctly.
- Each boy that correctly tied the knot takes one step forward. The first boy to tie the knot correctly takes two steps forward.
- The first father/son team to get to the finish line wins!

NO-BURN FOIL DINNER

Outdoorsman Requirement 8

Foil dinners are the staple of outdoor cooking. These are easy to put together and the boys can work on other outdoorsman requirements while they are cooking.

- Spray foil with cooking spray (The new “Release” foil works well).
- Place meat (hamburger patty or boneless chicken breast) in center of foil. Add vegetables as desired. Season to taste.
- Tightly seal foil packet.
- Wet 4-6 layers of newspaper. Wrap foil dinner in wet paper.
- Wrap entire package in additional heavy duty foil. Write your name on packet with permanent marker. Now the dinner will cook without burned spots. Yummy!
- Place dinner directly on hot coals (no flame). Turn after 20 to 30 minutes. Cook until meat is done and veggies are tender (an additional 20 minutes or so).



READYMAN

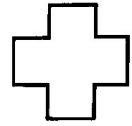

COURAGE - CHARACTER CONNECTION

Readyman Requirement 1

DOUBLE TAKE: *Doing skits can also count for Showman/Drama Requirement 19.*

YOU WILL NEED:

___ Word strip for each Courage Step

BE STRONG

BE CALM

BE CLEAR

BE CAREFUL

___ Several cards that depict situations that require courage (the boys will turn these into skits).

___ Props that may be needed to do the skits.

- Ask the boys to define “courage”.

Accept any answer they give that is even close to accurate. You will be able to clarify any misconceptions later in the discussion.

- Using the word strips, BRIEFLY discuss each courage step. Begin the discussion by displaying a word strip and asking the boys how being “strong” (calm, clear, or careful) helps us have courage.
- Tell the boys that they will act out a situation that requires courage. You may need to divide the boys into small groups and let them read their situation and plan the skit as a group. Don’t worry if the choices the boys make in their skit are not the best ones. At the end of their skit, ask which of the Steps of Courage were used (i.e. Strong, Calm, Clear, Careful). This will give you an opportunity to correct any less than perfect outcomes. You may have the boys do their skit again, using the suggestions the group has made.
- Do enough skits that every boy gets a chance to participate at least one time. Completing this activity will fulfill all three requirements for the Courage Character Connection.

SAMPLE SITUATIONS:

Use these or make up your own.

- You and a friend are playing with your soccer ball at recess. Another boy comes and takes the ball and won’t give it back. What do you do?
- A friend invites you to go to a movie with him. When you get there you realize that it is not a good movie and you know your mom wouldn’t want you to watch it. What do you do?
- You are wrestling in the house with a friend and you bump into a table and knock the lamp onto the floor. It is cracked, but not broken apart. Your mom isn’t home. What do you do?
- On your way home from school you find a wallet. You look inside. There isn’t a name, but there is over \$100 of cash. What do you do?
- You are riding your bike and you have on your helmet. You meet a friend and he asks you why you always wear that goofy looking thing. What do you do? (see Readyman Req. 10)



SCHOLAR

WHO RUNS THE SCHOOL?

Scholar Requirement 10

ITEMS YOU WILL NEED:

- Wooden blocks or Duplos®
- Labels of the staff positions in a school (these should be removable)
 - Place a label for each staff position on the blocks. You may want to try this out at home first to make sure that it will stand up by itself. Using a different color of block for each layer will make this easier to get back together at the meeting.
 - At the meeting challenge the boys to stack the blocks like the sample on page 399 of their book. (Their example need not be this detailed). Correct any problems they might have with the pyramid. Make the point that it takes more than teachers and a principal to keep a school functioning.

“BEST” WALL REMINDER

Scholar Requirement 1

DOUBLE TAKE: Make a simple frame (Craftsman Req. 3 or 4) to frame the “BEST” steps.

ITEMS YOU WILL NEED:

- Large, sturdy white paper plate
- Markers or paints
- Buttons, beads, stickers, or other trims
- Glue
- Copy of “BEST” Handout for each boy
- Plastic lacing
- Scissors
- Ice pick, nail or small punch

PRIOR TO THE MEETING:

- You may want to cut and remove the center from each paper plate. This will be a 6” circle.
- Copy the “BEST” handout onto white card **AT THE MEETING:**
- Talk to the boys about the “BEST” steps. Encourage them to think of something at school they could improve. Have the boys write their goal in the center blank section of the “BEST” handout.
- Make the paper plate frame by giving each boy the paper plate ring (if you prepared these ahead of time). Allow him to decorate the frame with the items you have brought.
- Make a hanger from 12-15 inches of plastic lacing (or yarn). Using a pick, nail or punch, poke a couple of small holes in the top edge of the paper plate. Thread the lacing through the holes and then tie a knot in each end.
- Glue the “BEST” handout with the goal written on it onto the back of the plate over the opening, making sure all the words are visible on the front and are right side up. Glue or tape into place.
- The boys can take them home and hang them on the wall or a door knob to remind them of their goal. Ask them at the end of the month how they think they did.

SCHOLAR – “BEST” WALL REMINDER - Continued

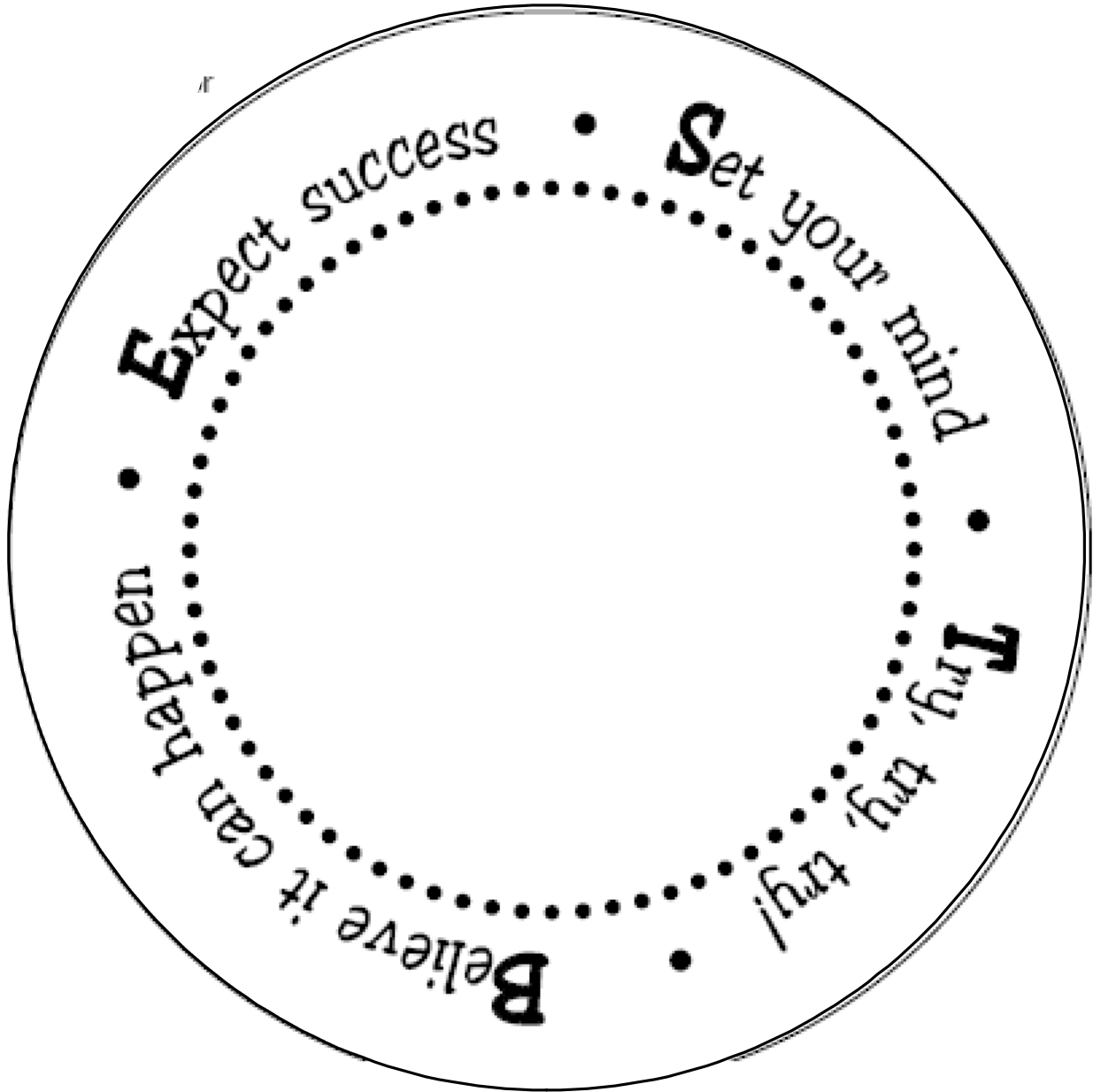

271



SCIENTIST

When you are doing this badge keep in mind that you are “scientists”. Before you do a demonstration or experiment tell the boys what you are doing and have them predict the outcome. Be sure to compare the real outcome to their hypothesis. This is the scientific method in **Science Belt Loop Requirement 1**.

BERNOULLI’S PRINCIPLE

Scientist Requirement 1

#1

ITEMS YOU WILL NEED:

__ 3”x5” pieces of paper

- Fold the 3x5 paper into thirds, along the dotted lines as shown.
- Open the paper and stand it on the table top to form a small “table”. Place the paper table along the edge of a smooth table
- Have the boys kneel and blow in the opening under the table. Observe what happens (the paper table should collapse).

#2

ITEMS YOU WILL NEED:

__ 2”x8” pieces of paper

- Using the short edge, hold the strip of paper on your chin with your index finger. Let the paper drape over your finger and hang down like a goatee.
- Blow straight out and slightly down. Observe what happens (the paper floats straight out).

#3

ITEMS YOU WILL NEED:

__ Straw for each boy

__ Drinking glass or other cylindrical object

__ Box or other square object

__ Pieces of paper cut to 1/2” x 4”

__ Tape

- Tape the narrow end of the paper to the tabletop. Then bend the paper so it is standing upright.
- Let the boys blow on the paper with the straw.
- Now place the square or flat object in front of the paper. Allow the boys (one at a time) to blow on the surface of the flat object and observe that the paper does not move.
- Replace the square object with a glass and allow the boys to blow on the glass. The paper will move. This action demonstrates how the air flows evenly around the glass and comes back together on the other side and moves the paper.

SCIENTIST ACTIVITY BADGE – Continued

TENNIS BALL LAUNCHER

Scientist Requirement 3, (partial)

ITEMS YOU WILL NEED:

- Tennis ball
- Basketball

- "Stack" the tennis ball on top of the basketball. Hold them together and then drop them at the same time, making sure you're out of the way. The tennis ball will shoot straight up; the basketball will stop dead.
- You can do the same thing, with even more impressive results, with a ping pong ball and a large super ball. If the super ball is as large as a tennis ball, place the ping pong ball on top of it and let the two of them go. Don't forget to stand back.

NOTE: You probably want to do this activity outside. You may also want to have more than one set of balls so the boys can give it a try. Just be sure to have the boys stand far apart.

YARDSTICK BREAK

Scientist Requirement 5

ITEMS YOU WILL NEED:

- Yard stick for each boy, plus an extra for demonstration purposes
- Several sheets of newspaper
- Small table

- Lay the yardstick on the table with 5-6 inches hanging over the edge.
- Cover the table with 5-6 sheets of newspaper. Make sure the entire table top is covered and you can only see the part of the yardstick that is hanging off the table.
- Demonstrate that if you push slowly down on the end of the yardstick that the yardstick lifts the paper. Reposition the paper as before.
- Quickly and firmly strike the exposed end of the yardstick (the stick will break). Ask the boys why they think the yardstick broke this time. The yardstick broke because the atmospheric pressure on the surface of the paper held the yardstick down. By striking the stick quickly, you don't give the air enough time to move out of place and so the yardstick is held in place. You can break one yardstick 2-3 times.
- Let each boy have a turn breaking a yardstick. They LOVE this!

TOOTHPICK BALANCE

Scientist Requirement 11 (one of three tricks)

ITEMS YOU WILL NEED:

- Toothpick for each boy (round works best)
- Spool of floral wire
- Needle nose pliers

- Cut the wire into lengths of 12-18 inches (one for each boy)
- Using the pliers, make a tiny loop in one end of each wire. I usually do this before the meeting. Insert the tip of one toothpick into the tiny loop and pinch the loop onto the toothpick with

SCIENTIST – Toothpick Balance Continued

the pliers. Now bend the wire to form a large letter “c” with the toothpick at the top. Practice balancing the toothpick on your fingertip.

- Give each boy a toothpick and challenge him to balance it on the end of his finger. Discourage them from sticking the toothpick under their fingernail.
- After a few attempts show them that you can do it using the toothpick with the wire you prepared ahead of time.
- Fasten a wire to the end of each boy’s toothpick and challenge him to try again to balance his toothpick.
- The wire must hang below the toothpick, but does not have to be in the exact shape of a “c”. Allow the boys to bend their wire into different shapes and observe the results.

STOMP ROCKETS

Scientist Requirement 8

ITEMS YOU WILL NEED:

- ___ 5 ft. of 1/2” schedule 40 PVC
- ___ One 90° 1/2” elbow
- ___ Small saw to cut PVC
- ___ 8 1/2”x11” pieces of paper
- ___ 7/8 “ I.D. (inside diameter) plastic tips
- ___ Masking tape or clear packing tape
- ___ Cloth duct tape

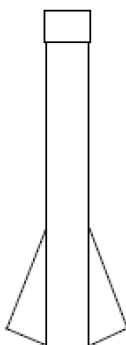

- ___ Transparent tape
- ___ Cardstock of various colors (Cut 2”x3” rectangles, then cut diagonally)
- ___ Several empty 2-liter soda bottles
- ___ Markers (optional)
- ___ Scissors

- Cut the PVC into a 4’ and a 4” length (save the scrap piece). Connect these two pieces with the elbow. If you don’t have PVC adhesive, don’t worry; just twist these together until they are snug. Using duct tape, tape the empty soda bottle snugly onto the end of the 4” piece of PVC. This is the launcher. Preassemble this at home and bring it to the meeting with you. You will also want to bring extra soda bottles since they do burst after several stomps. The bottles last longer if the boys stomp with one foot.
- Wrap a piece of notebook paper tightly around the leftover piece of PVC to form an 8 1/2” roll. Slide the roll off the PVC. Using your finger, with a twisting motion tighten one end slightly so that it just fits inside the plastic tip. Place the tip on the end of the paper.
- Now use your finger to slightly loosen the other end of the roll so that it fits easily over the end of the PVC. The bottom edge will be slightly uneven.
- Use the masking or packing tape to tape the plastic tip to the paper. Use transparent tape to secure the side seam of the rocket. Trim the bottom edge, if desired, until it is even.
- Use the markers to decorate the rocket.
- Attach the cardstock fins to the rocket with transparent tape. Three to five fins, evenly spaced around the rocket work the best. NOTE: Attach the fins to the rocket along the diagonal cut (the edge opposite the right angle of the triangle).
- Go to an open area with a firm surface. Place the rocket onto the end of the launcher. Hold the launcher at arm’s length with the rocket pointing up and the soda bottle resting on the ground. Now STOMP in the center of the soda bottle and watch the rocket go! Remember to wear protective eyewear.
- Retrieve the rocket. Blow into the pipe to re-inflate the soda bottle and launch again.

SCIENTIST ACTIVITY BADGE – Continued

OPTICAL ILLUSION TOPS

Scientist Requirement 12

ITEMS YOU WILL NEED:

- __ 2" plastic top for each boy. Be sure the top of the top is flat.
- __ Several 3" circles of white cardstock or poster board with a hole punched in the center
- __ Markers

- In advance, prepare some of the cardstock circles by coloring them with different patterns so that you can demonstrate the concept to the boys (patterns are included for your use).

- Place the colored discs over the stem of the top. Ask the boys to predict what they will see.

Spin the top and observe.

- Allow the boys to create their own patterns and try them out. Remind them that geometric shapes are the best. It is also more effective if you limit yourself to two or three colors per disc.

- *Copy circles at right onto white cardstock.*

- *Leave the top circle black and white. Color the circle in the middle with two or three different colors (I suggest primary colors). Color the circles that are divided into wedges color you like. Cut out additional circles and make patterns of your choice. Experiment-it's fun!*

- *Once you color them, laminate them so you can use them over and over. You do not necessarily need to laminate the ones that the boys will do.*

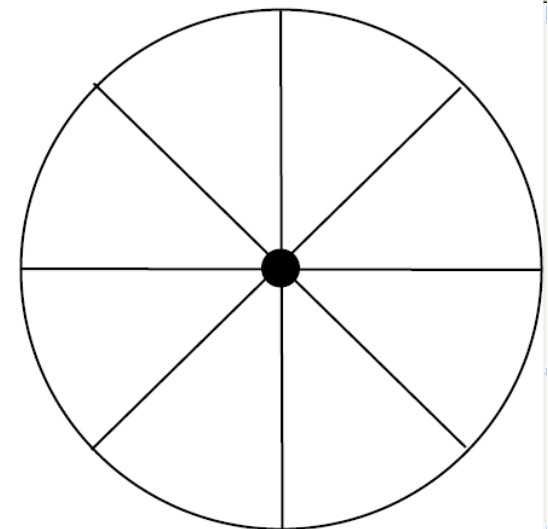
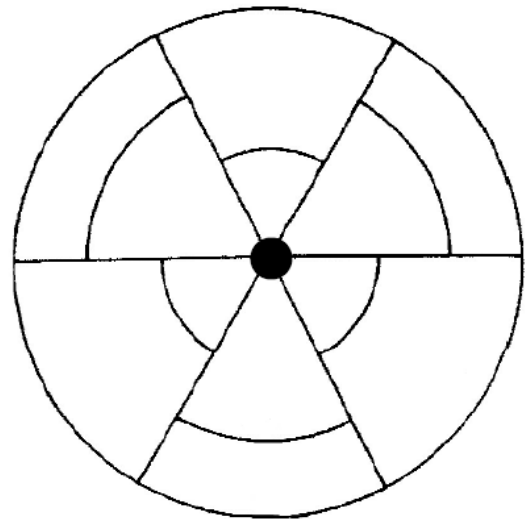
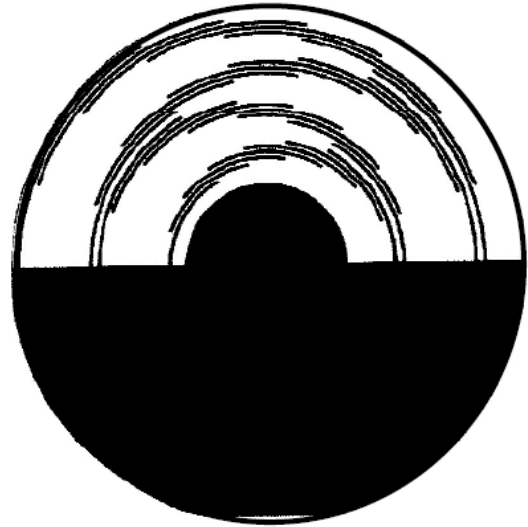

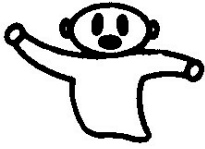

SHOWMAN

PUPPET STAGE

Showman Puppets Requirement 3

DOUBLE TAKE Making the stage will also fulfill Craftsman Requirement 4 (part.)

ITEMS YOU WILL NEED:

- ___ Large cardboard box (like an appliance box)
- ___ Utility knife (don't let the boys use this)
- ___ Pencils, markers or paints
- ___ Curtain rod or dowel
- ___ Simple curtain

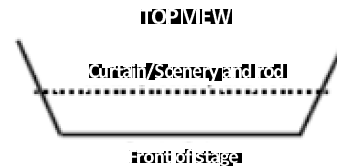
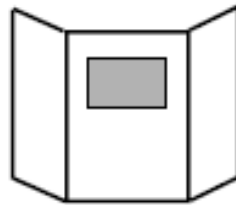

- Prior to the meeting obtain a large cardboard appliance box. Remove any large staples or cover the ends with tape. Resist the urge to remove the flaps of the box. If they are in the way, tape them to the inside of the box for stability. You can even tape the bottom flaps to the floor with wide masking tape to keep the stage from tipping over during the puppet show.
- Have the boys decide on a design for their stage and begin marking the box with the pencils.
- When the design is complete, cut out the stage opening and allow the boys to use the paints or markers to decorate the box. You may need to cut away the back of the box.
- Prior to your first puppet show, mount the curtain rod and curtain 6-8 inches behind the stage opening. This is easily accomplished by cutting a notch in the sides of the box on either side of the stage. You can also create "scenery" by drawing the desired setting on blank newsprint and using this instead of the curtain.

BATONS

Showman Music Requirement 14

DOUBLE TAKE: Craftsman Requirement 2 (partial)

ITEMS YOU WILL NEED:

- ___ 1" doll head for each boy
- ___ 3/16" x 12" dowel
- ___ Tacky glue
- ___ Sandpaper
- ___ Markers
- ___ Clear spray sealer (optional)

- Give each boy a dowel and a doll head. Have him place a small amount of glue into the hole on the doll head. Push the dowel firmly into the doll head.
- Give each boy a piece of sandpaper. Instruct him to sand his baton smooth. Also he should sand the tip into a rounded shape.
- Give each boy some markers so that he may decorate his baton as desired.
- You may spray the baton with a clear sealer.

TRAVELER



COMPACT FIRST AID KIT

Traveler Requirement 8

DOUBLE TAKE: Readyman Req. 12 Explain how to use each item you include in the kit

ITEMS YOU WILL NEED:

- ___ Rectangular potholder with a loop
- ___ Button (that fits in potholder loop)
- ___ 5 snack size plastic Ziploc baggies
- ___ Band-Aids, antiseptic wipes, needle, matches, etc.
- ___ Sewing machine
- ___ Needle, thread, small scissors

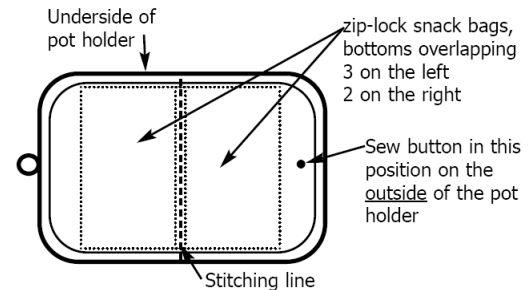

Prior to the meeting:

- Sew the bottom (non-Ziploc) edges of the baggies down the center of the potholder with a zig zag stitch. Three baggies should lay to the left and 2 should lay to the right (see diagram above). If you wish, you could also sew the button to the outside of the potholder on the outside center, on the opposite edge from the loop, or the boys could do this at the meeting, if time permits.
- Gather the first aid items for the kit.

At the meeting:

- If you haven't already done so, have the boys sew the button on the outside of the pot holder. Be careful that the boys do not sew through the baggies.
- Go over each item to be added to the kit. Discuss with the boys how to use this item. Have the boy place the item in one of the Ziploc baggies. Repeat with each item. When you have discussed all the items, fold the pot holder along the stitching line and fasten with the button. Now each boy has a first aid kit for the family car.

MAP SYMBOLS ACTIVITIES

Traveler Requirement 9

ITEMS YOU WILL NEED:

- ___ Map of your area (one for each boy) (see www.maps.yahoo.com) OR obtain one large map and laminate it so you can use it over and over
- ___ Enlarged map symbols on individual cards
- ___ Names of symbols on separate cards (opt.)
 - Show the boys the map symbols. Have them try to guess what they represent. Then show them the map and have them try to find some of the symbols they have identified. Challenge them to find their house or the school they attend. This makes the activity more meaningful to them.
 - You could also use the cards with the names on them to play a matching game.

Traveler Requirement 10

ITEMS YOU WILL NEED:

- ___ Map of area (the one you used above)
- ___ Ruler for each boy
- ___ Markers
 - Have the boys locate a common landmark (like the library or the mall) and have them draw two routes to get there from their home. You might want them to mark each route in a different color. Have the boys measure the route to see which one is the shortest.

WEBELOS DOUBLE TAKES

Many of the requirements for Webelos Activity Badges are very similar. If you do just a little bit more, you can pass off two or three requirements at the same time. This is especially useful for LDS sponsored packs where time is so short. Here is a list of requirements that coincide with each other.

Activity badge	Double Take
Aquanaut 5: Water rescue Methods	Ready Man 8: Safe Swim/Buddy System
Aquanaut 7: 100 meter Swim	Athlete 9: Swim a quarter mile/ improve time
Aquanaut 8: Swimming Belt Loop	Athlete 9: Swim a quarter mile/ improve time Sportsman 3: 2 individual Sport Belt Loops
Artist 3: Draw picture outdoors/ Frame it	Craftsman 3: Make display stand or FRAME
Artist 7: Sculpt object from clay	Craftsman 4: 4 useful items not from wood
Artist 8: Make a mobile	Craftsman 4: 4 useful items not from wood
Athlete 2: Explain Physical/Mental Health	Fitness 1: Health Character Connection
Athlete 8: Ride bike 1 mile/ improve time	Sportsman 3: 2 individual Sport Belt Loops Readyman 9: Bicycle safety rules Handyman 6,7,8: Bike repairs
Athlete 9: Swim a quarter mile/ improve time	Aquanaut 7: 100 meter Swim Aquanaut 8: Swimming Belt Loop Sportsman 3: 2 individual Sport Belt Loops
Athlete 10: Physical Fitness pin	Sportsman 3: 2 individual Sport Belt Loops
Citizen 5: Pledge of Allegiance	Webelos 6: Flag Ceremony
Citizen 8: Citizen Belt Loop: Job Chart 1 week	Family Member 2: Job chart 2 months. Family Member 9: Help clean home 1 month Family Member 10: Help with laundry Family Member 11: Plan and prepare meals Handyman 1: Responsibility Character Con. Handyman 13: Help care for the lawn
Citizen 8: Citizen Belt Loop: Service Project	Scholar 3: Help in school activity or service Scholar 13: Help other student in school Outdoorsman 6: Conservation Project
Citizen 11: Write/tell story about an American	Showman 16: Monologue Communicator: 2- 3 minute talk to den
Communicator 2: 3 minute talk to den	Showman 16: Monologue Citizen 11: Write/tell story about an American
Communicator 10: Foreign Language	Scholar 6: Language Belt Loop
Communicator 12: Visit 5 websites	Traveler 3: Internet map sight
Craftsman 1: Tool Safety	Handyman 14-17: Store, clean, label tools, assemble tool kit
Craftsman 2: Make 2 wooden objects	Engineer9: Build a catapult Handyman 12: Build a sawhorse or stool Naturalist 5:(make birdfeeder) watch for birds Naturalist 11:(make waterscope) learn about aquatic ecosystems Showman 4: Build a puppet stage
Craftsman 3: Make a display box or frame	Artist 3: Draw picture outdoors/ Frame it

Activity badge	Double Take
Craftsman4: Make 4 non wood useful items	Artist 7: Sculpt object from clay Artist 8: Make a mobile Engineer 6: Make simple electrical switch Engineer 8: Make simple crane Naturalist 2: Make and keep insect zoo Naturalist 3: Set up aquarium or terrarium Scientist 2,5,6: (make submarine in a bottle) Pascal's Law, water and air pressure Scientist 8: Build and launch model rocket Showman 3: Make a set of puppets Showman 4: Build a puppet stage
Engineer 2: Draw floor plan of your home	Readyman 11: Make home fire escape plan
Engineer 5: How energy gets to your home	Family Member 7: Energy savings plan
Engineer 6: Make simple electrical switch	Craftsman4: Make 4 non wood useful items
Engineer 8: Make simple crane	Craftsman4: Make 4 non wood useful items
Engineer9: Build a catapult	Craftsman 2: Make 2 wooden objects
Engineer 10: Math belt Loop	Scholar 7: Math Belt Loop
Family Member 2: Chart of jobs for the home. New job for 2 months	Citizen 8: Citizen Belt Loop: Job Chart 1 week Handyman 13: Help care for the lawn
Family Member 5: 4 family meetings	Fitness 2: Safety Notebook Fitness 3: Plan week of nutritious meals Fitness 5: Discuss bad effects of tobacco Fitness 6: Discuss bad effects of alcohol Fitness 7: Discuss bad effects of drugs Fitness 8: Drug booklet, discuss with adult
Family Member 6: Inspect home for hazards	Readyman 13: Accidents in the home
Family Member 7: Energy savings plan	Engineer 5: How energy gets to your home
Family Member 9: Clean home properly 1 mo.	Citizen 8: Citizen Belt Loop: Job Chart 1 week Handyman 1: Responsibility Character Con. Handyman 13: Help care for the lawn
Family Member 10: Help with laundry	Citizen 8: Citizen Belt Loop: Job Chart 1 week Handyman 1: Responsibility Character Con.
Family Member 11: Plan and prepare meals	Fitness 3: Plan 1 week nutritious meals Outdoorsman 8: Prep, Cook, Cleanup 1 meal
Fitness 1: Health Character Connection	Athlete 2: Explain Physical/Mental Health
Fitness 2: Safety Notebook	Readyman 3: Make help list and post by phone Family Member 5: 4 family meetings
Fitness 3: Plan week of nutritious meals	Family Member 5: 4 family meetings Family Member 11: Plan and prepare meals Outdoorsman 8: Prep, Cook, Cleanup 1 meal
Fitness 5: Discuss bad effects of tobacco Fitness 6: Discuss bad effects of alcohol Fitness 7: Discuss bad effects of drugs Fitness 8: Drug booklet, discuss with adult	Showman 19: Write/ put on play (as a den for parents about bad effects of drugs etc.) Showman 2,5 Puppet play (about drugs etc.)
Forester 3: Identify 6 forest trees	Webelos 6: Overnight camp or Dayhike Outdoorsman 9: 3 mile hike/ things needed

Activity badge	Double Take
Forester 4: Identify 6 forest plants	Webelos 6: Overnight camp or Dayhike Outdoorsman 9: 3 mile hike/ things needed Naturalist 7: Poisonous plants and reptiles
Forester 7: Wood used in building houses	Geologist 4: Geologic materials used in houses
Forester 8: Plant 20 forest seedlings, care for	Naturalist 3: set up terrarium Outdoorsman 6: Conservation Project
Forester 9: benefits and harm of wildfire	Outdoorsman 7: Fire safety/ build and put out fire Webelos 7c: Outdoor Code
Forester 10: Urban Forestry plan	Traveler 13: Map and compass belt loop, map of neighborhood
Geologist 4: Geologic materials used in houses	Forester 7: Wood used in building houses
Geologist 8: Trip to geological site, geological lab, or rock show	Scientist 4: Science Belt Loop, visit place where scientist works and discuss jobs with him/her
Handyman 1: Responsibility Character Con. Job for 2 weeks	Citizen 8: Citizen Belt Loop: Job Chart 1 week Family Member 9: Clean home properly 1 mo. Family Member 10: Help with laundry
Handyman 6,7,8: Bike repairs	Athlete 8: Ride bike 1 mile/ improve time Sportsman 3: 2 individual Sport Belt Loops Readyman 9: Bicycle safety rules
Handyman 12: Build a sawhorse or stool	Craftsman 2: Make 2 wooden objects
Handyman 13: Help care for the lawn	Citizen 8: Citizen Belt Loop: Job Chart 1 week Family Member 2: Chart of jobs for the home. New job for 2 months Family Member 9: Clean home properly 1 mo.
Handyman 14-17: Store, clean, label tools	Craftsman 1: Tool Safety
Naturalist 1: Respect Character Connection	Webelos 7c: Outdoor Code Outdoorsman 5: Leave no trace
Naturalist 2: Make and keep insect zoo	Craftsman 4: Make 4 non wood useful items
Naturalist 3: Set up aquarium or terrarium	Craftsman 4: Make 4 non wood useful items Forester 8: Plant 20 forest seedlings, care for
Naturalist 4: Visit museum nature ctr. or zoo	Scientist 4: Science Belt Loop, visit place where scientist works and discuss jobs with him/her
Naturalist 5: watch for birds	Craftsman 2: Make 2 wooden objects (make birdfeeder)
Naturalist 7: Poisonous plants and reptiles	Forester 4: Identify 6 forest plants Readyman 7: Basic first aid/specific injuries
Naturalist 11: (make waterscope) learn about aquatic ecosystems	Craftsman 2: Make 2 wooden objects
Naturalist 12: Clean up litter to protect animals	Outdoorsman 6: Conservation Project
Naturalist 13: Wildlife Cons. Belt Loop	Outdoorsman 6: Conservation Project
Outdoorsman 1: Dress, pack correctly for camp	Traveler 7: Plan 2 day trip, and pack for it
Outdoorsman 2 Evening outdoor activity w/ fire	Webelos 7c: Outdoor Code Forester 9: benefits and harm of wildfire Showman 9: Indoor/ Outdoor song
Outdoorsman 5: Leave no trace	Webelos 7c: Outdoor Code Naturalist 1: Respect Character Connection

Activity badge	Double Take
Outdoorsman 6: Conservation Project	Forester 8: Plant 20 forest seedlings, care for Naturalist 12: Clean up litter to protect animals Naturalist 13: Wildlife Cons. Belt Loop
Outdoorsman 7: Fire safety/ build and put out fire	Webelos 7c: Outdoor Code Forester 9: benefits and harm of wildfire
Outdoorsman 8: prepare cook cleanup meal	Fitness 3: Plan 1 week nutritious meals Family Member 11: Plan and prepare meals
Outdoorsman 9: 3 mile hike/ things needed	Forester 3: Identify 6 forest Trees Forester 4: Identify 6 forest plants Webelos 6: Overnight camp or Dayhike
Outdoorsman 10: Visit Boy Scout Camp	Arrow of Light 4: Visit Boy Scout Outdoor activity
Readyman 3: Make help list, post by phone	Fitness 2: Safety Notebook
Readyman 7: Basic first aid/specific injuries	Naturalist 7: Poisonous plants and reptiles
Readyman 8: Safe swim/ buddy system	Aquanaut 5: Water rescue Methods Aquanaut 7: 100 meter Swim Aquanaut 8: Swimming Belt Loop Sportsman 2: 2 individual sport belt loops
Readyman 9: Bicycle safety rules	Athlete 8: Ride bike 1 mile/ improve time Sportsman 3: 2 individual Sport Belt Loops Handyman 6,7,8: Bike repairs
Readyman 10: Sports safety equipment	Sportsman 3: 2 individual Sport Belt Loops Sportsman 4: 2 team Sport Belt Loops
Readyman 11: Make home fire escape plan	Engineer 2: Draw floor plan of your home
Readyman 12: Explain items in first aid kit	Traveler 8: Check car first aid kit
Readyman 13: Accidents in the home	Family Member 6: Inspect home for hazards
Readyman 14: Car safety rules	Traveler 11: List of safety rules for travel
Readyman 15: Attend first aid demo (boy scout, red cross or community event)	Arrow of Light 4: Visit Boy Scout troop mtg.
Scholar 3: Help in school activity or service	Citizen 8: Citizen belt loop, service project Naturalist 12: Clean up litter to protect animals Outdoorsman 6: Conservation Project
Scholar 6: Languages Belt Loop	Communicator 10: Foreign Language
Scholar 7: Math Belt Loop	Engineer 10: Math belt Loop
Scholar 13: Help student with schoolwork	Citizen 8: Citizen belt loop, service project
Scientist 2,5,6: Pascal's Law, water and air pressure	Craftsman4: Make 4 non wood useful items (make submarine in a bottle)
Scientist 4: Science Belt Loop, visit place where scientist works and discuss jobs with him/her	Geologist 8: Trip to geological site, geological lab, or rock show Naturalist 4: Visit museum nature ctr. or zoo
Scientist 8: Build and launch model rocket	Craftsman4: Make 4 non wood useful items
Showman 2,5 Write/ put on Puppet play	Fitness 3,5-7: Discuss nutrition and bad drugs. (write/ put on puppet play about it)
Showman 3: Make a set of puppets	Craftsman4: Make 4 non wood useful items
Showman 4: Build a puppet stage	Craftsman 2: Make 2 wooden objects Craftsman4: Make 4 non wood useful items
Showman 9: Indoor/ Outdoor song	Outdoorsman 2 Evening outdoor act. w/ fire
Showman 16: Monologue	Citizen: Write/tell story about American Communicator 2: 3 minute talk to den

Activity badge	Double Take
Showman 19: Write/ put on play	Fitness 3: Discuss nutrition and bad drugs. (Write/ put on play about it)
Sportsman 3: 2 individual Sport Belt Loops	Aquanaut 8: Swimming Belt Loop Athlete 9: Swim a quarter mile/ improve time Athlete 8: Ride bike 1 mile/ improve time Handyman 6,7,8: Bike repairs Readyman 9: Bicycle safety rules Athlete 10: Physical Fitness pin
Sportsman 4: 2 team sport belt loops	Readyman 10: Sports safety equipment
Traveler 3: Internet map sight	Communicator 12: Visit 5 websites
Traveler 5: Figure cost per mile of trip	Scholar 7: Math belt loop
	Engineer 10: Math belt loop
Traveler 7: Plan 2 day trip, and pack for it	Outdoorsman 1: Dress, pack correctly for camp
Traveler 8: Check car first aid kit	Readyman 12: Explain items in first aid kit
Traveler 11: List of safety rules for travel	Readyman 14: Car safety rules
Traveler 13: Map and compass belt loop, map of neighborhood	Forester 10: Urban Forestry plan

Webelos badge requirement 8d – earn the religious emblem of your faith

There are also “double takes” for the Academics and Sports Program and the Webelos program. See the Academic and Sports Program section of this Pow Wow book for a listing of how earning belt loops can be used toward some of the Webelos Activity badges also.

Also there are some of the patches in the back section of this Pow Wow book that list requirements from the Webelos handbook.



WEBELOS AND FAITH IN GOD DOUBLE TAKES

Faith in God	Webelos Double Take
Learning and Living the Gospel	
LLG 1: Sacrament/ baptismal Covenants, and things we can do to remain faithful.	Webelos badge 8: Faith Character Connection
LLG 2: FHE about First Vision and how Heavenly Father answers our prayers.	Webelos badge 8: Faith Char. Connection Communicator 2: Prepare, give 3 min talk. Showman 16: Give a monologue (talk)
LLG 5: Give prayers, share feelings	Webelos badge 8: Faith Char. Connection
LLG 6: Share scripture on faith, testimony	Webelos badge 8: Faith Char. Connection Communicator 2: Prepare, give 3 min talk. Showman 19: Give a monologue (talk)
LLG 7: Read and teach Word of Wisdom	Athlete 10: Physical Fitness Belt Loop Fitness 1, 3-8: Nutrition, drugs Communicator 2: Prepare, give 3 min talk. Showman 16: Give a monologue (talk) Showman 19: Write, put on play.
LLG 8: Pedigree Chart, temple blessings	Family Member 12: Heritages Belt Loop
LLG 9: Sing Choose the Right, discuss agency and responsibility for choices	Showman 9: Song indoor and outdoor song, discuss differences. Citizen 12: boy who is good citizen/ why Citizen 14: Why obey laws, 3 laws obeyed
Serving Others	
SO1: Good Samaritan, Service Project	Citizen 8: Citizen Belt Loop: Service Project Scholar 3: Help in school activity or service Scholar 13: Help other student in school Outdoorsman 6: Conservation Project
SO2: Letter of Appreciation	Communicator 11: Use computer to write letter
SO4: Plan, prepare and serve a nutritious meal	Family Member 11: Plan and prepare meals Fitness 3: Plan 1 week nutritious meals Outdoorsman 8: Prep, Cook, Cleanup 1 meal
SO5: Entertain children with songs/games	Family Member 8: Family Fun Night Showman 2-6: Make puppets, write, put on play Showman 8,9: Play music instrument, sing songs Showman 19: Write, put on play Craftsman 4: Make useful items Scientist 1-12: Science magic show
SO 6: Good Manners and Courtesy	Citizen 1b: How to be good citizen now Communicator 1: Body language game
SO 7: Parent child activity	Family Member 8: Family Fun Night Fitness: 1-8: games and plays to teach family about nutrition and bad effects of drugs. Outdoorsman 2: Outdoor evening activity Outdoorsman 8: Cook at outdoor activity Scientist 1-12: Science magic show Showman 19: Write, put on play Showman 2-6: Make puppets, write put on play

Faith in God	Webelos Double Take
SO 8: 12 th Article of Faith, good citizen	Citizen 1: Citizenship Character Connection
Developing Talents	
DT1: Budget, tithing, save for education	Family Member 3: How family spends/ saves
DT2: Sing, play or lead song from primary. Teach song, discuss developing talents	Showman 8,9 Play music instrument, sing songs
DT3: Write poem, story or play, about a gospel principle	Showman 2, 19 Write puppet play or play Communicator 8: Write article
DT4: Make and display item	Artist 3: Draw picture outdoors/ Frame it Artist 7: Sculpt object from clay Artist 8: Make a mobile Engineer 6: Make simple electrical switch Engineer 8: Make simple crane Engineer9: Build a catapult Handyman 12: Build a sawhorse or stool Naturalist 2: Make and keep insect zoo Naturalist 3: Set up aquarium or terrarium Naturalist 5:(make birdfeeder) watch for birds Naturalist 11:(make waterscope) learn about aquatic ecosystems Scientist 2,5,6: (make submarine in a bottle) Pascal’s Law, water and air pressure Scientist 8: Build and launch model rocket Showman 3: Make a set of puppets Showman 4: Build a puppet stage
DT5: Visit art museum or attend play, concert, or cultural event	Showman 17 Attend a play
DT6: D&C 88: 118 Improve personal study habits.	Scholar 1,2,4, Do your best, good grades, importance of education,
DT7: 5 things to help around home. Importance of honoring parents and work.	Citizen 8: Citizen Belt Loop, Job Chart Family Member 2: Job chart 2 months. Family Member 9: Help clean home 1 month Family Member 10: Help with laundry Family Member 11: Plan and prepare meals Handyman 1: Responsibility Character Con. Handyman 2,4,5: Car Maintenance Handyman 10: Replace light bulbs Handyman 11: Arrange storage area (chemicals) Handyman 13: Help care for the lawn Handyman 14,15,16,17: Care for tools/toolbox
DT8: Physical Fitness program 1 month	Athlete 5: Improve fitness over 30 days
DT9: Good Nutrition, health and grooming	Athlete 2: Explain Physical/Mental Health Fitness 1: Health Character Connection Fitness 3,4: Track meals, Plan meals Family Member 5: 4 family meetings Family Member 11: Plan and prepare meals Outdoorsman 8: Prep, Cook, Cleanup 1 meal

Advice from Akela



In this section you will find some tips and advice for almost every Cub Scout leader. There is information here that will be helpful to the leaders who are new and those who are experienced. Included in this section are tips for a brand new leader, Den Leaders, Unit Commissioners, Cubmasters, Pack Committees, Ideas for saying “Thank You”, Pack Communication, How to involve parents, Den Discipline, Scouting for the differently-abled, all about Training and more...

Akela (Pronounced *Ah-KAY-la.*) means good leader and the name comes from Rudyard Kipling's *Jungle Book*.

HELP! I'M A NEW CUB SCOUT LEADER!

Welcome to the wonderful, wild and wacky world of Cub Scouts! Well, at least we hope it will be wonderful, not too wild and just a little bit wacky. Here are some suggestions for all Cub Scout leaders, Cubmasters, committee members, den leaders or Webelos leaders, who are just starting out.

YOUTH PROTECTION TRAINING - If you have not done so already go online to myscouting.org (or follow the links on the UNPC Website- www.utahscouts.org), create yourself an account and take the Youth Protection Training. As of June 1, 2010 ALL new scout leaders must present proof of Youth Protection Training with their Registration. All Scout leaders must take this training every 2 years. A Completion certificate is available to print or save upon completion of this course. Save it, print it and keep a copy for yourself, but make a copy to turn in with your registration.

REGISTER - Obtain a copy of the Adult Leader Registration form and fill it out completely. Be sure you have three signatures yours, the Committee Chairman and the Chartered Organization Representative. Return the completed form to your local Scout office with applicable fees. Some chartered organizations will pay registration fees. Check with your chartered organization representative to see if yours does.

GET TRAINED - Fast Start training is designed to help get you started as a successful leader. The section for your position (Den Leader, Webelos Den Leader, Cubmaster, Pack Committee or Tiger Cub Den Leader) will help you plan your first meeting by showing you what a meeting looks like and explaining how it is designed. You can check this video out or obtain a copy of the DVD at your local Scout Service Center.

Fast Start Training can also be done online, for all you computer lovers. Just log on to your **myscouting** account (that you created to take your Youth Protection Training) or on the Utah National Parks Council web site (www.utahscouts.org)

Your next step is **Leader Specific Training**. As of August of 2010 this training is also available on your **myscouting** account. Your local district should provide several opportunities throughout the year to attend these training sessions. Take this training as soon as possible. This will give you the foundation you need to become a successful leader. Every boy deserves a trained and qualified leader. The next step is also online on myscouting.org and is called **"This is Scouting"** it gives an overview and a bit of history of the BSA and helps you understand where you fit in.

LEARN THE LINGO - To be a Cub Scout leader, you will need to learn a new language - a form of English known as the language of Scouting (which sometimes sounds like Pig Latin to those just starting out.) Here is a brief dictionary to help you learn some of the most common terms.

PACK - A Scouting unit, made up of dens, which conducts the Cub Scout program for the chartered organization.

DEN - A neighborhood group of six to eight Cub Scouts or Webelos Scouts who usually meet once a week.

CHARTERED ORGANIZATION - A religious, civic, fraternal, educational, or other group that has applied for and received a charter to operate a Scouting unit.

CHARTERED ORGANIZATION REPRESENTATIVE The liaison between the chartered organization and pack.

NEW LEADER - LINGO – Continued

TIGER CUB A boy who is in the first grade (or is 7 years old) and registered, with his adult partner, as a member of a Tiger Cub den.

BOBCAT The first rank for all boys who join Cub Scouting.

WOLF The Cub Scout rank designed for a second-grade Cub Scout (or one who is 8 years old). Wolf rank is earned by completing twelve achievements.

BEAR The Cub Scout rank designed for a third-grade Cub Scout (or one who is 9 years old.) Bear rank is earned by completing twelve of twenty-four achievements.

WEBELOS SCOUT A Cub Scout who has completed third-grade (or is age 10) and is a member of a Webelos den.

ARROW OF LIGHT Highest award in Cub Scouting and is earned by Webelos Scouts. It is the only Cub Scout badge that may be worn on the Boy Scout uniform.

PACK COMMITTEE A group of qualified adults appointed by the chartered organization to administer the affairs of the pack. The pack committee is led by the **PACK COMMITTEE CHAIRMAN**.

CUBMASTER The registered leader of the pack. One of his responsibilities is seeing that pack meeting happens and is a good experience for the boys and their families. The Cubmaster is helped by an **ASSISTANT CUBMASTER**.

DEN LEADER A registered leader who leads a Cub Scout den. A **WEBELOS DEN LEADER** leads a Webelos den. Both types of den leaders should be helped by an **ASSISTANT DEN LEADER**.

ROUNDTABLE A monthly program and morale-building training meeting for Cub Scout leaders, held by the district.

AKELA (Pronounced Ah-KAY-la) A title of respect in the Cub Scout program, referring to any good leader—parent, teacher, minister, Scouting leader, etc.

KISMIF Keep It Simple, Make It Fun.

Of course, this little dictionary does not contain all the terms used in Cub Scouting. For more info, check out the Glossary section of the Cub Scout Leader Book.

STUDY - Obtain a copy of the Cub Scout Leader Book and read it often. It will help you define your role in the pack. It is a great resource for answers to policy questions. Obtain and study additional resources that will help you be a better leader. Just a few of the many resources available are Den and Pack Meeting Resource Guide, Webelos Leader Guide, Boys' Life and Scouting magazines, Pow Wow books, Ceremonies for Dens and Packs and the Cub Scout How-to Book.

UNIFORM - Obtain and wear a Cub Scout leader uniform as soon as possible. It is attractive, comfortable, and suitable for all Cub Scout meetings and activities. Wearing the uniform properly is important in setting a good example for the boys.

HELP! I'M A NEW CUB SCOUT LEADER! – Continued

BOYS - Get to know the boys in your den and pack. They are the reason for the entire program. And you'll make some great new friends.

PLAN - Those who fail to plan, plan to fail. Make a written plan for your den meeting, pack meeting or committee meeting. Use your resources. The Den and Pack Meeting Resource Guide and the Webelos Leader Guide have excellent ideas to get you on the right track. Remember, KISMIF keep it simple, make it fun. Once you've made your plan, follow it. Next evaluate what happened. What was good? What was not so good? How can we improve?

ROUNDTABLE - Attend the monthly district Cub Scout leaders' Roundtable. You will receive many good program ideas on the monthly Core Value, and will get acquainted with leaders from other packs who will share ideas and experiences with you. You will also receive information about upcoming district and council events. "Roundtable is a way to get your battery recharged each month and puts a spark in your program," said one Cub leader.

CONTINUE TRAINING - Being trained is a misnomer. You are never completely trained in the Cub Scout program. There are always new ideas and programs out there, waiting for you to learn about them and use them with your Cubs. Yearly Cub leader Pow Wow gives you a chance to learn things that help your pack be great. Akela's Council, a unique and fun training course offered by the Utah National Parks Council, gives you a chance to learn and do with leaders from all parts of the Council and beyond. "90% of what I know about Cub Scouting I learned at Akela's Council," said one satisfied participant. The new Wood Badge program teaches leadership skills that are helpful not only in Cub Scouts, but in all phases of your life. Ask your training chairman for more info on these training programs. Get on the track and keep training!

HELP! Don't hesitate to ask for help. There are many people who want to help you provide the finest possible Cub Scout experience for the boys in your pack. They include (but are not limited to) parents and extended family, chartered organization representatives, unit commissioners, district executives, roundtable and training staffs, other Scouters, community organizations, teachers, friends and neighbors.

DELEGATE - If you are trying to do everything yourself, you will burnout. Have an assistant, a den chief or a denner help with den meetings. Invite parents and guests to help and participate in pack meeting. Parents can be actively involved on the committee when planning special events or providing transportation for field trips, day camps, etc. Remember, delegate or die!

And always remember the Cub Scout motto,

DO YOUR BEST!

DEN LEADERS

(Tips for those New and Experienced)

PLANNING is the key to running a successful den. Setting goals for the year will allow you time to gather materials and ideas for activities that relate to upcoming core values. Plan ahead to involve as many people as possible. Most people are willing to help out if given enough notice. Get to know the parents' talents and interests and involve them in your program.

ACHIEVING ADVANCEMENTS raises the boys' self-esteem and keeps them interested in Scouting. While the home is responsible for seeing the advancement requirements are completed, doing fun activities and projects that fulfill requirements during den meetings, give the boys an added boost. The Wolf and Bear handbooks are full of exciting things that will be fun for you and your Cub Scouts as they move along the advancement trail.

Always have a **PLAN B** ready. If the weather doesn't cooperate, or an activity isn't keeping the interest of the boys, have something to fall back on. When boys are bored, they get rowdy. Changing to another activity can prevent discipline problems from happening.

Use your **DEN CHIEF**. Include your den chief in your planning and let him know what you expect of him. He can be an example for the boys to look up to and "young legs" that can run and play with them, giving you a chance to attend to other needs of the den. He can be a great resource as an activity leader and will contribute a lot to your meetings as he learns important leadership skills from you. Don't forget to thank him for a job well done.

COMMUNICATE with the families of your Cub Scouts. Keep everyone informed about what is going on in your den. It makes it so much easier for parents to do their job if they know what to expect. Make up a monthly calendar outlining weekly activities and give suggestions of things they should be working on at home. Include assignments of things to bring to meetings, ideas for family activities that would fulfill requirements, information about pack meeting and praise the accomplishments of your Cub Scouts. You could even include a permission slip to be signed for your field trip.

Include **CEREMONIES** in your den meetings. Using simple flag ceremonies can help teach the boys patriotism and respect for the flag and their country. Use proper etiquette and let everyone participate. New boys will have an easier time learning the Cub Scout Promise and Law of the Pack if they are used often as part of your den meetings. Ceremonies can be used to present "Immediate Recognition" beads as well as other incentive awards. Closing ceremonies could include a Living Circle.

Always wear a **UNIFORM** when you are with the Cubs. This builds respect for you and they will behave better for you. It also encourages them to wear their uniforms. Small uniform inspections with a prize as part of the den opening or closing ceremony can really make a difference in how the boys come dressed to den meetings. Make sure your den chief is a good example by wearing his uniform, too.

KEEPING RECORDS of the boys' achievements is a challenge, but if done properly, it will make your job less stressful. Having your own separate record of which requirements have been completed helps you know where each boy is on the advancement trail, even if they can't locate their handbook. While your den chief is busy doing an activity or playing a game with the boys, it is a perfect opportunity to get your records up to date.

GET TRAINED! For the first time in Cub Scout history a Cub Scout leader can go online to myscouting.org and take all the training necessary to wear the “trained” patch on their uniform. Make it a habit to attend Roundtable each month for great program ideas and training helps. Attend other training opportunities like Pow Wow and Akela’s Council. Learn as much as you can about your Scouting job. **Training is an ongoing process that should never end.** Remember, every boy deserves a well-trained leader.

Utilize available **RESOURCES.** The list of publications that BSA has produced to help Cub Scout leaders is huge. Some of the best ones are the Den and Pack Meeting Resource Guide, the Cub Scout How-to Book, Cub Scout Leader Book, the Den Chief Handbook, Boys’ Life and Scouting Magazines. For an even larger list of resources, see the index of the Cub Scout Leader Book. Don’t forget, Council Services and other Scouters make great resources, too.

Leadership is developed and learned. You can become an effective Cub Scout Leader if you will prepare yourself and take the time to learn. Remember to be flexible in your planning. There are no set answers to handling boys. Don’t be afraid to experiment. Do your best, and above all, HAVE FUN!!

ELEMENTS OF A GOOD DEN MEETING

Den leaders, use this check list to see how your den is doing.

1. A **meeting place** where Cub Scouts feel at home.
2. Led by a **trained den leader**.
3. Assisted by a **den chief**.
4. Assisted by an **assistant den leader**.
5. Specific leadership **assignments** understood before den meeting.
6. Meeting opened and closed **on time**.
7. A well-planned **written program**.
8. Activities related to next **pack meeting**.
9. Activities and projects that encourage Cub Scout **ideals**.
10. Crafts and projects related to the **core value**.
11. Achievements and elective projects started, to be **finished at home** with parents’ help.
12. Activities that contribute to good **sportsmanship**, team spirit and citizenship.
13. Opportunities for **self-expression** through songs, games, tricks, puzzles, crafts.
14. Meeting planned to allow for a **change of pace**, alternating loud and quiet activities, giving boys a chance to let off steam.
15. Cub Scouts having **fun**.
16. **Parent involvement** wherever possible (provide refreshments, supplies, transportation).
17. All equipment and supplies **on hand** and ready to use before the meeting.
18. Inspiration and motivation through **ceremonies** and discussion of projects.
19. Properly **uniformed** Cub Scouts and leaders.



DEN DISCIPLINE

Does the idea of six highly energetic boys jumping on your couch, bouncing off your walls, painting the cat and causing all kinds of mayhem just make you want to pull your hair out? Don't worry – every Cub Scout leader has felt like that at one time or another. For the sake of your sanity, not to mention your house or your cat, you will need to come up with some guidelines of behavior for the den. This is known as den discipline.

It is important to remember that discipline is not punishment. Discipline is making the Cub Scout responsible for his own behavior – telling him that if he chooses a certain course of action, what the specific consequences of that action will be. Discipline is training given to a child to mold or correct his behavior. As a den leader, you need to spell out for the boys what is acceptable behavior and what is not. Also, let them know the consequences for acceptable and unacceptable behavior.

A **den code of conduct** (or den rules) should be established in an open discussion with the boys. Some of their ideas may be silly to you, but don't judge too harshly. Many of their ideas that relate to safety, respect for property and relationships with others will be along the same lines as yours. You may need to make suggestions for things the boys don't bring up. And they'll be delighted if you decide to throw out a rule or two. You should also discuss the consequences of breaking the den code of conduct. What should be in your den code? Things that are important to you and your boys. Since every den is different, every den code will be different. Here are some suggestions to help you get started.

- | | |
|---|--|
| -No put-downs, name calling, or crude language. | -One person speaks at a time and everyone listens. |
| -No physical aggression. | -No running inside. |
| -You are a guest in this house, please act like one. (Try to be on your best behavior.) | -Share and take turns. |
| -Be on time. | -Leave the cat (or dog or hamster or fish) alone. |
| -Wear your uniform | |
| -Bring your book. | |

A few rules are enough to start, but more may need to be added as you go. Cub Scouts may want to write their den rules and sign on a line at the end of the list. This is a way of sharing with parents the expectations of their sons. A large poster can also be placed at the den meeting site to remind boys of the code.

Now that the rules have been established, **stick to them. Be fair.** Don't let one boy get away with doing something you would discipline another boy for doing. Be consistent. Don't warn and threaten but take action quickly. Don't send a boy home unless he oversteps the disciplinary bounds you have drawn. If you do send a boy home, call his parents immediately and tell them why.

Here are a few ideas to keep your den meetings running smoothly.

Use the Cub Scout **SIGN** as a signal for quiet. When boys see this symbol, they should stop what they're doing, be quiet and raise their own arm in the sign.

- Keep den meetings going at a **FAST PACE**, with lots of variety and fun things to do. Plan more than you think you will need. Get assistants and den chiefs involved.
- Treat boys **IMPARTIALLY**. Boys expect fair treatment and your example becomes their model. If you make promises, keep them.
- **DON'T CRITICIZE** a boy in front of the den.
- Wait until you can talk to him alone.
- Give boys opportunities to make **CHOICES** as often as possible. Involve them in planning.

DEN DISCIPLINE – Continued

Take some time to **EVALUATE** your den meetings. What went well? What didn't go so well? How can I do this differently next time?

Focus on the **POSITIVE**. Catch boys being good, helping others, keeping the den code of conduct. Baden-Powell said "A pat on the back is a stronger stimulus than a prick with a pin. Expect a great deal of your boys and you will generally get it."

When asked what tricks, programs or guidelines were used in their den to promote discipline, one leader said "Well, we have our good days and our bad days. Sometimes we just have to remember they are little boys that need to use their bodies. So, we always try to have at least one activity each den meeting that gets them moving! Normally, den meetings are full of various activities, so the boys have a good chance to work off that energy."

"Most of the years we have taught, the boys got along fine. But we had one year when that was not so. The first time we had two boys collide physically, we let them know it would not be tolerated. We told them we are like brother wolves in a den and we support each other. I said if it ever happened again the parents would be informed and they would possibly attend our future meetings. No more problems!"

Here are a few ideas that have worked.

"SCOUT BUCKS." These can be anything from a fancy piece of paper with cool graphics that looks like money to a slip of paper that says "Scout Bucks" on it. Distribute these to the boys when you catch them doing something good. You can also give them out for being on time, wearing their uniform and bringing their book. At the end of den meeting (or the end of the month or another time you designate), boys can go to the den store and buy something. This store can be a box that you have filled with small toys, candies, gift certificates or coupons for free goodies, scout paraphernalia, etc.

"BEAR STUMPS" Each boy is given a block of wood that doubles as a stool at den meeting. He earns nails that will be hammered into the stump if he meets the following requirements:

Red: He must attend den meeting.

Blue: He must wear his Scout uniform.

Green: He must bring his book to den meeting.

Yellow: He must be represented by at least one member of his family at pack meeting.

White: He must meet the requirements of a "Bear Necessities" challenge. This challenge, a charge to do something to make the world just a little bit better, is written down and sent home with the boy.

Silver: He must do three good deeds for the week, without being asked. (Chores do not count.)

Gold: He must have done one good deed, that includes a sacrifice of at least one hour, without expectation of reward.

The den leader hands out the nails before the meeting begins, and the Bear Cubs can only hammer before the meeting and after the closing prayer. If hammer or nails are misused, the Bear loses his nails for that week. The boys are challenged to see how creatively they can decorate their stump. This can be adapted for Wolf dens and Webelos dens too.

Give each boy a whole piece of shoestring **LICORICE** at the beginning of the meeting. Every time you need to discipline the boy, cut off two inches. He gets whatever is left at the end of meeting time for a treat. A variation of this method would be to give each boy a small cup and three or four M&M's when he arrives. When you catch him doing good, (helping, volunteering, sharing etc..) reward him with a few more M&Ms to keep in his cup. When the meeting is over, he gets to keep the goodies in the cup.

DEN DISCIPLINE – Continued

Give each boy a whole piece of shoestring **LICORICE** at the beginning of the meeting. Every time you need to discipline the boy, cut off two inches. He gets whatever is left at the end of meeting time for a treat. A variation of this method would be to give each boy a small cup and three or four M&M's when he arrives. When you catch him doing good, (helping, volunteering, sharing etc..) reward him with a few more M&Ms to keep in his cup. When the meeting is over, he gets to keep the goodies in the cup.

The **GOOD CONDUCT CANDLE** is an oldie but goodie. A candle is lit as the meeting begins. If the boys misbehave, the candle is extinguished. Use your den code of conduct as a basis of when to keep the candle lit and when to blow it out. You determine if the behavior is suitably changed so that the candle can be lit again. When the candle is burned down to a certain level, a reward is given. It can be a pizza party, a day at the park or pool, or a day of games. Help the boys decide what the reward will be, then they will work for it.

This method has several disadvantages. Most schools and some churches do not allow open flames. Open flame is dangerous around any group of young kids. Then, what do you do for discipline once the candle is blown out?

Use carnival or homemade **TICKETS**. Give each boy three tickets at the beginning of the meeting. Have him sign his name on the ticket. When he breaks a rule, he has to give up a ticket. Tickets left at the end of the meeting can be placed in a bank. At the end of the month, add up who has the most tickets, and he gets a special treat.

Use a **MARBLE JAR**. Give each boy three marbles at the beginning of the meeting. When he breaks a rule, he gives up a marble. The marbles left at the end of the meeting go into a jar with a line drawn around it at a height determined by the leader. When the marbles go over the line, the den gets a special treat. Adjust the size of the jar to make this happen every two months or so.

Use a **POINT SYSTEM**. Award points for every part of the uniform worn by the boy (shirt, neckerchief, slide, belt, pants, socks, tucking in shirt), a point for coming, bringing their book and anything they passed off at home. Additional points can be awarded as you see fit (pack meeting attendance, helping without being asked, performing a service project, etc.). When the boy earns a set amount of points, he can choose a gift from the Scout bag. The bag contains different items from the Scout Shop, Wal-Mart, Harbor Freight, dollar store, etc. When a boy earns his Arrow of Light, he is allowed to pick his own party (within reason - no Disneyland!)

An Indian **COUP** and beads can be used in conjunction with any of the above methods. The boys can make their own coups out of leather or vinyl. They can be worn on their belts, around their necks, or displayed on a board. The boys can earn beads for:

- | | |
|---|--|
| -Attending den meeting | -Bringing his book |
| -Passing off achievements and electives | -Attending pack meeting |
| -Advancement | -Bringing a snack |
| -Denner service | -Almost anything else – beads are cheap! |
| -Coming in uniform | |

The real keys to your discipline system are: **HAVE ONE**. Don't wait to see if you need one, you do! If you wait until you need it, it's too late! Make sure everyone (Cubs and parents) **KNOWS** what it is. Explain it at the parents' meeting, in a note sent home with the boys, and at your first den meeting. Remind when necessary. **STICK TO IT**. Plan on the boys (and maybe the parents) testing you. Be ready for it. They expect you to do what you say you will do. You lose all credibility if you don't.

YOUR DEN CHIEF

A den chief is a magical creature. You can be exasperated by him sometimes when he doesn't act like an adult, but then you remember he's just a boy. You can run meetings without him, but you might as well admit that it's a whole lot easier when he is there. He is your helper, an assistant . . . a fun-loving young man, full of boy type ideas and action.

Use these six steps when choosing and using a den chief for your den:

1. **OBTAIN** - The den chief is a Boy Scout selected through the cooperation of the Scoutmaster, Cubmaster, and Den Leader. He may be any rank, but it is suggested that he be at least a First Class Scout. Age is not a factor although it is recommended that he is 3-4 years older than the boys he will be working with since his maturity and experience will be of great value. The den chief becomes a member of your leadership team.
2. **TRAIN** - This Scout will only be as good as you make him. He needs to be trained. Check with your district training chairman to find out if you have a den chief training conference. He will need a Den Chief Handbook. His den chief cord is presented at pack meeting; his patch is presented at troop meeting. There are requirements for him to complete to earn his Den Chief Service Award. (This award may be obtained at the Council Service Center). If there is no district or council training, then the Cubmaster or den leader is responsible for providing temporary training.

There are some things your den chief needs to know:

Relationships - How to work with a den leader and other pack members.

Discipline - How to help maintain discipline by leading and setting an example.

Patience - Importance of patience when dealing with Cub Scouts.

Boys' nature - **How** the viewpoint of a Cub differs from older Scouts.

Skills - How to lead songs, games, yells, skits, run-ons, other activities.

Unless you make it fun, your den chief may not be interested in spending more time learning to be a den chief.

3. **KNOW** what his responsibilities as a Den Chief (See the Cub Scout Leader Book page 65) are and know that he can use this leadership position as part of his rank advancement (6 months) in Boy Scouts and he can earn an award (1 year) as well. **Be aware** of the requirements he needs to fulfill to receive the Den Chief Service Award (see the Den Chief Handbook). It's good for the Cub Scouts to know that he is working towards a rank and specific award. His attitude towards his own advancement can help the Cub Scouts have a better attitude about theirs.
4. **USE** - Your den chief will be as effective and helpful as you will let him be. Remember he is a youth leader. Keep in mind that den chiefs are busy people too. Each week they attend troop and patrol meetings and work on their own Scouting advancements. They have school and sports activities, possibly a job and eventually, they'll discover girls.

Use your den chief at den meetings for:

Gathering period – He helps teach Cubs tricks, puzzles, and games while the den leader is checking advancement and attendance.

Opening – He helps organize Cubs and get them ready for den meeting. He may do a uniform inspection. He can sign the boys' books and record achievements the boys have completed.

DEN CHIEF – Continued

Business – He may have good ideas for theme projects, service projects, trips, etc. Give him a chance to voice his ideas.

Activities – He is your activity assistant. He can help Cubs with craft projects. He can demonstrate physical activities for the Cubs.

Closing – He helps restore order and quiet for closing.

Afterwards – Ask him to help evaluate the meeting just held and review the next meeting.

Use your den chief at pack meeting to help; den or Webelos leader **set up** displays, Cubs to **present** stunts or skits, Cubs to **maintain** good behavior, by **leading** den yells and songs, and **cleanup**.

5. PRAISE - Everyone likes to be recognized for their good work. Den Chiefs are no different.

Recognize him at the first pack meeting after becoming a den chief.

Congratulate him before your den and/or pack meeting each time he receives scout advancement.

Recognize him on his birthday or other special occasions.

Give him an important job and let him **do it**.

Be **patient** with him. He is just a boy.

Praise him during den meetings.

Build him up every way you can.

Understand his limitations and abilities.

Let him know that there are some things that he can do that you can't do.

Let him feel **successful**.

Do **NOT** leave discipline solely up to him.

6. EXPECT Your den chief to wear his uniform to your den meetings. This will encourage the Cubs to wear theirs. The Webelos will be encouraged by the insignias and badges and thus create an interest in Boy Scouting.



It isn't just an accident that we use Scouts as den chiefs. Because of his close association with den members, he can encourage them to advance in Cub Scouting and live up to the Cub Scouting ideals in their everyday life. He is already what every Cub Scout wants to be – a Boy Scout. He is a person whom the Cubs would most like to follow. This makes him a natural leader for them. By directing this natural leader wisely, we influence the den of Cubs under his leadership.

PACK COMMITTEE

ORGANIZING THE COMMITTEE How many people will you need to be an effective pack committee? Well, the answer is up to you. What are the needs of your pack? Do you need someone to help with advancement, or maintain membership records and do registration, or arrange transportation to special events like Day Camp, or make phone calls and send out reminders, or coordinate fund-raising efforts, or . . . The list is endless. You could try to do everything yourself, but you will burn out after a few months. Delegate, delegate, delegate. Train your people, then let them do their job.

What are the **needs** of your pack? Look at the boys and the families in your pack. How can you help them have a good Cub Scouting experience? Is your pack large or small? The number of boys will determine the number of dens you need, and the number of leaders to run those dens. The needs of your pack will also determine who and how many people will be on your committee.

What are some special **talents** that prospective leaders have? Someone who enjoys working with boys could be a candidate for den leader. A person who likes to make phone calls could be a good pack secretary. A person who likes to cook could be a great resource when it comes time for the Blue and gold banquet. You may even be surprised by some leaders' hidden talents!

Are the committee members **enthusiastic**? How can you help them to be? Show enthusiasm yourself. Reward and thank committee members at every opportunity. Even if they work behind the scenes, people like to be recognized and given a pat on the back.

MAINTAINING POSITIVE RELATIONSHIPS Do you have effective, open **communication**? Do you really listen to a problem before offering advice? Communicating with everyone involved in the pack, leaders as well as boys, is an essential part of pack leadership. Listening is a skill that needs to be practiced often, and leads to greater understanding within the pack. Do you let people know their **responsibilities** and their job description before they jump into a leadership position? (See pages 55-65 of the Cub Scout Leader Book)

QUALIFICATIONS AND RESPONSIBILITIES. Review with, and give a copy to, the new leader. Highlight things that are especially important to your pack. Do you always try to maintain a composed, patient, cheerful **attitude**? (Even when you want to pull your hair out?) Attitude is contagious. If you present a cheerful attitude to your pack, they will be cheerful too. Remember, the Cub Scout motto is "Do Your Best."

Do you have a regular, planned **monthly meeting** for the entire committee? Try choosing a day, time and place, then have it at the same time each month. Make sure everyone knows when and where the meeting is. Some people need to be reminded a week in advance, then a few days in advance, the day before or even ten minutes before. Refrigerator magnets, postcards, notes stuck on the door, phone calls, or e-mail can serve as reminders.

Do you **plan** far enough in advance to give adequate time for preparation? Sure, you could plan a pack meeting the night before, but will it be as effective as one planned the month before, giving the dens time to practice that skit and the Cubmaster time to round up all those awards. An annual Pack Program Planning Conference helps you to get an overview of the year, and lets you begin planning months in advance for special events.

PACK COMMITTEE – Continued

Do you use an **agenda** for your meetings and stick to it? As the leader of the meeting, you have to be firm, yet nice, in telling people that their concern will be discussed later in the meeting. Have a copy of the agenda for each participant. Be sure to include in your agenda a heading such as “Other Business” that will give others a chance to bring up and discuss issues you may not have thought of.

PACK ADVANCEMENT Are **advancement records** being kept on each boy? Is the den leader keeping accurate records of advancement? Den leaders should frequently review the book of each boy to see that he is progressing toward his rank. The den leader should keep a record of each boy’s progress that is separate from the boy’s book, just in case a book is missing or the dog eats it. Is there another copy of advancement records somewhere in the pack? What happens if the den leader’s house burns down and all the records are destroyed? Another copy makes it easier to re-create the records. The person in charge of advancement could keep a second copy of the den record. He could also maintain a file of copies of advancement forms from the Scout office as a record of advancement and awards.

Is advancement encouraged and properly **recognized**? Is the Cubmaster performing meaningful ceremonies that recognize what the boy has accomplished, or is he handing the boy the award, saying something like “He really has worked hard for this award,” then shaking his hand? Success breeds success - make advancement a meaningful and memorable thing and more boys will advance.

ADULT RECOGNITION Does everyone feel appreciated and recognized? Be sure to express appreciation whenever you can. Don’t wait for the Blue and gold banquet to **recognize leaders**. Hand out recognitions and thank yous each month. Try some fun awards, like candy bar awards. Tape a Big Hunk candy bar to a homemade certificate that says “Thanks for doing a big hunk of the work!” Or give a Snickers bar to someone who “really brings laughs and snickers to our pack.” A spark plug mounted on a wooden plaque could be given to someone who “really puts some spark in our pack.” A plastic egg mounted on a wooden base could be given to a person who is a “good egg.”

Is every leader aware of the **adult awards** they can earn? Use some of your pack planning meeting to briefly review the requirements for these awards. They are found toward the back of this Pow Wow Book and online at www.scouting.org. When leaders earn these awards, be sure to recognize them at pack meeting. It is good for the boys to see their leaders earning awards too.

PACK PLANNING MEETING HINTS

- 1 **Schedule** your meeting the same time each month.
- 2 Start **on time** and don’t go over one hour at the MOST. If you’re organized and well pre-pared, you can do it in thirty minutes.
- 3 Prepare an **agenda** and stick to it. Give everyone a copy.
- 4 Have all **materials** - agendas, pack meeting planning sheets, handouts, three hole punched for a binder.
- 5 Make sure everyone knows their **assignments** for pack meeting.
- 6 **Remind** committee members of the next meeting and their assignments for the next planning session.
- 7 Show **appreciation** for the leaders.
- 8 Always keep in mind what is best for the boys?

ELEMENTS OF SUCCESSFUL PACK MANAGEMENT

Pack committees; use this checklist to determine how well your pack is operating.

- 1 Enthusiastic **parent participation**.
- 2 Good family attendance at pack meetings and activities.
- 3 Pack **administered** by pack committee with work shared by leaders.
- 4 A pack **secretary** to keep up-to-date records.
- 5 A pack **treasurer** handles financial affairs and keeps accurate records.
- 6 Accurate advancement **records** are kept.
- 7 Cubmaster is **executive officer** of pack and responsible for program.
- 8 Pack operates on the **budget** plan.
- 9 Adult leaders are **trained**.
- 10 Adult leaders are properly **uniformed**.
- 11 Adult leaders regularly attend monthly **Roundtable**
- 12 All dens meet **weekly**.
- 13 **Two-deep leadership** in all dens.
- 14 Trained **den chiefs** in all dens.
- 15 Den leaders **meet** regularly with their den chiefs.
- 16 Pack has at least one **Webelos den** – more if needed.
- 17 Regular monthly **pack leaders' meetings** are held.
- 18 Pack holds **annual program planning conference** to plan year-round program.
- 19 Pack has plan to **transfer** Cub Scouts into Webelos dens when they turn 10 or enter 4th grade.
- 20 Pack holds impressive **graduation ceremonies** into Boy Scouting.
- 21 Pack conducts at least one **service project** each year for community or chartered organization.
- 22 Impressive **ceremonies** are used for **induction** of new families and for advancement.
- 23 Pack has an effective, year-round membership **recruiting** plan.
- 24 Pack has close working relationship with **Boy Scout troop**.
- 25 Pack **reregisters** on time with at least 50% of its members.
- 26 At least 50% of registered boys **advance in rank** each year.
- 27 Pack earns **Quality Unit Award**.
- 28 Leadership and performance of adults is regularly **recognized**.
- 29 Pack takes part in **district and council** Cub Scout activities.

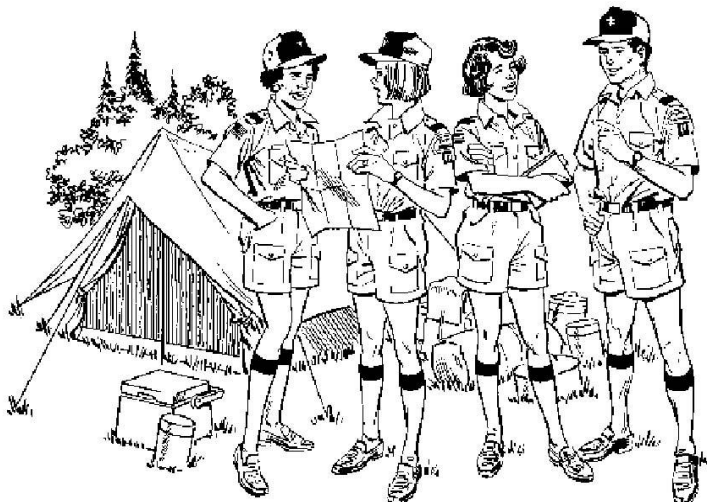

CUBMASTERS

The **CUBMASTER** is a RECRUITER, a SUPERVISOR, a DIRECTOR, a PLANNER, and a MOTIVATOR.

The job boils down to these specifics:

The Cubmaster works directly with the pack trainer, den leaders, Webelos den leaders, den chiefs, and members of the committee to make sure the dens are functioning well.

The Cubmaster plans the den and pack program with the help of all the leaders.

The Cubmaster leads the monthly pack meeting.

The Cubmaster coordinates the total Cub Scout program in the pack.

Experience shows that the success or failure of the Cub Scout program as it reaches the boys lies in the hands of the Cubmaster. He/she is the single most important person in bringing a quality Cub Scout program to the boys.

ATTITUDE OF A GOOD CUBMASTER: **ENTHUSIASTIC** -Enthusiasm is the most contagious quality in the world. **COOPERATIVE** The ability to work with other people. **DEDICATED**- Accept responsibilities go the extra mile. **HUMBLE** -There is no end to the good we can do, if we don't care who gets the credit. Keep in mind that it is the BOY who counts. **PATIENT** -You cannot do it overnight. Be consistent and stay with it. **PREPARED**- The Cubmaster who fails to plan, plans to fail.

As a Cubmaster, you must be able to communicate with the boys, committee, and the parents of the boys to function properly. You have to be able to listen to the boys' wants and needs. Programs are an accumulation of activities and tools designed to build desirable attributes in youth. Cubmasters should understand that advancement, handicrafts, games, trips, etc., are not an end in themselves, but simply a means used to attain the fundamental aims of Scouting by preparing Cub Scouts to become Boy Scouts.

ELEMENTS OF A GOOD PACK MEETING

Cubmasters, use this checklist to see how your pack is doing.

1. **Conducted** by Cubmaster with responsibilities **delegated** to pack committee members, assistant Cubmaster, den leaders, and den chiefs.
2. **Adults** outnumber Cub Scouts. Both parents, leaders and committee members in attendance.
3. Good **attendance** of Cub Scouts and Webelos Scouts.
4. **Welcoming** committee to greet people as they arrive.
5. Good **seating** arrangements.
6. **Exhibits** and displays by dens.
7. All Cub Scouts, Webelos Scouts, and leaders in clean, neat, complete **uniforms** with proper insignia.
8. Detailed, well-planned, **written program** (with a time schedule) conducted without delays. Copies of the program in the hands of all persons participating in the program.
9. An **orderly** meeting, opened and closed on time, and run without delays.
10. Meeting planned to include each Cub Scout and Webelos den **participating** in some way.
11. Cub Scouts and Webelos Scouts and parents appear **enthusiastic**.
12. **Parents participate** in meeting activities such as games, stunts and songs.
13. **Awards** made to a large number of Cub Scouts and Webelos Scouts, evidence of parent participation in awards ceremonies, and den achievement charts or den doodles on display.
14. Well-conducted **ceremonies** for opening, closing, awards and recognition of boys and leaders.
15. Evidence of activities planned toward Cub Scout **ideals and purposes**.
16. **No excessive speech making** or lengthy announcements on the program.
17. Adequate, clean, **safe place** to meet.

PACK COMMUNICATION

Communication is one of the most important aspects of pack leadership. The following skit, entitled *Halley's Comet*, illustrates this point quite well in a humorous way.

PACK COMMITTEE CHAIRMAN TO CUBMASTER: Tomorrow evening at approximately 8 p.m., *Halley's Comet* will be visible in this area, an event which occurs only every 75 years. Ask the pack to assemble out on the ball field in uniform, and I will explain this rare phenomenon to them. In case of rain, we will not be able to see anything, so assemble the pack in the assembly hall and I will show films of it.

CUBMASTER TO PACK TRAINER: By direction of the pack committee chairman, tomorrow at 8 p.m., *Halley's Comet* will appear above the ball field. If it rains, assemble the pack in uniform and march them into the assembly hall where the phenomenon will take place, something that occurs only once every 75 years.

PACK TRAINER TO DEN LEADER: By direction of the pack committee chairman in uniform at 8 p.m. tomorrow evening, the phenomenal *Halley's Comet* will appear in the ball field. In case of rain in the assembly hall, the Cubmaster will give another direction something which occurs once every 75 years.

DEN LEADER TO DEN CHIEF: Tomorrow at 8 p.m., the pack committee chairman will appear in the assembly hall with *Halley's Comet*, something which happens every 75 years. If it rains, the Cubmaster will direct the come to the ball field.

DEN CHIEF TO DEN: When it rains tomorrow at 8 p.m., the phenomenal 75-year-old pack committee chairman, accompanied by the Cubmaster, will drive his comet through the assembly hall in uniform.

Don't let the above situation happen to you! Even when you think you have given all the information clearly and to the right people – it can get all messed up. That's one reason to write it down. If you put it in print, you will know that everyone was given the same information.

ONLINE RESOURCES

At www.scouting.org you can find the following communication resources:

- A Pack Newsletter Template** – an online newsletter form ready for you to plug in information and print or download, save and customize.
- A Pack Calendar Template** – A yearly calendar ready for you to plug in some of your own dates and it's ready to give to parents and leaders.
- Family Information Letter Samples** – this is a new resource for den leaders to keep families updated on what achievements were done at den meetings, what will be done next and what needs to be completed at home. Parents are much more likely to help when they know specifically what is needed. (Also in the *Den and Pack Meeting Resource Guide*)
- Informed Consent Agreement (Permission Slip)** – This helps you know that the parents have been informed about all field trips and they approve of and support the outing.

Good Communication with all members of the pack – boys, leaders and parents, is vital to a well-run pack. It's important that everyone knows what's going on, when and where. Otherwise they can't attend. Parents need to know how their boys are doing and where they are along the advancement trail .

SAYING THANK YOU - THE CUB SCOUT WAY

Here are **over 100** ideas and suggestions for AWARDS and a way to say thank you using candy and other common items. How you make the presentations is just as important as the awards themselves. So, ham it up and have fun, especially with some of the more humorous awards. Most require five minutes of your time to make, and some even less. Most of the items listed below can be mounted on a piece of wood for a plaque, or on a piece of cardstock for a certificate. The item is listed first, followed by award names, explanations, or uses.

SMARTIES CANDIES

You're a real smartie!

If you feel your mind start to drain, these will recharge your brain.

100 GRAND CANDY BAR

You are worth a grand to our pack.

MINT CANDIES

You were "mint" to be thanked.

We "mint" to tell you thanks for a job well done.

You are worth a mint to our pack.



HERSHEY'S KISSES

You really deserve a kiss.

For love, energy, and a sweet attitude, eat one of these and get in the mood!

HERSHEY'S HUGS AND KISSES

You deserve hugs and kisses!

LIFESAVERS

You're a real lifesaver.

NUTS (PEANUTS, WALNUTS, ETC.)

Nuts about the job award.

For the person who had to be nuts to take this job.

Nuttiest.

In a nutshell, we're nuts about you.

The (Wolfs, Bears, Webelos, Pack) would go nutty without you.

Stick with us, we need you.

CRACKER JACKS

You're a "Cracker Jack" leader. You're the prize in a box of Cracker Jacks.

LUCKY CHARMS CEREAL

We're "lucky" to have such a "charming" leader.

GUM

Thanks for sticking with us.

We're stuck on you.

Thanks for "chews-ing" to help our pack.

Bubble gum - You really bubble with enthusiasm.

Extra gum - You "chews" to go the "extra" mile.

SUCKER

You can't be licked.

LOOK CANDY BAR

Look-ing good!

BIG HUNK CANDY BAR

Thanks for doing a "Big Hunk" of the work.

WHOPPER CANDIES

You did a whopper of a job!

SNICKERS CANDY BAR

I'm not "snicker-ing", you did a great job!

Thanks for adding laughs and snickers to our pack.

To help revive your sense of humor, when all else is reduced to furor!

ALMOND JOY CANDY BAR OR JOY DISH SOAP

Thanks for being a "joy" to be around.

Thanks for bringing "joy" to our pack.

*With
Thanks*

MOUNDS CANDY BAR

You're "mounds" of fun!

Thanks for doing "mounds" of work in our pack.

CRUNCH CANDY BAR

Thanks for coming through in a "crunch."

BOX OF RAISINS

You deserve a "raisin pay."

Thanks for "raisin" the enthusiasm in our pack

GUMMY BEARS

You did a “beary” good job.
Cub Scouts would be un- “bear”-able without you.

Thank you “beary, beary, beary” much.

SUGAR FROSTED FLAKES CEREAL

You’re Gr-r-reat!

RICE KRISPIES CEREAL

Thanks for putting the “snap, crackle, pop” into our pack.

TOTAL CEREAL

Thanks for being “total-ly” awesome.

TRIX CEREAL

Thanks for opening your bag of “Trix.”

SPICES

Thanks for putting a little “spice” in our pack.
You really “spiced” up our pack meeting.

WELCOME ABOARD

A 2 x 4 with the word “Welcome” written on it.

APPLE (REAL OR PLASTIC)

You’re the apple of my eye. (Paint a large letter “I” or an eye on the apple.)
For the person with great appeal.
You’re such a polished leader.

ORANGE (REAL OR PLASTIC)

“Orange” glad you’re in Cub Scouts! We are!
For the person with great appeal.

BANANA (REAL OR PLASTIC)

Thanks for going bananas over Cub Scouting.
We are bananas about you.
Top banana award for the person in charge.
For the person with great appeal.

GRAPES (REAL OR PLASTIC)

We are so “grapeful” for your help in our pack.

PUDDING (BOX OR CAN)

Thanks for “pudding” on a great program.
Thanks for “pudding” all you have into Cub Scouts.

LIGHT BULB

You’re the leader with all the bright ideas.
You really brighten up our pack.

SCISSORS

You’re a cut above the rest. You’re a real cut-up.

RULER

You really measure up.
Thanks for putting your best “foot forward.”

BATTERY

You’ve charged up our pack.
Thanks for energizing our pack.
For the leader who keeps going and going and going . . .

MARBLES

You did a “marble-ous” job.
Here’s a few extra marbles, in case you lost some of yours.
Order of the spare marble -for the person who’s lost ‘em.

RUBBER BANDS

You really banded us together.
Thanks for expanding our knowledge.

MARKERS

You’re re-mark-able!
You’ve made your mark on our pack.

EGG (PLASTIC, NOVELTY, HARD-BOILED)

For a real good egg.
Thanks for the “egg”-celent job.
That was “egg”-actly what we needed.
Good egg award for not cracking under pressure.
Thanks for egging us on to do our best.

SALT

You are the salt of the earth.

**BALLS**

For someone who is really on the ball.
Thanks, we had a ball!
Thanks for giving our pack that needed bounce.
Football - For someone who really tackles problems. Soccer ball - We get a kick out of you.
Baseball - You’ve hit a grand slam with our pack.

TACKS

When it comes to being a leader, you’re as sharp as a tack.

SPARKPLUG OR SPARKLER

Thanks for putting the “spark” in our pack.

KEYS

You are the key to our success. You unlock the fun at pack meeting.
Thanks for being a key player.

NEEDLE AND THREAD

Thanks “sew” much.

You keep our pack in stitches.

FAN (folded paper, or small electric or battery type)

Greatest Cub Scout fan.

Thanks for keeping your cool.

You’re the coolest!

Fan-tas-tic!

GLUE OR TAPE

Thanks for sticking to it!

Thanks for helping to hold our pack together.

Thanks for getting us out of sticky situations.

BALLOON

Thanks to the person who lightens our load.

You really lift our spirits.

You rise to any occasion.

OUR EYES ARE ON YOU AWARD

For the leader who sets the example. - Glue wiggly eyes on a large felt “U”

HEADS UP AWARD

For the person who is heads above the rest. -

Use a piece of wire to mount a plastic head above a piece of wood.

HELPING HAND AWARD

For the person who is always willing to help, a latex or garden glove.

THANKS

SCOUT SPIRIT AWARD

To the person who shows Scout spirit. - A ghost made from a ball covered with a piece of white cloth or a lollipop covered with a tissue. Attach a Cub Scout sticker to the ghost.

“UDDERLY” RIDICULOUS AWARD

A blown up latex glove.

BEST FOOT FORWARD AWARD

A 12” ruler or a sock with a hole in the toe.

HEARTFELT THANKS AWARD

A large heart cut out of felt.

BEST OVERALL AWARD

A small pair of overalls with the word “Best” written on the bib.

THANKS A MILLION

A million dollars in play money.

THE TEE-RIFIC AWARD

Mount a golf tee to a plaque or certificate.

For a really tee-rific award, mount several golf tees in the shape of the letter T.

THE RIGHT ON TARGET AWARD

A paper target with the words “right on” written on one of the rings.

HUNG IN THERE AWARD

A rope tied in a noose or anything that can be hung on the wall.

THE COVETED DIME and PIN AWARD

(Say it quickly.) Glue a small safety pin to a dime.

THE PLUNGED RIGHT IN AWARD

A small sink plunger.

RECORD BREAKER AWARD

A mounted broken 45 record. (Look in your local thrift shop for these dinosaurs.)

KNOCKED YOURSELF OUT AWARD

A small hammer, a mini bat or a small pair of boxing gloves.

YOU HAVE A STAKE IN THE FUTURE OF OUR SCOUTS

A tent stake, or if you really mean it, a 2-inch thick T-bone steak.

YOU TICKLED OUR FUNNY BONE

A feather mounted to a large bone.

THE HORNBLOWER AWARD

For the person who never (or always) blows his own horn, a plastic bicycle horn.

THE RINGY DINGY AWARD

For the person who is always on the phone, a mounted plastic telephone, or two tin cans on a string.

THE BAND-AID AWARD

A large band-aid for someone who can fix anything.

THE ROPE AWARD

A length of rope for tying up loose ends.

THE ALKA SELTZER AWARD

A box of Alka Seltzer for someone who really adds fizz to your unit.

THE WHALE AWARD

A toy whale for doing a whale of a job.

PIG AWARD

A toy pig for the big HAMS.

DE-PEN-DABLE or STU-PEN-DOUS AWARD

A mounted ball point pen.

PARENT and FAMILY PARTICIPATION

Repeat after me: “Cub Scouting is a family pro-gram.” Good. Now that we’ve established that, how can we motivate, teach, or persuade parents and families to be involved in our packs?

One of the most common problems that is voiced by unit level leaders is “How do we get more parent participation?” In today’s busy world, many of our Cub Scouts are coming from homes where both parents work or from single-parent families. As Cub Scout leaders, we must be tolerant enough to realize that most parents do not deliberately neglect their growing children. But sometimes parents can become so caught up in the business of providing for their families that they may lose sight that what their children need most is some of their time and attention.



Obviously, it is not our role to lecture the parents and make them feel guilty because they are not giving enough time to their Cub Scout. And I don’t think any Cub Scout leader would want to deprive a boy of Cub Scouting just because the parents don’t give as much time as we’d like. So, what can we do?

First, realize the basic foundation and objective of a good Cub Scout pack is for the boys to have **FUN**. It would stand to reason that fun would be the motivating factor behind parent involvement.

Next, let’s look at common reasons parents give for not wanting to become involved in the Cub Scout program.

- Both parents are **employed** outside the Home.
- They are **already involved** with other activities of their children and cannot take on additional responsibilities.
- They have not had a child in Cub Scouting before, and the element of the **unknown** can be frightening.

How do we respond to these reasons?

Working parents: Since hours for Cub Scouting activities are **flexible**, there are places for everyone in the program.

Parents involved with other activities with their children: The key here is to praise them for being involved and having more than a passing interest in the welfare of their children. Then, **suggest specific jobs** and let them choose what their responsibilities and time will allow.

Unfamiliarity with the Cub Scout program: **Educate** them. When a new boy joins your pack, take time to visit with the family and give them an overview of the program. Tell them what is expected of them. Answer any questions or concerns. This visit can be made by the pack trainer, the committee chairman, the Cubmaster, the den leader or any of the above. Annual parents’ meetings allow you to discuss and explain Cub Scouting to several people at once.

POSITIONS TO INVOLVE PARENTS IN A PACK

Volunteer Position	Description of Tasks to be Accomplished
Academics Coordinator	Coordinate the academic skills programs for youth in the den or unit.
Activities	Assist in leading activities; example, craft projects, games, etc.
Activity badge Counselors	Help teach one of the Webelos activity badges.
Activity Record-keeper	Keep track of boys' participation in unit events.
Advancement Committee	Help keep award and recognition records for den or pack.
Assistant Leader	Provide support to the key leader for one of the dens.
Award Coordinator	Complete paperwork and pick up awards from Scout shop or council service center.
Back-up Parent	Help den leader as a second helper (two-deep leadership).
Birthday Coordinator	Keep track of birthdays and share with leader for recognition.
Calendar Planner	Help create and maintain the unit calendar.
Camping	Attend campouts with unit.
Campout Planner	Help in coordinating the planning for outdoor programs, especially campouts.
Car Pool	Coordinate transportation for field trips, campouts, or events.
Ceremonies Helper	Provide support during ceremonies and presentation of awards for youth and adults at unit meetings.
Child Sitter	If leader has a younger child, volunteer to help watch their child during meeting.
Commissioner	Support one or more units as a liaison with the district/council.
Construction Support	Provide support to unit in building derby tracks, props, etc.
Cubmaster or Assistant	Serve as the unit leader or assistant overseeing the pack in its program.
Day Camp	Attend camp with son and assist with den/pack.
Decorations Committee	Provide support in making of decorations at key meetings and events.
Delivery Person	Help with delivery of supplies, flyers, etc. to youth who are absent.
Den Project Helper	Assist with pre-prep work for den meeting projects (cut out patterns, make stencils, etc.)
Den Leader or Assistant	Serve as the key leader or serve as an assistant for one of the dens - Tiger, Wolf, Bear, Webelos.
Den Record Keeper	Help keep the records of advancement for all boys in the den.
Derby Committee	Serve on the derby planning and execution committee -
District Committee Member	Provide support on the district level in support of program, membership, finance, or unit service.
Driver's Information Update	Make sure all information on drivers for tour permits is updated.
Equipment Coordinator	Maintain unit equipment - ceremonial props, game equipment, etc.
Facilities Coordinator	Locate meeting places and coordinate arrangements for special events.
Family Camp Committee	Assist in making arrangements for the pack's family campout.
Field Trip Paperwork	Make sure permission slips and emergency contact forms are collected for all.
Field Trip Planner	Maintain a listing of potential field trips and help secure permission from organizations.
Field Trips	Volunteer to drive, chaperone, or arrange for den field trips.

Volunteer Position	Description of Tasks to be Accomplished
First Aid Coordinator	Be aware of health and safety issues at unit meetings and activities.
Flag Ceremony Coordinator	Provide support by working with boys in conducting the flag ceremony at den and unit meetings.
Fund-raiser Coordinator	Serve as chairperson for product sales within den or pack.
Fund-raiser Support	Help with some specific part of the unit fund-raiser.
Game Leader	Plan and provide materials for games at unit meetings.
Grocery Shopper	Coordinate purchase of food supplies for outings and meetings.
Guest Speaker Coordinator	Help secure guest speakers and presenters related to the core value of the month or event.
Historian	Keep track of events - current, past, and future.
Hobby Expert	Give a presentation to den or pack on a hobby of interest to the boys.
Holiday Party Committee	Assist in preparation for the holiday party for your den and pack.
Judge at Events	Serve as a judge for competitive events; like, derbies, Olympics, etc.
Librarian	Maintain updated literature and resources for unit.
Lifeguard	Serve as a certified lifeguard for aquatic activities.
Mailing Coordinator	Coordinate the mailing of flyers and other items about unit events.
Newsletter Editor for Unit	Coordinate the regular unit newsletter (printed and/or electronic).
Pack Committee	Serve as a committee member in support of the pack and meet monthly to help with planning.
Pack Committee Chairperson	Serve as the chairperson for the pack committee to help with coordination of pack business.
Pack Meeting Arranger	Arrive early for set-up and stay afterward for take down.
Pack Meeting Helper	Help with program at monthly pack meeting - setup, registration, etc.
Pack Record-Keeper	Help keep the records of advancement for all the boys in the pack.
Pack Trainer/Mentor	Serve as the coordinator for training of adult leaders with the unit.
Scout Parent Coordinator	Serve as Scout Parent coordinator working with all parents in pack.
Parent Talent Survey Recorder	Conduct annually a Parent Talent Survey with all parents and maintain a database of their interests.
Photographer	Take pictures or videos of events ,den meetings and pack meetings.
Popcorn Chairperson	Serve as the coordinator for the den or unit in support of the annual popcorn sale.
Poster Maker	Make posters as needed to promote events and activities of unit.
Printer	Lay out and print flyers and other promotional items for special events.
Prop Builder	Make props for activities - ceremonies, costumes, presentations, decorations, etc.
Public Relations Expert	Coordinate the writing and submission of articles to local media.
Recruitment Promoter	Help with making and distributing promotional items in community, neighborhoods, and schools.
Recycling Coordinator	Assist den or pack with recycling in community.
Refreshment Coordinator	Coordinate bringing of refreshments with the parents in your den.
Refreshment Provider	Bring refreshments to a den, pack, adult leader meetings.
Registration Coordinator	Coordinate the registration of those attending meetings or activities.
Religious Emblem Counselor	Provide support in instructing to youth for religious award for their age.

<u>Volunteer Position</u>	<u>Description of Tasks to be Accomplished</u>
Scout Expo Exhibit Committee	Assist pack with coordination of exhibit for Scout Expo or other community exhibits.
Scout Expo Ticket Specialist	Assist pack with coordination of ticket sales for Scout Expo.
Scout Sunday Coordinator	Set up details for unit participation at religious organization in February.
Seamstress	Help sew uniform patches for those needing help.
Secretary	Take notes at meeting; send out thank you notes for field trips, etc.
Service Projects Supporter	Coordinate and help organize service projects; for example, clothing or food drives.
Skills Expert	Give a presentation to the den or pack on a skill of interest to the boys for their advancement.
Skit Leader	Lead skits at a den or unit meeting.
Song Leader	Lead songs at a den or unit meeting.
Special Award Coordinator	Keep track of special awards earned - Leave No Trace, World Conservation Award, etc.
Special Events Helper	Help coordinate blue and gold banquet, holiday parties, pack outings.
Special Leader Recognition	Provide support in helping to recognize leaders of unit.
Specialized Trainer	Provide training in special skills of interest to the adults (example, swimming, first aid).
Sports Coordinator	Coordinate sports activities for pack or den - Secure equipment, referee, coach, etc.
Sports and Academics Recorder	Keep track of boys' participation in various activities for earning of belt loops and pins.
Summertime Pack Coordinator	Coordinate plans, program, and monitor participation in one of the monthly summertime pack activities.
Supply Coordinator	Coordinate purchase or collection of craft supplies for meetings.
Survey Coordinator	Help collect from all families and tabulate the results from the Parent Talent Survey.
Theme Developer	Develop ideas for activities, crafts, and such for monthly Core Values.
Equipment Transportation	Provide a trailer or transportation for equipment needed at an event.
Transportation Driver	Transport youth to and from activities.
Trip Planner	Research places to go for field trips, etc. Provide details for planning.
Uniform Exchange Coordinator	Coordinate donation of "experienced" uniforms for unit and help with distribution.
Uniform Inspection Coordinator	Help the commissioner conduct a uniform inspection during the year.
Webelos Den leader or Assistant	Serve as the key leader or assistant for one of the Webelos dens.
Webelos Transition Coordinator	Provide for a seamless transition of Webelos into Boy Scouts when the boys earn the Arrow of Light Award.
Webmaster	Maintain a unit Web-site, send reminders of upcoming events, or review BSA Web sites for information.
Woodworking Helper	Help teach and support any woodworking projects in the den or pack.

* Note: This is not a complete list of all the available tasks a parent or other adult can assist with but it provides guidance and ideas.

DO'S and DON'TS OF PARENT PARTICIPATION

DO get to know your pack parents. It is much easier to ask someone you know to assist you rather than ask a complete stranger. Use the Parent-Talent Survey found in the Cub Scout Leader Book to find out your parents' interests. Personal notes sent home with Cub Scouts or telephone calls or e-mails can encourage parental involvement.

DO have a specific request in mind when you contact a potential helper. You will get better results if you ask "Can you help with the roller skating party on May 19th?" than to say "Can you help me this year?" Everyone can identify with taking a group of boys on a roller skating party, but vague questions deal with the unknown and will be easily answered with a negative response.

If the person you ask can't help with your current request, **DO have another activity** in mind. "I'm sorry you can't help with this party because it will be a really fun event for the boys. Next month we have a swimming date planned for the boys. Can I call you to help out with that?"

DO be fair and honest with your request. If you ask a parent to take the boys roller skating, explain the time of the party and what will be expected (drive, skate with the boys, supervise snacks, etc.) If the project involves more than one day and some preparation, be specific. Don't abuse anyone's willingness to get involved.

If a parent offers help in a **specific area** such as crafts, **DO ask for help** in this capacity rather than in an area which is unfamiliar. If you put someone in an uncomfortable position, you will eventually lose their talents.

DO acknowledge someone who volunteers their time, in the form of a short and simple note or a telephone call. You could have the Cubmaster acknowledge a parent at pack meeting with a certificate or presentation. These thank-yous, while not time consuming on your part, show your volunteers you appreciate the time they have to help you.

DON'T put people **on the spot**. No matter how much we need help for a project or special event, we must leave room for a person to gracefully step aside without experiencing a guilt trip for not helping with their son's activity.

DON'T assume everyone has the same attitude and interests in Cub Scouting that you have. This certainly does not mean we should in any way refrain from offering those parents opportunities to become active and involved in our pack program. After becoming familiar with the program, interest and excitement may develop.

Not all parents want or can be full time committee members, nor do they have to be, but they should all contribute something. The list of annual events is such that a dozen parents are needed for leadership, not to mention field trip assistance, theme idea help, telephoning, equipment construction and storage, etc. Remember, this year's Pinewood Derby chairman may well be next year's pack committee chairman

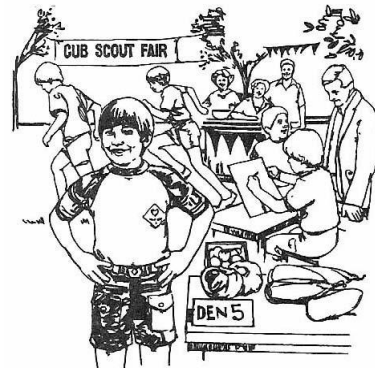

\$\$\$ and BUDGETS

Who is responsible for preparing the pack budget? The pack committee with the help of the other pack leaders and parents determine the needs of the pack. The pack committee should then meet with the charter organization to determine exactly what the charter organization will provide. The charter organization is to provide all the advancement awards. However, a joint decision needs to be made of what constitutes advancement awards. Some chartering organizations say all badges, pins, boy's handbooks, neckerchiefs, cars, mother's pins, patches, arrows, belt loops, certificates, quality unit awards, etc., are part of advancement. Other organizations interpret advancement differently and say only rank badges and Webelos activity badges are advancement. The rest then has to be provided from fundraisers or the parents and the boy.

Included in the evaluation of the budget should be the **boy and the parents**, and what they should provide. Scouting is a self-sufficient and self-reliant program. Each boy is helped to develop character if he can earn and pay his own way. Families should be urged to find ways for the boys to do small things around the house or neighborhood to earn money for his dues.

What items can the pack decide the parents and boy should provide?

Complete uniform?

Wolf, Bear, and Webelos handbooks?

Items or money to help make a craft?

Day Camp fee?

Derby supplies? (Pinewood Derby car, Raingutter Regatta boat, Space Derby rocket)

Items that the chartering organization decides they will not provide?

How do you **plan** the quantity of pins, badges, belt loops, etc., for the year? It is important to know the number of boys that will be in each den for the year and the number coming in so that you have a figure to work with in planning your budget. Also you will need to know your year-long plan as to what events you will have going on during the year.

Setting up a pack budget can be a little over-whelming. Knowing how to start a budget can take care of most of the stress. The questions to ask are:

How much money does the pack need to run for the coming year?

What were last year's total expenses?

Will the expenses be the same this year or have prices gone up?

If you can answer the last two questions, you have a basis on which to start your budget.

Consider these items and then fill out the worksheet:

- 1 Advancement awards for the boys (badges, cards) – How many boys will advance a rank this year?
- 2 Mother's pins – Does the pack provide these?
- 3 Boy's handbooks – Are they considered part of advancement or should they provide their own?
- 4 Sports and Academics belt loops and pins – Should the pack provide these?
- 5 Quality Unit Awards – Should the pack provide these?
- 6 Summertime Pack Awards – Should the pack provide these?
7. Books for leaders – How many and what do you need?
 - a. Cub Scout Leader Book (a must for every leader)
 - b. Tiger Cub, Wolf, Bear, or Webelos Handbook for leader of that particular den
 - c. Den and Pack Meeting Resource Guide(a must for every leader)
 - d. Webelos Leader Guide and Webelos Resource Book for Webelos leaders
 - e. Library of books such as: How-To Book, Pow Wow Book(s), Ceremonies for Dens and Packs, etc.
 - f. Pack Record Book

\$\$\$ and BUDGET – Continued

8. Rental or purchase of Derby tracks, – What are your resources?
9. Rental or purchase of ceremony equipment – Or do you make your own?
10. Blue and gold Banquet allowance for meal, decorations, special awards, etc.
11. Supplies to operate dens (craft supplies) – Do you reimburse your den leaders?
12. Pack meeting refreshments and incidentals – Do your families bring refreshments?

Using the **worksheet** on the next page, you can figure your budget need for the upcoming year. If the item is one that the pack does not provide, simply enter a 0 under the “Total” column on that line. Use blank spaces by “other” to enter any other expected expenses unique to your pack such as special plaques for Arrow of Light, trainings, etc.

Now that you know how much money you need, you can **consider your resources**.

What are the money resources?

From what resources was the money received from last year?

Are those resources still available this year?

If so, how much is available from those resources this year?

What are some available resources?

Most chartering organizations will usually provide a large percentage of the income of the pack. The chartering organization may also approve a **fundraiser**. Selling tickets for the Scout Expo is an approved fundraiser. Selling Trails End Popcorn is also approved. Districts or councils may approve a fundraiser or sponsor a fundraiser. Remember, a fund-raising form must be filled out, and submitted to the council for approval before Cub Scouts can sell a commodity.

Ideally, the budget should be presented at a pack meeting for the sustaining vote of the parents. They need to know what is going on and what is expected of them. Give them a chance to express their views.

A well-planned budget can make a big difference to your pack. Chartered organizations are more willing to help you meet your budget needs when they can see just where the money needs to go.



PACK BUDGET WORKSHEET

(Prices as of Sept 1, 2010. Prices subject to change without notice.)

Item	Cost	Est # of Boys	=	\$	Total
Bobcat Mother's Pin	1.29	X _____	=	\$ _____	_____
Bobcat badge	1.59	x _____	=	\$ _____	_____
Bobcat Pocket Certificate	.12	x _____	=	\$ _____	_____
Instant Recognition - 10 per kit	6.99	x _____	=	\$ _____	_____
Tiger Cub Book	6.99	x _____	=	\$ _____	_____
Tiger Cub Mother's Pin	1.29	x _____	=	\$ _____	_____
Tiger Cub badge	1.59	x _____	=	\$ _____	_____
Tiger Cub Pocket Certificate	.12	x _____	=	\$ _____	_____
Wolf Book	8.99	x _____	=	\$ _____	_____
Wolf Mother's Pin	1.29	x _____	=	\$ _____	_____
Wolf badge	1.59	x _____	=	\$ _____	_____
Wolf Pocket Certificate	.12	x _____	=	\$ _____	_____
Bear Book	8.99	x _____	=	\$ _____	_____
Bear Mother's Pin	1.29	x _____	=	\$ _____	_____
Bear badge	1.59	x _____	=	\$ _____	_____
Bear Pocket Certificate	.12	x _____	=	\$ _____	_____
Arrow Points - avg. 3 per rank/boy	.75	x _____	=	\$ _____	_____
Arrow Point Pocket Certificate	.12	x _____	=	\$ _____	_____
Webelos Book	8.99	x _____	=	\$ _____	_____
Webelos Mother's Pin	1.29	x _____	=	\$ _____	_____
Webelos badge (diamond or oval)	1.59	x _____	=	\$ _____	_____
Webelos Pocket Certificate	.12	x _____	=	\$ _____	_____
Webelos Colors	4.49	x _____	=	\$ _____	_____
Activity badges - avg. 12 per boy	1.69	x _____	=	\$ _____	_____
Activity badge Pocket Certificate	.12	x _____	=	\$ _____	_____
Compass Emblem	2.69	x _____	=	\$ _____	_____
Compass Point - 3 per boy	1.39	x _____	=	\$ _____	_____
Arrow of Light Mother's Pin	1.29	x _____	=	\$ _____	_____
Arrow of Light badge	1.59	x _____	=	\$ _____	_____
Arrow of Light Pocket Certificate	.12	x _____	=	\$ _____	_____
Arrow (Yellow)	4.50	x _____	=	\$ _____	_____
World Conservation Award	1.79	x _____	=	\$ _____	_____
Sports and Academics Belt Loops	1.79	x _____	=	\$ _____	_____
Quality Unit Award	.83	x _____	=	\$ _____	_____
Summertime Pack Award Pin	1.29	x _____	=	\$ _____	_____
Blue and gold Banquet	_____	_____	=	\$ _____	_____
Pack Meeting Treats, etc.	_____	x 12 months _____	=	\$ _____	_____
Den Leader Supplies	_____	x 12 months _____	=	\$ _____	_____
Pack Library	_____	_____	=	\$ _____	_____
Derby Rentals	_____	_____	=	\$ _____	_____
Other _____	_____	x _____	=	\$ _____	_____
Other _____	_____	x _____	=	\$ _____	_____
Other _____	_____	x _____	=	\$ _____	_____
Other _____	_____	x _____	=	\$ _____	_____
		Total Budget Needs	=	\$ _____	_____

PACK TRAINER

Years ago was called the Den Leader Coach

The pack trainer's main objective is to have 100 percent of the pack leadership trained in their position responsibilities. New leaders and adult family members should receive orientation within one week of joining the pack. Leaders should receive position-specific training as soon as the training becomes available.

POSITION QUALIFICATIONS

The pack trainer must:

- Meet BSA membership requirements and be at least 21 years of age.
- Be registered with the Boy Scouts of America as a pack trainer.

It is recommended that the pack trainer have at least one year of experience in a leadership position in Cub Scouting. Pack trainers should participate in a Trainer Development Conference.

RESPONSIBILITIES

The pack trainer is responsible for:

- Remaining current with training material and program updates
- Conducting orientation of new families
- Providing Fast Start Training to new leaders. The pack trainer should contact the new leader within two or three days to review the information and answer questions. Fast Start Training can be completed by viewing the Fast Start video or DVD or by completing the training online.
- Conducting monthly Unit Leadership Enhancements
- Encouraging pack leaders to complete/attend:

Youth Protection Training
Fast Start Training
Cub Scout Leader Specific Training
This is Scouting
Health and Safety Training

Roundtable
Pow Wow
Outdoor Webelos Leader Skills (OWL/North Star)
Akela's Council
Wood Badge

- Encouraging den chiefs to attend Den Chief Training
- Maintaining pack training records

POSITION SUMMARY

Under the direction of the pack committee chairman, the pack trainer helps leaders and parents understand purposes, policies, and procedures of the Cub Scouting program. The pack trainer conducts, or facilitates, the training of leaders and parents in the pack. The pack trainer promotes training to help leaders learn to plan and conduct pack and den meetings and activities. The pack trainer orients parents and leaders and guides pack leaders in carrying out their specific position responsibilities. Pack Trainer is a registered position.



TRAINING FOR CUB SCOUT LEADERS

1) YOUTH PROTECTION TRAINING - Every leader in Cub Scouting should complete Youth Protection training before they register with the BSA (as of 6/1/10) Proof of course completion is required to be turned in with your adult application. It is available online by following the links on our council web site (www.utahscouts.org) or at www.myscouting.org. Parents will also find this training valuable. In addition to a thorough review of BSA Youth Protection policies, the training develops an increased awareness of Youth Protection issues. Completion of Youth Protection training is a requirement for all awards in the Cub Scout leader recognition plan. Leaders must recertify in this training every 2 years.

2) FAST START TRAINING - As the next step in the training process, Fast Start Training is meant to provide all the information and resources for new leaders to conduct their first meeting, along with guidance for the meetings that follow. Cub Scout Fast Start Training is also available on DVD and online at myscouting.org. There is also a DVD version available from the council office.

Basic leader training - Basic Leader Training is designed to give position-related information to all adult leaders in Cub Scouting. Building on the foundation established in Fast Start Training, Basic Leader Training goes into greater detail. Basic Leader Training has two parts which are both available online at myscouting.org; and occasionally at the district and council levels.



3) THIS IS SCOUTING is for **all leaders** in Cub Scouting, Boy Scouting, Varsity Scouting and Venturing. It highlights the values, aims, history, and methods of the Scouting program. Once completed it need not be taken again even if the leader moves to a different position or program level.

4) LEADER SPECIFIC TRAINING gives a leader the knowledge and skills needed for a specific position. Leader Specific Training is available for all Tiger Cub, Cub Scout and Webelos den leaders; Cubmasters and assistants; Pack Committee members and Pack Trainers.

Every Cub Scout leader should complete their training shortly after accepting the position; it prepares him or her to deliver a quality, fun-filled program. Upon completion of these four training courses, all Cub Scout leaders are considered to be trained and are eligible to wear the trained leader emblem on their uniform.



MyScouting.org

– Is a Cub Scout leader’s “one stop shop” for training. Once you have created yourself an account there are lots of training courses available to take. As of Aug 2010, a new Cub Scout leader can go online (any time of day or night, dressed or in your PJ’s) and take all four of the required training courses required to wear the trained patch. It can’t get any easier than that. Check out the other online training courses like Safe Swim Defense, Safety Afloat, Hazardous Weather, and many more.

A wise leader knows there is always more to learn and improvement to be made as a leader. Training is an ongoing process. We need to continually be looking for new information, new training opportunities.

ON-GOING and SUPPLEMENTAL TRAININGS

ROUNDTABLE - A “Monthly Must” for every leader. - Roundtables are held monthly on a district basis and usually last from 1-1/2 to 2 hours. Den and pack leaders join for fun and fellow-ship while learning new tricks, stunts, games, crafts, ceremonies, songs and skits related to the Cub Scout Core Values and Webelos activity badges for the following month. This also provides opportunities for sharing ideas and activities with leaders from other packs. This is a place to get the latest most up to date information from the district and council. Attendance is required for leader awards.

UNIT LEADERSHIP ENHANCEMENTS - This training is conducted by a member of the pack leadership team as a part of the monthly pack leaders’ meeting. Enhancements are short training discussions intended to help leaders be better prepared to deliver a quality Cub Scouting program to their boys. Pack leaders can choose from among 15 topics starting on page 167 of the Cub Scout Leader Book

POW WOW – A yearly renewal of “The big picture” - Cub Scout Pow Wow is an annual one-day training filled with fun and exciting things to do and learn, and is held on the district level in the Utah National Parks Council. There are classes for every leader in your pack to attend including crafts, ceremonies, derbies and much more. Leaders are able to select which classes they want to attend and interact with other Cub Scout leaders from other packs in their communities.



OUTDOOR SKILLS FOR WEBELOS DEN LEADERS (OWL) - Outdoor Training is required for the Webelos den leader award. This course teaches out-door skills through demonstration and hands-on practice. In some districts you may attend **North Star** Training to fulfill this requirement

HEALTH and SAFETY TRAINING - Safety is always of paramount concern within the BSA and the Utah National Parks Council. Volunteer leaders are entrusted with the health and safety of youth and adults participating in any Scouting activity. This course emphasizes the importance of qualified supervision, discipline and common sense in ensuring the safety of all participants involved in scouting activities. Some districts in our council require at least one adult leader to be certified in this training and to be present at the unit activity before their unit can receive a tour permit for its Scouting activity. In the near future, this policy will become a council-wide policy. Leaders need to recertify in this training every two years.



AKELA'S COUNCIL - This is an annual course that is sponsored by the Utah National Parks Council for all Cub Scout leaders. It is held each summer and picks up where Basic Training ended. Participants are immersed in the Cub Scout program by living it for 4-1/2 days in their respective dens. Participants will learn in a hands-on environment all about resources, relationships, BSA policies, pack and den management, charter renewal, uniforms, den yells, den doodles, skits, puppets, Academics and Sports program, games, songs and so much more.

WOOD BADGE - is an advanced training course. All Cub Scout, Boy Scout, Varsity Scout and Venturing leaders may attend Wood Badge. Several courses are scheduled each year at various locations throughout the council (usually between Apr and Sept). Participants learn leadership skills and techniques that can be used to improve their program when the leader returns home. Wood Badge is a 5-1/2 day training course sponsored by our council.



A NOTE ABOUT TRAINING

The key to being a good Cub Scout leader is Training. Getting the right training can make ALL the difference in how much time you spend preparing and in how well it goes. There is no organization better prepared to train its volunteers than the BSA. There is help at every turn! The Cub Scout motto is “Do Your Best” We should set the example and do all we can to be the best Cub Scout Leader we can for them.

You have probably heard it said that...



**Every boy
deserves a
well-trained
Leader!**

Have you also heard that...

Every Leader deserves to be well trained!

If you feel that your district’s roundtables or other trainings events are not as good as you need/want them to be so that you can be a well-trained leader –

VOLUNTEER TO HELP!

Remember - the BSA is a volunteer organization. We all have families, jobs, lives and other things to do outside of Cub Scouting. The more of us there are to carry the load the easier it is on everyone!



Your district wants **YOU!**

THE SWEET SIXTEEN OF BSA SAFETY

(From the Guide to Safe Scouting – available online at scouting.org)

Few youth organizations encompass the breadth, volume and diversity of physical activity common to Scouting, and none enjoy a better safety record. **The key to maintaining and improving this exemplary record is the conscientious and trained adult leader who is attentive to safety concerns.**

The BSA National Health and Safety Committee and the Council Services Division of the BSA National Council have developed the "Sweet Sixteen" of BSA safety procedures for physical activity. These 16 points, which embody good judgment and common sense, are applicable to all activities. All leaders should review and comply with such guidelines in the respective activities.

1. QUALIFIED SUPERVISION - Every BSA activity should be supervised by a conscientious adult who understands and knowingly accepts responsibility for the well-being and safety of the children and youth in his or her care. The supervisor should be sufficiently trained, experienced and skilled in the activity to be confident of his/her ability to lead and to teach the necessary skills and to respond effectively in the event of an emergency. Field knowledge of all applicable BSA standards and a commitment to implement and follow BSA policy and procedures are essential parts of the supervisor's qualifications.

2. PHYSICAL FITNESS - For youth participants in any potentially strenuous activity, the supervisor should receive a complete health history from a health care professional, parent or guardian. Adult participants and youth involved in higher-risk activity (e.g., scuba) may require professional evaluation in addition to the health history. The supervisor should adjust all supervision, discipline and protection to anticipate potential risks associated with individual health conditions. Neither youth nor adults should participate in activity for which they are unfit. To do so would place both the individual and others at risk.

3. BUDDY SYSTEM - The long history of the "buddy system" in Scouting has shown that it is always best to have at least one other person with you and aware at all times as to your circumstances and what you are doing in any outdoor or strenuous activity.

4. SAFE AREA OR COURSE - A key part of the supervisor's responsibility is to know the area or course for the activity and to determine that it is well-suited and free of hazards.

5. EQUIPMENT SELECTION AND MAINTENANCE - Most activity requires some specialized equipment. The equipment should be selected to suit the participant and the activity and to include appropriate safety and program features. The supervisor should also check equipment to determine that it is in good condition for the activity and is properly maintained while in use.

6. PERSONAL SAFETY EQUIPMENT - The supervisor must ensure that every participant has and uses the appropriate personal safety equipment. For example, activity afloat requires a PFD properly worn by each participant; bikers, horseback riders, and whitewater kayakers need helmets for certain activity; skaters may need protective gear; and all need to be dressed for warmth and utility depending on the circumstances.

SWEET 16 Continued

7. SAFETY PROCEDURES AND POLICIES - For most activities there are common sense procedures and standards that can greatly reduce the risk. These should be known and appreciated by all participants, and the supervisor must ensure compliance.

8. SKILL LEVEL LIMITS - There is a minimum skill level requirement for every activity, and the supervisor must identify and recognize this minimum skill level and be sure that none are put at risk by attempting activity beyond their ability. A good example of skill levels in Scouting is the venerable "swim test" which defines conditions for safe swimming based on individual ability.

9. WEATHER CHECK - The risk factors in many outdoor activities vary substantially with weather conditions. These variables and the appropriate response should be understood and anticipated.

10. PLANNING - Safe activity follows a plan that has been conscientiously developed by the experienced supervisor or other competent source. Good planning minimizes risks and also anticipates contingencies that may require emergency response or a change of plan.

11. COMMUNICATIONS - The supervisor needs to be able to communicate effectively with participants as needed during the activity. Emergency communications also need to be considered in advance for any foreseeable contingencies.

12. PERMIT AND NOTICES - BSA tour permits, council office registration, government or landowner authorization, and any similar formalities are the supervisor's responsibility when such are required. Appropriate notification should be directed to parents, enforcement authorities, landowners, and others as needed, before and after the activity.

13. FIRST AID RESOURCES - The supervisor should determine what first aid supplies to include among the activity equipment. The level of first aid training and skill appropriate for the activity should also be considered. An extended trek over remote terrain obviously may require more first aid resources and capabilities than an afternoon activity in the local community. Whatever is determined to be needed should be available.

14. APPLICABLE LAWS - BSA safety policies generally parallel or go beyond legal mandates, but the supervisor should confirm and ensure compliance with all applicable regulations or statutes.

15. CPR RESOURCE - Any strenuous activity or remote trek could present a cardiac emergency. Aquatic programs may involve cardiopulmonary emergencies. The BSA strongly recommends that a CPR-trained person (preferably an adult) be part of the leadership for any BSA program. Such a resource should be available for strenuous outdoor activity.

16. DISCIPLINE - No supervisor is effective if he or she cannot control the activity and the individual participants. Youth must respect their leader and follow his or her direction.

UNIT COMMISSIONERS



COMMISSIONERS—IN THE BOY SCOUTS OF AMERICA

Commissioners are district and council leaders who help Scout units succeed. They coach and consult with adult leaders of Cub Scout packs, Boy Scout troops, and Venturing crews. Commissioners help maintain the standards of the Boy Scouts of America. They also oversee the unit charter renewal plan so that each unit reregisters on time with an optimum number of youth and adult members.

ROLES THE COMMISSIONER PLAYS

A commissioner plays several roles, including friend, representative, unit "doctor," teacher, and counselor.

The commissioner is a **friend** of the unit. Of all their roles, this one is the most important. It springs from the attitude, "I care, I am here to help. What can I do for you?" Caring is the ingredient that makes commissioner service successful. He or she is an advocate of unit needs. A commissioner who makes himself known and accepted now will be called on in future times of trouble.

The commissioner is a **representative**. The average unit leader is totally occupied in working with kids. Some have little if any contact with the Boy Scouts of America other than a commissioner's visit to their meeting. To them, the commissioner may be the BSA. The commissioner helps represent the ideals, the principles, and the policies of the Scouting movement.

The commissioner is a unit **"doctor."** In their role as "doctor," they know that prevention is better than a cure, so they try to see that their units make good "health practices" a way of life. When problems arise, and they will even in the best unit, they act quickly. They observe symptoms, diagnose the real ailment, prescribe a remedy, and follow up on the patient.

The commissioner is a **teacher**. As a commissioner, they will have a wonderful opportunity to participate in the growth of unit leaders by sharing knowledge with them. They teach not just in an academic environment, but where it counts most—as an immediate response to a need to know. That is the best adult learning situation since the lesson is instantly reinforced by practical application of the new knowledge.

The commissioner is a **counselor**. As a Scouting counselor, they will help units solve their own problems. Counseling is the best role when unit leaders don't recognize a problem and where solutions are not clear-cut. Everyone needs counseling from time to time, even experienced leaders.



CUB SCOUTING AND THE COMMISSIONER

From “The Commissioner” spring 2003 by John Fooks,

Cub Scouting is our entry-level program. First impressions are pretty important to a boy and his family. Cub Scouting is a five-year program; that’s an awesome opportunity to influence a boy — so Cub Scout retention is important. Eighty seven percent of Boy Scouts have been Cub Scouts, thus healthy packs also influence Boy Scouts. Yes, a boy’s first year in the program is critical!

Cub Scouting action ideas for Commissioners:

1. **The den meeting.** Fellow commissioners, let’s start with square one— uno— first—primarily— foremost—
Let’s set aside every other aspect of Cub Scouting for a moment and start exactly at the point where boys really receive the greatest values of Cub Scouting. That’s in the den!
 - Have your pack leaders do a den health check.
 - Are den meetings fun and attention-grabbing?
 - Do all den leaders plan meetings in advance using the Cub Scout Den Meeting Program Sheet?
 - Are the dens retaining their youth members?
 - Talk with the Cubmaster to be sure each den leader is the best kind of person to work directly with boys.
 - Is every new boy quickly assigned to a den?
2. **Promote Den visibility** outside of homes and church basements in uniform. Good visibility helps boys feel good about being Cub Scouts and encourages other families to join.
 - Suggest age-appropriate community service projects to den and pack leaders.
 - Discuss with pack leaders the kinds of den activities and trips that are fun and exciting for boys.
3. **Give priority to packs that need the most help.** Identify the “hurry cases” which are unit life-threatening.
Then quickly administer the correct “first aid”:
 - Dens not meeting
 - Pack with missing den leaders or Cubmaster
 - Pack with no committee
 - Pack with no new Cub Scouts
 - Pack conflict with its chartered organization
 - Den or pack with weak leadership
 - Dens that are continually losing youth members (see pages 28-31 of Commissioner Fieldbook)
4. At district commissioner staff meetings, be sure adequate time is set aside for **Assistant District Commissioner and their respective teams of unit commissioners to review the health of each pack and plan who will help meet specific unit needs during the month ahead.**
5. **Be sure all den leaders and Cub-masters have Basic Leader Training.**
 - Check the record—Who still needs their training?
 - If the pack has a pack trainer, with the Cubmaster or pack committee chair, guide the pack trainer in his/her training promotion responsibilities.
 - As a last resort, take leaders to training.
 - As a last, last resort, bring training to the pack.
6. **Be sure advancement is happening. Boys who advance usually stay in the pack!**
 - Be sure pack leaders show parents how they help their sons advance.
 - Be sure den leaders fill den meetings with activities that help boys advance.
 - Are advancement records kept and displayed in den and pack meetings?
 - Help pack leaders give boys prompt recognition in colorful ceremonies.

CUB SCOUTING AND THE COMMISSIONER – Continued

7. **Packs with summertime activities usually have a high boy retention rate!**
 - Be sure your packs plan a pack out-door activity and/or pack meeting in June, July, and August that will encourage dens to meet all summer.
 - Encourage packs to earn the National Summertime Pack Award.
 - Help your packs take advantage of the wonderful world of resident Cub Scout camp.
8. At charter renewal time you should **help with the membership inventory**. Be sure to help pack leaders **examine why any Cub Scout has been left off the renewal form**.
9. **Unit commissioners should periodically visit pack leader meetings** as well as pack meetings to determine how well packs are delivering fun and meaningful program to boys.

RESOURCES and TOOLS FOR THE UNIT COMMISSIONER

TRAINING: Just like every other Cub Scout leader a Unit Commissioner needs to be trained.

- 1) **Youth Protection Training** – available online at www.myscouting.org
- 2) **Fast Start Training for Unit Commissioners** – also available online.
- 3) **This is Scouting** – available online
- 4) **Leader Specific Training** – There is specific training for Unit Commissioners. Contact your district or council to see when that is being offered. (If you are new to Cub Scouting you would benefit from the Cub Scout Leader Specific Training that is available online)
- 5) **Commissioner College** – advanced training specifically for Commissioners (see council website for dates)

BSA LITERATURE and FORMS – The BSA has specific resources for your position. Some are available to download online.

- Commissioner Fieldbook** for Unit Service - Consider this handy book the commissioner's best friend, the book every commissioner should own.
- Commissioner Helps** - is full of handy tips on helping packs upgrade pack program.
- Unit Commissioners Worksheet** - helps commissioners identify the parts of pack operation that need help.
- Cub Scout Den and Pack Meeting Resource Guide** - has complete plans for den and pack meetings.
- Cub Scout Leader Book** - an essential reference for Cub Scout leaders on program planning, activities, and guidelines on every aspect of Cub Scouting.

ONLINE TOOLS and RESOURCES: The National website (www.scouting.org) has an entire section just for Commissioners with tools and resources such as:

- Commissioner Manuals** – many of those listed above are available to download at scouting.org
- Commissioner's Podcast** – Nothing new but has links to older still relevant topics.
- Unit Visit Tracking System** – Helps track and report your visits to units. (myscouting.org)
- And more... go online and check it out today!**

Don't forget to check the commissioner's tab on our Council website (www.utahscouts.org) for a listing of upcoming training opportunities, and other information.

Use your resources online to be "in the know" and be able to pass on current and correct information to the packs under your commission. You are there to be their friend, to watch, evaluate and to be ready to throw them a lifeline should they need one. You may also present leader awards, help with rechartering and lead a charter presentation ceremony.

CHARTER PRESENTATION CEREMONIES

The presentation of a pack charter to a chartered organization is very important. It should be an outstanding occasion, impressive but not too long.

The installation or charter presentation ceremony should be held in conjunction with a regular meeting of the chartered organization. If it is impossible to hold the ceremony during a meeting of the organization, be sure that organization officials and members are urged to attend, whenever it is held.

In some cases it may become necessary to include the ceremony in the pack meeting.

It is the responsibility of your district commissioner staff to prepare for and conduct the installation or charter presentation. When your pack's charter review meeting is held, your chartered organization representative should be ready to announce the date the chartered organization would like to have the charter presented. Discuss this with your unit commissioner.

The unit commissioner conducts the presentation of the charter to the head of the chartered organization, and makes appropriate remarks on the responsibilities involved. The unit commissioner also installs the chartered organization representative, the pack committee, and the leaders, and reviews their responsibilities.

If the pack is eligible for annual program awards, the unit commissioner or council representative explains what they are and presents them to the pack.

If the pack is new, leaders will induct new members. If the chartered organization is a religious body, there are available impressive church investiture ceremonies. Check with your local council service center or write the Relationships Division, S226, Boy Scouts of America, 1325 West Walnut Hill Lane, P.O. Box 152079, Irving, TX 75015-2079.

The pack leaders explain duties of den leaders and den chiefs, and present them their badges of office. The pack may then put on a program in which the leaders tell of the pack's plans, and request cooperation of parents and the chartered organization.

STANDARD CHARTER PRESENTATION

Chartered Organization Representative: Tonight we have the pleasure of renewing an obligation to the youth of our area, which this organization first assumed in [year], namely, the rechartering of our Cub Scout pack. It gives me a great deal of pleasure to introduce to you [name], who serves as [title] and who will now present to us our charter.

Commissioner: Thank you, [name]. I would like at this time to congratulate the [name of chartered organization] on the way they have assumed and carried out this obligation as the chartered organization for Pack [number]. I'm sure everyone here is aware that the Boy Scouts of America issues a charter to an organization to operate a Scouting unit as part of the organization's program. I want to express the council's appreciation to [name of chartered organization] for the cooperation it has given in fulfilling this program. Now, [name], the chartered organization representative, and [name], pack chairman, please come forward. (They do.) The Boy Scouts of America is chartered by Congress, and has been since 1915.

STANDARD CHARTER PRESENTATION - Continued

The Boy Scouts of America in turn charters your organization to carry out the full Scouting program. I hope [name of chartered organization] will continue to look upon Scouting as an important part of its program. [Name], chartered organization representative, it is with a great deal of pleasure that I now present to you the charter for Cub Scout Pack [number] for [year], and I wish your pack a happy and successful Cub Scout program in the coming year.

Chartered Organization Representative: Thank you. I can assure you that [name of chartered organization] will continue to carry out the Scouting program and will cooperate fully to see that the program is a success.

Commissioner: [Name], as chartered organization representative it is your responsibility to serve as liaison between the pack and the chartered organization and to help bring the two groups together to establish and maintain a good relationship. You are also the official link with the [name of local council] and [name of local district] through your capacity as district committee member.

Also, it is your duty to keep your committees recruited to full strength with able, active men and women; to see that your chartered organization is regularly informed on the work of its units; to see that the unit leaders receive recognition; and to bring to the district committee the needs and desires, problems and successes of your unit. Will you in the coming year carry out these responsibilities?

Chartered Organization Representative: I will. (The commissioner presents the membership card and shakes hands.)

Commissioner: [Name], as chairman of the pack committee your job is to work closely with the pack and direct the work of the pack committee. Will you in the coming year carry out these responsibilities?

Chairman: I will. (The commissioner presents the membership card and shakes hands.)

Commissioner: Ladies and gentlemen, it is the responsibility of the pack committee to select a Cubmaster and one or more assistants. In addition, the committee is responsible for proper facilities for the pack meetings and pack finances. In the event that the pack is without a leader, it is the responsibility of the committee to carry on the activities of the pack. Will you as a committee assume these responsibilities for the coming year?

Committee: We will. (The commissioner presents each with a membership card.)

Commissioner: Will [name], the Cubmaster, and assistant(s), [name], come forward please. Ladies and gentlemen, to you, along with the pack committee, we are entrusting the responsibility of guiding our youth through the Scouting program. On your shoulders rests the future of tomorrow's citizens. Are you prepared to accept this responsibility?

Leaders: We are. (The commissioner presents each with a membership card.)

Commissioner: It is always a pleasure to present a charter to an organization that has such a fine tradition of Scouting as Pack [number]. I wish you continued success in carrying on this tradition.

CANDLELIGHT CHARTER PRESENTATION CEREMONY

The charter is presented to a representative of the chartered organization at one of its meetings.

PERSONNEL: Unit commissioner, chartered organization representative, Cubmaster, pack committee chairman, seven Cub Scouts.

EQUIPMENT: Seven flashlights, the lens of one covered with blue tissue paper and the other six covered with yellow tissue paper (or plastic wrap).

ARRANGEMENT: The Cubmaster calls the meeting to order.

(The first Cub Scout lights the blue light.)

Pack Committee Chairman: This blue light represents the spirit of Cub Scouting. May it ever burn brightly.

2nd Cub Scout: (Lights yellow light.) I promise to do my best to do my duty to God and my country,

3rd Cub Scout: (Lights yellow light.) To help other people....

4th Cub Scout: (Lights yellow light.) And to obey the Law of the Pack. (The other three Cub Scouts come forward. No. 5 holds the charter.)

Commissioner: (To chairman.) In presenting this charter to [name of chartered organization], I ask if the pack committee agrees to work with and recruit the best adult leadership available, to conduct regular monthly pack leaders' meetings, and to assist the Cubmaster?

Chairman: We will.

Commissioner: (To the chartered organization representative.) Do you, as the representative of the chartered organization, promise to serve boys by providing the best leadership available; to keep informed of this pack's condition and performance, and relay this to your organization regularly; to see that the best possible Cub Scouting gets to these boys through adherence to the rules and regulations set forth by the Boy Scouts of America and the [local council]; and to place this charter in a prominent place for all to see that this organization operates Pack _____ ?

Chartered Organization Representative: I do promise.

(The fifth Cub Scout then gives the charter to the chartered organization representative and salutes him.)

5th Cub Scout: (Lights yellow light.) The Cub Scout follows Akela.

6th Cub Scout: (Lights yellow light.) The Cub Scout helps the pack go.

7th Cub Scout: (Lights yellow light.) The pack helps the Cub Scout grow. The Cub Scout gives goodwill.

(The Cubmaster and Cub Scouts leave with lights still burning.)

SCOUTING FOR THE “DIFFERENTLY-ABLED”

Since Cub Scouting challenges each boy to do his best – not to be the best – it’s a great place for boys with disabilities. The program is easily adaptable to every boy, and the sheer variety of activities means that just about every Cub Scout will discover something he excels at. (*Cub Scout Leader Book* pg. 23) In the new *Cub Scout Leader Book* it is divided into four different categories...Abilities and Disabilities, Categories of Disabilities, Understanding Disabilities, and General Guidelines...pages 23-24.

Cub Scouting is for boys and each boy is different. Cubs come in all sizes, shapes, colors and from a variety of backgrounds. There are no “average” boys and that’s why cub scouting is easily adaptable to a boy with physical, mental, or emotional limitations. Cub Scout leaders need to recognize the abilities of ALL Cub Scouts and how to adapt the Cub Scout program for those who are differently-abled.

“Differently”-abled vs. “Dis”-abled?

What do you think of when you hear the word disabled? We may think of such things as: learning, physical, developmental or emotional disabilities. It is important to understand these disabilities. Cub Scouts with disabilities have the same **needs** and **desires** to achieve as any other Cub. It may be necessary to make some special accommodations for the disabled Cub to participate...it is **well worth** the extra effort. For example... a scout who was recovering from a brain tumor couldn’t do a push-up. His scout leader figured what it would take him to bench press the weight that would be equivalent. He was then able to accomplish this part of the Cub Scout program by simply adapting it to an ability he could do.

Adjusting the program so that a boy with a disability can participate

There are excellent publications to help leaders adjust the program so that a boy with a disability can participate. A great resource is the “Scouting for Youth with Disabilities Manual”. This handbook can be found at your local Scout store. The family is the primary resource as well as advocates for their Cub. Communication is the main key. Working as a team can help your Cubs be successful. We should all exercise **kindness** and **patience** with all our cubs. It’s all about the **ATTITUDE!** If we just remember that ... the disabled **Cub Scout is more LIKE than UNLIKE other boys.**

Remember to not use Disabilities as labels or excuses

Cub Scouts with disabilities and their parents may get offended because of how others react to them. The boys may feel unenthusiastic, unhelpful, off-put, pessimistic, downbeat, gloomy, negative, and like they are not welcomed. Everyone has feelings that could get hurt very easily. Let’s use the term “differently-abled” instead of “dis-abled”. Let’s think of it this way...**If you pity – they resent, if you’re kind – they respond.** Making changes in a scouting activity can mean the difference between success and failure.

Timeless Values

Use common sense. Treat them with respect and dignity.

Be understanding. People with disabilities have the same responsibilities and obligations that you have (theirs might be harder to meet!)

Be patient. Don’t hurry; try to match their pace.

Be natural. Don’t worry about using words related to the disability.

Eye contact. Speak directly to the person, not to his companion.

Don’t assume the person is sick. Most people with disabilities are healthy. You can’t “catch” a disability.

Help make your community accessible. Are your meeting places easily accessible? Campsites? Do you have service opportunities?

Remember...cubs do not feel unfortunate since they have nothing to compare. If they have lived in a wheel chair all their life, they do not know what it is to run. A differently-abled cub in a den or a pack can also help others learn and understand these abilities.

Another way to understand abilities is to observe cubs participating in activities and interacting with other cubs. As leaders, you may not have any “differently-abled” cubs in your dens now, but you may in the future. The principles of a “CAN Do Attitude” will work with all the Cubs in your pack, regardless of abilities. We need to accept each boy for who he is and what he can contribute. Offer friendship and encouragement. Try not to overprotect or under assist boys who have special needs. Treat them as closely as possible as to how you would treat others, allowing for their special needs only when necessary.

The standard we hold for all our Cub Scouts is DO YOUR BEST. Is my best the same as yours? No. No boys’ level of achievement should be used as a measuring stick for another boy. Celebrate improvement or when you determine a boy has done his best. Cubs need to feel “I CAN DO THAT”. The program is flexible and should only be modified when necessary. **Provide challenges – don’t make things too easy.**

BSA is continually adding materials on this subject, it is not possible to list what publications will be available at the time of your need, so be sure to check with the Scout Shop and see what resources are available.

GENERAL GUIDELINES

(Cub Scout Leader Book pg. 24)

1. Follow the Cub Scout motto, “Do Your Best.”
2. Use available resources, including people, materials, the pack committee, other organizations, the boy’s parents and the other boys in the den.
3. Preplan all activities, especially outdoor activities and field trips. Is the site accessible for everyone in the group? Are the activities accessible for everyone in the group? What special accommodations are needed? Are any special health or safety issues involved for any person in the group?
4. Plan activities to include all ability levels, because each boy develops at his own rate.
5. Emphasize individual abilities while making necessary allowances for areas of need.
6. Simplify instructions and activities.
7. Use a variety of instructions for each activity. Verbal instructions with a demonstration may help teach the boys. Sometimes, it is good for boys to figure out how to do something on their own.
8. Keep a good supply of “filler” activities on hand for times when an activity ends early or you need a short activity to fill time.
9. Keep quiet activities quiet, but not inactive. A discussion will hold boys’ attention for only a short time.
10. When working with a new group of boys, start with simple, easier activities until each boy’s abilities are apparent.
11. Include ethical decision-making activities to help build a cooperative and understanding spirit in the den.
12. Promote awareness and acceptance of diversity in the group.
13. Practice new skills, such as ceremonies, skits and songs, in the den before using them at a pack meeting. Boys need the opportunity to build their self-confidence in a small cooperative group before using the skill in a large group.



People with disabilities want to be treated like everyone else.

DISABILITY AWARENESS GAMES

(From Heart of America Council)

By using some of these activities we can give our Cub Scouts a way to connect to and better understand others who have special needs.

- **Wear glasses that have been smeared with Vaseline to simulate impaired vision.** *What did you experience while wearing the glasses? What did you learn about yourself? What was the purpose of trying the glasses?*
- **Use a balance board with a circular board with an “x” below also circular, to simulate inner ear problems.** (see teeterboard jousting in the *How-To Book*)
What did you like about this exercise? How did you feel while standing on the board? What did you learn?
- **Set up a blind man’s maze, using wooden timbers to layout the maze. Each Cub was blindfolded, given a stick to tap out his way, and turned loose in the maze.**
What would you do differently in this exercise? How did you feel when you started to get around? What did you learn?
- **Type out the Cub Scout Promise and the Law of the Pack on computer then use a font to change the words to symbols such as MT Extra, Mobile, Cairo, Webdings, Symbols, Zapf Dingbats. Have the boys figure out what they say.**
What was the best part of this activity? Why do you think this activity was a good idea to do?
- **Fill a bowl with pony beads and add 1 or 2 slightly larger different colored beads. The object is to pick out the larger bead of a specific color.** The boys will always pick up one of the larger beads, but not necessarily the right color.
What was the purpose of this game? What did you learn about yourself?



These are activities that are designed to give the boys the chance to experience the frustrations faced daily by people with disabilities. Unless a person has experienced a disability we really have no idea what others face day to day.

Treat the disabled Scout with all the respect and consideration that you do with other Scouts. If a game being played requires a blindfold, the blind or visually impaired Scout should be given one as well. If the Scout is in a wheelchair, don’t stand over him to talk to him, bend down to communicate face to face. If a hearing impaired scout has a signer, respond to the Scout not the signer. Our Scouts look to us to set the example.

Cub Scout



Patches and Awards

The Council tries to keep an updated list of patches that are available on their website at www.utahscouts.org. If you know of others not listed here (or there) please let them know about it.

This section lists many of the patches and awards that Cub Scouts and Cub Scout leaders can earn. We have tried to provide a picture of the patch, the name and requirements for the patch. Some of the awards listed here are BSA awards and others are patches specific to the Utah National Parks Council or other nearby councils. If a family travels to another state there may be a patch that the cub scout can earn there as well (from a museum, a national park etc...) It never hurts to ask. A patch collection can be fun. Cub Scout Leader Recognition Awards (Knots) are at the end.

UNPC CENTENNIAL AWARD PROGRAM

An award called the Utah National Parks Council Centennial Award can be earned by both Scouting youth and adults who faithfully participate in their regularly scheduled Scouting program. This award focuses on five areas: **Leadership, Achievement, Community Service, Character and Environment Stewardship**



The Utah National Parks Council Centennial Award includes a patch and a series of six pins. Any youth or adult can earn the series of pins. The patch and pins are available at any of the Scout Service Centers throughout the council. Five of the pins are yearly pins which can be earned during the specified year. The sixth pin - the MacLaren tartan or Mentoring pin – can be earned by attending or staffing an advanced training course anytime during the five year centennial celebration. (Like Akela’s Council or Woodbadge)

From 2008-2012, youth and adults can earn a Centennial pin by completing the following requirements. You may earn this pin each year and the pin may be attached to your Centennial patch. Leaders who have viewed the online training, found on the Council website, are qualified to sign off requirements. For more information, go to www.utahscouts.org.

2012 will be the last year to earn this award!

Youth Award Requirements

To earn a commemorative pin, you must do the following during the specified calendar year: Complete all the required (R) and complete at least: 7 electives for Cub Scouts At least one from each category.

Leadership

Required: (R) Be a properly registered Scout.

Electives (choose at least one):

1. Show leadership by teaching a skill at a Scouting activity.
2. Represent Scouting by participating in a community event.
3. Attend or staff a Junior Leader Training event.
4. Become a member of the Order of the Arrow or have the Order of Arrow participate in a unit meeting.
5. Plan and carry out a centennial-themed leadership activity.

Achievement

Required: (R) Earn a rank advancement or recognition.

Electives (choose at least one):

1. Earn a Scouting award not required for advancement.
2. Earn a second rank advancement.
3. Earn the “Trained” patch for your position.
4. Record and share a significant personal, Scouting or community achievement.
5. Plan and carry out a centennial-themed achievement activity.

Community Service

Required: (R) Give four hours of community service, in uniform when appropriate.

Electives (choose at least one):

1. Participate in a council-approved service activity (separate from the four required hours).
2. Visit with another community service organization and discuss with them their objectives.
3. Record and share a significant act of service.
4. Earn a Citizenship merit badge or achievement.
5. Plan and carry out a centennial-themed community service activity.

Character

Required: (R) Attend the Annual Parent Night or review Youth Protection information in your handbook with a parent or leader.

Electives (choose at least one):

1. Wear your uniform to at least 50% of your unit’s meetings, events and activities.
2. Earn a religious award or complete one year’s requirements towards a multi-year award.
3. Record and share a significant act of patriotism.
4. Help plan and carry out a Centennial-themed Character activity.

UNPC Celebration and Centennial Award - Continued

Environmental Stewardship

Required: (R) Participate in an environmental stewardship activity with your unit (must be separate from other Required or Elective Requirements).

Electives (choose at least one):

1. Attend a district, council or National BSA-sponsored outdoor activity or camp.

2. Become a member of the Order of the Arrow or earn the National Camping Award.
3. Earn an environmental stewardship award.
4. Visit with another environmental stewardship organization and discuss with them their objectives.
5. Plan and carry out a centennial-themed environmental stewardship activity.

Adult Award Requirements

To earn a commemorative pin, you must do the following during the specified year: Complete all the required (R) and complete at least 10 electives. At least one from each category.

Leadership

Required: (R) Be a properly registered adult leader.

Electives (choose at least one):

1. Take or renew a supplemental training course.
2. Represent Scouting by participating in a community event.
3. Attend or staff a leadership training course, or staff a district or council event.
4. Develop or facilitate a youth-led unit.
5. Participate as a member of the OA.
6. Plan and carry out a centennial-themed leadership activity.

Achievement

Required: (R) Be a "Trained" leader for your position.

Electives (choose at least one):

1. Earn an individual Scouting award or assist your unit in earning a unit award.
2. Do one year's requirements toward earning your age group-specific award for leaders.
3. Record and share a significant personal, Scouting or community achievement.
4. Plan and carry out a centennial-themed achievement activity.

Community Service

Required: (R) Give 4 hours of community service.

Electives (choose at least one):

1. Participate in a council-approved service activity (separate from the four required hours).
2. Visit with another community service organization and discuss with them their objectives.
3. Record and share a significant act of service.

4. Record your unit's yearly service hours.
5. Plan and carry out a centennial-themed community service activity.

Character

Required: (R) Attend and/or help facilitate an Annual Parent Night or a Youth Protection review for your unit(s) and parents.

Electives (choose at least one):

1. Wear your uniform to at least 75% of your unit's meetings, events and activities.
2. Recite the Scouting Oath, Law, and/or Promise at all unit meetings.
3. Earn a religious adult recognition.
4. Record and share a significant act of patriotism.
5. Plan and carry out a centennial-themed character activity.

Environmental Stewardship

Required: (R) Participate in an environmental stewardship activity with your unit.

Electives (choose at least one):

1. Attend a district, council or National BSA-sponsored outdoor activity or camp.
2. Participate as a member of the Order of Arrow or earn the National Camping Award.
3. Earn an environmental stewardship award.
4. Visit with another environmental stewardship organization and discuss with them their objectives.
5. Plan and carry out a centennial-themed environmental stewardship activity.

*For full descriptions, examples, desired outcomes of each requirement and other additional Centennial Celebration and Centennial Award resources go to www.utahscouts.org;

THE HEART OF SCOUTING PIN



(for everyone)

The Heart of Scouting pin has been created as a symbolic reminder for Scouts and adults. The pin can be earned as a part of Cub Scouting, Boy Scouting, Varsity Scouting and Venturing programs. This pin can also be earned by members of a Scout's family and Scout leaders. It is worn by those who understand why duty to God is the heart of Scouting, have made a personal commitment to put duty to God first in their life, and want to use the pin as a way to remind themselves of that commitment.

Complete all of the following activities.

1. Participate in a training session on how to put the first duty first in your unit, church and family.
2. Make a list of ten things you believe are important for you to do as you try to do your best to do your duty to God. Place this list in a prominent place in your home.
3. Spend at least three hours in service where the sole purpose is to do your duty to God.
4. Make a personal commitment to put duty to God first in your life.

THE HEART OF SCOUTING PATCH FOR CUB SCOUTS

The activities below help Cub Scouts learn more about their duty to God. These activities also help them increase their desire to do their duty to God. The Heart of Scouting patch for Cub Scouts patch has a blue border and is worn on the right shirt pocket of the uniform. It represents a Cub's commitment to put "my duty to God" first in his life.



Complete five of the following activities.

1. Identify someone who is honest and trustworthy. Tell Akela why being trustworthy and honest are a big part of doing one's duty to God.
2. Visit a place that your family believes is a sacred place (such as a church, synagogue, cemetery, or a mountaintop). After your visit, talk with your parents how showing reverence in a sacred place demonstrates your duty to God.
3. After saying prayers for one week tell Akela how prayer has helped you feel closer to God.
4. Participate in a discussion about how choosing good media (movies, music TV etc.) can help us live our duty to God. Tell why too much, poor quality or inappropriate media interferes with our ability to be close to God. Write three personal rules your family can use to help when choosing media.
5. Tell Akela something kind you did recently for someone else. Explain how you did this cheerfully, showing Scout spirit. Tell how it made you feel about yourself and how you think God feels when you help others.
6. Describe to Akela what bad language is and why the use of profanity shows disrespect for God. Explain how others can be offended by the use of profanity.

Requirements may be signed off by a parent, Scout leader, or religious leader.

FUN FOR THE FAMILY AWARD

Fun for the Family is Cub Scouting's family activity program. The BSA recognizes that parents and family have the responsibility to teach their children. Strengthening families is one of the purposes of Cub Scouting. This program can be an additional, positive resource in helping families accomplish worthy goals of building and strengthening relationships.

Parents may use the ideas and activities found in the Fun for the Family book to meet their own family's needs and interests. Ultimately, the activities are designed to help family members strengthen their relationships with each other by having fun and adventure through meaningful learning activities.

The program allows families to choose how they would like to participate. Flexibility and choice are important to allow families to meet their individual needs and interests. Families who wish to participate in this program choose the requirements that are applicable to their own family and complete the activities at a pace that is sensible and applicable to them.

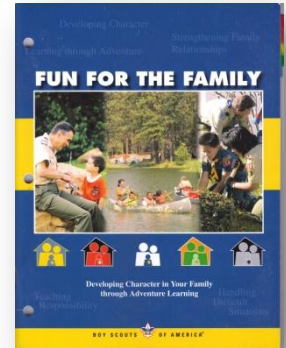

Fun for the Family is organized into five categories:

- **Shaping Your Family Identity**
- **Developing Personal Skills**
- **Building a Family Team**
- **Connecting With Your Community**
- **Facing Family Challenges**

Each category contains activities and Character Connections[®] which relate the activities to one or more of the **12 Core Values** of Cub Scouting. As a family participates they will connect family fun with important values that build character.

How to earn the Fun for the Family Award:

Certificate - To earn the Fun for the Family Award the family members must work together to complete **2 activities from each of the 5 categories** for a total of 10 activities completed.

Patches - Upon Completion of the award the family members may be presented with the certificate and each family member may be presented with the patch or patches.



Pins - After receiving the patch they may continue working on additional activities to earn the pins to be worn on the patches. Each **additional 2 activities** completed within a category earns them a pin. They may earn as many pins as they like during their Cub Scout years.

Ideally the certificate, patches and pins will be presented to the family at a pack meeting.

CUB SCOUT OUTDOOR ACTIVITY AWARD



Tiger Cubs, Wolf, Bear Cub Scouts, and Webelos Scouts can earn the Cub Scout Outdoor Activity Award. Boys may earn the award in each of the program years as long as the requirements are completed each year. The first time the award is earned, the boy will receive the pocket flap award, which is to be worn on the right pocket flap of the uniform shirt. Each successive time the award is earned, a wolf track pin may be

added to the flap. Leaders should encourage boys to build on skills and experiences from previous years when working on the award for a successive year.

Requirements

All Ranks - Attend Cub Scout Day Camp or Webelos Scout camp (Webelos-Ree).

Rank-specific Requirements

Tiger Cubs. Complete one requirement in Achievement 5, "Let's Go Outdoors" (Tiger Cub Handbook) and complete **three** of the outdoor activities listed below.

Wolf Cub Scouts - Assemble the "Six Essentials for Going Outdoors" (*Wolf Handbook*, Elective 23b) and discuss their purpose, and complete **four** of the outdoor activities listed below.

Bear Cub Scouts - Earn the Cub Scout Leave No Trace Award (*Bear Handbook*, Elective 25h) and complete **five** of the outdoor activities listed below.

Webelos Scouts - Earn the Outdoorsman Activity Badge (*Webelos Handbook*) and complete **six** of the outdoor activities listed below.

Outdoor Activities - to be done with the den, pack, or family:

- 1 Participate in a nature hike in your local area. This can be on an organized, marked trail, or just a hike to observe nature in your area.
- 2 Participate in an outdoor activity such as a picnic or park fun day.
- 3 Explain the buddy system and tell what to do if lost. Explain the importance of cooperation.
- 4 Attend a pack overnighter. Be responsible by being prepared for the event.
- 5 Complete an outdoor service project in your community.
- 6 Complete a nature/conservation project in your area. This project should involve improving, beautifying, or supporting natural habitats. Discuss how this project helped you to respect nature.
- 7 Earn the Summertime Pack Award.
- 8 Participate in a nature observation activity. Describe or illustrate and display your observations at a den or pack meeting.
- 9 Participate in an outdoor aquatic activity. This can be an organized swim meet or just a den or pack swim.
- 10 Participate in an outdoor campfire program. Perform in a skit, sing a song, or take part in a ceremony.
- 11 Participate in an outdoor sporting event.
- 12 Participate in an outdoor Scout's Own or other worship service.
- 13 Explore a local city, county, state, or national park. Discuss with your den how a good citizen obeys the park rules.

LEAVE NO TRACE AWARENESS AWARD



As more people use parks and recreation facilities, LEAVE NO TRACE® guidelines become even more important for outdoor visitors.

Leave No Trace is a plan that helps people to be more concerned about their environment and to help them protect it for future generations. Leave No Trace applies in a backyard or local park (frontcountry) as much as it does in the wilderness (backcountry).

We should practice Leave No Trace in our attitude and actions—wherever we go. Understanding nature strengthens our respect toward the environment. One person with thoughtless behavior or one shortcut on a trail can spoil the outdoor experience for others.

Help protect the environment by remembering that while you are there, you are a visitor. When you visit the outdoors, take special care of the area. Leave everything just as you find it.

Hiking and camping without a trace are signs of a considerate outdoorsman who cares for the environment. Travel lightly on the land.

SIX LEAVE NO TRACE GUIDELINES FOR CUB SCOUTS

- | | |
|--------------------|---------------------------|
| 1. Plan Ahead | 4. Leave What You Find |
| 2. Stick to Trails | 5. Respect Other Visitors |
| 3. Manage Your Pet | 6. Trash Your Trash |

Tiger Cub, Cub Scout, Webelos Scout

1. Discuss with your leader or parent/guardian the importance of the Leave No Trace frontcountry guidelines.
2. On three separate outings, practice the frontcountry guidelines of Leave No Trace.
3. Boys in a Tiger Cub den complete the activities for Achievement 5, Let's Go Outdoors; boys in a Wolf den complete Requirement 7, Your Living World; boys in a Bear den complete Requirement 12, Family Outdoor Adventures; boys in a Webelos den earn the Outdoorsman activity badge.
4. Participate in a Leave No Trace-related service project.
5. Promise to practice the Leave No Trace frontcountry guidelines by signing the Cub Scout Leave No Trace Pledge.
6. Draw a poster to illustrate the Leave No Trace frontcountry guidelines and display it at a pack meeting.

Cub Scout Leader

1. Discuss with your den's Cub Scouts or your pack's leaders the importance of the Leave No Trace frontcountry guidelines.
2. On three separate outings demonstrate and practice the frontcountry guidelines of Leave No Trace.
3. Participate in presenting a den, pack, district, or council awareness session on Leave No Trace frontcountry guidelines.
4. Participate in a Leave No Trace-related service project.
5. Commit yourself to the Leave No Trace frontcountry guidelines by signing the Cub Scout Leave No Trace Pledge.
6. Assist at least three boys in earning Cub Scouting's Leave No Trace Awareness Award.

Look for the new "Outdoor Activities" Section on this Aug 2011 CD for ideas and links to resources for teaching LNT and service project ideas too..

CUB SCOUT WORLD CONSERVATION AWARD

This award is worn on the uniform shirt, centered on the right pocket as a TEMPORARY patch. The World Conservation Award provides an opportunity for Cub Scouts, to "think globally" and "act locally" to preserve and improve our environment. It is designed to make the boys aware that all nations are closely related through natural resources and that we are interdependent with our world environment.



The Cub Scout version of the World Conservation Award can be earned by Wolf or Bear Cub Scouts, and by Webelos Scouts but it **can only be earned once, either as a Wolf, a Bear, or as a Webelos Scout.**

Wolf Cub Scout Requirements

1. Complete achievement #7 - Your Living World
2. Complete all Arrow Points in 2 of the following 3 Electives:
 - #13 - Birds
 - #15 - Grow Something
 - #19 - Fishing
3. Participate in a den or pack conservation project in addition to the above

Bear Cub Scout Requirements

- Complete achievement #5 - SHARING YOUR WORLD WITH WILDLIFE
- Complete all requirements in 2 of the following 3 electives:
 1. #2 - Weather
 2. #12 - Nature Crafts
 3. #15 - Water and Soil Conservation
- Participate in a den or pack conservation project in addition to the above

Webelos Scout Requirements

1. Earn the Forester activity badge.
2. Earn the Naturalist activity badge.
3. Earn the Outdoorsman activity badge.
4. Participate in a den or pack conservation project.



CRIME PREVENTION AWARD

(NOTE: BSA is discontinuing this award. It is still currently available until the patches run out). The BSA Crime Prevention Program was created to use the collective resources of our youth, adult membership, law enforcement agencies, and the community to address the problem of crime in our communities. Recognition for completion of the following requirements consists of a patch, pin, pocket card, and certificate. A packet is available at Council Service Centers that gives further information and helps you fulfill the requirements. This award can be earned at each grade level.



Phase I

Complete activities from the program book in which your son is working as indicated below, and discuss how they relate to crime prevention in your family.

First Grade

Tiger Cubs BSA Family Activity Book "Know Your Family" – Hold a family meeting and discuss ideas from the "Youth" section on p. 4 of the Crime Prevention Award packet. "Know Your Community" – Discuss how your family can better understand community resources related to crime prevention.

Second Grade

Wolf Cub Scout Book
"Know Your Home and Community" and "Making Choices"

Third Grade

The Big Bear Cub Scout Book
"Law Enforcement is a Big Job
"Be a Leader" Relate three of the requirements to crime prevention.

Fourth-Fifth Grade

Webelos Scout Book
"Citizen" and "Family Member"
Discuss items about drugs and crime, gangs and crime, graffiti and crime, peers and crime

Phase II

Participate with your family, pack, or friends in a crime prevention project, either an original project or a project of a neighborhood- or community-based organization. (Before beginning the project, have the unit leader approve your choice.)

SONS OF THE UTAH PIONEERS



The Holladay Chapter of the Sons of the Utah Pioneers has joined with the Utah National Parks Council to create a patch that encourages all boys to learn about the pioneer heritage in their area.

The cost of the patch is \$3.00 and it is available through:

Preston Hunt
4933 South 1575 West
Taylorsville, UT 84123
(801) 266-8216

To earn this patch, the Scout with their leader must visit a historical building, a monument or a place that represents the pioneer history of that area.

- 1 Learn the pioneer history of that place and why it is important.
- 2 Write a short story about your experience and what it means to you.
- 3 Fill out a pedigree chart of your ancestors and tell a story about them.
- 4 Find out who is the earliest pioneer of your area and when they came to the area.
- 5 Have your Scout leader pass you off on these requirements and sign that you have accomplished these things.

HUTCHINGS MUSEUM OF NATURAL HISTORY

The Hutchings Museum of Natural History is located at 55 North Center Street in Lehi. The museum is open Tuesday through Saturday 11 am to 5 pm. Tours can be pre-arranged by calling the museum at (801) 768-7180. The cost for adults, senior citizens, and students over 12 is \$2.00 and for children under 12 is \$1.50. Once the worksheet is completed, the patch is available for purchase at the Hutchings Museum.



BIRD AND EGG ROOM

In order to see, what type of bird must turn its head rather than move its eyes?

What does the woodpecker eat with his long tongue?

True or false: Monarch butterflies are poisonous to eat.

What is the biggest bird egg?

FOSSIL AND SHELL ROOM

What tiny coral animals make coral reefs?

How many varieties of coral are there?

Trilobites are how old?

What is Utah's dinosaur?

Gastroliths are used by dinosaurs and birds to do what?

ROCK AND MINERAL ROOM

What is the green colored mineral from Kennecott Copper Mine called?

What two items are made from that mineral?

What is pyrite also called?

What are most of Timpanogos Cave's formations made from?

What are the hollow rocks that are made from hot lava bubbles?

PIONEER ROOM

Before electricity, people used ice blocks to keep food and drinks cold. What was the item used to cut through the ice?

What were marbles once made of?

True or false: In the late 1800's and early 1900's, fathers made left and right-foot pairs of shoes for each member of the family.

The museum's organ, brought across the plains in 1857, arrived how many years after the pioneers entered the Salt Lake Valley?

NATIVE AMERICAN ROOM

What are the rock items that were used to grind corn and seeds to meal called?

What are petroglyphs carved in?

What were most projectile points used to make knife blades, arrow shafts, spears and darts made from?

What are three different types of animals that Native Americans hunted in Utah Valley?

JAIL ROOM

Porter Rockwell is pictured on the wall. What did he do for Joseph Smith and Brigham Young?

In what year was Camp Floyd founded southwest of Lehi, when the Johnston Army came to Utah?

Who was Utah's most famous outlaw? (Hint: Hole in the Rock was one of his hideouts.)

In what year was the jail used for Lehi city?

MUSEUM OF PEOPLES AND CULTURES

This patch was designed to motivate and guide Cub Scouts to a greater appreciation and understanding of native cultures and lifeways. Based on the cultures highlighted in the Museum's current exhibitions, the patch requirements encourage Scouts to explore specific cultures carefully and relate that knowledge to their own lives.

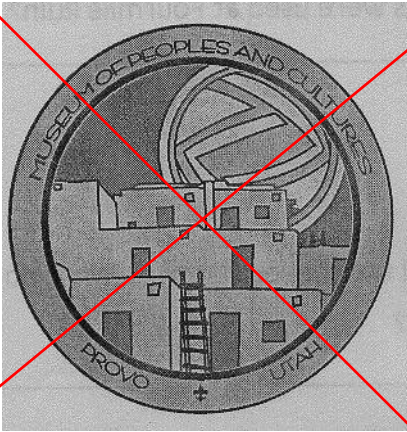

2009 Patch

There is a new patch for 2011



2010 Patch

Beneath Your Feet: Discovering
The Archeology of Utah Valley

The Museum of Peoples and Cultures is located on the corner of 700 North and 100 East in Provo, one block south of the Brick Oven restaurant. Admission is free. Guided tours are available by appointment for a nominal charge.

To earn the patch:

1. Visit the museum
2. Complete the worksheet. (available at the Museum)
3. Have a Museum employee review your completed worksheet and sign the form to certify fulfillment of the patch requirements.

Patch(s) is available for purchase at the Orem Scout Shop.

Museum of Peoples and Cultures
105 Allen Hall
Brigham Young University
Provo UT 84602-3600
(801) 422-0020

Hours: Monday-Friday 9 am-5 pm
Evenings by arrangement

There are always two different patches available. 1 exhibit, worksheet and patch changes each year. So in 2011 you can still get the 2010 and the new 2011 patch. In 2012 you will be able to get the 2011 and 2012.

MONTE L. BEAN LIFE SCIENCE PATCH

This patch was designed to motivate Scouts to gain a greater appreciation and knowledge of life science. By completing the requirements for this patch, Scouts can expand their minds, search their interests and gain an understanding of the world around them. The Monte L. Bean Museum is located on the east side of the Marriott Center on the BYU campus. Call (801) 422-5051 for hours and information. A packet to help boys earn this patch is available at the Utah National Parks Council Service Center.



Requirements:

- 1 Visit the museum a minimum of two times.
- 2 During your two visits to the museum, complete the following:
 - a. Attend one of the in-house shows such as reptile, bird, or other such shows.
 - b. Complete the museum worksheet entitled "In Search for Life." (This worksheet can be obtained at the museum information desk.)
 - c. Watch one of the museum nature videos of your choice.

UTAH COUNTY FAIR PATCH

Requirements for ages 5-7 (Tiger)

With your family or unit, do five of the following activities:

- 1 Attend the Utah County Fair with your den, pack, troop, or family.
- 2 Wear your uniform.
- 3 Enter an item of your own in the Fair. (Call 370-8137 for details.)
- 4 Identify two items exhibited at the Fair by people from your own town.
- 5 Identify two different breeds of animals at the Fair.
- 6 Identify two different kinds of plants in the horticulture exhibits.
- 7 Pick up litter as you go around the Fairgrounds.
- 8 Attend a musical performance at the Fair.
- 9 Eat a food that you have never eaten before.



Requirements for ages 8-10 (Wolf, Bear and Webelos)

With your family or unit, do five of the following activities:

- 1 Attend the Utah County Fair with your den, pack, troop, or family.
- 2 Wear your uniform.
- 3 Enter an item of your own in the Fair. (Call 370-8137 for details.)
- 4 Identify five items exhibited at the Fair by people from your own town.
- 5 Identify five different breeds of animals at the Fair.
- 6 Identify five different kinds of plants in the horticulture exhibits.
- 7 Pick up litter as you go around the Fairgrounds.
- 8 Attend a musical performance at the Fair. Identify which group is performing and what instruments they are using.

Requirements for ages 11 and up (Boy Scouts) and Patches are available through Council Services at the Utah National Parks Council Service Center.

UTAH COUNTY FREEDOM FESTIVAL PATCH

Requirements for ages 5-7 (Tigers)

With your family or unit, do five of the following activities:

- 1 Attend a Freedom Festival activity.
- 2 Wear your uniform to Freedom Festival activities.
- 3 Attend or participate in a Flag Raising Ceremony.
- 4 Pick up litter at any of the Freedom Festival activities
- 5 Attend a fireworks display and discuss fireworks safety.
- 6 Discuss the meaning of freedom. Name some of your personal freedoms.
- 7 Help plan and attend a 4th of July picnic.
- 8 Name two patriotic songs and sing one of them.
- 9 Attend Freedom Festival's Grand Parade and identify two entries.
- 10 Give the Pledge of Allegiance to the flag of the United States of America. Tell what it means.



Requirements for ages 8-10 (Wolf, Bear, Webelos and 11-year-old Webelos)

With your family or unit, do five of the following activities:

- 1 Attend a Freedom Festival activity.
- 2 Wear your uniform to a Freedom Festival activity.
- 3 Attend or participate in a Flag Raising ceremony.
- 4 Visit a veterans' memorial and discuss veterans' contributions to our freedom.
- 5 Write an essay on freedom and discuss it with you family or Scout group.
- 6 Attend Freedom Festival Grand Parade and identify five different entries.
- 7 Name three patriotic songs and sing one of them.
- 8 Pick up litter at any of the Freedom Festival activities.
- 9 Attend a firework display and discuss firework safety.
- 10 Build or create patriotic floats or other entries, and participate in the Children's Freedom Festival parade.

Requirements for 11-years-old and up,
and patches are available through Council Services
at the Utah National Parks Council,
748 North 1340 West, Orem, Utah 84057.



UTAH COUNTY TRAILS PATCH

Requirements for ages 5-7

Choose one:

- A. Choose one trail and hike a one mile portion of it with your den, pack or family.
- B. Choose a trail and bike or roller blade or go horseback riding along a one mile portion of it: list the safety equipment and requirements for the activity that you choose.

Choose four of the following activities:

- 1 Have your Scout leader or parent show you on a map where two county trails are.
- 2 Find out what activities you can do on each trail.
- 3 Participate in a service project to clean up an area of a trail.
- 4 Take a garbage bag and collect at least five pieces of litter; dispose of it properly.
- 5 Find three different animals as you hike.
- 6 Explain what you liked best about the trail.
- 7 Practice "No Trace" picnicking, hiking and camping. Leave an area cleaner than you found it. For more information, contact the Forest Service.



Requirements for ages 8-10

Choose one:

- A. Choose one trail and hike a two mile portion of it with your den, pack, or family.
- B. Choose a trail and bike or roller blade or go horseback riding along a three mile portion of it; list the safety equipment and requirements for the activity that you choose.

Choose four of the following activities:

- 1 Name three Utah County trails and locate them on a map.
- 2 Find out what activities you can do on each trail.
- 3 Participate in a service project to clean up an area of a trail.
- 4 Take a garbage bag and collect at least five pieces of litter; dispose of it properly.
- 5 Identify three plants/trees or three animals that you see on the trail.
- 6 Explain what you liked best about the trail.
- 7 Practice "No Trace" hiking, picnicking, and camping. Leave an area cleaner than you found it. For more information, contact the Forest Service.

Requirements for ages 11 and up and patches are available through Council Services at the Utah National Parks Council, 748 North 1340 West, Orem Utah, 84057.



UTAH'S NATIONAL MONUMENTS TOUR PATCH

Requirements for earning the Utah's National Monuments Tour patch:

- 1 View the video at the Visitors Center showing you about the monument. (If not available, obtain a pamphlet and read about the monument.)
- 2 Sign the register book at the Visitors Center.
- 3 Tour the monument.

Report to your den or pack the following:

4. Explain what the words "national" and "monument" mean. (You can use a dictionary.)
5. On a map of the state of Utah, show where you live and what route you took to reach the monument. Show the area the monument covers.
6. Tell how nature made the monument.
7. Explain what you saw and learned at the monument.
8. Tell what trees and plants grow at the monument. Name three of each. Explain what you liked best about the monument.
9. Do something to improve the monument site. (You could gather litter.)



For your information, the addresses and telephone numbers of Utah's National Monuments are listed below. Entrance fees vary. For highway maps and information on accommodations, campgrounds, and tours, contact: **Utah Office of Tourism**, 300 North State Street, Salt Lake City, UT 84114, Phone (801) 538-1030. All patches must be purchased by an adult leader at the Council Service Center.

Cedar Breaks National Monument

P.O. Box 749 Cedar City UT 84720
(435) 586-9451

Natural Bridges National Monument

Box 1 Lake Powell UT 84533
(435) 259-5174

Timpanogos Cave National Monument

Box 200 American Fork UT 84003
(801) 756-0351

Pipe Springs National Monument

401 North Pipe Springs Road
Fredonia AZ 86052
(602) 643-7105

Dinosaur National Monument

Box 210 Dinosaur CO 81610 Headquarters
(303) 529-4461
Quarry Visitor Center
(435) 789-2115

Rainbow Bridge National Monument

Glen Canyon National Recreation Area
Box 1507 Page, AZ
(602) 645-2471

Hovenweep National Monument

Mesa Verde National Park Box 8
Mesa Verde National Park, CO 81330
(303) 529-4461

UTAH'S NATIONAL PARKS TOUR PATCH

Requirements:

1. Sign the register book at the visitors center.
2. View the video at the Visitors Center showing you about the park. (If not available, obtain a pamphlet and read about the park.)
3. Tour the park.

Report to your den or pack the following:

- 4 On a map of the state of Utah, show where you live and the route you took to reach the park. Show the area the park covers.
- 5 Explain how nature made the park.
- 6 Explain what you saw and learned at the park.
- 7 Tell what trees and plants grow in the park. Name three of each.
- 8 Do something to improve the park. (You could gather litter.)
- 9 Explain what you liked best about the park.



For your information, Utah's national parks are listed below. Entrance fees vary. For highway maps and information on accommodations, campgrounds and tours, contact: **Utah Office of Tourism** 300 North State Street Salt Lake City, UT 84114, Phone (801) 538-1030. All patches must be purchased by an adult leader at the Council Service Center.

Arches National Park

Box 907 Moab, UT 84532
(435) 259-8161

Capitol Reef National Park

Torrey, UT 84775
(435) 425-3791

Zion National Park

Springdale, UT 84767-1099
(435) 772-3256

Bryce Canyon National Park

Bryce Canyon, UT 84717
(435) 834-5322

Canyonlands National Park

446 South Main St. Moab, UT
84532
(435) 259-7164

Great Basin National Park

Highway 488 Baker NV 89311
(702) 234-7331



FLAMING GORGE NATIONAL RECREATION AREA PATCH

1. Visit the Flaming Gorge Visitors Center and sign the guest book.
2. Watch the presentation on the building of the dam and answer the following questions.
 - a. What year was the dam completed?
 - b. Who dedicated the dam?
 - c. How much water can the dam hold?
 - d. Where was the switch flipped to turn on the generators?
 - e. What is the height and width of the dam?
 - f. What town/city was created for workers while working on the dam?
 - g. What year-round recreational opportunities are available at the dam?
 - h. Tour the dam and identify five things you saw on the tour.
3. What is outdoor ethics? List two ways you can practice positive outdoor ethics.
4. Identify five wildlife species found in the Flaming Gorge Recreational area. Pick one species of wildlife and write or explain about the habitat needed for that species.
5. Identify five plant species found in the Flaming Gorge Recreational area. How are these plants useful to the wildlife?
6. Complete a conservation project with your pack.
7. Visit two of the following:
 - a. Red Canyon overlook and Red Canyon Visitors Center
 - b. Swett Ranch
 - c. Ute Tower Lookout - Deep Creek
 - d. Sheep Creek Bay
 - e. Sheep Creek Geological Loop
 - f. Firefighters Memorial
 - g. Take the "Wildlife through the Ages" tour and stop at each site
 - h. Spillway boat launch

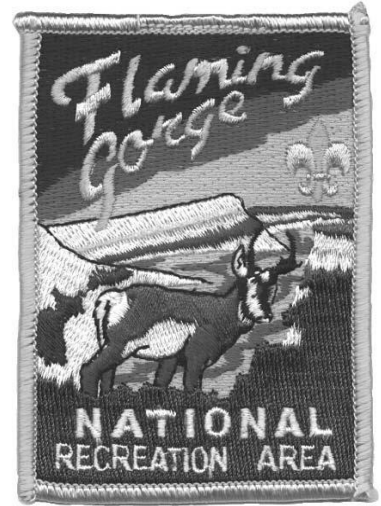

When you fulfill the requirements:

The patch is available for purchase at The Flaming Gorge Visitor Center.



THE BSA PHYSICAL FITNESS AWARD

Two important challenges in preparing youth for the 21st century— particularly in today’s increasingly automated and sedentary culture are physical fitness and good health. Every adult leader should set the example and contribute directly to the health and fitness of today’s Scouts by completing requirements for the BSA Physical Fitness Award.



The purpose of this award is to:

- Encourage the development of attitudes, knowledge, and skills that promote fitness and safe conduct.
- Lay a skill, knowledge, and attitude foundation of the seven major components of fitness— Posture, Accuracy, Strength, Agility, Speed, Balance, and Endurance.
- Improve health, fitness, and quality of life through daily physical activity.

Requirements

1. Complete a cardiovascular fitness evaluation/consultation with your personal health care provider. (This can be done as part of the examination for the **Annual Health and Medical Record**)
2. Using the BSA references listed after the seven major components, give a presentation to a BSA or other community youth group (at least eight youth participants) on cardiovascular fitness, diet, the health benefits of regular aerobic exercise, exercise recommendations for the Scout-age group, and healthy lifestyles.
3. Review the BSA guidelines for the Athletics and other physical activity or personal fitness-oriented merit badge and explain steps you have taken to follow each of the guidelines for the fitness goals. Explain precautions to be taken for a physical fitness activity in each of the following: woods, fields, facilities, and waterfront.
4. Explain to your mentor the symptoms of dehydration and hypothermia. Explain the special considerations for preventing dehydration and hypothermia.
5. Properly outfit for physical activities with proper equipment, clothing, and footwear. Know your own capabilities and limitations. Illustrate how you would prepare for the physical fitness goals included in the award program.
6. With supervision from your mentor or other qualified persons, set up a fitness goal-oriented plan using the seven major components of fitness.
7. Demonstrate your ability to improve your strength, posture, endurance, agility, speed, accuracy, and balance with your own goal-oriented fitness plan.

The following physical fitness activities are included in the Cub Scout program. These suggested advancement requirements could be a resource for youth in earning the BSA Physical Fitness Award. Complete requirements are in the To Be Physically Fit BSA pamphlet at Council Service Centers.

Tiger Cub Handbook Elective 37: Take a bike ride Elective 40: Swimming-related activity

Wolf Cub Scout Book Achievement 1: All of them Achievement 9: Ride a bike Achievement 10b: Walk Elective 7: Walk on stilts/puddle jumpers Elective 20: Sports—boating, skiing, ice-skating, roller-skating, sprint start, standing long jump, soccer, baseball, basketball

Bear Cub Scout Book - Achievement 14, 15: Bike riding, games Achievement 16, 23: Building muscles, sports Elective 5, 19: Boats, rowing, swimming Elective 20: Sports—plus long and high jump

Webelos Scout Book - Aquanaut: Swimming, boating Athlete: Push- and pull-ups, curl-ups, standing long and vertical jump, 50- and 600-yard dash Sportsman: Two team sports, two individual sports

See scouting.org to download application form

NATIONAL DEN AWARD

Cub Scouting happens in the den. The National Den Award will create an incentive for a year-round fun, quality program in the den. The National Den Award may be earned only once in any 12-month period. The period (charter year, calendar year, etc.) is to be determined by the pack committee.

REQUIREMENTS



A. Have at least 50 percent of the den's Tiger Cubs, Cub Scouts or Webelos Scouts attend two den meetings and one pack meeting or pack activity each month of the year.

B. Complete six of the following during the year:

- Use the denner system within the den. In a Tiger Cub den, use shared leadership and rotate the boy/adult host team.
- Have 50 percent of the den go on three field trips per year. A field trip may be used in place of a den meeting.
- As a den, attend a Cub Scout day camp, Cub Scout or Webelos Scout resident camp, or a council family camping event with at least 50 percent of the den membership.
- Explore at least three Character Connection activities.
- As a den, participate in at least one of the Cub Scout Sports programs.
- As a den, participate in at least one of the Cub Scout Academics programs.
- Have 50% of the den participate in a den conservation/resource project.
- Have 50% of the den participate in at least one den service project. An

application for this award can be obtained at the Council Service Center.

DONOR AWARENESS

The purpose of the Donor Awareness Patch is to make Scouts and their families aware of organ donation and its benefits

To earn the patch, learn about organ donation and talk to your family about it. They do not have to make a commitment to donate. They just need to be aware of what organ donation is and how it can benefit the lives of others. And just for becoming aware, you'll earn a cool patch that lets people know your heart is in the right place. Intermountain Organ Donor Services is an excellent resource for learning more about organ donation. With two to three weeks' notice, they can send someone to speak to your group about organ donation. They may also be able to bring a donor or recipient family to speak.



For more information, contact:

Intermountain Donor Services
230 South 500 East #290
Salt Lake City, UT 84102
(801) 521-1755

www.idslife.org

BOYS' LIFE PATCH

To complete the requirements, several Boys' Life magazines may be needed. Family members, friends, or Cub Scout leaders may help boys in reading the articles. In some of the following requirements, other Cub Scout advancements might be earned depending on the work that is accomplished. On completion of this patch, the Communicating belt loop may also be earned.



Do three of the following:

1. Subscribe to Boys' Life for at least one year. If you are unable to have Boys' Life in your home, go to a library, or borrow from a friend.
2. Find another Cub Scout boy who doesn't take Boys' Life magazine and tell him about how much fun you had reading it.
3. Enter the Boys' Life reading contest with a one page book report on "The Best Book I Read This Year" and receive the free Pedro Patch from Boys' Life. Contest rules can be found in Scouting magazine. Mail to Boys' Life Reading Contest, S204 1325 W. Walnut Hill Lane P.O. Box 152079 Irving TX 75015-2079

4. Read the article A TRUE STORY OF SCOUTS IN ACTION. Tell an adult about the story and find out ways you can become prepared for accidents. (Wolf elec. 16; Bear Ach. 11; Webelos Readyman)
5. Read a fiction story from any issue with your family.

Do four of the following:

6. Read two comics with a family member or a friend. Tell an adult about the comics you read.
7. Read a THINK AND GRIN page with a family member or friend. Prepare one of the jokes for a family, den, or pack meeting.
8. Read an article on SPORTS or SCIENCE. Try the sport or experiment out for yourself and tell an adult what you have learned.
9. Read an article on SAFETY or HISTORY. Practice the safety rules or, if doing history, tell an adult what you have learned.
10. Read an article on HOBBY HOWS or CODEMASTER. Try one of the hobbies or learn one of the codes and show to a parent, den member, or den leader.
11. Read an article of your choice different from what you have read.

CRIME FIGHTING ACTIVITY PATCH



The Attorney General's Office teams up with Utah Scouts to fight crime! If you are interested in getting the requirements for earning this patch, send your name, sponsoring unit name, unit number, your address with city, state, and zip to:

Utah Attorney General's Office
 c/o Chief Deputy Attorney
 Genera l236 State Capitol
 Salt Lake City UT 84114

KENNECOTT'S BINGHAM CANYON MINE TOUR PATCH

Tours available only from April 1 through the end of October. Entrance fee will be waived for all vehicles with Cub Scouts and leaders in uniform. Otherwise cost is \$4.00 per car. Open 8:00 am to 8:00 pm, seven days a week through October 31. No appointment is necessary.



Each Cub Scout and leader who visits the mine may earn the patch by completing the following requirements.

1. Sign the Guest Registry in the Visitors Center as a family, den, or pack.
2. Tour the Visitors Center, both inside and outside, and locate the following information:
 - a. Name two artifacts on display in front of the Visitor Center.
 - b. What is the weight of a haulage truck tire?
 - c. Name five minerals found in the Bingham Canyon Mine.
- d. Name 5 ways copper is used in your everyday life.
- e. What is the oldest man-made metal object?
3. Watch the video presentation in the Visitors Center Theater and answer the following questions:
 - a. What two man-made objects on Earth can be seen from outer space?
 - b. A giant electric shovel can scoop how many tons of rock in one bite? _____ tons
 - c. In addition to copper, name two other metals that are produced from the mine.
4. (Optional) If you wish, pick out a sample of ore from the "Free Samples" bin in front of the gift shop.

OURAY NATIONAL WILDLIFE REFUGE PATCH

1. Attend the Ouray National Wildlife Refuge Open House and sign your name in the registration book.
2. Visit at least six of the eight booths at the Open House. Below is a list of possible booths. Write in any that you visited that are not listed. Wetland, Birds, Gigantic Bugs, Small Mammals, Fish Hatchery, Birding Tour, Pesky Weeds, Soils, Live Hawks, Mistnetting, Waterfowl, Prescribed Fire, Endangered Fish
3. Complete a service project to be assigned at the Open House. Some service projects that may be assigned are: trash pick-up, restroom check, equipment set-up and take down.
4. Visit the Jones Hole **or** Ouray National Fish Hatcheries.
 - a. Identify the species of fish raised there.
 - b. Why was the fish hatchery built?
 - c. Where do the fish go that are raised here?
 - d. At what age and size are the fish stocked out?



WOLF REQUIREMENT: Complete Wolf Elective #13 a-f and Wolf elective #19 a.

BEAR REQUIREMENT: Complete Bear Achievement #5.

WEBELOS REQUIREMENT: Complete Naturalist activity badge.

THIS IS THE PLACE HERITAGE PARK



This is the Place Heritage Park is located across from Hogle Zoo at 2601 E. Sunnyside. The phone number is (801) 582-1847. The Visitor Center, monument and grounds are open year-round Monday through Saturday from 9:00 am to 5:00 pm free of charge. Old Deseret Village is open Memorial Day weekend through Labor Day Monday through Saturday from 10:00 a.m.-5:00 p.m. There is no fee for Scouts and leaders in uniform. Fee for Scouts not in uniform is \$4.00 per Scout. Fee for adults not in uniform is \$6.00 per adult. Regularly priced admission tickets are required for the carriage ride.

Each Cub Scout and leader who visits the park may earn the patch by completing the following requirements:

1. While visiting the park, pickup five pieces of litter.
2. Visit the monument and find the answers to the following questions:
 - a. What Indian tribe lived near this area. Name their chief who was close friends with Brigham Young?
 - b. Who conducted the first scientific explorations of the Great Salt Lake?
3. Visit the school.
 - a. What was the name of the new system of writing in the pioneer period?
 - b. Write your name using this system.
 - c. Play a pioneer game.
4. Tour the Andrus Inn.
 - a. Tell what chores children did at the farm.
 - b. Why are the dishes upside down on the dining table?
5. What animals did you see at the park? Tell what they were used for.

UTAH STATE FAIR PATCH

The Fair starts the first Thursday following Labor Day and runs for 11 days. The Fairpark Administration Office is located at 155 North 1000 West in Salt Lake City.

To earn the patch, do five of the eight following requirements.

1. Attend the Utah State Fair with your den, pack or family.
2. Wear your uniform. (Scouts and leaders wearing their uniform will receive \$1.00 off the regular gate admission. Pick up your \$1.00 off coupon at the Fairpark Administration Office prior to purchasing your gate admission tickets. Offer is not good toward Advance Discount Tickets.)
3. Enter an item or exhibit of your own into the Fair. Call (801) 538-8400 for details.
4. Identify exhibits by people from your town or county.
5. Identify five (5) breeds of animals at the Fair. Example: Angus is a breed of beef cattle.
6. Identify five (5) vegetables at the horticulture exhibit in Promontory Hall.
7. Pick up and throw away litter as you go through the Fairpark.
8. Describe your favorite experience or something you learned at the Fair.



UTAH FIREFIGHTERS MUSEUM AND MEMORIAL TOUR



The Firefighters Museum and Memorial is located at the Deseret Peaks Complex in Tooele County, 2390 State Route 112, between Tooele and Grantsville. The museum is open to the public Friday and Saturday from 11:00 am to 3:00 pm. For more information and tour times, call (435) 843-4040 or make an appointment with Dave Hammond at (435) 830-6556.

1. Sign the register and take a tour of the Firefighters Museum and Memorial.
2. Watch the fire safety movie (about 15 minutes).
3. Talk about the ten steps to fire safety.
4. Name a method of communication first used between firemen and the station that's still in use today.
5. Tour the Memorial Gardens and observe a moment of silence for those who gave their lives to save the lives of others.
6. Name one of the first modes of transportation used to get to a fire.
7. Name two makes of fire trucks.
8. Visit the Envirocare Safe Alternative Exhibit and name something Scouts use that is radioactive.

WHEELER HISTORIC FARM WALK

Wheeler Historic Farm is located at 6351 South 900 East in Murray. Admission is free. A fee is charged for services. Reservations are available for large groups, so please call the farm in advance so they know how many people to expect (801-264-2241). Hours are 9:30 a.m.-5:30 p.m. year-round. Tours are available

With your Den, Pack or Family, visit Wheeler Historic Farm and do the following:

1. Bring a garbage bag and gather litter. Put the bag in trash can.
2. Tell what kind of horses they have at the farm.
3. Tell the name of Henry Wheeler's Dairy.
4. Name three pieces of farm machinery.
5. What were the ponds used for in the winter?
6. Tell who took care of the chickens and rabbits.
7. What color eggs do Plymouth Rock chickens lay?
8. Tell what looms were used for.
9. (Optional) Attend the milking session at 5:00 p.m. There is a 50¢ charge per person.
10. (Optional) Wagon House tour Monday through Saturday for \$1.50 per person.



ABILITY AWARENESS PATCH

The objective of the Ability Awareness Patch is: To encourage opportunities for Scouts and leaders to promote Ability Awareness. To encourage Scouts and leaders to increase interaction with people with disabilities. To help Scouts and leaders better understand the meaning of "disability." To provide experiences for Scouts with disabilities to interact with other Scouts.

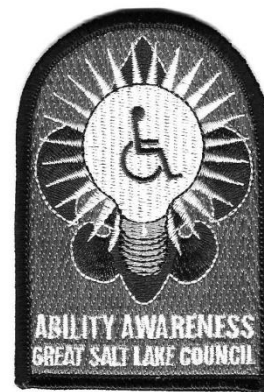

Complete 9 of the following requirements to earn the Patch.

1. Visit an agency that works with disabilities (physical, mental, or sensory). Collect available literature. Make a display about one or more disabilities and display it at a Scout meeting.
2. For a one-hour period, go about your normal routine (doing chores, watching television, studying, etc.) using one of these experiences:
 - Hearing impairment: muffle your ears with bandages or earmuffs.
 - Sight impairment: Blindfold one or both eyes so your sight is obscured.
 - Physical impairment: Immobilize arms or legs so that they cannot be used.
 - Choose a different experience of your own.
- 1 Using sign language, learn a Scout promise, motto, or oath.
- 2 Learn about the Braille alphabet. Spell out ten words, including your first name.
- 3 Talk to a youth who has a disability. Learn about the disability and its effect on the person.
- 4 Learn about wheelchairs. Discuss the uses and purposes of different types of wheelchairs. Be a "buddy" to a youth with a disability for an activity at a Scouting meeting or a school, church or community activity.
- 5 Read a book, fiction or nonfiction, about a person who has a disability.
- 6 Invite a special education teacher or disability specialist to visit a Scout meeting to talk about disabilities, therapy, mainstreaming, and/or interacting with youth with disabilities.
- 7 Do a service project for people with disabilities.
- 8 Attend a class to learn about a specific type of disability.
- 9 Teach a family member the main points you have learned about disability awareness.
- 10 Assist with the Special Olympics.

CUB ZOO TRAIL

Hogle Zoo is located at 2600 East Sunnyside Avenue in Salt Lake City. Zoo hours are 9:00 am to 5:00 pm except Christmas and New Year's Day. You must call Hogle Zoo at (801) 584-1785 two weeks before you plan to attend in order to receive the group discount and the Hogle Zoo brochure. When you call be prepared to leave a message with the following information - your name, mailing address, phone number, date of intended visit and approximate number of people attending. You will receive the brochures by mail and a coupon for \$1.00 off per Scout in uniform and two adult leaders.

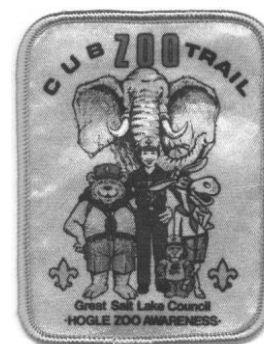

With Den, Pack or Family, do these requirements to earn this patch:

1. Identify 20 different animals.
2. Determine which parts of the world these animals originated. (Notice signs at each exhibit for this)
3. Tour and observe Hogle Zoo with your family, den, or pack.
4. WEAR YOUR UNIFORM. Only Scouts in uniform will get a discount.

CUB SCOUT LEADER RECOGNITIONS

Special awards are available for Cub Scout leaders who complete training, tenure, and performance requirements. These awards are presented by the local council through each district.

All of the awards require the completion of Fast Start Training, both parts of Basic Leader Training (This is Scouting and Leader Specific) for the position, Youth Protection training, and participation in some Roundtables or Pow Wow or University of Scouting. Some require additional supplemental training. One or two years of registered service in the appropriate position is a requirement for each award, and tenure used for one award may not be used for another. You may download charts to help you keep track of your progress at www.scouting.org/cubscouts

*Because the requirements for these awards are no longer included in the Cub Scout Leader Book we thought we would show and list them here.



Cub Scouter Award

(Blue and yellow knot on a blue background)

Award Requirements:

Tenure

Complete two years as a registered adult leader in a Cub Scout pack. Dates of service used to earn one key or award cannot be used to earn another key or award.

Training:

- Complete Fast Start training, if available for your position.
- Complete basic training for any Cub Scouting position.
- Complete Youth Protection training.
- During each year of tenure for this award, participate in a Cub Scout Leader Pow Wow or University of Scouting, or attend at least four roundtables.

Performance –

Do five of the following:

- Assist in planning a pack program that results in advancement in rank by a minimum of 50 percent of pack members each year.
- Serve as an adult leader related to a pack that earns the national Quality Unit Award.
- Serve as leader of a blue and gold dinner, pinewood derby, space derby, raingutter regatta, field day, picnic or other Cub Scout activity.
- Give leadership to a promotional effort that results in at least 60 percent of pack families subscribing to *Boy's Life* magazine.
- Develop or update a Tiger Cub or Cub Scout den activity book listing local places to go, things to do, costs, distances, etc., for each big idea or for at least 12 Cub Scout themes.
- Give leadership to planning and conducting a pack service project.
- Organize participation of a pack in the Cub Scout Academics and Sports program.
- Help conduct two annual pack Friends of Scouting campaigns.
- Serve as a leader for members of your pack attending a Cub Scout day camp or resident camp.
- Serve one year as pack trainer, during which time 75 percent of registered pack leaders complete basic training for their positions.

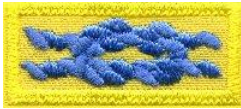

Cubmasters Award

(Light blue over light blue knot on gold field with gold border)

Award Requirements:

Tenure:

Serve as a registered assistant Cubmaster for one year and a registered Cubmaster for one year, or serve as a registered Cubmaster for two years. Dates of service used to earn one key or award cannot be used to earn another key or award.

Training:

- Complete "The New Cubmaster" Fast Start Training.
- Complete basic training for Cubmasters.
- Complete Youth Protection training.
- During each year of tenure for this award, participate in a Cub Scout Leader pow wow or university of Scouting, or attend at least four roundtables.

Performance:

- As a Cubmaster or assistant Cubmaster, earn the national Quality Unit Award at least once.
- Earn the National Summertime Pack Award at least once.
- Plan and conduct pack meetings during each year registered as Cubmaster.



Den Leader Award

(Gold over light blue knot on blue field with blue border)

Award Requirements:

Tenure: Complete one year as a registered Cub Scout den leader.

Training:

- Complete 'The New Den Leader' Fast Start Training.
- Complete basic training for Cub Scout den leaders.
- Complete Youth Protection training.
- During your tenure for this award, participate in a Cub Scout leader pow wow or University of Scouting, or attend at least four roundtables.

Performance:

Do five of the following:

- During at least one program year, have a minimum of 50 percent of the Cub Scouts in your den earn the rank for their grade or age (Wolf or Bear).
- At least once, reregister a minimum of 75 percent of the eligible members of your den as a part of pack rechartering.
- Graduate a minimum of 60 percent of the eligible members of your den into Webelos Scouting.
- Have an assistant den leader who meets regularly with your den.
- Have a den chief who meets regularly with your den.
- Take leadership in planning and conducting a den service project.
- Conduct at least three den meetings per month, nine months per year, or follow an optional plan approved by the pack.
- Participate with your den in a Cub Scout day camp or Cub Scout resident camp experience.
- Explore three Character Connection activities with your den members in one year.
- Hold regular den meeting and den activity planning sessions with your assistant den leader.



Pack Trainer Award

(Blue and Gold knot on gold field with blue border)

Award Requirements:

Tenure: Complete two years as a registered pack trainer.

Training:

- Complete Fast Start Training for the pack committee.
- Complete Basic Leader Training for any Cub Scouting position.
- Complete New Leader Essentials and be familiar with and able to explain the key elements of Leader Specific Training for all volunteer positions in the pack.
- Complete Youth Protection Training.
- Participate in a trainer development conference.

Performance:

- Participate in a Cub Scout leader pow wow or University of Scouting during each year of tenure.
- Have Cub Scout roundtable staff certify your attendance for at least 30 percent of the roundtables during each year of tenure for this award.
- Attain 100% trained leadership within the pack for the committee chairman, Cubmaster, and all den leaders.
- Have a working plan in place for delivering Fast Start training to new leaders within 48 hours of their joining your pack.
- Have a working plan in place for helping leaders who have not taken basic training to attend New Leader Essentials and Leader Specific training.
- Keep and update training records of all leaders in your pack.
- During the pack annual program planning meeting, be available to answer questions about training courses.
- Review ongoing pack leadership training status and provide leaders with updates on any available supplemental training.



Tiger Cub Den Leader

(Black over orange knot on gold field with orange border)

Award Requirements:

Tenure: Complete one year as a registered Tiger Cub den leader

Training:

- Complete 'The New Tiger Cub Den Leader' Fast Start Training.
- Complete basic training for Tiger Cub den leaders.
- Complete Youth Protection training.
- During your tenure for this award, participate in a Cub Scout leader pow wow or University of Scouting, or attend at least four roundtables.

Performance:

Do all of the following:

- Conduct a Tiger Cub roundup for your pack with at least five new Tiger Cub boy/adult teams recruited.
- Contact the host team each month and provide support as needed for one year.
- Coordinate Tiger Cub den participation in three Cub Scout pack activities each year.
- Graduate at least 60 percent of your Tiger Cubs into a Cub Scout den.
- Report on the progress of Tiger Cub dens at 75 percent of pack leader meetings.

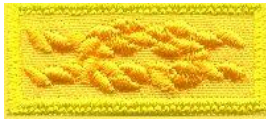

Webelos Den Leader Award

(Orange on orange knot on gold field with gold border)

Award Requirements:

Tenure:

Complete one year as a registered Webelos den leader. Dates of service used to earn one key or award cannot be used to earn another key or award.

Training:

- Complete "The New Webelos Den Leader" Fast Start training.
- Complete basic training for Webelos den leaders.
- Complete outdoor training for Webelos den leaders.
- Complete Youth Protection training.
- During your tenure for this award, participate in a Cub Scout leader pow wow or University of Scouting, or attend at least four roundtables.

Performance:

Do seven of the following:

- During at least one program year, have a minimum of 50 percent of the Webelos Scouts in your den advance in rank (Webelos badge or Arrow of Light Award).
- At least once, register a minimum of 75 percent of the eligible members of your den as part of pack rechartering.
- Graduate a minimum of 60% of the eligible members of your Webelos den into Boy Scouting.
- Have an assistant den leader or second adult who regularly attends your den's meetings and activities.
- Have a den chief who regularly meets with your den.
- Take leadership in planning and conducting two Webelos overnight campouts or other outdoor den activities each year.
- Assist in planning and conducting a Webelos den/Boy Scout troop joint activity.
- Take leadership in planning and conducting a Webelos den service project.
- Conduct at least three Webelos den meetings per month, nine months per year, or follow an optional plan approved by the pack.
- Participate with your den in a Webelos day camp or resident camp experience.
- Explore three Ethics in Action activities with your den members in one year.
- Hold regular den meetings and den activity planning sessions with your assistant den leader.



Adult Religious Emblem

(Purple on purple knot on a silver field with silver border)

Most of the major religious chartering units have programs to recognize both the youth and their adult scouters for exceptional service to boys. These are not scouting awards but may be worn on the uniform. Requirements are determined by the religious institution and vary depending on the chartering organization. For specific requirements go to www.scouting.org. (For LDS sponsored units see "On My Honor" requirements)

Note: When putting the knots on your uniform, above the right pocket, the knot on top goes to the wearer's right side:



← Correct

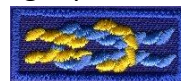

← Incorrect

WHERE CAN I FIND SCOUT STUFF?

Orem Service Center (Headquarters)

748 North 1340 West
Orem, Utah 84057
(801) 437-6222
(801) 437-6240 (FAX)
(801) 437-6239 (FAX-Tour Permits)
Hours of Operation:
M-F: 8:30 a.m. to 5:30 p.m.
Sat: 9:00 a.m. to 2:00 p.m.
Scout Shop Contact Information:
(801) 221-1008
(801) 765-4520 (FAX)

St. George

204 North 1000 East
St. George, Utah 84770
(435) 628-5172
(435) 674-2263 (FAX)
Hours of Operation:
M-F: 9:00 a.m. to 5:30 p.m.
Sat: 10 a.m. to 2 p.m. (Scout Shop only)
Scout Shop Contact Information:
(435) 628-3100
(435) 673-4865 (FAX)

Monticello

PO Box 632
116 South Main Suite 2
Monticello, Utah 84535
(435) 587-3403 Hours of Operation:
Mon: Closed
T-F: 10:00 a.m. to 5:00 p.m.
Sat: Closed

And of course you can
always order any
supplies online at
www.scoutstuff.org

Cedar City

444 South Main #3A
Cedar City, Utah 84720
(435) 586-1613
(435) 867-8324 (FAX)
Hours of Operation:
M-F: 9:30 a.m. to 5:30 p.m.
Sat: Closed

Price

212 East 100 North
Price, Utah 84501
(435) 637-8059
(435) 636-8006 (FAX)
Hours of Operation:
Mon: Closed
Tue: 12:00 p.m. to 6:00 p.m.
W-F: 12:00 p.m. to 5:00 p.m.
Sat: Closed

Vernal

240 East 100 North
Vernal, Utah 84078
(435) 789-9108
(435) 781-1008 (FAX)
Hours of Operation:
M, T, F: 11:- 4:.
Wed: 11:- 6:
Fri-Sat: Closed

Ephraim

45 East 400 South
Ephraim, Utah 84627
(435) 283-6451
(435) 283-6452 (FAX)
Hours of Operation:
M-Th: 10:00 a.m. to 5:00 p.m.
Fri-Sat: Closed

Richfield

95 West 100 South
Richfield, Utah 84701
(435) 896-6619
(435) 896-8873 (FAX)
Hours of Operation:
Mon: Closed
T-F: 10:30 a.m. to 5:00 p.m.
Sat: Closed

Heber City

150 N Main Street, Suite 102A
Heber City, Utah 84032
(435) 657-0073
Hours of Operation:
M-F: 12:00 p.m. to 5:00 p.m.
Sat: Closed

BSA Distributors

Jensens, Inc.

29 North Main
Manti, UT 84642
(801) 835-3131

Christensen's Dept. Store

56 West Main St.
American Fork, UT 84003
(801) 756-4741

Kimos Kamera

123 South Main
Nephi, UT 84648
(801) 623-0376

Homeglo, Inc.

45 North Main
Fillmore, UT 84631
(435) 743-5178

INDEX by Core Value

Any Value

Audience Participation, 103, 111, 112, 119
 Cubmaster Minutes, 176, 177, 178, 179
 Games and Activities, 76, 81, 82, 88, 95, 98
 Gathering Activities, 16
 Opening Ceremonies, 23
 Recognition Ceremonies, 46, 49, 52, 53, 60, 63,
 64, 65, 66, 67, 68, 70
 Skits, 123, 132, 135, 137, 142

Citizenship - November

Audience Participation, 104, 107, 114, 118
 Closing Ceremonies, 182, 184, 185, 188, 190, 191,
 192, 194
 Cubmaster Minutes, 171, 172, 173, 176
 Games and Activities, 83, 84, 88, 89, 93, 94, 95,
 96, 97
 Gathering Activities, 6, 8, 10, 12, 13, 14, 15
 Opening Ceremonies, 18, 19, 20, 21, 22, 24, 25,
 26, 27, 28, 29, 30, 31, 35, 36, 37
 Recognition Ceremonies, 42, 43, 47, 52, 55, 56,
 58, 61, 62
 Skits, 125, 127, 131, 133, 139, 143

Compassion - March

Audience Participation, 106, 107, 108, 109, 110,
 114, 117
 Closing Ceremonies, 183, 184, 187, 189, 192, 193,
 194
 Cubmaster Minutes, 171, 172, 173, 174, 175, 176,
 177, 178, 180
 Games and Activities, 83, 84, 85, 86, 88, 93, 99
 Gathering Activities, 7, 8, 11
 Opening Ceremonies, 21, 24, 25, 26, 27, 29, 35,
 36
 Recognition Ceremonies, 44, 45, 48, 50, 61
 Skits, 123, 125, 128, 130, 131, 134, 135, 139, 143,
 144, 145, 146

Cooperation - September

Audience Participation, 102, 104, 105, 106, 107,
 109, 110, 113, 114, 117
 Closing Ceremonies, 184, 185, 187, 192, 194
 Cubmaster Minutes, 170, 172, 173, 174, 175, 176,
 177
 Games and Activities, 78, 79, 80, 81, 82, 83, 84,
 85, 86, 87, 88, 89, 90, 91, 92, 93, 94, 95, 96,
 97, 98, 99, 100

Gathering Activities, 8, 10, 11, 12, 13
 Opening Ceremonies, 22, 24, 27, 33, 34, 38
 Recognition Ceremonies, 43, 52, 53, 54, 55, 56,
 57, 58
 Skits, 122, 123, 125, 126, 129, 130, 131, 135, 136,
 137, 138, 139, 140, 141, 142, 143, 144, 145

Courage - July

Audience Participation, 107, 114, 115, 117
 Closing Ceremonies, 182, 184, 185, 186, 187, 188,
 190, 194
 Cubmaster Minutes, 171, 172, 173, 174, 175, 176,
 177
 Games and Activities, 79, 80, 81, 82, 83, 84, 85,
 87, 90, 91, 92, 93, 95, 96, 97, 98
 Gathering Activities, 8, 10
 Opening Ceremonies, 19, 21, 24, 25, 28, 29, 30,
 31, 32, 34, 35, 36, 37
 Recognition Ceremonies, 40, 42, 44, 45, 46, 50,
 55, 57, 58
 Skits, 123, 127, 130, 132, 133, 136, 138, 140, 141,
 143, 146

Faith - April

Closing Ceremonies, 183, 184, 186, 187, 188, 189,
 190, 192, 193, 194
 Cubmaster Minutes, 172, 173, 174, 177, 178, 179
 Games and Activities, 79, 89, 90, 94, 95
 Gathering Activities, 6, 12
 Opening Ceremonies, 19, 20, 21, 22, 26, 35
 Recognition Ceremonies, 40, 42, 44, 48, 52, 55
 Skits, 129, 131, 144

Health and Fitness - May

Audience Participation, 105, 108, 110, 113, 115,
 116, 117
 Closing Ceremonies, 182, 184, 193, 194
 Cubmaster Minutes, 173, 177, 180
 Games and Activities, 78, 79, 81, 82, 83, 84, 85,
 86, 91, 92, 93, 94, 95, 96, 97, 98, 99
 Gathering Activities, 9, 10
 Opening Ceremonies, 19, 30, 32, 33, 34
 Recognition Ceremonies, 46, 54, 57, 58
 Skits, 125, 132, 133, 134, 140, 141

Honesty - August

Audience Participation, 106
 Closing Ceremonies, 183, 184, 185, 186, 187, 188,
 189, 192, 194

Cubmaster Minutes, 170, 172, 173, 174, 175, 176, 178
 Games and Activities, 78, 79, 80, 81, 82, 84, 85, 86, 87, 88, 89, 90, 92, 93, 94, 95, 97, 99
 Gathering Activities, 6, 7, 8, 10, 11, 12, 13
 Opening Ceremonies, 19, 23, 24, 25
 Recognition Ceremonies, 43, 45, 47, 48, 52, 55
 Skits, 125, 128, 131, 133, 135, 136, 137, 139, 141, 142, 144, 145, 146

Perseverance - June

Audience Participation, 102, 105, 106, 108, 110, 113, 115, 116, 117
 Closing Ceremonies, 183, 184, 186, 187, 188, 189, 190, 191, 192
 Cubmaster Minutes, 171, 172, 173, 174, 175, 176, 177
 Games and Activities, 78, 79, 80, 81, 82, 83, 84, 85, 86, 87, 88, 89, 90, 91, 93, 94, 95, 96, 97, 98, 99
 Gathering Activities, 6, 7, 8, 9, 10, 11
 Opening Ceremonies, 20, 21, 24, 26, 29, 30
 Recognition Ceremonies, 40, 42, 45, 47, 48, 50, 53, 54, 57, 59, 61
 Skits, 125, 126, 132, 136, 137, 140, 141, 145, 146

Positive Attitude - January

Audience Participation, 106, 110, 115, 116, 117
 Closing Ceremonies, 182, 184, 187, 189, 191, 194
 Cubmaster Minutes, 171, 172, 173, 174, 175, 177, 178
 Games and Activities, 78, 79, 80, 81, 82, 83, 84, 85, 86, 87, 88, 89, 91, 92, 93, 96, 97, 98, 99
 Gathering Activities, 7, 12, 15
 Opening Ceremonies, 19, 21, 24, 25, 29, 33, 36
 Recognition Ceremonies, 45, 46, 48, 50, 52, 53, 55, 56, 57
 Skits, 122, 123, 124, 125, 126, 127, 129, 130, 133, 135, 136, 137, 138, 139, 141, 142, 143, 145, 146

Resourcefulness - February

Audience Participation, 102, 106, 107, 108, 109, 110, 113, 115

Closing Ceremonies, 186, 188, 190, 194
 Cubmaster Minutes, 171, 174, 176
 Games and Activities, 78, 79, 80, 81, 82, 83, 84, 85, 86, 87, 88, 90, 91, 92, 93, 94, 95, 96, 97, 99
 Gathering Activities, 6, 8, 10, 11, 15
 Opening Ceremonies, 18, 21, 26, 27, 28, 29, 31, 34, 35, 36
 Recognition Ceremonies, 40, 43, 44, 46, 47, 52, 54, 56, 59, 61, 62
 Skits, 122, 125, 126, 129, 130, 131, 133, 134, 135, 136, 137, 138, 140, 142, 145

Respect - December

Audience Participation, 107, 109, 114, 115, 117
 Closing Ceremonies, 182, 183, 184, 185, 186, 187, 188, 189, 190, 192, 193, 194
 Cubmaster Minutes, 170, 171, 172, 173, 174, 175, 176, 177, 178
 Games and Activities, 78, 79, 80, 81, 82, 83, 85, 87, 88, 89, 90, 92, 93, 94, 97, 98, 99
 Gathering Activities, 6, 7, 10, 12, 13, 14, 15
 Opening Ceremonies, 18, 19, 20, 21, 22, 23, 24, 25, 26, 27, 29, 30, 31, 32, 34, 35, 36, 37
 Recognition Ceremonies, 43, 44, 45, 46, 47, 50, 52, 55, 56, 58, 61, 62
 Skits, 127, 129, 131, 133, 141, 143, 144

Responsibility - October

Audience Participation, 104, 106, 107
 Closing Ceremonies, 182, 184, 186, 187, 188, 189, 190, 191, 192, 194
 Cubmaster Minutes, 170, 171, 173, 174, 176
 Games and Activities, 79, 80, 81, 82, 83, 84, 89, 90, 93, 96, 97, 98
 Gathering Activities, 7, 9, 10, 11, 13, 14, 15
 Opening Ceremonies, 18, 19, 20, 21, 22, 24, 26, 27, 28, 29, 30, 31, 34, 35, 36
 Recognition Ceremonies, 40, 42, 43, 44, 47, 50, 52, 53, 55, 56, 57, 58, 59, 61, 62
 Skits, 124, 125, 126, 128, 129, 130, 131, 133, 135, 136, 137, 138, 140, 143, 144

WHEN IS THE NEXT POW WOW?

Looking forward to next year’s Pow Wow already?
Of course we are!

Below we have listed tentative dates and locations for as many of them as we could get information for before this Pow Wow Book went to the printer. If there is not a date listed below for your area’s Pow Wow we encourage you to ask your District personnel and keep checking on your District’s and the Council’s website.

- North Pow Wow (Utah and Wasatch County) August 27, 2011
- South Pow Wow (St George area) November 5, 2011
- Central Pow Wow (Richfield).....
- Grand/San Juan Area Pow Wow
- Kings Peak/Uintah Area Pow Wow September 24, 2011
- Buckhorn/Carbon Area Pow Wow October 15,2011
- Cedar Breaks/Beaver Area Pow Wow.....
- Deseret/Millard Area Pow Wow.....
- Sanpete Area Pow Wow

All Dates are tentative and subject to change.