

**Nikon**

DIGITAL CAMERA

# D3100















---

Reference Manual

En

# Where to Find It

Find what you're looking for from:

	<b>The Table of Contents</b>		 iv–viii
Find items by function or menu name.			
	<b>The Q&amp;A Index</b>		 ii–iii
Know what you want to do but don't know the function name? Find it from the "question and answer" index.			
	<b>The Index</b>		 205–207
Search by key word.			
	<b>Error Messages</b>		 192–194
If a warning is displayed in the viewfinder or monitor, find the solution here.			
	<b>Troubleshooting</b>		 188–191
Camera behaving unexpectedly? Find the solution here.			

## **For Your Safety**

Before using the camera for the first time, read the safety instructions in "For Your Safety" ( ix–xiv).

## **Help**

Use the camera's on-board help feature for help on menu items and other topics. See page 11 for details.

## **Digitutor**

"Digitutor", a series of "watch and learn" manuals in movie form, is available from the following website: [http://www.nikondigitutor.com/index\\_eng.html](http://www.nikondigitutor.com/index_eng.html)

# D3100

<b>Q&amp;A Index</b>	 <b>ii</b>
<b>Table of Contents</b>	 <b>iv</b>
 <b>Introduction</b>	 <b>1</b>
 <b>Basic Photography and Playback</b>	 <b>23</b>
 <b>Guide Mode</b>	 <b>33</b>
 <b>Live View</b>	 <b>37</b>
 <b>Recording and Viewing Movies</b>	 <b>45</b>
 <b>Release Mode</b>	 <b>53</b>
 <b>More on Photography (All Modes)</b>	 <b>55</b>
 <b>P, S, A, and M Modes</b>	 <b>73</b>
 <b>More on Playback</b>	 <b>99</b>
 <b>Connections</b>	 <b>115</b>
 <b>The Playback Menu</b>	 <b>129</b>
 <b>The Shooting Menu</b>	 <b>131</b>
 <b>The Setup Menu</b>	 <b>136</b>
 <b>The Retouch Menu</b>	 <b>151</b>
 <b>Recent Settings</b>	 <b>165</b>
 <b>Technical Notes</b>	 <b>167</b>

## Q&A Index

Find what you're looking for using this "question and answer" index.



### Taking Photographs



#### Shooting Modes and Framing Options

Is there a quick and easy way to take snapshots?	23–27
How do I use the <b>GUIDE</b> position on the mode dial?	33–36
Can I choose a shutter speed (mode <b>S</b> )?	75
Can I choose an aperture (mode <b>A</b> )?	76
How do I make long ("time") exposures (mode <b>M</b> )?	78
Can I frame photos in the monitor?	37–43
Can I shoot movies?	45–46



#### Release Modes

Can I take photos one at a time or in quick succession?	5, 53
How do I take pictures with the self-timer?	54
Can I reduce shutter noise in quiet surroundings?	5



#### Focus

Can I choose how the camera focuses?	55–56
Can I choose the focus point?	60



#### Image Quality and Size

How do I take pictures for printing at large sizes?	64–66
How can I get more pictures on the memory card?	



#### Exposure

Can I make photos brighter or darker?	81
How do I preserve details in shadows and highlights?	85–86



#### Using the Flash

Can I set the flash to fire automatically when needed?	
How do I keep the flash from firing?	67–70
How do I avoid "red-eye"?	



### Viewing Photographs



#### Playback

How do I view photographs on the camera?	30, 99
How do I view more information about a photo?	100–104
Can I view photos in an automatic slide show?	112
Can I view photos on a TV?	126–128
Can I protect photos from accidental deletion?	108



#### Deletion

How do I delete unwanted photos?	31, 109–111
----------------------------------	-------------



## Retouching Photographs



How do I create retouched copies of photos?	151–164
How do I remove “red-eye”?	153
How do I make JPEG copies of RAW (NEF) photos?	160
Can I overlay two NEF (RAW) photos to make a single image?	158–159
Can I copy a photo to use as a base for a painting?	162
Can I trim movie footage on the camera?	50–52



## Menus and Settings



How do I adjust settings in the information display?	6–7
How do I use the menus?	11–13
How do I display menus in another language?	18, 140
How do I keep the displays from turning off?	143
How do I focus the viewfinder?	22
Can I display a framing grid in the monitor?	41
How do I set the camera clock?	18, 139
How do I format memory cards?	21
How do I restore default settings?	131, 136
Is there any way to stop the camera beeping?	144
How do I get help for a menu or message?	11, 192



## Connections



How do I copy photos to a computer?	115–116
How do I print photos?	117–125
Can I print the date of recording on my photos?	119, 125, 147



## Maintenance and Optional Accessories



What memory cards can I use?	177
What lenses can I use?	167
What optional flash units (Speedlights) can I use?	172
What other accessories are available for my camera?	176
What software is available for my camera?	176
What do I do with the supplied eyepiece cap?	54
How do I clean the camera?	179
Where should I take my camera for servicing and repairs?	179

# Table of Contents

Q&A Index .....	ii
For Your Safety .....	ix
Notices.....	xi











## Introduction **1**

---

Overview .....	1
Getting to Know the Camera.....	2
The Camera Body .....	2
The Mode Dial.....	4
The Release-Mode Selector .....	5
The Information Display.....	6
The Command Dial .....	8
The Viewfinder.....	10
Camera Menus.....	11
Using Camera Menus .....	12
First Steps .....	14
Charge the Battery .....	14
Insert the Battery .....	15
Attach a Lens.....	16
Basic Setup.....	18
Insert a Memory Card.....	20
Format the Memory Card .....	21
Adjust Viewfinder Focus .....	22

## Basic Photography and Playback **23**

---

“Point-and-Shoot” Photography (  and  Modes).....	23
Step 1: Turn the Camera On.....	23
Step 2: Select  or  Mode .....	24
Step 3: Frame the Photograph .....	25
Step 4: Focus .....	26
Step 5: Shoot .....	26
Creative Photography (Scene Modes) .....	28
 <i>Portrait</i> .....	28
 <i>Landscape</i> .....	28
 <i>Child</i> .....	29
 <i>Sports</i> .....	29
 <i>Close Up</i> .....	29
 <i>Night Portrait</i> .....	29
Basic Playback.....	30
Deleting Unwanted Photographs .....	31

---

**Guide Mode** **33**

---

The Guide .....	33
Guide Mode Menus.....	34

---

**Live View** **37**

---

Framing Photographs in the Monitor .....	37
--	----

---

**Recording and Viewing Movies** **45**

---

Recording Movies .....	45
Viewing Movies .....	49
Editing Movies .....	50
Trimming Movies .....	50
Saving Selected Frames.....	52

---

**Release Mode** **53**

---

Choosing a Release Mode .....	53
Self-Timer Mode .....	54

---

**More on Photography (All Modes)** **55**

---

Focus .....	55
Focus Mode.....	55
AF-Area Mode .....	58
Focus Point Selection .....	60
Focus Lock .....	60
Manual Focus .....	62
Image Quality and Size .....	64
Image Quality .....	64
Image Size.....	66
Using the Built-in Flash.....	67
Flash Mode .....	68
ISO Sensitivity.....	71

---

**P, S, A, and M Modes** **73**

---

Shutter Speed and Aperture.....	73
Mode <b>P</b> (Programmed Auto) .....	74
Mode <b>S</b> (Shutter-Priority Auto) .....	75
Mode <b>A</b> (Aperture-Priority Auto).....	76
Mode <b>M</b> (Manual).....	77

Exposure .....	79
Metering .....	79
Autoexposure Lock .....	80
Exposure Compensation.....	81
Flash Compensation.....	83
Active D-Lighting.....	85
White Balance .....	87
Fine-Tuning White Balance.....	89
Preset Manual .....	90
Picture Controls.....	94
Selecting a Picture Control.....	94
Modifying Picture Controls.....	95
The GP-1 GPS Unit .....	98

## **More on Playback** **99**

---

Full-Frame Playback.....	99
Photo Information.....	100
Thumbnail Playback .....	105
Calendar Playback .....	106
Taking a Closer Look: Playback Zoom.....	107
Protecting Photographs from Deletion.....	108
Deleting Photographs .....	109
Full-Frame, Thumbnail, and Calendar Playback.....	109
The Playback Menu .....	110
Slide Shows.....	112

## **Connections** **115**

---

Connecting to a Computer .....	115
Before Connecting the Camera.....	115
Connecting the Camera .....	116
Printing Photographs.....	117
Connecting the Printer.....	117
Printing Pictures One at a Time.....	118
Printing Multiple Pictures.....	120
Creating Index Prints.....	123
Creating a DPOF Print Order: Print Set .....	124
Viewing Photographs on TV.....	126
Standard Definition Devices.....	126
High-Definition Devices.....	127



- ▶ The Playback Menu: *Managing Images* ..... 129
  - Playback Folder ..... 129
  - Display Mode ..... 130
  - Image Review ..... 130
  - Rotate Tall ..... 130
- 📷 The Shooting Menu: *Shooting Options* ..... 131
  - Reset Shooting Options ..... 131
  - ISO Sensitivity Settings ..... 132
  - Auto Distortion Control ..... 133
  - Color Space ..... 133
  - Noise Reduction ..... 134
  - AF-Assist ..... 134
  - Built-in Flash ..... 135
- ⚙ The Setup Menu: *Camera Setup* ..... 136
  - Reset Setup Options ..... 136
  - LCD Brightness ..... 137
  - Info Display Format ..... 137
  - Auto Info Display ..... 139
  - Video Mode ..... 139
  - Flicker Reduction ..... 139
  - Time Zone and Date ..... 139
  - Language ..... 140
  - Image Comment ..... 140
  - Auto Image Rotation ..... 141
  - Dust off Ref Photo ..... 141
  - Auto off Timers ..... 143
  - Self-Timer Delay ..... 143
  - Beep ..... 144
  - Rangefinder ..... 144
  - File Number Sequence ..... 145
  - Buttons ..... 146
  - Slot Empty Release Lock ..... 147
  - Date Imprint ..... 147
  - Storage Folder ..... 149
  - Eye-Fi Upload ..... 150
  - Firmware Version ..... 150
- ✂ The Retouch Menu: *Creating Retouched Copies* ..... 151
  - Creating Retouched Copies ..... 152
    - D-Lighting ..... 153
    - Red-Eye Correction ..... 153
    - Trim ..... 154
    - Monochrome ..... 154
    - Filter Effects ..... 155
    - Color Balance ..... 156

Small Picture .....	156
Image Overlay .....	158
NEF (RAW) Processing .....	160
Quick Retouch .....	161
Straighten .....	161
Distortion Control .....	161
Fisheye .....	162
Color Outline .....	162
Perspective Control .....	162
Miniature Effect .....	163
Before and After .....	164
 Recent Settings .....	165

## Technical Notes

**167**

Compatible Lenses .....	167
Compatible CPU Lenses .....	167
Compatible Non-CPU Lenses .....	169
Optional Flash Units (Speedlights) .....	172
The Nikon Creative Lighting System (CLS) .....	173
Other Accessories .....	176
Approved Memory Cards .....	177
Attaching a Power Connector and AC Adapter .....	178
Caring for the Camera .....	179
Storage .....	179
Cleaning .....	179
The Low-Pass Filter .....	180
Caring for the Camera and Battery: Cautions .....	184
Available Settings .....	186
Memory Card Capacity .....	187
Troubleshooting .....	188
Display .....	188
Shooting (All Modes) .....	188
Shooting ( <b>P</b> , <b>S</b> , <b>A</b> , <b>M</b> ) .....	190
Playback .....	190
Miscellaneous .....	191
Error Messages .....	192
Specifications .....	195
Battery Life .....	204
Index .....	205

# For Your Safety









To prevent damage to your Nikon product or injury to yourself or to others, read the following safety precautions in their entirety before using this equipment. Keep these safety instructions where all those who use the product will read them.

The consequences that could result from failure to observe the precautions listed in this section are indicated by the following symbol:



This icon marks warnings. To prevent possible injury, read all warnings before using this Nikon product.

## ■ ■ WARNINGS

-  **Keep the sun out of the frame**  
Keep the sun well out of the frame when shooting backlit subjects. Sunlight focused into the camera when the sun is in or close to the frame could cause a fire.
-  **Do not look at the sun through the viewfinder**  
Viewing the sun or other strong light source through the viewfinder could cause permanent visual impairment.
-  **Using the viewfinder diopter control**  
When operating the viewfinder diopter control with your eye to the viewfinder, care should be taken not to put your finger in your eye accidentally.
-  **Turn off immediately in the event of malfunction**  
Should you notice smoke or an unusual smell coming from the equipment or AC adapter (available separately), unplug the AC adapter and remove the battery immediately, taking care to avoid burns. Continued operation could result in injury. After removing the battery, take the equipment to a Nikon-authorized service center for inspection.
-  **Do not use in the presence of flammable gas**  
Do not use electronic equipment in the presence of flammable gas, as this could result in explosion or fire.
-  **Keep out of reach of children**  
Failure to observe this precaution could result in injury.
-  **Do not disassemble**  
Touching the product's internal parts could result in injury. In the event of malfunction, the product should be repaired only by a qualified technician. Should the product break open as the result of a fall or other accident, remove the battery and/or AC adapter and then take the product to a Nikon-authorized service center for inspection.
-  **Do not place the strap around the neck of an infant or child**  
Placing the camera strap around the neck of an infant or child could result in strangulation.
-  **Observe caution when using the flash**

  - Using the camera with the flash in close contact with the skin or other objects could cause burns.
  - Using the flash close to the subject's eyes could cause temporary visual impairment. Particular care should be observed when photographing infants, when the flash should be no less than one meter (39 in.) from the subject.
-  **Avoid contact with liquid crystal**  
Should the monitor break, care should be taken to avoid injury due to broken glass and to prevent the liquid crystal from the monitor touching the skin or entering the eyes or mouth.

**⚠ Observe proper precautions when handling batteries**

Batteries may leak or explode if improperly handled. Observe the following precautions when handling batteries for use in this product:

- Use only batteries approved for use in this equipment.
- Do not short or disassemble the battery.
- Be sure the product is off before replacing the battery. If you are using an AC adapter, be sure it is unplugged.
- Do not attempt to insert the battery upside down or backwards.
- Do not expose the battery to flame or to excessive heat.
- Do not immerse in or expose to water.
- Replace the terminal cover when transporting the battery. Do not transport or store the battery with metal objects such as necklaces or hairpins.
- Batteries are prone to leakage when fully discharged. To avoid damage to the product, be sure to remove the battery when no charge remains.
- When the battery is not in use, attach the terminal cover and store in a cool, dry place.
- The battery may be hot immediately after use or when the product has been used on battery power for an extended period. Before removing the battery turn the camera off and allow the battery to cool.
- Discontinue use immediately should you notice any changes in the battery, such as discoloration or deformation.

**⚠ Observe proper precautions when handling the charger**

- Keep dry. Failure to observe this precaution could result in fire or electric shock.
- Do not short the charger terminals. Failure to observe this precaution could result in overheating and damage to the charger.
- Dust on or near the metal parts of the plug should be removed with a dry cloth. Continued use could result in fire.
- Do not go near the charger during thunderstorms. Failure to observe this precaution could result in electric shock.
- Do not handle the plug or charger with wet hands. Failure to observe this precaution could result in electric shock.
- Do not use with travel converters or adapters designed to convert from one voltage to another or with DC-to-AC inverters. Failure to observe this precaution could damage the product or cause overheating or fire.

**⚠ Use appropriate cables**

When connecting cables to the input and output jacks, use only the cables provided or sold by Nikon for the purpose to maintain compliance with product regulations.

**⚠ CD-ROMs**

CD-ROMs containing software or manuals should not be played back on audio CD equipment. Playing CD-ROMs on an audio CD player could cause hearing loss or damage the equipment.

# Notices

- No part of the manuals included with this product may be reproduced, transmitted, transcribed, stored in a retrieval system, or translated into any language in any form, by any means, without Nikon's prior written permission.
- Nikon reserves the right to change the specifications of the hardware and software described in these manuals at any time and without prior notice.
- Nikon will not be held liable for any damages resulting from the use of this product.
- While every effort has been made to ensure that the information in these manuals is accurate and complete, we would appreciate it were you to bring any errors or omissions to the attention of the Nikon representative in your area (address provided separately).

## **Notice for Customers in Canada**

### **CAUTION**

This Class B digital apparatus complies with Canadian ICES-003.

### **ATTENTION**

Cet appareil numérique de la classe B est conforme à la norme NMB-003 du Canada.

## **Notices for Customers in Europe**

### **CAUTION**

RISK OF EXPLOSION IF BATTERY IS REPLACED BY AN INCORRECT TYPE. DISPOSE OF USED BATTERIES ACCORDING TO THE INSTRUCTIONS.

This symbol indicates that this product is to be collected separately.



The following apply only to users in  European countries:

- This product is designated for separate collection at an appropriate collection point. Do not dispose of as household waste.
- For more information, contact the retailer or the local authorities in charge of waste management.

This symbol on the battery indicates that the battery is to be collected separately.



The following apply only to users in European countries:

- All batteries, whether marked with this symbol or not, are designated for separate collection at an appropriate collection point. Do not dispose of as household waste.
- For more information, contact the retailer or the local authorities in charge of waste management.

## Notices for Customers in the U.S.A.

### The Battery Charger

# IMPORTANT SAFETY INSTRUCTIONS—SAVE THESE INSTRUCTIONS DANGER—TO REDUCE THE RISK OF FIRE OR ELECTRIC SHOCK, CAREFULLY FOLLOW THESE INSTRUCTIONS

For connection to a supply not in the U.S.A., use an attachment plug adapter of the proper configuration for the power outlet if needed. This power unit is intended to be correctly oriented in a vertical or floor mount position.

### Federal Communications Commission (FCC) Radio Frequency Interference Statement

This equipment has been tested and found to comply with the limits for a Class B digital device, pursuant to Part 15 of the FCC rules.

These limits are designed to provide reasonable protection against harmful interference in a residential installation. This equipment generates, uses, and can radiate radio frequency energy and, if not installed and used in accordance with the instructions, may cause harmful interference to radio communications. However, there is no guarantee that interference will not occur in a particular installation. If this equipment does cause harmful interference to radio or television reception, which can be determined by turning the equipment off and on, the user is encouraged to try to correct the interference by one or more of the following measures:

- Reorient or relocate the receiving antenna.
- Increase the separation between the equipment and receiver.
- Connect the equipment into an outlet on a circuit different from that to which the receiver is connected.
- Consult the dealer or an experienced radio/television technician for help.



**Nikon**  
D3100

### CAUTIONS

#### *Modifications*

The FCC requires the user be notified that any changes or modifications made to this device that are not expressly approved by Nikon Corporation may void the user's authority to operate the equipment.

#### *Interface Cables*

Use the interface cables sold or provided by Nikon for your equipment. Using other interface cables may exceed the limits of Class B Part 15 of the FCC rules.

#### **Notice for Customers in the State of California**

**WARNING:** Handling the cord on this product may expose you to lead, a chemical known to the State of California to cause birth defects or other reproductive harm. *Wash hands after handling.*

Nikon Inc., 1300 Walt Whitman Road, Melville, New York 11747-3064, U.S.A.  
Tel.: 631-547-4200

### ***Notice Concerning Prohibition of Copying or Reproduction***

Note that simply being in possession of material that has been digitally copied or reproduced by means of a scanner, digital camera, or other device may be punishable by law.

- **Items prohibited by law from being copied or reproduced**

Do not copy or reproduce paper money, coins, securities, government bonds, or local government bonds, even if such copies or reproductions are stamped “Sample.”

The copying or reproduction of paper money, coins, or securities which are circulated in a foreign country is prohibited.

Unless the prior permission of the government has been obtained, the copying or reproduction of unused postage stamps or post cards issued by the government is prohibited.

The copying or reproduction of stamps issued by the government and of certified documents stipulated by law is prohibited.

- **Cautions on certain copies and reproductions**

The government has issued cautions on copies or reproductions of securities issued by private companies (shares, bills, checks, gift certificates, etc.), commuter passes, or coupon tickets, except when a minimum of necessary copies are to be provided for business use by a company. Also, do not copy or reproduce passports issued by the government, licenses issued by public agencies and private groups, ID cards, and tickets, such as passes and meal coupons.

- **Comply with copyright notices**

The copying or reproduction of copyrighted creative works such as books, music, paintings, woodcuts, prints, maps, drawings, movies, and photographs is governed by national and international copyright laws. Do not use this product for the purpose of making illegal copies or to infringe copyright laws.

### ***Disposing of Data Storage Devices***

Please note that deleting images or formatting memory cards or other data storage devices does not completely erase the original image data. Deleted files can sometimes be recovered from discarded storage devices using commercially available software, potentially resulting in the malicious use of personal image data. Ensuring the privacy of such data is the user’s responsibility.

Before discarding a data storage device or transferring ownership to another person, erase all data using commercial deletion software, or format the device and then completely refill it with images containing no private information (for example, pictures of empty sky). Be sure to also replace any pictures selected for preset manual white balance (□ 90). Care should be taken to avoid injury when physically destroying data storage devices.

### **Use Only Nikon Brand Electronic Accessories**

Nikon cameras are designed to the highest standards and include complex electronic circuitry. Only Nikon brand electronic accessories (including chargers, batteries, AC adapters, and flash accessories) certified by Nikon specifically for use with this Nikon digital camera are engineered and proven to operate within the operational and safety requirements of this electronic circuitry.

The use of non-Nikon electronic accessories could damage the camera and may void your Nikon warranty. The use of third-party rechargeable Li-ion batteries not bearing the Nikon holographic seal shown at right could interfere with normal operation of the camera or result in the batteries overheating, igniting, rupturing, or leaking.

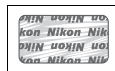

For more information about Nikon brand accessories, contact a local authorized Nikon dealer.

### **AVC Patent Portfolio License**

THIS PRODUCT IS LICENSED UNDER THE AVC PATENT PORTFOLIO LICENSE FOR THE PERSONAL AND NON-COMMERCIAL USE OF A CONSUMER TO (i) ENCODE VIDEO IN COMPLIANCE WITH THE AVC STANDARD ("AVC VIDEO") AND/OR (ii) DECODE AVC VIDEO THAT WAS ENCODED BY A CONSUMER ENGAGED IN A PERSONAL AND NON-COMMERCIAL ACTIVITY AND/OR WAS OBTAINED FROM A VIDEO PROVIDER LICENSED TO PROVIDE AVC VIDEO. NO LICENSE IS GRANTED OR SHALL BE IMPLIED FOR ANY OTHER USE. ADDITIONAL INFORMATION MAY BE OBTAINED FROM MPEG LA, L.L.C. SEE <http://www.mpegla.com>

#### **Before Taking Important Pictures**

Before taking pictures on important occasions (such as at weddings or before taking the camera on a trip), take a test shot to ensure that the camera is functioning normally. Nikon will not be held liable for damages or lost profits that may result from product malfunction.

#### **Life-Long Learning**

As part of Nikon's "Life-Long Learning" commitment to ongoing product support and education, continually-updated information is available on-line at the following sites:

- **For users in the U.S.A.:** <http://www.nikonusa.com/>
- **For users in Europe and Africa:** <http://www.europe-nikon.com/support/>
- **For users in Asia, Oceania, and the Middle East:** <http://www.nikon-asia.com/>

Visit these sites to keep up-to-date with the latest product information, tips, answers to frequently-asked questions (FAQs), and general advice on digital imaging and photography. Additional information may be available from the Nikon representative in your area. See the following URL for contact information: <http://imaging.nikon.com/>





# Introduction

## Overview

Thank you for your purchase of a Nikon single-lens reflex (SLR) digital camera. To get the most from your camera, please be sure to read all instructions thoroughly and keep them where they will be read by all who use the product.

### ■ *Symbols and Conventions*

To make it easier to find the information you need, the following symbols and conventions are used:



This icon marks cautions; information that should be read before use to prevent damage to the camera.



This icon marks notes; information that should be read before using the camera.



This icon marks references to other pages in this manual.

#### **✓ Use Only Nikon Brand Accessories**

Only Nikon brand accessories certified by Nikon specifically for use with your Nikon digital camera are engineered and proven to operate within its operational and safety requirements. THE USE OF NON-NIKON ACCESSORIES COULD DAMAGE YOUR CAMERA AND MAY VOID YOUR NIKON WARRANTY.

#### **✓ Servicing the Camera and Accessories**

The camera is a precision device and requires regular servicing. Nikon recommends that the camera be inspected by the original retailer or a Nikon-authorized service representative once every one to two years, and that it be serviced once every three to five years (note that fees apply to these services). Frequent inspection and servicing are particularly recommended if the camera is used professionally. Any accessories regularly used with the camera, such as lenses or optional flash units, should be included when the camera is inspected or serviced.

#### **✎ Camera Settings**

The explanations in this manual assume that default settings are used.



# Getting to Know the Camera

Take a few moments to familiarize yourself with camera controls and displays. You may find it helpful to bookmark this section and refer to it as you read through the rest of the manual.

## The Camera Body

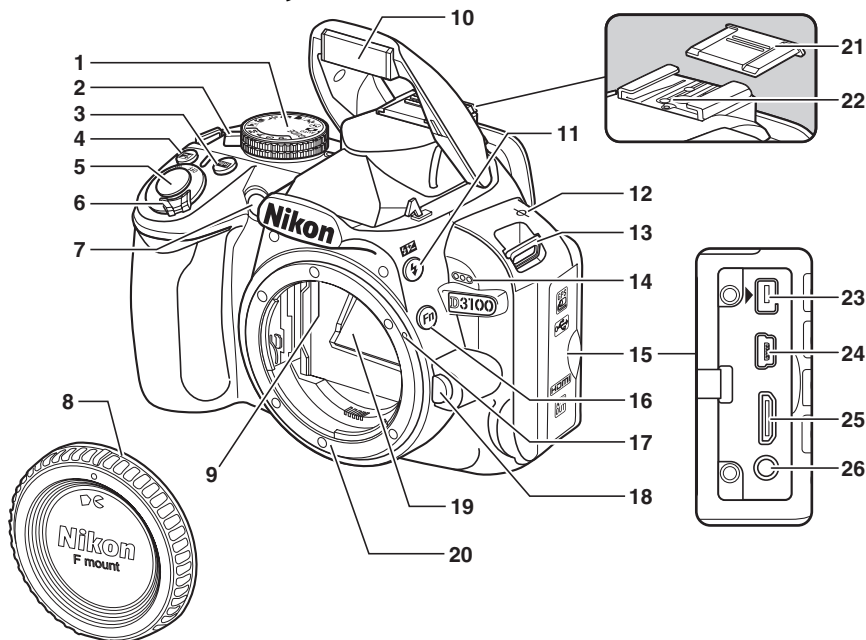

<b>1</b> Mode dial ..... 4	<b>9</b> CPU contacts	<b>19</b> Mirror ..... 182
<b>2</b> Release-mode selector ..... 5, 53	<b>10</b> Built-in flash ..... 67	<b>20</b> Lens mount ..... 63
<b>3</b> (information) button .... 7, 41	<b>11</b> (flash mode) button ..... 67	<b>21</b> Accessory shoe cover ..... 172
<b>4</b> (exposure compensation) button ..... 82	(flash compensation) button ..... 84	<b>22</b> Accessory shoe (for optional flash units) ..... 172
(aperture) button ..... 77	<b>12</b> Focal plane mark (☉) ..... 63	<b>23</b> Accessory terminal ..... 177
Flash compensation button ..... 84	<b>13</b> Eyelet for camera strap	<b>24</b> USB connector
<b>5</b> Shutter-release button ..... 27	<b>14</b> Microphone ..... 46	Connecting to a computer ..... 116
<b>6</b> Power switch ..... 3	<b>15</b> Connector cover	Connecting to a printer ... 117
<b>7</b> AF-assist illuminator ..... 57	<b>16</b> Fn (function) button ..... 146	<b>25</b> HDMI mini-pin connector ... 127
Self-timer lamp ..... 54	<b>17</b> Mounting mark ..... 16	<b>26</b> A/V connector ..... 126
Red-eye reduction lamp ..... 69	<b>18</b> Lens release button ..... 17	
<b>8</b> Body cap		

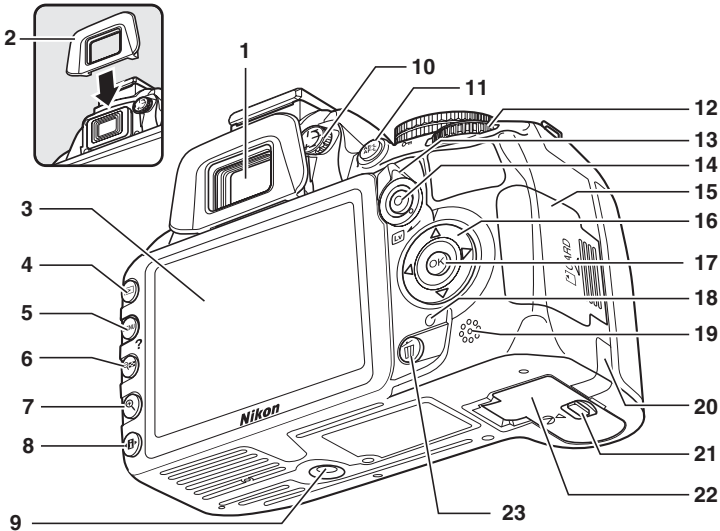

<b>1</b> Viewfinder eyepiece.....54	<b>8</b> (information edit) button.....6	<b>18</b> Memory card access lamp ..... 20, 26
<b>2</b> Rubber eyecup	<b>9</b> Tripod socket	<b>19</b> Speaker .....49
<b>3</b> Monitor	<b>10</b> Diopter adjustment control ..... 22	<b>20</b> Power connector cover for optional power connector .....178
Viewing settings .....6	<b>11</b> (AE-L/AF-L) button.....61, 146	<b>21</b> Battery-chamber cover latch ..... 15
Live view .....37	<b>12</b> (protect) button ..... 108	<b>22</b> Battery-chamber cover ..... 15
Viewing pictures.....30	<b>13</b> Command dial .....8	<b>23</b> (delete) button
Full-frame playback .....99	<b>14</b> Live view switch .....37, 45	Deleting pictures..... 31
<b>4</b> (playback) button .....30, 99	<b>15</b> Movie-record button..... 46	Deleting pictures during playback .....109
<b>5</b> MENU (menu) button .....11, 129	<b>16</b> Memory card slot cover..... 20	
<b>6</b> (thumbnail/playback zoom out) button ..... 105	<b>17</b> Multi selector ..... 12	
? (help) button.....11	<b>18</b> (OK) button..... 12	
<b>7</b> (playback zoom in) button ..... 107		

### The Power Switch

Rotate the power switch as shown to turn the camera on.

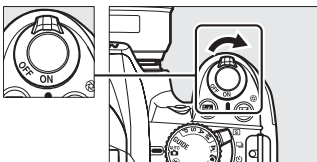

Rotate the power switch as shown to turn the camera off.

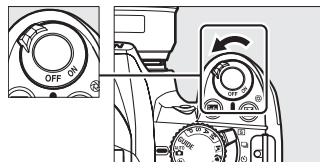

# The Mode Dial

The camera offers a choice of the following shooting modes and **GUIDE** mode:

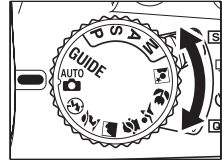

## P, S, A, and M Modes

Select these modes for full control over camera settings.

- **P—Programmed auto** (☞ 74)
- **S—Shutter-priority auto** (☞ 75)
- **A—Aperture-priority auto** (☞ 76)
- **M—Manual** (☞ 77)

## GUIDE Mode (☞ 33)

Take and view pictures and adjust settings with the help of an on-screen guide.

## Auto Modes

Select these modes for simple, point-and-shoot photography.



-  **Auto** (☞ 23)
-  **Auto (flash off)** (☞ 23)

## Scene Modes

The camera automatically optimizes settings to suit the scene selected with the mode dial. Match your selection to the scene being photographed.

-  **Portrait** (☞ 28)
-  **Landscape** (☞ 28)
-  **Child** (☞ 29)
-  **Sports** (☞ 29)
-  **Close up** (☞ 29)
-  **Night portrait** (☞ 29)

## Scene Auto Selector (Live View)

Selecting live view in  or  mode enables automatic scene selection (“scene auto selector”; ☞ 41) when autofocus is used.

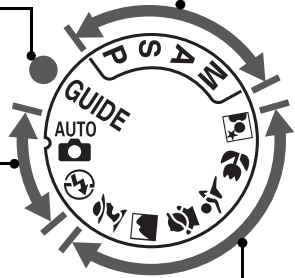

# The Release-Mode Selector

Use the release-mode selector to choose from the following release modes:

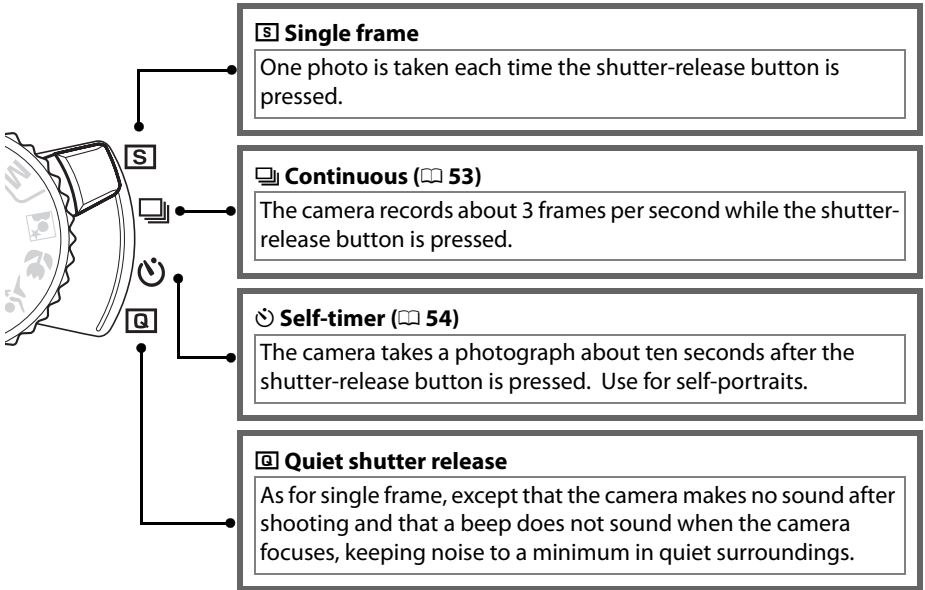
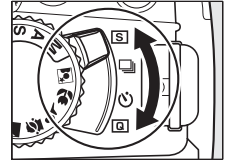

# The Information Display

Camera settings can be viewed and adjusted in the information display. Press the **ⓘ** button once to view settings, and again to make changes to settings. Highlight items using the multi-selector and press **OK** to view options for the highlighted item.

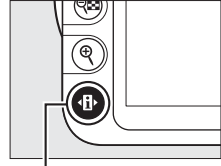

**ⓘ** button

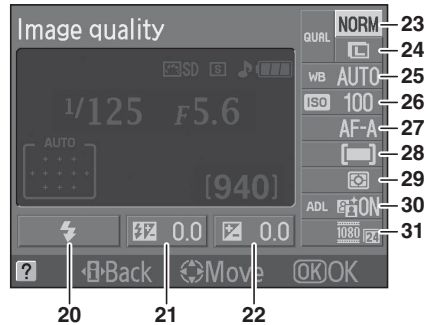
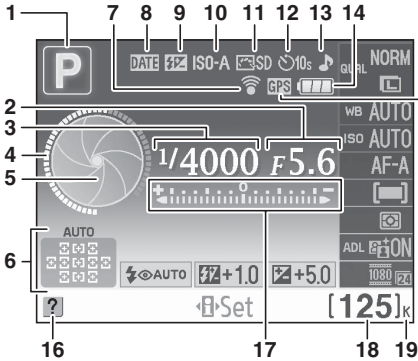

<b>1</b> Shooting mode <b>Ⓜ</b> auto/ <b>Ⓜ</b> auto (flash off) ..... 23 Scene modes ..... 28 Guide mode ..... 33 <b>P, S, A, and M</b> modes..... 73	<b>10</b> Auto ISO sensitivity indicator ..... 132	<b>20</b> Flash mode ..... 68
<b>2</b> Aperture (f-number) .....76, 77	<b>11</b> Picture Control .....94	<b>21</b> Flash compensation ..... 83
<b>3</b> Shutter speed .....75, 77	<b>12</b> Release mode .....5, 53	<b>22</b> Exposure compensation..... 81
<b>4</b> Shutter-speed display.....7	<b>13</b> “Beep” indicator .....144	<b>23</b> Image quality ..... 64
<b>5</b> Aperture display.....7	<b>14</b> Battery indicator .....23	<b>24</b> Image size ..... 66
<b>6</b> Auto-area AF indicator ..... 58 3D-tracking indicator..... 58 Focus point ..... 60	<b>15</b> GPS connection indicator.....98	<b>25</b> White balance ..... 87
<b>7</b> Eye-Fi connection indicator ..... 150	<b>16</b> Help icon .....192	<b>26</b> ISO sensitivity..... 71
<b>8</b> Date imprint indicator ..... 147	<b>17</b> Exposure indicator .....77 Exposure compensation indicator .....82 Electronic rangefinder.....144	<b>27</b> Focus mode .....38, 55
<b>9</b> Manual flash indicator ..... 135 Flash compensation indicator for optional flash units ... 175	<b>18</b> Number of exposures remaining .....24	<b>28</b> AF-area mode ..... 58
	<b>19</b> “K” (appears when memory remains for over 1000 exposures).....24	<b>29</b> Metering..... 79
		<b>30</b> Active D-Lighting..... 85
		<b>31</b> Movie frame size ..... 47

## Hiding Shooting Information

To turn the monitor off, press the **Info** button. Note that the monitor turns off automatically while the shutter-release button is pressed or if no operations are performed for about 8 s (for information on choosing how long the monitor stays on, see **Auto off timers** on page 143). The information display can be restored by pressing the **Info** button again.

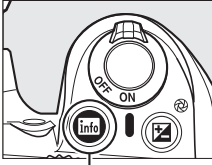

**Info** button



Information display

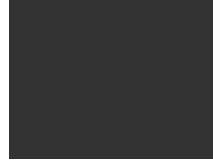

Monitor off

## Rotating the Camera

When the camera is rotated 90°, shooting information rotates to match camera orientation.



## The Shutter-Speed and Aperture Displays

These displays provide visual indications of shutter speed and aperture.

*Fast shutter speed, large aperture  
(small f-number).*



*Slow shutter speed, small aperture  
(large f-number).*



While the mode dial is rotated, this display is replaced by an image of the mode dial.

## See Also

For information on choosing a design for the information display, see **Info display format**, (□ 137). For information on choosing whether information is displayed when the shutter-release button is pressed; see **Auto info display** (□ 139).



# The Command Dial

The command dial can be used with other controls to adjust a variety of settings when shooting information is displayed in the monitor.

**⚡ button**

**Fn button**

**☑ button**

**Mode dial**

**Command dial**

Choose a combination of aperture and shutter speed (mode **P**; 74).

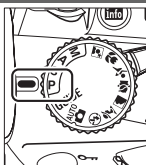

Mode **P**



Command dial



Information display

Choose a shutter speed (mode **S** or **M**; 75, 77).

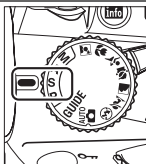

Mode **S** or **M**

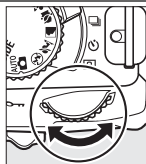

Command dial



Information display

Choose an aperture (mode **A**; 76).

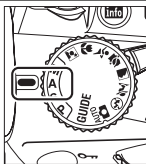

Mode **A**

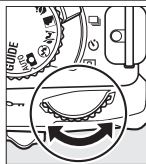

Command dial



Information display

Choose an aperture (mode **M**; 77).

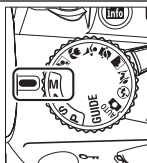

Mode **M**

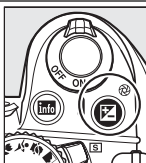

☑ button

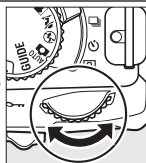

Command dial



Information display



Set exposure compensation (mode P, S, or A; 81).

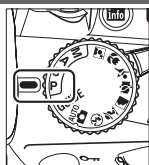

Mode P, S, or A

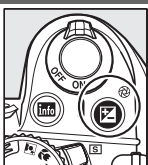

Fn button



Command dial

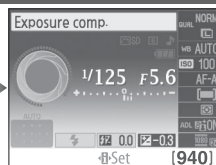

Information display

Choose a flash mode ( 68).

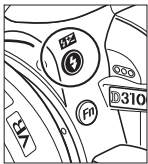

Fn button

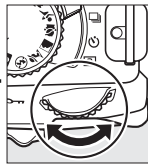

Command dial

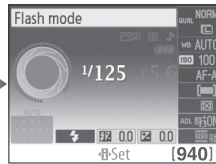

Information display

Adjust flash compensation (mode P, S, A, or M; 83).

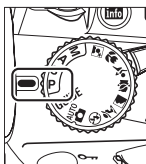

P, S, A, or M

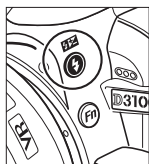

Fn button

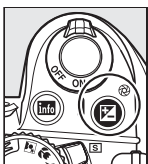

Fn button

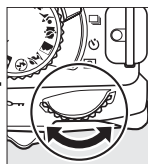

Command dial

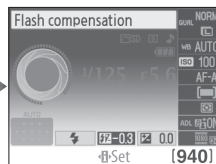

Information display

The role of the **Fn** button can be selected using the **Buttons > Fn button** option in the setup menu ( 146), allowing the following settings to be adjusted by pressing the **Fn** button and rotating the command dial:

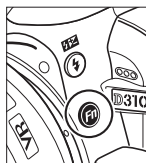

Fn button

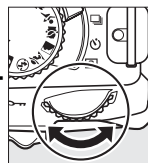

Command dial

Image quality/size ( 64)



ISO sensitivity ( 71)

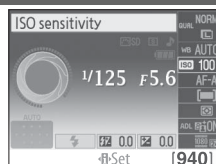

White balance ( 87)

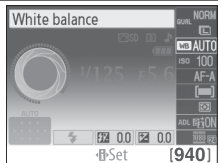

Active D-Lighting ( 85)



# The Viewfinder

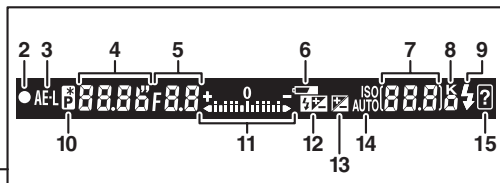
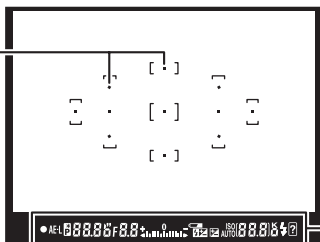
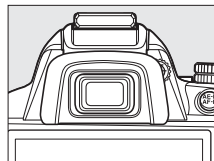

<p><b>1</b> Focus points ..... 60</p> <p><b>2</b> Focus indicator .....26, 63</p> <p><b>3</b> Autoexposure (AE) lock indicator..... 80</p> <p><b>4</b> Shutter speed .....75, 77</p> <p><b>5</b> Aperture (f-number) .....76, 77</p> <p><b>6</b> Battery indicator ..... 23</p>	<p><b>7</b> Number of exposures remaining ..... 24</p> <p>Number of shots remaining before memory buffer fills ..... 53</p> <p>White balance recording indicator .....90</p> <p>Exposure compensation value ..... 81</p> <p>Flash compensation value.....83</p> <p>ISO sensitivity..... 71</p> <p><b>8</b> "K" (appears when memory remains for over 1000 exposures) .....24</p>	<p><b>9</b> Flash-ready indicator .....27</p> <p><b>10</b> Flexible program indicator .....74</p> <p><b>11</b> Exposure indicator .....77</p> <p>Exposure compensation display .....82</p> <p>Electronic rangefinder.....63</p> <p><b>12</b> Flash compensation indicator .....83</p> <p><b>13</b> Exposure compensation indicator .....81</p> <p><b>14</b> Auto ISO sensitivity indicator .....132</p> <p><b>15</b> Warning indicator.....192</p>
---	--	--

## The Viewfinder

The response time and brightness of the viewfinder display may vary with temperature.

# Camera Menu

Most shooting, playback, and setup options can be accessed from the camera menu. To view the menu, press the **MENU** button.

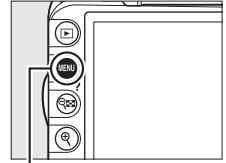

MENU button

## Tabs

Choose from the following menus:

- : **Playback** (☐ 129)
- : **Shooting** (☐ 131)
- : **Setup** (☐ 136)
- : **Retouch** (☐ 151)
- : **Recent settings** (☐ 165)

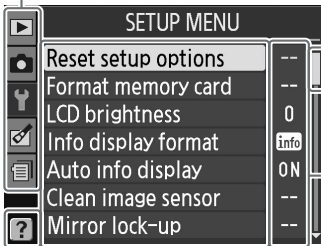

Slider shows position in current menu.

Current settings are shown by icons.

### Menu options

Options in current menu.



If a icon is displayed at the bottom left corner of the monitor, help can be displayed by pressing the button. A description of the currently selected option or menu will be displayed while the button is pressed. Press or to scroll through the display.

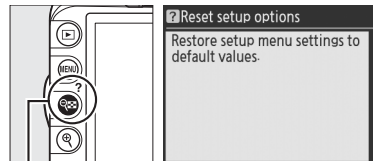

button

## Guide Mode

To display the on-screen guide, rotate the mode dial to **GUIDE** (☐ 33).



# Using Camera Menus

The multi selector and **OK** button are used to navigate the camera menus.

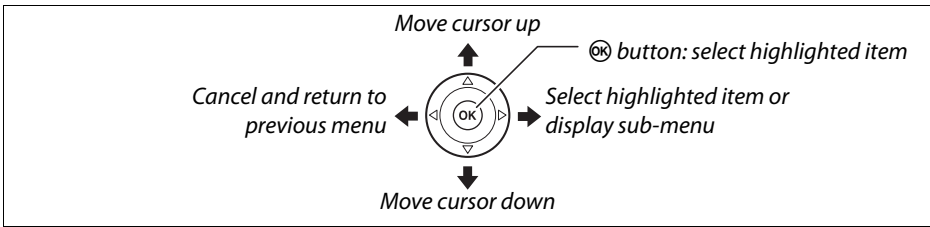

Follow the steps below to navigate the menus.

## 1 Display the menus.

Press the **MENU** button to display the menus.

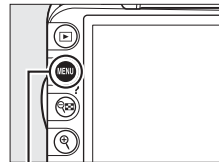

MENU button

## 2 Highlight the icon for the current menu.

Press **◀** to highlight the icon for the current menu.

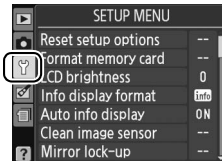

## 3 Select a menu.

Press **▲** or **▼** to select the desired menu.

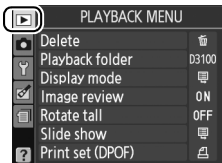
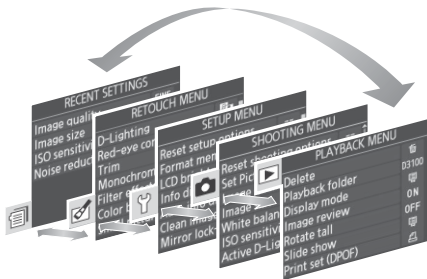

#### 4 Position the cursor in the selected menu.

Press **▶** to position the cursor in the selected menu.

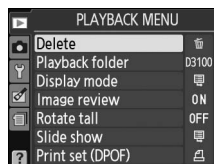

#### 5 Highlight a menu item.

Press **▲** or **▼** to highlight a menu item.

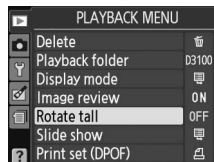

#### 6 Display options.

Press **▶** to display options for the selected menu item.

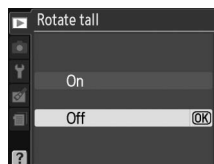

#### 7 Highlight an option.

Press **▲** or **▼** to highlight an option.

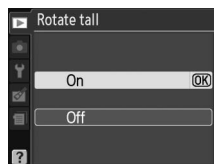

#### 8 Select the highlighted item.

Press **OK** to select the highlighted item. To exit without making a selection, press the **MENU** button.



Note the following:

- Menu items that are displayed in gray are not currently available.
- While pressing **▶** generally has the same effect as pressing **OK**, there are some cases in which selection can only be made by pressing **OK**.
- To exit the menus and return to shooting mode, press the shutter-release button halfway (□ 27).



# First Steps

## Charge the Battery

The camera is powered by an EN-EL14 rechargeable Li-ion battery (supplied). To maximize shooting time, charge the battery in the supplied MH-24 battery charger before use. About 1 hour and 30 minutes are required to fully recharge the battery when no charge remains.

### The Plug Adapter

Depending on the country or region of purchase, a plug adapter may be supplied with the charger. The shape of the adapter varies with the country or region of purchase. If a plug adapter is supplied, raise the wall plug and connect the plug adapter as shown at right, making sure the plug is fully inserted. Attempting to forcibly remove the plug adapter could damage the product.

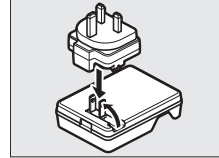

### 1 Remove the terminal cover.

Remove the terminal cover from the battery.

### 2 Insert the battery.

Insert the battery as shown in the illustration on the charger.

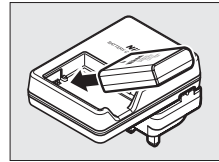

### Charging the Battery

Charge the battery indoors at ambient temperatures between 5–35 °C (41–95 °F). The battery will not charge if its temperature is below 0 °C (32 °F) or above 60 °C (140 °F).

### 3 Plug the charger in.

The **CHARGE** lamp will blink while the battery charges.

### During Charging

Do not move the charger or touch the battery during charging. Failure to observe this precaution could in very rare instances result in the charger showing that charging is complete when the battery is only partially charged. Remove and reinsert the battery to begin charging again.

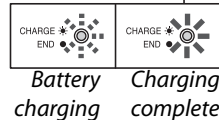
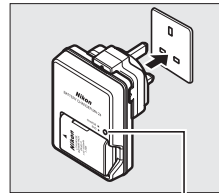

### 4 Remove the battery when charging is complete.

Charging is complete when the **CHARGE** lamp stops blinking. Unplug the charger and remove the battery.

# Insert the Battery

## 1 Turn the camera off.

### Inserting and Removing Batteries

Always turn the camera off before inserting or removing batteries.

## 2 Open the battery-chamber cover.

Unlatch (1) and open (2) the battery-chamber cover.

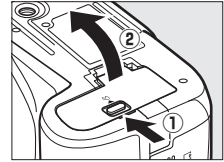

## 3 Insert the battery.

Insert the battery as shown at right.

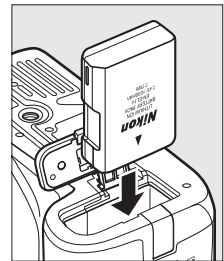

## 4 Close the battery-chamber cover.

### Removing the Battery

To remove the battery, turn the camera off, open the battery-chamber cover, and pull the battery out.

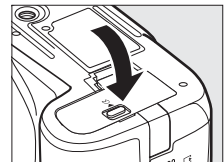

### The Battery and Charger

Read and follow the warnings and cautions on pages ix–x and 184–185 of this manual. Do not use the battery at ambient temperatures below 0°C/32°F or above 40°C/104°F; failure to observe this precaution could damage the battery or impair its performance. Capacity may be reduced and charging times may increase at battery temperatures from 0°C/32°F to 15°C/59°F and from 45°C/113°F to 60°C/140°F. If the **CHARGE** lamp flickers during charging, confirm that the temperature is in the correct range and then unplug the charger and remove and reinsert the battery. If the problem persists, cease use immediately and take battery and charger to your retailer or a Nikon-authorized service representative.

Do not attempt to charge a fully-charged battery. Failure to observe this precaution will result in reduced battery performance.

Use the charger with compatible batteries only. Unplug when not in use.



# Attach a Lens

Care should be taken to prevent dust from entering the camera when the lens is removed. The lens generally used in this manual for illustrative purposes is an AF-S DX NIKKOR 18–55mm f/3.5–5.6G VR.

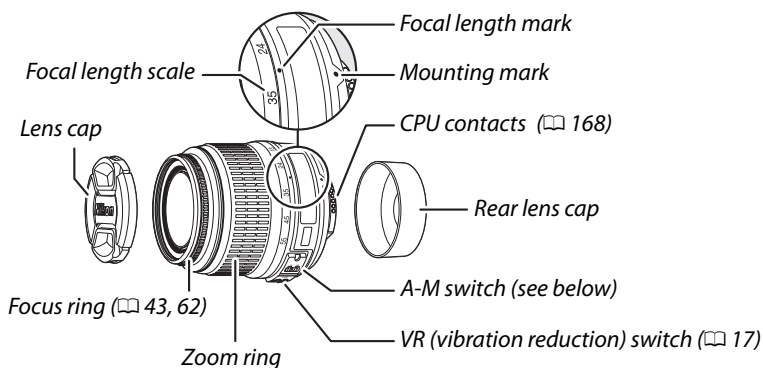

**1** Turn the camera off.

**2** Remove the rear lens cap and the camera body cap.

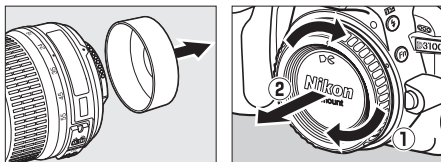

**3** Attach the lens.

Keeping the mounting mark on the lens aligned with the mounting mark on the camera body, position the lens in the camera's bayonet mount (1). Being careful not to press the lens-release button, rotate the lens counter-clockwise until it clicks into place (2).

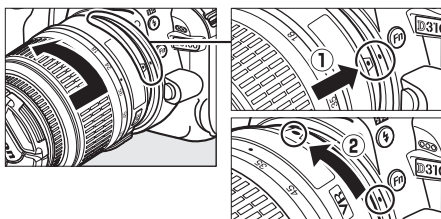

Slide the **A-M** switch to **A** (autofocus; if the lens has an **M/A-M** switch, select **M/A** for autofocus with manual override).

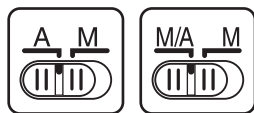

## Autofocus

Autofocus is supported with only AF-S and AF-I lenses, which are equipped with autofocus motors. Autofocus is not available with other AF lenses (167).



## ■ Vibration Reduction (VR)

AF-S DX NIKKOR 18–55mm f/3.5–5.6G VR lenses support vibration reduction (VR), which reduces blur caused by camera shake even when the camera is panned, allowing shutter speeds to be slowed by approximately 3 EV at a focal length of 55 mm (Nikon measurements; effects vary with the user and shooting conditions).

To use vibration reduction, slide the VR switch to **ON**. Vibration reduction is activated when the shutter-release button is pressed halfway, reducing the effects of camera shake on the image in the viewfinder and simplifying the process of framing the subject and focusing in both autofocus and manual focus modes. When the camera is panned, vibration reduction applies only to motion that is not part of the pan (if the camera is panned horizontally, for example, vibration reduction will be applied only to vertical shake), making it much easier to pan the camera smoothly in a wide arc.

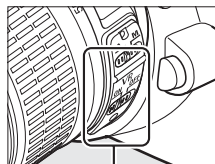

Vibration reduction can be turned off by sliding the VR switch to **OFF**. Turn vibration reduction off when the camera is securely mounted on a tripod, but leave it on if the tripod head is not secured or when using a monopod.

### Detaching the Lens

Be sure the camera is off when removing or exchanging lenses. To remove the lens, press and hold the lens release button (1) while turning the lens clockwise (2). After removing the lens, replace the lens caps and camera body cap.

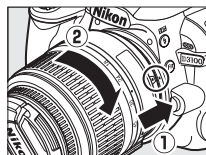

### CPU Lenses with Aperture Rings

In the case of CPU lenses equipped with an aperture ring (□ 168), lock aperture at the minimum setting (highest f-number).

### Vibration Reduction

Do not turn the camera off or remove the lens while vibration reduction is in effect. If power to the lens is cut while vibration reduction is on, the lens may rattle when shaken. This is not a malfunction, and can be corrected by reattaching the lens and turning the camera on. Vibration reduction is disabled while the built-in flash is charging. When vibration reduction is active, the image in the viewfinder may be blurred after the shutter is released. This does not indicate a malfunction.

# Basic Setup

A language-selection dialog will be displayed the first time the camera is turned on. Choose a language and set the time and date. Photographs can not be taken until you have set the time and date.

## 1 Turn the camera on.

A language-selection dialog will be displayed.

## 2 Select a language.

Press ▲ or ▼ to highlight the desired language and press **OK**.



## 3 Choose a time zone.

A time-zone selection dialog will be displayed. Press ◀ or ▶ to highlight the local time zone (the **UTC** field shows the difference between the selected time zone and Coordinated Universal Time, or UTC, in hours) and press **OK**.



## 4 Choose a date format.

Press ▲ or ▼ to choose the order in which the year, month, and day will be displayed. Press **OK** to proceed to the next step.

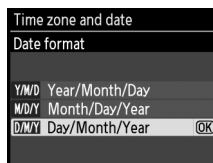

## 5 Turn daylight saving time on or off.

Daylight saving time options will be displayed. Daylight saving time is off by default; if daylight saving time is in effect in the local time zone, press ▲ to highlight **On** and press **OK**.

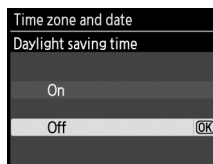

## 6 Set the date and time.

The dialog shown at right will be displayed. Press ◀ or ▶ to select an item, ▲ or ▼ to change. Press **OK** to set the clock and exit to shooting mode.

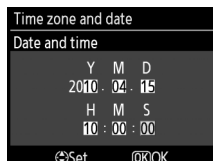

### **The Setup Menu**

Language and date/time settings can be changed at any time using the **Language** (📖 140) and **Time zone and date** (📖 139) options in the setup menu.

### **The Clock Battery**

The camera clock is powered by an independent, rechargeable power source, which is charged as necessary when the main battery is installed or the camera is powered by an optional EP-5A power connector and EH-5a AC adapter (📖 178). Three days of charging will power the clock for about a month. If a message warning that the clock is not set is displayed when the camera is turned on, the clock battery is exhausted and the clock has been reset. Set the clock to the correct time and date.

### **The Camera Clock**

The camera clock is less accurate than most watches and household clocks. Check the clock regularly against more accurate time pieces and reset as necessary.



# Insert a Memory Card

The camera stores pictures on Secure Digital (SD) memory cards (available separately;  177).

## 1 Turn the camera off.

### Inserting and Removing Memory Cards

Always turn the camera off before inserting or removing memory cards.

## 2 Open the card slot cover.

Slide the card slot cover out (①) and open the card slot (②).

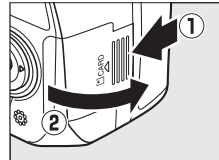

## 3 Insert the memory card.

Holding the memory card as shown at right, slide it in until it clicks into place. The memory card access lamp will light for a few seconds. Close the memory card slot cover.

### Inserting Memory Cards

Inserting memory cards upside down or backwards could damage the camera or the card. Check to be sure the card is in the correct orientation.

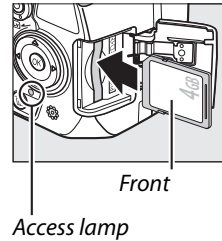

If this is the first time the memory card will be used in the camera or the card has been formatted in another device, format the card as described on page 21.

### Removing Memory Cards

After confirming that the access lamp is off, turn the camera off, open the memory card slot cover, and press the card in to eject it (①). The card can then be removed by hand (②).

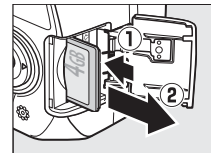

### The Write Protect Switch

Memory cards are equipped with a write protect switch to prevent accidental loss of data. When this switch is in the “lock” position, the memory card can not be formatted and photos can not be deleted or recorded (a beep will sound if you attempt to release the shutter). To unlock the memory card, slide the switch to the “write” position.

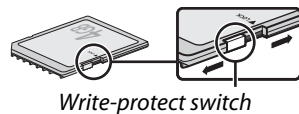

# Format the Memory Card

Memory cards must be formatted before first use or after being formatted in other devices. Format the card as described below.

## ✓ Formatting Memory Cards

Formatting memory cards permanently deletes any data they may contain. Be sure to copy any photographs and other data you wish to keep to a computer before proceeding ( 115).

### 1 Turn the camera on.

### 2 Display format options.

Press the **MENU** button to display the menus. Highlight **Format memory card** in the setup menu and press **▶**. For more information on using the menus, see page 11.

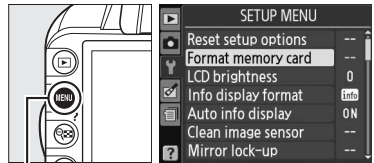

MENU button

### 3 Highlight Yes.

To exit without formatting the memory card, highlight **No** and press **OK**.



### 4 Press OK.

The message at right will be displayed while the card is formatted. *Do not remove the memory card or remove or disconnect the power source until formatting is complete.*



## ✓ Memory Cards

- Memory cards may be hot after use. Observe due caution when removing memory cards from the camera.
- Turn the power off before inserting or removing memory cards. Do not remove memory cards from the camera, turn the camera off, or remove or disconnect the power source during formatting or while data are being recorded, deleted, or copied to a computer. Failure to observe these precautions could result in loss of data or in damage to the camera or card.
- Do not touch the card terminals with your fingers or metal objects.
- Do not bend, drop, or subject to strong physical shocks.
- Do not apply force to the card casing. Failure to observe this precaution could damage the card.
- Do not expose to water, heat, high levels of humidity, or direct sunlight.



# Adjust Viewfinder Focus

The camera is equipped with diopter adjustment to accommodate individual differences in vision. Check that the display in the viewfinder is in focus before framing pictures in the viewfinder.

## 1 Remove the lens cap.

## 2 Turn the camera on.



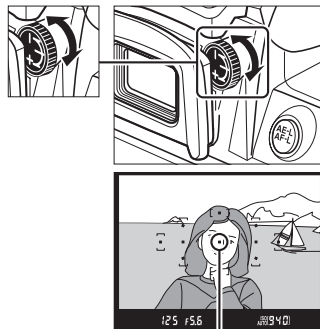

## 3 Focus the viewfinder.

Rotate the diopter adjustment control until the viewfinder display and focus point are in sharp focus. When operating the control with your eye to the viewfinder, be careful not to put your fingers or fingernails in your eye.



*Focus point*

### **Adjusting Viewfinder Focus**

If you are unable to focus the viewfinder as described above, select single-servo autofocus (AF-S;  55), single-point AF (L+;  58), and the center focus point ( 60), and then frame a high-contrast subject in the center focus point and press the shutter-release button halfway to focus the camera. With the camera in focus, use the diopter adjustment control to bring the subject into clear focus in the viewfinder. If necessary, viewfinder focus can be further adjusted using optional corrective lenses ( 176).



# Basic Photography and Playback

## “Point-and-Shoot” Photography

### (<sup>AUTO</sup> and Modes)

This section describes how to take photographs in <sup>AUTO</sup> (auto) mode, an automatic “point-and-shoot” mode in which the majority of settings are controlled by the camera in response to shooting conditions, and in which the flash will fire automatically if the subject is poorly lit. To take photographs with the flash off while leaving the camera in control of other settings, rotate the mode dial to  to select auto (flash off) mode.



## Step 1: Turn the Camera On







### 1 Turn the camera on.

Remove the lens cap and turn the camera on. The information display will appear in the monitor.

### 2 Check the battery level.

Check the battery level in the information display or the viewfinder (if the monitor is off, press the  button to view the information display; if the monitor does not turn on, the battery is exhausted and must be recharged).



Information display	Viewfinder	Description
	—	Battery fully charged.
	—	Battery partially discharged.
		Low battery. Ready fully-charged spare battery or prepare to charge battery.
 (blinks)	 (blinks)	Battery exhausted; shutter release disabled. Charge or exchange battery.

### Image Sensor Cleaning



The camera vibrates the low-pass filter covering the image sensor to remove dust when the camera is turned on or off ( 180).

### 3 Check the number of exposures remaining.

The information display and viewfinder show the number of photographs that can be stored on the memory card (values over 1,000 are rounded down to the nearest hundred; e.g., values between 1,200 and 1,299 are shown as 1.2 K). If a warning is displayed stating that there is not enough memory for additional photographs, insert another memory card (☞ 20) or delete some photos (☞ 31, 109).



## Step 2: Select <sup>AUTO</sup> or Mode

To shoot where use of a flash is prohibited, photograph infants, or capture natural lighting under low light conditions, rotate the mode dial to . Otherwise, rotate the mode dial to <sup>AUTO</sup> .

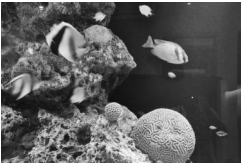

 mode



<sup>AUTO</sup>  mode

Mode dial

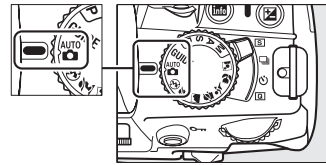



# Step 3: Frame the Photograph

## 1 Ready the camera.

When framing photographs in the viewfinder, hold the handgrip in your right hand and cradle the camera body or lens with your left. Keep your elbows propped lightly against your torso for support and place one foot half a pace ahead of the other to keep your upper body stable.

Hold the camera as shown at right when framing photographs in portrait (tall) orientation.

In  mode, shutter speeds slow when lighting is poor; use of a tripod is recommended.

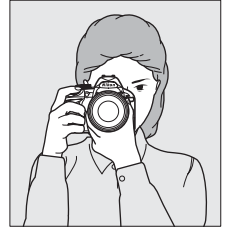

## 2 Frame the photograph.

Frame a photograph in the viewfinder with the main subject in at least one of the 11 focus points.



*Focus point*

### Using a Zoom Lens

Use the zoom ring to zoom in on the subject so that it fills a larger area of the frame, or zoom out to increase the area visible in the final photograph (select longer focal lengths on the lens focal length scale to zoom in, shorter focal lengths to zoom out).

### The AF-S DX NIKKOR 18–55mm f/3.5–5.6G VR Lens

In the case of the AF-S DX NIKKOR 18–55mm f/3.5–5.6G VR, changes to zoom can alter maximum aperture by up to  $1\frac{1}{3}$  EV. The camera however automatically takes this into account when setting exposure, and no modifications to camera settings are required following adjustments to zoom.

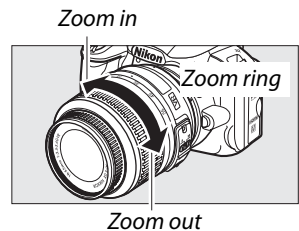

## Step 4: Focus

### 1 Press the shutter-release button halfway.

Press the shutter-release button halfway to focus. The camera will select the focus points automatically. If the subject is poorly lit, the flash may pop up and the AF-assist illuminator may light.



### 2 Check the indicators in the viewfinder.

When the focus operation is complete, the selected focus points will be briefly highlighted, a beep will sound (a beep may not sound if the subject is moving), and the in-focus indicator (●) will appear in the viewfinder.

In-focus indicator	Description
●	Subject in focus.
● (blinks)	Camera unable to focus using autofocus. See page 56.



In-focus indicator

Buffer capacity

While the shutter-release button is pressed halfway, the number of exposures that can be stored in the memory buffer ("24"; □ 53) will be displayed in the viewfinder.

## Step 5: Shoot

Smoothly press the shutter-release button the rest of the way down to release the shutter and record the photograph. The access lamp next to the memory card slot cover will light and the photograph will be displayed in the monitor for a few seconds (the photo will automatically clear from the display when the shutter-release button is pressed halfway). *Do not eject the memory card or remove or disconnect the power source until the lamp has gone out and recording is complete.*

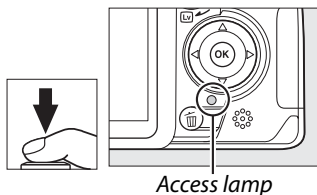

Access lamp



## The Shutter-Release Button

The camera has a two-stage shutter-release button. The camera focuses when the shutter-release button is pressed halfway. To take the photograph, press the shutter-release button the rest of the way down.

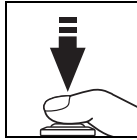
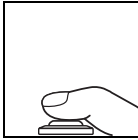

*Focus: press halfway*

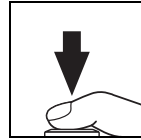

*Shoot: press all the way down*

## Auto-Meter Off

The viewfinder and information display will turn off if no operations are performed for about 8 seconds (auto-meter off), reducing the drain on the battery. Press the shutter-release button halfway to reactivate the display. The auto-meter off delay can be selected using the **Auto off timers** option in the setup menu ( 143).



## The Built-in Flash

If additional lighting is required for correct exposure in **AUTO** mode, the built-in flash will pop up automatically when the shutter-release button is pressed halfway. If the flash is raised, photographs can only be taken when the flash-ready indicator () is displayed. If the flash-ready indicator is not displayed, the flash is charging; remove your finger briefly from the shutter-release button and try again.

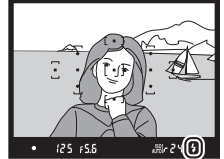
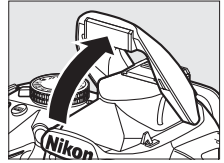

To save battery power when the flash is not in use, return it to its closed position by pressing it gently downward till the latch clicks into place.

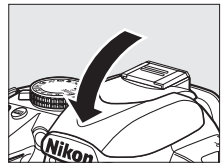

# Creative Photography (Scene Modes)

The camera offers a choice of “scene” modes. Choosing a scene mode automatically optimizes settings to suit the selected scene, making creative photography as simple as selecting a mode, framing a picture, and shooting as described on pages 23–27.



## ■ ■ The Mode Dial

The following scenes can be selected with the mode dial:

Mode dial

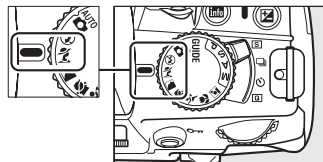

	Mode
	Portrait
	Landscape
	Child
	Sports
	Close up
	Night portrait

## ■ ■ Scene Modes

### Portrait



Use for portraits with soft, natural-looking skin tones. If the subject is far from the background or a telephoto lens is used, background details will be softened to lend the composition a sense of depth.

### Landscape



Use for vivid landscape shots in daylight. The built-in flash and AF-assist illuminator turn off; use of a tripod is recommended to prevent blur when lighting is poor.

## **Child**



Use for snapshots of children. Clothing and background details are vividly rendered, while skin tones remain soft and natural.

## **Close Up**



Use for close-up shots of flowers, insects, and other small objects (a macro lens can be used to focus at very close ranges). Use of a tripod is recommended to prevent blur.



## **Sports**



Fast shutter speeds freeze motion for dynamic sports shots in which the main subject stands out clearly. The built-in flash and AF-assist illuminator turn off. To take a sequence of shots, select continuous release mode (□ 5, 53).

## **Night Portrait**



Use for a natural balance between the main subject and the background in portraits taken under low light. Use of a tripod is recommended to prevent blur.

# Basic Playback

Photographs are automatically displayed for about 4 s after shooting. If no photograph is displayed in the monitor, the most recent picture can be viewed by pressing the  button.



## 1 Press the button.



A photograph will be displayed in the monitor.



 button

## 2 View additional pictures.

Additional pictures can be displayed by pressing  or  or rotating the command dial.

To view additional information on the current photograph, press  and  ( 100).

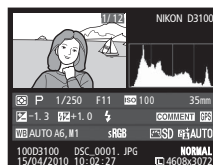

To end playback and return to shooting mode, press the shutter-release button halfway.



# Deleting Unwanted Photographs

To delete the photograph currently displayed in the monitor, press the  button.



*Note that photographs can not be recovered once deleted.*

## 1 Display the photograph.

Display the photograph you wish to delete as described on the preceding page.



## 2 Delete the photograph.

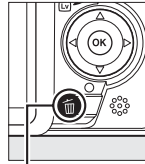

Press the  button. A confirmation dialog will be displayed; press the  button again to delete the image and return to playback (to exit without deleting the picture, press ).



 button



### Delete

To delete selected images ( 110), all images taken on a selected date ( 111), or all images in the current playback folder ( 129), use the **Delete** option in the playback menu.





# G Guide Mode

## The Guide

Guide mode gives access to a variety of frequently-used and useful functions. The top level of the guide is displayed when the mode dial is rotated to **GUIDE**.



G

Battery indicator (☞ 23)

Number of exposures remaining (☞ 24)

**Shooting mode:** A guide mode indicator appears on the shooting mode icon.

Choose from the following items:

Shoot	View/delete	Set up
<p>Take pictures.</p>	<p>View and/or delete pictures.</p>	<p>Change camera settings.</p>

# Guide Mode Menus

To access these menus, highlight **Shoot**, **View/delete**, or **Set up** and press **OK**.



## Shoot

### Easy operation

- Auto**
- No flash**
- Distant subjects**
- Close-ups**
- Sleeping faces**
- Moving subjects**
- Landscapes**
- Portraits**
- Night portrait**

### Advanced operation

- |                                 |                         |
|---------------------------------|-------------------------|
| <b>Soften backgrounds</b>       | Adjust aperture.        |
| <b>Bring more into focus</b>    |                         |
| <b>Freeze motion (people)</b>   | Select a shutter speed. |
| <b>Freeze motion (vehicles)</b> |                         |
| <b>Show water flowing</b>       |                         |

### Use a timer/quiet shutter

- Single frame**
- Continuous**
- 10-second self-timer**
- Quiet shutter release**

## "Start Shooting"

To start shooting, highlight **Start shooting** and press **▶**. The options shown below at right will be displayed.

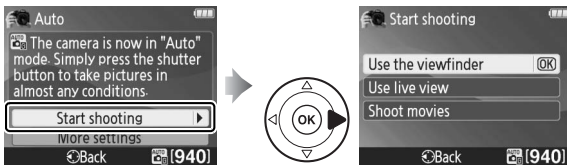

Highlight an option and press **OK**.

- **Use the viewfinder**
- **Use live view**
- **Shoot movies**

## "More Settings"

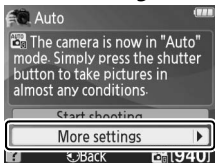

If **More settings** is displayed, you can highlight this option and press **▶** to access the following settings (the settings available vary with the shooting option selected):

- |                       |                   |
|-----------------------|-------------------|
| • Set Picture Control | • Exposure comp.  |
| • Flash compensation  | • Flash mode      |
| • Release mode        | • ISO sensitivity |

## ■ ■ View/Delete

View single photos

Choose a date

Delete photos

View multiple photos

View a slide show

## ■ ■ Set Up

Image quality

Language

Image size

Auto off timers

Playback folder

Beep

Print set (DPOF)

Date imprint

Format memory card

Slot empty release lock

LCD brightness

Movie settings

Info background color

HDMI

Auto info display

Flicker reduction

Video mode

Eye-Fi upload\*

Time zone and date

\* Only available when compatible Eye-Fi memory card is inserted (□ 150).







Changes to **Image quality, Image size, LCD brightness, Info background color, Auto info display, Auto off timers, Beep, Date imprint**, and **Movie settings** only apply in guide mode and are not reflected in other shooting modes.

G

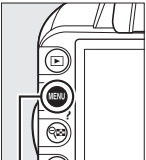
### Guide Mode

Guide mode is reset to **Easy operation > Auto** when the mode dial is rotated to another setting or the camera is turned off.

The following operations can be performed while the guide is displayed:

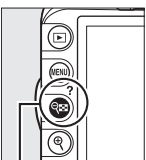
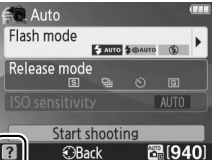
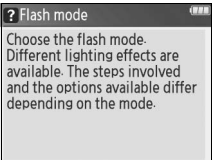
To	Use	Description
Return to top level of guide	 <b>MENU button</b>	Press <b>MENU</b> to turn the monitor on or return to the top level of the guide.
Turn monitor on		
Highlight a menu		Press ◀ or ▶ to highlight a menu.
Highlight options		Press ▲ or ▼ to highlight options in the menus.
		Press ▲, ▼, ◀, or ▶ to highlight options in displays like that shown at right.
Select highlighted menu or option		Press <b>OK</b> to select the highlighted menu or option.
Return to previous display		Press ◀ to return to the previous display.
		To cancel and return to the previous display from displays like that shown at right, highlight ↵ and press <b>OK</b> .
View help	 <b>? (help) button</b>	<p>If a ? icon is displayed at the bottom left corner of the monitor, help can be displayed by pressing the ? (help) button. A description of the currently selected option will be displayed while the button is pressed. Press ▲ or ▼ to scroll through the display.</p>  <p><b>? (help) icon</b></p> 



# Live View

## Framing Photographs in the Monitor

Follow the steps below to take photographs in live view.

### 1 Rotate the live view switch.

The mirror will be raised and the view through the lens will be displayed in the camera monitor. The subject will no longer be visible in the viewfinder.



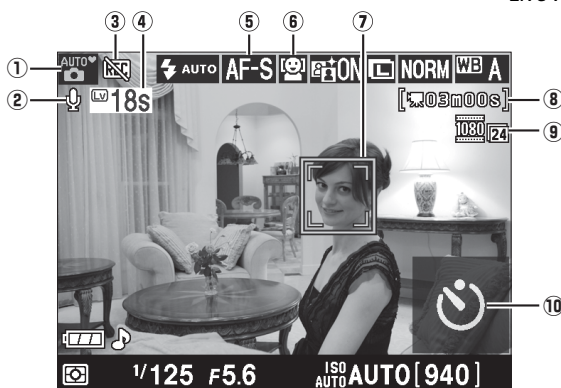

Live view switch





Item	Description	
① Shooting mode	The mode currently selected with the mode dial. Select  or  for automatic scene selection (autofocus only;  41).	23, 28, 73
② Audio recording indicator	Indicates whether sound is being recorded with movies.	47
③ "No movie" icon	Indicates that movies can not be recorded.	45
④ Time remaining	The amount of time remaining before live view ends automatically. Displayed if shooting will end in 30 s or less.	42
⑤ Focus mode	The current focus mode.	38
⑥ AF-area mode	The current AF-area mode.	38
⑦ Focus point	The current focus point. The display varies with the option selected for AF-area mode ( 38).	39
⑧ Time remaining (movie mode)	The recording time remaining in movie mode.	46
⑨ Movie frame size	The frame size of movies recorded in movie mode.	47
⑩ Self-timer	Displayed in self-timer release mode.	54

## 2 Choose a focus mode.

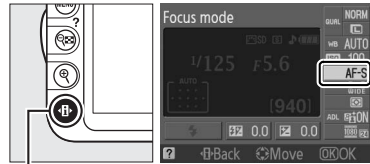
Press the  button and use the multi selector to highlight the current focus mode in the monitor. Press  to display the following options. Highlight an option and press .







 button





Option	Description
<b>AF-S Single-servo AF</b>	For stationary subjects. Focus locks when shutter-release button is pressed halfway. Shutter can only be released if camera is able to focus.
<b>AF-F Full-time servo AF</b>	For moving subjects. Camera focuses continuously during live view and movie recording. Shutter can only be released if camera is able to focus.
<b>MF Manual focus</b>	Focus manually (  43).

The description in Steps 3, 4, and 5 assumes that **AF-S** or **AF-F** is selected. If **MF** is selected, proceed to Step 6 after focusing manually.

## 3 Choose an AF-area mode.

AF-area mode can be selected in all shooting modes except  and . Highlight the current AF-area mode in the monitor. Press  to display the following options. Highlight an option and press .



Mode	Description
 <b>Face-priority AF</b>	The camera automatically detects and focuses on portrait subjects facing the camera. Use for portraits.
 <b>Wide-area AF</b>	Use for hand-held shots of landscapes and other non-portrait subjects. Use the multi selector to select the focus point.
 <b>Normal-area AF</b>	Use for pin-point focus on a selected spot in the frame. A tripod is recommended.
 <b>Subject-tracking AF</b>	Track a selected subject as it moves through the frame.

Press the  button again to return to live view.

### Live View AF-Area Mode

The AF-area modes for live view can also be chosen using the **AF-area mode > Live view/ movie** option in the shooting menu.

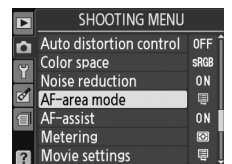

## 4 Choose the focus point.

**Face-priority AF:** A double yellow border will be displayed when the camera detects a portrait subject facing the camera (if multiple faces, up to a maximum of 35, are detected, the camera will focus on the closest subject; to choose a different subject, press the multi selector up, down, left, or right).

**Wide- and normal-area AF:** Use the multi selector to move the focus point to any point in the frame, or press **OK** to position the focus point in the center of the frame.

**Subject-tracking AF:** Position the focus point over your subject and press **OK**. The focus point will track the selected subject as it moves through the frame.

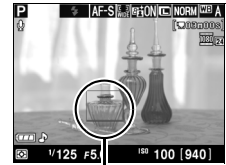
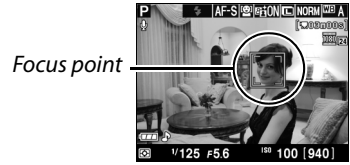

Focus point



Focus point

## 5 Focus.

Press the shutter-release button halfway to focus.



**Face-priority AF:** The camera sets focus for the face in the double yellow border while the shutter-release button is pressed halfway; if the camera can no longer detect the subject (because, for example, the subject has looked away), borders will no longer be displayed.



**Wide- and normal-area AF:** The camera focuses on the subject in the selected focus point while the shutter-release button is pressed halfway.

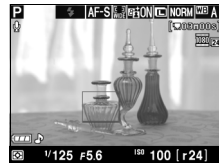

**Subject-tracking AF:** The camera focuses on the current subject. To end tracking, press **OK**.



### Subject Tracking

The camera may be unable to track subjects if they are small, moving quickly, or a similar color to the background, or if both the subject and the background are very bright or very dark, the brightness and color of the subject or background varies greatly, the subject leaves the frame, or the subject visibly changes size.

The focus point will blink green while the camera focuses. If the camera is able to focus, the focus point will be displayed in green; if the camera is unable to focus, the focus point will blink red. Note that pictures can be taken even when the focus point blinks red. Check focus in the monitor before shooting. Except in **AUTO** and **☺** modes, exposure can be locked by pressing the **AE-L/AF-L** button (**☐ 80**). Focus can be locked by pressing the shutter-release button halfway.



## 6 Take the picture.

Press the shutter-release button the rest of the way down to shoot. The monitor will turn off. When shooting is complete, the photograph will be displayed in the monitor for 4 s or until the shutter-release button is pressed halfway. The camera will then return to live view mode.



## 7 Exit live view mode.

Rotate the live view switch to exit live view mode.

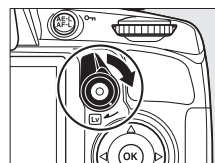

Lv

### Live View Display Options

Press the **Info** button to cycle through display options as shown below.

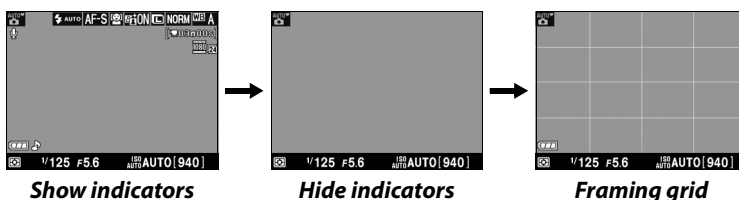

### Automatic Scene Selection (Scene Auto Selector)

If live view is selected in **AUTO** or **SCN** mode, the camera will automatically analyze the subject and select the appropriate shooting mode when autofocus is enabled. The selected mode is shown in the monitor.

	<b>Portrait</b>	Human portrait subjects
	<b>Landscape</b>	Landscapes and cityscapes
	<b>Close up</b>	Subjects close to the camera
	<b>Night portrait</b>	Portrait subjects framed against a dark background
	<b>Auto</b>	Subjects suited to <b>AUTO</b> or <b>SCN</b> mode or that do not fall into the categories listed above
	<b>Auto (flash off)</b>	



## Flicker

You may notice flicker or banding in the monitor during live view or when shooting movies under certain types of lighting, such as fluorescent or mercury-vapor lamps. Flicker and banding can be reduced by choosing a **Flicker reduction** option that matches the frequency of the local AC power supply (□ 139).

## Exposure Compensation

In **P**, **S**, and **A** modes, exposure can be adjusted by  $\pm 5$  EV in increments of  $\frac{1}{3}$  EV (□ 81). Note that the effects of values over +3 EV or under -3 EV can not be previewed in the monitor.

## HDMI

When the camera is attached to an HDMI video device, the camera monitor will turn off and the video device will display the view through the lens as shown at right. Movies can not be recorded and photographs can not be taken in live view while the camera is connected to an HDMI-CEC device.

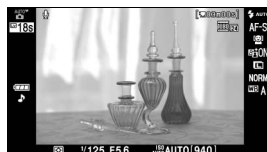

## Shooting in Live View Mode

To prevent light entering via the viewfinder from interfering with exposure, remove the rubber eyecup and cover the viewfinder with the supplied DK-5 eyepiece cap before shooting (□ 54).

Although they will not appear in the final picture, flicker, banding, or distortion may be visible in the monitor under fluorescent, mercury vapor, or sodium lamps or if the camera is panned horizontally or an object moves at high speed through frame. Bright light sources may leave after-images in the monitor when the camera is panned. When shooting in live view mode, avoid pointing the camera at the sun or other strong light sources. Failure to observe this precaution could result in damage to the camera's internal circuitry.

Live view ends automatically if the lens is removed.

Live view may end automatically to prevent damage to the camera's internal circuits; exit live view when the camera is not use. Note that the temperature of the camera's internal circuits may rise and noise (bright spots, randomly-spaced bright pixels, or fog) may be displayed in the following instances (the camera may also become noticeably warm, but this does not indicate a malfunction):

- The ambient temperature is high
- The camera has been used for extended periods in live view or to record movies
- The camera has been used in continuous release mode for extended periods

If a warning is displayed when you attempt to start live view, wait for the internal circuits to cool and then try again.

## The Count Down Display

A count down will be displayed 30 s before live view ends automatically (□ 37; the timer turns red 5 s before the auto-off timer expires or if live view is about to end to protect the internal circuits). Depending on shooting conditions, the timer may appear immediately when live view is selected. Note that although the count down does not appear in the information display or during playback, live view will still end automatically when the timer expires.

## ✔ Using Autofocus in Live View

Autofocus is slower in live view and the monitor may brighten or darken while the camera focuses. The camera may be unable to focus in the following situations:



- The subject contains lines parallel to the long edge of the frame
- The subject lacks contrast
- The subject in the focus point contains areas of sharply contrasting brightness, or the subject is lit by spot lighting or by a neon sign or other light source that changes in brightness
- Flicker or banding appears under fluorescent, mercury-vapor, sodium-vapor, or similar lighting
- A cross (star) filter or other special filter is used
- The subject appears smaller than the focus point
- The subject is dominated by regular geometric patterns (e.g., blinds or a row of windows in a skyscraper)
- The subject is moving

Note that the focus point may sometimes be displayed in green when the camera is unable to focus.

## ✎ Manual Focus

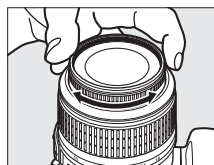
To focus in manual focus mode (M 62), rotate the lens focus ring until the subject is in focus.



To magnify the view in the monitor up to about 6.8 × for precise focus, press the  button. While the view through the lens is zoomed in, a navigation window will appear in a gray frame at the bottom right corner of the display. Use the multi selector to scroll to areas of the frame not visible in the monitor (available only if **Wide-area AF** or **Normal-area AF** is selected for **AF-area mode**), or press  to zoom out.

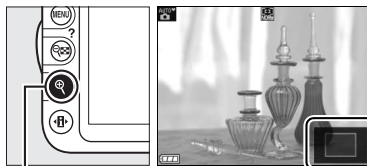

 button

Navigation window





# Recording and Viewing Movies

## Recording Movies

Movies can be recorded in live view mode.

### 1 Rotate the live view switch.

The mirror is raised and the view through the lens is displayed in the monitor instead of the viewfinder.

#### ✓ The Icon

A  icon (□ 37) indicates that movies can not be recorded.

#### Before Recording

Set aperture before recording in mode **A** or **M**.



Live view switch

### 2 Choose a focus mode.

Press the  button and select a focus mode as described in Step 2 of “Live View” (□ 38).

#### Camera Noise

The camera may record lens noise during autofocus or vibration reduction.

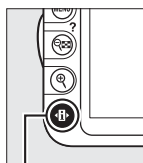

 button

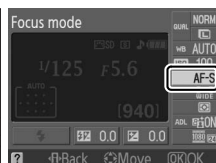

### 3 Choose an AF-area mode.

See Step 3 on page 38 for more information.







### 4 Focus.

Frame the opening shot and focus as described in Steps 4 and 5 of “Live View” (□ 39–40). Note that the number of subjects that can be detected in face-priority AF drops during movie recording.



## 5 Start recording.

Press the movie-record button to start recording (the camera can record both video and sound; do not cover the microphone on the front of the camera during recording). A recording indicator and the time available are displayed in the monitor. Except in  and  modes, exposure can be locked by pressing the **AE-L/AF-L** button ( 80) or (in modes **P**, **S**, and **A**) altered by up to  $\pm 3$  EV in steps of  $1/3$  EV using exposure compensation ( 81). Focus can be locked by pressing the shutter-release button halfway.

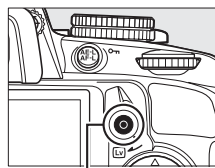

Movie record button

Recording indicator



Time remaining

## 6 End recording.

Press the movie-record button again to end recording. Recording will end automatically when the maximum length is reached, or the memory card is full.

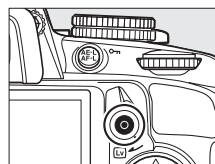

### **Taking Photographs During Movie Recording**

To take a photograph during movie recording, press the shutter-release button all the way down and hold it in this position until the shutter is released.

### **Maximum Length**

Each movie file can be up to 4 GB in size and 10 minutes long; note that depending on memory card write speed, shooting may end before this length is reached ( 177).

## Movie Settings

Choose movie frame size and sound options.

- Frame size (**Quality**)

Option	Frame size (pixels)	Frame rate (fps)	Maximum length
<b>1920 × 1080; 24 fps</b>	1920 × 1080	23.976	10 min.
<b>1280 × 720; 30 fps</b>	1280 × 720	29.97	
<b>1280 × 720; 25 fps</b>		25	
<b>1280 × 720; 24 fps</b>		23.976	
<b>640 × 424; 24 fps</b>	640 × 424		

- Audio (**Sound**)

Option	Description
<b>On</b>	Record monaural sound with movies.
<b>Off</b>	Sound recording off.

### 1 Select Movie settings.

Press the **MENU** button to display the menus. Highlight **Movie settings** in the shooting menu and press ►.

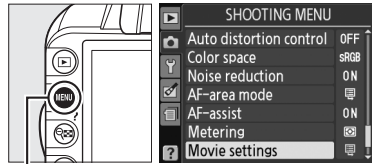

MENU button

### 2 Choose frame size and sound recording options.

To choose a frame size, highlight **Quality** and press ►, then highlight an option and press **OK**. To turn sound recording on or off, highlight **Sound** and press ►, then highlight an option and press **OK**.

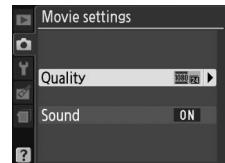

#### **Movie Settings > Quality**

The **1280 × 720; 30 fps**, **1280 × 720; 25 fps**, and **1280 × 720; 24 fps** options have different frame rates.

- **1280 × 720; 30 fps**: Suitable for display on NTSC devices
- **1280 × 720; 25 fps**: Suitable for display on PAL devices
- **1280 × 720; 24 fps**: The normal recording rate for movies and cartoons

## ✓ Recording Movies

Flicker, banding, or distortion may be visible in the monitor and in the final movie under fluorescent, mercury vapor, or sodium lamps or if the camera is panned horizontally or an object moves at high speed through frame (flicker and banding can be reduced by choosing a **Flicker reduction** option that matches the frequency of the local AC power supply;  139). Bright light sources may leave after-images when the camera is panned. Jagged edges, false colors, and moiré may also appear. When recording movies, avoid pointing the camera at the sun or other strong light sources. Failure to observe this precaution could result in damage to the camera's internal circuitry.

Recording ends automatically if the lens is removed.

Live view may end automatically to prevent damage to the camera's internal circuits; exit live view when the camera is not use. Note that the temperature of the camera's internal circuits may rise and noise (bright spots, randomly-spaced bright pixels, or fog) may be displayed in the following instances (the camera may also become noticeably warm, but this does not indicate a malfunction):

- The ambient temperature is high
- The camera has been used for extended periods in live view or to record movies
- The camera has been used in continuous release mode for extended periods

If a warning is displayed when you attempt to start live view or movie recording, wait for the internal circuits to cool and then try again.



Matrix metering is used regardless of the metering method selected. Shutter speed and ISO sensitivity are adjusted automatically.

## ✓ The Count-Down Display

A count down will be displayed in red 30 s before movie recording ends automatically ( 37). Depending on shooting conditions, the timer may appear immediately when movie recording begins. Note that regardless of the amount of recording time available, live view will still end automatically when the timer expires. Wait for the internal circuits to cool before resuming movie recording.







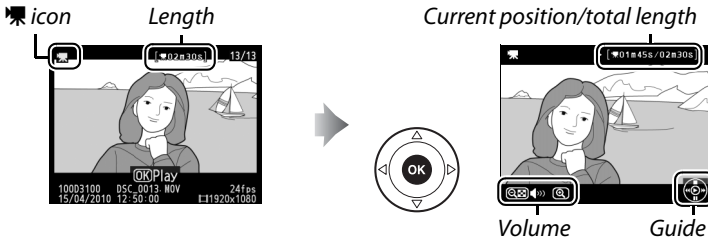







# Viewing Movies

Movies are indicated by a  icon in full-frame playback ( 99). Press  to start playback.



The following operations can be performed:

To	Use	Description
Pause		Pause playback.
Play		Resume playback when movie is paused or during rewind/advance.
Advance/rewind		Speed doubles with each press, from 2x to 4x to 8x to 16x; keep pressed to skip to beginning or end of movie. If playback is paused, movie rewinds or advances one frame at a time; keep pressed for continuous rewind or advance.
Adjust volume		Press  to increase volume,  to decrease.
Edit movie		To edit movie, press <b>AE-L/AF-L</b> while movie is paused (  50).
Return to full-frame playback	 / 	Press  or  to exit to full-frame playback.
Exit to shooting mode		Press shutter-release button halfway. Monitor will turn off; photographs can be taken immediately.
Display menus	<b>MENU</b>	See page 129 for more information.

## The Icon

 is displayed in full-frame and movie playback if the movie was recorded without sound.



# Editing Movies



Trim footage to create edited copies of movies or save selected frames as JPEG stills.

Option	Description
<b>Choose start point</b>	Create a copy from which the opening footage has been removed.
<b>Choose end point</b>	Create a copy from which the ending footage has been removed.
<b>Save selected frame</b>	Save a selected frame as a JPEG still.

## Trimming Movies

To create trimmed copies of movies:



### 1 Display a movie full frame.

Press the  button to display pictures full frame in the monitor and press  and  to scroll through pictures until the movie you wish to edit is displayed.





 button

### 2 Choose a starting or end point.

Play the movie back as described on page 49, pressing  to start and resume playback and  to pause. If you intend to trim the opening footage from the copy, pause on the first frame you wish to keep; if you will be trimming the ending footage from the copy, pause on the last frame you wish to keep.



#### Starting and Ending Frames

The starting frame is shown by a  icon, the final frame by a  icon.



### 3 Display the retouch menu.

Press the AE-L/AF-L button to display the retouch menu.

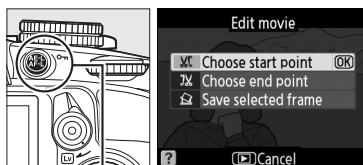

AE-L/AF-L button

## 4 Choose an option.

To create a copy that includes the current frame and all following frames, highlight **Choose start point** in the edit movie menu and press **OK**. Select **Choose end point** create a copy that includes the current frame and all preceding frames.

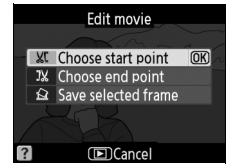

## 5 Delete frames.

Press **▲** to delete all frames before (**Choose start point**) or after (**Choose end point**) the current frame.



## 6 Save the copy.

Highlight **Yes** and press **ⓧ** to save the edited copy. If necessary, the copy can be trimmed as described above to remove additional footage. Edited copies are indicated by a  icon in full-frame playback.

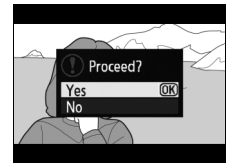

### Trimming Movies

Movies must be at least two seconds long. If a copy can not be created at the current playback position, the current position will be displayed in red in Step 5 and no copy will be created. The copy will not be saved if there is insufficient space available on the memory card.

To prevent the camera from turning off unexpectedly, use a fully-charged battery when editing movies.

### The Retouch Menu

Movies can also be edited using the **Edit movie** option in the retouch menu ( 151).



# Saving Selected Frames

To save a copy of a selected frame as a JPEG still:

- 1 View the movie and choose a frame.**  
Play the movie back as described on page 49. Pause the movie at the frame you intend to copy.



- 2 Display the retouch menu.**  
Press the **AE-L/AF-L** button to display the retouch menu.



AE-L/AF-L button

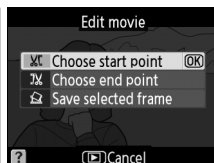

- 3 Choose Save selected frame.**  
Highlight **Save selected frame** and press **OK**.

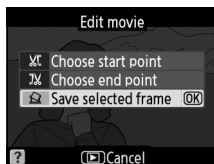

- 4 Create a still copy.**  
Press **▲** to create a still copy of the current frame.



- 5 Save the copy.**  
Highlight **Yes** and press **OK** to create a JPEG copy of the selected frame. Movie stills are indicated by a  icon in full-frame playback.

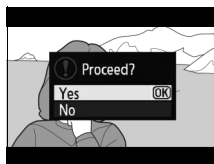





## Save Selected Frame

JPEG movie stills created with the **Save selected frame** option can not be retouched. JPEG movie stills lack some categories of photo information (100).

# Release Mode

## Choosing a Release Mode

To choose a release mode, rotate the release-mode selector to the desired setting.

-  **Single frame** (📖 5)
-  **Continuous** (📖 5)
-  **Self-timer** (📖 54)
-  **Quiet shutter release** (📖 5)

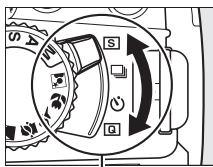



Release-mode selector

### **The Memory Buffer**

The camera is equipped with a memory buffer for temporary storage, allowing shooting to continue while photographs are being saved to the memory card. Up to 100 photographs can be taken in succession; note, however, that frame rate will drop when the buffer is full.

While photographs are being recorded to the memory card, the access lamp next to the memory card slot will light. Depending on the number of the images in the buffer, recording may take from a few seconds to a few minutes. *Do not remove the memory card or remove or disconnect the power source until the access lamp has gone out.* If the camera is switched off while data remain in the buffer, the power will not turn off until all images in the buffer have been recorded. If the battery is exhausted while images remain in the buffer, the shutter release will be disabled and the images transferred to the memory card.

### **Continuous Release Mode**

Continuous release mode () can not be used with the built-in flash; rotate the mode dial to  (📖 24) or turn the flash off (📖 67–69). For information on the number of photographs that can be taken in a single burst, see page 187.

### **Buffer Size**

The approximate number of images that can be stored in the memory buffer at current settings is shown in the viewfinder exposure-count display while the shutter-release button is pressed. The illustration shows the display when space remains in the buffer for about 24 pictures.



### **Auto Image Rotation**

The camera orientation recorded for the first shot applies to all images in the same burst, even if the camera is rotated during shooting. See “Auto Image Rotation” (📖 141).

# Self-Timer Mode

The self-timer can be used to reduce camera shake or for self-portraits.

## 1 Mount the camera on a tripod.

Mount the camera on a tripod or place the camera on a stable, level surface.

## 2 Select self-timer mode.

Rotate the release-mode selector to .

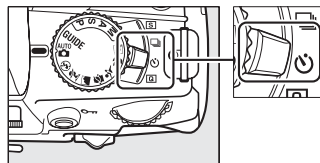

## 3 Frame the photograph.

### Cover the Viewfinder

When taking photos without your eye to the viewfinder, remove the DK-20 rubber eyecup (①) and insert the supplied DK-5 eyepiece cap as shown (②). This prevents light entering via the viewfinder interfering with exposure. Hold the camera firmly when removing the rubber eyecup.

*DK-20 rubber eyecup*

*DK-5 eyepiece cap*

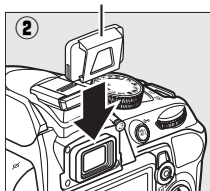
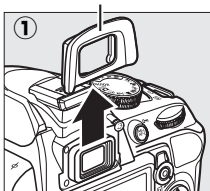

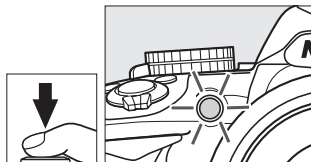

## 4 Take the photograph.

Press the shutter-release button halfway to focus, and then press the button the rest of the way down to start the self-timer (note that the timer will not start if the camera is unable to focus or in other situations in which the shutter can not be released). The self-timer lamp will start to blink and a beep will begin to sound. Two seconds before the photograph is taken, the self-timer lamp will stop blinking and the beeping will become more rapid. The shutter will be released ten seconds after the timer starts. To cancel the timer, turn the camera off.



### Using the Built-in Flash

Before taking a photograph with the flash in **P**, **S**, **A**, or **M** modes, press the  button to raise the flash and wait for the  indicator to be displayed in the viewfinder (□ 27). Shooting will be interrupted if the flash is raised after the timer has started.

### See Also

The length of the self-timer delay can be selected using the **Self-timer delay** option in the setup menu (□ 143).



# More on Photography (All Modes)

## Focus

This section describes the focus options available when photographs are framed in the viewfinder. Focus can be adjusted automatically or manually (see “Focus Mode,” below). The user can also select the focus point for automatic or manual focus (☐ 62) or use focus lock to focus to recompose photographs after focusing (☐ 60).

## Focus Mode

Choose from the following focus modes. Note that **AF-S** and **AF-C** are available only in modes **P**, **S**, **A**, and **M**.

Option	Description
<b>AF-A</b> <b>Auto-servo AF</b>	Camera automatically selects single-servo autofocus if subject is stationary, continuous-servo autofocus if subject is moving. Shutter can only be released if camera is able to focus.
<b>AF-S</b> <b>Single-servo AF</b>	For stationary subjects. Focus locks when shutter-release button is pressed halfway. Shutter can only be released if camera is able to focus.
<b>AF-C</b> <b>Continuous-servo AF</b>	For moving subjects. Camera focuses continuously while shutter-release button is pressed halfway. Shutter can only be released if camera is able to focus.
<b>MF</b> <b>Manual focus</b>	Focus manually (☐ 62).

### 1 Place the cursor in the information display.

If shooting information is not displayed in the monitor, press the **INFO** button. Press the **INFO** button again to place the cursor in the information display.

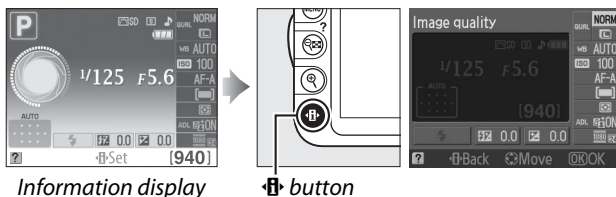

### 2 Display focus-mode options.

Highlight the current focus mode in the information display and press **OK**.

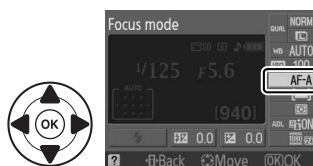

### 3 Choose a focus mode.

Highlight a focus mode and press **OK**. To return to shooting mode, press the shutter-release button halfway.

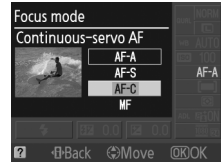

#### **✓** Continuous-servo Autofocus

In **AF-C** mode or when continuous-servo autofocus is selected in **AF-A** mode, the camera gives higher priority to focus response (has a wider focus range) than in **AF-S** mode, and the shutter may be released before the in-focus indicator is displayed.

#### **✍** Getting Good Results with Autofocus

Autofocus does not perform well under the conditions listed below. The shutter release may be disabled if the camera is unable to focus under these conditions, or the in-focus indicator (●) may be displayed and the camera may sound a beep, allowing the shutter to be released even when the subject is not in focus. In these cases, focus manually (□ 62) or use focus lock (□ 60) to focus on another subject at the same distance and then recompose the photograph.

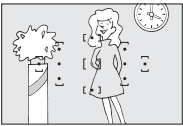

*There is little or no contrast between the subject and the background.*

**Example:** Subject is the same color as the background.

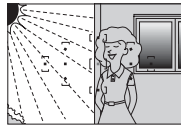

*The focus point contains areas of sharply contrasting brightness.*

**Example:** Subject is half in the shade.



*The focus point contains objects at different distances from the camera.*

**Example:** Subject is inside a cage.

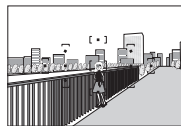

*Background objects appear larger than the subject.*

**Example:** A building is in the frame behind the subject.

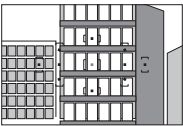

*The subject is dominated by regular geometric patterns.*

**Example:** Blinds or a row of windows in a skyscraper.

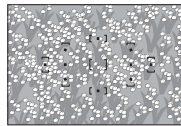

*The subject contains many fine details.*

**Example:** A field of flowers or other subjects that are small or lack variation in brightness.



### ✓ The AF-Assist Illuminator

If the subject is poorly lit, the AF-assist illuminator will light automatically to assist the autofocus operation when the shutter-release button is pressed halfway. The AF-assist illuminator will not light:

- In live view or during movie recording
- During manual focus or if live view is off and continuous-servo autofocus is selected (**AF-C** selected for focus mode, or continuous-servo AF selected in **AF-A** focus mode)
- If the center focus point is not selected in [•] **Single-point AF**, [•] **Dynamic-area AF**, or [3D] **3D-tracking (11 points)** AF-area mode (☞ 58, 60)
- In shooting modes in which the AF-assist illuminator can not be used (☞ 186)
- If **Off** has been selected for the **AF-assist** option in the shooting menu (☞ 134)

The illuminator has a range of about 0.5–3.0 m (1 ft. 8 in.–9 ft. 10 in.); when using the illuminator, use a lens with a focal length of 18–200 mm and remove the lens hood. The AF-assist illuminator will turn off automatically to protect the lamp after a period of continuous use. Normal function will resume after a brief pause. Note that the illuminator may become hot when used multiple times in quick succession.

*AF-assist illuminator*

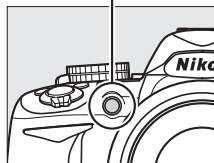

### ✎ The Beep Speaker

The **Beep** option in the setup menu (☞ 144) can be used to turn the beep speaker on or off.



# AF-Area Mode

Choose how the focus point for autofocus is selected. Note that **[3D]** (3D-tracking (11 points)) is not available when **AF-S** is selected for focus mode.

Option	Description
<b>[*] Single-point AF</b>	User selects focus point using multi selector (☐ 60); camera focuses on subject in selected focus point only. Use with stationary subjects.
<b>[*] Dynamic-area AF</b>	<b>In AF-A and AF-C focus modes</b> , user selects focus point manually (☐ 60), but camera will focus based on information from surrounding focus points if subject briefly leaves selected point. Use with erratically moving subjects. <b>In AF-S focus mode</b> , user selects focus point manually (☐ 60); camera focuses on subject in selected focus point only.
<b>[*] Auto-area AF</b>	Camera automatically detects subject and selects focus point.
<b>[3D] 3D-tracking (11 points)</b>	<b>In AF-A and AF-C focus modes</b> , user selects focus point using multi selector (☐ 60). If subject moves after camera has focused, camera uses 3D-tracking to select new focus point and keep focus locked on original subject while shutter-release button is pressed halfway. If subject leaves viewfinder, remove your finger from shutter-release button and recompose photograph with subject in selected focus point.

## 1 Place the cursor in the information display.

If shooting information is not displayed in the monitor, press the **[INFO]** button. Press the **[INFO]** button again to place the cursor in the information display.

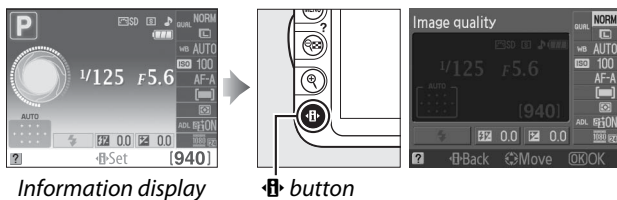

## 2 Display AF-area mode options.

Highlight the current AF-area mode in the information display and press **[OK]**.

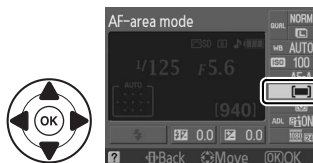

### 3 Choose an AF-area mode.

Highlight one of the following options and press . To return to shooting mode, press the shutter-release button halfway.

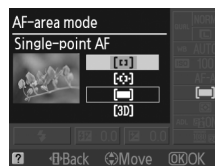

#### **AF-Area Mode**

The AF-area mode used when photographs are framed in the viewfinder can also be selected using the **AF-area mode > Viewfinder** option in the shooting menu (📖 131). AF-area mode selections made in shooting modes other than **P**, **S**, **A**, or **M** are reset when another shooting mode is selected.

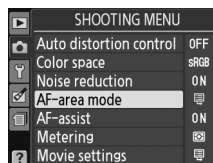

#### **3D-tracking (11 Points)**

When the shutter-release button is pressed halfway, the colors in the area surrounding the focus point are stored in the camera. Consequently 3D-tracking may not produce the desired results with subjects that are the same color as the background.



# Focus Point Selection

In manual focus mode or when autofocus is combined with AF-area modes other than **[ ]** (Auto-area AF), you can choose from 11 focus points, making it possible to compose photographs with the main subject almost anywhere in the frame.

- 1 Choose an AF-area mode other than **[ ]** (Auto-area AF; [□ 58](#)).

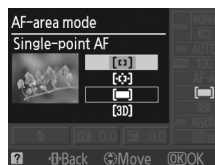

- 2 Select the focus point.

Use the multi selector to select the focus point in the viewfinder or information display while the exposure meters are on. Press **OK** to select the center focus point.

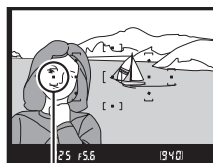

Focus point



# Focus Lock

Focus lock can be used to change the composition after focusing in AF-A, AF-S, and AF-C focus modes ([□ 55](#)), making it possible to focus on a subject that will not be in a focus point in the final composition. If the camera is unable to focus using autofocus ([□ 56](#)), you can also focus on another subject at the same distance and then use focus lock to recompose the photograph. Focus lock is most effective when an option other than **[ ]** (Auto-area AF) is selected for AF-area mode ([□ 58](#)).

- 1 Focus.

Position the subject in the selected focus point and press the shutter-release button halfway to initiate focus. Check that the in-focus indicator (●) appears in the viewfinder.



## 2 Lock focus.

**AF-A and AF-C focus modes:** With the shutter-release button pressed halfway (①), press the **AE-L/AF-L** button (②) to lock both focus and exposure (an **AE-L** icon will be displayed in the viewfinder; □ 80). Focus will remain locked while the **AE-L/AF-L** button is pressed, even if you later remove your finger from the shutter-release button.

Shutter-release button

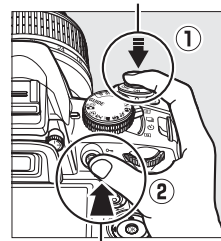

AE-L/AF-L button



**AF-S focus mode:** Focus will lock automatically when the in-focus indicator appears, and remain locked until you remove your finger from the shutter-release button. Focus can also be locked by pressing the **AE-L/AF-L** button (see above).

## 3 Recompose the photograph and shoot.

Focus will remain locked between shots if you keep the shutter-release button pressed halfway (**AF-S**) or keep the **AE-L/AF-L** button pressed, allowing several photographs in succession to be taken at the same focus setting.

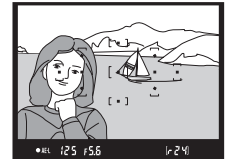

Do not change the distance between the camera and the subject while focus lock is in effect. If the subject moves, focus again at the new distance.

### The AE-L/AF-L Button

The **Buttons > AE-L/AF-L button** option in the setup menu (□ 146) controls the behavior of the **AE-L/AF-L** button.

# Manual Focus

Manual focus can be used when you are not using an AF-S or AF-I lens or when autofocus does not produce the desired results (□ 56).

## 1 Set the lens focus-mode switch.

If the lens is equipped with an A-M or M/A-M switch, slide the switch to **M**.

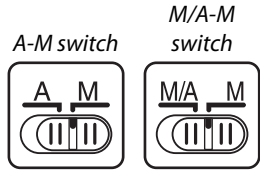

## 2 Focus.

To focus manually, adjust the lens focus ring until the image displayed on the clear matte field in the viewfinder is in focus. Photographs can be taken at any time, even when the image is not in focus.

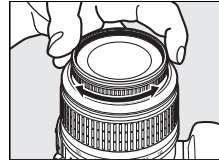

### Selecting Manual Focus with the Camera

Manual focus can also be selected by setting the camera focus mode to **MF** (manual focus; □ 55). Focus can then be adjusted manually, regardless of the mode selected with the lens.

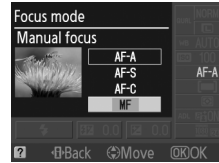

## ■ The Electronic Rangefinder

If the lens has a maximum aperture of  $f/5.6$  or faster, the viewfinder focus indicator can be used to confirm whether the subject in the selected focus point is in focus (the focus point can be selected from any of the 11 focus points). After positioning the subject in the selected focus point, press the shutter-release button halfway and rotate the lens focus ring until the in-focus indicator (●) is displayed. Note that with the subjects listed on page 56, the in-focus indicator may sometimes be displayed when the subject is not in focus; confirm focus in the viewfinder before shooting.

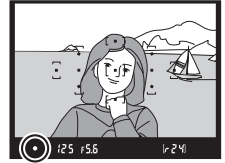
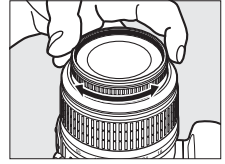

### Focal Plane Position

To determine the distance between your subject and the camera, measure from the focal plane mark on the camera body. The distance between the lens mounting flange and the focal plane is 46.5 mm (1.83 in.).

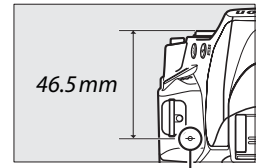

*Focal plane mark*

### The Exposure Indicator

If desired, the exposure indicator can be used to determine whether the focus point for manual focus is in front of or behind the subject (□ 144).



# Image Quality and Size



Together, image quality and size determine how much space each photograph occupies on the memory card. Larger, higher quality images can be printed at larger sizes but also require more memory, meaning that fewer such images can be stored on the memory card (☞ 187).

## Image Quality

Choose a file format and compression ratio (image quality).

Option	File type	Description
NEF (RAW) + JPEG fine	NEF/ JPEG	Two images are recorded: one NEF (RAW) image and one fine-quality JPEG image.
NEF (RAW)	NEF	Raw 12-bit data from the image sensor are saved directly to the memory card. Settings such as white balance and contrast can be adjusted on a computer after shooting.
JPEG fine	JPEG	Record JPEG images at a compression ratio of roughly 1 : 4 (fine quality).
JPEG normal	JPEG	Record JPEG images at a compression ratio of roughly 1 : 8 (normal quality).
JPEG basic	JPEG	Record JPEG images at a compression ratio of roughly 1 : 16 (basic quality).

### 1 Place the cursor in the information display.

If shooting information is not displayed in the monitor, press the  button. Press the  button again to place the cursor in the information display.

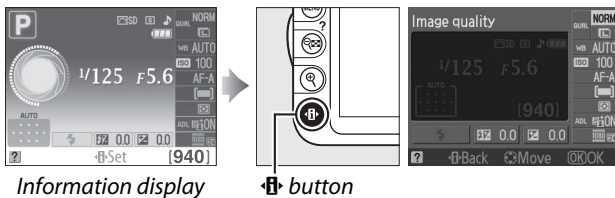

### 2 Display image quality options.

Highlight the current image quality in the information display and press .

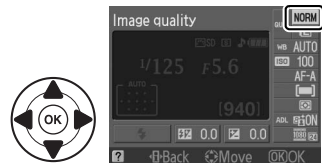



### 3 Choose a file type.

Highlight an option and press **OK**. To return to shooting mode, press the shutter-release button halfway.



#### **NEF (RAW) Images**

Note that the option selected for image size does not affect the size of NEF (RAW) or NEF (RAW)+JPEG images. Date imprint (□ 147) is not available at image quality settings of NEF (RAW) or NEF (RAW)+JPEG.

NEF (RAW) images can be viewed on the camera or using software such as Capture NX 2 (available separately; □ 177) or ViewNX 2 (available on the supplied ViewNX 2 CD). JPEG copies of NEF (RAW) images can be created using the **NEF (RAW) processing** option in the retouch menu (□ 160).

#### **NEF (RAW) + JPEG Fine**

When photographs taken at **NEF (RAW) + JPEG fine** are viewed on the camera, only the JPEG image will be displayed. When photographs taken at these settings are deleted, both NEF and JPEG images will be deleted.

#### **File Names**

Photographs are stored as image files with names of the form “DSC\_nnnn.xxx,” where *nnnn* is a four-digit number between 0001 and 9999 assigned automatically in ascending order by the camera, and *xxx* is one of the following three letter extensions: “NEF” for NEF images, “JPG” for JPEG images, or “MOV” for movies. The NEF and JPEG files recorded at a setting of **NEF (RAW) + JPEG fine** have the same file names but different extensions. Small copies created with the small picture option in the retouch menu have file names beginning with “SSC\_” and ending with the extension “.JPG” (e.g., “SSC\_0001.JPG”); copies created with the movie edit options (□ 50) have file names beginning with “DSC\_” and ending with the extension “.MOV” (trimmed copies, e.g., “DSC\_0001.MOV”) or “.JPG” (JPEG stills); copies created with the other options in the retouch menu have file names beginning with “CSC” (e.g., “CSC\_0001.JPG”). Images recorded with the **Color space** option in the shooting menu set to **Adobe RGB** (□ 133) have names that begin with an underscore (e.g., “\_DSC0001.JPG”).

#### **The Shooting Menu**

Image quality can also be adjusted using the **Image quality** option in the shooting menu (□ 131).

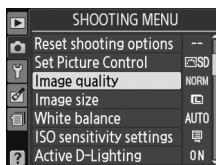



#### **The Fn Button**

Image quality and size can also be adjusted by pressing the **Fn** button and rotating the command dial (□ 146).





# Image Size

Image size is measured in pixels. Choose from the following options:

Image size	Size (pixels)	Print size (cm/in.)*
 Large	4,608 × 3,072	39 × 26/15.4 × 10.2
 Medium	3,456 × 2,304	29.3 × 19.5/11.5 × 7.7
 Small	2,304 × 1,536	19.5 × 13/7.7 × 5.1

\* Approximate size when printed at 300 dpi. Print size in inches equals image size in pixels divided by printer resolution in dots per inch (dpi; 1 inch = approximately 2.54 cm).

## 1 Place the cursor in the information display.

If shooting information is not displayed in the monitor, press the  button. Press the  button again to place the cursor in the information display.

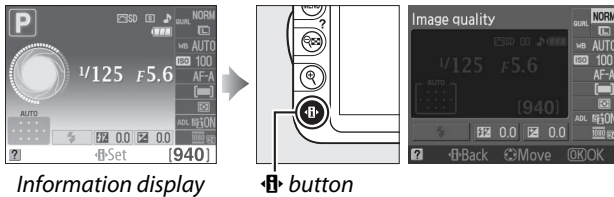

Information display

 button

## 2 Display image size options.

Highlight the current image size in the information display and press .



## 3 Choose an image size.

Highlight an option and press . To return to shooting mode, press the shutter-release button halfway.



### The Shooting Menu

Image size can also be adjusted using the **Image size** option in the shooting menu (131).

### The Fn Button

Image quality and size can also be adjusted by pressing the **Fn** button and rotating the command dial (146).



# Using the Built-in Flash

The camera supports a variety of flash modes for photographing poorly lit or backlit subjects.

## ■ Using the Built-in Flash: , , , , and Modes

### 1 Choose a flash mode ( 68).

### 2 Take pictures.

The flash will pop up as required when the shutter-release button is pressed halfway, and fire when a photograph is taken. *If the flash does not pop up automatically, DO NOT attempt to raise it by hand. Failure to observe this precaution could damage the flash.*

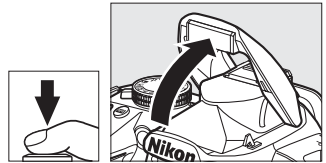

## ■ Using the Built-in Flash: P, S, A, and M Modes

### 1 Raise the flash.

Press the  button to raise the flash.

### 2 Choose a flash mode ( 68).

### 3 Take pictures.

The flash will fire whenever a picture is taken.

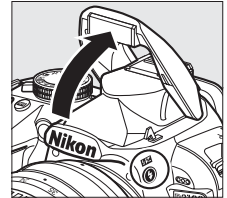

 button





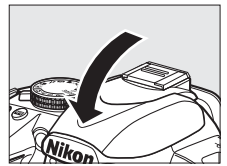

















### Lowering the Built-in Flash

To save power when the flash is not in use, press it gently downward until the latch clicks into place.





# Flash Mode

The flash modes available vary with shooting mode:

AUTO,  ,  , 			
 AUTO	Auto	  AUTO SLOW	Auto + slow sync + red-eye reduction
  AUTO	Auto + red-eye reduction	 AUTO SLOW	Auto + slow sync
	Off		Off
P, A		S, M	
	Fill flash		Fill flash
 	Red-eye reduction	 	Red-eye reduction
  SLOW	Slow sync + red-eye reduction	 REAR	Rear-curtain sync
 SLOW	Slow sync		
 REAR *	Rear curtain + slow sync		

\* SLOW appears in information display when setting is complete.

## 1 Place the cursor in the information display.

If shooting information is not displayed in the monitor, press the  button. Press the  button again to place the cursor in the information display.

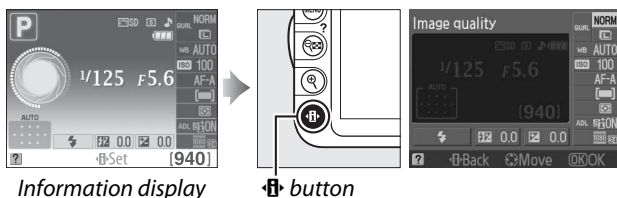

## 2 Display flash mode options.

Highlight the current flash mode in the information display and press .

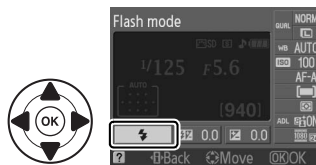

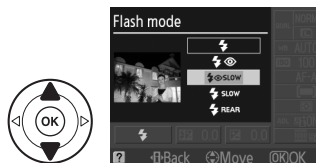

## 3 Choose a flash mode.

Highlight a mode and press . To return to shooting mode, press the shutter-release button halfway.



## Flash Modes

The flash modes listed on the previous page may combine one or more of the following settings, as shown by the flash mode icon:

- **AUTO (auto flash):** When lighting is poor or subject is back lit, flash pops up automatically when shutter-release button is pressed halfway and fires as required.
-  **(red-eye reduction):** Use for portraits. Red-eye reduction lamp lights before flash fires, reducing “red-eye.”
-  **(off):** Flash does not fire even when lighting is poor or subject is back-lit.
- **SLOW (slow sync):** Shutter speed slows automatically to capture background lighting at night or under low light. Use to include background lighting in portraits.
- **REAR (rear-curtain sync):** Flash fires just before shutter closes, creating a stream of light behind moving light sources (below at right). If this icon is not displayed, flash will fire as the shutter opens (front-curtain sync; the effect this produces with moving light sources is shown below at left).





*Front-curtain sync*



*Rear-curtain sync*

## Choosing a Flash Mode

The flash mode can also be selected by pressing the  button and rotating the command dial (in P, S, A, and M modes, raise the flash before using the  button to choose the flash mode).

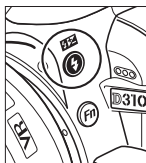

*Flash button*

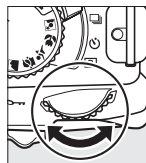

*Command dial*

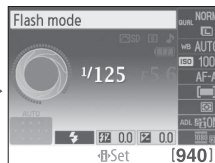

*Information display*

## The Built-in Flash





For information on the lenses that can be used with the built-in flash, see page 170. Remove lens hoods to prevent shadows. The flash has a minimum range of 0.6 m (2 ft.) and can not be used in the macro range of macro zoom lenses.

The shutter release may be briefly disabled to protect the flash after it has been used for several consecutive shots. The flash can be used again after a short pause.



### **Shutter Speeds Available with the Built-in Flash**

Shutter speed is restricted to the following ranges when the built-in flash is used:

Mode	Shutter speed	Mode	Shutter speed
   , P, A	$1/200$ – $1/60$ s	 , S	$1/200$ –30 s
	$1/200$ –1 s	M	$1/200$ –30 s, bulb

### **Aperture, Sensitivity, and Flash Range**

Flash range varies with sensitivity (ISO equivalency) and aperture.

Aperture at ISO equivalent of						Range	
100	200	400	800	1600	3200	m	ft.
1.4	2	2.8	4	5.6	8	1.0–8.5	3ft. 3in.–27ft. 11in.
2	2.8	4	5.6	8	11	0.7–6.0	2ft. 4in.–19ft. 8in.
2.8	4	5.6	8	11	16	0.6–4.2	2ft.–13ft. 9in.
4	5.6	8	11	16	22	0.6–3.0	2ft.–9ft. 10in.
5.6	8	11	16	22	32	0.6–2.1	2ft.–6ft. 11in.
8	11	16	22	32	—	0.6–1.5	2ft.–4ft. 11in.
11	16	22	32	—	—	0.6–1.1	2ft.–3ft. 7in.
16	22	32	—	—	—	0.6–0.7	2ft.–2ft. 4in.



# ISO Sensitivity

“ISO sensitivity” is the digital equivalent of film speed. Choose from settings that range from a value roughly equivalent to ISO 100 to one roughly equivalent to ISO 3200 in steps equivalent to 1 EV. For special situations, ISO sensitivity can be raised above ISO 3200 by about 1 EV (Hi 1, equivalent to ISO 6400) or 2 EV (Hi 2, equivalent to ISO 12800). Auto and scene modes also offer an **AUTO** option, which allows the camera to set ISO sensitivity automatically in response to lighting conditions; **AUTO** is selected automatically in **AUTO** and **☺** modes. The higher the ISO sensitivity, the less light needed to make an exposure, allowing higher shutter speeds or smaller apertures.

## 1 Place the cursor in the information display.

If shooting information is not displayed in the monitor, press the **INFO** button. Press the **INFO** button again to place the cursor in the information display.

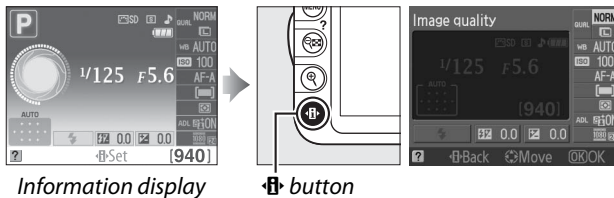

## 2 Display ISO sensitivity options.

Highlight the current ISO sensitivity in the information display and press **OK**.

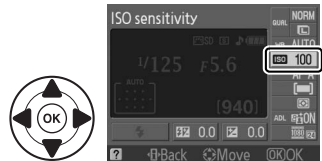

## 3 Choose an ISO sensitivity.

Highlight an option and press **OK**. To return to shooting mode, press the shutter-release button halfway.

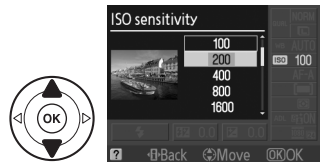

## **AUTO**

If the mode dial is rotated to **P**, **S**, **A**, or **M** after **AUTO** is selected for ISO sensitivity in another mode, the ISO sensitivity last selected in **P**, **S**, **A**, or **M** mode will be restored.

## **Hi 1/Hi 2**

Pictures taken at these settings are more likely to be subject to noise (randomly-spaced bright pixels, fog, or lines).

## **The Shooting Menu**

ISO sensitivity can also be adjusted using the **ISO sensitivity settings** option in the shooting menu (📖 132).

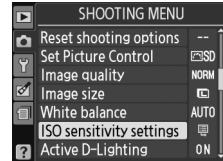

## **See Also**

For information on enabling auto ISO sensitivity control in **P**, **S**, **A**, or **M** modes, see page 132. For information on using the **Noise reduction** option in the shooting menu to reduce noise at high ISO sensitivities, see page 134. For information on using the **Fn** button and the command dial to select ISO sensitivity, see page 146.







# P, S, A, and M Modes

## Shutter Speed and Aperture

P, S, A, and M modes offer different degrees of control over shutter speed and aperture:



Mode		Description
P	Programmed auto (☐ 74)	Camera sets shutter speed and aperture for optimal exposure. Recommended for snapshots and in other situations in which there is little time to adjust camera settings.
S	Shutter-priority auto (☐ 75)	User chooses shutter speed; camera selects aperture for best results. Use to freeze or blur motion.
A	Aperture-priority auto (☐ 76)	User chooses aperture; camera selects shutter speed for best results. Use to blur background or bring both foreground and background into focus.
M	Manual (☐ 77)	User controls both shutter speed and aperture. Set shutter speed to “bulb” for long time-exposures.

### ✓ Lens Aperture Rings

When using a CPU lens equipped with an aperture ring (☐ 168), lock the aperture ring at the minimum aperture (highest f-number). Type G lenses are not equipped with an aperture ring.

### ✎ Shutter Speed and Aperture

The same exposure can be achieved with different combinations of shutter speed and aperture. Fast shutter speeds and large apertures freeze moving objects and soften background details, while slow shutter speeds and small apertures blur moving objects and bring out background details.



Fast shutter speed  
( $1/1,600$  s)

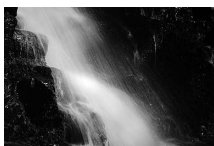

Slow shutter speed  
(1 s)



Large aperture (f/5.6)



Small aperture (f/22)

(Remember, the higher the f-number, the smaller the aperture.)



# Mode P (Programmed Auto)

In this mode, the camera automatically adjusts shutter speed and aperture for optimal exposure in most situations. This mode is recommended for snapshots and other situations in which you want to leave the camera in charge of shutter speed and aperture. To take photographs in programmed auto:

## 1 Rotate the mode dial to P.

Mode dial

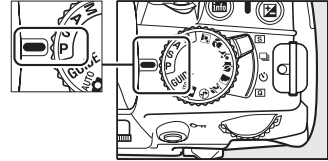

## 2 Frame a photograph, focus, and shoot.

### Flexible Program

In mode **P**, different combinations of shutter speed and aperture can be selected by rotating the command dial ("flexible program"). Rotate the dial to the right for large apertures (low f-numbers) that blur background details or fast shutter speeds that "freeze" motion. Rotate the dial to the left for small apertures (high f-numbers) that increase depth of field or slow shutter speeds that blur motion. All combinations produce the same exposure. While flexible program is in effect, a **P** (**Pi**) indicator appears in the viewfinder and information display. To restore default shutter speed and aperture settings, rotate the command dial until the indicator is no longer displayed, choose another mode, or turn the camera off.

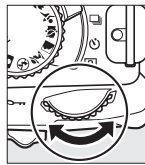

Command dial

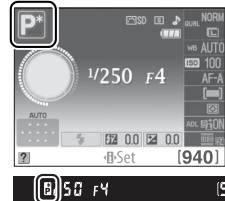

# Mode S (Shutter-Priority Auto)

In shutter-priority auto, you choose the shutter speed while the camera automatically selects the aperture that will produce the optimal exposure. Use slow shutter speeds to suggest motion by blurring moving subjects, fast shutter speeds to “freeze” motion.



Fast shutter speed ( $1/1,600$  s)



Slow shutter speed (1 s)

To take photographs in shutter-priority auto:

## 1 Rotate the mode dial to S.

Mode dial

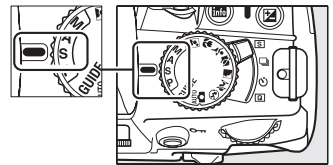

## 2 Choose a shutter speed.

Shutter speed is shown in the viewfinder and information display. Rotate the command dial to choose the desired shutter speed from values between 30 s and  $1/4,000$  s.

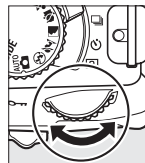

Command dial



## 3 Frame a photograph, focus, and shoot.

# Mode A (Aperture-Priority Auto)

In aperture-priority auto, you choose the aperture while the camera automatically selects the shutter speed that will produce the optimal exposure. Large apertures (low f-numbers) reduce depth of field, blurring objects behind and in front of the main subject. Small apertures (high f-numbers) increase depth of field, bringing out details in the background and foreground. Short field depths are generally used in portraits to blur background details, long field depths in landscape photographs to bring the foreground and background into focus.



Large aperture (f/5.6)



Small aperture (f/22)

To take photographs in aperture-priority auto:

## 1 Rotate the mode dial to A.

Mode dial

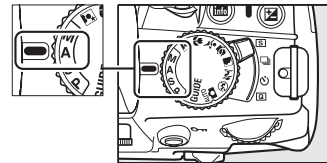

## 2 Choose an aperture.

Aperture is shown in the viewfinder and information display. Rotate the command dial to choose the desired aperture from values between the minimum and maximum for the lens.

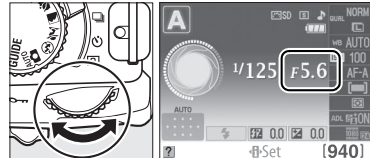

Command dial

## 3 Frame a photograph, focus, and shoot.

# Mode M (Manual)

In manual exposure mode, you control both shutter speed and aperture. To take photographs in manual exposure mode:

## 1 Rotate the mode dial to M.

Mode dial

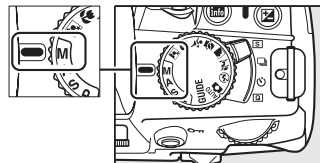

## 2 Choose aperture and shutter speed.

Checking the exposure indicator (see below), adjust shutter speed and aperture. Shutter speed is selected by rotating the command dial: choose from values between 30 s and  $1/4,000$  s or select “bulb” to hold the shutter open indefinitely for a long time-exposure (□ 78). Aperture is selected by pressing the  button and rotating the command dial: choose from values between the minimum and maximum for the lens. Shutter speed and aperture are shown in the viewfinder and information display.

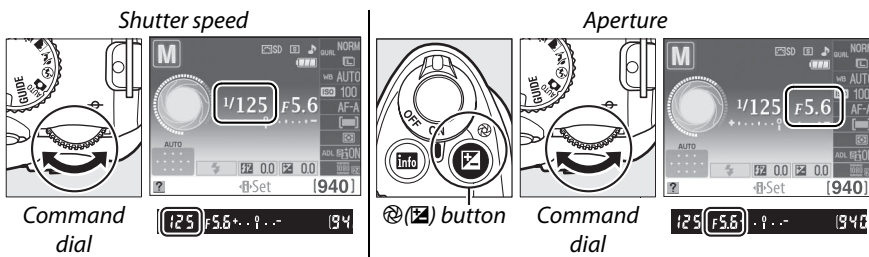

## 3 Frame a photograph, focus, and shoot.

### The Exposure Indicator

If a CPU lens is attached and a shutter speed other than “bulb” is selected, the exposure indicator in the viewfinder and information display shows whether the photograph would be under- or over-exposed at current settings (the illustrations below show the display in the viewfinder). If the limits of the exposure metering system are exceeded, the indicator will flash.

Optimal exposure	Underexposed by $1/3$ EV	Overexposed by over 2 EV
+ . 0 . . -	+ . 0 . . -	+  0 . . -

## ■ Long Time-Exposures (M Mode Only)

At a shutter speed of “bulb,” the shutter remains open while the shutter-release button is held down. This can be used for long time-exposure photographs of moving lights, the stars, night scenery, or fireworks. A tripod or optional MC-DC2 remote cord (☐ 177) is recommended to prevent blur.



Length of exposure: 35 s  
Aperture: f/25

### 1 Ready the camera.

Mount the camera on a tripod or place it on a stable, level surface. To prevent loss of power before the exposure is complete, use a fully charged EN-EL14 battery or an optional EH-5a AC adapter and EP-5A power connector. Note that noise (randomly-spaced bright pixels or fog) may be present in long exposures; before shooting, choose **On** for the **Noise reduction** option in the shooting menu (☐ 134).

### 2 Rotate the mode dial to M.

Mode dial

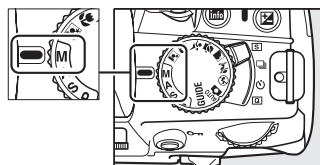

### 3 Choose a shutter speed.

Rotate the command dial until “Bulb” (b u l b) appears in the viewfinder or information display.

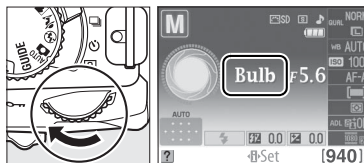

Command dial

### 4 Open the shutter.

After focusing, press the shutter-release button all the way down. Keep the shutter-release button pressed until the exposure is complete.

### 5 Close the shutter.

Take your finger off the shutter-release button.





#### Self-timer Mode

In self-timer mode, a shutter speed of “Bulb” is equivalent to approximately  $1/10$  s.



# Exposure

## Metering

Choose how the camera sets exposure in **P**, **S**, **A**, and **M** modes (in other modes, the camera selects the metering method automatically).

Method	Description
 <b>Matrix</b>	Produces natural results in most situations. Camera uses 420-pixel RGB sensor to meter a wide area of the frame and set exposure according to tone distribution, color, composition, and, with type G or D lenses (□ 168), distance information (3D color matrix metering II; with other CPU lenses, the camera uses color matrix metering II, which does not include 3D distance information).
 <b>Center-weighted</b>	Camera meters entire frame but assigns greatest weight to center area. Classic meter for portraits; recommended when using filters with an exposure factor (filter factor) over 1x.
 <b>Spot</b>	Camera meters current focus point; use to meter off-center subjects (if  <b>Auto-area AF</b> is selected for AF-area mode during viewfinder photography as described on page 58, camera will meter center focus point). Ensures that subject will be correctly exposed, even when background is much brighter or darker.

### 1 Place the cursor in the information display.

If shooting information is not displayed in the monitor, press the  button. Press the  button again to place the cursor in the information display.

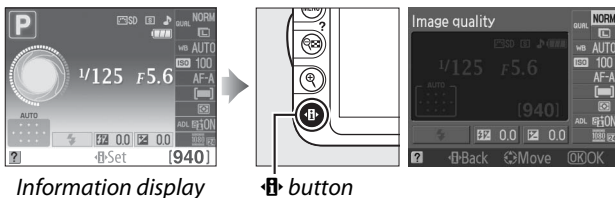

### 2 Display metering options.

Highlight the current metering method in the information display and press .

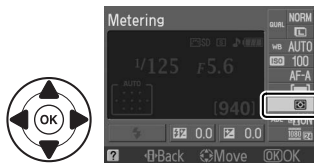

### 3 Choose a metering method.

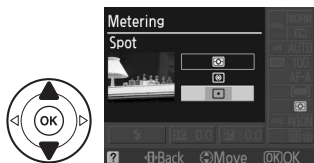

Highlight an option and press . To return to shooting mode, press the shutter-release button halfway.



# Autoexposure Lock

Use autoexposure lock to recompose photographs after metering exposure:

## 1 Set metering to or (📖 79).

 will not produce the desired results. Note that autoexposure lock is not available in  or  mode.

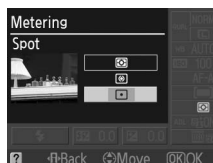

## 2 Lock exposure.

Position the subject in the selected focus point and press the shutter-release button halfway. With the shutter-release button pressed halfway and the subject positioned in the focus point, press the **AE-L/AF-L** button to lock focus and exposure.

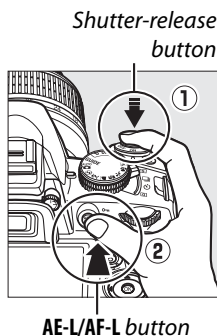

While exposure lock is in effect, an **AE-L** indicator will appear in the viewfinder.



## 3 Recompose the photograph.

Keeping the **AE-L/AF-L** button pressed, recompose the photograph and shoot.

### The Shooting Menu

Metering can also be adjusted using the **Metering** option in the shooting menu (📖 131).

### Adjusting Shutter Speed and Aperture

While exposure lock is in effect, the following settings can be adjusted without altering the metered value for exposure:

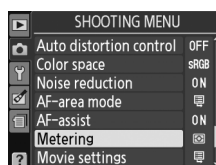

Mode	Setting
Programmed auto	Shutter speed and aperture (flexible program; 📖 74)
Shutter-priority auto	Shutter speed
Aperture-priority auto	Aperture

The metering method itself can not be changed while exposure lock is in effect.

### See Also

If **On** is selected for **Buttons > AE lock** in the setup menu (📖 146), exposure will lock when the shutter-release button is pressed halfway. For information on changing the role of the **AE-L/AF-L** button, see **Buttons > AE-L/AF-L button**.



# Exposure Compensation

Exposure compensation is used to alter exposure from the value suggested by the camera, making pictures brighter or darker. It is most effective when used with center-weighted or spot metering (☐ 79). Choose from values between  $-5$  EV (underexposure) and  $+5$  EV (overexposure) in increments of  $1/3$  EV. In general, positive values make the subject brighter while negative values make it darker.



$-1$  EV





No exposure compensation



$+1$  EV

## 1 Place the cursor in the information display.

If shooting information is not displayed in the monitor, press the  button. Press the  button again to place the cursor in the information display.



Information display

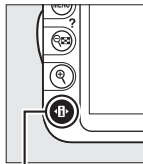

 button



## 2 Display exposure compensation options.

Highlight exposure compensation in the information display and press .



## 3 Choose a value.

Highlight a value and press . To return to shooting mode, press the shutter-release button halfway.



Normal exposure can be restored by setting exposure compensation to  $\pm 0$ . Exposure compensation is not reset when the camera is turned off.

### **The Button**

Exposure compensation can also be set by pressing the  button and rotating the command dial. The selected value is shown in the viewfinder and information display.

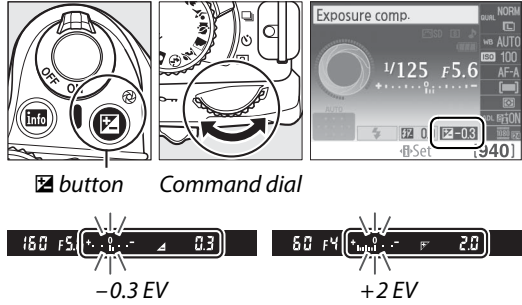

### **Mode M**

In mode **M**, exposure compensation affects only the exposure indicator; shutter speed and aperture do not change.

### **Using a Flash**

When a flash is used, exposure compensation affects both background exposure and flash level.

# Flash Compensation

Flash compensation is used to alter flash output from the level suggested by the camera, changing the brightness of the main subject relative to the background. Choose from values between  $-3$  EV (darker) and  $+1$  EV (brighter) in increments of  $1/3$  EV; in general, positive values make the subject brighter while negative values make it darker.

## 1 Place the cursor in the information display.

If shooting information is not displayed in the monitor, press the **INFO** button. Press the **INFO** button again to place the cursor in the information display.

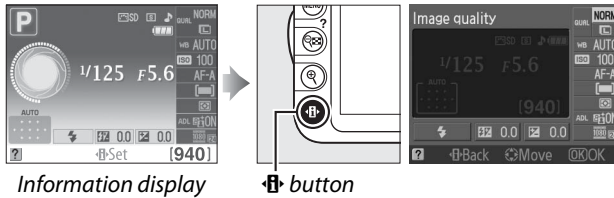

## 2 Display flash compensation options.

Highlight flash compensation in the information display and press **OK**.

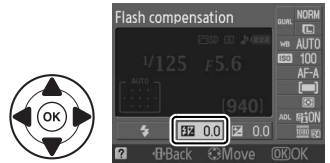



## 3 Choose a value.

Highlight a value and press **OK**. To return to shooting mode, press the shutter-release button halfway.



Normal flash output can be restored by setting flash compensation to  $\pm 0$ . Flash compensation is not reset when the camera is turned off.

### The (⚡) and Buttons

Flash compensation can also be set by rotating the command dial while pressing the  (⚡) and  buttons. The selected value is shown in the viewfinder and information display.

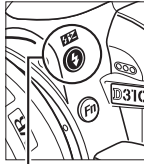

 (⚡) button

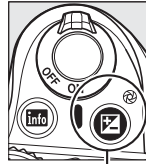

 button

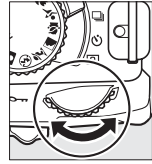

Command dial

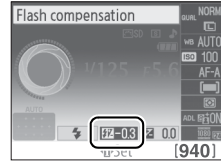



-0.3 EV

+1 EV

### Optional Flash Units

Flash compensation is also available with optional SB-900, SB-800, SB-600, SB-400, or SB-R200 flash units. The SB-900, SB-800, and SB-600 also allow flash compensation to be set using the controls on the flash unit. The flash compensation selected with the optional flash unit is added to the flash compensation selected with the camera.

# Active D-Lighting

When **ON On** is selected, the camera automatically adjusts Active D-Lighting during shooting to preserve details in highlights and shadows, creating photographs with natural contrast. Use for high contrast scenes, for example when photographing brightly lit outdoor scenery through a door or window or taking pictures of shaded subjects on a sunny day. It is most effective when used with  **Matrix** metering ( 79).





Active D-Lighting: **OFF Off**



Active D-Lighting: **ON On**

## 1 Place the cursor in the information display.

If shooting information is not displayed in the monitor, press the  button. Press the  button again to place the cursor in the information display.



Information display



 button



## 2 Display Active D-Lighting options.

Highlight Active D-Lighting in the information display and press .



## 3 Choose an option.

Highlight **ON On** or **OFF Off** and press . To return to shooting mode, press the shutter-release button halfway.



## ✓ Active D-Lighting

Noise (randomly-spaced bright pixels, fog, or lines) may appear in photographs taken with Active D-Lighting. Uneven shading may be visible with some subjects.

### ✎ “Active D-Lighting” Versus “D-Lighting”

The **Active D-Lighting** option in the shooting menu adjusts exposure before shooting to optimize the dynamic range, while the **D-Lighting** option in the retouch menu (📖 153) optimizes dynamic range in images after shooting.

### ✎ The Shooting Menu

Active D-Lighting can also be adjusted using the **Active D-Lighting** option in the shooting menu (📖 131).









### ✎ See Also



For information on using the **Fn** button and command dial to turn Active D-Lighting on and off, see page 146.

# White Balance

White balance ensures that colors are unaffected by the color of the light source. Auto white balance is recommended for most light sources; in **P**, **S**, **A**, and **M** modes, other values can be selected if necessary according to the type of source:

Option	Description
<b>AUTO Auto</b>	Automatic white balance adjustment. Recommended in most situations.
 <b>Incandescent</b>	Use under incandescent lighting.
 <b>Fluorescent</b>	Use with the light sources listed on page 88.
 <b>Direct sunlight</b>	Use with subjects lit by direct sunlight.
 <b>Flash</b>	Use with the flash.
 <b>Cloudy</b>	Use in daylight under overcast skies.
 <b>Shade</b>	Use in daylight with subjects in the shade.
<b>PRE Preset manual</b>	Measure white balance or copy white balance from existing photo (☞ 90).

## 1 Place the cursor in the information display.

If shooting information is not displayed in the monitor, press the  button. Press the  button again to place the cursor in the information display.

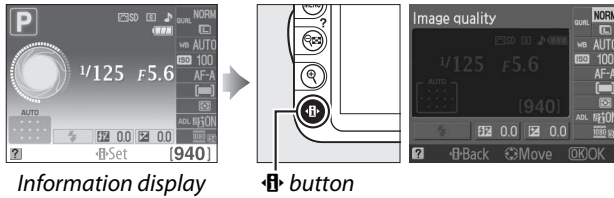

## 2 Display white balance options.

Highlight the current white balance setting in the information display and press .

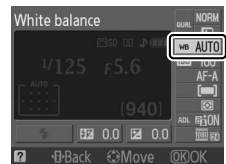

## 3 Choose a white balance option.

Highlight an option and press . To return to shooting mode, press the shutter-release button halfway.

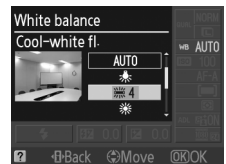

## The Shooting Menu

White balance can be selected using the **White balance** option in the shooting menu (☐ 131), which also can be used to fine-tune white balance (☐ 89) or measure a value for preset white balance (☐ 90).

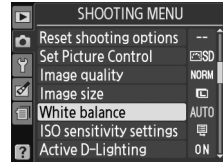



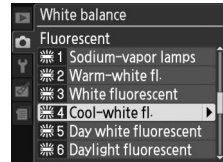









The  **Fluorescent** option in the **White balance** menu can be used to select the light source from the bulb types shown at right.



## Color Temperature

The perceived color of a light source varies with the viewer and other conditions. Color temperature is an objective measure of the color of a light source, defined with reference to the temperature to which an object would have to be heated to radiate light in the same wavelengths. While light sources with a color temperature in the neighborhood of 5,000–5,500 K appear white, light sources with a lower color temperature, such as incandescent light bulbs, appear slightly yellow or red. Light sources with a higher color temperature appear tinged with blue. The camera white balance options are adapted to the following color temperatures:

-  (sodium-vapor lamps): **2,700 K**
-  (incandescent)/  
•  (warm-white fl.): **3,000 K**
-  (white fluorescent): **3,700 K**
-  (cool-white fl.): **4,200 K**
-  (day white fluorescent): **5,000 K**
-  (direct sunlight): **5,200 K**
-  (flash): **5,400 K**
-  (cloudy): **6,000 K**
-  (daylight fluorescent): **6,500 K**
-  (mercury-vapor lamps): **7,200 K**
-  (shade): **8,000 K**

## The Fn Button

For information on using the **Fn** button and the command dial for white balance, see page 146.



# Fine-Tuning White Balance

White balance can be “fine tuned” to compensate for variations in the color of the light source or to introduce a deliberate color cast into an image. White balance is fine tuned using the **White balance** option in the shooting menu.

## 1 Display white balance options.

To display the menus, press the **MENU** button. Highlight **White balance** in the shooting menu and press **▶** to display white balance options.

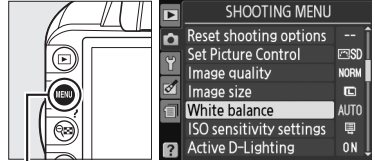

MENU button

## 2 Select a white balance option.

Highlight an option other than **Preset manual** and press **▶** (if **Fluorescent** is selected, highlight a lighting type and press **▶**). The fine-tuning options shown at right will be displayed. Fine-tuning is not available with **Preset manual** white balance.

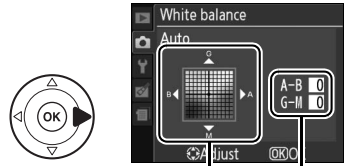

Coordinates

Adjustment

## 3 Fine tune white balance.

Use the multi selector to fine-tune white balance.

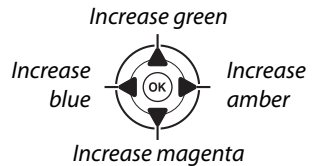

### White Balance Fine Tuning

The colors on the fine-tuning axes are relative, not absolute. For example, moving the cursor to **B** (blue) when a “warm” setting such as  (incandescent) is selected will make photographs slightly “colder” but will not actually make them blue.

## 4 Save changes and exit.

Press **OK**.



# Preset Manual

Preset manual is used to record and recall custom white balance settings for shooting under mixed lighting or to compensate for light sources with a strong color cast. Two methods are available for setting preset white balance:

Method	Description
Measure	Neutral gray or white object is placed under lighting that will be used in final photo and white balance measured by camera (see below).
Use photo	White balance is copied from photo on memory card (📄 93).

## ■ ■ Measuring a Value for Preset White Balance

### 1 Light a reference object.

Place a neutral gray or white object under the lighting that will be used in the final photograph.

### 2 Display white balance options.

To display the menus, press the MENU button. Highlight **White balance** in the shooting menu and press ► to display white balance options.

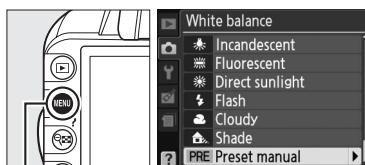

MENU button

### 3 Select Preset manual.

Highlight **Preset manual** and press ►.

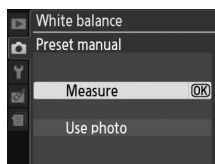

### 4 Select Measure.

Highlight **Measure** and press ►. The menu shown at right will be displayed; highlight **Yes** and press **OK**.

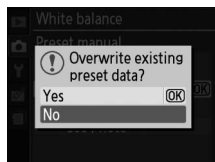

The message shown at right will be displayed before the camera enters preset measurement mode.

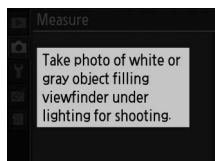

When the camera is ready to measure white balance, a flashing **PrE** (PRE) will appear in the viewfinder and information display.



## 5 Measure white balance.

Before the indicators stop flashing, frame the reference object so that it fills the viewfinder and press the shutter-release button all the way down. No photograph will be recorded; white balance can be measured accurately even when the camera is not in focus.



## 6 Check the results.

If the camera was able to measure a value for white balance, the message shown at right will be displayed and **ūd** will flash in the viewfinder for about eight seconds before the camera returns to shooting mode. To return to shooting mode immediately, press the shutter-release button halfway.

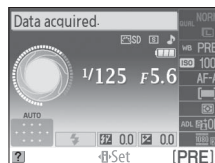

If lighting is too dark or too bright, the camera may be unable to measure white balance. A message will appear in the information display and a flashing **no ūd** will appear in the viewfinder for about eight seconds. Return to Step 4 and measure white balance again.

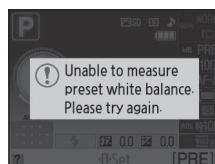

### ✔ **Measuring Preset White Balance**

If no operations are performed while the displays are flashing, direct measurement mode will end when the exposure meters turn off. The auto meter-off delay can be changed using the **Auto off timers** option in the setup menu (□ 143). The default setting is eight seconds.

### ✔ **Preset White Balance**

The camera can store only one value for preset white balance at a time; the existing value will be replaced when a new value is measured. Note that exposure is automatically increased by 1 EV when measuring white balance; when shooting in mode **M**, adjust exposure so that the exposure indicator shows  $\pm 0$  (□ 77).

### ✍ **Other Methods for Measuring Preset White Balance**

To enter preset measurement mode (see above) after selecting preset white balance in the information display (□ 87), press **OK** for a few seconds. If white balance has been assigned to the **Fn** button (□ 146) and preset white balance selected by pressing the **Fn** button and rotating the command dial, the camera will also enter preset measurement mode if the **Fn** button is pressed for a few seconds.

### ✍ **Studio Settings**

In studio settings, a standard gray panel can be used as a reference object when measuring preset white balance.



## ■ Copying White Balance from a Photograph

Follow the steps below to copy a value for white balance from a photograph on the memory card.

### 1 Select Preset manual.

To display the menus, press the **MENU** button. Highlight **White balance** in the shooting menu and press **▶** to display white balance options. Highlight **Preset manual** and press **▶**.

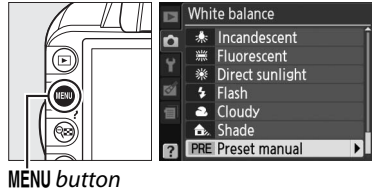

### 2 Select Use photo.

Highlight **Use photo** and press **▶**.

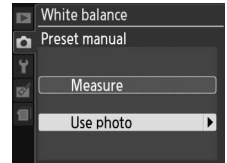

### 3 Choose Select image.

Highlight **Select image** and press **▶** (to skip the remaining steps and use the image last selected for preset white balance, select **This image**).



### 4 Choose a folder.

Highlight the folder containing the source image and press **▶**.



### 5 Highlight the source image.

To view the highlighted image full frame, press and hold the **Q** button.

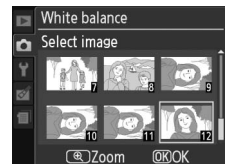

### 6 Copy white balance.

Press **OK** to set preset white balance to the white balance value for the highlighted photograph.









# Picture Controls

Nikon's unique Picture Control system makes it possible to share image processing settings, including sharpening, contrast, brightness, saturation, and hue, among compatible devices and software.

## Selecting a Picture Control

The camera offers six Picture Controls. In **P**, **S**, **A**, and **M** modes, you can choose a Picture Control according to the subject or type of scene (in other modes, the camera selects a Picture Control automatically).

Option	Description
 <b>Standard</b>	Standard processing for balanced results. Recommended for most situations.
 <b>Neutral</b>	Minimal processing for natural results. Choose for photographs that will later be extensively processed or retouched.
 <b>Vivid</b>	Pictures are enhanced for a vivid, photoprint effect. Choose for photographs that emphasize primary colors.
 <b>Monochrome</b>	Take monochrome photographs.
 <b>Portrait</b>	Process portraits for skin with natural texture and a rounded feel.
 <b>Landscape</b>	Produces vibrant landscapes and cityscapes.

### 1 Display Picture Controls.

To display the menus, press the **MENU** button. Highlight **Set Picture Control** in the shooting menu and press **▶** to display a list of Picture Controls.

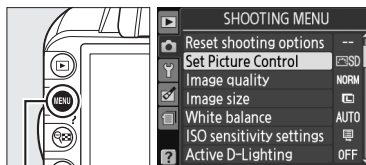

MENU button

### 2 Choose a Picture Control.

Highlight an option and press **OK**.

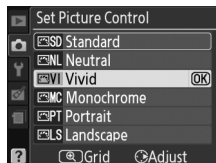

# Modifying Picture Controls

Picture Controls can be modified to suit the scene or the user's creative intent. Choose a balanced combination of settings using **Quick adjust**, or make manual adjustments to individual settings.

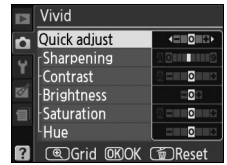

## 1 Display the Picture Control menu.

To display the menus, press the **MENU** button. Highlight **Set Picture Control** in the shooting menu and press **▶**.

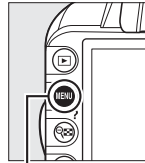

MENU button

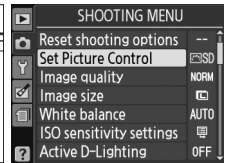

## 2 Select a Picture Control.

Highlight the desired Picture Control and press **▶**.

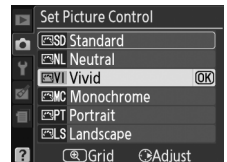

## 3 Adjust settings.

Press **▲** or **▼** to highlight the desired setting and press **◀** or **▶** to choose a value (p. 96). Repeat this step until all settings have been adjusted, or select **Quick adjust** to choose a preset combination of settings. Default settings can be restored by pressing the **⌵** button.



## 4 Save changes and exit.

Press **OK**.



### Modifications to Original Picture Controls

Picture Controls that have been modified from default settings are indicated by an asterisk (\*).



## Picture Control Settings



Option	Description
<b>Quick adjust</b>	Choose from options between <b>-2</b> and <b>+2</b> to reduce or exaggerate the effect of the selected Picture Control (note that this resets all manual adjustments). For example, choosing positive values for <b>Vivid</b> makes pictures more vivid. Not available with <b>Neutral</b> or <b>Monochrome</b> Picture Controls.
<b>Manual adjustments (all Picture Controls)</b>	<b>Sharpening</b> Control the sharpness of outlines. Select <b>A</b> to adjust sharpening automatically according to the type of scene, or choose from values between <b>0</b> (no sharpening) and <b>9</b> (the higher the value, the greater the sharpening).
	<b>Contrast</b> Select <b>A</b> to adjust contrast automatically according to the type of scene, or choose from values between <b>-3</b> and <b>+3</b> (choose lower values to prevent highlights in portrait subjects from being “washed out” in direct sunlight, higher values to preserve detail in misty landscapes and other low-contrast subjects). Not available if Active D-Lighting (☐ 85) is on; reset if Active D-Lighting is activated after value is changed.
	<b>Brightness</b> Choose <b>-1</b> for reduced brightness, <b>+1</b> for enhanced brightness. Does not affect exposure. Not available if Active D-Lighting (☐ 85) is on; reset if Active D-Lighting is activated after value is changed.
<b>Manual adjustments (non-monochrome only)</b>	<b>Saturation</b> Control the vividness of colors. Select <b>A</b> to adjust saturation automatically according to the type of scene, or choose from values between <b>-3</b> and <b>+3</b> (lower values reduce saturation and higher values increase it).
	<b>Hue</b> Choose negative values (to a minimum of <b>-3</b> ) to make reds more purple, blues more green, and greens more yellow, positive values (up to <b>+3</b> ) to make reds more orange, greens more blue, and blues more purple.
<b>Manual adjustments (monochrome only)</b>	<b>Filter effects</b> Simulate the effect of color filters on monochrome photographs. Choose from <b>Off</b> (the default setting), yellow, orange, red, and green (☐ 97).
	<b>Toning</b> Choose the tint used in monochrome photographs from <b>B&amp;W</b> (black-and-white), <b>Sepia</b> , <b>Cyanotype</b> (blue-tinted monochrome), <b>Red</b> , <b>Yellow</b> , <b>Green</b> , <b>Blue Green</b> , <b>Blue</b> , <b>Purple Blue</b> , <b>Red Purple</b> (☐ 97).

### “A” (Auto)

Results for auto contrast and saturation vary with exposure and the position of the subject in the frame.



### **The Picture Control Grid**

Pressing the  button in Step 3 displays a Picture Control grid showing the contrast and saturation for the selected Picture Control in relation to the other Picture Controls (only contrast is displayed when **Monochrome** is selected). Release the  button to return to the Picture Control menu.

The icons for Picture Controls that use auto contrast and saturation are displayed in green in the Picture Control grid, and lines appear parallel to the axes of the grid.

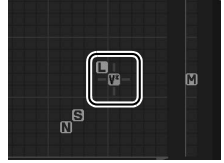
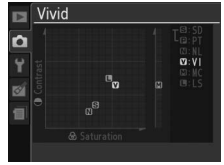

### **Previous Settings**

The line under the value display in the Picture Control setting menu indicates the previous value for the setting. Use this as a reference when adjusting settings.

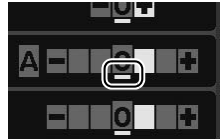



### **Filter Effects (Monochrome Only)**

The options in this menu simulate the effect of color filters on monochrome photographs. The following filter effects are available:

Option	Description
<b>Y</b> Yellow	Enhances contrast. Can be used to tone down the brightness of the sky in landscape photographs. Orange produces more contrast than yellow, red
<b>O</b> Orange	more contrast than orange.
<b>R</b> Red	
<b>G</b> Green	Softens skin tones. Can be used for portraits.

Note that the effects achieved with **Filter effects** are more pronounced than those produced by physical glass filters.

### **Toning (Monochrome Only)**

Pressing  when **Toning** is selected displays saturation options. Press  or  to adjust saturation. Saturation control is not available when **B&W** (black-and-white) is selected.



# The GP-1 GPS Unit

The GP-1 GPS unit (available separately) can be connected to the camera's accessory terminal (□ 177) using the cable supplied with the GP-1, allowing information on the camera's current position to be recorded when photographs are taken. Turn the camera off before connecting the GP-1; for more information, see the GP-1 manual.

## ■ Setup Menu Options

The **GPS** item in the setup menu contains the options listed below.

- **Auto meter-off:** Choose whether the exposure meters turn off automatically when the GP-1 is attached.

Option	Description
<b>Enable</b>	Exposure meters turn off automatically if no operations are performed for the time selected for <b>Auto off timers</b> in the setup menu (□ 143; to allow the camera time to acquire GPS data, the delay is extended by up to one minute after exposure meters are activated or the camera is turned on). This reduces the drain on the battery.
<b>Disable</b>	Exposure meters do not turn off while the GP-1 is connected.

- **Position:** This item is only available if the GP-1 is connected, when it displays the current latitude, longitude, altitude, and Coordinated Universal Time (UTC) as reported by the GP-1.

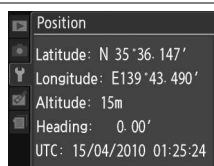

### ✍ Coordinated Universal Time (UTC)

UTC data is provided by the GPS device and is independent of the camera clock.

### ✍ The GPS Icon

Connection status is shown by the **GPS** icon:

- **GPS (static):** Camera has established communication with GP-1. Photo information for pictures taken while this icon is displayed include an additional page of GPS data (□ 104).
- **GPS (flashing):** The GP-1 is searching for a signal. Pictures taken while the icon is flashing do not include GPS data.
- **No icon:** No new GPS data have been received from the GP-1 for at least two seconds. Pictures taken when the **GPS** icon is not displayed do not include GPS data.



















# More on Playback

## Full-Frame Playback

To play photographs back, press the  button. The most recent photograph will be displayed in the monitor.



To	Use	Description
View additional photographs		Press  to view photographs in order recorded,  to view photographs in reverse order.
View photo information		Press  or  to view information about current photograph (□ 100).
View thumbnails		See page 105 for more information on the thumbnail display.
Zoom in on photograph		See page 107 for more information on playback zoom.
Delete images		Confirmation dialog will be displayed. Press  again to delete photo.
Change protect status	 (AF-L)	To protect image, or to remove protection from protected image, press  (AF-L) button (□ 108).
Return to shooting mode		Press shutter-release button halfway. Monitor will turn off; photographs can be taken immediately.
Display menus	<b>MENU</b>	See page 129 for more information.
Retouch photo or play movie		Create retouched copy of current photograph (□ 151). If current picture is marked with  icon to show that it is a movie, pressing  starts movie playback (□ 49).

# Photo Information

Photo information is superimposed on images displayed in full-frame playback. Press ▲ or ▼ to cycle through photo information as shown below. Note that shooting data, RGB histograms, and highlights are only displayed if corresponding option is selected for **Display mode > Detailed photo info** (p 130). GPS data are only displayed if a GP-1 was used when the photo was taken.

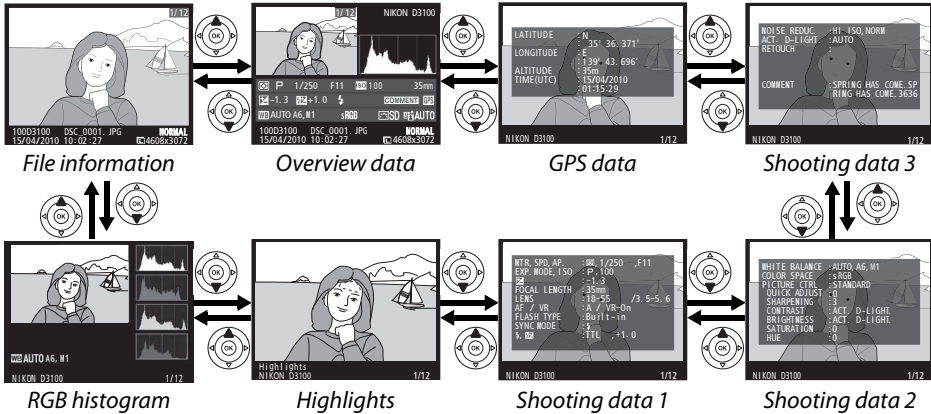

## File Information

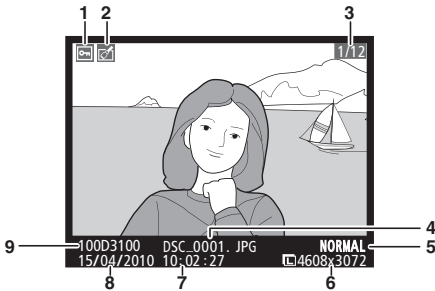

<b>1</b>	Protect status.....	108
<b>2</b>	Retouch indicator .....	152
<b>3</b>	Frame number/total number of images	
<b>4</b>	File name.....	65
<b>5</b>	Image quality .....	64
<b>6</b>	Image size.....	66
<b>7</b>	Time of recording.....	18
<b>8</b>	Date of recording.....	18
<b>9</b>	Folder name .....	149

## ■ ■ RGB Histogram \*

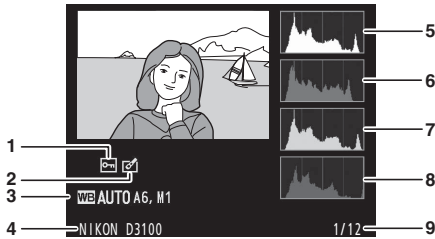

1	Protect status .....	108
2	Retouch indicator .....	152
3	White balance .....	87
	White balance fine-tuning .....	89
	Preset manual .....	90
4	Camera name	
5	Histogram (RGB channel). In all histograms, horizontal axis gives pixel brightness, vertical axis number of pixels.	
6	Histogram (red channel)	
7	Histogram (green channel)	
8	Histogram (blue channel)	
9	Frame number/total number of images	

\* Displayed only if **RGB histogram** is selected for **Display mode > Detailed photo info** (p 130).

### 🔍 Playback Zoom

To zoom in on the photograph when the histogram is displayed, press  $\mathcal{Q}$ . Use the  $\mathcal{Q}$  and  $\mathcal{Q}$  buttons to zoom in and out and scroll the image with the multi selector. The histogram will be updated to show only the data for the portion of the image visible in the monitor.



### 📊 Histograms

Camera histograms are intended as a guide only and may differ from those displayed in imaging applications. Some sample histograms are shown below:

If the image contains objects with a wide range of brightnesses, the distribution of tones will be relatively even.



If the image is dark, tone distribution will be shifted to the left.



If the image is bright, tone distribution will be shifted to the right.



Increasing exposure compensation shifts the distribution of tones to the right, while decreasing exposure compensation shifts the distribution to the left. Histograms can provide a rough idea of overall exposure when bright ambient lighting makes it difficult to see photographs in the monitor.



## ■ Highlights\*

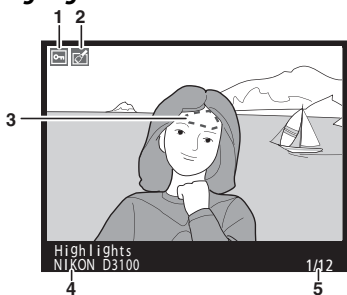

<b>1</b>	Protect status.....	108
<b>2</b>	Retouch indicator .....	152
<b>3</b>	Image highlights	
<b>4</b>	Camera name	
<b>5</b>	Frame number/total number of images	

\* Displayed only if **Highlights** is selected for **Display mode > Detailed photo info** (□ 130).  
Blinking areas indicate highlights.

## ■ Shooting Data Page 1<sup>1</sup>

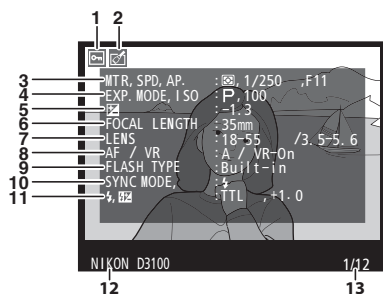

<b>4</b>	Shooting mode.....	23, 28, 73
	ISO sensitivity <sup>2</sup> .....	71
<b>5</b>	Exposure compensation.....	81
<b>6</b>	Focal length .....	171
<b>7</b>	Lens data	
<b>8</b>	Focus mode.....	38, 55
	Lens VR (vibration reduction) <sup>3</sup> .....	17
<b>9</b>	Flash type.....	135, 172
	Commander mode <sup>4</sup>	
<b>10</b>	Flash mode .....	68
<b>11</b>	Flash control .....	135
	Flash compensation.....	83
<b>12</b>	Camera name	
<b>13</b>	Frame number/total number of images	

<b>1</b>	Protect status .....	108
<b>2</b>	Retouch indicator .....	152
<b>3</b>	Metering .....	79
	Shutter speed.....	75, 77
	Aperture.....	76, 77

- 1 Displayed only if **Data** is selected for **Display mode > Detailed photo info** (□ 130).
- 2 Displayed in red if photo was taken with ISO sensitivity auto control on.
- 3 Displayed only if VR lens is attached.
- 4 Displayed only if photo was taken using optional flash unit with commander function.

## ■ Shooting Data Page 2<sup>1</sup>

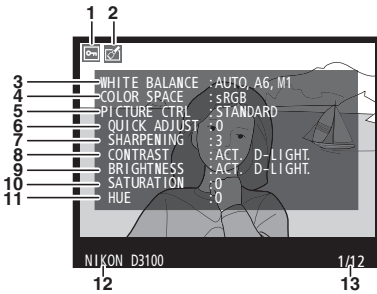

1	Protect status	108
2	Retouch indicator	152
3	White balance	87
	White balance fine-tuning	89
	Preset manual	90

4	Color space	133
5	Picture Control	94
6	Quick adjust <sup>2</sup>	96
	Original Picture Control <sup>3</sup>	94
7	Sharpening	96
8	Contrast	96
9	Brightness	
10	Saturation <sup>4</sup>	96
	Filter effects <sup>5</sup>	96
11	Hue <sup>4</sup>	96
	Toning <sup>5</sup>	96
12	Camera name	
13	Frame number/total number of images	

- 1 Displayed only if **Data** is selected for **Display mode > Detailed photo info** (📖 130).
- 2 **Standard**, **Vivid**, **Portrait**, and **Landscape** Picture Controls only.
- 3 **Neutral** and **Monochrome** Picture Controls.
- 4 Not displayed with monochrome Picture Controls.
- 5 Monochrome Picture Controls only.

## ■ Shooting Data Page 3<sup>1</sup>

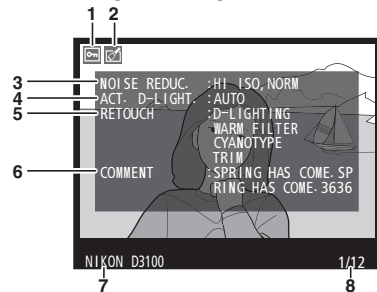

1	Protect status	108
2	Retouch indicator	152
3	Noise reduction	134
4	Active D-Lighting <sup>2</sup>	85
5	Retouch history	151
6	Image comment	140
7	Camera name	
8	Frame number/total number of images	

- 1 Displayed only if **Data** is selected for **Display mode > Detailed photo info** (📖 130).
- 2 **AUTO** is displayed if photo was taken with Active D-Lighting on.



## ■ GPS Data \*

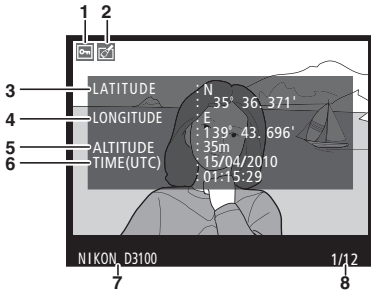

<b>1</b>	Protect status.....	108
<b>2</b>	Retouch indicator .....	152
<b>3</b>	Latitude	
<b>4</b>	Longitude	
<b>5</b>	Altitude	
<b>6</b>	Coordinated Universal Time (UTC)	
<b>7</b>	Camera name	
<b>8</b>	Frame number/total number of images	

\* Displayed only if GPS device was used when picture was recorded (☐ 98); data for movies are for start of recording.

## ■ Overview Data

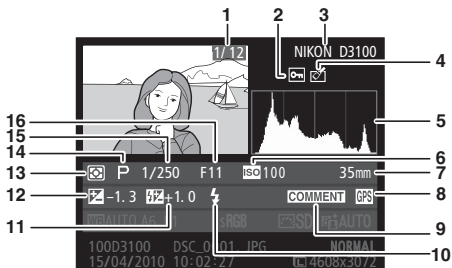

<b>1</b>	Frame number/total number of images	
<b>2</b>	Protect status .....	108
<b>3</b>	Camera name	
<b>4</b>	Retouch indicator .....	152

<b>5</b>	Histogram showing the distribution of tones in the image (☐ 101).	
<b>6</b>	ISO sensitivity <sup>1</sup> .....	71
<b>7</b>	Focal length .....	171
<b>8</b>	GPS data indicator .....	98
<b>9</b>	Image comment indicator .....	140
<b>10</b>	Flash mode .....	68
<b>11</b>	Flash compensation .....	83
	Commander mode <sup>2</sup>	
<b>12</b>	Exposure compensation .....	81
<b>13</b>	Metering .....	79
<b>14</b>	Shooting mode .....	23, 28, 73
<b>15</b>	Shutter speed .....	75, 77
<b>16</b>	Aperture .....	76, 77

1 Displayed in red if photo was taken with ISO sensitivity auto control on.

2 Displayed only if photo was taken using optional flash unit with commander function.

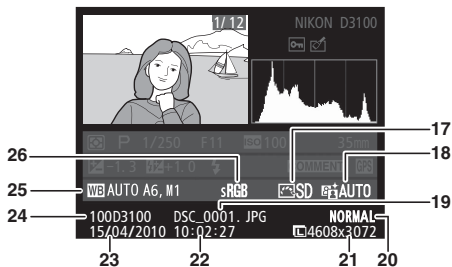

<b>17</b>	Picture Control .....	94
<b>18</b>	Active D-Lighting* .....	85

<b>19</b>	File name .....	65
<b>20</b>	Image quality .....	64
<b>21</b>	Image size .....	66
<b>22</b>	Time of recording .....	18
<b>23</b>	Date of recording .....	18
<b>24</b>	Folder name .....	149
<b>25</b>	White balance .....	87
	White balance fine-tuning .....	89
	Preset manual .....	90
<b>26</b>	Color space .....	133









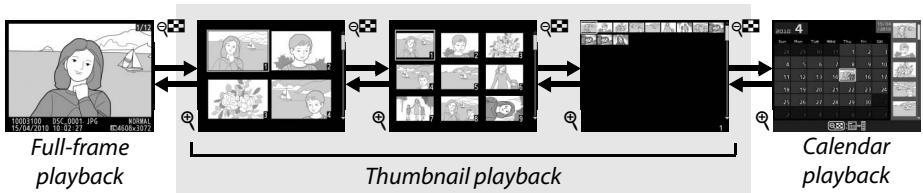





\* **AUTO** is displayed if photo was taken with Active D-Lighting on.



# Thumbnail Playback

To display images in “contact sheets” of four, nine, or 72 images, press the  button.





To	Use	Description
Display more images		Press  button to increase the number of images displayed.
Display fewer images		Press  button to reduce the number of images displayed. When four images are displayed, press to view highlighted image full frame.
Highlight images		Use multi selector or command dial to highlight images for full-frame playback, playback zoom (  107), deletion (  109), or protection (  108).
View highlighted image		Press  to display the highlighted image full frame.
Delete highlighted photo		See page 109 for more information.
Change protect status of highlighted photo	 (  / 	See page 108 for more information.
Return to shooting mode		Press shutter-release button halfway. Monitor will turn off; photographs can be taken immediately.
Display menus	<b>MENU</b>	See page 129 for more information.



# Calendar Playback

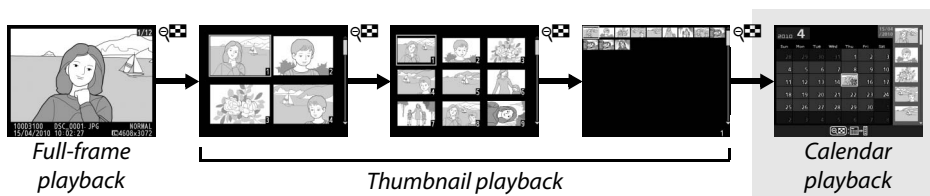





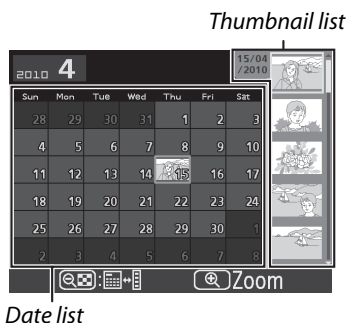



To view images taken on a selected date, press the  button when 72 images are displayed.



Press the  button to toggle between the date list and the list of thumbnails for the selected date. Use the multi selector to highlight dates in the date list or to highlight pictures in the thumbnail list.



















The operations can be performed depend on whether the cursor is in the date list or the thumbnail list:

To	Use	Description
Toggle between date list and thumbnail list		Press  button in date list to place cursor in thumbnail list. Press again to return to date list.
Exit to thumbnail playback/Zoom in on highlighted photo		<ul style="list-style-type: none"> <li>• <b>Date list:</b> Exit to 72-frame playback.</li> <li>• <b>Thumbnail list:</b> Press and hold  button to zoom in on highlighted picture.</li> </ul>
Highlight dates/Highlight images		<ul style="list-style-type: none"> <li>• <b>Date list:</b> Highlight date.</li> <li>• <b>Thumbnail list:</b> Highlight picture.</li> </ul>
Toggle full frame playback		<ul style="list-style-type: none"> <li>• <b>Date list:</b> View first picture taken on selected date.</li> <li>• <b>Thumbnail list:</b> View highlighted picture.</li> </ul>
Delete highlighted photo(s)		<ul style="list-style-type: none"> <li>• <b>Date list:</b> Delete all pictures taken on selected date.</li> <li>• <b>Thumbnail list:</b> Delete highlighted picture ( 109).</li> </ul>
Change protect status of highlighted photo		See page 108 for more information.
Return to shooting mode		Press shutter-release button halfway. Monitor will turn off; photographs can be taken immediately.
Display menus	<b>MENU</b>	See page 129 for more information.

# Taking a Closer Look: Playback Zoom

Press the  button to zoom in on the image displayed in full-frame playback or on the image currently highlighted in thumbnail or calendar playback. The following operations can be performed while zoom is in effect:

To	Use	Description	
Zoom in or out		Press  to zoom in to maximum of approximately 27× (large images), 20× (medium images) or 14× (small images). Press  to zoom out. While photo is zoomed in, use multi selector to view areas of image not visible in monitor. Keep multi selector pressed to scroll rapidly to other areas of frame. Navigation window is displayed when zoom ratio is altered; area currently visible in monitor is indicated by yellow border.	
View other areas of image		Faces (up to 35) detected during zoom are indicated by white borders in navigation window. Press  and  or  to zoom in or out; press  and  or  to view other faces.	
View other images		Rotate command dial to view same location in other images at current zoom ratio.	
Cancel zoom		Cancel zoom and return to full-frame playback.	
Change protect status		See page 108 for more information.	
Return to shooting mode		Press shutter-release button halfway. Monitor will turn off; photographs can be taken immediately.	
Display menus	<b>MENU</b>	See page 129 for more information.	



# Protecting Photographs from Deletion

In full-frame, zoom, thumbnail, and calendar playback, the **On** button can be used to protect photographs from accidental deletion. Protected files can not be deleted using the **W** button or the **Delete** option in the playback menu. Note that protected images *will* be deleted when the memory card is formatted (☐ 21).

To protect a photograph:

## 1 Select an image.

Display the image in full-frame playback or playback zoom or highlight it in the thumbnail list in thumbnail or calendar playback.



Full-frame playback

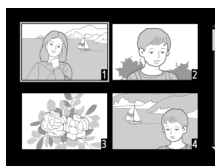

Thumbnail playback



Calendar playback

## 2 Press the **On** (AE-L/AF-L) button.

The photograph will be marked with a **On** icon. To remove protection from the photograph so that it can be deleted, display the photograph or highlight it in the thumbnail list and then press the **On** (AE-L/AF-L) button.

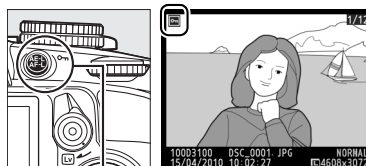

**On** (AE-L/AF-L) button

### **Removing Protection from All Images**

To remove protection from all images in the folder or folders currently selected in the **Playback folder** menu, press the **On** (AE-L/AF-L) and **W** buttons together for about two seconds during playback.

# Deleting Photographs

To delete the photograph displayed in full-frame playback or the photograph highlighted in the thumbnail list, press the  button. To delete multiple selected photographs, all photographs taken on a selected date, or all photographs in the current playback folder, use the **Delete** option in the playback menu. Once deleted, photographs can not be recovered.

## Full-Frame, Thumbnail, and Calendar Playback

Press the  button to delete the current photograph.

### 1 Select an image.

Display the image or highlight it in the thumbnail list in thumbnail or calendar playback.

### 2 Press the button.

A confirmation dialog will be displayed.

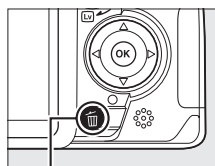

trash can button



Full-frame playback

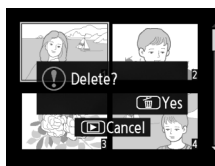



Thumbnail playback





Calendar playback  
(thumbnail list)

### 3 Press the button again.

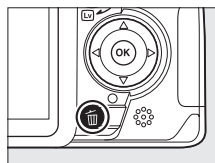
To delete the photograph, press the  button again. To exit without deleting the photograph, press the  button.





#### **Calendar Playback**

During calendar playback, you can delete all photographs taken on a selected date by highlighting the date in the date list and pressing the  button ( 106).

# The Playback Menu

The **Delete** option in the playback menu contains the following options. Note that depending on the number of images, some time may be required for deletion.

Option	Description
 <b>Selected</b>	Delete selected pictures.
 <b>Select date</b>	Delete all pictures taken on a selected date.
<b>ALL All</b>	Delete all pictures in the folder currently selected for playback (  129).

## ■ Selected: Deleting Selected Photographs

### 1 Select Delete.

To display the menus, press the **MENU** button. Highlight **Delete** in the playback menu and press **▶**.

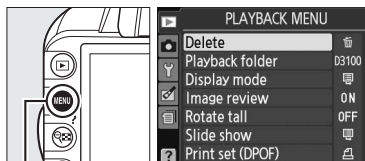

MENU button

### 2 Choose Selected.

Highlight **Selected** and press **▶**.

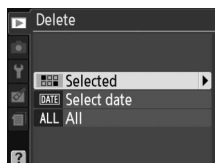

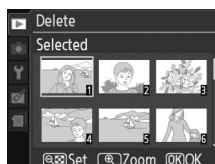

### 3 Highlight a picture.

Use the multi selector to highlight a picture (to view the highlighted picture full screen, press and hold the  button).



### 4 Select the highlighted picture.

Press the  button to select the highlighted picture. Selected pictures are marked by a  icon. Repeat steps 3 and 4 to select additional pictures; to deselect a picture, highlight it and press .



 button

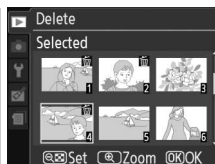

### 5 Press **OK** to complete the operation.

A confirmation dialog will be displayed; highlight **Yes** and press **OK**.

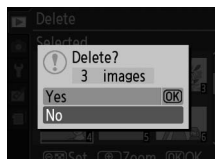

## ■ Select Date: Deleting Photographs Taken on a Selected Date

### 1 Choose Select Date.

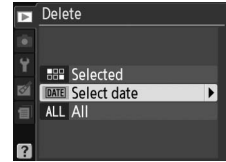

In the delete menu, highlight **Select date** and press ►.



### 2 Highlight a date.

Press ▲ or ▼ to highlight a date.



To view the pictures taken on the highlighted date, press . Use the multi-selector to scroll through the pictures, or press and hold  to view the current picture full screen. Press  to return to the date list.



 button

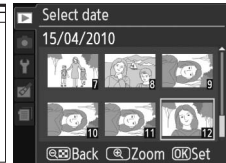

### 3 Select the highlighted date.

Press ► to select all pictures taken on the highlighted date. Selected dates are marked with a  icon. Repeat steps 2 and 3 to select additional dates; to deselect a date, highlight it and press ►.

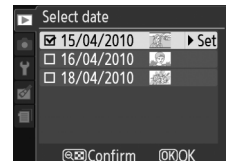

### 4 Press to complete the operation.

A confirmation dialog will be displayed; highlight **Yes** and press .



# Slide Shows

The **Slide show** option in the playback menu is used to display a slide show of the pictures in the current playback folder (📖 129).

## 1 Select Slide show.

To display the slide show menu, press the **MENU** button and select **Slide show** in the playback menu.

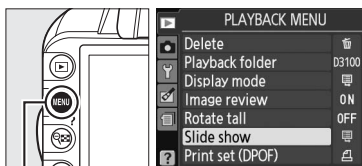

MENU button

## 2 Select Start.

To start the slide show, highlight **Start** in the slide show menu and press **OK**.

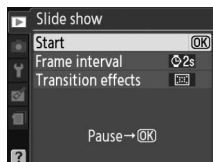

### Choosing a Frame Interval and Transition Effect

To choose how long each picture will be displayed, select **Frame interval** and choose from the options shown at right before selecting **Start** to start the slide show.

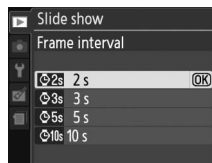





To choose the transition between frames, select **Transition effects** and choose from the following options:

- **Zoom/fade:** Frames fade into one another with a zoom effect.
- **Cube:** This transition takes the form of a rotating cube with the current picture on one face and the next picture on another.
- **None:** No transition between frames.



The following operations can be performed while the slide show is in progress:

To	Use	Description
Skip back/skip ahead		Press ◀ to return to previous frame, ▶ to skip to next frame.
View additional photo info		Change photo info displayed (□ 100).
Pause/resume slide show		Pause show. Press again to resume.
Exit to playback menu	<b>MENU</b>	See page 129 for more information.
Exit to playback mode		End show and return to playback mode.
Exit to shooting mode		Press shutter-release button halfway. Monitor will turn off; photographs can be taken immediately.

The dialog shown at right is displayed when the show ends. Select **Restart** to restart or **Exit** to return to the playback menu.





# Connections

## Connecting to a Computer

This section describes how to use a UC-E4 USB cable (available separately) to connect the camera to a computer.

### Before Connecting the Camera

Before connecting the camera, install the software on the supplied ViewNX 2 CD. To ensure that data transfer is not interrupted, be sure the camera EN-EL14 battery is fully charged. If in doubt, charge the battery before use or use an EH-5a AC adapter and EP-5A power connector (available separately).

#### ■ ■ *Supplied Software*

ViewNX 2 includes a “Nikon Transfer 2” function for copying pictures from the camera to the computer, where ViewNX 2 can be used to view and print selected images or to edit photographs and movies. For more information, see ViewNX 2 online help.

#### ■ ■ *Supported Operating Systems*

The supplied software can be used with computers running the following operating systems:

- **Windows:** Windows 7 (Home Basic/Home Premium/Professional/Enterprise/Ultimate), Windows Vista Service Pack 2 (Home Basic/Home Premium/Business/Enterprise/Ultimate) and Windows XP Service Pack 3 (Home Edition/Professional). ViewNX 2 runs as a 32-bit application in 64-bit editions of Windows 7 and Windows Vista.
- **Macintosh:** Mac OS X (version 10.4.11, 10.5.8, 10.6.4)

See the websites listed on page xiv for the latest information on supported operating systems.

#### **Connecting Cables**

Be sure the camera is off when connecting or disconnecting interface cables. Do not use force or attempt to insert the connectors at an angle. Close the connector cover when the connector is not in use.

#### **During Transfer**

Do not turn the camera off or disconnect the USB cable while transfer is in progress.

#### **Windows**

To visit the Nikon website after installing ViewNX 2, select **All Programs > Link to Nikon** from the Windows start menu (Internet connection required).

# Connecting the Camera

Connect the camera using a UC-E4 USB cable (available separately).

**1** Turn the camera off.

**2** Turn the computer on.

Turn the computer on and wait for it to start up.

**3** Connect the USB cable.

Connect the USB cable as shown. Do not use force or attempt to insert the connectors at an angle.

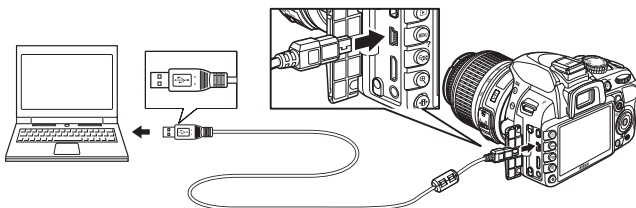

**USB Hubs**

Connect the camera directly to the computer; do not connect the cable via a USB hub or keyboard.

**4** Turn the camera on.

**5** Transfer photographs.

After following the on-screen instructions to start Nikon Transfer 2, click the **Start Transfer** button to transfer photographs (for more information on using Nikon Transfer 2, start ViewNX 2 or Nikon Transfer 2 and select **ViewNX 2 Help** from the **Help** menu).

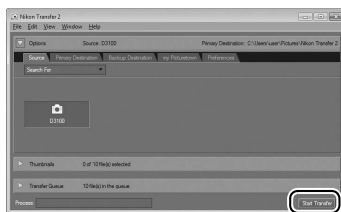

*Start Transfer button*

**6** Turn the camera off and disconnect the USB cable when transfer ends.

Nikon Transfer 2 will close automatically when transfer is complete.

**Third-Party USB Cables**

When using a third-party USB cable to connect the camera to a computer, use a cable about 1.5 m (5 ft.) long with a mini type B connector and attach the smaller of the supplied ferrite cores (the core for USB cables) to the USB cable as shown.

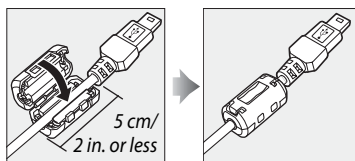

# Printing Photographs

To print selected JPEG pictures on a PictBridge printer via a direct USB connection, follow the steps below.

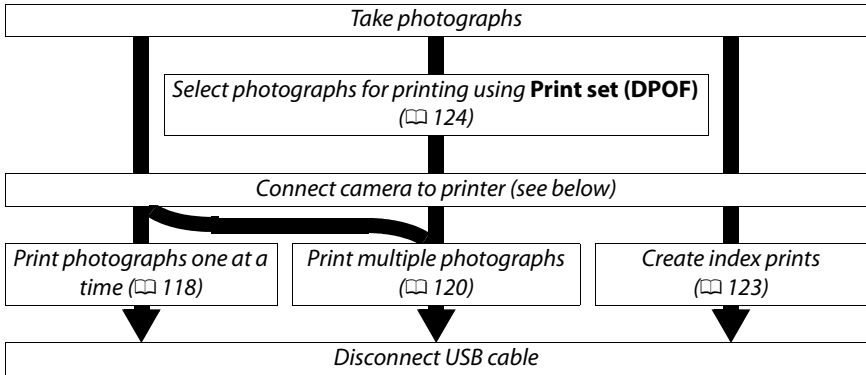

## Printing Via Direct USB Connection

Be sure the EN-EL14 battery is fully charged or use an optional EH-5a AC adapter and EP-5A power connector. When taking photographs to be printed via direct USB connection, set **Color space** to **sRGB** (☐ 133).

## Connecting the Printer

Connect the camera using a UC-E4 USB cable (available separately).

**1** Turn the camera off.

**2** Connect the USB cable.

Turn the printer on and connect the USB cable as shown. Do not use force or attempt to insert the connectors at an angle.

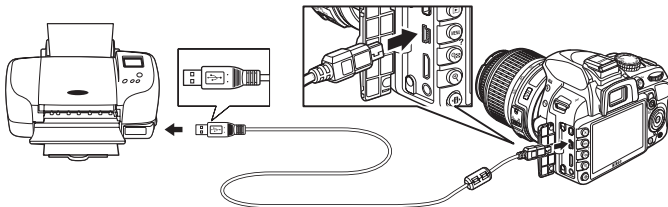

### ✓ USB Hubs

Connect the camera directly to the printer; do not connect the cable via a USB hub.

### 🔧 Third-Party USB Cables

When using a third-party USB cable to connect the camera to a printer, use a cable about 1.5 m (5 ft.) long with a mini type B connector and attach the smaller of the supplied ferrite cores (the core for USB cables) to the USB cable as shown.

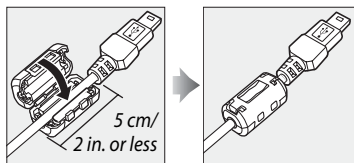

## 3 Turn the camera on.

A welcome screen will be displayed in the monitor, followed by a PictBridge playback display.

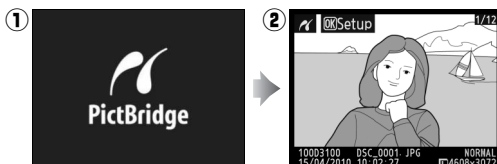

## Printing Pictures One at a Time

### 1 Select a picture.

Press ◀ or ▶ to view additional pictures, or press ▲ or ▼ to view photo information (📄 100). Press the 🔍 button to zoom in on the current frame (📄 107; press ▶ to exit zoom). To view six pictures at a time, press the 📄 button. Use the multi selector to highlight pictures, or press 🔍 to display the highlighted picture full frame.



### 2 Display printing options.

Press Ⓞ to display PictBridge printing options.

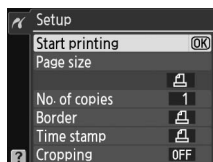

### 3 Adjust printing options.

Press ▲ or ▼ to highlight an option and press ► to select.

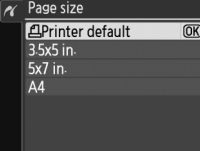
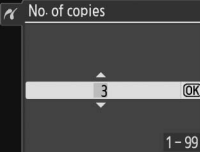
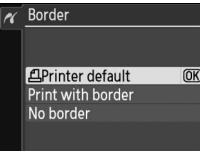
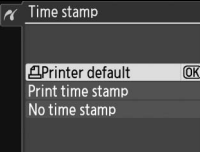
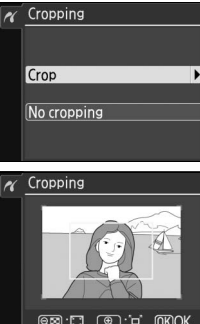
Option	Description	
<b>Page size</b>	Menu of page sizes will be displayed (options not supported by current printer are not listed). Press ▲ or ▼ to choose page size (to print at default page size for current printer, select <b>Printer default</b> ), then press OK to select and return to previous menu.	
<b>No. of copies</b>	Menu shown at right will be displayed. Press ▲ or ▼ to choose number of copies (maximum 99), then press OK to select and return to previous menu.	
<b>Border</b>	This option is available only if supported by current printer. Menu shown at right will be displayed. Press ▲ or ▼ to choose print style from <b>Printer default</b> (print using current printer settings), <b>Print with border</b> (print photo with white border), or <b>No border</b> , then press OK to select and return to previous menu. Only options supported by current printer will be displayed.	
<b>Time stamp</b>	Menu shown at right will be displayed. Press ▲ or ▼ to choose <b>Printer default</b> (print using current printer settings), <b>Print time stamp</b> (print time and date of recording on photo), or <b>No time stamp</b> , then press OK to select and return to previous menu.	
<b>Cropping</b>	<p>This option is available only with printers that support cropping. Menu shown at right will be displayed. To exit without cropping picture, highlight <b>No cropping</b> and press OK. To crop picture, highlight <b>Crop</b> and press ►.</p> <p>If <b>Crop</b> is selected, dialog shown at right will be displayed. Press ↻ to increase size of crop, ↻ to decrease. Choose position of crop using multi selector and press OK. Note that print quality may drop if small crops are printed at large sizes.</p>	



## 4 Start printing.

Select **Start printing** and press **OK** to start printing. To cancel before all copies have been printed, press **OK**.

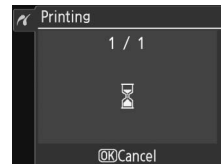

### **Date Imprint**

If you select **Print time stamp** in the PictBridge menu when printing photographs containing date information recorded using **Date imprint** in the setup menu (147), the date will appear twice. The imprinted date may however be cropped out if the photographs are cropped or printed without a border.

## Printing Multiple Pictures

### 1 Display the PictBridge menu.

Press the **MENU** button in the PictBridge playback display (see Step 3 on page 118).

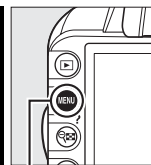
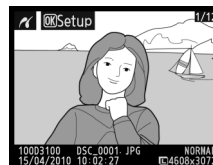

*MENU button*

### 2 Choose an option.

Highlight one of the following options and press **▶**.

- **Print select:** Select pictures for printing.
- **Select date:** Print one copy of all the pictures taken on a selected date.
- **Print (DPOF):** Print an existing print order created with the **Print set (DPOF)** option in the playback menu (124). The current print order will be displayed in Step 3.

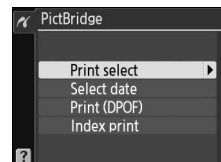









To create an index print of all JPEG pictures on the memory card, select **Index print**. See page 123 for more information.











### 3 Select pictures or choose a date.

#### If you chose **Print select** or **Print (DPOF)** in



**Step 2**, use the multi selector to scroll through the pictures on the memory card. To display the current picture full screen, press and hold the  button. To select the current picture for printing, press the  button and press . The picture will be marked with a  icon and the number of prints will be set to 1. Keeping the  button pressed, press  or  to specify the number of prints (up to 99; to deselect the picture, press  when the number of prints is 1). Continue until all the desired pictures have been selected.

#### **Selecting Photographs for Printing**

NEF (RAW) photographs ( 64) can not be selected for printing. JPEG copies of NEF (RAW) images can be created using the **NEF (RAW) processing** option in the retouch menu ( 160).

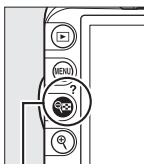
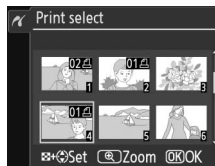
If you chose **Select date** in **Step 2**, press  or  to highlight a date and press  to toggle the highlighted date on or off. To view the pictures taken on the selected date, press . Use the multi selector to scroll through the pictures, or press and hold  to view the current picture full screen. Press  again to return to the date selection dialog.



 +  / : Choose number of copies

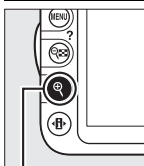

 button: View photo full screen



 button: View photos for selected date

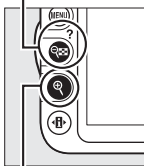

 button: View highlighted photo full screen

## 4 Display printing options.

Press **OK** to display PictBridge printing options.

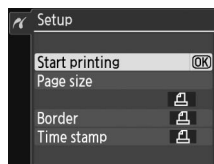

## 5 Adjust printing options.

Press **▲** or **▼** to highlight an option and press **▶** to select.

Option	Description
<b>Page size</b>	Menu of page sizes will be displayed (□ 119; options not supported by current printer are not listed). Press <b>▲</b> or <b>▼</b> to choose page size (to print at default page size for current printer, select <b>Printer default</b> ), then press <b>OK</b> to select and return to previous menu.
<b>Border</b>	Menu of border options will be displayed (□ 119; options not supported by current printer are not listed). Press <b>▲</b> or <b>▼</b> to choose print style from <b>Printer default</b> (print at current printer settings), <b>Print with border</b> (print photo with white border), or <b>No border</b> , then press <b>OK</b> to select and return to previous menu.
<b>Time stamp</b>	Menu of time stamp options will be displayed (□ 119). Press <b>▲</b> or <b>▼</b> to choose <b>Printer default</b> (print at current printer settings), <b>Print time stamp</b> (print time and date of recording on photo), or <b>No time stamp</b> , then press <b>OK</b> to select and return to previous menu.

## 6 Start printing.

Select **Start printing** and press **OK** to start printing. To cancel before all copies have been printed, press **OK**.



### Errors

See page 192 for information on what to do if an error occurs during printing.

# Creating Index Prints

To create an index print of all JPEG pictures on the memory card, select **Index print** in Step 2 of “Printing Multiple Pictures” (□ 120). Note that if the memory card contains more than 256 pictures, only the first 256 images will be printed.

## 1 Select Index print.

Selecting **Index print** in the PictBridge menu (□ 120) displays the images on the memory card as shown at right.

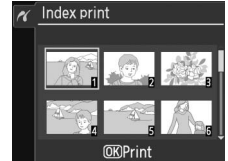

## 2 Display printing options.

Press **OK** to display PictBridge printing options.

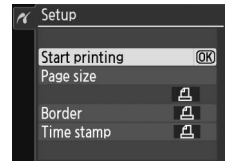

## 3 Adjust printing options.

Choose page size, border, and time stamp options as described on page 122 (a warning will be displayed if the selected page size is too small).

## 4 Start printing.

Select **Start printing** and press **OK** to start printing. To cancel before all copies have been printed, press **OK**.



# Creating a DPOF Print Order: Print Set

The **Print set (DPOF)** option in the playback menu is used to create digital “print orders” for PictBridge-compatible printers and devices that support DPOF.

## 1 Choose **Select/set** for the **Print set (DPOF)** item in the playback menu.

Press the **MENU** button and select **Print set (DPOF)** in the playback menu. Highlight **Select/set** and press **▶** (to remove all photographs from the print order, select **Deselect all?**).

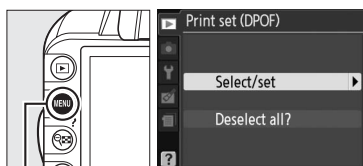

MENU button

## 2 Select pictures.

Use the multi selector to scroll through the pictures on the memory card. To display the current picture in full screen, press and hold the **Q** button. To select the current picture for printing, press the **Q** button and press **▲**. The picture will be marked with a **📄** icon and the number of prints will be set to 1. Keeping the **Q** button pressed, press **▲** or **▼** to specify the number of prints (up to 99; to deselect the picture, press **▼** when the number of prints is 1). Continue until all the desired pictures have been selected.

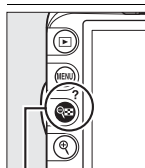
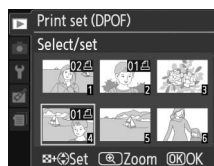

**Q** + **▲** / **▼**: Choose number of copies



**Q** button: View photo full screen

## 3 Display imprint options.

Press **OK** to display data imprint options.

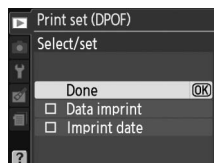

## 4 Select imprint options.

Highlight the following options and press ► to toggle the highlighted option on or off (to complete the print order without including this information, proceed to Step 5).

- **Data imprint:** Print shutter speed and aperture on all pictures in print order.
- **Imprint date:** Print date of recording on all pictures in print order.

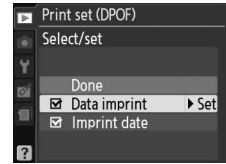

## 5 Complete the print order.

Highlight **Done** and press **OK** to complete the print order.

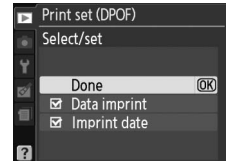

### ✓ Print Set (DPOF)

To print the current print order when the camera is connected to a PictBridge printer, select **Print (DPOF)** in the PictBridge menu and follow the steps in “Printing Multiple Pictures” to modify and print the current order (□ 120). DPOF date and data imprint options are not supported when printing via direct USB connection; to print the date of recording on photographs in the current print order, use the PictBridge **Time stamp** option.

The **Print set (DPOF)** option can not be used if there is not enough space on the memory card to store the print order.

NEF (RAW) photographs (□ 64) can not be selected using this option. JPEG copies of NEF (RAW) images can be created using the **NEF (RAW) processing** option in the retouch menu (□ 160).

Print orders may not print correctly if images are deleted using a computer or other device after the print order is created.



# Viewing Photographs on TV

An EG-D2 audio video (A/V) cable (available separately) can be used to connect the camera to a television or video recorder for playback or recording. A type C mini-pin High-Definition Multimedia Interface (HDMI) cable (available separately from third-party suppliers) can be used to connect the camera to high-definition video devices.

## Standard Definition Devices

Before connecting the camera to a standard television, confirm that the camera video standard (📖 139) matches that used in the TV.

### 1 Turn the camera off.

Always turn the camera off before connecting or disconnecting the A/V cable.

### 2 Connect the A/V cable as shown.

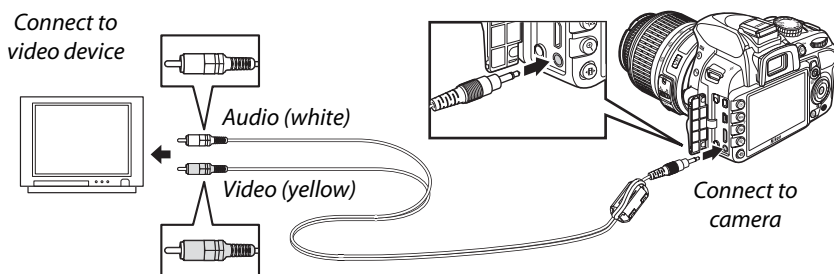

### 3 Tune the television to the video channel.

### 4 Turn the camera on and press the button.

During playback, images will be displayed both in the camera monitor and on the television screen. Note that the edges of images may not be displayed.

#### **Video Mode**

If no image is displayed, check that camera is correctly connected and that the option selected for **Video mode** (📖 139) matches the video standard used in the TV.

#### **Television Playback**

Use of an EH-5a AC adapter and EP-5A power connector (available separately) is recommended for extended playback.

### **Third-Party A/V Cables**

When using a third-party A/V cable to connect the camera to a television, use a cable about 1 m (3 ft.) long with two RCA jacks and attach the larger of the supplied ferrite cores (the core for A/V cables) to the A/V cable as shown. Make a loop in the cable 10 cm (3.9 in.) from the end that connects to the camera (①) and attach the ferrite core (②).

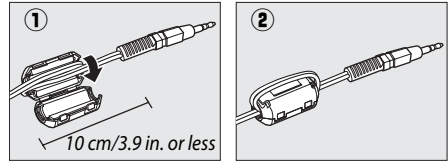

## **High-Definition Devices**

The camera can be connected to HDMI devices using a type C mini-pin HDMI cable (available separately from third-party suppliers).

### **1 Turn the camera off.**

Always turn the camera off before connecting or disconnecting an HDMI cable.

### **2 Connect the HDMI cable as shown.**

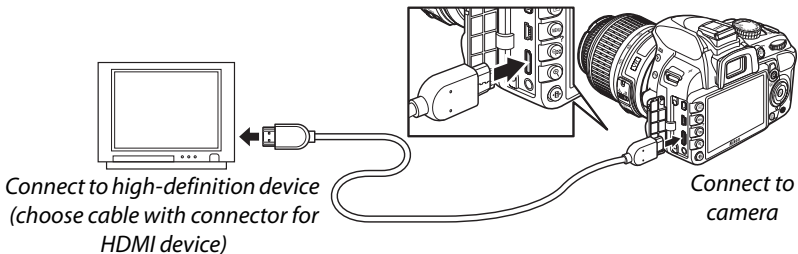

### **3 Tune the device to the HDMI channel.**

### **4 Turn the camera on and press the button.**

During playback, images will be displayed on the high-definition television or monitor screen; the camera monitor will remain off.

### **Close the Connector Cover**

Close the connector cover when the connectors are not in use. Foreign matter in the connectors can interfere with data transfer.



## ■ ■ HDMI Options

The **HDMI** option in the setup menu controls output resolution and can be used to enable the camera for remote control from devices that support HDMI-CEC (**H**igh-**D**efinition **M**ultimedia **I**nterface–**C**onsumer **E**lectronics **C**ontrol, a standard that allows HDMI devices to be used to control peripherals to which they are connected).

### **Output Resolution**

Choose the format for images output to the HDMI device. If **Auto** is selected, the camera will automatically select the appropriate format.

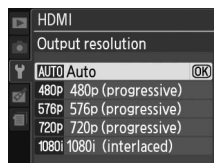

### **Device Control**

If **On** is selected for **HDMI > Device control** in the setup menu when the camera is connected to a television that supports HDMI-CEC and both the camera and television are on, the display shown at right will appear on the television and the television remote can be used in place of the camera multi selector and  button during full-frame playback and slide shows. If **Off** is selected, the television remote can not be used to control the camera.



#### **HDMI-CEC Devices**

When the camera is connected to an HDMI-CEC device,  will appear in the viewfinder in place of the number of exposures remaining.

#### **Device Control**

See the television manual for details.



# Menu Guide

## ▶ The Playback Menu: *Managing Images*

To display the playback menu, press **MENU** and select the ▶ (playback menu) tab.

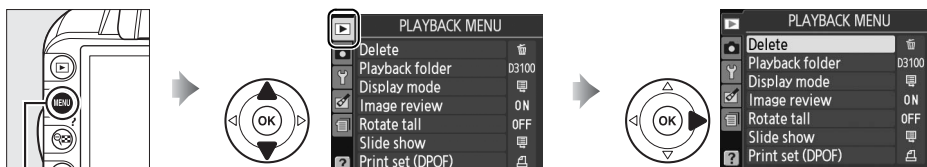

MENU button

The playback menu contains the following options:

Option	Default	📖	Option	Default	📖
<b>Delete</b>	—	110	<b>Rotate tall</b>	Off	130
<b>Playback folder</b>	Current	129	<b>Slide show</b>	—	112
<b>Display mode</b>	—	130	<b>Frame interval</b>	2 s	
<b>Detailed photo info</b>	—		<b>Transition effects</b>	Zoom/ fade	
<b>Transition effects</b>	Slide in	130	<b>Print set (DPOF)</b>	—	124
<b>Image review</b>	On				

### Playback Folder

MENU button → ▶ playback menu

Choose a folder for playback:

Option	Description
<b>Current</b>	Only photos in the folder currently selected for <b>Storage folder</b> in the setup menu (📖 149) are displayed during playback. This option is selected automatically when a photo is taken. If a memory card is inserted and this option selected before photos have been taken, a message stating that the folder contains no images will be displayed during playback. Select <b>All</b> to begin playback.
<b>All</b>	Pictures in all folders will be visible during playback.

## Display Mode

MENU button →  playback menu

Choose the information available in the playback photo information display ( 100) and the transition between frames during playback.

- **Detailed photo info:** Press ▲ or ▼ to highlight an option, then press ► to select the option for the photo information display. A  appears next to selected items; to deselect, highlight and press ►. To return to the playback menu, highlight **Done** and press .
- **Transition effects:** Choose from **Slide in** (each frame is pushed out of the display by the following frame), **Zoom/fade** (frames fade into one another with a zoom effect), and **None** (no transition between frames).

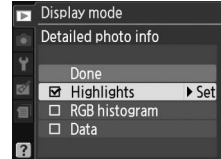

## Image Review

MENU button →  playback menu

Choose whether pictures are automatically displayed in the monitor immediately after shooting. If **Off** is selected, pictures can only be displayed by pressing the  button.

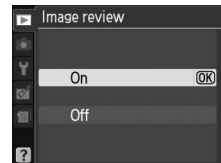

## Rotate Tall

MENU button →  playback menu

Choose whether to rotate “tall” (portrait-orientation) pictures for display during playback. Note that because the camera itself is already in the appropriate orientation during shooting, images are not rotated automatically during image review.

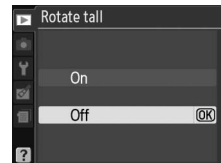

Option	Description
<b>On</b>	“Tall” (portrait-orientation) pictures are automatically rotated for display in the camera monitor. Pictures taken with <b>Off</b> selected for <b>Auto image rotation</b> (  141) will be displayed in “wide” (landscape) orientation.
<b>Off</b>	“Tall” (portrait-orientation) pictures are displayed in “wide” (landscape) orientation.

# 📷 The Shooting Menu: *Shooting Options*

To display the shooting menu, press **MENU** and select the **📷** (shooting menu) tab.

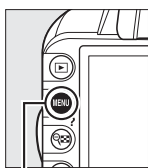

MENU button

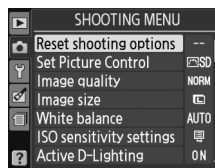

The shooting menu contains the following options:

Option	Default	📖
Reset shooting options	—	131
Set Picture Control	Standard	94
Image quality	JPEG normal	64
Image size	Large	66
White balance	Auto	87
Fluorescent	Cool-white fl.	88
<b>ISO sensitivity settings</b>		
ISO sensitivity	P, S, A, M	100
	Other modes	Auto
		71
Auto ISO sensitivity	Off	132
Active D-Lighting	On	85
Auto distortion control	Off	133
Color space	sRGB	133
Noise reduction	On	134

Option	Default	📖
<b>AF-area mode</b>		
Viewfinder	📷	Single-point AF
	📷	Dynamic-area AF
	Other modes	Auto-area AF
Live view/movie	📷, 📷, 📷, 📷	Face-priority AF
	📷, P, S, A, M	Wide-area AF
	📷	Normal-area AF
AF-assist	On	134
Metering	Matrix	79
<b>Movie settings</b>		
Quality	1920×1080; 24 fps	47
Sound	On	
Built-in flash	TTL	135

## Reset Shooting Options

MENU button → 📷 shooting menu

Select **Yes** to reset shooting menu settings.

### 🔧 Reset Shooting Options

Selecting **Yes** for **Reset shooting options** also restores Picture Control settings to their default values (📖 95) and resets the following:

Option	Default	📖
Focus point*	Center	60
Flexible program	Off	74
AE-L/AF-L button hold	Off	146
<b>Focus mode</b>		
Viewfinder	Auto-servo AF	55
Live view/movie	Single-servo AF	38

\* Not displayed if [📷] (Auto-area AF) is selected for **AF-area mode > Viewfinder**.

Option	Default	📖
<b>Flash mode</b>		
AUTO, 📷, 📷, 📷	Auto front-curtain sync	68
📷	Auto slow sync	
P, S, A, M	Front curtain sync	
Exposure compensation	Off	81
Flash compensation	Off	83



Adjust ISO sensitivity (☐ 71).



## ■ Auto ISO Sensitivity

If **Off** is chosen for **Auto ISO sensitivity** in **P**, **S**, **A**, and **M** modes, ISO sensitivity will remain fixed at the value selected by the user (☐ 71). When **On** is chosen, ISO sensitivity will automatically be adjusted if optimal exposure can not be achieved at the value selected by the user (ISO sensitivity is adjusted appropriately when the flash is used). The maximum value for auto ISO sensitivity can be selected using the **Max. sensitivity** option in the **Auto ISO sensitivity** menu (choose lower values to prevent noise (randomly-spaced bright pixels, fog, or lines); the minimum value for auto ISO sensitivity is automatically set to ISO 100). In modes **P** and **A**, sensitivity will only be adjusted if underexposure would result at the shutter speed selected for **Min. shutter spd** ( $1/2000-1$  s; in modes **S** and **M**, sensitivity will be adjusted for optimal exposure at the shutter speed selected by the user). Slower shutter speeds will be used only if optimum exposure can not be achieved at the ISO sensitivity value selected for **Max. sensitivity**. If the ISO sensitivity selected by the user is higher than the value selected for **Max. sensitivity**, the value selected for **Max. sensitivity** will be used instead.

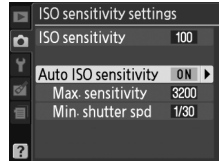

When **On** is selected, the viewfinder shows **ISO-AUTO** and the information display **ISO-A**. These indicators blink when sensitivity is altered from the value selected by the user.

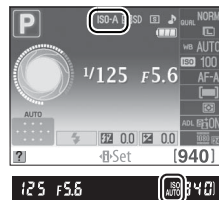

### Auto ISO Sensitivity Control

Noise (randomly-spaced bright pixels, fog, or lines) is more likely at higher sensitivities. Use the **Noise reduction** option in the shooting menu to reduce noise (☐ 134). Note that ISO sensitivity may be raised automatically when auto ISO sensitivity control is used in combination with slow sync flash modes (available with the built-in flash and SB-900, SB-800, SB-600, and SB-400 flash units), possibly preventing the camera from selecting slow shutter speeds.

## Auto Distortion Control

MENU button →  shooting menu

Select **On** to reduce barrel distortion when shooting with wide-angle lenses and to reduce pin-cushion distortion when shooting with long lenses (note that the edges of the area visible in the viewfinder may be cropped out of the final photograph, and that the time needed to process photographs before recording begins may increase). This option is available only with type G and D lenses (PC, fisheye, and certain other lenses excluded); results are not guaranteed with other lenses.

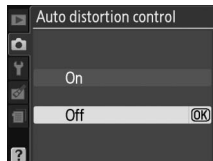

### **Retouch: Distortion Control**

For information creating copies of existing photographs with reduced barrel and pin-cushion distortion, see page 161.

## Color Space

MENU button →  shooting menu

The color space determines the gamut of colors available for color reproduction. Choose **sRGB** for photographs that will be printed or used “as is,” with no further modification. **Adobe RGB** has a wider color gamut and is recommended for images that will be extensively processed or retouched after leaving the camera.



### **Color Space**

Color spaces define the correspondence between colors and the numeric values that represent them in a digital image file. The sRGB color space is widely used, while the Adobe RGB color space is typically used in publishing and commercial printing. sRGB is recommended when taking photographs that will be printed without modification or viewed in applications that do not support color management, or when taking photographs that will be printed with ExifPrint, the direct printing option on some household printers, or kiosk printing or other commercial print services. Adobe RGB photographs can also be printed using these options, but colors will not be as vivid.

JPEG photographs taken in the Adobe RGB color space are DCF compliant; applications and printers that support DCF will select the correct color space automatically. If the application or device does not support DCF, select the appropriate color space manually. For more information, see the documentation provided with the application or device.

### **Nikon Software**

ViewNX 2 (supplied) and Capture NX 2 (available separately) automatically select the correct color space when opening photographs created with this camera.



## Noise Reduction

MENU button →  shooting menu



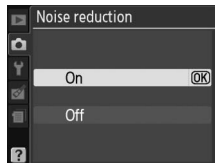

Select **On** to reduce noise (randomly-spaced bright pixels, lines, or fog), particularly in photographs taken at high ISO sensitivities or shutter speeds slower than 8 s. The time required for processing is roughly equal to the current shutter speed; during processing, “**Job nr**” will blink in the viewfinder and photographs can not be taken. Noise reduction will not be performed if the camera is turned off before processing is complete.



If **Off** is selected, noise reduction will only be performed at high ISO sensitivities; the amount of noise reduction is less than that performed when **On** is selected.

## AF-Assist

MENU button →  shooting menu

If **On** is selected and lighting is poor when photographs are framed in the viewfinder, the built-in AF-assist illuminator (□ 57) will light to assist the focus operation in single-servo AF (**AF-S** selected for focus mode, or single-servo AF selected in **AF-A** focus mode) when  **Auto-area AF** is selected for **AF-area mode > Viewfinder** or when  **Single-point AF**,  **Dynamic-area AF**, or  **3D-tracking (11 points)** is selected and the center focus point is used. If **Off** is selected, the AF-assist illuminator will not light to assist the focus operation. The camera may not be able to focus using autofocus when lighting is poor.

AF-assist illuminator

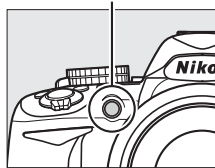

### See Also

See page 171 for restrictions on the lenses that can be used with AF assist. See page 186 for the shooting modes in which the AF-assist illuminator can be used.



Choose the flash mode for the built-in flash in **P**, **S**, **A**, and **M** modes.

Option	Description
<b>TTL</b>	Flash output is adjusted automatically in response to shooting conditions.
<b>Manual</b>	Choose a flash level between <b>Full</b> and <b>1/32</b> (1/32 of full power). At full power, the built-in flash has a Guide Number of 13/43 (m/ft., ISO 100, 20 °C/68 °F).

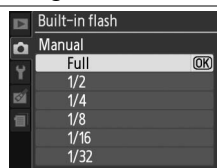

## Manual

A icon blinks in the viewfinder and information display when **Manual** is selected and the flash is raised.

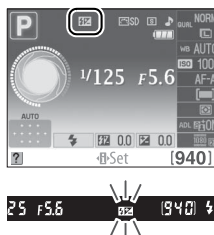

## The SB-400

When an optional SB-400 flash unit is attached and turned on, **Built-in flash** changes to **Optional flash**, allowing the flash control mode for the SB-400 to be selected from **TTL** and **Manual**.

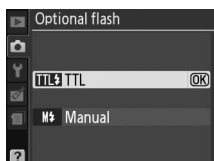

## Flash Control

The following types of flash control are supported when a CPU lens is used in combination with the built-in flash or optional SB-900, SB-800, SB-600, and SB-400 flash units (📖 67, 172).

- **i-TTL Balanced Fill-Flash for Digital SLR:** Information from the 420-pixel RGB sensor is used to adjust flash output for a natural balance between the main subject and the background.
- **Standard i-TTL Fill-Flash for Digital SLR:** Flash output is adjusted for the main subject; the brightness of the background is not taken into account. Recommended for shots in which the main subject is emphasized at the expense of background details, or when exposure compensation is used.

Standard i-TTL flash control is used with spot metering or when selected with the optional flash unit. i-TTL balanced fill-flash for digital SLR is used in all other cases.



# Y The Setup Menu: *Camera Setup*

To display the setup menu, press **MENU** and select the **Y** (setup menu) tab.

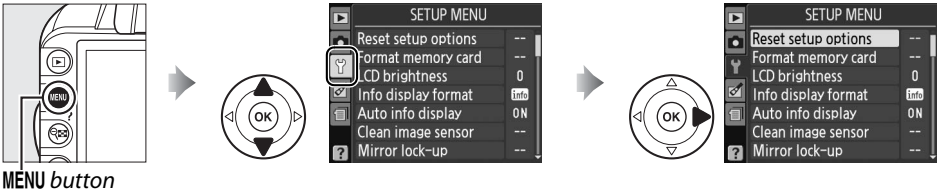

MENU button

The setup menu contains the following options:

Option	Default	
Reset setup options	—	136
Format memory card	—	21
LCD brightness	0	137
Info display format	Graphic; Background color: Green	137
Auto info display	On	139
Clean image sensor		
Clean at	Startup & shutdown	180
Mirror lock-up <sup>1</sup>	—	182
Video mode <sup>2</sup>	—	139
HDMI		
Output resolution	Auto	128
Device control	On	128
Flicker reduction <sup>2</sup>	—	139
Time zone and date <sup>2</sup>		
Daylight saving time	Off	139
Language <sup>2</sup>	—	140
Image comment	—	140

Option	Default	
Auto image rotation	On	141
Dust Off ref photo	—	141
Auto off timers	Normal	143
Self-timer delay	10 s	143
Beep	On	144
Rangefinder	Off	144
File number sequence	Off	145
Buttons		
Fn button	ISO sensitivity	146
AE-L/AF-L button	AE/AF lock	146
AE lock	Off	146
Slot empty release lock	Release locked	147
Date imprint	Off	147
Storage folder	—	149
GPS		
Auto meter-off	Enable	98
Eye-Fi upload <sup>3</sup>	Enable	150
Firmware version	—	150

1 Not available when battery is low.

2 Default varies with country of purchase.

3 Only available when compatible Eye-Fi memory card is inserted (150).

## Reset Setup Options

MENU button → Y setup menu

Select **Yes** to reset setup menu all settings except **Video mode**, **Flicker reduction**, **Time zone and date**, **Language**, and **Storage folder** to the defaults listed above.



## LCD Brightness

MENU button → Y setup menu

Press ▲ or ▼ to choose monitor brightness. Choose higher values for increased brightness, lower values for reduced brightness.

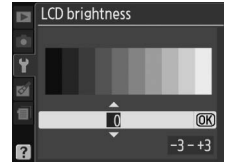

## Info Display Format

MENU button → Y setup menu

Choose from the following two formats for the information display (📖 6).



Classic (📖 138)



Graphic (📖 6)

### 1 Select a format.

Highlight an option and press ►.

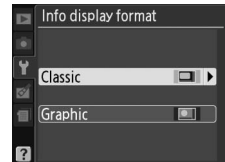

### 2 Select a background color.

Highlight a background color and press Ⓞ.

Choose from blue, black, or orange (Classic) or green, black, or brown (Graphic).



The “Classic” display is shown below.

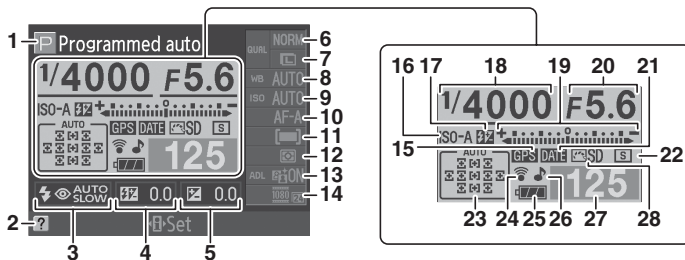

<p><b>1</b> Shooting mode              AUTO auto/              Ⓜ auto (flash off) ..... 23              Scene modes ..... 28              <b>P, S, A, and M</b> modes ..... 73</p> <p><b>2</b> Help icon ..... 192</p> <p><b>3</b> Flash mode ..... 68</p> <p><b>4</b> Flash compensation ..... 83</p> <p><b>5</b> Exposure compensation ..... 81</p> <p><b>6</b> Image quality ..... 64</p> <p><b>7</b> Image size ..... 66</p> <p><b>8</b> White balance ..... 87</p> <p><b>9</b> ISO sensitivity ..... 71</p> <p><b>10</b> Focus mode ..... 38, 55</p> <p><b>11</b> AF-area mode ..... 38, 58</p>	<p><b>12</b> Metering ..... 79</p> <p><b>13</b> Active D-Lighting ..... 85</p> <p><b>14</b> Movie frame size ..... 47</p> <p><b>15</b> GPS connection              indicator ..... 98</p> <p><b>16</b> Auto ISO sensitivity              indicator ..... 132</p> <p><b>17</b> Manual flash indicator ..... 135              Flash compensation indicator              for optional flash units ..... 175</p> <p><b>18</b> Shutter speed ..... 75, 77</p> <p><b>19</b> Exposure indicator ..... 77              Exposure compensation              indicator ..... 82              Electronic rangefinder ..... 144</p>	<p><b>20</b> Aperture (f-number) ..... 76, 77</p> <p><b>21</b> Date imprint indicator ..... 147</p> <p><b>22</b> Release mode ..... 5, 53</p> <p><b>23</b> Auto-area AF indicator ..... 58              3D-tracking indicator ..... 58              Focus point ..... 60</p> <p><b>24</b> Eye-Fi connection              indicator ..... 150</p> <p><b>25</b> Battery indicator ..... 23</p> <p><b>26</b> “Beep” indicator ..... 144</p> <p><b>27</b> Number of exposures              remaining ..... 24</p> <p><b>28</b> Picture Control ..... 94</p>
--	--	---

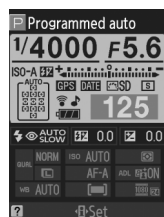

**✎ Rotating the Camera**

When the camera is rotated 90°, shooting information rotates to match camera orientation.



## Auto Info Display

MENU button →  setup menu

If **On** is selected, the information display will appear after the shutter-release button is pressed halfway; if image review ( 130) is off, it will also be displayed immediately after shooting. Choose **On** if you find yourself frequently referring to the information display during shooting. If **Off** is selected, the information display can be viewed by pressing the  button.

## Video Mode

MENU button →  setup menu

When connecting the camera to a television or VCR, be sure the camera video mode matches the device video standard (NTSC or PAL).

## Flicker Reduction

MENU button →  setup menu

Reduce flicker and banding when shooting under fluorescent or mercury-vapor lighting during live view or movie recording. Choose a frequency which matches that of the local AC power supply.

### Flicker Reduction

If you are unsure as to the frequency of the local power supply, test both options and choose the one that produces the best results. Flicker reduction may not produce the desired results if the subject is very bright, in which case you should select mode **A** or **M** and choose a smaller aperture (larger f-number).

## Time Zone and Date

MENU button →  setup menu

Change time zones, set the camera clock, choose the date display order, and turn daylight saving time on or off.

Option	Description
<b>Time zone</b>	Choose a time zone. The camera clock is automatically set to the time in the new time zone.
<b>Date and time</b>	Set the camera clock (  18).
<b>Date format</b>	Choose the order in which the day, month, and year are displayed.
<b>Daylight saving time</b>	Turn daylight saving time on or off. The camera clock will automatically be advanced or set back one hour. The default setting is <b>Off</b> .

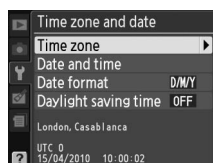

## Language

MENU button → Y setup menu

Choose a language for camera menus and messages. The following options are available:

Option	Description	Option	Description	Option	Description			
Cz	Čeština	Czech	It	Italiano	Italian	Sv	Svenska	Swedish
Dk	Dansk	Danish	Nl	Nederlands	Dutch	Tr	Türkçe	Turkish
De	Deutsch	German	No	Norsk	Norwegian	繁	中文(繁體)	Traditional Chinese
En	English	English	Pl	Polski	Polish	简	中文(简体)	Simplified Chinese
Es	Español	Spanish	Pt	Português	Portuguese	日	日本語	Japanese
Fr	Français	French	Ru	Русский	Russian	한	한글	Korean
Id	Indonesia	Indonesian	Fi	Suomi	Finnish			

## Image Comment

MENU button → Y setup menu

Add a comment to new photographs as they are taken. Comments can be viewed as metadata in ViewNX 2 (supplied) or Capture NX 2 (available separately; □ 177). The comment is also visible on the third shooting data page in the photo information display (□ 103).

- **Done:** Save changes and return to the setup menu.
- **Input comment:** Input a comment as described on page 149. Comments can be up to 36 characters long.
- **Attach comment:** Select this option to attach the comment to all subsequent photographs. **Attach comment** can be turned on and off by highlighting it and pressing ►.

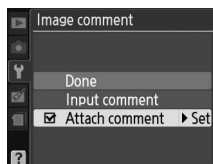

## Auto Image Rotation

MENU button →  setup menu

Photographs taken while **On** is selected contain information on camera orientation, allowing them to be rotated automatically during playback or when viewed in ViewNX 2 or Capture NX 2 (available separately; □ 177). The following orientations are recorded:



Landscape (wide) orientation

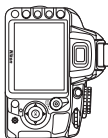

Camera rotated 90° clockwise



Camera rotated 90° counterclockwise

Camera orientation is not recorded when **Off** is selected. Choose this option when panning or taking photographs with the lens pointing up or down.

### Auto Image Rotation

In continuous release mode (□ 5, 53), the orientation recorded for the first shot applies to all photographs in the same burst, even if camera orientation is changed during shooting.

### Rotate Tall

To automatically rotate “tall” (portrait-orientation) photographs for display during playback, select **On** for the **Rotate tall** option in the playback menu (□ 130).

## Dust off Ref Photo

MENU button →  setup menu

Acquire reference data for the Image Dust Off option in Capture NX 2 (available separately; for more information, see the Capture NX 2 manual).

**Dust off ref photo** is available only when a CPU lens is mounted on the camera. A lens with a focal length of at least 50 mm is recommended. When using a zoom lens, zoom all the way in.

### 1 Choose a start option.

Highlight one of the following options and press . To exit without acquiring image dust off data, press MENU.



- **Start:** The message shown at right will be displayed and “rEF” will appear in the viewfinder.
- **Clean sensor, then start:** Select this option to clean the image sensor before starting. The message shown at right will be displayed and “rEF” will appear in the viewfinder when cleaning is complete.



**Image Sensor Cleaning**

Dust off reference data recorded before image sensor cleaning is performed can not be used with photographs taken after image sensor cleaning is performed. Select **Clean sensor, then start** only if the dust off reference data will not be used with existing photographs.

## 2 Frame a featureless white object in the viewfinder.

With the lens about ten centimeters (four inches) from a well-lit, featureless white object, frame the object so that it fills the viewfinder and then press the shutter-release button halfway.

In autofocus mode, focus will automatically be set to infinity; in manual focus mode, set focus to infinity manually.

## 3 Acquire dust off reference data.

Press the shutter-release button the rest of the way down to acquire Image Dust Off reference data. The monitor turns off when the shutter-release button is pressed. Note that noise reduction will be performed if the subject is poorly lit, increasing recording times.

If the reference object is too bright or too dark, the camera may be unable to acquire Image Dust Off reference data and the message shown at right will be displayed. Choose another reference object and repeat the process from step 1.



**Image Dust Off Reference Data**



The same reference data can be used for photographs taken with different lenses or at different apertures. Reference images can not be viewed using computer imaging software. A grid pattern is displayed when reference images are viewed on the camera.



## Auto off Timers

MENU button →  setup menu

This option determines how long the monitor remains on if no operations are performed during menu display and playback (**Playback/menus**), while photographs are displayed in the monitor after shooting (**Image review**), and during live view (**Live view**), and how long the exposure meters, viewfinder, and information display remain on when no operations are performed (**Auto meter-off**). Choose shorter auto-off delays to reduce the drain on the battery.

Option	Description (all times are approximate)				
SHORT <b>Short</b> NORM <b>Normal</b> LONG <b>Long</b>	Auto-off timers are set to the following values:				
		Playback/menus	Image review	Live view	Auto meter-off
	Short	8 s	4 s	30 s	4 s
	Normal	12 s	4 s	30 s	8 s
Long	20 s	20 s	3 min.	1 min.	
 <b>Custom</b>	Make separate adjustments to the <b>Playback/menus</b> , <b>Image review</b> , <b>Live view</b> , and <b>Auto meter-off</b> timers. When settings are complete, highlight <b>Done</b> and press  .				

### Auto off Timers

The monitor and viewfinder will not turn off automatically when the camera is connected to a computer or printer via USB.

## Self-Timer Delay

MENU button →  setup menu

Choose the length of the shutter release delay in self-timer mode ( 54).

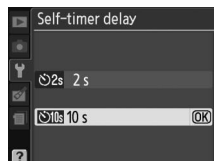



## Beep

MENU button → Y setup menu

If **On** is selected, a beep will sound when the camera focuses in single-servo AF (**AF-S** or when shooting stationary subjects in **AF-A** focus mode), when focus locks in live view, and while the release timer is counting down in self-timer mode (☞ 54, 55). The beep will not sound when **Off** is selected. In quiet shutter release mode (mode ; ☞ 5, 53), this option is not available and a beep will not sound when the camera focuses.









The current setting is shown in the information display:  is displayed when the beep is on,  when it is off.



## Rangefinder

MENU button → Y setup menu

Choose **On** to use the exposure indicator to determine whether the camera is correctly focused in manual focus mode (☞ 62; note that this function is not available in shooting mode **M**, when the exposure indicator instead shows whether the subject is correctly exposed).

Indicator	Description	Indicator	Description
	Camera in focus.		Focus point is slightly behind subject.
	Focus point is slightly in front of subject.		Focus point is well behind subject.
	Focus point is well in front of subject.		Camera can not determine correct focus.

### Using the Electronic Rangefinder

The electronic rangefinder requires a lens with a maximum aperture of  $f/5.6$  or faster. The desired results may not be achieved in situations in which the camera would be unable to focus using autofocus (☞ 56). The electronic rangefinder is not available during live view.



## File Number Sequence

MENU button →  setup menu

When a photograph is taken, the camera names the file by adding one to the last file number used. This option controls whether file numbering continues from the last number used when a new folder is created, the memory card is formatted, or a new memory card is inserted in the camera.

Option	Description
<b>On</b>	When a new folder is created, the memory card formatted, or a new memory card inserted in the camera, file numbering continues from the last number used or from the largest file number in the current folder, whichever is higher. If a photograph is taken when the current folder contains a photograph numbered 9999, a new folder will be created automatically and file numbering will begin again from 0001.
<b>Off</b>	File numbering is reset to 0001 when a new folder is created, the memory card is formatted, or a new memory card is inserted in the camera. Note that a new folder is created automatically if a photograph is taken when the current folder contains 999 photographs.
<b>RESET Reset</b>	Resets the file numbering for <b>On</b> to 0001 and creates a new folder with the next photograph taken.

### File Number Sequence

If the current folder is numbered 999 and contains either 999 photographs or a photograph numbered 9999, the shutter-release button will be disabled and no further photographs can be taken. Choose **Reset** for **File number sequence** and then either format the current memory card or insert a new memory card.



Choose the roles played by the **Fn** and **AE-L/AF-L** buttons.

### ■ ■ Fn Button

Choose the role played by the **Fn** button. The item currently selected is shown by a white-on-black icon in the information display.



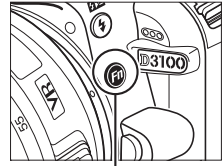

Option	Description
QUAL <b>Image quality/size</b>	Press the <b>Fn</b> button and rotate the command dial to select image quality and size (☞ 64).
ISO <b>ISO sensitivity</b>	Press the <b>Fn</b> button and rotate the command dial to select ISO sensitivity (☞ 71).
WB <b>White balance</b>	Press the <b>Fn</b> button and rotate the command dial to select white balance ( <b>P</b> , <b>S</b> , <b>A</b> , and <b>M</b> modes only; ☞ 87).
 <b>Active D-Lighting</b>	Press the <b>Fn</b> button and rotate the command dial to select an Active D-Lighting option ( <b>P</b> , <b>S</b> , <b>A</b> , and <b>M</b> modes only; ☞ 85).



**Fn** button

### ■ ■ AE-L/AF-L Button

Choose the role played by the **AE-L/AF-L** button.

Option	Description
 <b>AE/AF lock</b>	Focus and exposure lock while the <b>AE-L/AF-L</b> button is pressed.
 <b>AE lock only</b>	Exposure locks while the <b>AE-L/AF-L</b> button is pressed.
 <b>AF lock only</b>	Focus locks while the <b>AE-L/AF-L</b> button is pressed.
 <b>AE lock (hold)</b>	Exposure locks when the <b>AE-L/AF-L</b> button is pressed, and remains locked until the button is pressed a second time or the exposure meters turn off.
 <b>AF-ON</b>	The <b>AE-L/AF-L</b> button initiates autofocus. The shutter-release button can not be used to focus except when <b>AF-F</b> is selected in live view or during movie recording.

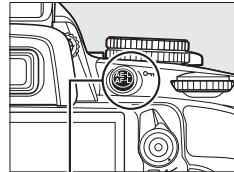

**AE-L/AF-L** button

### ■ ■ AE Lock

At the default setting of **Off**, exposure only locks when the **AE-L/AF-L** button is pressed. If **On** is selected, exposure will also lock when the shutter-release button is pressed halfway.

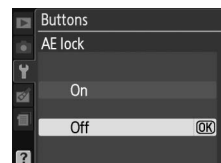

## Slot Empty Release Lock



MENU button →  setup menu

If **Release locked** is selected, the shutter-release button is only enabled when a memory card is inserted in the camera. Selecting **Enable release** allows the shutter to be released when no memory card is inserted, although no pictures will be recorded (they will however be displayed in the monitor in demo mode).

## Date Imprint

MENU button →  setup menu

Choose the date information imprinted on photographs as they are taken.

Option	Description
<b>Off</b>	The time and date do not appear on photographs.
DATE <b>Date</b>	The date or date and time are imprinted on photographs taken while this option is in effect. <span style="float: right;">15.04.2010</span>
DATE  <b>Date and time</b>	<span style="float: right;">15.04.2010 10:02</span>
 <b>Date counter</b>	New photos are imprinted with a time stamp showing the number of days between the date of shooting and a selected date (□ 148).

At settings other than **Off**, the selected option is indicated by a **DATE** icon in the information display.



### Date Imprint

The date is recorded in the order selected in the **Time zone and date** menu (□ 139). Date information is not imprinted on photographs taken in NEF (RAW) format and can not be added to or removed from existing pictures. To print the date of recording on photographs taken with date imprint off, select **Time stamp** in the PictBridge menu (□ 119, 122), or select **Imprint date** in the **Print set (DPOF)** menu to print the date of recording on all pictures in the current DPOF print order (□ 125).



## ■ ■ Date Counter

Pictures taken while this option is in effect are imprinted with the number of days remaining until a future date or the number of days elapsed since a past date. Use it to track the growth of a child or count down the days until a birthday or wedding.



*Future date (two days remaining)*



*Past date (two days elapsed)*

Up to three separate dates can be stored in slots 1, 2, and 3. The first time you use the date counter, you will be prompted to select a date for slot 1; enter a date using the multi selector and press **OK**. To change the date or store additional dates, highlight a slot, press **▶**, and enter the date. To use the stored date, highlight the slot and press **OK**.

To choose a date counter format, highlight **Display options** and press **▶** to display the menu shown at right. Highlight an option and press **OK**. Highlight **Done** in the date counter menu and press **OK** when settings are complete.

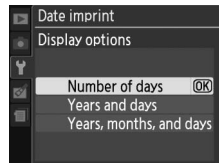
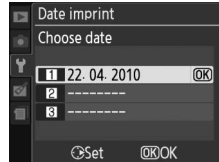
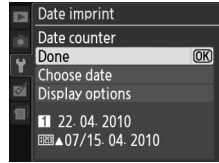

Create, rename, or delete folders, or choose the folder in which subsequent photographs will be stored.

- **Select folder:** Choose the folder in which subsequent photographs will be stored.

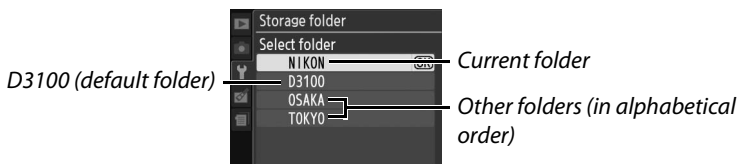



- **New:** Create a new folder and name it as described below.
- **Rename:** Select a folder from the list and rename it as described below.
- **Delete:** Delete all empty folders on the memory card.

## ■ Naming and Renaming Folders

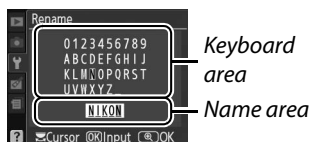
Folder names can be up to five characters long. To move the cursor in the name area, rotate the command dial. To enter a new letter at the current cursor position, use the multi selector to highlight the desired character in the keyboard area and press .



To delete the character at the current cursor position, press the  button. Press the  button to save changes and return to the setup menu, or press MENU to exit without creating a new folder or changing the folder name.

### Folder Names

On the memory card, folder names are preceded by a three-digit folder number assigned automatically by the camera (e.g., 100D3100). Each folder can contain up to 999 photographs. During shooting, pictures are stored in the highest-numbered folder with the selected name. If a photograph is taken when the current folder is full or contains a photograph numbered 9999, the camera will create a new folder by adding one to the current folder number (e.g., 101D3100). The camera treats folders with the same name but different folder numbers as the same folder. For example, if the folder NIKON is selected for **Storage folder**, photographs in all folders named NIKON (100NIKON, 101NIKON, 102NIKON, etc.) will be visible when **Current** is selected for **Playback folder** ( 129). Renaming changes all folders with the same name but leaves the folder numbers intact. Selecting **Delete** deletes empty numbered folders but leaves other folders with the same name intact.







## Eye-Fi Upload

MENU button → Y setup menu

This option is displayed only when an Eye-Fi memory card (available separately from third-party suppliers) is inserted in the camera. Choose **Enable** to upload photographs to a preselected destination. Note that pictures will not be uploaded if signal strength is insufficient.

Observe all local laws concerning wireless devices and choose **Disable** where wireless devices are prohibited.

When an Eye-Fi card is inserted, its status is indicated by an icon in the information display:

- : Eye-Fi upload disabled.
- : Eye-Fi upload enabled but no pictures available for upload.
-  (static): Eye-Fi upload enabled; waiting to begin upload.
-  (animated): Eye-Fi upload enabled; uploading data.
- : Error.



### Eye-Fi Cards

Eye-Fi cards may emit wireless signals when **Disable** is selected. If a warning is displayed in the monitor ( 192), turn the camera off and remove the card.

See the manual provided with the Eye-Fi card, and direct any inquiries to the manufacturer. The camera can be used to turn Eye-Fi cards on and off, but may not support other Eye-Fi functions.

### Supported Eye-Fi Cards

As of June 2010, the following cards can be used: 2 GB SD Eye-Fi cards in the Share, Home, and Explore product categories, 4 GB SDHC Eye-Fi cards in the Anniversary, Share Video, Explore Video, and Connect X2 product categories, and 8 GB SDHC cards in the Pro X2 and Explore X2 product categories. Eye-Fi cards are for use only in the country of purchase. Be sure the Eye-Fi card firmware has been updated to the latest version.

## Firmware Version

MENU button → Y setup menu

View the current camera firmware version.







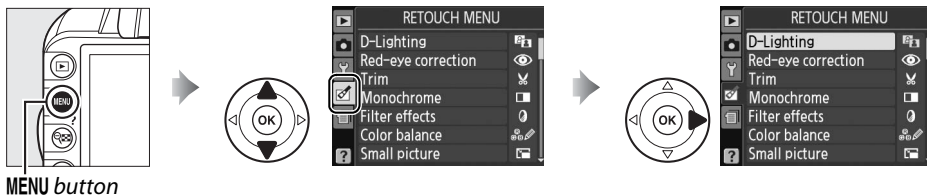













# The Retouch Menu: Creating Retouched Copies

To display the retouch menu, press **MENU** and select the  (retouch menu) tab.



MENU button

The retouch menu is used to create trimmed or retouched copies of the photographs on the memory card, and is only available when a memory card containing photographs is inserted in the camera.

Option		Option		Option	
 <b>D-Lighting</b>	153	 <b>Small picture</b>	156	 <b>Fisheye</b>	162
 <b>Red-eye correction</b>	153	 <b>Image overlay</b> <sup>1</sup>	158	 <b>Color outline</b>	162
 <b>Trim</b>	154	 <b>NEF (RAW) processing</b>	160	 <b>Perspective control</b>	162
 <b>Monochrome</b>	154	 <b>Quick retouch</b>	161	 <b>Miniature effect</b>	163
 <b>Filter effects</b>	155	 <b>Straighten</b>	161	 <b>Edit movie</b>	50
 <b>Color balance</b>	156	 <b>Distortion control</b>	161	 <b>Before and after</b> <sup>2</sup>	164

1 Can only be selected by pressing **MENU** button and selecting  tab.

2 Available only if  button is pressed in full-frame playback when a retouched image or original is displayed.

## Retouching Copies

With the exceptions of **Image overlay** and **Edit movie** > **Choose start point/Choose end point**, each effect can be applied once (note that multiple edits may result in loss of detail). Options that can not be applied to the current image are grayed out and unavailable.

## Image Quality

Except in the case of copies created with **Trim**, **Small picture**, **Image overlay**, and **NEF (RAW) processing**, copies created from JPEG images are the same size and quality as the original, while copies created from NEF (RAW) photos are saved as large fine-quality JPEG images. Time stamps added with **Date Imprint** (📖 147) may however be cropped out or illegible depending on the retouch options used.



# Creating Retouched Copies

To create a retouched copy:

- 1 Display retouch options.**  
Highlight the desired item in the retouch menu and press ►.

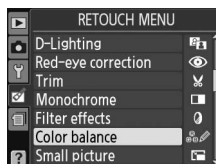

- 2 Select a picture.**  
Highlight a picture and press **OK**.

**Retouch**  
The camera may not be able to display or retouch images created with other devices.

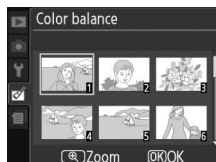

- 3 Select retouch options.**  
For more information, see the section for the selected item. To exit without creating a retouched copy, press **MENU**.



**Monitor off Delay**  
The monitor will turn off and the menu will close without a retouched copy being created if no operations are performed for about 12 s; if desired, the delay can be extended by choosing **Long** for **Auto off timers** in the setup menu.

- 4 Create a retouched copy.**  
Press **OK** to create a retouched copy. Retouched copies are indicated by a icon.



**Creating Retouched Copies During Playback**  
Retouched copies can also be created during playback.



Display picture full frame and press **OK**.

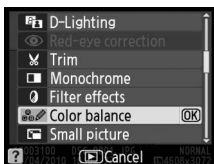

Highlight an option and press **OK**.



Create retouched copy.



## D-Lighting

MENU button → retouch menu

D-Lighting brightens shadows, making it ideal for dark or backlit photographs.



Before



After

Press ▲ or ▼ to choose the amount of correction performed. The effect can be previewed in the edit display. Press to copy the photograph.

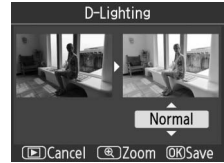

## Red-Eye Correction

MENU button → retouch menu

This option is used to correct “red-eye” caused by the flash, and is available only with photographs taken using the flash. The photograph selected for red-eye correction is previewed as shown at right. Confirm the effects of red-eye correction and create a copy as described in the following table. Note that red-eye correction may not always produce the expected results and may in very rare circumstances be applied to portions of the image that are not affected by red-eye; check the preview thoroughly before proceeding.

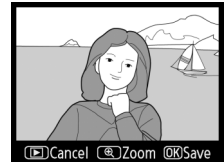

To	Use	Description
Zoom in		Press  button to zoom in,  button to zoom out. While photo is zoomed in, use multi selector to view areas of image not visible in monitor. Keep multi selector pressed to scroll rapidly to other areas of frame. Navigation window is displayed when zoom buttons or multi selector is pressed; area currently visible in monitor is indicated by yellow border. Press  to cancel zoom.
Zoom out		
View other areas of image		
Cancel zoom		
Create copy		If the camera detects red-eye in the selected photograph, a copy will be created that has been processed to reduce its effects. No copy will be created if the camera is unable to detect red-eye.

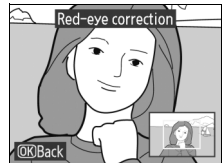

## Trim

MENU button → retouch menu

Create a cropped copy of the selected photograph. The selected photograph is displayed with the selected crop shown in yellow; create a cropped copy as described in the following table.



To	Use	Description
Increase size of crop		Press the  button to increase the size of the crop.
Reduce size of crop		Press the  button to reduce the size of the crop.
Change crop aspect ratio		Rotate the command dial to switch between aspect ratios of 3 : 2, 4 : 3, 5 : 4, 1 : 1, and 16 : 9.
Move crop		Use multi selector to move the crop to another area of the image.
Create copy		Save the current crop as a separate file.

### Trim: Image Quality and Size

Copies created from NEF (RAW) or **NEF (RAW) + JPEG fine** photos have an image quality of JPEG fine ( 64); copies created from JPEG photos have the same image quality as the original. The size of the copy varies with crop size and aspect ratio.

Aspect ratio	Possible sizes
3 : 2	3,840 × 2,560, 3,200 × 2,128, 2,560 × 1,704, 1,920 × 1,280, 1,280 × 856, 960 × 640, 640 × 424
4 : 3	3,840 × 2,880, 3,200 × 2,400, 2,560 × 1,920, 1,920 × 1,440, 1,280 × 960, 960 × 720, 640 × 480
5 : 4	3,600 × 2,880, 2,992 × 2,400, 2,400 × 1,920, 1,808 × 1,440, 1,200 × 960, 896 × 720, 608 × 480
1 : 1	2,880 × 2,880, 2,400 × 2,400, 1,920 × 1,920, 1,440 × 1,440, 960 × 960, 720 × 720, 480 × 480
16 : 9	3,840 × 2,160, 3,200 × 1,800, 2,560 × 1,440, 1,920 × 1,080, 1,280 × 720, 960 × 536, 640 × 360

## Monochrome

MENU button → retouch menu

Copy photographs in **Black-and-white**, **Sepia**, or **Cyanotype** (blue and white monochrome).

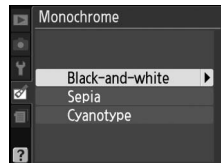

Selecting **Sepia** or **Cyanotype** displays a preview of the selected image; press to increase color saturation, to decrease. Press to create a monochrome copy.

Increase saturation





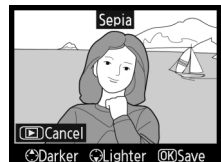



Decrease saturation

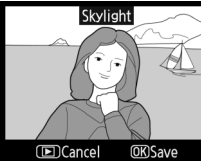
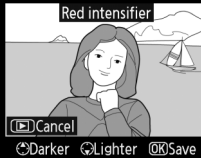

# Filter Effects

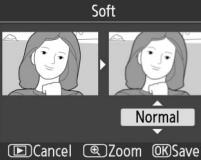
MENU button →  retouch menu

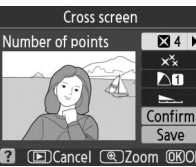
Choose from the following filter effects. After adjusting filter effects as described below, press  to copy the photograph.

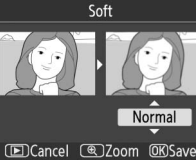
Option	Description	
<b>Skylight</b>	Creates the effect of a skylight filter, making the picture less blue. The effect can be previewed in the monitor as shown at right.	
<b>Warm filter</b>	Creates a copy with warm tone filter effects, giving the copy a “warm” red cast. The effect can be previewed in the monitor.	
<b>Red intensifier</b> <b>Green intensifier</b> <b>Blue intensifier</b>	Intensify reds ( <b>Red intensifier</b> ), greens ( <b>Green intensifier</b> ), or blues ( <b>Blue intensifier</b> ). Press  to increase the effect,  to decrease.	
<b>Cross screen</b>	Add starburst effects to light sources. <ul style="list-style-type: none"> <li>• <b>Number of points:</b> Choose from four, six, or eight.</li> <li>• <b>Filter amount:</b> Choose the brightness of the light sources affected.</li> <li>• <b>Filter angle:</b> Choose the angle of the points.</li> <li>• <b>Length of points:</b> Choose the length of points.</li> <li>• <b>Confirm:</b> Preview the effects of the filter as shown at right. Press  to preview the copy full frame.</li> <li>• <b>Save:</b> Create a retouched copy.</li> </ul>	
<b>Soft</b>	Add a soft filter effect. Press  or  to choose the filter strength.	



## Color Balance

MENU button → retouch menu

Use the multi selector to create a copy with modified color balance as shown below. The effect is displayed in the monitor together with red, green, and blue histograms (□ 101) giving the distribution of tones in the copy.

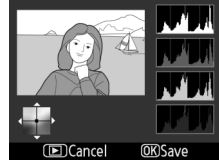

*Increase amount of green*



*Increase amount of magenta*

### Zoom

To zoom in on the image displayed in the monitor, press the button. The histogram will be updated to show data only for the portion of the image displayed in the monitor. While the image is zoomed in, press the () button to toggle back and forth between color balance and zoom. When zoom is selected, you can zoom in and out with the and buttons and scroll the image with the multi selector.



## Small Picture

MENU button → retouch menu

Create small copies of pictures. The following sizes are available:

Option	Description
<b>640×480</b>	Suited to television playback.
<b>320×240</b>	Suited to display on Web pages.
<b>160×120</b>	Suitable for e-mail.

To create small copies of multiple selected pictures, press **MENU**, select **Small picture** in the retouch menu tab, and then follow the steps below.

### 1 Select Choose size.

Highlight **Choose size** and press .

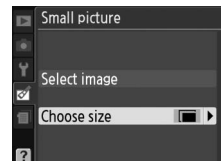

## 2 Choose the desired size.

Highlight desired size and press **OK** to select and return to the previous menu.

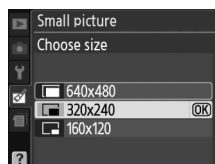

## 3 Choose Select image.

Highlight **Select image** and press **▶**.

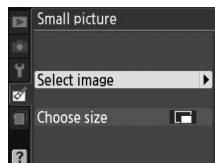

## 4 Select pictures.

Highlight pictures using the multi selector and press the **Set** button to select or deselect. Selected pictures are marked by an icon. To view the highlighted photograph full frame, press and hold the **Zoom** button.

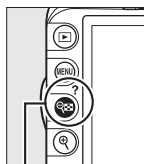

**Set** button

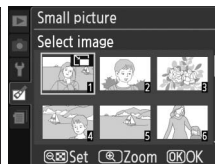

## 5 Press **OK** to complete the operation.

Press **OK**. A confirmation dialog will be displayed; highlight **Yes** and press **OK** to copy pictures at the selected size and return to playback. To exit without creating copies, highlight **No** and press **OK**, or press **MENU** to exit to the retouch menu.



### Viewing Small Pictures

Small pictures are indicated by a gray border. Playback zoom is not available when small pictures are displayed. Note that because small copies do not have the same aspect ratio as the original, the edges of the copy will be cropped out on its longest dimension.



Image overlay combines two existing NEF (RAW) photographs to create a single picture that is saved separately from the originals; the results, which make use of RAW data from the camera image sensor, are noticeably better than overlays created in an imaging application. The new picture is saved at current image quality and size settings; before creating an overlay, set image quality and size (☐ 64, 66; all options are available). To create an NEF (RAW) copy, choose an image quality of **NEF (RAW)**.



## 1 Select Image overlay.

Highlight **Image overlay** in the retouch menu and press ►. The dialog shown at right will be displayed, with **Image 1** highlighted.



## 2 Display NEF (RAW) images.

Press to display a picture selection dialog listing only NEF (RAW) images created with this camera.



## 3 Highlight a photograph.

Use the multi selector to highlight the first photograph in the overlay. To view the highlighted photograph full frame, press and hold the button.



## 4 Select the highlighted photograph.

Press to select the highlighted photograph and return to the preview display. The selected image will appear as **Image 1**.

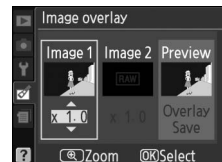

## 5 Select the second photograph.

Press **▶** to highlight **Image 2**. Repeat Steps 2–4 to select the second photo.

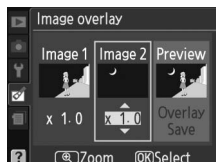

## 6 Set gain.

Highlight **Image 1** or **Image 2** and optimize exposure for the overlay by pressing **▲** or **▼** to set gain for the selected image to values between 0.1 and 2.0. Repeat for the second image. The default value is 1.0; selecting 0.5 cuts gain in half, while selecting 2.0 doubles gain. The effects of gain are visible in the **Preview** column.

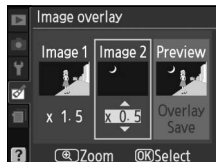

## 7 Highlight the Preview column.

Press **◀** or **▶** to highlight the **Preview** column.

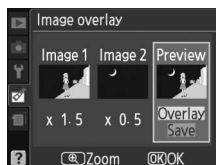

## 8 Preview the overlay.

Press **▲** or **▼** to highlight **Overlay** and press **OK** (to save the overlay without displaying a preview, highlight **Save** and press **OK**). To return to Step 6 and select new photos or adjust gain, press **⏪**.

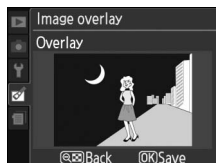

## 9 Save the overlay.

Press **OK** while the preview is displayed to save the overlay. After an overlay is created, the resulting image will be displayed full-frame in the monitor.



### Image Overlay

The overlay has the same photo info (including date of recording, metering, shutter speed, aperture, shooting mode, exposure compensation, focal length, and image orientation) and values for white balance and Picture Control as the photograph selected for **Image 1**.



Create JPEG copies of NEF (RAW) photographs.

## 1 Select NEF (RAW) processing.

Highlight **NEF (RAW) processing** in the retouch menu and press ► to display a picture selection dialog listing only NEF (RAW) images created with this camera.

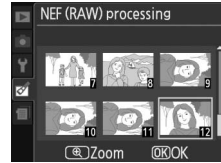

## 2 Select a photograph.

Use the multi selector to highlight a photograph (to view the highlighted photograph full frame, press and hold the button). Press to select the highlighted photograph and proceed to the next step.



## 3 Adjust NEF (RAW) processing settings.

Choose image quality ( 64), image size ( 66), white balance ( 87), exposure compensation ( 81), and a Picture Control ( 94) for the JPEG copy. Color space ( 133) and noise reduction ( 134) are set to the values currently selected in shooting mode. Note that white balance is not available with pictures created with image overlay, and that exposure compensation can only be set to values between -2 and +2 EV.

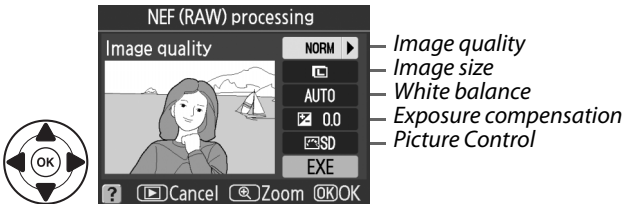

## 4 Copy the photograph.

Highlight **EXE** and press to create a JPEG copy of the selected photograph. The resulting image will be displayed full-frame in the monitor. To exit without copying the photograph, press the MENU button.





## Quick Retouch

MENU button →  retouch menu

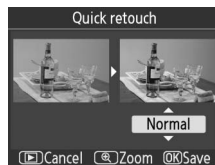

Create copies with enhanced saturation and contrast. D-Lighting is applied as required to brighten dark or backlit subjects.

Press ▲ or ▼ to choose the amount of enhancement. The effect can be previewed in the edit display. Press  to copy the photograph.



## Straighten

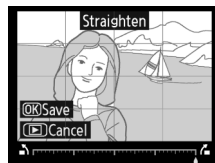

MENU button →  retouch menu

Create a straightened copy of the selected image. Press ► to rotate the image clockwise by up to five degrees in increments of approximately 0.25 degrees, ◀ to rotate it counterclockwise (note that edges of the image will be trimmed to create a square copy). Press  to copy the photograph, or press  to exit to playback without creating a copy.



## Distortion Control

MENU button →  retouch menu

Create copies with reduced peripheral distortion. Select **Auto** to let the camera correct distortion automatically and then make fine adjustments using the multi selector, or select **Manual** to reduce distortion manually (note that **Auto** is not available with photos taken using auto distortion control; see page 133). Press ► to reduce barrel distortion, ◀ to reduce pin-cushion distortion (note that greater amounts of distortion control result in more of the edges being cropped out). Press  to copy the photograph, or press  to exit to playback without creating a copy.

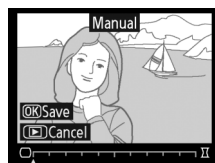

### **Auto**

**Auto** is for use only with pictures taken with type G and D lenses (PC, fisheye, and certain other lenses excluded). Results are not guaranteed with other lenses.



## Fisheye

MENU button →  retouch menu

Create copies that appear to have been taken with a fisheye lens. Press **▶** to increase the effect (this also increases the amount that will be cropped out at the edges of the image), **◀** to reduce it. Press **Ⓚ** to copy the photograph, or press **▶** to exit to playback without creating a copy.

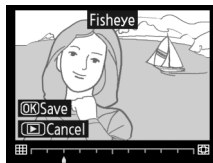

## Color Outline

MENU button →  retouch menu

Create an outline copy of a photograph to use as a base for painting. The effect can be previewed in the edit display. Press **Ⓚ** to copy the photograph.

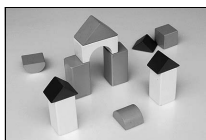

Before

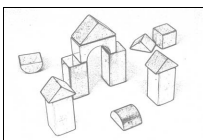

After



## Perspective Control

MENU button →  retouch menu

Create copies that reduce the effects of perspective taken from the base of a tall object. Use the multi selector to adjust perspective (note that greater amounts of perspective control result in more of the edges being cropped out). Press **Ⓚ** to copy the photograph, or press **▶** to exit to playback without creating a copy.



Before



After

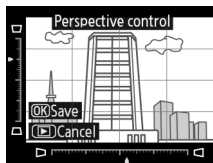

# Miniature Effect

MENU button → retouch menu

Create a copy that appears to be a photo of a diorama. Works best with photos taken from a high vantage point.

To	Press	Description
Choose area in focus		If photo is displayed in wide orientation, press ▲ or ▼ to position frame showing area of copy that will be in focus.
		If photo is displayed in tall orientation (📖 141), press ◀ or ▶ to position frame showing area of copy that will be in focus.
Preview copy		Preview copy.
Cancel		Exit to full-frame playback without creating copy.
Create copy		Create copy.

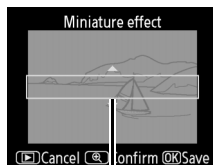

*Area in focus*

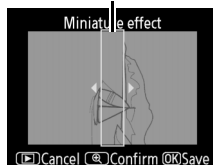

## Before and After

Compare retouched copies to the original photographs. This option is only available if the **OK** button is pressed to display the retouch menu when a copy or original is played back full frame.

### 1 Select a picture.

Select a retouched copy (shown by a  icon) or a photograph that has been retouched in full-frame playback and press **OK**.



### 2 Select Before and after.

Highlight **Before and after** in the retouch menu and press **OK**.



### 3 Compare the copy with the original.

The source image is displayed on the left, the retouched copy on the right, with the options used to create the copy listed at the top of the display. Press **◀** or **▶** to switch between the source image and the retouched copy. To view the highlighted picture full frame, press and hold the **Q** button. If the copy was created from two images using **Image overlay**, press **▲** or **▼** to view the other source image. If multiple copies exist for the current source image, press **▲** or **▼** to view the other copies. To exit to playback mode, press the **▶** button, or press **OK** to return to playback with the highlighted image displayed.

*Options used to create copy*

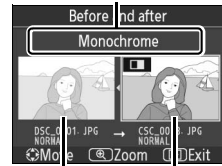

*Source image      Retouched copy*

#### **Before-and-After Comparisons**

The source image will not be displayed if the copy was created from a photograph that has since been deleted or that was protected when the copy was made ( 108).



# Recent Settings

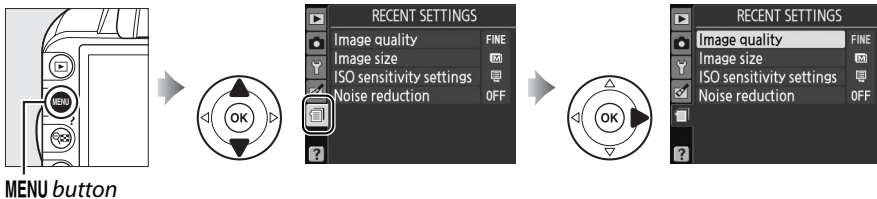

To display the recent settings menu, press **MENU** and select the  (recent settings) tab.

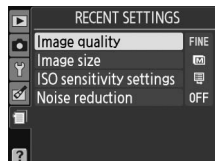

The recent settings menu lists the twenty most recently used settings. Press **▲** or **▼** to highlight an option and press **▶** to select.



## Removing Items from the Recent Settings Menu

To remove an item from the recent settings menu, highlight it and press the  button. A confirmation dialog will be displayed; press  again to delete the selected item.







# Technical Notes

## Compatible Lenses

### Compatible CPU Lenses

This camera supports autofocus with AF-S and AF-I CPU lenses only. AF-S lenses have names beginning with **AF-S**, AF-I lenses names beginning with **AF-I**. Autofocus is not supported with other autofocus (AF) lenses. The features available with compatible CPU lenses are listed below:

Camera setting Lens/accessory	Focus			Mode			Metering		
	AF	MF (with electronic rangefinder)	MF	Auto and scene modes; P, S, A	M	☒		☑	
						3D	Color	☑	
AF-S, AF-I NIKKOR <sup>1</sup>	✓	✓	✓	✓	✓	✓	—	✓ <sup>2</sup>	
Other type G or D AF NIKKOR <sup>1</sup>	—	✓	✓	✓	✓	✓	—	✓ <sup>2</sup>	
PC-E NIKKOR series	—	✓ <sup>3</sup>	✓	✓ <sup>3</sup>	✓ <sup>3</sup>	✓ <sup>3</sup>	—	✓ <sup>2,3</sup>	
PC Micro 85mm f/2.8D <sup>4</sup>	—	✓ <sup>3</sup>	✓	—	✓	✓	—	✓ <sup>2,3</sup>	
AF-S/AF-I teleconverter <sup>5</sup>	✓ <sup>6</sup>	✓ <sup>6</sup>	✓	✓	✓	✓	—	✓ <sup>2</sup>	
Other AF NIKKOR (except lenses for F3AF)	—	✓ <sup>7</sup>	✓	✓	✓	—	✓	✓ <sup>2</sup>	
AI-P NIKKOR	—	✓ <sup>8</sup>	✓	✓	✓	—	✓	✓ <sup>2</sup>	

- Use AF-S or AF-I lenses to get the most from your camera. Vibration Reduction (VR) supported with VR lenses.
- Spot metering meters selected focus point (☐ 79).
- Can not be used with shifting or tilting.
- The camera's exposure metering and flash control systems may not function as expected when the lens is shifted and/or tilted or an aperture other than the maximum aperture is used.
- AF-S or AF-I lens required.
- With maximum effective aperture of f/5.6 or faster.
- When AF 80–200mm f/2.8, AF 35–70mm f/2.8, AF 28–85mm f/3.5–4.5 (New), or AF 28–85mm f/3.5–4.5 lenses are zoomed all the way in at the minimum focus distance, the in-focus indicator may be displayed when the image on the matte screen in the viewfinder is not in focus. Focus manually until image in viewfinder is in focus.
- With maximum aperture of f/5.6 or faster.

#### ✓ IX NIKKOR Lenses

IX NIKKOR lenses can not be used.

#### ✎ Lens f-number

The f-number given in lens names is the maximum aperture of the lens.



### Identifying CPU and Type G and D Lenses

CPU lenses can be identified by the presence of CPU contacts, type G and D lenses by a letter on the lens barrel. Type G lenses are not equipped with a lens aperture ring.

*CPU contacts*

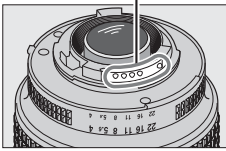

*CPU lens*

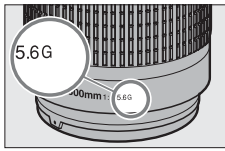

*Type G lens*

*Aperture ring*

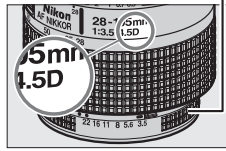

*Type D lens*





# Compatible Non-CPU Lenses

Non-CPU lenses may only be used when the camera is in mode **M**. Selecting another mode disables the shutter release. Aperture must be adjusted manually via the lens aperture ring and the camera metering system, i-TTL flash control, and other features requiring a CPU lens can not be used. Some non-CPU lenses can not be used; see “Incompatible Accessories and Non-CPU Lenses,” below.

Lens/accessory	Camera setting	Focus		Mode		Metering
	AF	MF (with electronic rangefinder)	MF	Auto and scene modes; P, S, A	M	☉, ☉, ☐
AI-, AI-modified NIKKOR or Nikon Series E lenses	—	✓ <sup>1</sup>	✓	—	✓ <sup>2</sup>	—
Medical NIKKOR 120mm f/4	—	✓	✓	—	✓ <sup>2,3</sup>	—
Reflex NIKKOR	—	—	✓	—	✓ <sup>2</sup>	—
PC NIKKOR	—	✓ <sup>4</sup>	✓	—	✓ <sup>2</sup>	—
AI-type Teleconverter	—	✓ <sup>5</sup>	✓	—	✓ <sup>2</sup>	—
PB-6 Bellows Focusing Attachment <sup>6</sup>	—	✓ <sup>1</sup>	✓	—	✓ <sup>2</sup>	—
Auto extension rings (PK-series 11A, 12, or 13; PN-11)	—	✓ <sup>1</sup>	✓	—	✓ <sup>2</sup>	—

1 With maximum aperture of f/5.6 or faster.

2 Exposure indicator can not be used.

3 Can be used at shutter speeds slower than flash sync speed by one step or more.

4 Can not be used with shifting or tilting.

5 With maximum effective aperture of f/5.6 or faster.

6 Attach in vertical orientation (can be used in horizontal orientation once attached).

## ☑ Incompatible Accessories and Non-CPU Lenses

The following accessories and non-CPU lenses can NOT be used with the D3100:

- TC-16AS AF teleconverter
- Non-AI lenses
- Lenses that require the AU-1 focusing unit (400mm f/4.5, 600mm f/5.6, 800mm f/8, 1200mm f/11)
- Fisheye (6mm f/5.6, 7.5mm f/5.6, 8mm f/8, OP 10mm f/5.6)
- 2.1cm f/4
- Extension Ring K2
- 180–600mm f/8 ED (serial numbers 174041–174180)
- 360–1200mm f/11 ED (serial numbers 174031–174127)
- 200–600mm f/9.5 (serial numbers 280001–300490)
- AF lenses for the F3AF (AF 80mm f/2.8, AF 200mm f/3.5 ED, AF Teleconverter TC-16)
- PC 28mm f/4 (serial number 180900 or earlier)
- PC 35mm f/2.8 (serial numbers 851001–906200)
- PC 35mm f/3.5 (old type)
- Reflex 1000mm f/6.3 (old type)
- Reflex 1000mm f/11 (serial numbers 142361–143000)
- Reflex 2000mm f/11 (serial numbers 200111–200310)



## The Built-in Flash

The built-in flash can be used with lenses with focal lengths of 18–300 mm, although in some cases the flash may be unable to entirely light the subject at some ranges or focal lengths due to shadows cast by the lens, while lenses that block the subject's view of the red-eye reduction lamp may interfere with red-eye reduction. Remove lens hoods to prevent shadows. The flash has a minimum range of 0.6 m and can not be used in the macro range of macro zoom lenses. The flash may be unable to light the entire subject with the following lenses at ranges less than those given below:

Lens	Zoom position	Minimum distance without vignetting
AF-S DX NIKKOR 10–24mm f/3.5–4.5G ED	24 mm	2.5 m/8 ft. 2 in.
AF-S DX Zoom-Nikkor 12–24mm f/4G IF-ED	20 mm	3.0 m/9 ft. 10 in.
	24 mm	1.0 m/3 ft. 3 in.
AF-S 16–35mm f/4G VR	28 mm	1.5 m/4 ft. 11 in.
	35 mm	1.0 m/3 ft. 3 in.
AF-S DX NIKKOR 16–85mm f/3.5–5.6G ED VR	24–85 mm	No vignetting
	24 mm	2.0 m/6 ft. 7 in.
AF-S Zoom-Nikkor 17–35mm f/2.8D IF-ED	28 mm	1.0 m/3 ft. 3 in.
	35 mm	No vignetting
	28 mm	1.5 m/4 ft. 11 in.
AF-S DX Zoom-Nikkor 17–55mm f/2.8G IF-ED	35 mm	1.0 m/3 ft. 3 in.
	45–55 mm	No vignetting
	24 mm	1.0 m/3 ft. 3 in.
AF Zoom-Nikkor 18–35mm f/3.5–4.5D IF-ED	28–35 mm	No vignetting
	18 mm	1.0 m/3 ft. 3 in.
AF-S DX Zoom-Nikkor 18–70mm f/3.5–4.5G IF-ED	24–70 mm	No vignetting
	18 mm	2.5 m/8 ft. 2 in.
AF-S DX NIKKOR 18–105mm f/3.5–5.6G ED VR	24 mm	1.0 m/3 ft. 3 in.
	18 mm	1.0 m/3 ft. 3 in.
AF-S DX Zoom-Nikkor 18–135mm f/3.5–5.6G IF-ED	24–135 mm	No vignetting
	24 mm	1.0 m/3 ft. 3 in.
AF-S DX VR Zoom-Nikkor 18–200mm f/3.5–5.6G IF-ED, AF-S DX NIKKOR 18–200mm f/3.5–5.6G ED VR II	35–200 mm	No vignetting
	24 mm	2.5 m/8 ft. 2 in.
AF Zoom-Nikkor 20–35mm f/2.8D IF	28 mm	1.0 m/3 ft. 3 in.
	35 mm	No vignetting
	24 mm	1.0 m/3 ft. 3 in.
AF-S NIKKOR 24mm f/1.4G ED	35 mm	1.5 m/4 ft. 11 in.
AF-S NIKKOR 24–70mm f/2.8G ED	50 mm	1.0 m/3 ft. 3 in.
	70 mm	No vignetting
	24 mm	1.0 m/3 ft. 3 in.
AF-S VR Zoom-Nikkor 24–120mm f/3.5–5.6G IF-ED	28–120 mm	No vignetting
	24 mm	2.5 m/8 ft. 2 in.
AF-S NIKKOR 24–120mm f/4G ED VR	28 mm	1.5 m/4 ft. 11 in.
AF-S NIKKOR 28–300mm f/3.5–5.6G ED VR	35 mm	1.0 m/3 ft. 3 in.
	35 mm	1.5 m/4 ft. 11 in.
AF-S Zoom-Nikkor 28–70mm f/2.8D IF-ED	50–70 mm	No vignetting



Lens	Zoom position	Minimum distance without vignetting
AF-S VR Zoom-Nikkor 200–400mm f/4G IF-ED	250 mm	2.5 m/8 ft. 2 in.
	350 mm	2.0 m/6 ft. 7 in.
AF-S NIKKOR 200–400mm f/4G ED VR II	200 mm	5.0 m/16 ft. 5 in.
	250 mm	3.0 m/9 ft. 10 in.
	300 mm	2.5 m/8 ft. 2 in.
	350–400 mm	No vignetting
PC-E NIKKOR 24mm f/3.5 ED *	24 mm	3.0 m/9 ft. 10 in.

\* When not shifted or tilted.

When used with the AF-S NIKKOR 14–24mm f/2.8G ED, the flash will be unable to light the entire subject at all ranges.

### ☑ AF-Assist Illumination

AF-assist illumination is not available with the following lenses:

- AF-S NIKKOR 14–24mm f/2.8G ED
- AF-S DX NIKKOR 28–300mm f/3.5–5.6G ED VR
- AF-S DX NIKKOR 55–300mm f/4.5–5.6G ED VR
- AF-S VR Zoom-Nikkor 70–200mm f/2.8G IF-ED
- AF-S NIKKOR 70–200mm f/2.8G ED VR II
- AF-S Zoom-Nikkor 80–200mm f/2.8D IF-ED
- AF-S VR Nikkor 200mm f/2G IF-ED
- AF-S VR Zoom-Nikkor 200–400mm f/4G IF-ED
- AF-S NIKKOR 200–400mm f/4G ED VR II

At ranges under 1 m (3 ft. 3 in.), the following lenses may block the AF-assist illuminator and interfere with autofocus when lighting is poor:

- AF-S Zoom-Nikkor 17–35mm f/2.8D IF-ED
- AF-S DX Zoom-Nikkor 17–55mm f/2.8G IF-ED
- AF-S DX NIKKOR 18–105mm f/3.5–5.6G ED VR
- AF-S DX VR Zoom-Nikkor 18–200mm f/3.5–5.6G IF-ED
- AF-S DX NIKKOR 18–200mm f/3.5–5.6G ED VR II
- AF-S NIKKOR 24–70mm f/2.8G ED
- AF-S VR Zoom-Nikkor 24–120mm f/3.5–5.6G IF-ED
- AF-S NIKKOR 24–120mm f/4G ED VR
- AF-S Zoom-Nikkor 28–70mm f/2.8D IF-ED
- AF-S NIKKOR 85mm f/1.4G
- AF-S VR Micro-Nikkor 105mm f/2.8G IF-ED

### 📐 Calculating Angle of View

The size of the area exposed by a 35mm camera is  $36 \times 24$  mm. The size of the area exposed by the D3100, in contrast, is  $23.1 \times 15.4$  mm, meaning that the angle of view of a 35mm camera is approximately 1.5 times that of the D3100. The approximate focal length of lenses for the D3100 in 35mm format can be calculated by multiplying the focal length of the lens by about 1.5.

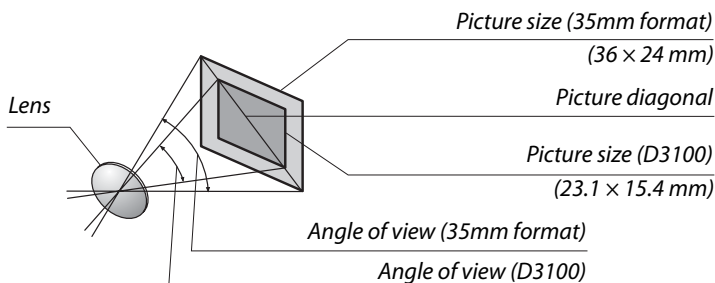

# Optional Flash Units (Speedlights)

The camera supports the Nikon Creative Lighting System (CLS) and can be used with CLS-compatible flash units. Optional flash units can be attached directly to the camera accessory shoe as described below. The accessory shoe is equipped with a safety lock for flash units with a locking pin, such as the SB-900, SB-800, SB-600, and SB-400.

## 1 Remove the accessory shoe cover.

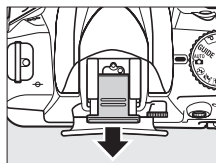

## 2 Mount the flash unit on the accessory shoe.

See the manual provided with the flash unit for details. The built-in flash will not fire when an optional flash unit is attached.

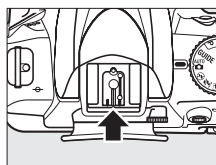

### **The AS-15 Sync Terminal Adapter**

When the AS-15 sync terminal adapter (available separately) is mounted on the camera accessory shoe, flash accessories can be connected via a sync cable.

### **Use Only Nikon Flash Accessories**

*Use only Nikon flash units.* Negative voltages or voltages over 250 V applied to the accessory shoe could not only prevent normal operation, but damage the sync circuitry of the camera or flash. Before using a Nikon flash unit not listed in this section, contact a Nikon-authorized service representative for more information.



# The Nikon Creative Lighting System (CLS)

Nikon's advanced Creative Lighting System (CLS) offers improved communication between the camera and compatible flash units for improved flash photography.

## ■ CLS-Compatible Flash Units

The camera can be used with the following CLS-compatible flash units:

- **The SB-900, SB-800, SB-600, SB-400, and SB-R200:**

Flash unit		Feature				
		SB-900 <sup>1</sup>	SB-800	SB-600	SB-400	SB-R200 <sup>2</sup>
Guide No. <sup>3</sup>	ISO 100	34/111	38/125	30/98	21/69	10/33
	ISO 200	48/157	53/174	42/138	30/98	14/46

- 1 If a color filter is attached to the SB-900 when **AUTO** or  (flash) is selected for white balance, the camera will automatically detect the filter and adjust white balance appropriately.
- 2 Controlled remotely using optional SB-900 or SB-800 flash unit or SU-800 wireless Speedlight commander.
- 3 m/ft., 20 °C (68 °F), SB-900, SB-800 and SB-600 at 35 mm zoom head position; SB-900 with standard illumination.

- **The SU-800 wireless speedlight commander:** When mounted on a CLS-compatible camera, the SU-800 can be used as a commander for remote SB-900, SB-800, SB-600, or SB-R200 flash units in up to three groups. The SU-800 itself is not equipped with a flash.

### Guide Number

To calculate the range of the flash at full power, divide the Guide Number by the aperture. For example, at ISO 100 the SB-800 has a Guide Number of 38 m or 125 ft. (35 mm zoom head position); its range at an aperture of  $f/5.6$  is  $38 \div 5.6$  or about 6.8 meters (or in feet,  $125 \div 5.6 =$  approximately 23 ft. 7 in.). For each twofold increase in ISO sensitivity, multiply the Guide Number by the square root of two (approximately 1.4).



The following features are available with CLS-compatible flash units:

Flash mode/feature	Flash unit			Advanced Wireless Lighting				
	SB-900 SB-800	SB-600	SB-400	Commander		Remote		
				SB-900 SB-800	SU-800 <sup>1</sup>	SB-900 SB-800	SB-600	SB-R200
i-TTL i-TTL balanced fill-flash for digital SLR <sup>2</sup>	✓ <sup>3</sup>	✓ <sup>3</sup>	✓ <sup>4</sup>	✓	✓	✓	✓	✓
AA Auto aperture <sup>2</sup>	✓ <sup>5</sup>	—	—	✓ <sup>6</sup>	✓ <sup>6</sup>	✓ <sup>6</sup>	—	—
A Non-TTL auto	✓ <sup>5</sup>	—	—	✓ <sup>6</sup>	—	✓ <sup>6</sup>	—	—
GN Distance-priority manual	✓	—	—	—	—	—	—	—
M Manual	✓	✓	✓ <sup>7</sup>	✓	✓	✓	✓	✓
RPT Repeating flash	✓	—	—	✓	✓	✓	✓	—
AF-assist for multi-area AF <sup>2</sup>	✓	✓	—	✓	✓	—	—	—
Flash Color Information Communication	✓	✓	✓	✓	—	—	—	—
REAR Rear-curtain sync	✓	✓	✓	✓	✓	✓	✓	✓
 Red-eye reduction	✓	✓	✓	✓	—	—	—	—
Power zoom	✓	✓	—	✓	—	—	—	—
Auto ISO sensitivity control (□ 132)	✓	✓	✓	—	—	—	—	—

1 Only available when SU-800 is used to control other flash units.

2 CPU lens required.

3 Standard i-TTL flash for digital SLR is used with spot metering or when selected with flash unit.

4 Standard i-TTL flash for digital SLR is used with spot metering.

5 Selected with flash unit.

6 Auto aperture (AA) is used regardless of mode selected with flash unit.

7 Can be selected with camera.

## ■ ■ Other Flash Units

The following flash units can be used in non-TTL auto and manual modes.

Flash mode	Flash unit	SB-80DX, SB-28DX, SB-28, SB-26, SB-25, SB-24	SB-50DX <sup>1</sup>	SB-30, SB-27 <sup>2</sup> , SB-22S, SB-22, SB-20, SB-16B, SB-15	SB-23, SB-29 <sup>3</sup> , SB-21B <sup>3</sup> , SB-29S <sup>3</sup>
A Non-TTL auto		✓	—	✓	—
M Manual		✓	✓	✓	✓
 Repeating flash		✓	—	—	—
REAR Rear-curtain sync <sup>4</sup>		✓	✓	✓	✓

1 Select mode P, S, A, or M, lower built-in flash, and use optional flash unit only.

2 Flash mode is automatically set to TTL and shutter-release is disabled. Set flash unit to A (non-TTL auto flash).

3 Autofocus is available with AF-S VR Micro-Nikkor 105mm f/2.8G IF-ED and AF-S Micro NIKKOR 60mm f/2.8G ED lenses only.

4 Available when camera is used to select flash mode.

## Notes on Optional Flash Units

Refer to the Speedlight manual for detailed instructions. If the flash unit supports CLS, refer to the section on CLS-compatible digital SLR cameras. The D3100 is not included in the “digital SLR” category in the SB-80DX, SB-28DX, and SB-50DX manuals.

If an optional flash unit is attached in shooting modes other than  $\text{Ⓢ}$ , the flash will fire with every shot, even in modes in which the built-in flash can not be used ( $\text{Ⓢ}$  and  $\text{Ⓢ}$ ).

i-TTL flash control can be used at ISO sensitivities between 100 and 3200. At values over 3200, the desired results may not be achieved at some ranges or aperture settings. If the flash-ready indicator blinks for about three seconds after a photograph is taken, the flash has fired at full power and the photograph may be underexposed.

When an SC-series 17, 28, or 29 sync cable is used for off-camera flash photography, correct exposure may not be achieved in i-TTL mode. We recommend that you choose spot metering to select standard i-TTL flash control. Take a test shot and view the results in the monitor.

In i-TTL, use the flash panel or bounce adapter provided with the flash unit. Do not use other panels such as diffusion panels, as this may produce incorrect exposure.

If the controls on the optional SB-900, SB-800, SB-600, or SU-800 flash unit are used to set flash compensation,  $\text{Ⓢ}$  will appear in the information display.

The SB-900, SB-800, SB-600, and SB-400 provide red-eye reduction, while the SB-900, SB-800, SB-600, and SU-800 provide AF-assist illumination with the following restrictions:

- **SB-900:** AF-assist illumination is available for all focus points; with 17–135 mm AF lenses, however, autofocus is available only with the focus points shown at right.

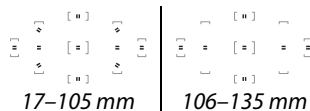

- **SB-800, SB-600 and SU-800:** With 24–105 mm AF lenses, AF-assist illumination is available only with the focus points shown at right.

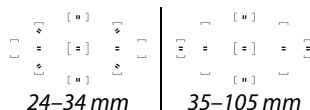

With other flash units, the camera AF-assist illuminator is used for AF-assist illumination and red-eye reduction.



# Other Accessories

At the time of writing, the following accessories were available for the D3100.

<b>Power sources</b>	<ul style="list-style-type: none"><li>• <b>Rechargeable Li-ion Battery EN-EL14</b> (☞ 14–15): Additional EN-EL14 batteries are available from local retailers and Nikon-authorized service representatives.</li><li>• <b>Battery Charger MH-24</b> (☞ 14): Recharge EN-EL14 batteries.</li><li>• <b>Power Connector EP-5A, AC Adapter EH-5a</b>: These accessories can be used to power the camera for extended periods (EH-5 AC adapters can also be used). A power connector EP-5A is required to connect the camera to the EH-5a or EH-5; see page 178 for details.</li></ul>
<b>USB cable</b>	<b>USB Cable UC-E4</b> : Connect the camera to a computer or printer.
<b>A/V cable</b>	<b>Audio Video Cable EG-D2</b> : Connect the camera to a TV.
<b>Filters</b>	<ul style="list-style-type: none"><li>• Use Nikon filters; filters manufactured by other makers may interfere with autofocus or the electronic rangefinder.</li><li>• The D3100 can not be used with linear polarizing filters. Use the C-PL circular polarizing filter instead.</li><li>• NC filters are recommended for protecting the lens.</li><li>• To prevent ghosting, use of a filter is not recommended when the subject is framed against a bright light, or when a bright light source is in the frame.</li><li>• Center-weighted metering is recommended with filters with exposure factors (filter factors) over <math>1 \times</math> (Y44, Y48, Y52, O56, R60, X0, X1, C-PL, ND2S, ND4, ND4S, ND8, ND8S, ND400, A2, A12, B2, B8, B12). See the filter manual for details.</li></ul>
<b>Viewfinder eyepiece accessories</b>	<ul style="list-style-type: none"><li>• <b>DK-20C Eyepiece Correction Lenses</b>: Lenses are available with diopters of <math>-5, -4, -3, -2, 0, +0.5, +1, +2,</math> and <math>+3 \text{ m}^{-1}</math> when the camera diopter adjustment control is in the neutral position (<math>-1 \text{ m}^{-1}</math>). Use eyepiece correction lenses only if the desired focus can not be achieved with the built in diopter adjustment control (<math>-1.7</math> to <math>+0.5 \text{ m}^{-1}</math>). Test eyepiece correction lenses before purchase to ensure that the desired focus can be achieved. The rubber eyecup can not be used with eyepiece correction lenses.</li><li>• <b>Magnifier DG-2</b>: The DG-2 magnifies the scene displayed in the center of the viewfinder for greater precision during focusing. Eyepiece adapter required (available separately).</li><li>• <b>Eyepiece Adapter DK-22</b>: The DK-22 is used when attaching the DG-2 magnifier.</li><li>• <b>Right-Angle Viewing Attachment DR-6</b>: The DR-6 attaches at a right angle to the viewfinder eyepiece, allowing the image in the viewfinder to be viewed at right angles to the lens (for example, from directly above when the camera is horizontal).</li></ul>



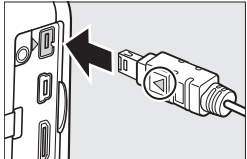

<b>Software</b>	<b>Capture NX 2:</b> A complete photo editing package offering such features as white balance adjustment and color control points. <b>Note:</b> Use the latest versions of Nikon software. Most Nikon software offers an auto update feature when the computer is connected to the Internet. See the websites listed on page xiv for the latest information on supported operating systems.
<b>Body cap</b>	<b>BF-1B and BF-1A Body Caps:</b> The body cap keeps the mirror, viewfinder screen, and low-pass filter free of dust when a lens is not in place.
<b>Accessory terminal accessories</b>	The D3100 is equipped with an accessory terminal for <b>MC-DC2 remote cords</b> (□ 78) and <b>GP-1 GPS units</b> (□ 98), which connect with the ◀ mark on the connector aligned with the ▶ next to the accessory terminal (close the connector cover when the terminal is not in use). 

## Approved Memory Cards

The following SD memory cards have been tested and approved for use in the D3100. Cards with class 6 or faster write speeds are recommended for movie recording. Recording may end unexpectedly when cards with slower write speeds are used.

	SD memory cards	SDHC memory cards <sup>2</sup>	SDXC memory cards <sup>3</sup>
<b>SanDisk</b>	512 MB, 1 GB, 2 GB <sup>1</sup>	4 GB, 8 GB, 16 GB	64 GB
<b>Toshiba</b>		4 GB, 8 GB, 16 GB, 32 GB	
<b>Panasonic</b>		4 GB, 6 GB, 8 GB, 12 GB, 16 GB, 32 GB	48 GB, 64 GB
<b>Lexar Media</b>		4 GB, 8 GB	—
<b>Platinum II</b>			
<b>Professional</b>	4 GB, 8 GB, 16 GB, 32 GB		

- 1 Check that any card readers or other devices with which the card will be used support 2 GB cards.
- 2 Check that any card readers or other devices with which the card will be used are SDHC-compliant.
- 3 Check that any card readers or other devices with which the card will be used are SDXC-compliant.



Other cards have not been tested. For more details on the above cards, please contact the manufacturer.



# Attaching a Power Connector and AC Adapter

Turn the camera off before attaching an optional power connector and AC adapter.

## 1 Ready the camera.

Open the battery-chamber (①) and power connector (②) covers.

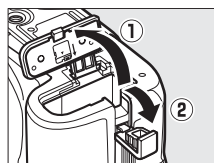

## 2 Insert the EP-5A power connector.

Be sure to insert the connector in the correct orientation.

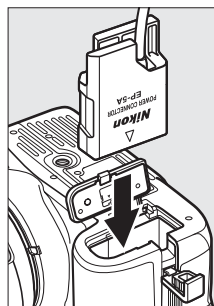

## 3 Close the battery-chamber cover.

Position the power connector cable so that it passes through the power connector slot and close the battery-chamber cover.

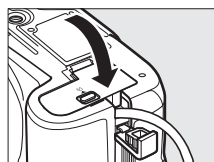

## 4 Connect the AC adapter.

Connect the AC adapter power cable to the AC socket on AC adapter (③) and the EP-5A power cable to the DC socket (④). A  icon is displayed in the monitor when the camera is powered by the AC adapter and power connector.

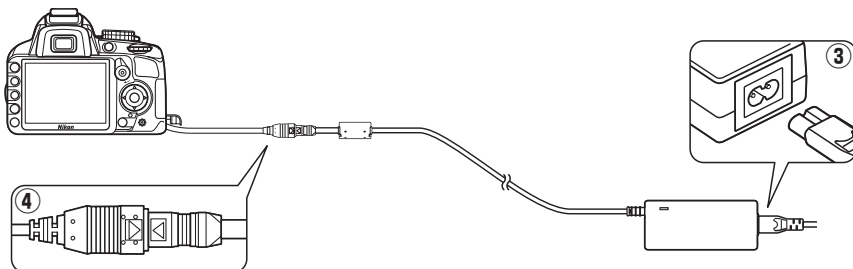

# Caring for the Camera

## Storage

When the camera will not be used for an extended period, remove the battery and store it in a cool, dry area with the terminal cover in place. To prevent mold or mildew, store the camera in a dry, well-ventilated area. Do not store your camera with naphtha or camphor moth balls or in locations that:

- are poorly ventilated or subject to humidities of over 60%
- are next to equipment that produces strong electromagnetic fields, such as televisions or radios
- are exposed to temperatures above 50 °C (122 °F) or below –10 °C (14 °F)

## Cleaning

<b>Camera body</b>	Use a blower to remove dust and lint, then wipe gently with a soft, dry cloth. After using the camera at the beach or seaside, wipe off sand or salt with a cloth lightly dampened in distilled water and dry thoroughly. <b>Important:</b> <i>Dust or other foreign matter inside the camera may cause damage not covered under warranty.</i>
<b>Lens, mirror, and viewfinder</b>	These glass elements are easily damaged. Remove dust and lint with a blower. If using an aerosol blower, keep the can vertical to prevent the discharge of liquid. To remove fingerprints and other stains, apply a small amount of lens cleaner to a soft cloth and clean with care.
<b>Monitor</b>	Remove dust and lint with a blower. When removing fingerprints and other stains, wipe the surface lightly with a soft cloth or chamois leather. Do not apply pressure, as this could result in damage or malfunction.

*Do not use alcohol, thinner, or other volatile chemicals.*

### **Servicing the Camera and Accessories**

The camera is a precision device and requires regular servicing. Nikon recommends that the camera be inspected by the original retailer or Nikon-authorized service representative once every one to two years, and that it be serviced once every three to five years (note that fees apply to these services). Frequent inspection and servicing are particularly recommended if the camera is used professionally. Any accessories regularly used with the camera, such as lenses or optional flash units, should be included when the camera is inspected or serviced.



# The Low-Pass Filter

The image sensor that acts as the camera's picture element is fitted with a low-pass filter to prevent moiré. If you suspect that dirt or dust on the filter is appearing in photographs, you can clean the filter using the **Clean image sensor** option in the setup menu. The filter can be cleaned at any time using the **Clean now** option, or cleaning can be performed automatically when the camera is turned on or off.

## ■ ■ "Clean Now"

### 1 Place the camera base down.

Image sensor cleaning is most effective when the camera is placed base down as shown at right.

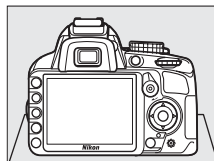

### 2 Display the Clean image sensor menu.

Press the **MENU** button to display the menus. Highlight **Clean image sensor** in the setup menu (☰ 136) and press ►.

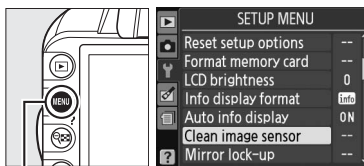

MENU button

### 3 Select Clean now.

Highlight **Clean now** and press **OK**.

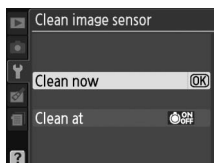



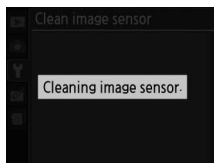

The message shown at right will be displayed while cleaning is in progress.



## ■ “Clean At”

Choose from the following options:

Option	Description
 <b>Startup</b>	The image sensor is automatically cleaned each time the camera is turned on.
 <b>Shutdown</b>	The image sensor is automatically cleaned during shutdown each time the camera is turned off.
 <b>Startup &amp; shutdown</b>	The image sensor is cleaned automatically at startup and at shutdown.
 <b>Cleaning off</b>	Automatic image sensor cleaning off.

### 1 Select Clean at.

Display the **Clean image sensor** menu as described in Step 2 on the previous page. Highlight **Clean at** and press .

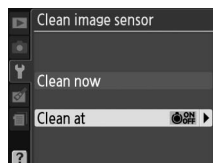

### 2 Select an option.

Highlight an option and press .

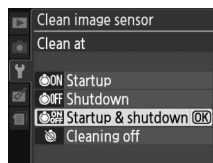

#### **Image Sensor Cleaning**

Using camera controls interrupts image sensor cleaning. Image sensor cleaning may not be performed at startup if the flash is charging.

Cleaning is performed by vibrating the low-pass filter. If dust can not be fully removed using the options in the **Clean image sensor** menu, clean the image sensor manually (182) or consult a Nikon-authorized service representative.

If image sensor cleaning is performed several times in succession, image sensor cleaning may be temporarily disabled to protect the camera's internal circuitry. Cleaning can be performed again after a short wait.



## Manual Cleaning

If foreign matter can not be removed from the low-pass filter using the **Clean image sensor** option in the setup menu (☐ 180), the filter can be cleaned manually as described below. Note, however, that the filter is extremely delicate and easily damaged. Nikon recommends that the filter be cleaned only by Nikon-authorized service personnel.

### 1 Charge the battery or connect an AC adapter.

A reliable power source is required when inspecting or cleaning the low-pass filter. Turn the camera off and insert a fully-charged EN-EL14 battery or connect an optional EP-5A power connector and EH-5a AC adapter.

### 2 Remove the lens.

Turn the camera off and remove the lens.

### 3 Select Mirror lock-up.

Turn the camera on and press the **MENU** button to display the menus. Highlight **Mirror lock-up** in the setup menu and press **▶** (note that this option is not available at battery levels of  or below).

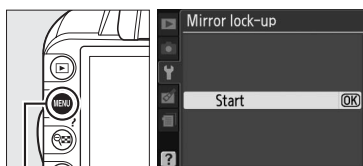

MENU button

### 4 Press **OK**.

The message shown at right will be displayed in the monitor. To restore normal operation without inspecting the low-pass filter, turn the camera off.

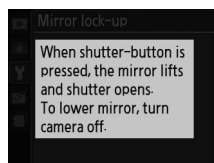

### 5 Raise the mirror.

Press the shutter-release button all the way down. The mirror will be raised and the shutter curtain will open, revealing the low-pass filter.



### 6 Examine the low-pass filter.

Holding the camera so that light falls on the low-pass filter, examine the filter for dust or lint. If no foreign objects are present, proceed to Step 8.

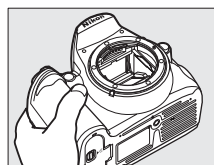

---

## 7 Clean the filter.

Remove any dust and lint from the filter with a blower. Do not use a blower-brush, as the bristles could damage the filter. Dirt that can not be removed with a blower can only be removed by Nikon-authorized service personnel. Under no circumstances should you touch or wipe the filter.

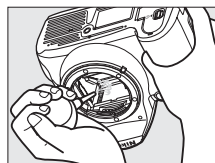

---

## 8 Turn the camera off.

The mirror will return to the down position and the shutter curtain will close. Replace the lens or body cap.

### Use a Reliable Power Source

The shutter curtain is delicate and easily damaged. If the camera powers off while the mirror is raised, the curtain will close automatically. To prevent damage to the curtain, observe the following precautions:

- Do not turn the camera off or remove or disconnect the power source while the mirror is raised.
- If the battery runs low while the mirror is raised, a beep will sound and the self-timer lamp will blink to warn that the shutter curtain will close and the mirror will be lowered after about two minutes. End cleaning or inspection immediately.

### Foreign Matter on the Low-Pass Filter

Nikon takes every possible precaution to prevent foreign matter from coming into contact with the low-pass filter during production and shipping. The D3100, however, is designed to be used with interchangeable lenses, and foreign matter may enter the camera when lenses are removed or exchanged. Once inside the camera, this foreign matter may adhere to the low-pass filter, where it may appear in photographs taken under certain conditions. To protect the camera when no lens is in place, be sure to replace the body cap provided with the camera, being careful to first remove all dust and other foreign matter that may be adhering to the body cap. Avoid exchanging lenses in dusty environments.

Should foreign matter find its way onto the low-pass filter, clean the filter as described above, or have the filter cleaned by authorized Nikon service personnel. Photographs affected by the presence of foreign matter on the filter can be retouched using Capture NX 2 (available separately; □ 177) or the clean image options available in some third-party imaging applications.



# Caring for the Camera and Battery:

## Cautions

**Do not drop:** The product may malfunction if subjected to strong shocks or vibration.

**Keep dry:** This product is not waterproof, and may malfunction if immersed in water or exposed to high levels of humidity. Rusting of the internal mechanism can cause irreparable damage.

**Avoid sudden changes in temperature:** Sudden changes in temperature, such as those that occur when entering or leaving a heated building on a cold day, can cause condensation inside the device. To prevent condensation, place the device in a carrying case or plastic bag before exposing it to sudden changes in temperature.

**Keep away from strong magnetic fields:** Do not use or store this device in the vicinity of equipment that generates strong electromagnetic radiation or magnetic fields. Strong static charges or the magnetic fields produced by equipment such as radio transmitters could interfere with the monitor, damage data stored on the memory card, or affect the product's internal circuitry.

**Do not leave the lens pointed at the sun:** Do not leave the lens pointed at the sun or other strong light source for an extended period. Intense light may cause the image sensor to deteriorate or produce a white blur effect in photographs.

**Turn the product off before removing or disconnecting the power source:** Do not unplug the product or remove the battery while the product is on or while images are being recorded or deleted. Forcibly cutting power in these circumstances could result in loss of data or in damage to product memory or internal circuitry. To prevent an accidental interruption of power, avoid carrying the product from one location to another while the AC adapter is connected.

**Cleaning:** When cleaning the camera body, use a blower to gently remove dust and lint, then wipe gently with a soft, dry cloth. After using the camera at the beach or seaside, wipe off any sand or salt using a cloth lightly dampened in pure water and then dry the camera thoroughly.

The lens and mirror are easily damaged. Dust and lint should be gently removed with a blower. When using an aerosol blower, keep the can vertical to prevent discharge of liquid. To remove fingerprints and other stains from the lens, apply a small amount of lens cleaner to a soft cloth and wipe the lens carefully.

See "The Low-Pass Filter" (📖 180, 182) for information on cleaning the low-pass filter.

**Do not touch the shutter curtain:** The shutter curtain is extremely thin and easily damaged. Under no circumstances should you exert pressure on the curtain, poke it with cleaning tools, or subject it to powerful air currents from a blower. These actions could scratch, deform, or tear the curtain.

**Storage:** To prevent mold or mildew, store the camera in a dry, well-ventilated area. If you are using an AC adapter, unplug the adapter to prevent fire. If the product will not be used for an extended period, remove the battery to prevent leakage and store the camera in a plastic bag containing a desiccant. Do not, however, store the camera case in a plastic bag, as this may cause the material to deteriorate. Note that desiccant gradually loses its capacity to absorb moisture and should be replaced at regular intervals.





To prevent mold or mildew, take the camera out of storage at least once a month. Turn the camera on and release the shutter a few times before putting it away.

Store the battery in a cool, dry place. Replace the terminal cover before putting the battery away.

**Notes on the monitor:** The monitor may contain a few pixels that are always lit or that do not light. This is common to all TFT LCD monitors and does not indicate a malfunction. Images recorded with the product are unaffected.

Images in the monitor may be difficult to see in a bright light.

Do not apply pressure to the monitor, as this could cause damage or malfunction. Dust or lint on the monitor can be removed with a blower. Stains can be removed by wiping lightly with a soft cloth or chamois leather. Should the monitor break, care should be taken to avoid injury from broken glass and to prevent liquid crystal from the monitor touching the skin or entering the eyes and mouth.

**Moiré:** Moiré is an interference pattern created by the interaction of an image containing a regular, repeating grid, such as the pattern of weave in cloth or windows in a building, with the camera image sensor grid. If you notice moiré in your photographs, try changing the distance to the subject, zooming in and out, or changing the angle between the subject and the camera.

**Batteries:** Batteries may leak or explode if improperly handled. Observe the following precautions when handling batteries:

- Use only batteries approved for use in this equipment.
- Do not expose the battery to flame or excessive heat.
- Keep the battery terminals clean.
- Turn the product off before replacing the battery.
- Remove the battery from the camera or charger when not in use and replace the terminal cover. These devices draw minute amounts of charge even when off and could draw the battery down to the point that it will no longer function. If the battery will not be used for some time, insert it in the camera and run it flat before removing it and storing it in a location with an ambient temperature of 15 to 25 °C (59 to 77 °F; avoid hot or extremely cold locations). Repeat this process at least once every six months.
- The internal temperature of the battery may rise while the battery is in use. Attempting to charge the battery while the internal temperature is elevated will impair battery performance, and the battery may not charge or charge only partially. Wait for the battery to cool before charging.
- Continuing to charge the battery after it is fully charged can impair battery performance.
- A marked drop in the time a fully charged battery retains its charge when used at room temperature indicates that it requires replacement. Purchase a new EN-EL14 battery.
- Charge the battery before use. When taking photographs on important occasions, ready a spare EN-EL14 battery and keep it fully charged. Depending on your location, it may be difficult to purchase replacement batteries on short notice. Note that on cold days, the capacity of batteries tends to decrease. Be sure the battery is fully charged before taking photographs outside in cold weather. Keep a spare battery in a warm place and exchange the two as necessary. Once warmed, a cold battery may recover some of its charge.
- Used batteries are a valuable resource; recycle in accord with local regulations.



# Available Settings

The following table lists the settings that can be adjusted in each mode. Defaults can be restored with **Reset shooting options** (□ 131).

										P	S	A	M	
Shooting menu	Set Picture Control	—	—	—	—	—	—	—	—	✓	✓	✓	✓	
	Image quality	✓	✓	✓	✓	✓	✓	✓	✓	✓	✓	✓	✓	
	Image size	✓	✓	✓	✓	✓	✓	✓	✓	✓	✓	✓	✓	
	White balance	—	—	—	—	—	—	—	—	✓	✓	✓	✓	
	ISO sensitivity settings	—	—	✓	✓	✓	✓	✓	✓	✓	✓	✓	✓	
	Active D-Lighting	—	—	—	—	—	—	—	—	✓	✓	✓	✓	
	Auto distortion control	✓	✓	✓	✓	✓	✓	✓	✓	✓	✓	✓	✓	
	Color space	✓	✓	✓	✓	✓	✓	✓	✓	✓	✓	✓	✓	
	Noise reduction	✓	✓	✓	✓	✓	✓	✓	✓	✓	✓	✓	✓	
	AF-area mode	Viewfinder	✓ <sup>1</sup>	✓ <sup>1</sup>	✓ <sup>1</sup>	✓ <sup>1</sup>	✓ <sup>1</sup>	✓ <sup>1</sup>	✓ <sup>1</sup>	✓ <sup>1</sup>	✓	✓	✓	✓
		Live view/movie	—	—	✓ <sup>1</sup>	✓ <sup>1</sup>	✓ <sup>1</sup>	✓ <sup>1</sup>	✓ <sup>1</sup>	✓ <sup>1</sup>	✓	✓	✓	✓
	AF-assist	✓	✓	✓	—	✓	—	✓	✓	✓	✓	✓	✓	
	Metering	—	—	—	—	—	—	—	—	✓	✓	✓	✓	
	Movie settings	✓	✓	✓	✓	✓	✓	✓	✓	✓	✓	✓	✓	
	Built-in flash/Optional flash	—	—	—	—	—	—	—	—	✓	✓	✓	✓	
Other settings	AE-L/AF-L button hold	—	—	✓	✓	✓	✓	✓	✓	✓	✓	✓	✓	
	Focus mode	✓	✓	✓	✓	✓	✓	✓	✓	✓	✓	✓	✓	
	Flexible program	—	—	—	—	—	—	—	—	✓	—	—	—	
	Exposure compensation	—	—	—	—	—	—	—	—	✓	✓	✓	✓	
	Flash mode	✓ <sup>1</sup>	—	✓ <sup>1</sup>	—	✓ <sup>1</sup>	—	✓ <sup>1</sup>	✓ <sup>1</sup>	✓	✓	✓	✓	
Flash compensation	—	—	—	—	—	—	—	—	✓	✓	✓	✓		

1 Reset when mode dial is rotated to new setting.



# Memory Card Capacity

The following table shows the approximate number of pictures that can be stored on a 4 GB SanDisk Extreme SDHC card at different image quality and size settings.

Image quality	Image size	File size <sup>1</sup>	No. of images <sup>1</sup>	Buffer capacity <sup>2</sup>
NEF (RAW)+ JPEG fine <sup>3</sup>	L	19.8 MB	151	9
NEF (RAW)	—	12.9 MB	226	13
JPEG fine	L	6.8 MB	460	100
	M	3.9 MB	815	100
	S	1.8 MB	1700	100
JPEG normal	L	3.4 MB	914	100
	M	2.0 MB	1500	100
	S	0.9 MB	3300	100
JPEG basic	L	1.7 MB	1700	100
	M	1.0 MB	3000	100
	S	0.5 MB	6000	100

1 All figures are approximate. File size varies with scene recorded.

2 Maximum number of exposures that can be stored in memory buffer at ISO 100. Drops when noise reduction (☐ 134) is on.

3 Image size applies to JPEG images only. Size of NEF (RAW) images can not be changed. File size is the total for NEF (RAW) and JPEG images.



# Troubleshooting

If the camera fails to function as expected, check the list of common problems below before consulting your retailer or Nikon representative.

## Display

**Viewfinder is out of focus:** Adjust viewfinder focus or use optional eyepiece correction lenses (□ 22, 176).

**Displays turn off without warning:** Choose longer delays for **Auto off timers** (□ 143).

**Information display does not appear in monitor:** Shutter-release button is pressed halfway. If information display does not appear when you remove your finger from shutter-release button, confirm that **On** is selected for **Auto info display** (□ 139) and that battery is charged.

**Camera does not respond to controls:** See “A Note on Electronically-Controlled Cameras,” below.

**Viewfinder display is unresponsive and dim:** The response times and brightness of this display vary with temperature.

### **A Note on Electronically-Controlled Cameras**

In extremely rare instances, unusual characters may appear in the monitor and the camera may stop functioning. In most cases, this phenomenon is caused by a strong external static charge. Turn the camera off, remove and replace the battery, taking care to avoid burns, and turn the camera on again, or, if you are using an AC adapter (available separately), disconnect and reconnect the adapter and turn the camera on again. If the problem persists after removing the battery from the camera, contact your retailer or Nikon-authorized service representative.

## Shooting (All Modes)

**Camera takes time to turn on:** Delete files or folders.

### **Shutter-release disabled:**

- Memory card is locked, full, or not inserted (□ 20, 24).
- Built-in flash is charging (□ 27).
- Camera is not in focus (□ 26).
- CPU lens with aperture ring attached but aperture not locked at highest f-number (□ 168).
- Non-CPU lens is attached but camera is not in mode **M** (□ 169).

**Final photo is larger than area shown in viewfinder:** Viewfinder horizontal and vertical frame coverage is approximately 95%.

### **Photos are out of focus:**

- AF-S or AF-I lens is not attached: use AF-S or AF-I lens or focus manually.
- Camera unable to focus using autofocus: use manual focus or focus lock (□ 60, 62).
- Camera is in manual focus mode: focus manually (□ 62).



---

**Focus does not lock when shutter-release button is pressed halfway:** Use **AE-L/AF-L** button to lock focus when live view is off and **AF-C** is selected for focus mode or when photographing moving subjects in **AF-A** mode (□ 60).

---

**Can not select focus point:**

- **[ ] Auto-area AF** selected for **AF-area mode > Viewfinder** (□ 58), or **Face-priority AF** selected for **AF-area mode > Live view/movie** (□ 38): choose another mode.
- Press shutter-release button halfway to turn monitor off or activate exposure meters (□ 27).

**Subject-tracking AF not available:** Select a non-monochrome Picture Control (□ 94).

---

**Can not select AF-area mode:** Manual focus selected (□ 38, 55).

---

**Image size can not be changed:** **Image quality** set to **NEF (RAW)** or **NEF (RAW) + JPEG fine** (□ 65).

---

**Camera is slow to record photos:** Turn noise reduction off (□ 134).

---

**Noise (randomly-spaced bright pixels, fog, or lines) appear in photos:**

- Choose lower ISO sensitivity or turn noise reduction on (□ 134).
- Shutter speed is slower than 8 s: use noise reduction (□ 134).

**Smudges appear in photographs:** Clean front and rear lens elements. If problem persists, perform image sensor cleaning (□ 180).

---

**Date is not imprinted on photos:** Image quality set to **NEF (RAW)** or **NEF (RAW) + JPEG fine** (□ 65, 147).

---

**Sound is not recorded with movies:** **Off** is selected for **Movie settings > Sound** (□ 47).

---

**Flicker or banding appears during live view or movie recording:** Choose an option for **Flicker reduction** that matches the frequency of the local AC power supply (□ 139).

---

**Menu item can not be selected:** Some options are not available in all modes.

---



## Shooting (P, S, A, M)

---

### **Shutter-release disabled:**

- Non-CPU lens is attached: rotate camera mode dial to **M** (☐ 169).
  - Mode dial rotated to **S** after shutter speed of “bulb” selected in mode **M**: choose new shutter speed (☐ 75).
- 

**Full range of shutter speeds not available:** Flash in use (☐ 70).

---

### **Colors are unnatural:**

- Adjust white balance to match light source (☐ 87).
  - Adjust **Set Picture Control** settings (☐ 94).
- 

**Can not measure white balance:** Subject is too dark or too bright (☐ 91).

---

**Image can not be selected as source for preset white balance:** Image was not created with D3100 (☐ 93).

---

**Effects of Picture Control differ from image to image:** **A** (auto) is selected for sharpening, contrast, or saturation. For consistent results over a series of photos, choose another setting (☐ 96).

---

**Can not adjust contrast and brightness for selected Picture Control:** Active D-Lighting is on. Turn Active D-Lighting off before adjusting contrast or brightness (☐ 85, 96).

---

**Metering can not be changed:** Autoexposure lock is in effect (☐ 80).

---

**Exposure compensation can not be used:** Choose mode **P**, **S**, or **A** (☐ 73, 81).

---

**Only one shot taken each time shutter-release button is pressed in continuous shooting mode:** Lower built-in flash (☐ 53, 67).

---

**Noise (reddish areas or other artifacts) appears in long time-exposures:** Turn noise reduction on (☐ 134).

---

## Playback

---

**Flashing areas, shooting data, or graphs appear on images:** Press ▲ or ▼ to choose photo information displayed, or change settings for **Display mode** (☐ 100, 130).

---

**NEF (RAW) image is not played back:** Photo was taken at image quality of **NEF (RAW) + JPEG fine** (☐ 65).

---

**Some pictures are not displayed during playback:** Select **All** for **Playback folder**. Note that **Current** is automatically selected after photograph is taken (☐ 129).

---

**“Tall” (portrait) orientation photos are displayed in “wide” (landscape) orientation:**

- Select **On** for **Rotate tall** (☐ 130).
  - Photo was taken with **Off** selected for **Auto image rotation** (☐ 141).
  - Camera orientation was changed while shutter-release button was pressed in continuous release mode or camera was pointed up or down when photo was taken (☐ 53).
  - Photo is displayed in image review (☐ 130).
- 



---

**Can not delete picture:**

- Picture is protected: remove protection (☞ 108).
- Memory card is locked (☞ 20).

---

**Can not retouch picture:** Photo can not be further edited with this camera (☞ 151).

---

**Can not change print order:**

- Memory card is full: delete pictures (☞ 24, 109).
- Memory card is locked (☞ 20).

---

**Can not select photo for printing:** Photo is in NEF (RAW) format. Create JPEG copy using **NEF (RAW) processing** or transfer to computer and print using supplied software or Capture NX 2 (☞ 115, 160).

---

**Picture is not displayed on TV:**

- Choose correct video mode (☞ 139) or output resolution (☞ 128).
- A/V (☞ 126) or HDMI (☞ 127) cable is not correctly connected.

---

**Can not transfer photos to computer:** OS not compatible with camera or transfer software. Use card reader to copy photos to computer (☞ 115).

---

**NEF (RAW) photos not displayed in Capture NX 2:** Update to latest version (☞ 177).

---

**Image Dust Off option in Capture NX 2 does not have desired effect:** Image sensor cleaning changes the position of dust on the low-pass filter. Dust off reference data recorded before image sensor cleaning is performed can not be used with photographs taken after image sensor cleaning is performed. Dust off reference data recorded after image sensor cleaning is performed can not be used with photographs taken before image sensor cleaning is performed (☞ 142).

---

## Miscellaneous

---

**Date of recording is not correct:** Set camera clock (☞ 18, 139).



---









**Menu item can not be selected:** Some options are not available at certain combinations of settings or when no memory card is inserted (☞ 20, 151, 186).

# Error Messages

This section lists the indicators and error messages that appear in the viewfinder and monitor.

## Warning Icons

A flashing  in the monitor or  in the viewfinder indicates that a warning or error message can be displayed in the monitor by pressing the  button.

Indicator		Solution	
Monitor	Viewfinder		
<b>Lock lens aperture ring at minimum aperture (largest f/-number).</b>	 (blinks)	Set lens aperture ring to minimum aperture (largest f-number).	17, 168
<b>Lens not attached.</b>	 (blinks)	<ul style="list-style-type: none"> <li>Attach non-IX NIKKOR lens.</li> <li>If non-CPU lens is attached, select mode <b>M</b>.</li> </ul>	167 77
<b>Shutter release disabled. Recharge battery.</b>	 (blinks)	Turn camera off and recharge or replace battery.	14, 15
<b>This battery cannot be used. Choose battery designated for use in this camera.</b>		Use Nikon-approved battery.	176
<b>Initialization error. Turn camera off and then on again.</b>		Turn camera off, remove and replace battery, and then turn camera on again.	3, 15
<b>Battery level is low. Complete operation and turn camera off immediately.</b>	—	End cleaning and turn camera off and recharge or replace battery.	183
<b>Clock not set.</b>	—	Set camera clock.	18, 139
<b>No SD card inserted.</b>	 (blinks)	Turn camera off and confirm that card is correctly inserted.	20
<b>Memory card is locked. Slide lock to “write” position.</b>	 (blinks)	Memory card is locked (write protected). Slide card write-protect switch to “write” position.	20
<b>This memory card cannot be used. Card may be damaged. Insert another card.</b>	 (blinks)	<ul style="list-style-type: none"> <li>Use approved card.</li> <li>Format card. If problem persists, card may be damaged. Contact Nikon-authorized service representative.</li> <li>Error creating new folder. Delete files or insert new memory card.</li> <li>Insert new memory card.</li> <li>Eye-Fi card is still emitting wireless signal after <b>Disable</b> has been selected for <b>Eye-Fi upload</b>. To terminate wireless transmission, turn the camera off and remove the card.</li> </ul>	177 21 31, 109 20 150
<b>Not available if Eye-Fi card is locked.</b>	 (blinks)	Eye-Fi card is locked (write protected). Slide card write-protect switch to “write” position.	20



Indicator		Solution	📖
Monitor	Viewfinder		
<b>This card is not formatted. Format the card.</b>	(F or ?) (blinks)	Format card or turn camera off and insert new memory card.	21
<b>Card is full</b>	FuL/0/? (blinks)	<ul style="list-style-type: none"> <li>• Reduce quality or size.</li> <li>• Delete photographs.</li> <li>• Insert new memory card.</li> </ul>	64 31, 109 20
—	● (blinks)	Camera can not focus using autofocus. Change composition or focus manually.	26, 56, 62
<b>Subject is too bright.</b>	Hi	<ul style="list-style-type: none"> <li>• Use a lower ISO sensitivity.</li> <li>• Use commercial ND filter.</li> <li>• In mode: <ul style="list-style-type: none"> <li>S Increase shutter speed</li> <li>A Choose a smaller aperture (larger f-number)</li> </ul> </li> </ul>	71 — 75 76
<b>Subject is too dark.</b>	Lo	<ul style="list-style-type: none"> <li>• Use a higher ISO sensitivity.</li> <li>• Use flash.</li> <li>• In mode: <ul style="list-style-type: none"> <li>S Lower shutter speed</li> <li>A Choose a larger aperture (smaller f-number)</li> </ul> </li> </ul>	71 67 75 76
<b>No Bulb in S mode.</b>	bulb (blinks)	Change shutter speed or select manual exposure mode.	75, 77
—	⚡ (blinks)	Flash has fired at full power. Check photo in monitor; if underexposed, adjust settings and try again.	—
<b>Flash is in TTL mode. Choose another setting or use a CPU lens.</b>	⚡/? (blinks)	Change flash mode setting on optional flash unit or use CPU lens.	167
—	⚡/? (blinks)	<ul style="list-style-type: none"> <li>• Use the flash.</li> <li>• Change distance to subject, aperture, flash range, or ISO sensitivity.</li> <li>• Lens focal length is less than 18 mm: use a longer focal length.</li> <li>• Optional SB-400 flash unit attached: flash is in bounce position or focus distance is very short. Continue shooting; if necessary, increase focus distance to prevent shadows from appearing in photograph.</li> </ul>	67 70, 71, 76 — —
<b>Flash error</b>	? (blinks)	Error occurred updating firmware for optional flash unit. Contact Nikon-authorized service representative.	—



Indicator		Solution	📖
Monitor	Viewfinder		
<b>Error. Press shutter release button again.</b>	Err (blinks)	Release shutter. If error persists or appears frequently, consult Nikon-authorized service representative.	—
<b>Start-up error. Contact a Nikon-authorized service representative.</b>		Consult Nikon-authorized service representative.	—
<b>Autoexposure error</b>			
<b>Unable to start live view. Please wait.</b>	—	Wait for the internal circuits to cool before resuming live view or movie recording.	42, 48
<b>Folder contains no images.</b>	—	Folder selected for playback contains no images. Insert another memory card or select a different folder.	20, 129
<b>Cannot display this file.</b>	—	File has been created or modified using a computer or different make of camera, or file is corrupt.	152
<b>Cannot select this file.</b>			
<b>No image for retouching.</b>	—	Memory card does not contain NEF (RAW) images for use with <b>NEF (RAW) processing</b> .	160
<b>Check printer.</b>	—	Check printer. To resume, select <b>Continue</b> (if available).	—*
<b>Check paper.</b>	—	Paper is not selected size. Insert paper of correct size and select <b>Continue</b> .	—*
<b>Paper jam.</b>	—	Clear jam and select <b>Continue</b> .	—*
<b>Out of paper.</b>	—	Insert paper of selected size and select <b>Continue</b> .	—*
<b>Check ink supply.</b>	—	Check ink. To resume, select <b>Continue</b> .	—*
<b>Out of ink.</b>	—	Replace ink and select <b>Continue</b> .	—*

\* See printer manual for more information.















# Specifications





## ■ Nikon D3100 Digital Camera

<b>Type</b>	
Type	Single-lens reflex digital camera
Lens mount	Nikon F mount (with AF contacts)
Effective angle of view	Approx. $1.5 \times$ lens focal length (Nikon DX format)
<b>Effective pixels</b>	
Effective pixels	14.2 million
<b>Image sensor</b>	
Image sensor	23.1 $\times$ 15.4 mm CMOS sensor
Total pixels	14.8 million
Dust-reduction System	Image sensor cleaning, Image Dust Off reference data (optional Capture NX 2 software required)
<b>Storage</b>	
Image size (pixels)	<ul style="list-style-type: none"><li>• 4,608 <math>\times</math> 3,072 (L)</li><li>• 2,304 <math>\times</math> 1,536 (S)</li><li>• 3,456 <math>\times</math> 2,304 (M)</li></ul>
File format	<ul style="list-style-type: none"><li>• <b>NEF (RAW)</b></li><li>• <b>JPEG:</b> JPEG-Baseline compliant with fine (approx. 1 : 4), normal (approx. 1 : 8), or basic (approx. 1 : 16) compression</li><li>• <b>NEF (RAW)+JPEG:</b> Single photograph recorded in both NEF (RAW) and JPEG formats</li></ul>
Picture Control System	Standard, Neutral, Vivid, Monochrome, Portrait, Landscape; selected Picture Control can be modified
Media	SD (Secure Digital), SDHC, and SDXC memory cards
File system	DCF (Design Rule for Camera File System) 2.0, DPOF (Digital Print Order Format), Exif 2.21 (Exchangeable Image File Format for Digital Still Cameras), PictBridge
<b>Viewfinder</b>	
Viewfinder	Eye-level pentamirror single-lens reflex viewfinder
Frame coverage	Approx. 95% horizontal and 95% vertical
Magnification	Approx. $0.8 \times$ (50 mm f/1.4 lens at infinity, $-1.0 \text{ m}^{-1}$ )
Eyepoint	18 mm ( $-1.0 \text{ m}^{-1}$ )
Diopter adjustment	$-1.7$ – $+0.5 \text{ m}^{-1}$
Focusing screen	Type B BriteView Clear Matte Mark VII screen
Reflex mirror	Quick return
Lens aperture	Instant return, electronically controlled





Lens	
<b>Compatible lenses</b>	<ul style="list-style-type: none"> <li>• <b>AF-S or AF-I:</b> All functions supported.</li> <li>• <b>Type G or D AF NIKKOR without built-in autofocus motor:</b> All functions except autofocus supported. IX NIKKOR lenses not supported.</li> <li>• <b>Other AF NIKKOR:</b> All functions supported except autofocus and 3D color matrix metering II. Lenses for F3AF not supported.</li> <li>• <b>Type D PC NIKKOR:</b> All functions supported except autofocus and some shooting modes.</li> <li>• <b>AI-P NIKKOR:</b> All functions supported except autofocus and 3D color matrix metering II.</li> <li>• <b>Non-CPU:</b> Autofocus not supported. Can be used in mode <b>M</b>, but exposure meter does not function.</li> </ul> <p>Electronic rangefinder can be used if lens has a maximum aperture of f/5.6 or faster.</p>
Shutter	
<b>Type</b>	Electronically-controlled vertical-travel focal-plane shutter
<b>Speed</b>	$1/4000$ – 30 s in steps of $1/3$ EV, bulb
<b>Flash sync speed</b>	X = $1/200$ s; synchronizes with shutter at $1/200$ s or slower
Release	
<b>Release mode</b>	 (single frame),  (continuous),  (self-timer),  (quiet shutter release)
<b>Frame advance rate</b>	Up to 3 fps (manual focus, mode <b>M</b> or <b>S</b> , shutter speed $1/250$ s or faster, and other settings at default values)
<b>Self-timer</b>	2 s, 10 s
Exposure	
<b>Metering</b>	TTL exposure metering using 420-pixel RGB sensor
<b>Metering method</b>	<ul style="list-style-type: none"> <li>• <b>Matrix:</b> 3D color matrix metering II (type G and D lenses); color matrix metering II (other CPU lenses)</li> <li>• <b>Center-weighted:</b> Weight of 75% given to 8-mm circle in center of frame</li> <li>• <b>Spot:</b> Meters 3.5-mm circle (about 2.5% of frame) centered on selected focus point</li> </ul>
<b>Range (ISO 100, f/1.4 lens, 20 °C/68 °F)</b>	<ul style="list-style-type: none"> <li>• <b>Matrix or center-weighted metering:</b> 0–20 EV</li> <li>• <b>Spot metering:</b> 2–20 EV</li> </ul>
<b>Exposure meter coupling</b>	CPU
<b>Mode</b>	Auto modes (  auto;  auto (flash off)); scene modes (  portrait;  landscape;  child;  sports;  close up;  night portrait); programmed auto with flexible program ( <b>P</b> ); shutter-priority auto ( <b>S</b> ); aperture-priority auto ( <b>A</b> ); manual ( <b>M</b> )
<b>Exposure compensation</b>	–5 – +5 EV in increments of $1/3$ EV
<b>Exposure lock</b>	Luminosity locked at detected value with <b>AE-L/AF-L</b> button



Exposure	
<b>ISO sensitivity (Recommended Exposure Index)</b>	ISO 100 – 3200 in steps of 1 EV; can also be set to approx. 1 EV above ISO 3200 (ISO 6400 equivalent) or to approx. 2 EV above ISO 3200 (ISO 12800 equivalent); auto ISO sensitivity control available
<b>Active D-Lighting</b>	On, off
Focus	
<b>Autofocus</b>	Nikon Multi-CAM 1000 autofocus sensor module with TTL phase detection, 11 focus points (including one cross-type sensor), and AF-assist illuminator (range approx. 0.5–3 m/1 ft. 8 in.–9 ft. 10 in.)
<b>Detection range</b>	–1 – +19 EV (ISO 100, 20 °C/68 °F)
<b>Lens servo</b>	<ul style="list-style-type: none"> <li>• <b>Autofocus (AF):</b> Single-servo AF (<b>AF-S</b>); continuous-servo AF (<b>AF-C</b>); auto AF-S/AF-C selection (<b>AF-A</b>); predictive focus tracking activated automatically according to subject status</li> <li>• <b>Manual focus (MF):</b> Electronic rangefinder can be used</li> </ul>
<b>Focus point</b>	Can be selected from 11 focus points
<b>AF-area mode</b>	Single-point AF, dynamic-area AF, auto-area AF, 3D-tracking (11 points)
<b>Focus lock</b>	Focus can be locked by pressing shutter-release button halfway (single-servo AF) or by pressing <b>AE-L/AF-L</b> button
Flash	
<b>Built-in flash</b>	 : Auto flash with auto pop-up <b>P, S, A, M:</b> Manual pop-up with button release
<b>Guide Number</b>	Approx. 12/39, 13/43 with manual flash (m/ft, ISO 100, 20 °C/68 °F)
<b>Flash control</b>	<ul style="list-style-type: none"> <li>• <b>TTL:</b> i-TTL balanced fill-flash and standard i-TTL flash for digital SLR using 420-pixel RGB sensor are available with built-in flash and SB-900, SB-800, SB-600, or SB-400 (i-TTL balanced fill-flash is available when matrix or center-weighted metering is selected)</li> <li>• <b>Auto aperture:</b> Available with SB-900/SB-800 and CPU lens</li> <li>• <b>Non-TTL auto:</b> Supported flash units include SB-900, SB-800, SB-80DX, SB-28DX, SB-28, SB-27, and SB-22S</li> <li>• <b>Distance-priority manual:</b> Available with SB-900 and SB-800</li> </ul>
<b>Flash mode</b>	<ul style="list-style-type: none"> <li>• : Auto, auto with red-eye reduction, off; fill-flash and red-eye reduction available with optional flash units</li> <li>• : Auto slow sync, auto slow sync with red-eye reduction, off; slow sync and slow sync with red-eye reduction available with optional flash units</li> <li>• : Fill-flash and red-eye reduction available with optional flash units</li> <li>• <b>P, A:</b> Fill-flash, rear-curtain with slow sync, slow sync, slow sync with red-eye reduction, red-eye reduction</li> <li>• <b>S, M:</b> Fill-flash, rear-curtain sync, red-eye reduction</li> </ul>



<b>Flash</b>	
<b>Flash compensation</b>	-3 – +1 EV in increments of $\frac{1}{3}$ EV
<b>Flash-ready indicator</b>	Lights when built-in flash or optional flash unit such as SB-900, SB-800, SB-600, SB-400, SB-80DX, SB-28DX, or SB-50DX is fully charged; blinks for 3 s after flash is fired at full output
<b>Accessory shoe</b>	ISO 518 hot-shoe with sync and data contacts and safety lock
<b>Nikon Creative Lighting System (CLS)</b>	Advanced Wireless Lighting supported with SB-900, SB-800, or SU-800 as commander; Flash Color Information Communication supported with built-in flash and all CLS-compatible flash units
<b>Sync terminal</b>	AS-15 sync terminal adapter (available separately)
<b>White balance</b>	
<b>White balance</b>	Auto, incandescent, fluorescent (7 types), direct sunlight, flash, cloudy, shade, preset manual, all except preset manual with fine tuning.
<b>Live view</b>	
<b>Lens servo</b>	<ul style="list-style-type: none"> <li>• <b>Autofocus (AF):</b> Single-servo AF (<b>AF-S</b>); full-time servo AF (<b>AF-F</b>)</li> <li>• <b>Manual focus (MF)</b></li> </ul>
<b>AF-area mode</b>	Face-priority AF, wide-area AF, normal-area AF, subject-tracking AF
<b>Autofocus</b>	Contrast-detect AF anywhere in frame (camera selects focus point automatically when face-priority AF or subject-tracking AF is selected)
<b>Automatic scene selection</b>	Available in  and  modes
<b>Movie</b>	
<b>Metering</b>	TTL exposure metering using main image sensor
<b>Metering method</b>	Matrix
<b>Frame size (pixels) and frame rate</b>	<ul style="list-style-type: none"> <li>• 1,920 × 1,080 (24p); 24 fps</li> <li>• 1,280 × 720 (30p); 30 fps (23.976 fps)</li> <li>• 1,280 × 720 (25p); 25 fps</li> <li>• 1,280 × 720 (24p); 24 fps (23.976 fps)</li> <li>• 640 × 424 (24p); 24 fps (23.976 fps)</li> </ul>
<b>File format</b>	MOV
<b>Video compression</b>	H.264/MPEG-4 Advanced Video Coding
<b>Audio recording format</b>	Linear PCM
<b>Audio recording device</b>	Built-in monaural microphone
<b>Monitor</b>	
<b>Monitor</b>	7.5-cm/3-in., approx. 230k-dot TFT LCD with brightness adjustment
<b>Playback</b>	
<b>Playback</b>	Full-frame and thumbnail (4, 9, or 72 images or calendar) playback with playback zoom, movie playback, slide show, histogram display, highlights, auto image rotation, and image comment (up to 36 characters)



<b>Interface</b>	
<b>USB</b>	Hi-Speed USB
<b>Video output</b>	NTSC, PAL
<b>HDMI output</b>	Type C mini-pin HDMI connector
<b>Accessory terminal</b>	<b>Remote cord:</b> MC-DC2 (available separately) <b>GPS unit:</b> GP-1 (available separately)
<b>Supported languages</b>	
<b>Supported languages</b>	Chinese (Simplified and Traditional), Czech, Danish, Dutch, English, Finnish, French, German, Indonesian, Italian, Japanese, Korean, Norwegian, Polish, Portuguese, Russian, Spanish, Swedish, Turkish
<b>Power source</b>	
<b>Battery</b>	One rechargeable Li-ion EN-EL14 battery
<b>AC adapter</b>	EH-5a AC adapter; requires EP-5A power connector (available separately)
<b>Tripod socket</b>	
<b>Tripod socket</b>	1/4 in. (ISO 1222)
<b>Dimensions/weight</b>	
<b>Dimensions (W × H × D)</b>	Approx. 124 × 96 × 74.5 mm (4.9 × 3.8 × 2.9 in.)
<b>Weight</b>	Approx. 450 g/15.9 oz. (camera body only); approx. 500 g (1 lb. 1.6 oz.) with battery and memory card but without body cap
<b>Operating environment</b>	
<b>Temperature</b>	0–40 °C (+32–104 °F)
<b>Humidity</b>	Less than 85% (no condensation)

- Unless otherwise stated, all figures are for a camera with a fully-charged battery operating at an ambient temperature of 20 °C (68 °F).
- Nikon reserves the right to change the specifications of the hardware and software described in this manual at any time and without prior notice. Nikon will not be held liable for damages that may result from any mistakes that this manual may contain.



<b>MH-24 battery charger</b>	
<b>Rated input</b>	AC 100–240 V, 50/60 Hz, 0.2 A maximum
<b>Rated output</b>	DC 8.4 V/0.9 A
<b>Supported batteries</b>	Nikon rechargeable Li-ion battery EN-EL14
<b>Charging time</b>	Approx. 1 hour and 30 minutes when no charge remains
<b>Operating temperature</b>	0–40 °C (+32–104 °F)
<b>Dimensions (W × H × D)</b>	Approx. 70 × 26 × 97 mm (2.8 × 1.0 × 3.8 in.), excluding plug adapter
<b>Weight</b>	Approx. 89 g (3.1 oz.), excluding plug adapter
<b>EN-EL14 rechargeable Li-ion battery</b>	
<b>Type</b>	Rechargeable lithium-ion battery
<b>Rated capacity</b>	7.4 V/1030 mAh
<b>Dimensions (W × H × D)</b>	Approx. 38 × 53 × 14 mm (1.5 × 2.1 × 0.6 in.)
<b>Weight</b>	Approx. 48 g (1.7 oz.), excluding terminal cover
<b>AF-S DX NIKKOR 18–55mm f/3.5–5.6G VR lens</b>	
<b>Type</b>	Type G AF-S DX NIKKOR zoom lens with built-in CPU and F mount for use exclusively with Nikon DX-format digital SLR cameras
<b>Focal length</b>	18–55 mm
<b>Maximum aperture</b>	f/3.5–5.6
<b>Lens construction</b>	11 elements in 8 groups (including 1 aspherical element)
<b>Angle of view</b>	76°–28° 50′
<b>Focal length scale</b>	Graduated in millimeters (18, 24, 35, 45, 55)
<b>Distance information</b>	Output to camera
<b>Zoom</b>	Manual zoom using independent zoom ring
<b>Focusing</b>	Autofocus controlled by Silent Wave Motor; manual focus
<b>Vibration reduction</b>	Lens-shift method using voice coil motors (VCMs)
<b>Minimum focus distance</b>	0.28 m (0.9 ft) from focal plane mark (□ 63) at all zoom positions
<b>Diaphragm blades</b>	7 (rounded diaphragm opening)
<b>Diaphragm</b>	Fully automatic
<b>Aperture range</b>	<ul style="list-style-type: none"> <li>• <b>18 mm focal length:</b> f/3.5–22</li> <li>• <b>55 mm focal length:</b> f/5.6–36</li> </ul>
<b>Metering</b>	Full aperture
<b>Filter-attachment size</b>	52 mm (P=0.75 mm)
<b>Dimensions</b>	Approx. 73 mm diameter × 79.5 mm/2.9 × 3.1 in. (distance from camera lens-mount flange)
<b>Weight</b>	Approx. 265 g (9.3 oz.)

Nikon reserves the right to change the specifications of the hardware and software described in this manual at any time and without prior notice. Nikon will not be held liable for damages that may result from any mistakes that this manual may contain.





## ■ The AF-S DX NIKKOR 18–55mm f/3.5–5.6G VR

The AF-S DX NIKKOR 18–55mm f/3.5–5.6G VR is for use exclusively with Nikon DX format digital cameras. If the camera is equipped with an AF-ON button, vibration reduction will not be activated when the AF-ON button is pressed.

### Using the Built-in Flash

When using the built-in flash, be sure the subject is at a range of at least 0.6 m (2 ft.) and remove lens hoods to prevent vignetting (shadows created where the end of the lens obscures the built-in flash).

Camera	Minimum distance without vignetting
D5000, D3000, D300 series, D200, D100, D90, D80, D70 series, D60, D50, D40 series	No vignetting at any focus distance

Because the built-in flash units for the D100 and D70 can only cover the angle of view of a lens with a focal of 20 mm or more; vignetting will occur at a focal length of 18 mm.

### Lens Care

- Keep the CPU contacts clean.
- Use a blower to remove dust and lint from the lens surfaces. To remove smudges and fingerprints, apply a small amount of ethanol or lens cleaner to a soft, clean cotton cloth or lens-cleaning tissue and clean from the center outwards using a circular motion, taking care not to leave smears or touch the glass with your fingers.
- Never use organic solvents such as paint thinner or benzene to clean the lens.
- The lens hood or NC filters can be used to protect the front lens element.
- Attach the front and rear caps before placing the lens in its flexible pouch.
- When a lens hood is attached, do not pick up or hold the lens or camera using only the hood.
- If the lens will not be used for an extended period, store it in a cool, dry location to prevent mold and rust. Do not store in direct sunlight or with naphtha or camphor moth balls.
- Keep the lens dry. Rusting of the internal mechanism can cause irreparable damage.
- Leaving the lens in extremely hot locations could damage or warp parts made from reinforced plastic.



### **Supplied Accessories**

- 52 mm Snap-on Front Lens Cap LC-52

### **Optional Accessories**

- 52 mm screw-on filters
- LF-1 and LF-4 rear lens caps
- Flexible Lens Pouch CL-0815
- Lens Hood HB-45 (attaches as shown at right)

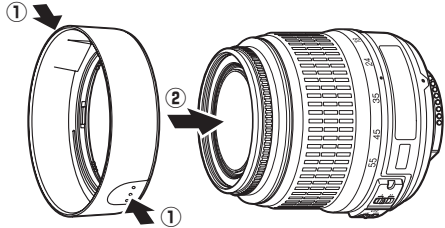

### **A Note on Wide-Angle Lenses**

Autofocus may not provide the desired results with wide- and super-wide-angle lenses in the following situations:

#### **1 The subject does not fill the focus point.**

If the subject does not fill the focus point, the camera may focus on the background and the subject may be out of focus.



**Example:** A far-off portrait subject at some distance from the background

#### **2 The subject contains many fine details.**

The camera may have difficulty focusing on subjects that contain many fine details or that are lacking in contrast.

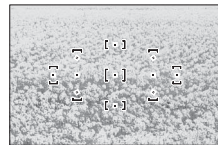

**Example:** A field of flowers

In these cases, use manual focus, or use focus lock to focus on another subject at the same distance and then recompose the photograph. For more information, see “Getting Good Results with Autofocus” (p 56).

## ■ ■ **Supported Standards**

- **DCF Version 2.0:** The Design Rule for Camera File Systems (DCF) is a standard widely used in the digital camera industry to ensure compatibility among different makes of camera.
- **DPOF:** Digital Print Order Format (DPOF) is an industry-wide standard that allows pictures to be printed from print orders stored on the memory card.
- **Exif version 2.21:** The D3100 supports Exif (Exchangeable Image File Format for Digital Still Cameras) version 2.21, a standard in which information stored with photographs is used for optimal color reproduction when the images are output on Exif-compliant printers.
- **PictBridge:** A standard developed through cooperation with the digital camera and printer industries, allowing photographs to be output directly to a printer without first transferring them to a computer.
- **HDMI: High-Definition Multimedia Interface** is a standard for multimedia interfaces used in consumer electronics and AV devices capable of transmitting audiovisual data and control signals to HDMI-compliant devices via a single cable connection.

### **Trademark Information**

Macintosh, Mac OS, and QuickTime are registered trademarks of Apple Inc. in the United States and/or other countries. Microsoft, Windows, and Windows Vista are either registered trademarks, or trademarks of Microsoft Corporation in the United States and/or other countries. PictBridge logo is a trademark. The SD, SDHC, and SDXC logos are trademarks of the SD-3C, LLC. HDMI, the HDMI logo and High-Definition Multimedia Interface are trademarks or registered trademarks of HDMI Licensing LLC. All other trade names mentioned in this manual or the other documentation provided with your Nikon product are trademarks or registered trademarks of their respective holders.



## **Battery Life**

The number of shots that can be taken with fully-charged batteries varies with the condition of the battery, temperature, and how the camera is used. Sample figures for EN-EL14 (1030 mAh) batteries are given below.

- **Single-frame release mode (CIPA standard <sup>1</sup>):** Approximately 550 shots
- **Continuous release mode (Nikon standard <sup>2</sup>):** Approximately 2000 shots
  - 1 Measured at 23 °C/73.4 °F ( $\pm 2$  °C/3.6 °F) with an AF-S DX NIKKOR 18–55mm f/3.5–5.6G VR lens under the following test conditions: lens cycled from infinity to minimum range and one photograph taken at default settings once every 30 s; after photograph is taken, monitor is turned on for 4 s; tester waits for exposure meters to turn off after monitor is turned off; flash fired at full power once every other shot. Live view not used.
  - 2 Measured at 20 °C/68 °F with an AF-S DX NIKKOR 18–55mm f/3.5–5.6G VR lens under the following test conditions: vibration reduction off, continuous release mode, focus mode set to **AF-C**, image quality set to JPEG basic, image size set to **M** (medium), white balance set to **AUTO**, ISO sensitivity set to ISO 100, shutter speed  $1/250$  s, focus cycled from infinity to minimum range three times after shutter-release button has been pressed halfway for 3 s; six shots are then taken in succession and monitor turned on for 4 s and then turned off; cycle repeated once exposure meters have turned off.

The following can reduce battery life:

- Using the monitor
- Keeping the shutter-release button pressed halfway
- Repeated autofocus operations
- Taking NEF (RAW) photographs
- Slow shutter speeds
- Using a GP-1 GPS unit
- Using VR (vibration reduction) mode with VR lenses



























To ensure that you get the most from rechargeable Nikon EN-EL14 batteries:

- Keep the battery contacts clean. Soiled contacts can reduce battery performance.
- Use batteries immediately after charging. Batteries will lose their charge if left unused.



# Index

## Symbols

 (Auto mode) .....23
 (Auto (flash off) mode) .....23
 (Portrait) .....28
 (Landscape).....28
 (Child).....29
 (Sports) .....29
 (Close up) .....29
 (Night portrait).....29
<b>P</b> (Programmed auto) .....74
<b>S</b> (Shutter-priority auto) .....75
<b>A</b> (Aperture-priority auto).....76
<b>M</b> (Manual) .....77
<b>GUIDE</b> (Guide).....33
 (flexible program) .....74
<b>WB</b> (White balance) .....87
<b>PRE</b> (Preset manual) .....90
 (Single frame) ..... 5, 53
 (Continuous)..... 5, 53
 (Self-timer).....5, 53, 54, 143
 (Quiet shutter release)..... 5, 53
 (Single-point AF) .....58
 (Dynamic-area AF) .....58
 (Auto-area AF) .....58
 (3D-tracking (11 points) ) .....58
 (Matrix) .....79
 (Center-weighted) .....79
 (Spot).....79
 (Flash compensation) .....83
 (Exposure compensation) .....81
 (Help).....11
 (focus indicator) .....26, 60, 63
 (flash-ready indicator).....27
 (“Beep” indicator)..... 144

## Numerics

3D color matrix metering II .....79
3D-tracking .....58
3D-tracking (11 points) (AF-area mode) .....58
420-pixel RGB sensor .....79

## A

A/V cable .....126, 176
AC adapter .....176, 178
Accessories ..... 176
Active D-Lighting .....85, 146
Adobe RGB ..... 133
AE lock ..... 80, 146
AE-L .....80, 146
AE-L/AF-L ..... 146
<b>AE-L/AF-L</b> button ..... 61, 80, 146
AF .....55–61

AF-area mode .....38, 58
AF-assist.....57, 134, 171
A-M switch .....16, 62
Amber ..... 89, 156
Angle of view .....171
Aperture .....73, 76
Aperture-priority auto ..... 76
Attaching the lens ..... 16
Auto (White balance)..... 87
Auto distortion control ..... 133
Auto flash .....69
Auto image rotation..... 141
Auto info display ..... 139
Auto ISO sensitivity ..... 132
Auto meter-off ..... 27, 143
Auto off timers ..... 143
Auto-area AF (AF-area mode) ... 58
Autofocus..... 55–61
Auto-servo AF ..... 55
Available settings..... 186

## B

Battery .....14, 15, 23
Beep ..... 144
Before and after ..... 164
Black-and-white..... 154
Blue ..... 89, 156
Blue intensifier (Filter effects) .. 155
Body cap.....2, 16, 177
Border (PictBridge) ..... 119, 122
Built-in flash ..... 135
Burst ..... 53
Buttons ..... 146

## C

Calendar ..... 106
Calendar playback ..... 106
CEC ..... 128
Center-weighted ..... 79
Charging a battery..... 14
Clean image sensor ..... 180
Clock ..... 18, 139
Clock battery ..... 19
Cloudy (White balance) ..... 87
CLS ..... 173
Color balance..... 156
Color outline ..... 162
Color space..... 133
Color temperature ..... 88
Compatible lens ..... 167
Computer..... 115
Connecting a GPS to the camera... 98, 177
Continuous (Release mode) ... 5, 53

Continuous-servo AF ..... 55
CPU contacts ..... 168
CPU lens ..... 17, 167
Creative Lighting System ..... 173
Cross screen (Filter effects) ..... 155
Cyanotype ..... 154

## D

Date and time..... 18, 139
Date counter ..... 147, 148
Date format ..... 18, 139
Date imprint ..... 147
Daylight saving time ..... 18, 139
DCF version 2.0 ..... 133, 203
Delete ..... 31, 109
Delete all images..... 110
Delete current image..... 31, 109
Delete selected images ..... 110
Device control (HDMI) ..... 128
Digital Print Order Format ..... 117, 120, 124, 203
Diopter adjustment control ..... 22, 176
Direct sunlight (White balance) 87
Display mode..... 130
Distortion control ..... 161
D-Lighting ..... 153
DPOF..... 117, 120, 124, 203
Dust Off ref photo..... 141
Dynamic-area AF ..... 58

## E

Edit movie..... 50, 52
Exif version 2.21 ..... 133, 203
Exposure.....73, 80, 81
Exposure compensation ..... 81
Exposure indicator..... 77
Exposure lock ..... 80
Exposure meters ..... 27, 143
Exposure mode..... 73
Eye-Fi upload..... 150

## F

Face-priority AF ..... 38
File information ..... 100
File number sequence ..... 145
Filter effects.....96, 155
Fine-tuning white balance ..... 89
Firmware version..... 150
Fisheye ..... 162
Flash .....27, 67, 68, 172
Flash (White balance)..... 87
Flash compensation..... 83
Flash control ..... 135



Flash mode ..... 68  
Flash range ..... 70  
Flash ready indicator ..... 27, 175  
Flash sync speed ..... 196  
Flexible program ..... 74  
Flicker reduction ..... 42, 48, 139  
Fluorescent (White balance) 87, 88  
Fn button ..... 9, 146  
f-number ..... 76, 167  
Focal length ..... 171  
Focal length scale ..... 16  
Focal plane mark ..... 63  
Focus ..... 55–63  
Focus indicator ..... 26, 60, 63  
Focus lock ..... 60  
Focus mode ..... 38, 55  
Focus point ..... 25, 38, 58, 60, 63  
Focusing screen ..... 195  
Focusing the viewfinder ..... 22  
Focus-mode switch ..... 16, 62  
Format ..... 21  
Format memory card ..... 21  
Frame interval (Slide show) ..... 112  
Front-curtain sync ..... 69  
Full-frame playback ..... 99  
Full-time servo AF ..... 38

## G

GP-1 ..... 98, 177  
GPS ..... 98, 104  
GPS data ..... 104  
Green ..... 89, 156  
Green intensifier (Filter effects) ..... 155  
Guide mode ..... 33

## H

H.264 ..... 198  
HDMI ..... 127, 203  
HDMI-CEC ..... 128  
Help ..... 11  
Hi (Sensitivity) ..... 71, 72  
High definition ..... 127, 203  
Highlights ..... 102, 130  
Histogram ..... 101, 130

## I

Image comment ..... 140  
Image overlay ..... 158  
Image quality ..... 64  
Image review ..... 130  
Image size ..... 66  
Incandescent (White balance) .. 87  
Index print ..... 123  
Info display format ..... 137  
In-focus indicator ..... 26, 60, 63

Information ..... 6, 100, 137  
ISO sensitivity ..... 71, 132  
i-TTL ..... 135  
i-TTL balanced fill-flash for digital SLR ..... 135

## J

JPEG ..... 64  
JPEG basic ..... 64  
JPEG fine ..... 64  
JPEG normal ..... 64

## L

Landscape (Set Picture Control) 94  
Language ..... 18, 140  
Large (Image size) ..... 66  
LCD ..... 137  
LCD brightness ..... 137  
Lens ..... 16, 17, 167  
Lens cap ..... 16  
Lens focus ring ..... 16  
Lens mount ..... 2, 16, 63  
Lens VR switch ..... 16, 17  
Live view ..... 37, 45  
Live view switch ..... 37, 45  
Live view/movie ..... 38

## M

Magenta ..... 89, 156  
Manual ..... 62, 77  
Manual focus ..... 43, 62  
Matrix ..... 79  
Max. sensitivity ..... 132  
Maximum aperture ..... 63  
Medium (Image size) ..... 66  
Memory buffer ..... 26, 53  
Memory card ..... 20, 177, 187  
Memory card capacity ..... 187  
Metering ..... 79  
Min. shutter spd ..... 132  
Miniature effect ..... 163  
Minimum aperture ..... 17, 73  
Mirror ..... 2, 182  
Mirror lock-up ..... 182  
Monitor ..... 37, 99  
Monochrome ..... 154  
Monochrome (Set Picture Control) 94  
Mounting index ..... 16  
MOV ..... 65  
Movie settings ..... 47  
Movie-record button ..... 46  
Movies ..... 45

## N

NEF ..... 64

NEF (RAW) ..... 64, 160  
NEF (RAW) processing ..... 160  
Neutral (Set Picture Control) ..... 94  
Nikon Transfer 2 ..... 115, 116  
Noise reduction ..... 134  
Non-CPU lens ..... 169  
Normal-area AF ..... 38  
Number of shots ..... 204

## O

Optional flash ..... 135, 172  
Output resolution (HDMI) ..... 128  
Overview data ..... 104

## P

Page size (PictBridge) ..... 119, 122  
Perspective control ..... 162  
Photo info ..... 100, 130  
PictBridge ..... 117, 203  
Picture Controls ..... 94, 95  
Playback ..... 30, 99  
Playback folder ..... 129  
Playback information ..... 100, 130  
Playback menu ..... 129  
Playback zoom ..... 107  
Portrait (Set Picture Control) ..... 94  
Preset manual (White balance) 87, 90  
Press the shutter-release button all the way down ..... 26, 27  
Press the shutter-release button half-way ..... 26, 27  
Print (DPOF) ..... 120  
Print select ..... 120  
Print set (DPOF) ..... 124  
Printing ..... 117  
Programmed auto ..... 74  
Protecting photographs ..... 108

## Q

Quality (Movie settings) ..... 47  
Quick retouch ..... 161

## R

Rangefinder ..... 144  
Rear lens cap ..... 16  
Rear-curtain sync ..... 69  
Recent settings ..... 165  
Red intensifier (Filter effects) ... 155  
Red-eye correction ..... 153  
Red-eye reduction ..... 69  
Release mode ..... 5, 53  
Release-mode selector ..... 5, 53  
Remote cord ..... 78, 177  
Removing the lens from the camera ..... 17

Reset setup options ..... 136  
 Reset shooting options..... 131  
 Retouch menu ..... 151  
 RGB .....101, 133  
 RGB Histogram..... 101  
 Rotate tall..... 130

**S**

Scene auto selector .....41  
 Scene mode .....28  
 Self-timer .....5, 53, 54, 143  
 Self-timer delay..... 143  
 Sensitivity ..... 71, 132  
 Sepia ..... 154  
 Set Picture Control.....95  
 Setup menu ..... 136  
 Shade (White balance).....87  
 Shooting data.....102, 103  
 Shooting menu ..... 131  
 Shutter-priority auto.....75  
 Shutter-release button...26, 27, 60,  
 80  
 Single frame (Release mode) .5, 53  
 Single-point AF (AF-area mode)58  
 Single-servo AF.....38, 55  
 Size .....47, 66  
 Skylight (Filter effects)..... 155  
 Slide show ..... 112  
 Slot empty release lock..... 147  
 Slow sync .....69  
 Small (Image size) .....66  
 Small picture ..... 156  
 Soft (Filter effects)..... 155  
 Sound (Movie settings) .....47  
 Speedlight ..... 172  
 Spot.....79  
 sRGB..... 133  
 Standard (Set Picture Control)...94  
 Standard i-TTL fill-flash for digital  
 SLR..... 135  
 Start printing (PictBridge) 120, 122  
 Storage folder..... 149  
 Straighten ..... 161  
 Subject-tracking AF.....38

**T**

Television ..... 126  
 Thumbnail playback ..... 105  
 Time stamp (PictBridge) ...119, 122  
 Time zone ..... 18, 139  
 Time zone and date..... 18, 139  
 Timer.....54  
 Toning .....96, 97  
 Transition effects (Display mode)..  
 130  
 Transition effects (Slide show). 112

Trim ..... 154  
 Type D lens ..... 168  
 Type G lens ..... 168

**U**

USB .....116, 117  
 USB cable ..... 116, 117, 176  
 UTC ..... 18, 98, 104

**V**

Vibration Reduction ..... 17  
 Video mode..... 139  
 Viewfinder ..... 10, 22, 195  
 Viewfinder eyepiece ..... 54  
 Viewfinder eyepiece cap ..... 54  
 ViewNX 2 ..... 115  
 Vivid (Set Picture Control) ..... 94

**W**

Warm filter (Filter effects)..... 155  
 WB ..... 87  
 White balance ..... 87  
 Wide-area AF ..... 38



# **Nikon**

No reproduction in any form of this manual, in whole or in part (except for brief quotation in critical articles or reviews), may be made without written authorization from NIKON CORPORATION.



**NIKON CORPORATION**

---

© 2010 Nikon Corporation

SB0G01(11)  
**6MB09111-01**