

Acoustic Test Fixture for Hearing protectors

Per Rasmussen

Introduction

The GRAS 45CB Acoustic Test Fixtures is primarily designed for objective testing of hearing protectors. The 45CB is designing in accordance with the ANSI S12.42 standard. While normal Acoustical Test fixtures like the GRAS 45BA Kemar, which is optimized for testing devices like hearing aids, headphones and telephones, only have a self-insertion loss in the range of 40-60 dB, the 45CB has self insertion loss of more than 60 dB. The test fixture is equipped with artificial ear couplers to simulate the input impedance of the human ear.



Theory

The acoustic test fixture can be seen as a number of different sub-system each with a different function for the correct measurement of insert loss of hearing protectors.

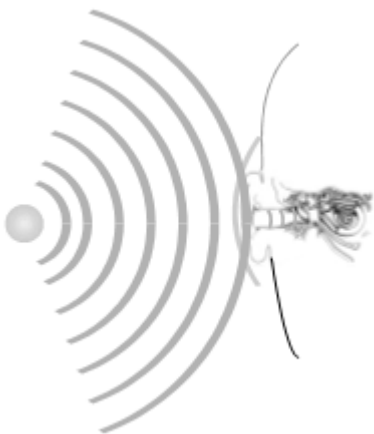

The first part is the general outer shape of a human head with shoulders. When a human head is introduced in a sound field, the sound field will be changed due to diffraction around the head and torso. In the mid frequency range the presence of the head will result in an increase of the sound pressure close to the head. This pressure increase depends on the orientation of the head in the sound field, but for a plane wave arriving from the front of the head the pressure increase at the ear reference point is as shown in figure VV.

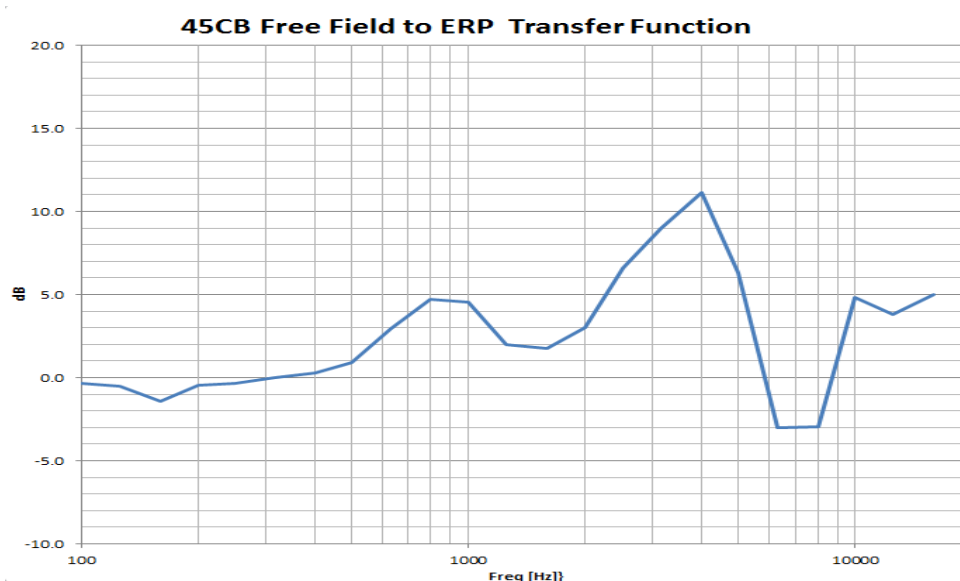

It can be seen that there is an increase of the sound pressure level of approximately 5 dB around 900 Hz and 10 dB around 4 kHz. In order to realistically test the performance of hearing protectors as they will perform on a human head it is important that the size of the test structure resembles the shape of the human head.

The next important subsystem is the pinna and outer ear canal. These forms the direct mechanical interface to the hearing protectors and are important in simulating transmission through through the skin and flesh of a typical human head structure. Therefore the stiffness of the rubber used for the in the Acoustic Test Fixture is carefully controlled to a stiffness of 35 Shore AA.

The outer ear canal is followed by the Ear simulator, which replicates the human ear impedance and also includes a microphone to simulate the function of the eardrum and inner ear. When the hearing protector is mounted on the ear (circum aural type) or inside the ear canal (in-the-ear type), the hearing protector will be loaded with the input impedance of the ear and this will affect the sound transmission through the hearing protector. Also the sound transmitted through the hearing protector has to be transmitted through the ear canal to the ear drum. The effect of this can be described as the transfer impedance of the ear canal system, and the Type RA0045 Ear simulator in the Acoustic text fixture has a transfer impedance similar to what is found in a typical human ear system.

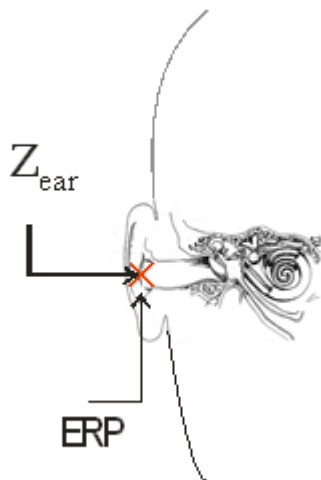
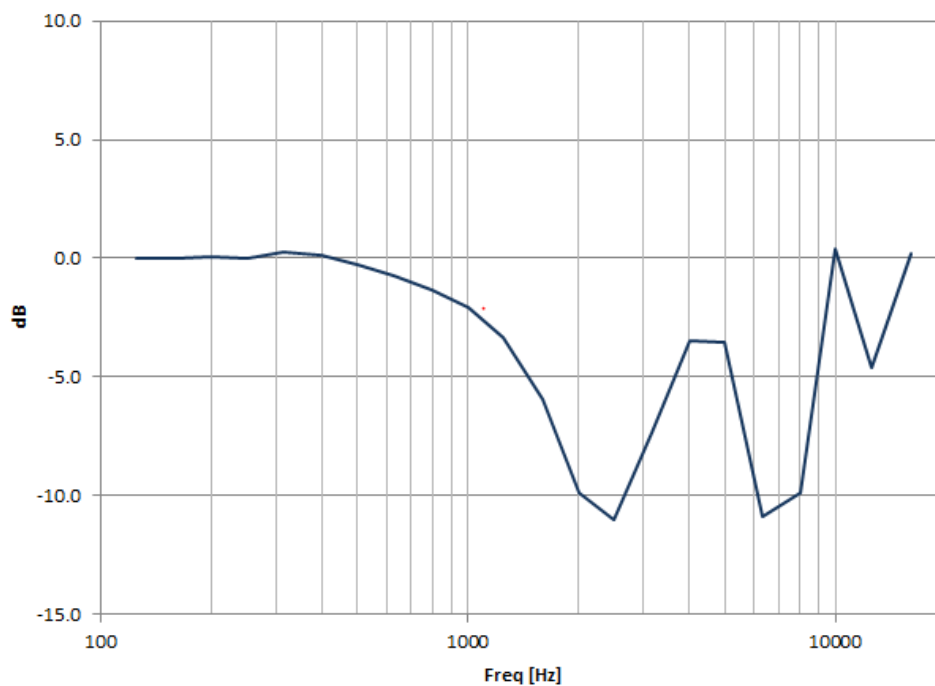

Figure WW shows the transfer function from the ear entrance point to the drum reference point and it can be seen that the signal is attenuated by up to 10 dB in the mid frequency range.



Typical test setup

The test fixtures may be used for testing of both continuous and impulsive excitation of hearing protectors, but here we will focus on continuous excitation testing using broad band noise.

The test should be performed in a diffuse sound field, for example in a reverberation room. In order to test hearing protectors with high attenuation, it is necessary to establish a high sound pressure level in the diffuse field. This may require the use of several high power loudspeakers distributed in the test room so that a diffuse field is obtained in the position where the test fixture is positioned.

The diffuse sound field was established in a large room (16 x 12 x 6m) with reflecting walls (Reverberation room) by four loudspeakers pointing away from the test object. The loudspeakers were driven by four power amplifiers and produced a sound pressure level of about 90 dB (in 1/3 octave bands) from 50 Hz to 20 kHz as seen in fig 2, upper graph. This level was measured with a reference microphone in the position where the test fixture would be, but without the test fixture in the sound field. This level should be compared to the noise floor the test fixture. In the standard configuration, the 45CB is equipped with ear couplers with ¼" pressure microphones with a sensitivity of 1.6 mV/Pa. With these microphones, the test fixture has a noise floor as indicated in fig lower curve. The difference between the sound pressure level in the diffuse field and the noise floor determines the range of insertion loss which can be measured with this setup and is in the range of 60 dB. For higher ranges either the sound pressure level in sound field should be increased or the microphones should be replaced with more sensitive units with lower noise floor.

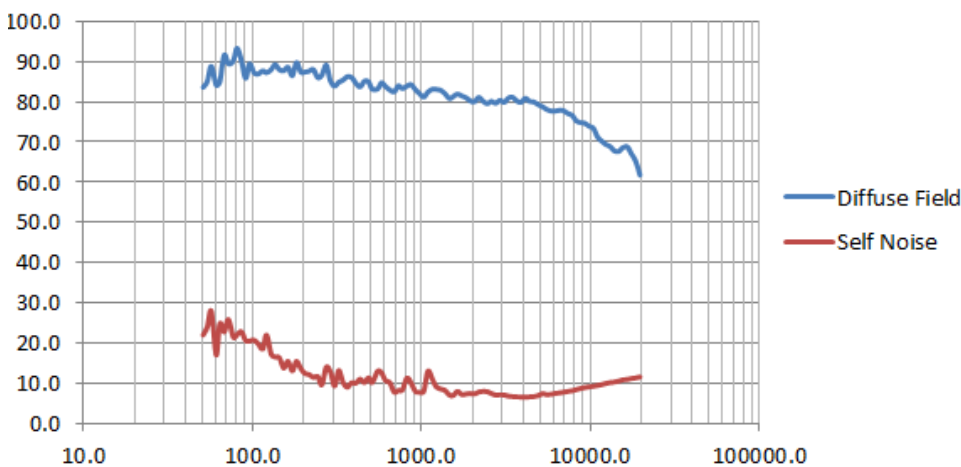

The self-insertion loss of the 46CB has been determined using more sensitive microphones in a sound field with higher sound pressure level. This can be seen in fig 3 where it is also compared to the requirements given in ANSI S12.42 exceeds the requirements in the standard. The self insertion loss is obtained by fully blocking the ear canal entrance with a solid steel plug with at least 10 mm wall thickness. Also this is measured without the rubber pinna mounted on the head as transmission through the rubber, simulating the human flesh, is an important path for sound transmission for normal circum-aural head protectors.

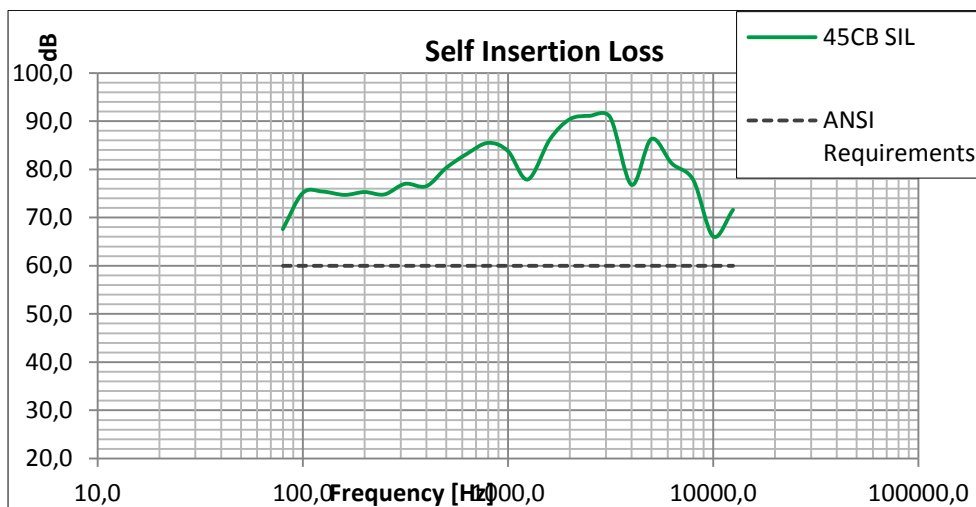

The measurements were performed with a setup as shown in fig.4. with data acquisition and output signal generation software implemented in Labview connected to a NI 4163 USB Dynamic Signal Analyzer. The output signal was broadband pink noise going to a four channel power amplifier driving four full range loudspeakers. The microphone signals from the two artificial ear couplers in the 45CB was connected to a GRAS Type 12AA two channel power supply and from there to the NI 4163.

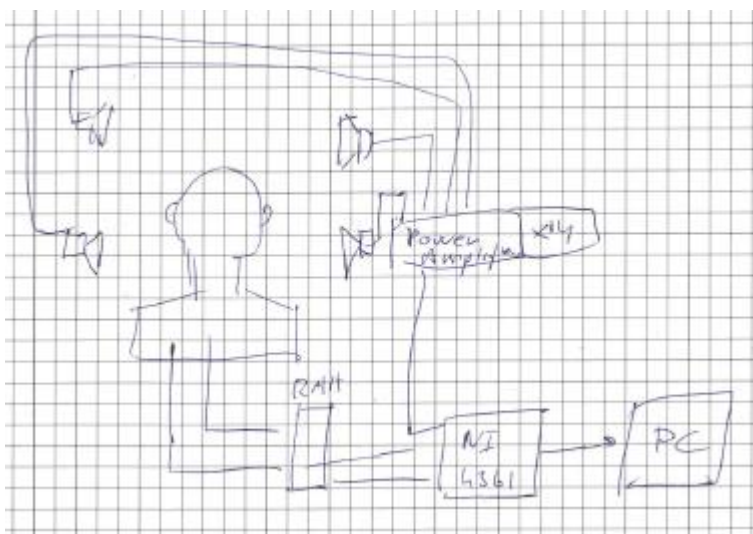

The acoustical test fixture was equipped with rubber pinna (the external ear structure) on both sides, with Shore 00 35 hardness. The 45CB is equipped with heated ear canals so that the temperature can be maintained at levels as found in the human ear canal. This may be of importance when studying in -ear type headphones with rubber fittings, as the rubber may change properties with temperatures. It is then important that the measurements are performed with the in-ear type headphone at the same temperature as when mounted on a human ear.

While the rubber pinnae simulates the outer ear structure, the middle and inner ear is simulated by a standardized IEC 60318-4 coupler (formerly known as the "711-coupler"). This

has the same input and transfer impedance as a typical human ear. This means that when the headphone is mounted on the ear, the headphones will be loaded with the same impedance as for a typical human ear. The couplers is also equipped with a microphone, in a position where the human eardrum would normally be. This means that the microphone will record the sound pressure as it would be at a typical ear drum of a typical listener.

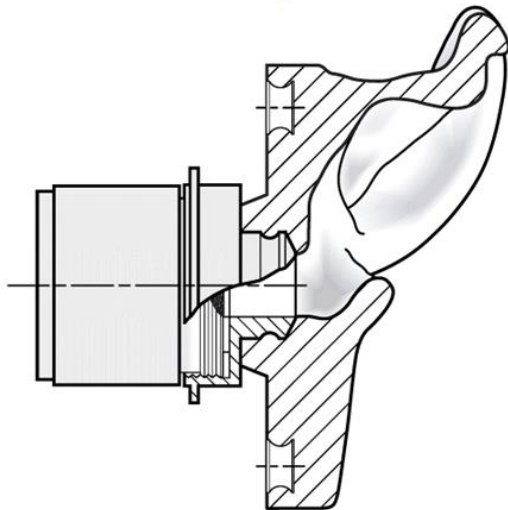

Results:

A series of test were performed on both passive ear-protectors and on active noise cancelling headphones.

The passive ear-protectors included two in-ear models, Fig XX A & B, and one circum-aural Fig XX C.



For each test, the signal from the ATF was first recorded without the headphone mounted, then with the ear protector mounted. For all types it is critical to ensure a proper sealing and leaks may seriously affect the measurement results especially at low frequencies.

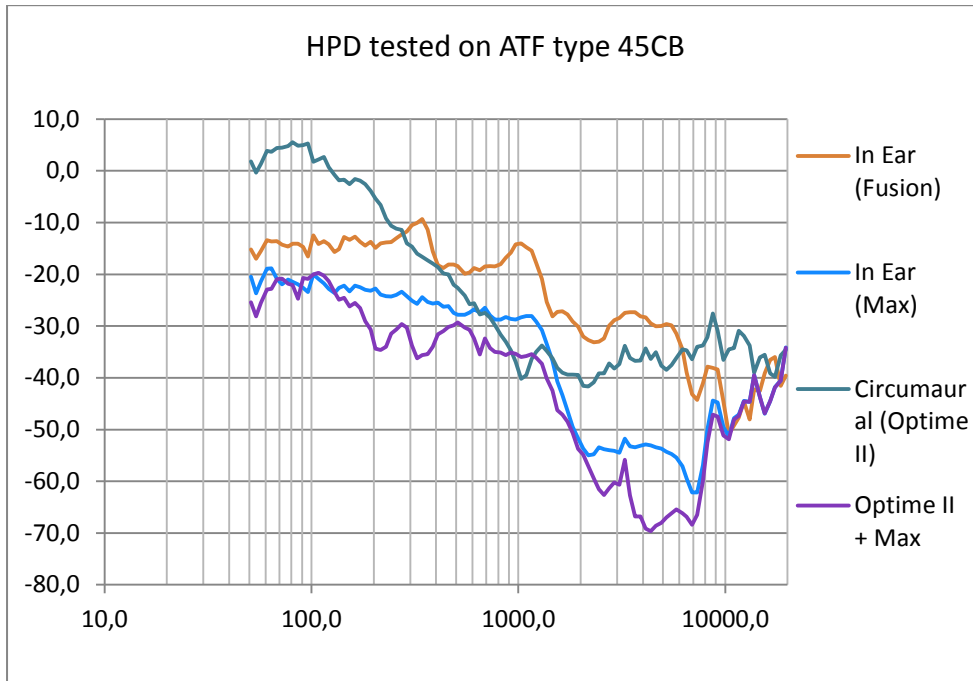

Similar measurements were performed on active noise control headphones of both in-ear type fig yy A and circum-aural type fig YY B. both units were measured in both active and passive mode as seen in fig zz and ZZ.



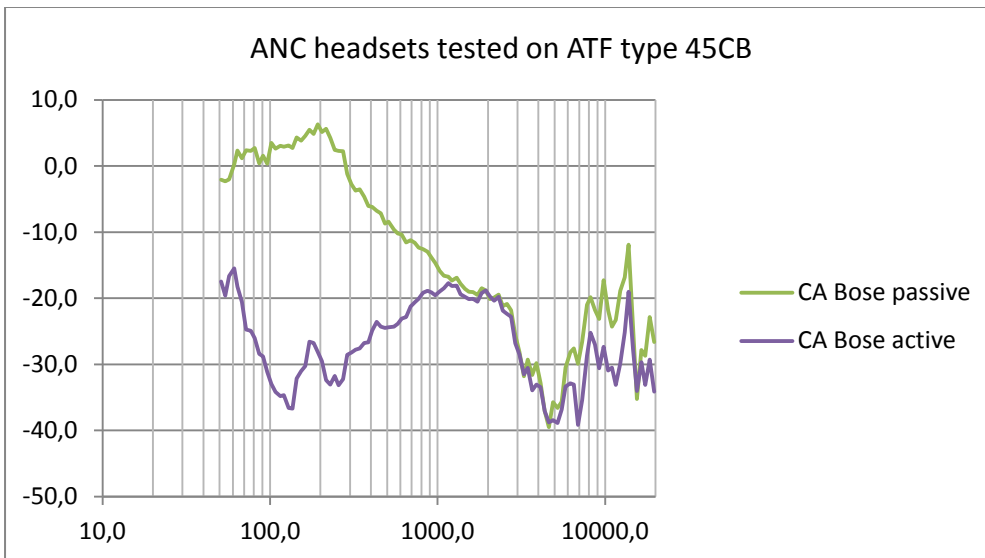
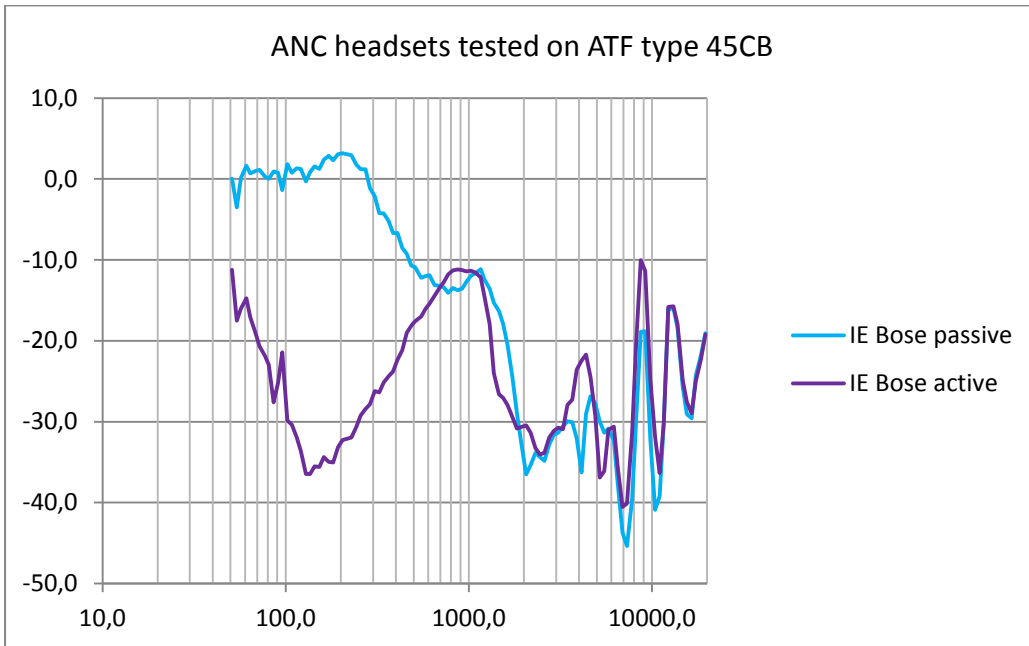
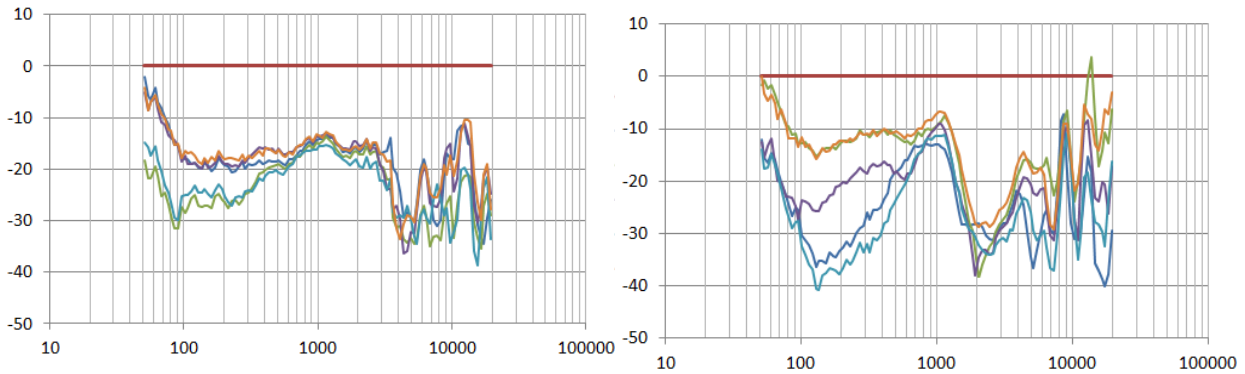

Fig TT shows repeatability of measurements in active mode for Type A and B headphones. It can be seen that for the circum-aural type B the repeatability is good in the mid-frequency range, while in the low frequency range the results fall in two groups, probably caused by leakage. This may occur if the headphone is not properly fitted to the ATF. For the In-ear type A, it is also critical how the headphone is fitted to the ear and the affects both the high frequency and the low frequency performance considerable.



Conclusion

The Insertion loss of Active Noise cancelling headphones can be measured and evaluated with Acoustical Test Fixtures according to the ANSI Standard. The individual test is sensitive to the exact mounting of the headphone on the test fixture. This variation is larger than the differences found for type of fixture. There are other methods like the REAT (Real Ear Attenuation at Threshold). For a comparison of measurements using acoustical test fixture and REAT test see for example E. Berger et al:

Performance of New Acoustical Test Fixtures Complying with ANSI S12.42-2010, With Particular Attention to the Specification of Self Insertion Loss , Internoise 2014.