

***ViaLiteHD***  
**Fibre Optic Link System**  
**3U chassis**

User Manual

HRK3-HB-7

CR4566

17/09/20



## Instrument Care and Safety Information

Please read the whole of this section before using your **ViaLiteHD** product. It contains important safety information and will enable you to get the most from your Fibre Optic link.

### Electrical Safety



The **ViaLiteHD** chassis provides the termination for power inputs and can be fitted with power supplies.

The **ViaLiteHD** chassis is a Safety Class 1 product (having metal chassis directly connected to earth via the power supply cable).

When operating the equipment note the following precautions:

- Hazardous voltages exist within the equipment.
- There are no user serviceable parts inside; the covers **MUST NOT** be removed.
- There are no user replaceable fuses in the chassis mounted equipment. Replacement should only be carried out by a **ViaLite Communications** technician.
- The chassis earth stud **SHOULD** be connected to the safety earth.
- When using a 2 pin power supply cable the chassis earth stud **MUST** be connected to the safety earth.
- The **ViaLiteHD** Power Supply Modules do not have an isolating switch on the mains voltage inlet. For this reason, the **ViaLiteHD** chassis **MUST** be installed within easy reach of a clearly labelled dual pole mains isolation switch, which supplies the equipment.
- PSU modules are fused on the mains live feed only. A second fuse should be used for the neutral connection where the polarity of the connectors can be reversed; rating should match those given in section 5.1.1.

### ESD Precautions



The **ViaLiteHD** chassis is not equipped with any active electronics but it may be fitted with them.

Precautions for handling electro-static sensitive devices should be observed when handling all **ViaLiteHD** modules. Technicians should ensure that they use effective personal grounding (i.e. ESD wrist strap etc.) when servicing the equipment. Any equipment or tools used should be grounded to prevent static charge build-up. Good practice should be observed at all times. For reference see relevant standards. EN 61340-5-1, "Protection of Electronic Devices from Electrostatic Phenomena – General Requirements"

### Optical Safety



The **ViaLiteHD** chassis is not equipped with optical units but it may be fitted with them

The **ViaLiteHD** RF Transmitter and Transceiver modules contain laser diode sources operating at nominal wavelengths of 1270nm to 1610nm.

These devices are rated as EN60825-1:2007 CLASS 1 radiation emitting devices. A class 1 laser is safe under all conditions of normal use.

When operating the equipment note the following precautions:

- Never look into the end of an optical fibre directly or by reflection either with the naked eye or through an optical instrument.
- Never leave equipment with radiating bare fibres – always cap the connectors.
- Do not remove equipment external covers when operating.

### Hot surface



The **ViaLiteHD** Redundancy load module may have hot surfaces when operating under full load. The hot surfaces are not accessible when fitted in an approved chassis installation.

Suitable precaution should be taken when handling this device.

- Allow to cool for 10 minutes
- Do not touch metallic surfaces or printed circuit board when hot.
- When handling, hold front panel and handle only.

## TABLE OF CONTENTS

1	INITIAL INSPECTION .....	5
2	INTRODUCTION TO THE <i>VIALITEHD</i> RANGE .....	5
3	<i>VIALITEHD</i> AND <i>VIALITE</i> CLASSIC COMPATIBILITY .....	6
4	<i>VIALITEHD</i> SYSTEM COMPONENTS .....	7
4.1	<i>ViaLiteHD</i> 19" chassis.....	7
4.2	Description.....	7
4.3	Power Interface Management .....	7
4.3.1	External backplane power .....	7
4.3.2	Module bias feed.....	8
4.4	Alarm Management .....	8
4.4.1	"Alarm Concentrator" 50way Connector J1 .....	8
4.4.2	Connecting to an "open collector" output .....	8
4.4.3	Summary Alarm.....	8
4.4.4	Module Alarm Defeat.....	9
4.4.5	Using open collector alarms with controller cards .....	9
4.4.6	Using open collector alarms with RF switch and RF splitter cards .....	9
4.5	Heat management .....	9
4.6	Unused module positions.....	9
4.7	Minimum power supply load.....	10
4.8	Chassis Specification.....	11
4.9	Chassis connector pinouts .....	11
4.9.1	Chassis connector pin out J4 & J19-31.....	12
4.9.1.1	Chassis connector pin out J4 & J19-31 - serial numbers below and including SN1221901 .....	12
4.9.1.2	Chassis connector pin out J4 & J19-31 - serial numbers above and including SN1221902.....	13
4.9.2	LNA feed and BUC feed pin assignment for different module types.....	14
4.10	Fan replacement.....	15
5	<i>VIALITEHD</i> POWER SUPPLIES .....	16
5.1	6HP Chassis Power Supplies .....	16
5.1.1	Specification.....	17
5.2	19" Chassis Power Requirements.....	17
5.3	Redundancy load module, HRL .....	17
5.3.1	Redundancy load module, plug-in card.....	18
5.3.2	Redundancy load module, front panel .....	18
5.3.3	Redundancy load module, DIP switches.....	18
5.3.4	Redundancy load module, setting the load DIP switches.....	19
5.3.5	Redundancy load module, using with SNMP and controller module.....	19
5.4	Power Supply HPS-CS-3 for use with OEM modules (HRx-xx-xM-xx).....	19
6	INSTALLATION GUIDE .....	21
6.1	Chassis Installation.....	21
6.2	6HP Power Supply Module Installation (slots 15 and 16) .....	21
6.3	5HP Standard Plug-in Modules (slots 1-13) .....	21
6.4	5HP Blindmate Plug-in Modules (slots 1-13).....	22
6.5	7HP Standard Plug-in Modules (slot 14 only).....	23
6.6	5HP blanking panel installation (slots 1-13).....	24
6.7	7HP blanking panel installation (slot 14) .....	25
6.8	6HP blanking panel installation (slots 15, 16).....	25
6.9	Separate blindmate panels .....	25
6.10	Electrical power connection .....	25
6.11	Typical redundancy configurations.....	27
6.11.1	Four 1:1 redundant single transmitters, standard modules.....	27
6.11.2	Four 1:1 redundant single transmitters, blindmate modules .....	27
6.11.3	Six 1:1 redundant dual transmitters, standard modules .....	28
6.11.4	Six 1:1 redundant dual transmitters, blindmate modules.....	28
6.11.5	Four 1:1 redundant single receivers, standard modules.....	29
6.11.6	Four 1:1 redundant single receivers, blindmate modules .....	29
6.11.7	Six 1:1 redundant dual receivers, standard modules.....	30
6.11.8	Six 1:1 redundant dual receivers, blindmate modules.....	30
6.11.9	Four 1:1 redundant links, blindmate modules, using single transmitters TX and single receivers RX .....	31
6.11.10	Six 1:1 redundant links, blindmate modules, using dual transmitters DTX and dual receivers DRX.....	32
6.11.11	Uplink and downlink 1:1 redundant, blindmate modules using single transmitters TX and single receivers RX .....	33
6.11.12	Six 1:1 redundant transceivers TRX, standard modules .....	34
6.11.13	Six 1:1 redundant links, standard modules, using transceivers TRX .....	35
6.12	Shock and vibration .....	36
7	PART NUMBERING.....	38
7.1	<i>ViaLiteHD</i> Chassis, part numbering .....	38
7.2	<i>ViaLiteHD</i> Power supply, part numbering.....	38

8	MAINTENANCE AND FAULT-FINDING GUIDE.....	39
9	PRODUCT WARRANTY .....	40
10	FCC APPROVAL .....	40

## 1 Initial Inspection

Unpack and inspect the equipment as soon as possible. If there is any sign of damage or any parts missing, do not install the equipment before seeking advice from **ViaLite Communications** or your local agent.

The equipment received should match the delivery note that is shipped with the equipment. If there are any discrepancies, contact **ViaLite Communications** or your local agent.

## 2 Introduction to the ViaLiteHD Range

The **ViaLiteHD** range has been developed to provide a modular solution to the transmission of a wide range of analogue and digital data where traditional 'copper wire' systems cannot be used, for example, in electrically noisy environments or over long distances.

The range is ideal for permanent and semi-permanent installation in Satellite communications, GPS, antenna remoting and other related applications.

The variety of links available includes low frequency timing (2kHz) to C-Band RF (7.5GHz), RF splitters, amplifiers and switches; they also include a full suite of supporting functions including RS232/422/485, Ethernet and control systems to monitor and control the system with both Web and SNMP interfaces.

All **ViaLiteHD** equipment operates over high quality glass fibre optic cable, which can be supplied in low-cost 3mm jacket, riser and outdoor specifications. The links can also be used with existing cable systems at customer premises.

A **ViaLiteHD** system can be added to at any time, enabling the system to evolve with the needs of the user.

**ViaLiteHD** is a product brand manufactured by Pulse Power and Measurement Ltd (PPM). **ViaLite Communications** is a division of Pulse Power and Measurement Ltd (PPM).

### 3 **ViaLiteHD and ViaLite Classic compatibility**

The RF and optical interfaces of most **ViaLiteHD** and **ViaLite Classic** modules are compatible. However the physical size, mounting systems and control of the modules are different, so it will not be possible to fit **ViaLiteHD** module in a **ViaLite Classic** chassis or housing and vice versa. However it is possible for modules of different types to interwork and be used to expand existing systems. Listed below is a brief summary of inter family compatibility.

- RF                                      Compatible optical and RF interfaces
- RF + digital                          Compatible optical and RF interfaces
- RS232                                    Compatible optical and digital interfaces
- RS422                                    Compatible optical and digital interfaces
- RS485                                    Compatible optical and digital interfaces
- Ethernet                                Modules of matching speed have compatible optical and digital interfaces
- Redundancy Switch                  Compatible RF interfaces may need interface cable (no optical interface)
- RF Splitters                          Compatible RF interfaces (no optical interface)
- Amplifier                                Compatible RF interfaces (no optical interface)
- SNMP                                    Not compatible

Contact **ViaLite Communications** or your local agent for more details.

## 4 ViaLiteHD System Components

### 4.1 ViaLiteHD 19" chassis

#### 4.2 Description

The 19" chassis is suitable for 19" rack mounting. There are two versions, one for alternating current (AC) power and one for direct current (DC) power.

The chassis accommodates up to thirteen (5HP) plug-in RF/data modules, one (7HP) control module and two (6HP) plug-in power supplies. The hot-swappable, dual power supply capability provides full redundancy and maximum reliability to avoid traffic loss in the event of a power supply failure. The chassis incorporates a backplane PCB for the distribution of DC power, status alarms and data.

Note: Each power supply position requires a separate power source to provide fully redundant protection.



The plug-in modules simply plug into the chassis, allowing the user to replace modules quickly and easily or to upgrade the system with additional modules at any time. For ease of upgrade and replacement, most modules are offered with the option of a Blind mate interface, where all interface cables are connected to in the chassis hardware and not the module.

Each of the RF/data module positions has a dedicated D type connector that provides access to all the digital data for that module; this is fitted to the chassis backplane.

All of the module alarm outputs, both digital alarms and analogue monitors, are routed to a SCSI-3 connector on the rear panel of the chassis. This connector also has the interface for the summary alarm relay if a module has been fitted to provide this function. This permits the integration of the **ViaLiteHD** equipment into a Maintenance & Control system.

All of the module external power connections (LNA feeds) and chassis backplane external power connections are routed to a second SCSI-3 connector on the rear panel of the chassis.

Module slots 1-14 have a data bus that can be used for sending and receiving data between modules.

### 4.3 Power Interface Management

External power can be provided to, or taken from the chassis via the "Power Concentrator" connector J4, the current should be limited to 1A per pin for single pins or 0.8A per pin for shared pins. The power level (sum of chassis and external power) must be within the capability of the chassis power supplies, see specification in section 5.2.

#### 4.3.1 External backplane power

If the chassis is powered externally the input DC voltage measured at the power concentrator connector should be 12Vdc +/- 0.5V. If chassis power supplies are also fitted we would advise that a low voltage drop diode (i.e. Schottky or similar) be used to OR the power feeds.

It is also possible to provide external power to a chassis fitted with PSUs, for this reason the current share bus (CSB) is available on "Power Concentrator" connector J4. If this option is used the chassis must be interfaced to **ViaLite Communications** approved external power supplies, and the +12Vdc, GND and CSB lines for each power source should be connected in parallel.

**4.3.2 Module bias feed**

It is possible to provide a bias voltage from the modules to connected devices. Dependent on module type, this can be either internally sourced from the module or provided via the "Power Concentrator" connector J4. The current limit is dependent on module type fitted.

**4.4 Alarm Management**

The alarm strategy on the *ViaLiteHD* system caters for all levels of Alarm and Monitoring System complexity from simple module failure LED indication, to local and remote end alarm notification and redundancy switching.

All modules provide an alarm output to the chassis backplane to indicate that the module is present and working correctly. The alarm is fail-safe in that when a working module is withdrawn from the chassis an alarm is registered for that module position.

**4.4.1 "Alarm Concentrator" 50way Connector J1**

All module alarms are provided for the user on the 50 way "Alarm Concentrator" connector on the chassis rear panel. These outputs are "open collector" outputs. There are also two analogue monitors per module position. Their function depends on the type of module fitted.

**4.4.2 Connecting to an "open collector" output.**

The alarm output pin should be connected to a suitable current source (a positive voltage via a 10kohm pull-up resistor is adequate). When the module is in a working (non-alarm) state, the alarm output pin is short circuited to ground by the module. If the module enters an alarm state, the alarm pin is released to a high impedance state and current is no longer drawn from the constant current source. In the case of a positive voltage and pull-up resistor, the voltage on the alarm output pin will rise to indicate the alarm state. It follows that, if a module is removed from the chassis, the alarm will be raised for that module position.

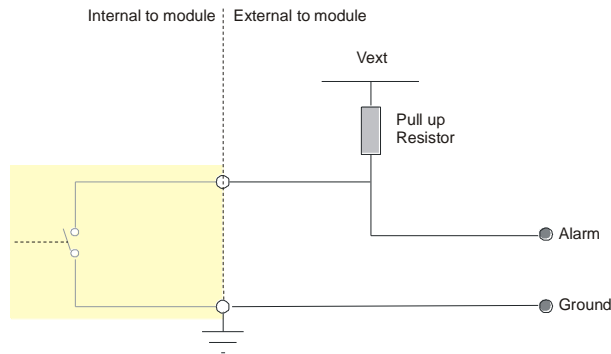

The capability of the open collector is dependent on the module that provides it. The typical capability of the Open Collector/Drain is 50mA maximum current sink and 15V maximum voltage (Vext)

**4.4.3 Summary Alarm**

A summary alarm can be provided if an appropriate module is fitted in the 7HP slot (slot 14). This function can be provided by either of the following modules

- SNMP control module (automatic sensing of module presence)
- Summary alarm relay module (manual setting of module presence)

If no module is fitted the summary alarm relay connections will all be open circuit.

If an appropriate module is fitted there is a volt free 3-pin connection present on "Power Concentrator" Connector J4. The three connections are Normally Open (NO), Common (COM) and Normally Closed (NC).

Condition 1 - Power applied to chassis, no alarms (i.e. normal condition)

- Pin NO is open circuit
- Pin NC is connected to COM

Condition 2 - Power removed from chassis and/or one or more module alarms (i.e. Alarm condition)

- Pin NO is connected to COM
- Pin NC is open circuit

RELAY\_x [1= normally closed, 2=common, 3=normally open]



#### 4.4.4 Module Alarm Defeat

In some installations, the chassis might not be fully populated with modules. In this case, the module alarm output for the vacant positions would register a continuous alarm state and the Summary Alarm Output would also register an alarm condition.

It is very important to ensure that the DIP switches on the Summary alarm relay module or software alarm mask of the SNMP control module for chassis positions where modules are “present” is set correctly. If a DIP switches/software mask is set incorrectly for a “present” module, then if this module were to fail, NEITHER THE MODULE ALARM NOR THE SUMMARY ALARM WOULD DETECT THE FAILURE. The front panel LEDs of the module will always register an alarm condition correctly regardless of the state of the DIP switches/software mask.

#### 4.4.5 Using open collector alarms with controller cards

When a chassis is fitted with a controller card (i.e. SNMP and web controller or summary alarm card) all the alarm lines will be loaded and pulled up. The alarm lines are pulled up to as shown below.

SNMP and web controller      pulled up to 3.3V via 4.7k ohms\* (see warning below)  
 Summary Alarm                pulled up to 5V via 100k ohm, with series diode  
 \*                                  Applying external voltage to these pins may cause damage, contact **ViaLite communications**

Note: the alarm line for slot 14 is always pulled up irrespective of the card status, these cards are all fitted with summary alarm relays.

#### 4.4.6 Using open collector alarms with RF switch and RF splitter cards

When a chassis is fitted with an RF switch or RF splitter card the alarm lines of the adjacent slots will be loaded and pulled up. The alarm lines are pulled up to as shown below.

RF switch or RF splitter                                  pulled up to 5V via 10k ohm, with series diode

### 4.5 Heat management

The chassis is designed to meet its environmental specification, when operating in a typical configuration. A typical configuration is all modules populated (13\*Transceiver, 1\*SNMP, 2\*PSU), chassis power consumption 67 watts, no external DC power input or DC output and no obstruction to convection air path.

Under normal operating conditions module slots 1-14 are cooled by convection, module slots 15 and 16 are force air cooled with exhaust at rear of the chassis. The chassis will continue to run without the forced cooling provided by the integrated fan but its operating temperature will be reduced.

- Single PSU only fitted:                                  maximum operating temperature reduced by -5°C
- Airflow above chassis blocked:                                  maximum operating temperature reduced by -10°C
- Airflow below chassis blocked:                                  maximum operating temperature reduced by -5°C
- No forced air:    maximum operating temperature reduced by -10°C

Also see section 5.2 that details the typical power consumption of most common types of modules.

#### 4.6 Unused module positions

We advised that all unused slots be fitted with blanking panels. Different widths of blanking panel are available these fit the 5HP general purpose (slots 1-13), 7HP controller card slots (slot 14), 6HP power supply slots (slots 15,16). They can be used with any **ViaLiteHD** 19inch chassis and will prevent accidental/unwanted access and the ingress of dust. Blanking panels available are.

- |         |  |             |
|---------|--|-------------|
| • 85044 | <b>ViaLiteHD</b> Blank Panel, 5HP          | Slots 1-13  |
| • 85050 | Reusable <b>ViaLiteHD</b> Blank Panel, 5HP | Slots 1-13  |
| • HPS-0 | <b>ViaLiteHD</b> Blank Panel, 6HP          | Slot 15, 16 |
| • 85046 | <b>ViaLiteHD</b> Blank Panel, 7HP          | Slot 14     |
| • 85049 | Reusable <b>ViaLiteHD</b> Blank Panel, 7HP | Slot 14     |

Contact **ViaLite Communications** or your local agent for more details.

There are two types of the 5 and 7 HP blanking panels. The standard blanking panels are fitted with snap in plastic barbs. These are designed to permanently hold the blanking panel in position. Please ensure that you have fully planned the configuration of your chassis, as the plastic barbs are a close tolerance fit and removal results in the barbs being broken; the panel should then be discarded.

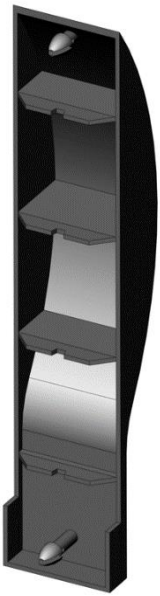

85044 *ViaLiteHD* Blank Panel, 5HP

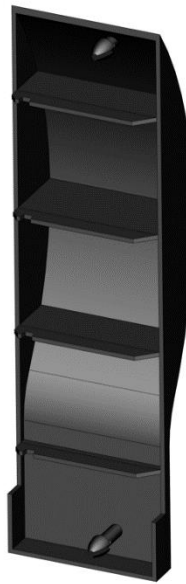

85046 *ViaLiteHD* Blank Panel, 7HP

There are also reusable panels available (85049 and 85050) with handles to keep them in place.

The 6 HP blanking panels are fitted with handles to secure them into either slot 15 or 16. These are design to permanently hold the blanking panel in position.

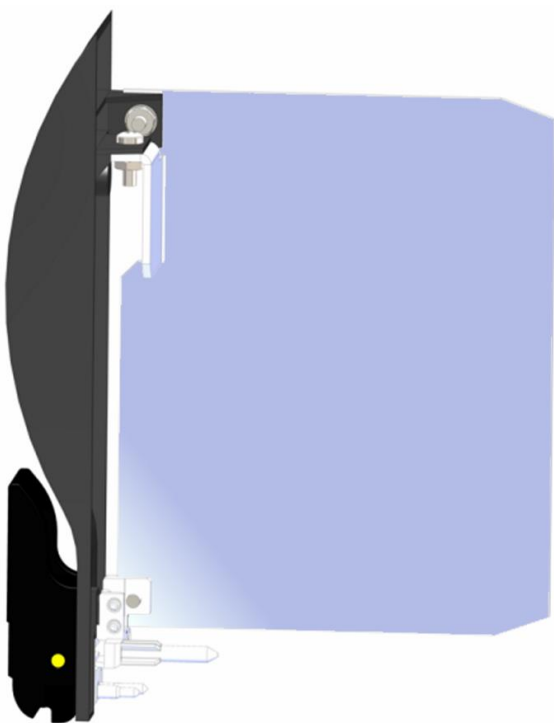

HPS-0 *ViaLiteHD* Blank Panel, 6HP

#### 4.7 Minimum power supply load

If the chassis power supplies are operating in dual redundant configuration, there should be a minimum load of 12 watts to ensure that both power supplies are active, below this level one power supply may be in idle mode (its LED will not be illuminated). If necessary a redundancy load module can be supplied, to fit into any unused slots to meet this minimum power requirement, see section 5.3.

**4.8 Chassis Specification**

	HRK3	HRK3-DC
Description	19" Rack Mounting Chassis	
Max. No. of 5HP modules	13 (in slots 1-13 only)	
Max. No. of 7HP modules	1 (in slots 14 only)	
Max. No. of 6HP modules	2 (in slots 15,16 only)	
19" Rack Mounting	Yes	
Desktop Mounting	Not Suitable (use <i>ViaLite Classic</i> products)	
Width, internally	84 HP	
Width, externally	483 mm	
Height, internally	3U	
Height, externally	134 mm	
Depth, externally	265 mm	
Maximum weight	1.8 kg (chassis ONLY), 7.2 kg (chassis and slot modules)	
Cooling	Convection (slots 1-14); Forced air (slots 15,16) exhaust at rear	
Operating Temperature	-10°C to +50°C	
Humidity	0-95%, Non-condensing	
Power Supply compatibility	HPS	HPS-DC
Chassis power input	2 x IEC 60320, 3 pins each	2 x screw terminal, 2 pins each
Chassis earth	Rear panel M4 stud	
Fan power	IDC male, Dual row 6 pin • DC power to rear mounted fan cassette	
Data Connector	9way Female D with screw-lock termination at the rear of each module position (1 per 5 HP slot). • Data input/output for individual modules.	
Alarm Concentrator Connector J1: SCSI-3	This concentrates the alarms from each module to a common point. • Open Drain alarm (1 per 5 & 7HP slot) • Power Good (2 per 6 HP slot) • Analogue Monitor (2 per 5 HP slot) • Ground Type: 50 way connector Har-mik® female [SCSI-3]	
Power Concentrator Connector J4: SCSI-3	This concentrates the power connections and summary alarms to a common point. • +12Vdc backplane power • Ground • Current sharing bus • Summary Alarm relay (optional) • External LNA bias (1 per 5 HP slot) Type: 50 way connector Har-mik® female [SCSI-3]	
<i>ViaLiteHD</i> plug-in module compatibility	All types	

**4.9 Chassis connector pinouts**

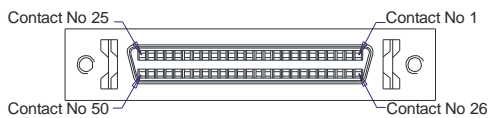

Chassis connector:  
50 way SCSI-3 Har-mik® female

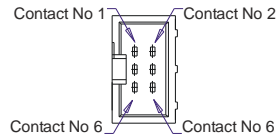

Fan connector:  
6 way IDC dual row male

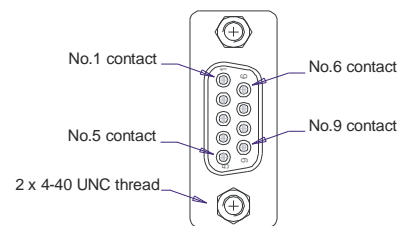

Module connector:  
9 way D-Type connector female

All connectors are viewed looking into connector from mating interface  
Each connector is shown in the correct orientation for normally mounted 3U chassis

Pin Out – J32 “Fan power” connector

Pin	Chassis Fan	Pin	Chassis Fan	Pin	Chassis Fan
1	+12Vdc	3	+12Vdc	5	GND
2	+12Vdc	4	GND	6	GND

Note: Colour indicates relevant connector drawing

- An optional mating half cable is available for use in *ViaLiteHD* system

Pin out – J1 “Alarm Concentrator” connector\*

Pin	Chassis J1*	Pin	Chassis J1*	Pin	Chassis J1*	Pin	Chassis J1*
1	GND	14	Analogue_monitor_B_8	27	ALARM_3	40	Analogue_monitor_B_11
2	ALARM_2	15	Analogue_monitor_B_10	28	ALARM_5	41	Analogue_monitor_B_13
3	ALARM_4	16	Analogue_monitor_B_12	29	ALARM_7	42	GND
4	ALARM_6	17	GND	30	ALARM_9	43	GND
5	ALARM_8	18	GND	31	ALARM_11	44	Analogue_monitor_A_2
6	ALARM_10	19	Analogue_monitor_A_1	32	ALARM_13	45	Analogue_monitor_A_4
7	ALARM_12	20	Analogue_monitor_A_3	33	GND	46	Analogue_monitor_A_6
8	ALARM_14	21	Analogue_monitor_A_5	34	ALARM_P_1	47	Analogue_monitor_A_8
9	ALARM_P_2	22	Analogue_monitor_A_7	35	Analogue_monitor_B_1	48	Analogue_monitor_A_10
10	GND	23	Analogue_monitor_A_9	36	Analogue_monitor_B_3	49	Analogue_monitor_A_12
11	Analogue_monitor_B_2	24	Analogue_monitor_A_11	37	Analogue_monitor_B_5	50	GND
12	Analogue_monitor_B_4	25	Analogue_monitor_A_13	38	Analogue_monitor_B_7		
13	Analogue_monitor_B_6	26	ALARM_1	39	Analogue_monitor_B_9		

Note: See your module handbooks for assignment and function of the “Analogue\_monitor” pins

#### 4.9.1 Chassis connector pin out J4 & J19-31

The pin out of connectors J4 & J19-31 has been changed, to add additional functionality to the chassis. Check serial number to find correct pin out. See section 4.9.1.1 and 4.9.1.2 below. The approximate last shipment date of the early revision racks is July 2013, contact **ViaLite Communications** for more details.

##### 4.9.1.1 Chassis connector pin out J4 & J19-31 - serial numbers below and including SN1221901

Below is the pin out of J4 and J19-J31 for all early production chassis with serial number below and including SN1221901.

Pin Out – J19 to J31 “Module Data” connectors

If connected to a **TX module** (single transmitter)

Pin	Module	Pin	Module	Pin	Module
1	GND	4	<i>Do not connect</i>	7	<i>RX_422_OUT-</i>
2	<i>Do not connect</i>	5	<i>Do not connect</i>	8	<i>RX_232_OUT [TTL_OUT]*</i>
3	<i>Do not connect</i>	6	<i>RX_422_OUT+</i>	9	<i>RX_RTS_485</i>

If connected to a **RX module** (single receiver)

Pin	Module	Pin	Module	Pin	Module
1	GND	4	<i>TX_232_IN [TTL_IN]*</i>	7	<i>Do not connect</i>
2	<i>TX_422_IN+</i>	5	<i>Do not connect</i>	8	<i>Do not connect</i>
3	<i>TX_422_IN-*</i>	6	<i>Do not connect</i>	9	<i>Do not connect</i>

If connected to a **TRX module** (transceiver)

Pin	Module	Pin	Module	Pin	Module
1	GND	4	<i>TX_232_IN [TTL_IN]*</i>	7	<i>RX_422_OUT-</i>
2	<i>TX_422_IN+</i>	5	<i>Do not connect</i>	8	<i>RX_232_OUT [TTL_OUT]*</i>
3	<i>TX_422_IN-*</i>	6	<i>RX_422_OUT+</i>	9	<i>RX_RTS_485</i>

If connected to a **DTX module** (dual transmitter)

Pin	Module	Pin	Module	Pin	Module
1	GND	4	<i>TX1_232_IN [TTL1_IN]*</i>	7	<i>TX2_422_IN-</i>
2	<i>TX1_422_IN+</i>	5	<i>Do not connect</i>	8	<i>TX2_232_IN [TTL2_IN]*</i>
3	<i>TX1_422_IN-</i>	6	<i>TX2_422_IN+</i>	9	<i>Do not connect</i>

If connected to a **DRX module** (dual receiver)

NOT supported

If connected to a **Serial module** (transceiver)

Pin	Module	Pin	Module	Pin	Module
1	GND	4	<i>TX_232_IN [TTL_IN]*</i>	7	<i>RX_422_OUT-</i>
2	<i>TX_422_IN+</i>	5	<i>Do not connect</i>	8	<i>RX_232_OUT [TTL_OUT]*</i>
3	<i>TX_422_IN-*</i>	6	<i>RX_422_OUT+</i>	9	<i>RX_RTS_485</i>

Note: Data on the connector is only for the module fitted in that 5HP slot and is printed beneath (J19 = slot 1, J20 = slot 2 ... J31 = Slot 13)  
Connections in *Blue text* are optional and only available on some types of module

Pin out – J4 “Power Concentrator” connector\*

Pin	Chassis J4*	Pin	Chassis J4*	Pin	Chassis J4*	Pin	Chassis J4*
1	CSB	14	GND	27	Relay_1 (NC)	40	LNA_feed_3
2	Relay_2 (COM)	15	LNA_feed_2	28	GND	41	LNA_feed_5
3	GND	16	LNA_feed_4	29	GND	42	LNA_feed_7
4	GND	17	LNA_feed_6	30	GND	43	LNA_feed_9
5	GND	18	LNA_feed_8	31	+12Vdc	44	LNA_feed_11
6	+12Vdc	19	LNA_feed_10	32	+12Vdc	45	LNA_feed_13
7	+12Vdc	20	LNA_feed_12	33	+12Vdc	46	GND
8	+12Vdc	21	GND	34	+12Vdc	47	GND
9	+12Vdc	22	GND	35	+12Vdc	48	GND
10	+12Vdc	23	GND	36	+12Vdc	49	GND
11	+12Vdc	24	GND	37	+12Vdc	50	GND
12	+12Vdc	25	GND	38	LNA_feed_1		
13	+12Vdc	26	Relay_3 (NO)	39	GND		

Note: The Chassis and power ground are common

#### 4.9.1.2 Chassis connector pin out J4 & J19-31 - serial numbers above and including SN1221902

Below is the pin out of J4 and J19-J31 for all later production chassis with serial number above and including SN1221902.

The backplane is marked '**Issue C**' – this description can be found on the PCB between slot 13 and 14 when viewed from the front.

Pin Out – J19 to J31 “Module Data” connectors

If connected to a **TX module** (single transmitter)

Pin	Module	Pin	Module	Pin	Module
1	GND	4	<i>Do not connect</i>	7	<i>RX_422_OUT-</i>
2	<i>Do not connect</i>	5	<i>Do not connect</i>	8	<i>RX_232_OUT [TTL_OUT]*</i>
3	<i>Do not connect</i>	6	<i>RX_422_OUT+</i>	9	<i>RX_RTS_485</i>

If connected to a **RX module** (single receiver)

Pin	Module	Pin	Module	Pin	Module
1	GND	4	<i>TX_232_IN [TTL_IN]*</i>	7	<i>Do not connect</i>
2	<i>TX_422_IN+</i>	5	<i>Do not connect</i>	8	<i>Do not connect</i>
3	<i>TX_422_IN-*</i>	6	<i>Do not connect</i>	9	<i>Do not connect</i>

If connected to a **TRX module** (transceiver)

Pin	Module	Pin	Module	Pin	Module
1	GND	4	<i>TX_232_IN [TTL_IN]*</i>	7	<i>RX_422_OUT-</i>
2	<i>TX_422_IN+</i>	5	<i>Do not connect</i>	8	<i>RX_232_OUT [TTL_OUT]*</i>
3	<i>TX_422_IN-*</i>	6	<i>RX_422_OUT+</i>	9	<i>RX_RTS_485</i>

If connected to a **DTX module** (dual transmitter)

Pin	Module	Pin	Module	Pin	Module
1	GND	4	<i>TX1_232_IN [TTL1_IN]*</i>	7	<i>TX2_422_IN-</i>
2	<i>TX1_422_IN+</i>	5	<i>Do not connect</i>	8	<i>TX2_232_IN [TTL2_IN]*</i>
3	<i>TX1_422_IN-</i>	6	<i>TX2_422_IN+</i>	9	<i>Do not connect</i>

If connected to a **DRX module** (dual receiver)

Pin	Module	Pin	Module	Pin	Module
1	GND	4	<i>RX1_232_OUT [TTL1_OUT]*</i>	7	<i>RX2_422_OUT-</i>
2	<i>RX1_422_OUT+</i>	5	<i>RX1_RTS_485</i>	8	<i>RX2_232_OUT [TTL2_OUT]*</i>
3	<i>RX1_422_OUT-</i>	6	<i>RX2_422_OUT+</i>	9	<i>RX2_RTS_485</i>

If connected to a **Serial module** (transceiver)

Pin	Module	Pin	Module	Pin	Module
1	GND	4	<i>TX_232_IN [TTL_IN]*</i>	7	<i>RX_422_OUT-</i>
2	<i>TX_422_IN+</i>	5	<i>Do not connect</i>	8	<i>RX_232_OUT [TTL_OUT]*</i>
3	<i>TX_422_IN-*</i>	6	<i>RX_422_OUT+</i>	9	<i>RX_RTS_485</i>

Note: Data on the connector is only for the module fitted in that 5HP slot and is printed beneath (J19 = slot 1, J20 = slot 2 ... J31 = Slot 13)

Connections in *Blue* are optional and only available on some types of module

Pin out – J4 “Power Concentrator” connector\*

Pin	Chassis J4*	Pin	Chassis J4*	Pin	Chassis J4*	Pin	Chassis J4*
1	CSB	14	GND	27	Relay_1 (NC)	40	LNA_feed_3
2	Relay_2 (COM)	15	LNA_feed_2	28	GND	41	LNA_feed_5
3	GND	16	LNA_feed_4	29	GND	42	LNA_feed_7
4	GND	17	LNA_feed_6	30	BUC_feed_1	43	LNA_feed_9
5	GND	18	LNA_feed_8	31	BUC_feed_3	44	LNA_feed_11
6	BUC_feed_2	19	LNA_feed_10	32	BUC_feed_5	45	LNA_feed_13
7	BUC_feed_4	20	LNA_feed_12	33	BUC_feed_7	46	GND
8	BUC_feed_6	21	GND	34	BUC_feed_9	47	GND
9	BUC_feed_8	22	GND	35	BUC_feed_11	48	GND
10	BUC_feed_10	23	GND	36	BUC_feed_13	49	GND
11	BUC_feed_12	24	GND	37	+12Vdc	50	GND
12	+12Vdc	25	GND	38	LNA_feed_1		
13	+12Vdc	26	Relay_3 (NO)	39	GND		

Note: The Chassis and power ground are common

#### 4.9.2 LNA feed and BUC feed pin assignment for different module types

The function of J4 pins described as LNA\_feed and BUC\_feed can vary dependant on the module type. The table below shows pin assignment for all different module types.

The "X" used on the pin assignment indicates the slot to which the LNA or BUC feed is connected (i.e. LNA\_feed\_8 is connected to slot 8).

When an "A" or "B" suffix is shown this is used to indicated which channel of the dual module (i.e. "LNA\_feed\_A\_X" or the LNA or BUC feed) is connected to, it will match with the connector letter on the rear panel. Channel "A" is the upper channel and channel "B" is the lower channel. Transceivers always have the receiver as the upper channel and the transmitter as the lower channel.

The LNA and BUC feed will only be connected if the module in the slot has the appropriate functionality.

J4 pin assignment for a transmitter, TX module

	Chassis J4, LNA_feed_X	BUC_feed_X (J4)
TX	LNA_feed_X	NC (Not Connected)

J4 pin assignment for a receiver, RX module

	Chassis J4, LNA_feed_X	BUC_feed_X (J4)
RX	NC (Not Connected)	BUC_feed_X

J4 pin assignment for a transceiver, TRX module

	Chassis J4, LNA_feed_X	BUC_feed_X (J4)
TRX	LNA_feed_X	BUC_feed_X

J4 pin assignment for a dual transmitter, DTX module

	Chassis J4, LNA_feed_X	BUC_feed_X (J4)
DTX	LNA_feed_A_X	LNA_feed_B_X

J4 pin assignment for a dual receiver, DRX module

	Chassis J4, LNA_feed_X	BUC_feed_X (J4)
DRX	BUC_feed_A_X	BUC_feed_B_X

J4 pin assignment for a Switch, SW module

	Chassis J4, LNA_feed_X	BUC_feed_X (J4)
SW	Switch_feed_X	NC (Not Connected)

J4 pin assignment for a Splitter, SP module

	Chassis J4, LNA_feed_X	BUC_feed_X (J4)
SP	Splitter_feed_X	NC (Not Connected)

J4 pin assignment for a single Amplifier, AMP module

	Chassis J4, LNA_feed_X	BUC_feed_X (J4)
AMP	Amplifier_feed_X	NC (Not Connected)

J4 pin assignment for a Dual Amplifier, AMP module

	Chassis J4, LNA_feed_X	BUC_feed_X (J4)
AMP	Amplifier_feed_A_X	Amplifier_feed_B_X

#### 4.10 Fan replacement

If the fan is not turning, the fan cartridge assembly should be replaced. This can be completed without disconnecting the chassis from the mains supply.

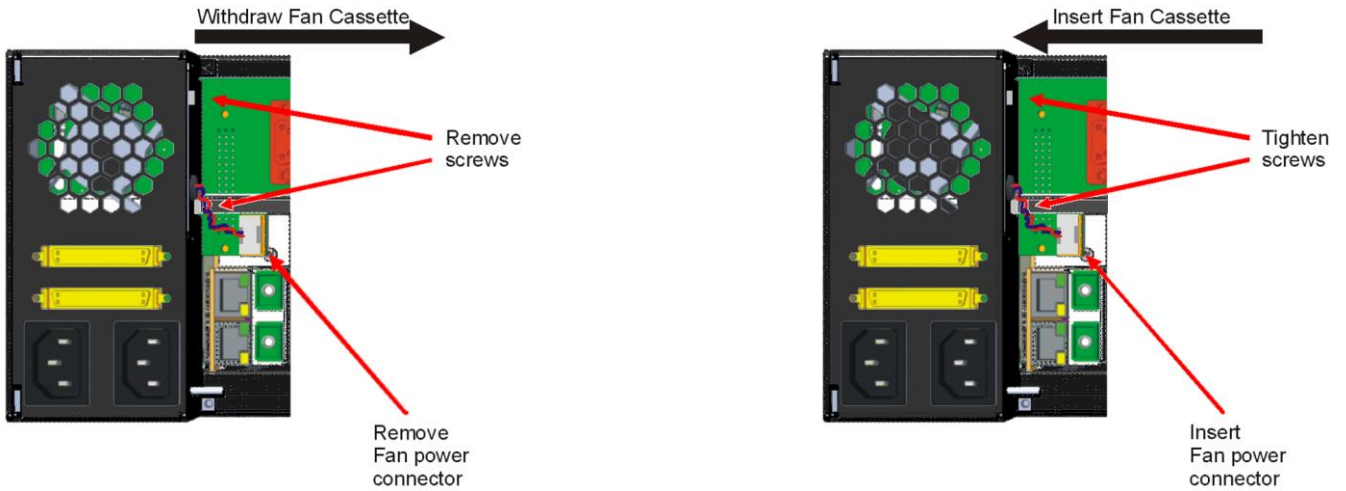

Please ensure that when the fan is outside of its safety enclosure it is disconnected from its power connector

The fan is removed by the following procedure.

- Disconnect the fan power connector J32.
- Using a magnetic screw driver, remove the two screws fixing the fan cassette
- Withdraw the fan cassette

The fan is replaced by the following procedure.

- Insert the fan cassette.
- Using a magnetic screw driver fix the cassette in place using the two screws provided
- Connect the fan power connector J32,  
NOTE: The FAN connector is polarised, match the slot in the receptacle with the key of the plug.
- Check that air is being exhausted.

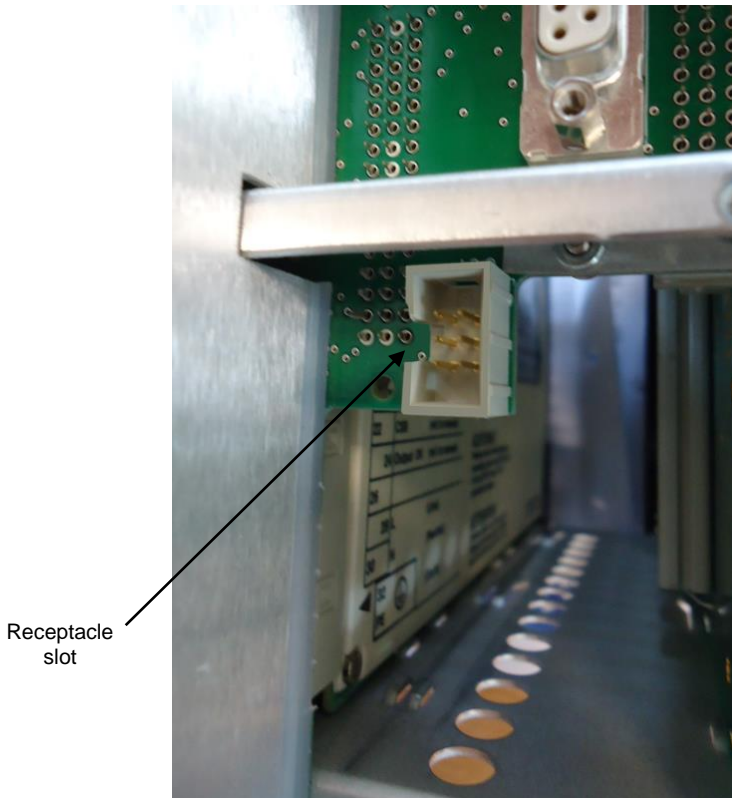

View of fan connector showing polarisation *ViaLiteHD* Power Supplies



## 5 ViaLiteHD power supplies

### 5.1 6HP Chassis Power Supplies

The HPS series power supplies provide DC power to all plug-in modules in the 19" chassis. Two versions are offered, HPS with universal mains input and HPS-DC with wide range DC input. Either one or two HPS modules can be fitted. Two HPS modules will provide dual redundant operation. Separate supply inputs mean that they can be operated from different supplies for even higher levels of availability. During normal operation, the supplies current share to maximise reliability. In the event of a failure all the chassis current will be provided by the remaining operational module. The front panel LED provides a visual indication of failure, and a power good alarm output is available for use at the "Alarm Concentrator" connector.

The modules are fan-cooled for maximum reliability and each PSU offers an MTBF of 270,000 hours at an ambient temperature of 40°C.

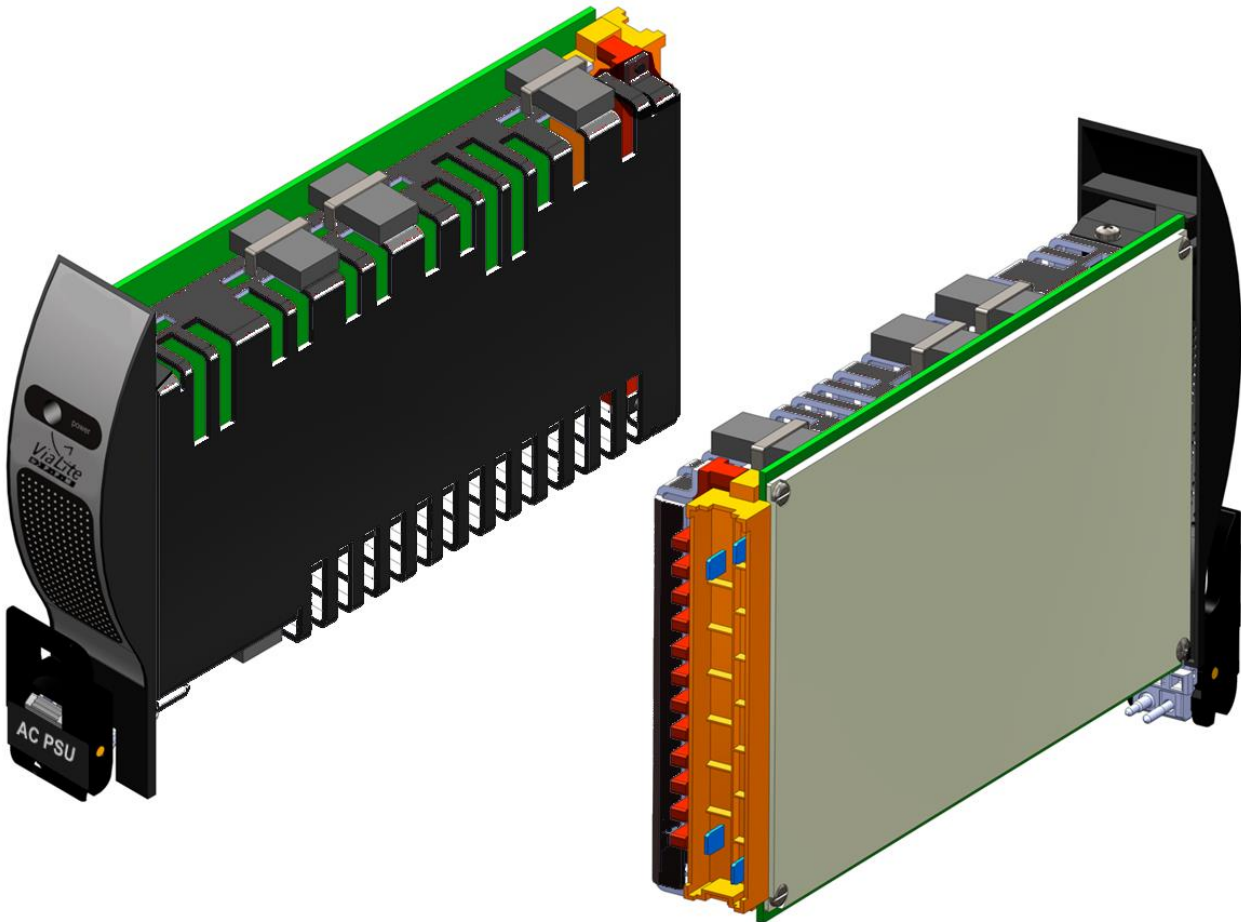

The HPS power supply has a wide range alternating current (AC) input and can operate from 110V and 230V nominal mains supplies. Mains power is applied at the rear of the chassis via an earthed IEC60320 connector, and regulated direct current (DC) power is supplied to the chassis backplane PCB for distribution to the plug-in modules. This connector is also used for reporting PSU alarm status.

For DC versions HPS-DC, power is applied at the rear of the chassis via a 2-pole screw terminal connector; it will operate from a wide range DC input 20-72Vdc.

Both types of power supply are internally fused; this fuse is only expected to fail under fault conditions. The fuse is located internally underneath the earthed safety cover; this is not user serviceable and must be returned to **ViaLite Communications** for replacement.

On the front panel the module has a single LED indicator. This reports the status of the module. IF the LED is **GREEN** the module is operating in its normal non-alarm state. If the LED is OFF, the power supply is not supplying 12V and has either failed or is in standby mode, see section 4.7.



### 5.1.1 Specification

	HPS-3	HPS-3-DC
Description	Wide input range AC power supply	Wide input range DC power supply
Dimensions, internal (W x H)	6HP * 3U	
Dimensions, external (W x H x D)	188 x 129 x 30 mm	
Weight	0.6kg	
Input Supply Power	110V or 230V nominal at 50/60Hz 88 - 264V absolute range	20 – 72Vdc
Fuse	Internal, 4 A / 250 Vac	Internal, 10 A / 125 V
Efficiency	75%	84%
Switch on current	<20A @ 230Vac	<6.5A @ 20V input
Output voltage	12.0 +/- 0.5Vdc	
Output ripple	50mV	
Maximum input current	1.6A	6.5A
Maximum output power	100 W single PSU 180 W dual PSUs	
Minimum load power	12 W	
Inlet air temperature	-10 to +50°C	
Derating >+50°C	1.5% / °C, absolute maximum 70°C	3% / °C, absolute maximum 70°C
Hot-swapping and Dual Redundant	Yes	
Output overload	Built in overload protection switches output OFF and automatically restarts at 110% nominal current	
Output over voltage protection	19Vdc	
Status Indicators	Front panel GREEN power LED	
Rear Panel alarm outputs	Power Good on J1 "Alarm Concentrator" connector 12V = Normal operation; 0V = Alarm	
MTBF @40°C	270 000 hours at 100% load	

### 5.2 19" Chassis Power Requirements

The exact power requirements of modules are given in the module handbooks, however the details below maybe used to approximate the power output requirements from the chassis mounted PSUs. The input power requirements can be calculated by using the power supply efficiency given in section 5.1.1

Single Transmitter	2.0 W Typical per slot, excluding LNA/LNB power
Single DWDM Transmitter	3.2 W / 4.0W / 6.0 Typical per slot at 25/50/70°C, laser types "D", "E" and "K", excluding LNA/LNB power
Single Receiver	1.5 W Typical per slot
Dual Transmitter	4.0 W Typical per slot, excluding LNA/LNB power
Dual Receiver	2.6 W Typical per slot
Transceiver	3.3 W Typical per slot, excluding LNA/LNB power
Amplifier	2.4W Typical per slot
Serial Digital	0.7W Typical per slot
Switch	0.4W Typical per slot
Splitter	0.4W Typical per slot
Ethernet	1.9W Typical per slot
SNMP controller	4.0 W Typical per slot
Alarm and Load	1 W Typical, plus 0/3/6/9/12 W load, per slot
Redundancy load module	1 W Typical, plus 0/3/6/9/12 W load, per slot
LNA/LNB feed	up to an additional 14.6 W per slot, if used (efficiency 89% typically and 80% minimum).
AC to DC efficiency	see section 5.1.1
DC to DC efficiency	see section 5.1.1

### 5.3 Redundancy load module, HRL

The redundancy load module ensures that when redundant power supplies are used, there is enough current for both power supplies to be active. The module can provide a maximum load of 12 watts, this load can be switched in 3 watt steps. It can be fitted into a standard 5HP slot.

The module can provide a maximum load of 12 watts, but this load can be switched in 3 watt steps

Load	0 / 3 / 6 / 9 / 12 watts switched
Control	via switch selection, using four DIP switches
Setting*	1 or 2 modules fitted all four switches ON
	3 or 4 modules fitted three switches ON
	5 or 6 modules fitted two switches ON
	7 or 8 modules fitted one switch ON
	9 or more modules fitted

\* These calculations assume the lowest possible power consumption to meet the minimum load specification; a more accurate calculation can be made by either using the modules datasheets or the estimates in section 5.2.

**5.3.1 Redundancy load module, plug-in card**

The redundancy load module does not have a microprocessor, I2C bus or an alarm line. It will not be recognised by the ViaLiteHD SNMP and web controller or included in the GUI. The alarm line of the module is resistively pulled down.

The *ViaLiteHD* Redundancy load module may have hot surfaces when operating under full load. Suitable precaution should be taken when handling this device, see safety instructions.



**5.3.2 Redundancy load module, front panel**

The redundancy load plug-in module has two front panel LEDs for indication of the state of the module. The following table shows the operation

	Colour	SNMP and Web controller
LED1	GREEN	Normal
	No light	No power
LED2	GREEN	LOAD ON (Any load resistor active)
	No light	LOAD OFF

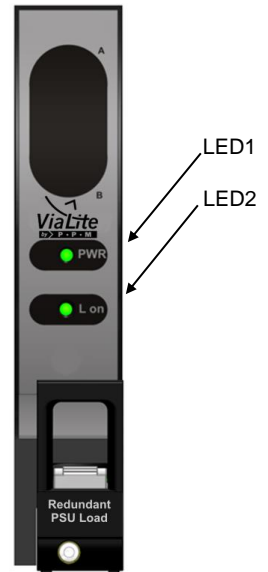

**5.3.3 Redundancy load module, DIP switches**

The *ViaLiteHD* Redundancy load module has one four way DIP switch (SW5) that configures the load.

The switch is on the rear side of the module and can be accessed with the module partially withdrawn.

SW5	Name	OFF	ON
Position 1	Load 1	Load resistor OFF	Load resistor ON
Position 2	Load 2	Load resistor OFF	Load resistor ON
Position 3	Load 3	Load resistor OFF	Load resistor ON
Position 4	Load 4	Load resistor OFF	Load resistor ON



**5.3.4 Redundancy load module, setting the load DIP switches**

Detail of the DIP switch positions are given in section 5.3.3. If you wish to activate any of the resistive loads follow the sequence below.

1. Calculate the additional load required, see section 5.1.1., 5.2 and 5.3
2. Round this load up to the nearest three watt step
3. Switch the appropriate number of DIP switches of SW5 to the ON position

Note. If sufficient load is not applied, it is possible for a PSU front panel power LED to be **GREEN** and the “power good” output to be LOW (alarm state), in this case the power supply will not be registered by the **ViaLiteHD** summary alarm and SNMP and web controller cards.

**5.3.5 Redundancy load module, using with SNMP and controller module**

The redundancy load module is not fitted with a micro controller or I2C memory, so it is not visible on the ViaLiteHD controller GUI or accessible via SNMP.

**5.4 Power Supply HPS-CS-3 for use with OEM modules (HRx-xx-xM-xx)**

The HPS-CS-3 is a Panel Mounting 12V DC output, mains input supply with a 15 way Molex connector for connection to **ViaLiteHD** OEM modules (HRx-xx-xM-xx).

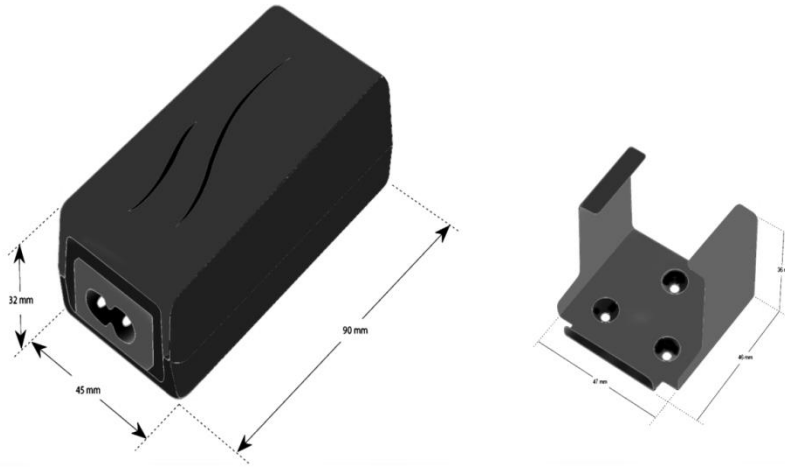

**HPS-CS-3**

Description	Wide input range AC power supply
Dimensions, external (W x H x D)	90 * 45 * 32 mm, supplied with mounting bracket
Lead length	1700mm typical
Weight	0.2kg
Input Supply Power	110V or 230V nominal at 50/60Hz 90 - 264V, 47-63Hz absolute range
Efficiency	83%
Output voltage	12.0 +/- 0.5Vdc
Output ripple	100mV pk-pk
Maximum output power	16 W, 1.5A @ 12V
Minimum load power	0 W
Status Indicators	<b>GREEN</b> power LED
Operating temperature	-20 to +60°C, derate above +40°C
Storage temperature	-20 to +85°C
Derating >+40°C	2.4% / °C above +40°C, absolute maximum 60°C
Input protection	Over voltage protection
Output protection	Short circuit protected (Polyswitch)
Insulation class	Class 2
Power input	IEC-60320 2 pin input socket C8, supplied with matching power lead
Power output	Molex, CGRID3, 15 way socket (female) Pin 4 = GND Pin 5=+12V Power connections match the requirements of <b>ViaLiteHD</b> OEM modules (HRx-xx-xM-xx) All other pins are unconnected



Illustration of IEC-60320 2 pin input socket C8 configuration



HPS-CS-3 with supplied mounting bracket (power lead not shown)

## 6 Installation Guide

### 6.1 Chassis Installation

The *ViaLiteHD* Power Supply Modules do not have an isolating switch on the mains voltage inlet. For this reason, the *ViaLiteHD* Chassis must be installed within easy reach of a clearly labelled dual pole mains isolation switch, which supplies the equipment.

The *ViaLiteHD* 19" chassis is designed to fit 19" racks and occupies a height of 3U. The chassis is provided with flanges for mounting to the rack. The Chassis backplane contains 9-way D-type data connectors for each module position. This provides user access to data connections from relevant modules (depends on module type). The pin outs of these connectors depend on the type of module in use in that chassis position. There is also an "Alarm concentration" connector providing access to alarms and monitoring information from all modules and a "Power Concentration" connector that provides access to various power feeds and the summary alarm.

### 6.2 6HP Power Supply Module Installation (slots 15 and 16)

The *ViaLiteHD* Power Supply Module powers the plug-in modules via the Chassis backplane PCB. It occupies slots 15 and 16.

To install a 6HP power supply module

- Push the release button of the module handle down and simultaneously pull the top of the handle forwards.
- Align the module upright and perpendicular to the front face of the chassis so that the PCB slides into the "straight" card guides top and bottom.
- Gently push the module down its guide, applying pressure via the handle; you may also apply pressure just above the LED. Avoid applying pressure on the ventilation grill.
- As the module is fully mated the top of the handle should snap back and lock in position.
- The pawls of the handle should be fully engaged in the matching slots.

To remove a 6HP power supply module

- Push the release button of the module handle down and simultaneously pull the top of the handle forwards.
- Apply pressure via the handle and gently withdraw the module from the chassis.

### 6.3 5HP Standard Plug-in Modules (slots 1-13)

All *ViaLiteHD* plug-in modules are hot-swappable, so it is not necessary to power-down the chassis before inserting a module. All standard optical connectors are retained by the module. So it will be necessary to either disconnect any cables or have a sufficiently long service loop.

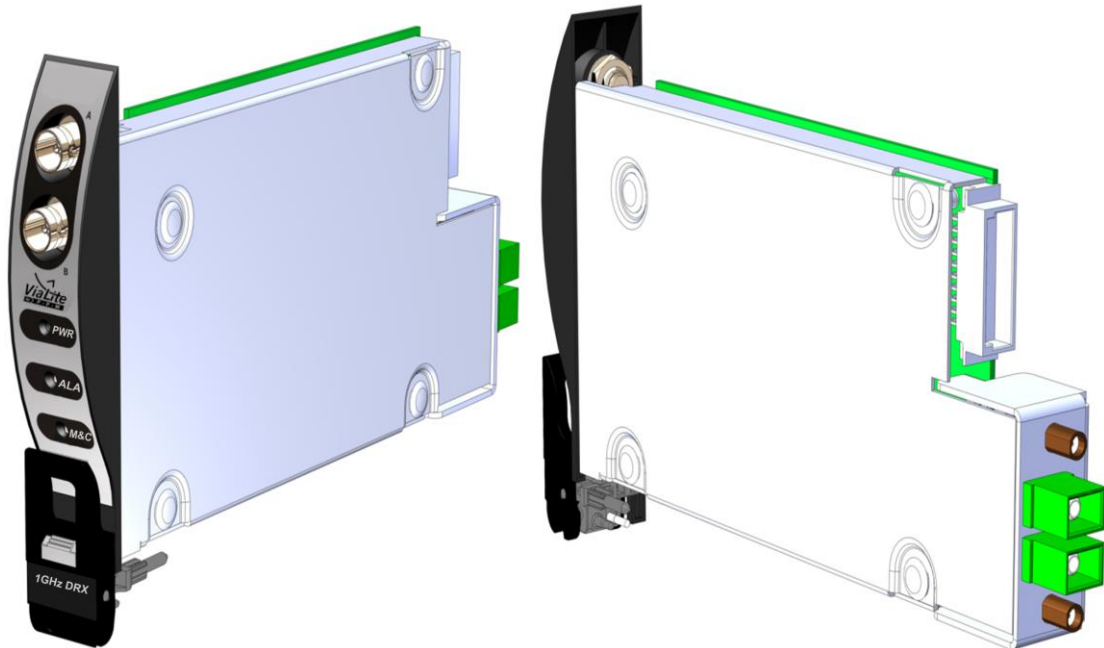

To install a 5HP Standard module and matching interface plate

- The protective covers on the connectors may be left in place.
- Push the release button of the module handle down and simultaneously pull the top of the handle forwards.
- Align the module upright and perpendicular to the front face of the chassis so that the PCB slides into the "crow's feet" card guides top and bottom.
- Gently push the module down its guide, applying pressure via the handle, you may also apply pressure between the LED and test connector.
- As the module is fully mated the top of the handle should snap back and lock in position.
- The pawls of the handle should be fully engaged in the matching slots.
- If power is applied to the chassis the module power LED should light as soon as the module is fully inserted
- Remove protective covers and connect any interface cables



To remove a 5HP Standard module

- Disconnect any cables if necessary
- Push the release button of the module handle down and simultaneously pull the top of the handle forwards.
- Apply pressure via the handle and gently withdraw the module from the chassis.

#### 6.4 5HP Blindmate Plug-in Modules (slots 1-13)

All **ViaLiteHD** plug-in modules are hot-swappable, so it is not necessary to power-down the Chassis before inserting a module. All blind mate optical connectors are provided with spring loaded covers that will protect the optics of any inserted modules. As there is no cover on the opposite side, mating cables should not be installed until the slot modules are present. There are 2 types of blind mate, type 'D' and type 'E' as shown in the images below. A type 'E' module is not compatible with a type 'D' rack plate. Likewise a type 'D' module is not compatible with a type 'E' rack plate. Should this happen in error stoppers will prevent any damage to the connectors.

To install a blind mate module and matching interface plate

- Firstly inspect the rear Blind mating plate, ensure that the connector barrels are fitted into all RF connectors (Type 'D') and are centrally aligned.
- Remove protective covers from the inside face of the optical connector if fitted
- Ensure that the rear plate is free of any dust and contamination, if necessary clean with filtered compressed air.
- Screw the Blind mating plate into the appropriate slot at the rear of the chassis, using the supplied screws and a "Poizdriv Number 1" screwdriver
- Push the release button of the module handle down and simultaneously pull the top of the handle forwards.
- Remove the protective cover from the modules optical connectors and clean any optical connectors
- Align the module upright and perpendicular to the front face of the chassis so that the PCB slides into the "crow's feet" card guides top and bottom.
- Gently push the module down its guide, applying pressure via the handle, you may also apply pressure between the LED and test connector.
- As the module is fully mated the top of the handle should snap back and lock in position.
- The pawls of the handle should be fully engaged in the matching slots.
- If power is applied to the chassis the module power LED should light as soon as the module is fully inserted
- Connect any interface cables to the blind mate plate.

#### Type 'D' blind mates

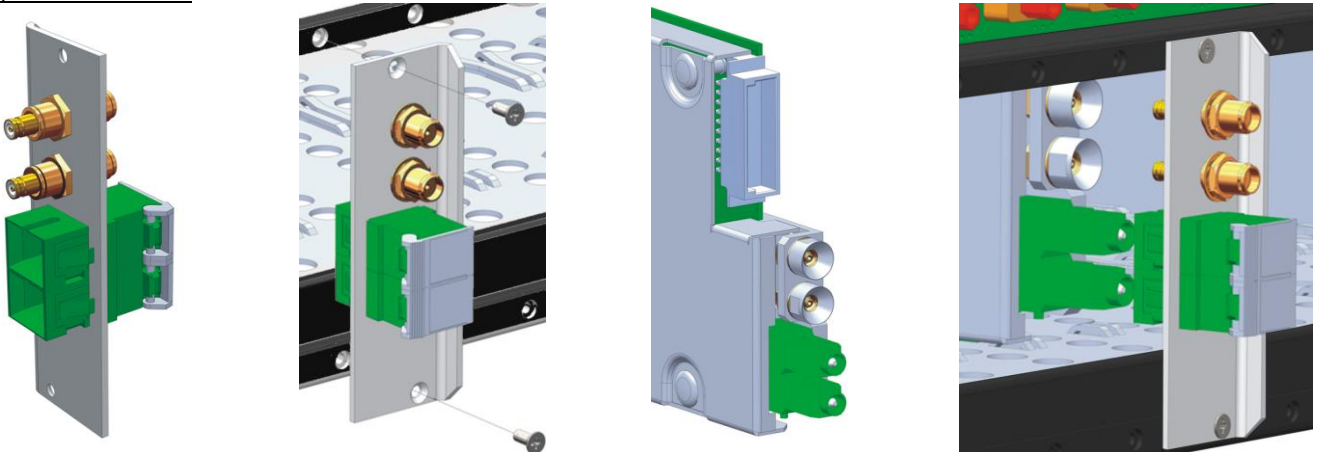



### Type 'E' blind mates

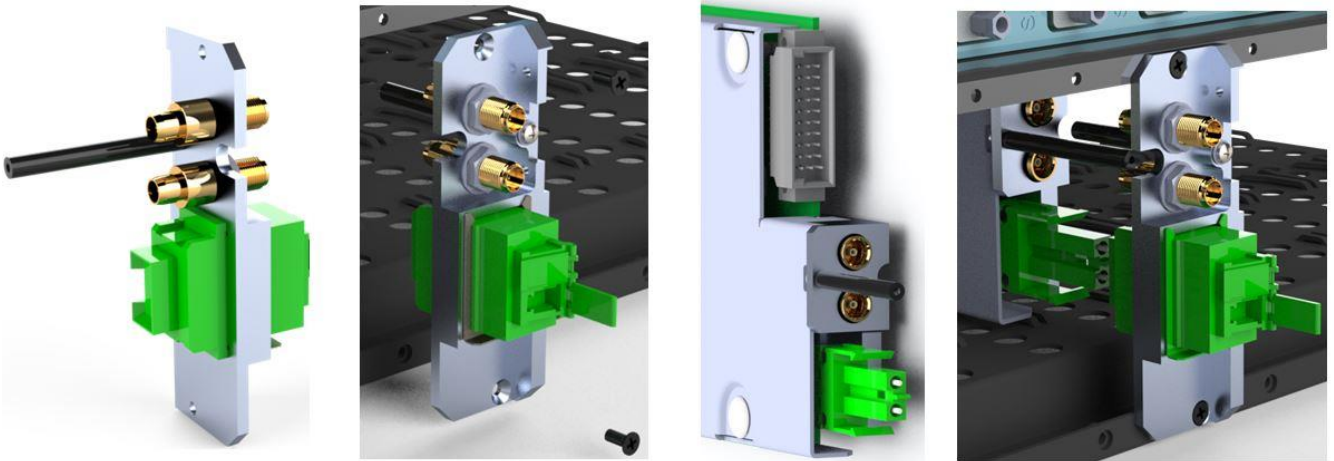

To remove a blind mate module

- Push the release button of the module handle down and simultaneously pull the top of the handle forwards.
- Apply pressure via the handle and gently withdraw the module from the chassis.
- All cables will be retained by the chassis.

Note if modules are absent for an extended period there is chance of the optical fibres being contaminated as the optical mating interface is unprotected. If this happens it will be necessary to clean both the blind mating adaptor and fibre optic cable.

### 6.5 7HP Standard Plug-in Modules (slot 14 only)

All *ViaLiteHD* plug-in modules are hot-swappable, so it is not necessary to power-down the chassis before inserting a module. All standard optical connectors are retained by the module. So it will be necessary to either disconnect any cables or have a sufficiently long service loop.



To install a 7HP Standard module

- The protective covers on the connectors may be left in place.
- Push the release button of the module handle down and simultaneously pull the top of the handle forwards.
- Align the module upright and perpendicular to the front face of the chassis so that the PCB slides into the “crow’s feet” card guides top and bottom.
- Gently push the module down its guide, applying pressure via the handle, you may also apply pressure between the LED and test connector.
- As the module is fully mated the top of the handle should snap back and lock in position.
- The pawls of the handle should be fully engaged in the matching slots.

- If power is applied to the chassis the module power LED should light as soon as the module is fully inserted
- Remove protective covers and connect any interface cables

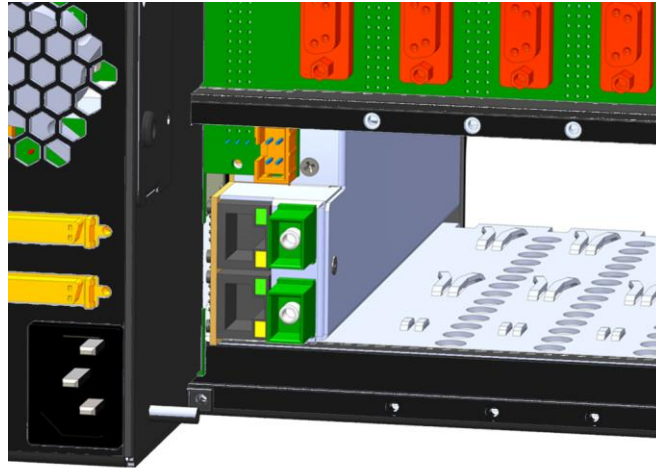

To remove a 7HP Standard module

- Disconnect any cables if necessary
- Push the release button of the module handle down and simultaneously pull the top of the handle forwards.
- Apply pressure via the handle and gently withdraw the module from the chassis.

#### 6.6 **5HP blanking panel installation (slots 1-13)**

Blanking panels should be the last panel installed into your chassis

To install the blanking panel

- Firstly inspect the blanking panel ensure that the plastic barbs are in good condition
- Align the plastic barbs with the larger holes centrally above and below the slot on the chassis top and bottom rails.
- Firmly push the panel in until you feel the barbs click

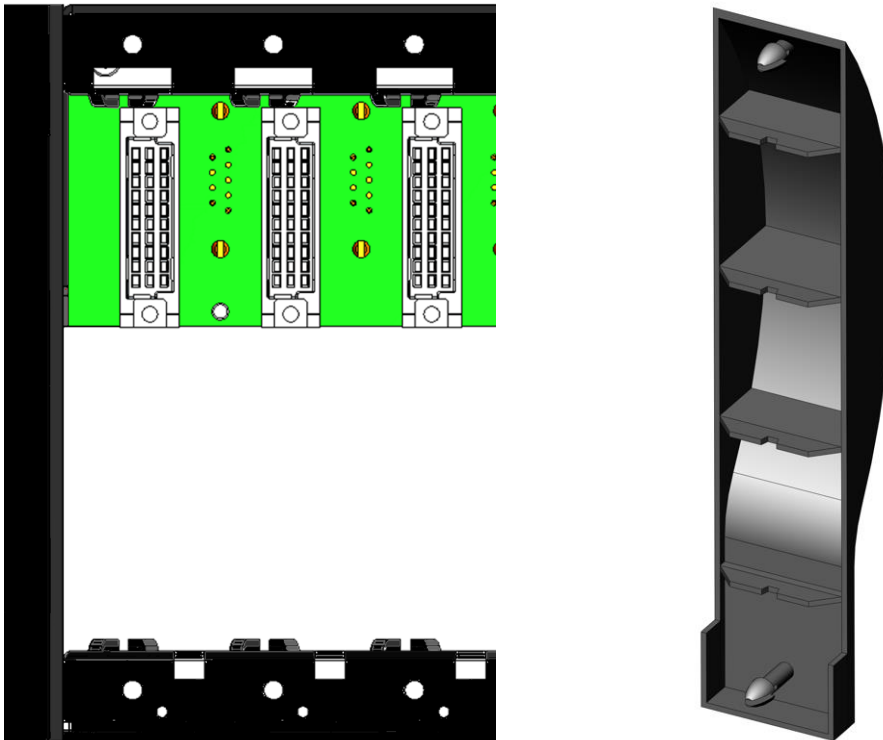

To remove the blanking panel

- Pull the blanking panel towards you, it may be necessary to use extra leverage.
- Discard the panel as the plastic barbs will now be over stressed and will not provide a reliable fixing.



### 6.7 7HP blanking panel installation (slot 14)

Blanking panels should be the last panel installed into your chassis

To install the blanking panel

- Firstly inspect the blanking panel ensure that the plastic barbs are in good condition
- Align the plastic barbs with the larger holes centrally above and below the slot on the chassis top and bottom rails.
- Firmly push the panel in until you feel the barbs click

To remove the blanking panel

- Pull the blanking panel towards you, it may be necessary to use extra leverage.
- Discard the panel as the plastic barbs will now be over stressed and will not provide a reliable fixing.

### 6.8 6HP blanking panel installation (slots 15, 16)

Blanking panels should be the last panel installed into your chassis

To install the blanking panel

- Push the release button of the panel handle down and simultaneously pull the top of the handle forwards.
- Align the panel upright and perpendicular to the front face of the chassis so that the plate slides into the “straight” card guides.
- Gently push the panel down its guide, applying pressure via the handle.
- As the panel is fully mated the top of the handle should snap back and lock in position.
- The pawls of the handle should be fully engaged in the matching slots.

To remove the blanking panel

- Push the release button of the panel handle down and simultaneously pull the top of the handle forwards.
- Apply pressure via the handle and gently withdraw the panel from the chassis.

### 6.9 Separate blindmate panels

If you wish to pre-populate and cable your blindmate chassis in advance, chassis plates can be purchased as spares, details below.

- PPM part number 85058 ViaLiteHD, Chassis plate, Blind mate (Type 'D'), 1 \* SMA 50ohms, 1 \* SC/APC
- PPM part number 85059 ViaLiteHD, Chassis plate, Blind mate (Type 'D'), 2 \* SMA 50ohms, 2 \* SC/APC
- PPM part number 85060 ViaLiteHD, Chassis plate, Blind mate (Type 'D'), 1 \* BNC 75ohms, 1 \* SC/APC
- PPM part number 85061 ViaLiteHD, Chassis plate, Blind mate (Type 'D'), 2 \* BNC 75ohms, 2 \* SC/APC
- PPM part number 85064 ViaLiteHD, Chassis plate, Blind mate (Type 'D'), 1 \* F-Type 75ohms, 1 \* SC/APC
- PPM part number 85065 ViaLiteHD, Chassis plate, Blind mate (Type 'D'), 2 \* F-Type 75ohms, 2 \* SC/APC
- PPM part number 85066 ViaLiteHD, Chassis plate, Blind mate (Type 'D'), 2 \* SMA 50ohms
- PPM part number 85067 ViaLiteHD, Chassis plate, Blind mate (Type 'D'), 3 \* SMA 50ohms
- PPM part number 85068 ViaLiteHD, Chassis plate, Blind mate (Type 'D'), 4 \* SMA 50ohms
- PPM part number 85069 ViaLiteHD, Chassis plate, Blind mate (Type 'D'), Duplexed, 1 \* SMA 50ohms, 1 \* SC/APC
- PPM part number 85070 ViaLiteHD, Chassis plate, Blind mate (Type 'D'), Duplexed, 1 \* BNC 75ohms, 1 \* SC/APC
- PPM part number 85071 ViaLiteHD, Chassis plate, Blind mate (Type 'D'), 1 \* BNC 50ohms, 1 \* SC/APC
- PPM part number 85072 ViaLiteHD, Chassis plate, Blind mate (Type 'D'), 2 \* BNC 50ohms, 2 \* SC/APC.
- PPM part number 85073 ViaLiteHD, Chassis plate, Blind mate (Type 'D'), 2 \* SC/APC
- PPM part number 85103 ViaLiteHD, Chassis plate, Blind mate (Type 'E'), 1 \* SMA 50ohms, 1 \* LC/APC
- PPM part number 85104 ViaLiteHD, Chassis plate, Blind mate (Type 'E'), 2 \* SMA 50ohms, 2 \* LC/APC
- PPM part number 85105 ViaLiteHD, Chassis plate, Blind mate (Type 'E'), 1 \* BNC 75ohms, 1 \* LC/APC
- PPM part number 85106 ViaLiteHD, Chassis plate, Blind mate (Type 'E'), 2 \* BNC 75ohms, 2 \* LC/APC
- PPM part number 85107 ViaLiteHD, Chassis plate, Blind mate (Type 'E'), 2 \* SMA 50ohms
- PPM part number 85108 ViaLiteHD, Chassis plate, Blind mate (Type 'E'), 3 \* SMA 50ohms

### 6.10 Electrical power connection

Power should be applied to the chassis with the supplied power cords (AC chassis only), if these are not used a suitable alternative should be used. A substitute power cord should be rated as following

- Current rating 10A
- Voltage rating To match your installation requirement
- Mating connector (AC) IEC 60320 C13 socket (HRK3S)
- Mating connector (DC) Plug, stripped cable or fork terminal suitable for mounting to 4mm screw terminal (HRK3S-DC))

You should ensure that all cable is routed carefully to protect them from mechanical damage especially those caused by sharp edges.

Each chassis has two separate power feeds these separately feed, slots 15 and 16, as shown below. To fully isolate the chassis BOTH power feeds MUST be removed.



Slot 16 AC power feed  
Slot 15 AC power feed  
Ground stud (M4)



Slot 16 DC power feed  
Slot 15 DC power feed  
Ground stud (M4)

**Red** is positive  
**Black** is negative

AC powered chassis

Electrical power connection locations

DC powered chassis

**6.11 Typical redundancy configurations**

The chassis configuration below can be used to provide redundant fibre optic links by the use of *ViaLiteHD* chassis, with transmitters, receivers, splitters and switches. Illustrated below are some popular configurations.

For simplicity the chassis configuration is viewed from the rear.

**6.11.1 Four 1:1 redundant single transmitters, standard modules**

The blank slot can be used as a storage slot for a hot spare

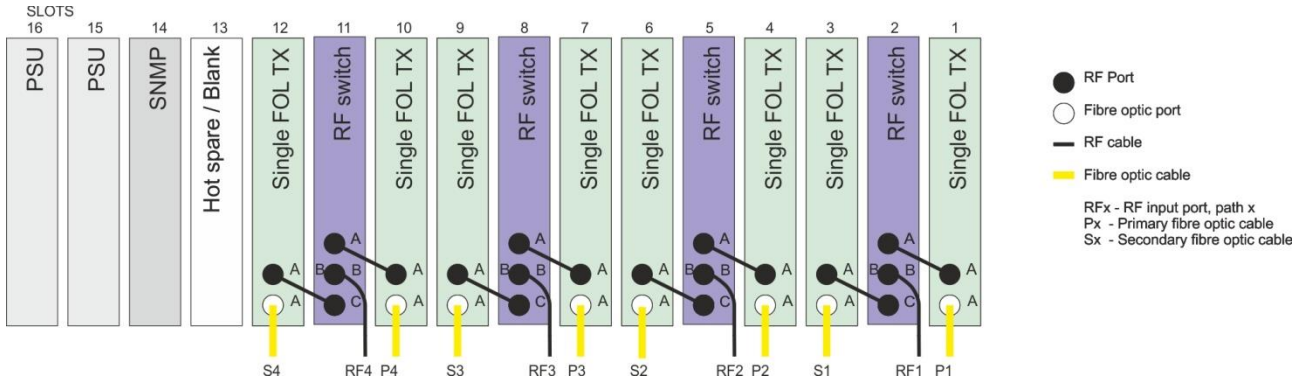

Four 1:1 redundant transmitters using standard plug in modules and splitters, viewed from rear of chassis

**6.11.2 Four 1:1 redundant single transmitters, blindmate modules**

The blank slot can be used as a storage slot for a hot spare

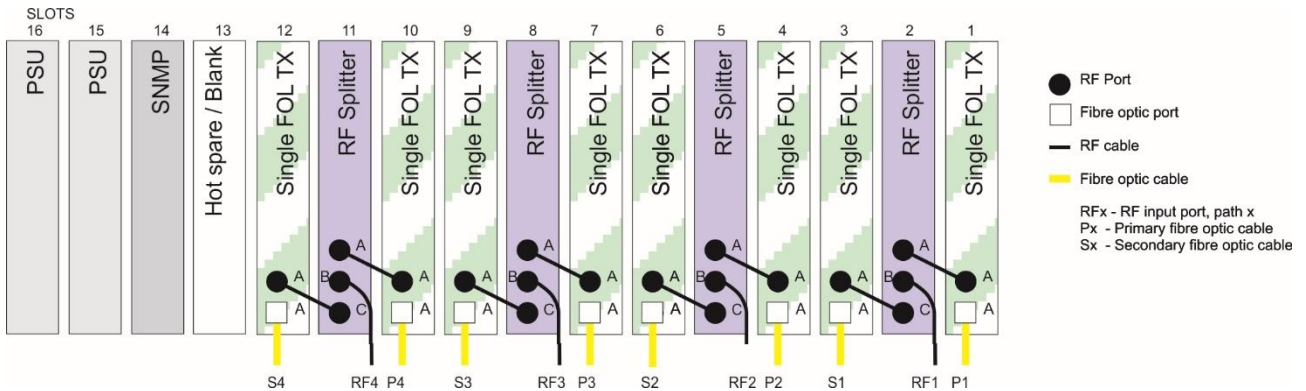

Four 1:1 redundant transmitters using blindmate plug in modules and splitters, viewed from rear of chassis

**6.11.3 Six 1:1 redundant dual transmitters, standard modules**

The rear panel connector configurations are dependent on module type; different module may have different connector configurations. However RF and optical connector can clearly be distinguished and connector letters are clearly shown on the rear panels.

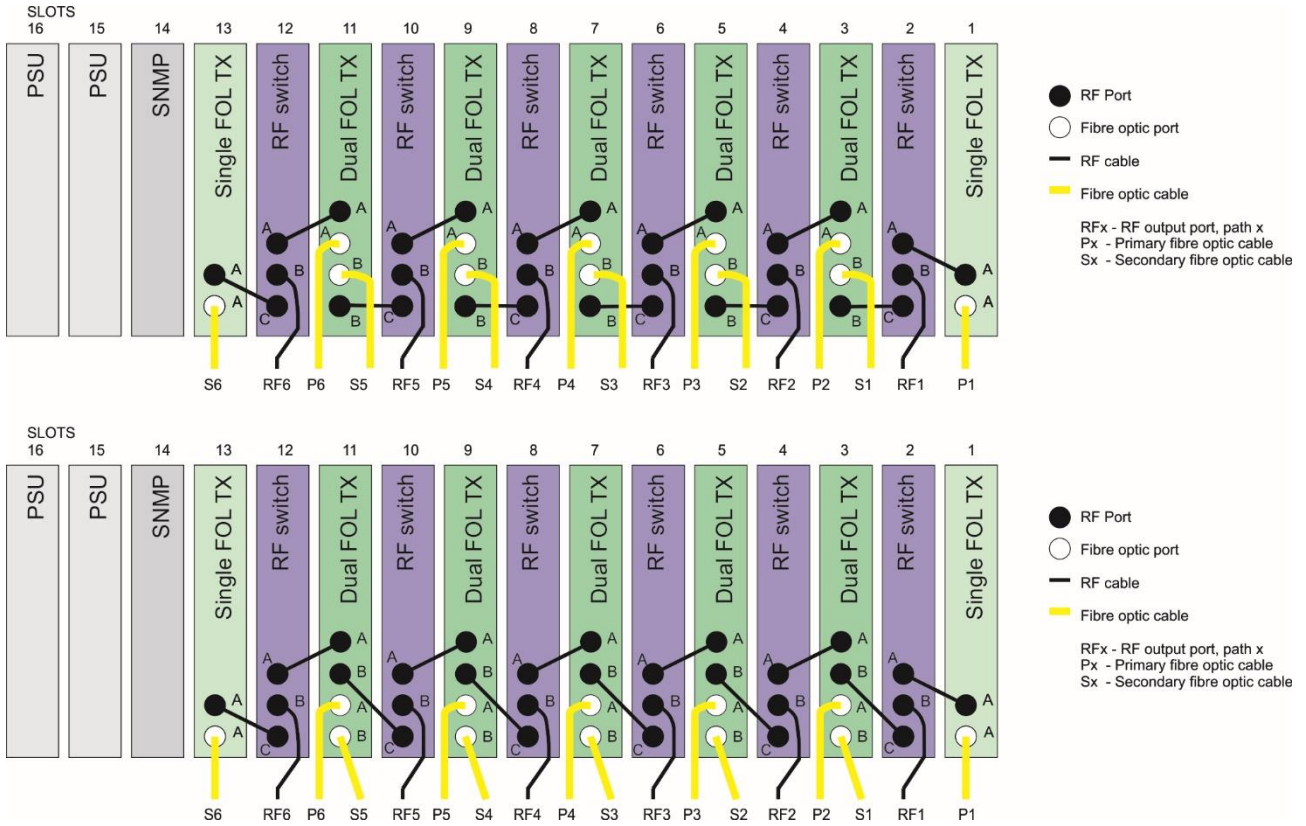

Six 1:1 redundant transmitters using standard plug in modules and splitters, viewed from rear of the chassis  
 Top – Connector configuration A (typically used with FC optical and SMA RF connectors)  
 Bottom - Connector configuration B (typically used with all other connector configurations)

**6.11.4 Six 1:1 redundant dual transmitters, blindmate modules**

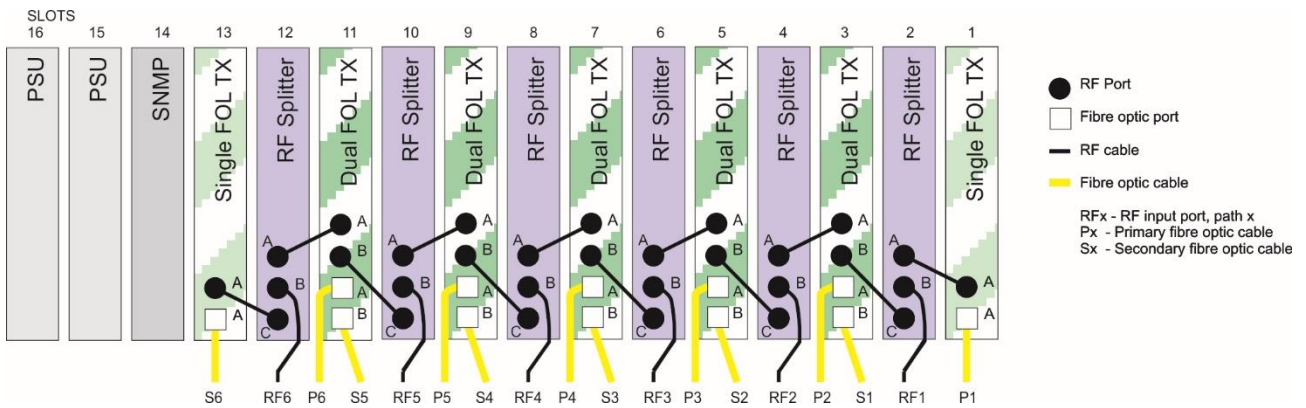

Six 1:1 redundant transmitters using blindmate plug in modules and splitters, viewed from rear of chassis

### 6.11.5 Four 1:1 redundant single receivers, standard modules

The blank slot can be used as a storage slot for a hot spare

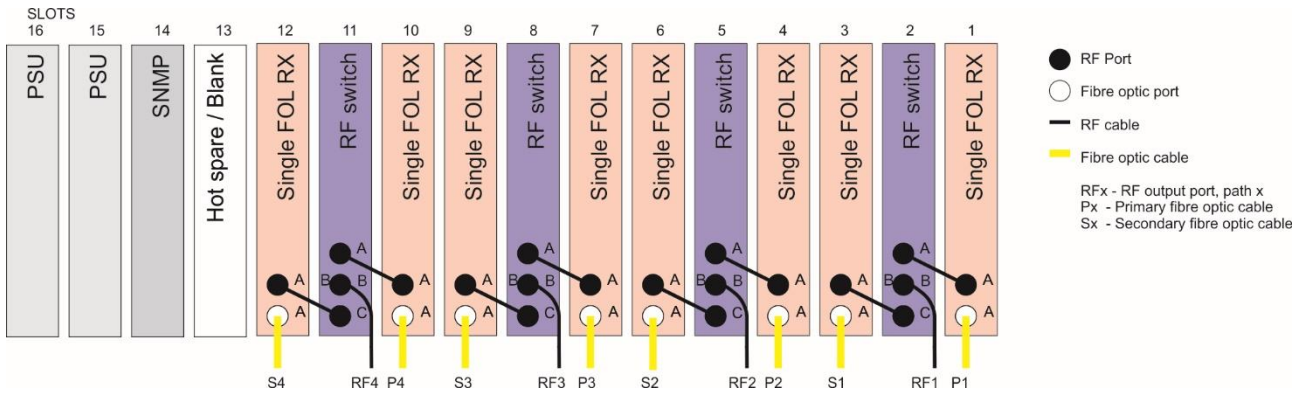

Four 1:1 redundant receivers using standard plug in modules and switches, viewed from rear of chassis

### 6.11.6 Four 1:1 redundant single receivers, blindmate modules

The blank slot can be used as a storage slot for a hot spare

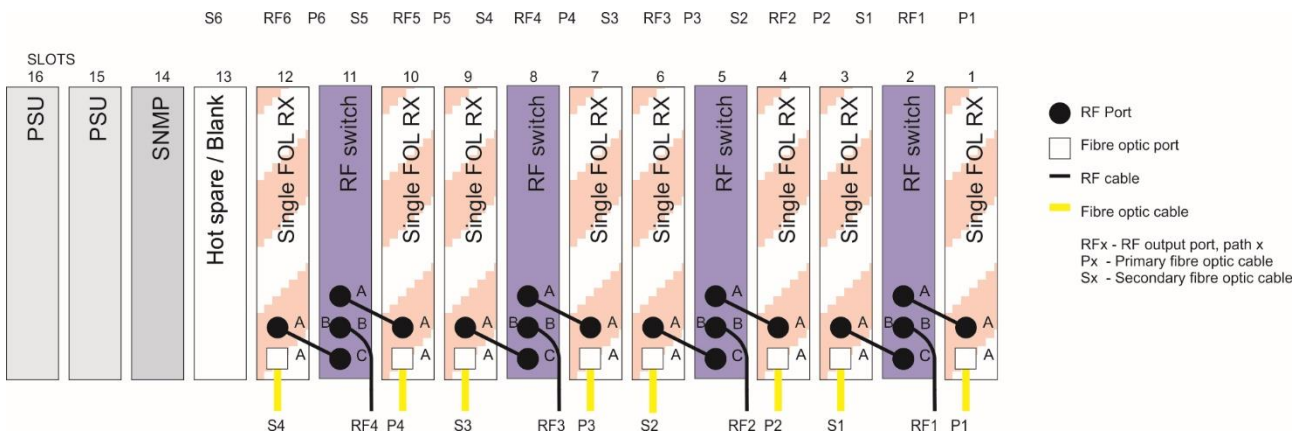

Four 1:1 redundant receivers using blindmate plug in modules and switches, viewed from rear of chassis



**6.11.7 Six 1:1 redundant dual receivers, standard modules**

The rear panel connector configurations are dependent on module type; different module may have different connector configurations. However RF and optical connector can clearly be distinguished and connector letters are clearly shown on the rear panels.

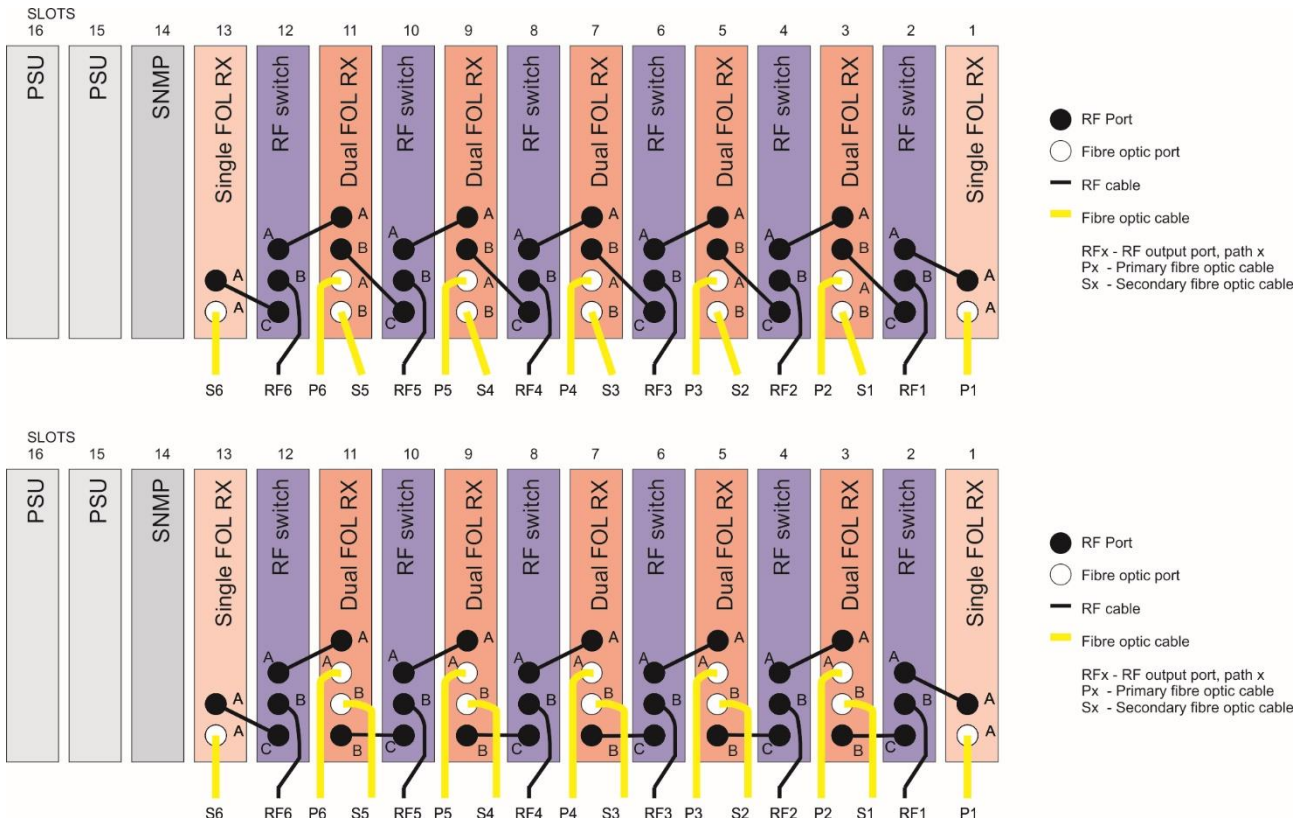

Six 1:1 redundant receivers using standard plug in modules and switches, viewed from rear of the chassis  
 Top – Connector configuration A (typically used with FC optical and SMA RF connectors)  
 Bottom - Connector configuration B (typically used with all other connector configurations)

**6.11.8 Six 1:1 redundant dual receivers, blindmate modules**

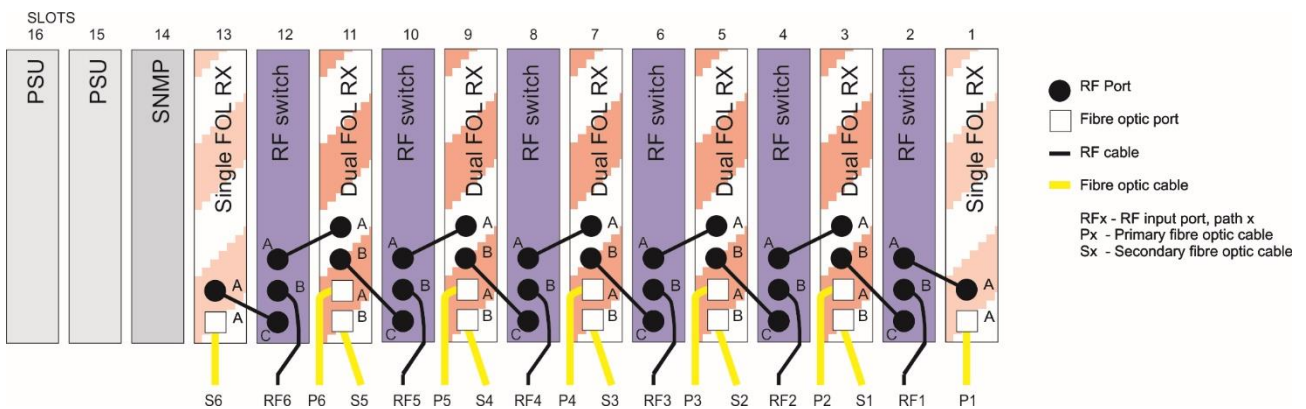

Six 1:1 redundant receivers using blindmate plug in modules and switches, viewed from rear of chassis

6.11.9 Four 1:1 redundant links, blindmate modules, using single transmitters TX and single receivers RX

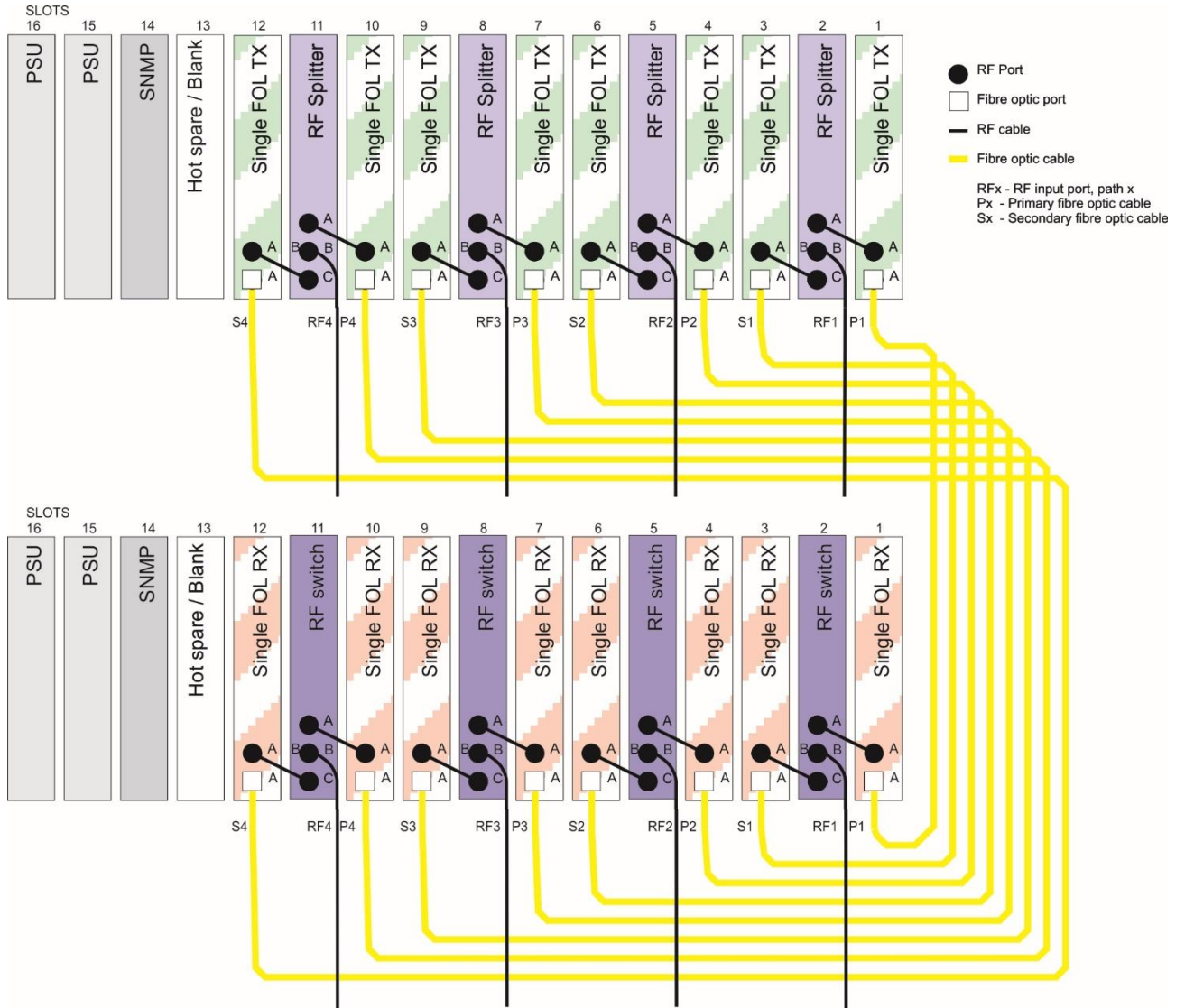

Four 1:1 redundant links using blindmate modules, splitters and switches, viewed from rear of chassis

6.11.10 Six 1:1 redundant links, blindmate modules, using dual transmitters DTX and dual receivers DRX

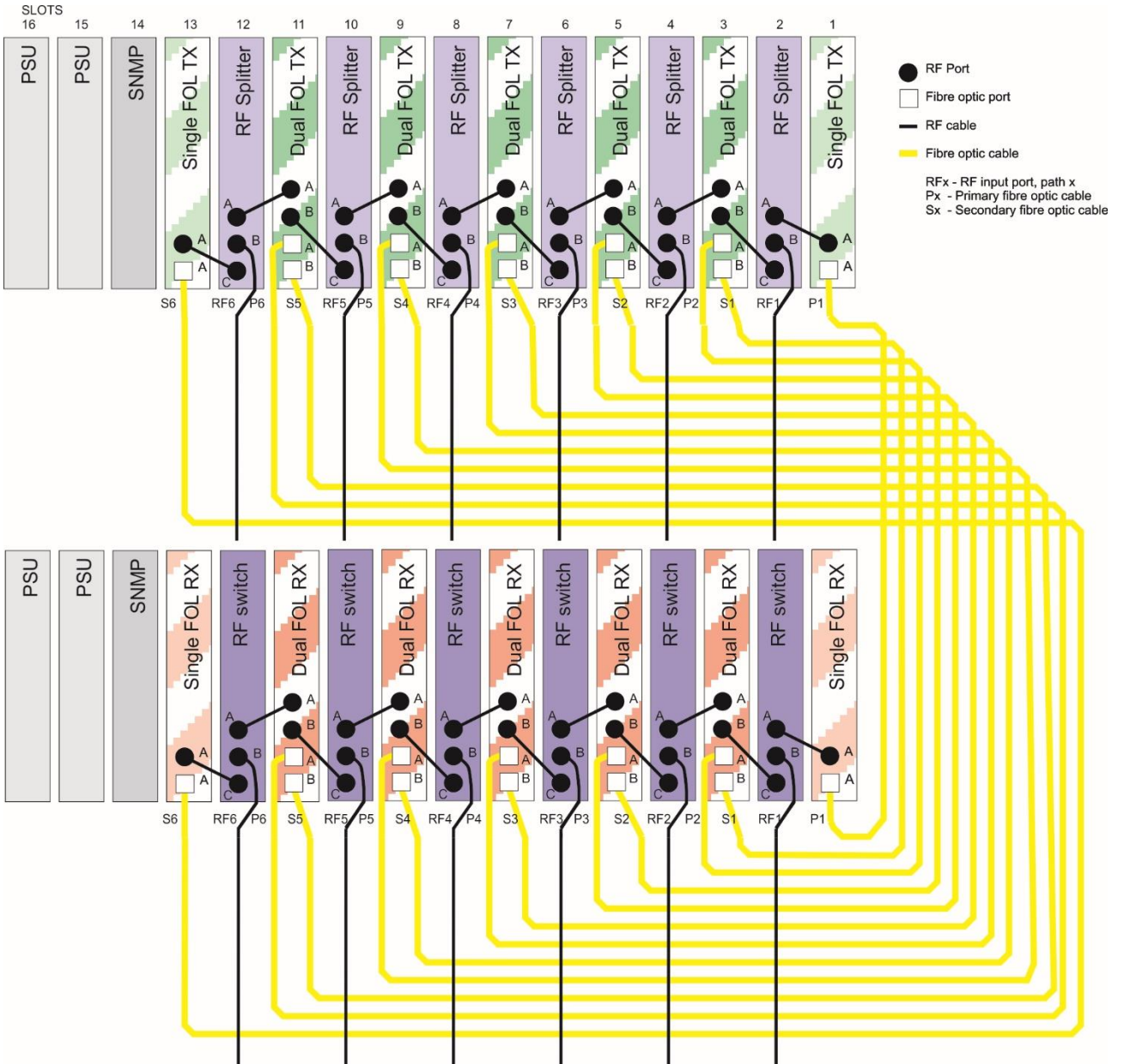

Six 1:1 redundant links using blindmate modules, splitters and switches, viewed from rear of chassis



**6.11.11 Uplink and downlink 1:1 redundant, blindmate modules using single transmitters TX and single receivers RX**

Only an single uplink and downlink are shown for clarity, however this configuration can be expanded to include an extra uplink and downlink.

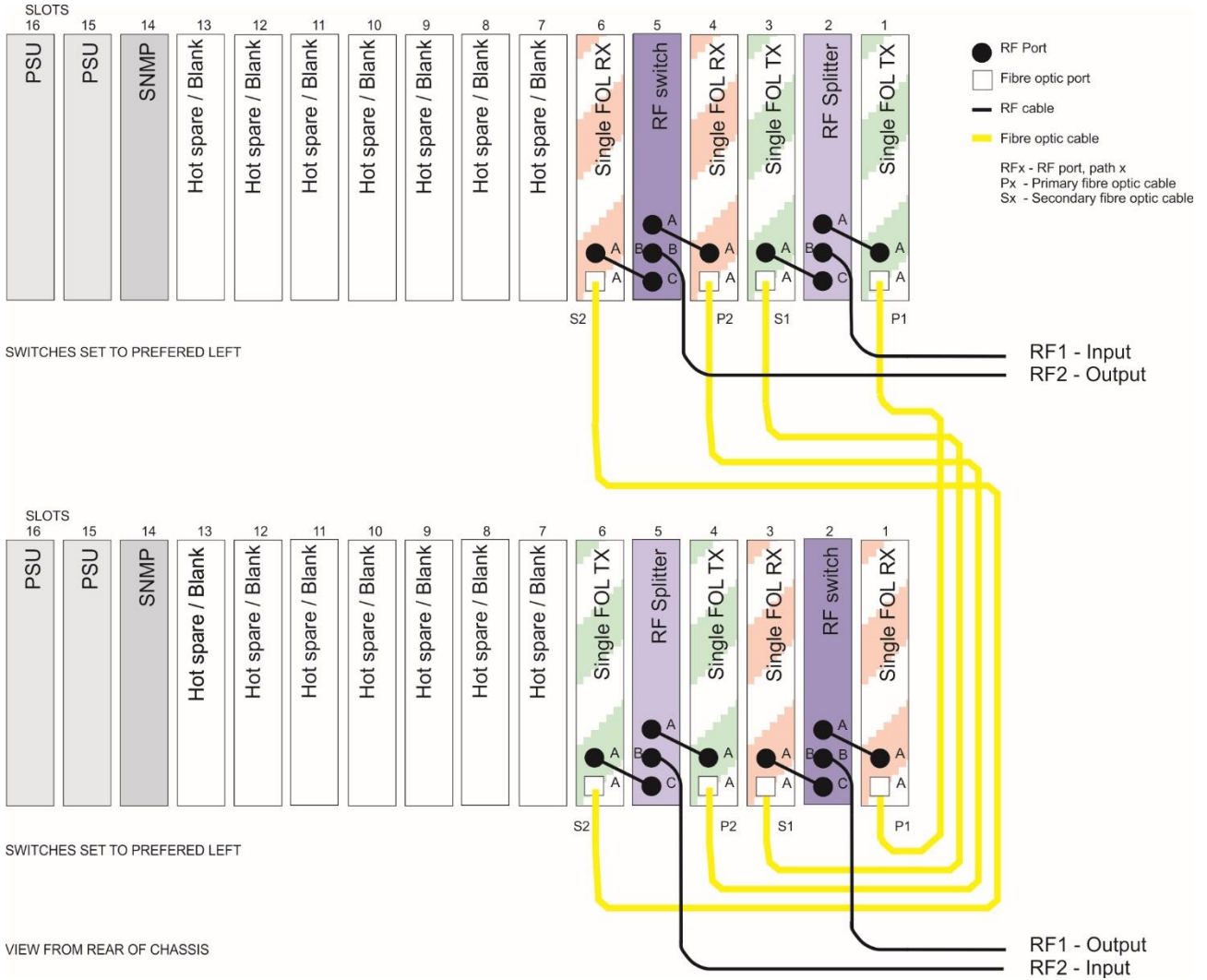

Uplink and downlink 1:1 redundant, blindmate modules using receiver, transmitter, splitters and switches, viewed from rear of chassis

**6.11.12 Six 1:1 redundant transceivers TRX, standard modules**

This configuration should not be used for system that have LNA bias tee feed generated by the TRX transmitter (or fed through this module) and that also require the DC bias to be switched by the RF splitter modules. The configuration below does not allow automatic switching of the DC path via adjacent alarm sensing. If switching of the LNA bias feed is required use one of the previous configurations in sections 6.11.1 to 6.11.4

The rear panel connector configurations are dependent on module type; different module may have different connector configurations. However RF and optical connector can clearly be distinguished and connector letters are clearly shown on the rear panels.

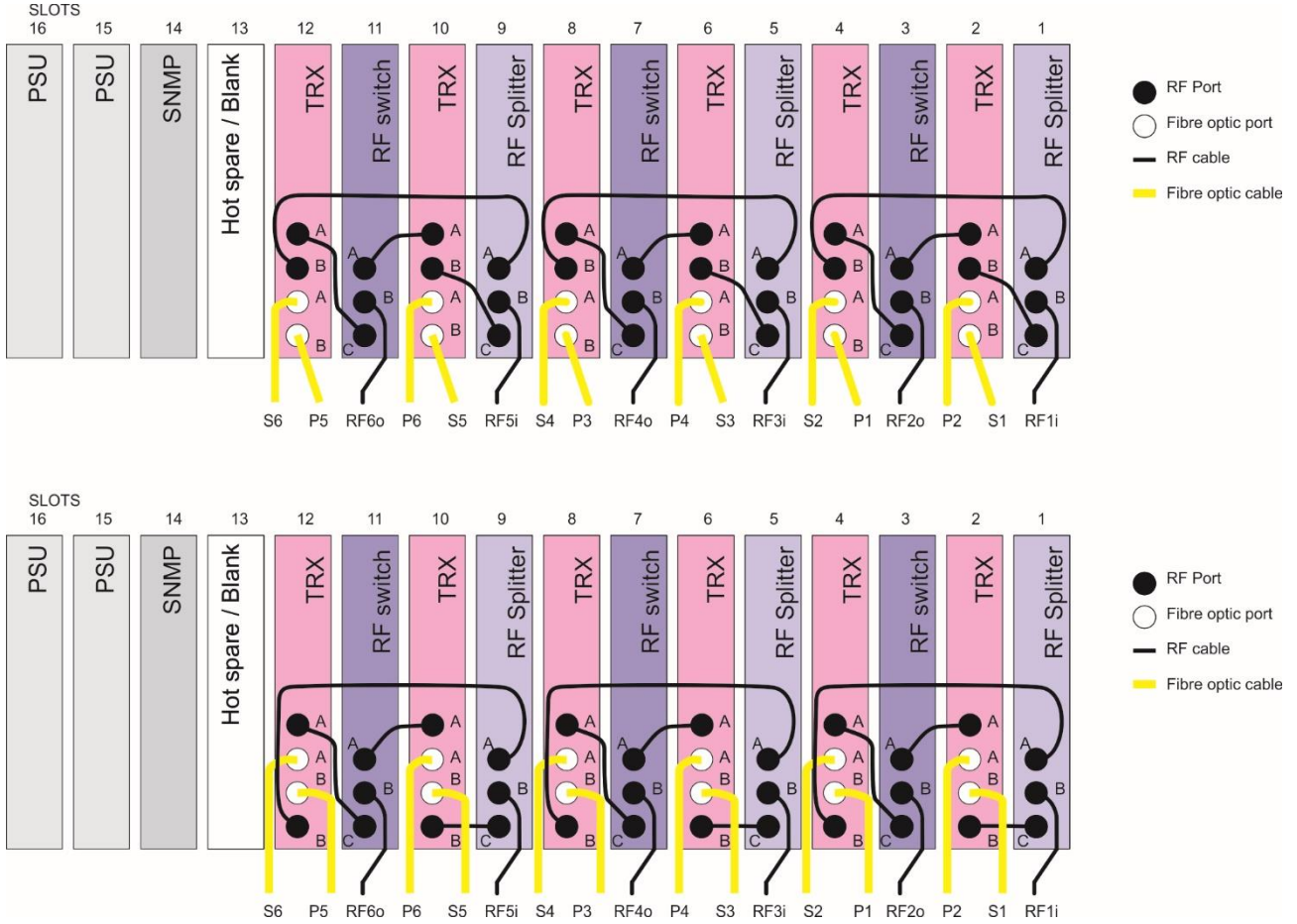

Six 1:1 redundant transceivers using standard plug in modules splitters and switches, viewed from rear of the chassis  
 Top – Connector configuration A (typically used with FC optical and SMA RF connectors)  
 Bottom - Connector configuration B (typically used with all other connector configurations)

6.11.13 Six 1:1 redundant links, standard modules, using transceivers TRX

The rear panel connector configurations are dependent on module type; different module may have different connector configurations. However RF and optical connector can clearly be distinguished and connector letters are clearly shown on the rear panels.

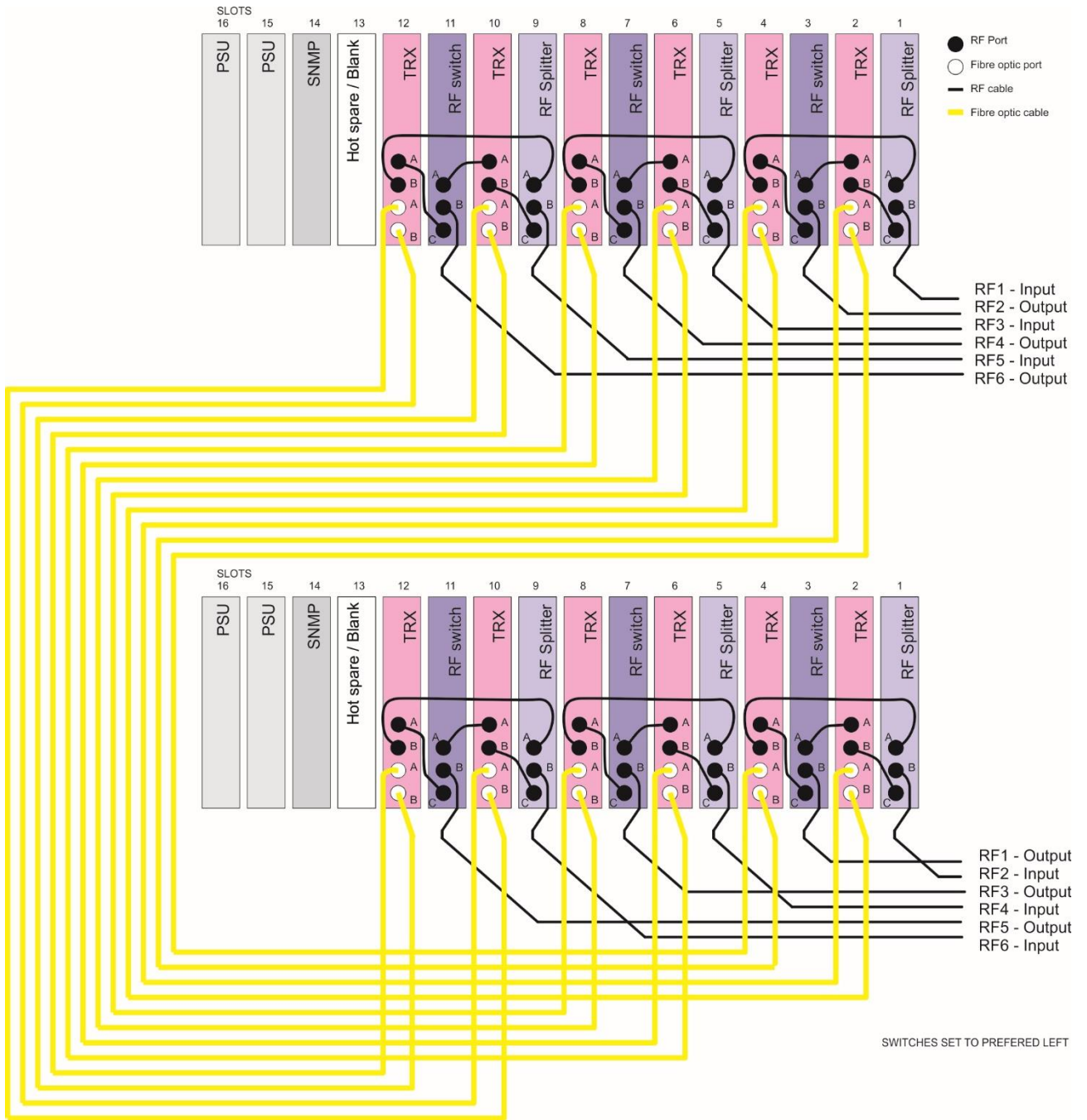

Six 1:1 redundant links using standard TRX modules, splitters and switches, viewed from rear of chassis

In this configuration, each transceiver carries on main and one redundant path.

**6.12 Shock and vibration**

ViaLiteHD modules have been designed and tested to operate under significant mechanical stress; the tests run far exceed normal ground fixed operational use. This has been done to assure the robustness and reliability of the designs. Below are detailed the tests undertaken.

The system under test was a set of 3U chassis mounted modules, powered by chassis mounted AC PSUs. The system is detailed below:

- HRK3S 3U chassis
- HPS-3 AC PSU
- HPS-3 AC PSU
- HRC-1-09-8R-20 SNMP controller
- HRT-N1-6R-35-S1310 1GHz TX
- HRR-N1-6R-05 1GHz RX
- HRX-N1-8D-05-C1530 1GHz TRX blindmate
- F6R1/0.5 Optical test cable
- F8R1/0.5 Optical test cable
- Laptop (running SNMP web interface), not subject to vibration or shock

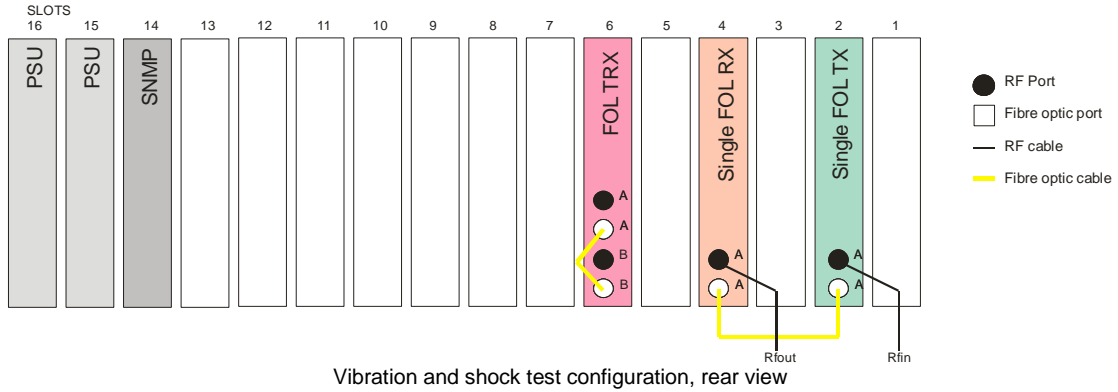

Vibration applied to the system:

- Vibration (Sinusoidal)
- Planes 3 planes, X/Y/Z
- Severity 5G, 25 – 2000 Hz, 1 octaves per minute.
- Duration 1/2 hour in each axis
- Standard IEC68-2-6: 1982

Shock applied to the system:

- Shock (half sine);
- Axis: 6 axis, X+/X-/Y+/Y-/Z+/Z-
- Severity 15g/ 11ms Shock (half sine)
- Duration 3 shocks each direction of each axes
- Standard IEC68-2-27:1987

A continuous wave RF test signal was applied to the TX FOL and monitored on the RX FOL via a spectrum analyser. The spectrum analyser used both maximum and minimum hold to capture performance extremes.

The test pass requirement was as follows:

- Continuous RF operation to specification.
- No SNMP error events to be logged.
- No front panel LED errors to be shown.
- No visible mechanical damage or degradation.

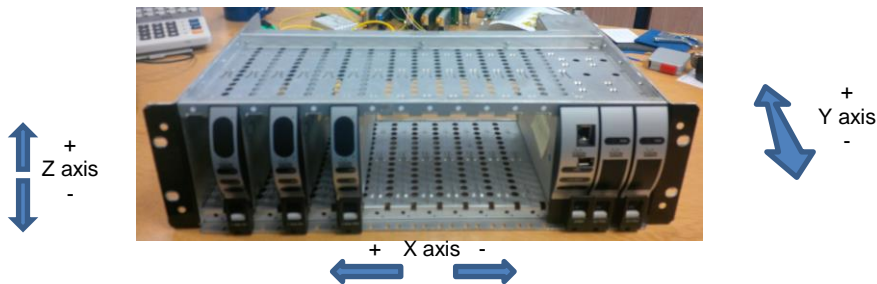

Orientation of shock and vibration

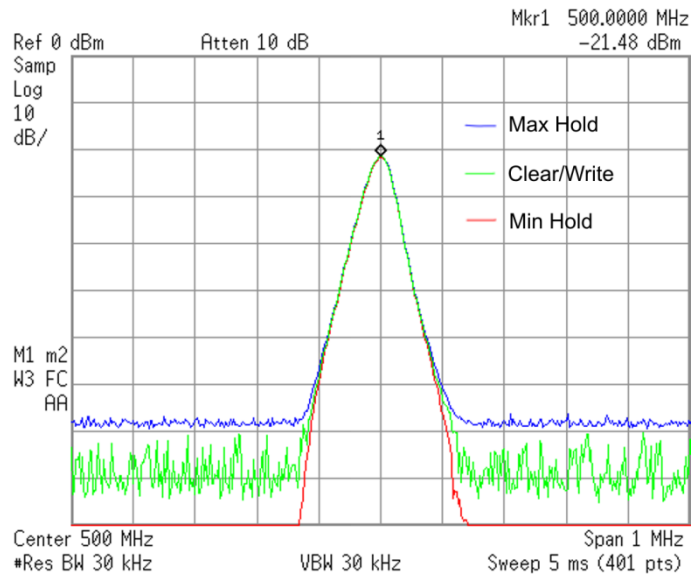

Spectrum plot of 500MHz CW tone when under vibration

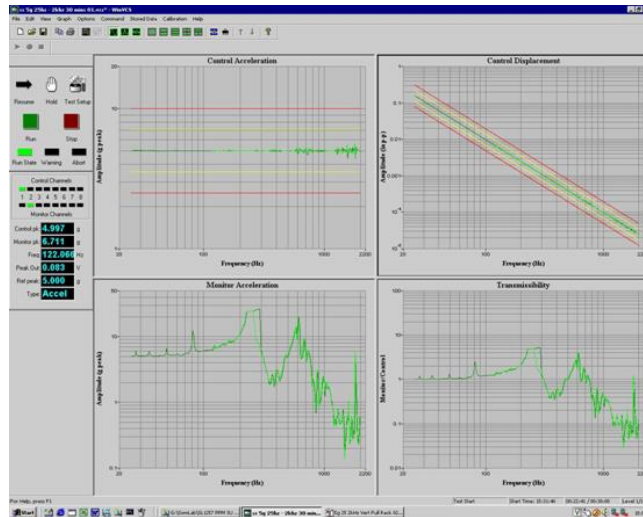

Sample plot of vibration in Y axis

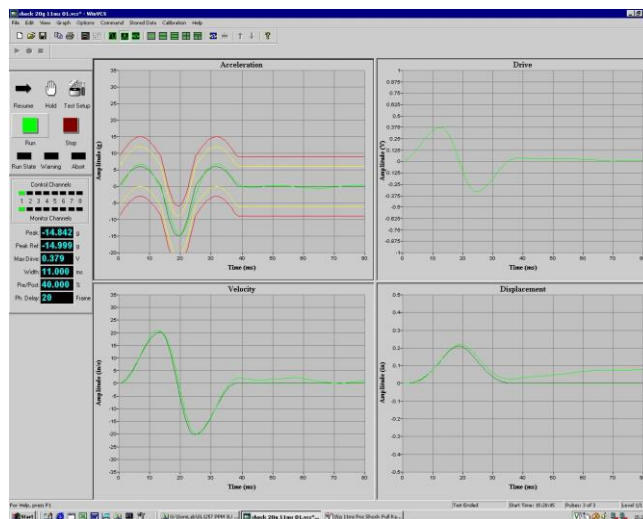

Sample plot of Half Sine Shock in Y+ axis

No measurable change in RF power level was detected. The system under test passed all the vibration and shock tests, detailed above. A full test report is available, contact **ViaLite Communications** for more details.

## 7 Part Numbering

### 7.1 ViaLiteHD Chassis, part numbering

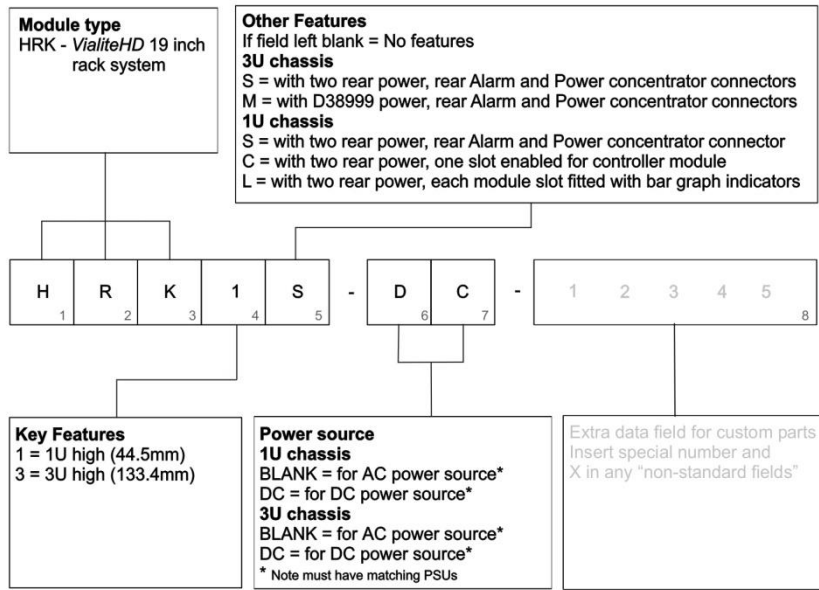

### 7.2 ViaLiteHD Power supply, part numbering

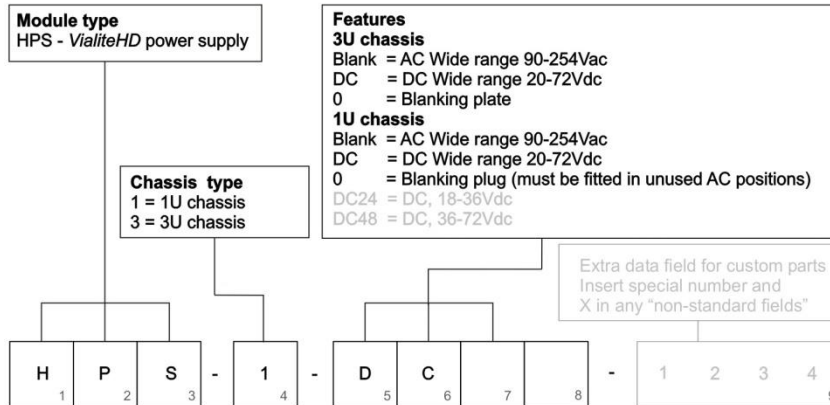

## 8 Maintenance and Fault-Finding Guide

Refer to the following table that gives a list of commonly encountered problems and suggested solutions.

Fault	Possible Causes	Solution
Power LED does not illuminate on the plug-in PSUs.	Power is not connected to the PSU.  PSU is in idle mode.  Fuse has blown in PSU.	Connect mains power to the rear of the PSU. Check fuses of power leads.  Add additional dummy load board or plug in modules.  Return the module to <b>ViaLite Communications</b> or your local agent.
Power LED does not light.	Power supply is not connected.  Incorrect rack or power supply type	Attach power source.  Check that rack type (AC or DC) matches your power source.  Check that power supply type matches your power source type (AC or DC) and voltage.
Fan not turning.	Fan power disconnected.	Check fan power connector is inserted.  Replace failed fan
Difficulty inserting module.	Incorrect alignment.  Incorrect module slot.	Check that the module is correctly fitted in the card guides.  Check that module is in correct slot Slots 1-13 for 5HP modules Slot 14 for 7 HP modules Slot 15-16 for 6 HP modules
Summary alarm triggered when no module failure is indicated.	Summary alarm module: Open collector alarms for unused slots not masked.  SNMP and web controller module: Open collector alarms for unused slots not masked.  Failed Module.	Check that the DIP switches on the Summary alarm relay module for all chassis positions are set correctly.  Check the software alarm mask of the SNMP control module for all chassis positions is set correctly.  Return the module to <b>ViaLite Communications</b> or your local agent.

In the event of any problems or queries about the equipment, contact **ViaLite Communications** or your local agent.

For module fault finding information see module handbooks



## 9 Product Warranty

The guarantee / warranty period, unless otherwise agreed in writing, shall be as stated in document F292 - PPM Manufactured Product – Warranty, which is available at: <https://ppm.co.uk/warranty-periods/>. Extended warranty options are available at the time of purchase.

Prior to returning any goods for warranty or non-warranty repairs please contact PPM / **ViaLite Communications** for a returns reference.

## 10 FCC Approval

Information to the user of **ViaLiteHD** products

For a Class A digital device or peripheral, the following instructions are furnished to the user. This equipment has been tested and found to comply with the limits for a Class A digital device, pursuant to part 15 of the FCC Rules. These limits are designed to provide reasonable protection against harmful interference when the equipment is operated in a commercial environment. This equipment generates, uses, and can radiate radio frequency energy and, if not installed and used in accordance with the instruction manual, may cause harmful interference to radio communications. Operation of this equipment in a residential area is likely to cause harmful interference in which case the user will be required to correct the interference at his own expense.

© PULSE POWER & MEASUREMENT LTD 2020

NO PART OF THIS DOCUMENT MAY BE REPRODUCED OR TRANSMITTED IN ANY FORM WITHOUT PRIOR WRITTEN PERMISSION.

PULSE POWER & MEASUREMENT LTD, 65 SHRIVENHAM HUNDRED BUSINESS PARK, SWINDON, SN6 8TY, UK.

TEL: +44 1793 784389 FAX: +44 1793 784391

EMAIL: [SALES@VIALITE.COM](mailto:SALES@VIALITE.COM) WEBSITE: [WWW.VIALITE.COM](http://WWW.VIALITE.COM)

---