

CANALOG

MCallen TX.
1720 W Maple Suite 7
Mcallen TX 78501

Reynosa Tamps
Canales #620 Zona
Centro Reynosa
Tamaulipas

Rio Bravo Tamps
Merida 205 Int C Plaza la
Joya Zona Centro Rio
Bravo Tamaulipas.



www.metalmoldingusa.com

WHAT WE OFFER

- Automation Supplies
- Abrasives
- Chemicals & Paints
- Cutting Tools
- Metalworking
- Fasteners & HVAC
- Tools
- Fleet & Automotive
- Hydraulics & Pneumatics
- Electrical & Lightning
- Raw Materials
- Component Repair
- Welding & Soldering
- Lubricants & Oils
- PPE Equipment
- Steel Molds
- Walls
- Roofs
- Galvanized Steel
- Warehouses

24/7 Customer Support

Any day, Any time, We are there for you !

- On The Spot Solutions
- Competitive Pricing
- Shipping & Deliveries
- Revamped Lead Times
- Outworn Parts

sales@metalmoldingusa.com

Rio Bravo, Tamps, Mexico
Merida 205 Local C
Plaza La Joya Zona Centro
+52 899-960-15-46

Nuestras Locaciones - Our Locations:

Reynosa, Tamps, Mexico
Servando Canales #620 Zona Centro
+52 899-401-0968

San Juan, TX
2506 N Raul Longoria Suite 7
956-854-5415



TEAM METAL MOLDING & MRO SUPPLY LLC

We are a company specializing in Maintenance, Repair, and Operations (MRO) services for the industrial sector. Our commitment is to ensure the operational continuity and efficiency of our clients' production processes through reliable, agile, and customized technical solutions. We have a multidisciplinary team of highly trained professionals, cutting-edge technology, and an organizational culture based on safety, quality, and continuous improvement. More than a supplier, we are a strategic partner working to keep the industry moving forward.



Advantage

We provide quality and guarantee with products made in America with the best and most durable materials.

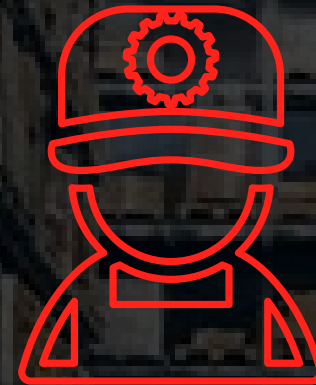

Innovative

We have a highly qualified and continuously trained technical team, supported by state-of-the-art digital management systems (CMMS) and diagnostic tools. We adapt to the specific needs of each industry, rigorously adhering to quality, safety, and sustainability standards.



Service

We work to provide the best service to our customers, with quality standards and meeting their requirements **24 hours a day, 7 days a week** in our MRO Service. From Monday to Saturday we are available to provide the best steel in the region.

AUTOMATION AND CONTROL

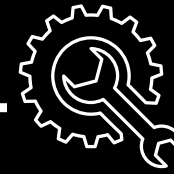

METAL MOLDING &

MRO SUPPLY

- TERMINAL BLOCK
- PLC, HMI AND LOGIC DEVICES
- PROCESS CONTROL
- CONTACTORS

- TERMINAL BLOCK
- PLC, HMI AND LOGIC DEVICES
- PROCESS CONTROL
- CONTACTORS

- MACHINE SAFETY
- DRIVES



SIEMENS

ABB

Allen-Bradley

Schneider Electric

EATON

KOLLMORGEN

MITSUBISHI ELECTRIC
Cooling and Heating Solutions

SAFETY EPP

- IDENTIFICATION PRODUCTS
- HAND PROTECTION
- LOCKOUT TAGOUT
- PROTECTIVE CLOTHING

- FRIST AID AND HEALTH CARE
- FACE AND PROTECTION
- FOOTWEAR AND LEG PROTECTION
- SPILL CONTROL

- FACILITY SAFETY
- TRAFIC ROADWAY SAFETY
- FALL PROTECTION AND RESCUE EQUIPMENT
- HERING PROTECTION

- ERGONOMIC SUPPORTS
- HEAD PROTECTION
- RESPIRATORY PROTECTION



BEARINGS, LINEAR MOTION, MECHANICAL POWER TRANSMISSION

- BALL BEARINGS
- CAM FOLLOWERS AND YOKE ROLLERS
- MOUNTED BEARINGS
- THRUST BEARINGS

- ACME AND BALL SCREW
- BALL GUIDES
- LINEAR GUIDES

- BELTS AND SHAVES
- CHAIN AND SPROCKETS
- CLUTCHS AND BRAKES
- DRIVE COMPONENTS
- SPEED REDUCERS

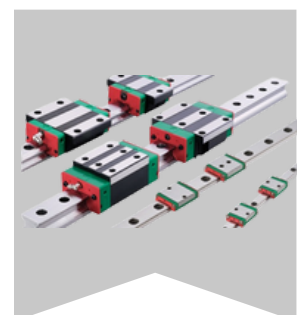
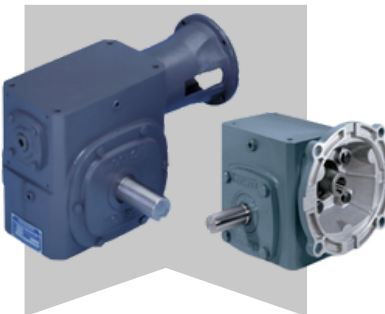
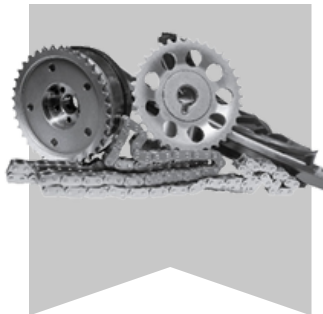
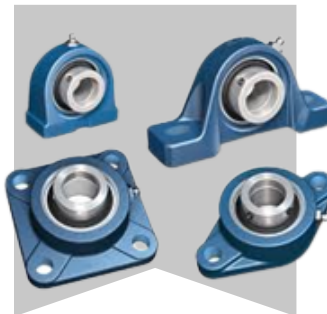
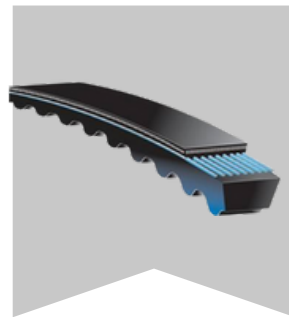

HYDRAULICS AND PNEUMATICS

- AIR COMPRESSOR EQUIPMENT
- AIR CYLINDER AND ROTARY ACTUATORS
- AIR MOTORS
- AIR PREPARATION
- CONDENSATE MANAGEMENT
- ENERGY ABSORPTION
- PNEUMATIC INSTRUMENTATION
- PNEUMATIC COMPONENTS
- PNEUMATIC VALVES AND MANIFOLDS
- PROCESS VALVES
- VACUUM EQUIPMENT
- HYDRAULIC ACCESSORIES
- HYDRAULIC CYLINDERS
- HYDRAULIC FILTRATION
- HYDRAULIC HEAT EXCHANGERS
- HYDRAULIC MOTORS
- HYDRAULIC OILS
- HYDRAULIC PUMPS



JANITORIAL

METAL MOLDING &

MRO SUPPLY

- BATHROOM SUPPLIES AND HYGIENE
- CLEANING SUPPLIES
- FLOOR CARE

- INDUSTRIAL CLEANING WIPES
- SPONGES AND SCOURING PADS
- TRASH CANS, BAGS AND RECEPTACLES



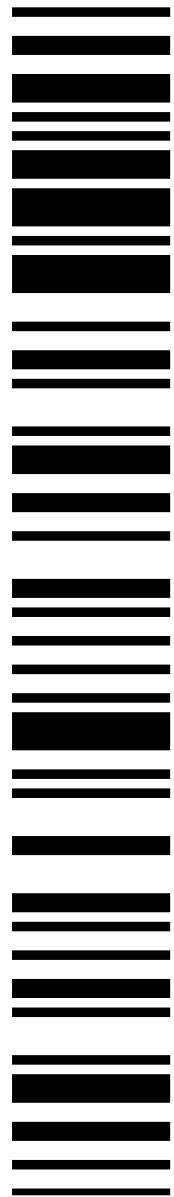

ABRASIVES

- ABRASIVE BRUSHES
- BUFFING Y POLISHING
- BURNISHING TOOLS
- COATED ABRASIVES
- DEBURRING TOOLS
- FILES, STICKS

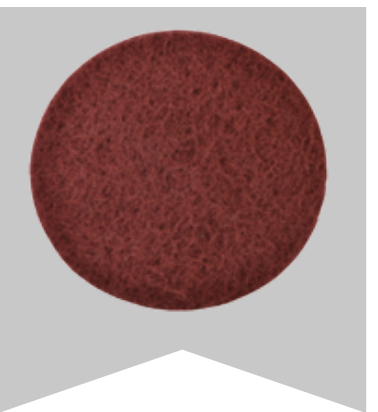
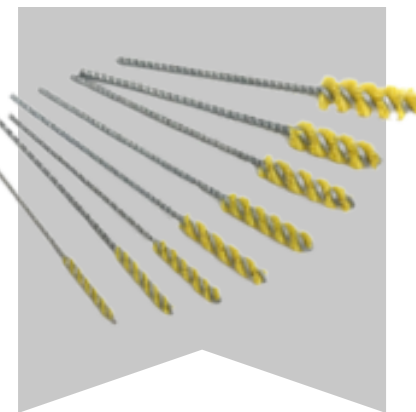
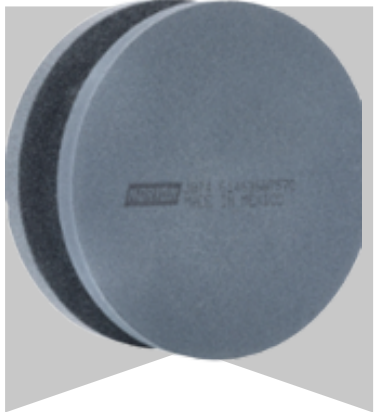
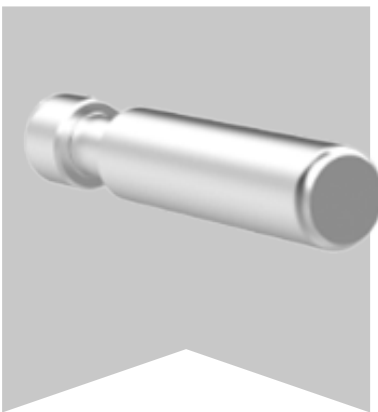
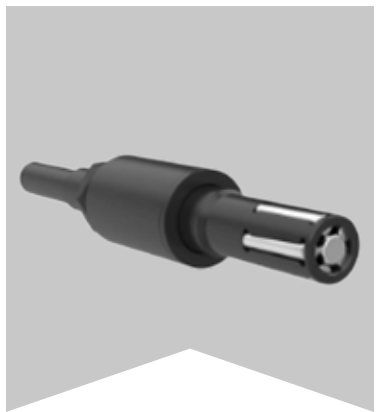

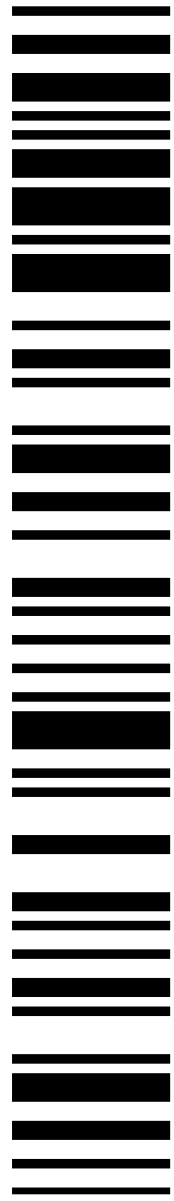

FASTENERS

- ANCHORS
- BOLTS, SCREWS & CAP SCREWS
- NUTS
- PINS, CLIPS & RETAINING RINGS

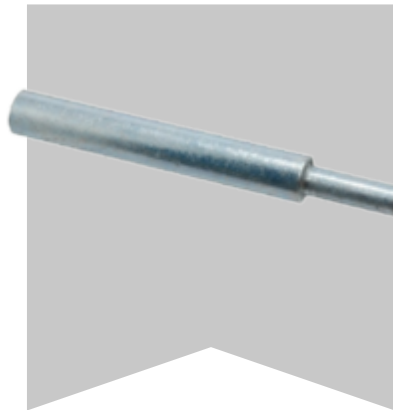

METAL MOLDING &

MRO **SUPPLY**

Contáctanos

Jonathan Álvarez

Manager

www.metalmoldingusa.com

+1 (956) 225-9563

sales@metalmoldingusa.com

1720 W Maple AVE STE 7
Mcallen, TX 78501-8586