

Hans Lehmann

Maschinen und Werkzeuge

Lörrach-Riesstraße 2 - Telefon 2827



Feinmeßzeuge



MAUSER-MESSZEUG G.M.B.H.

7238 Oberndorf/Neckar ☎ (074 23) *71 41

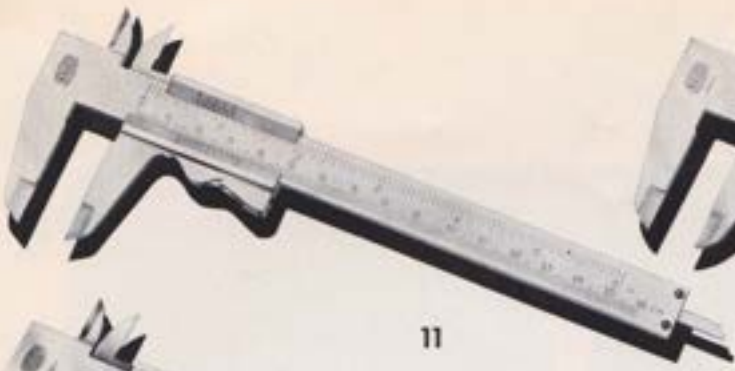

11



131

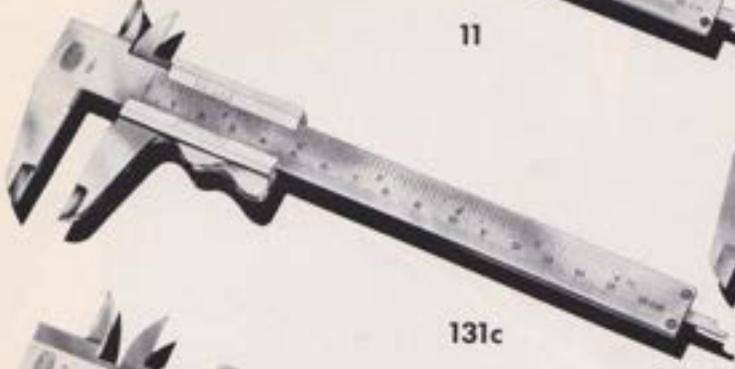

131c

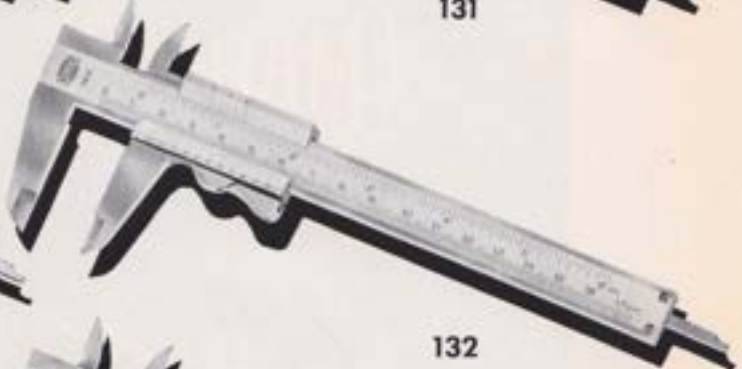

132

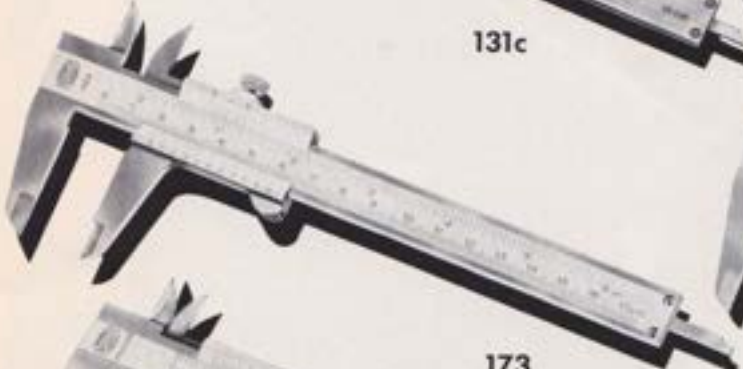

173

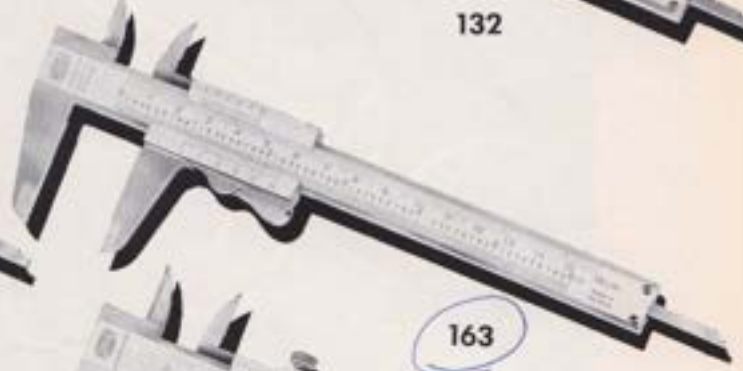

163

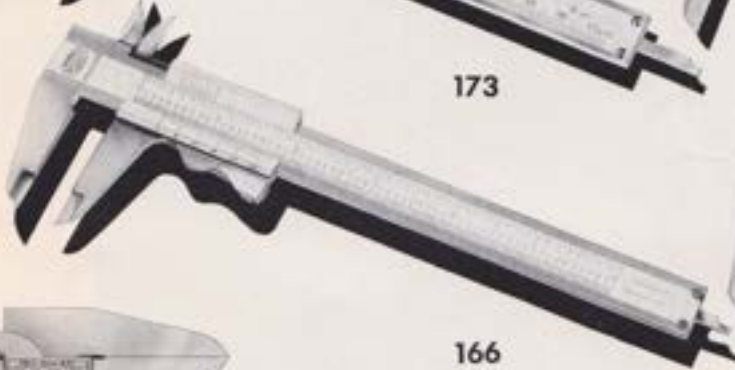

166

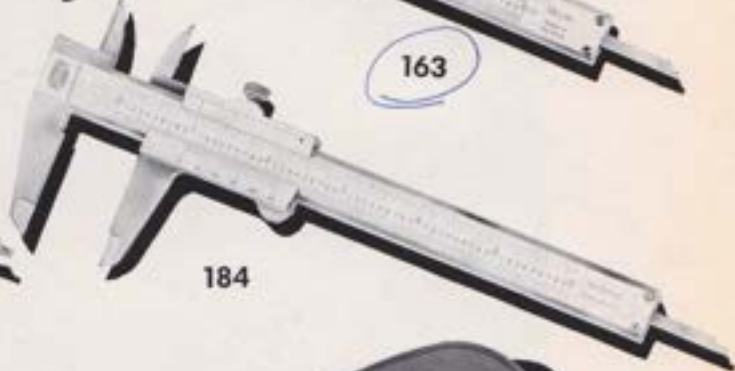

184



1421/L



Nachstellbare
Phosphorbronzegleitfeder

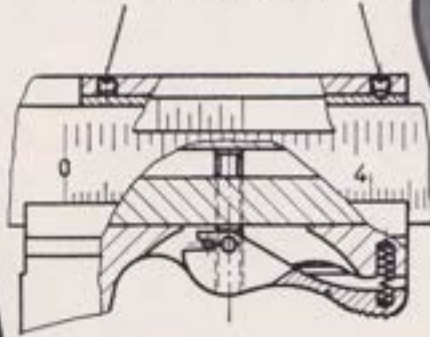

Moment-Feststellung



1422/K

1470





139



179

$\frac{1}{50}$

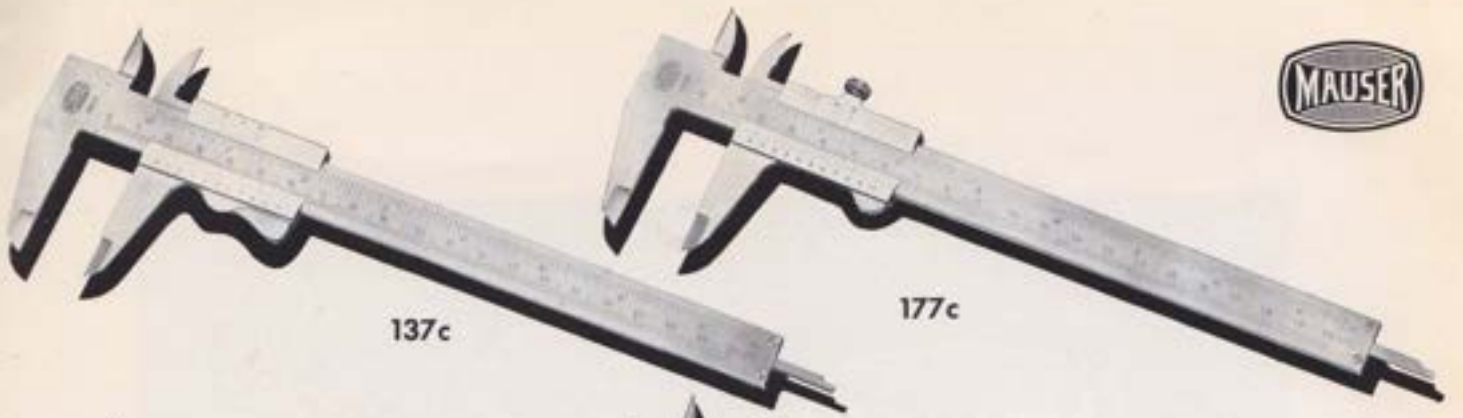

137c

177c

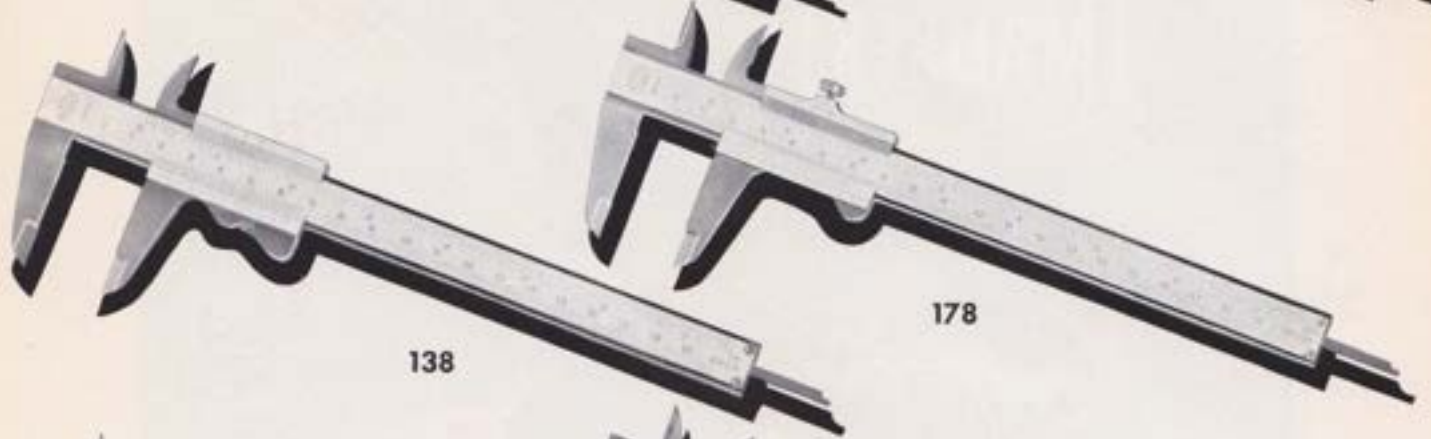

138

178



139

179



191

196

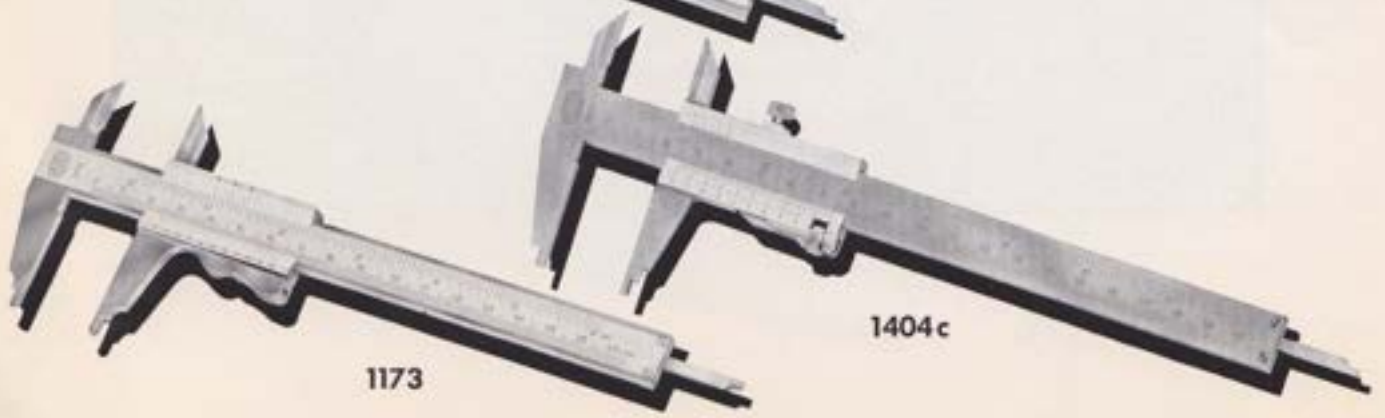

1173

1404c

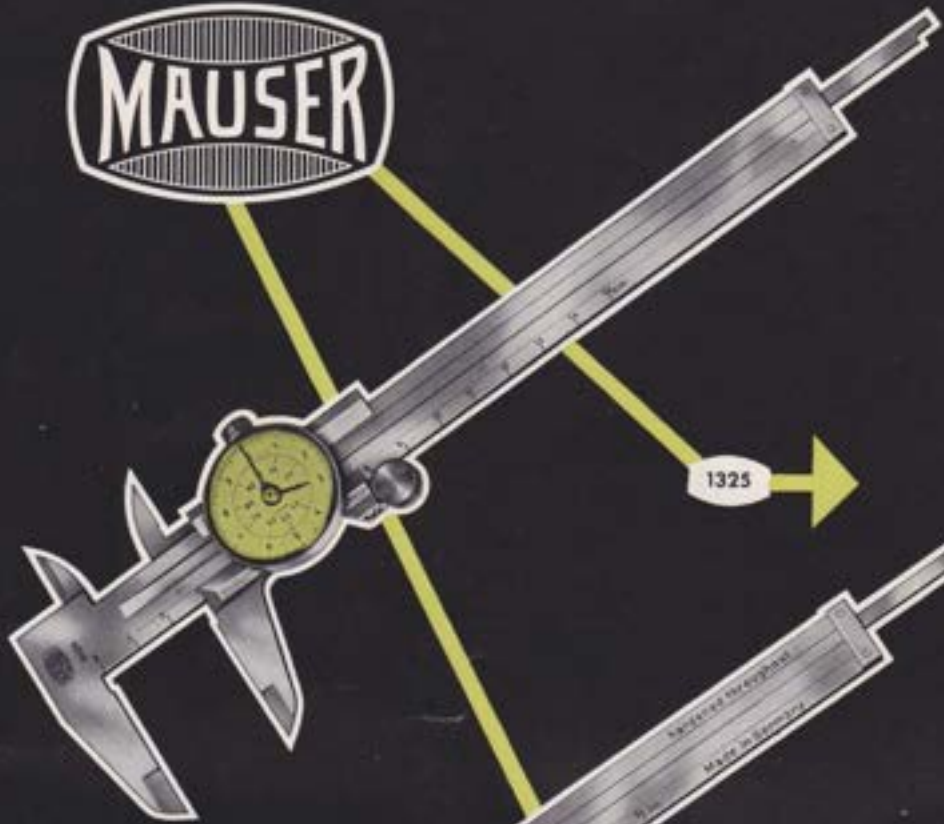

1325

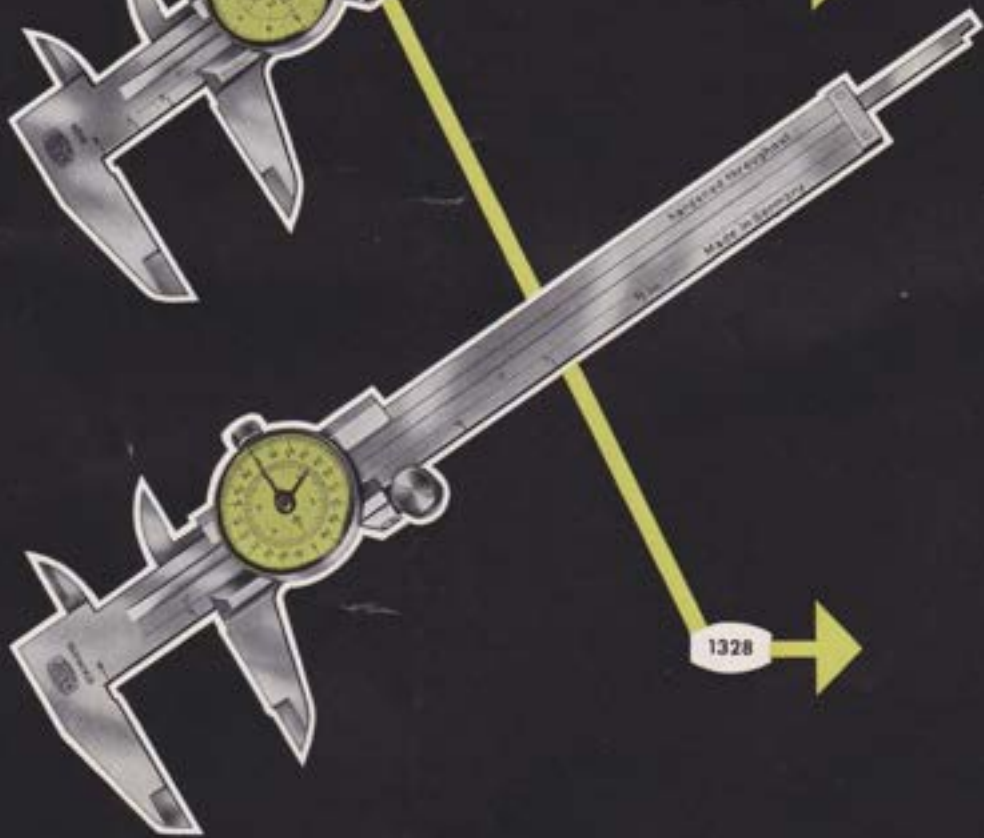

1328



1325

7mm 86,50

1328

92,50



1441

1443

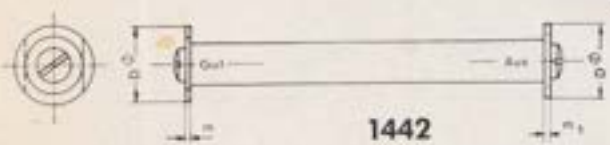

1442

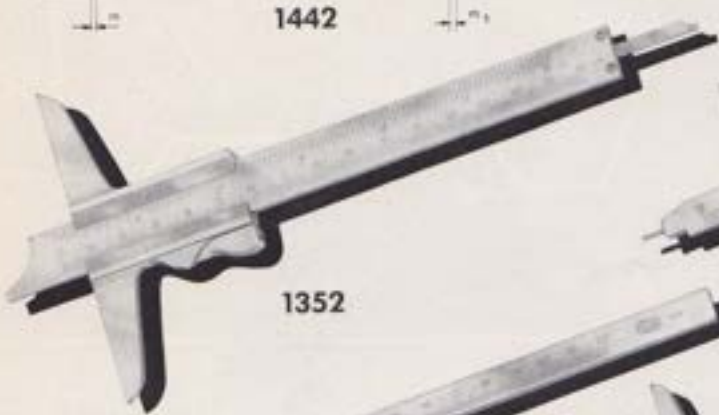

1352



1356/N

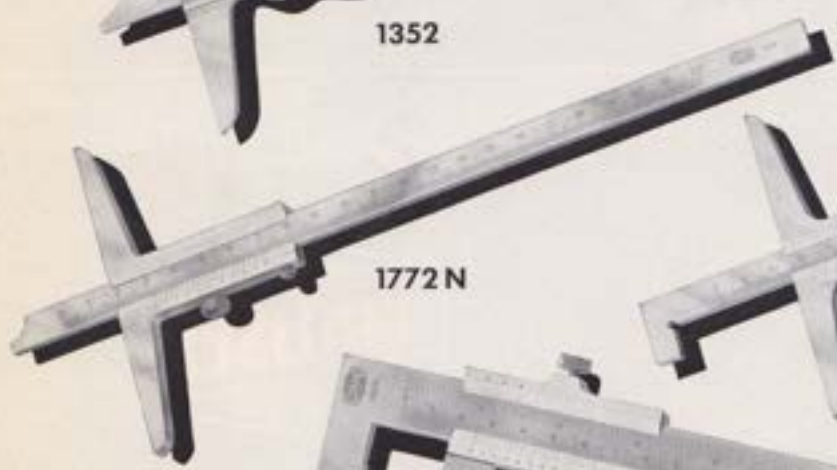

1772 N



1794 N

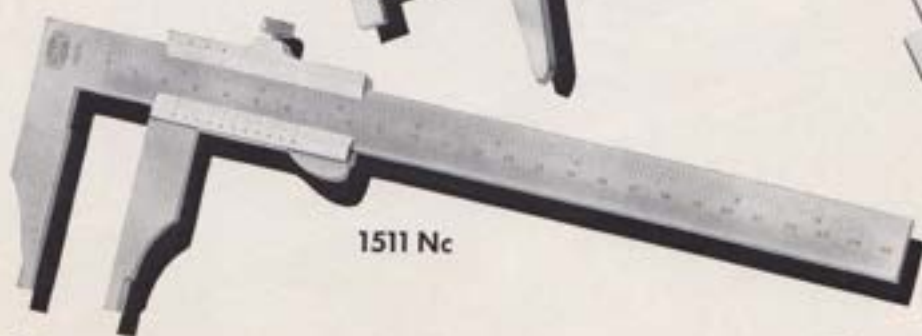

1511 Nc



1599

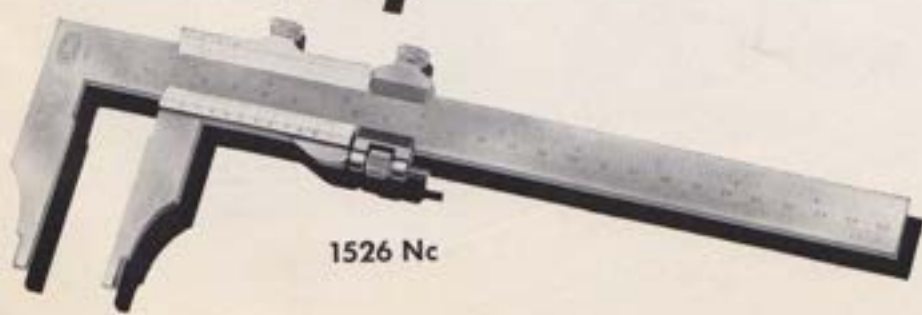

1526 Nc

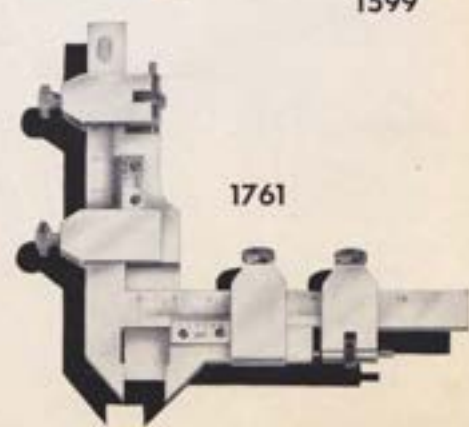

1761

MAUSER

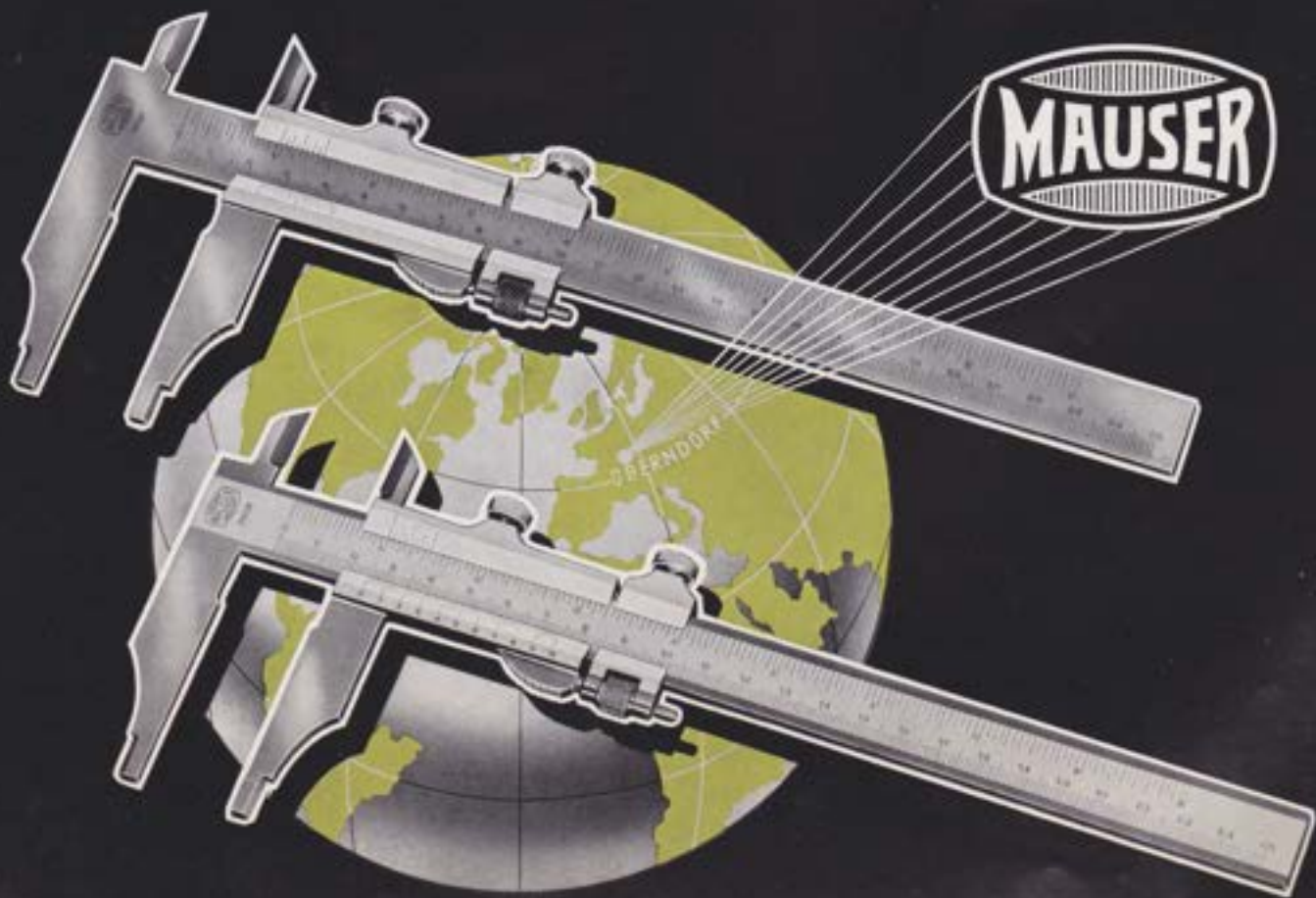
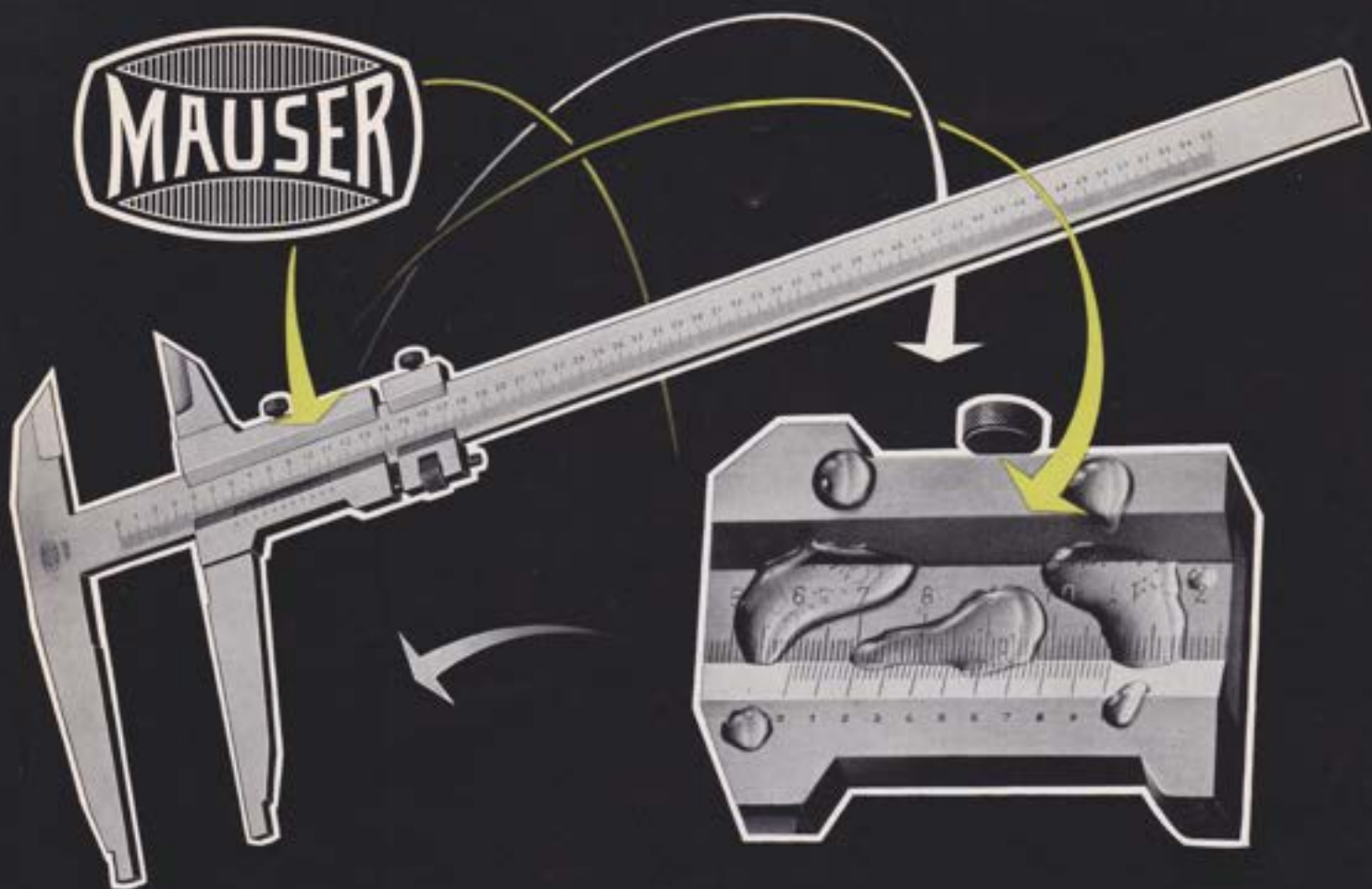



1581 Nc



1596 NCH

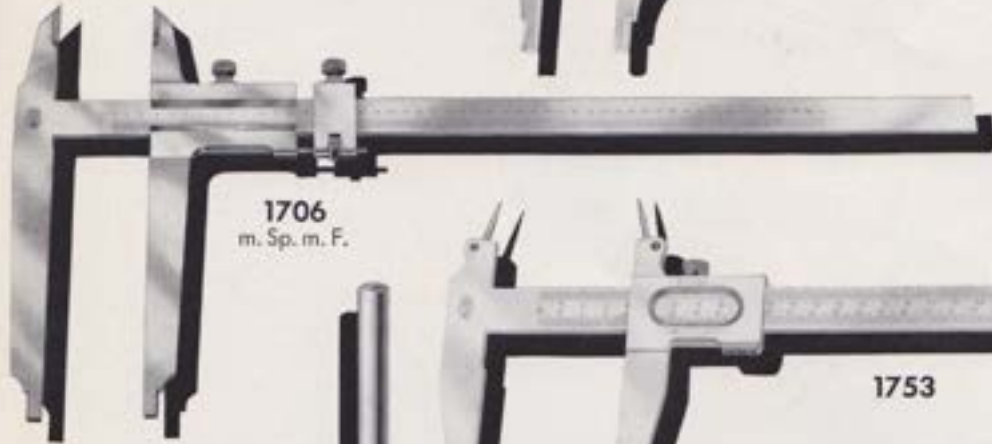

1706
m. Sp. m. F.



1470

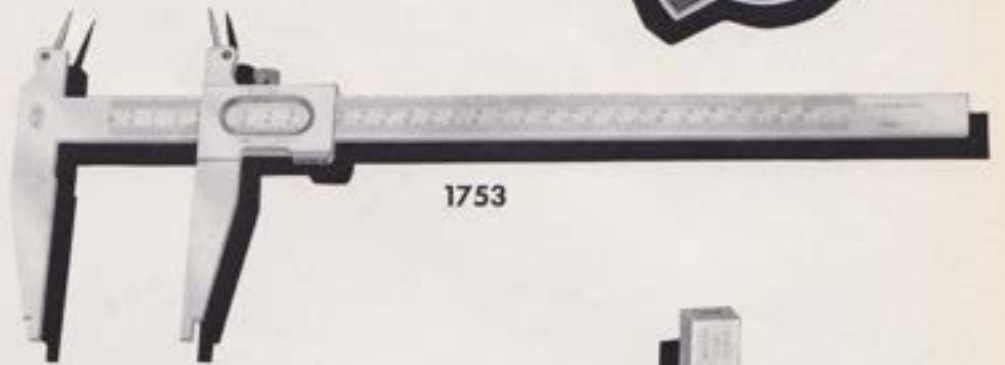

1753

1650

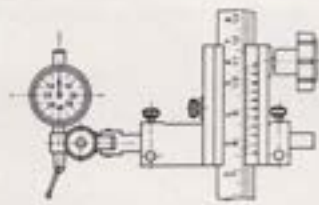

1691

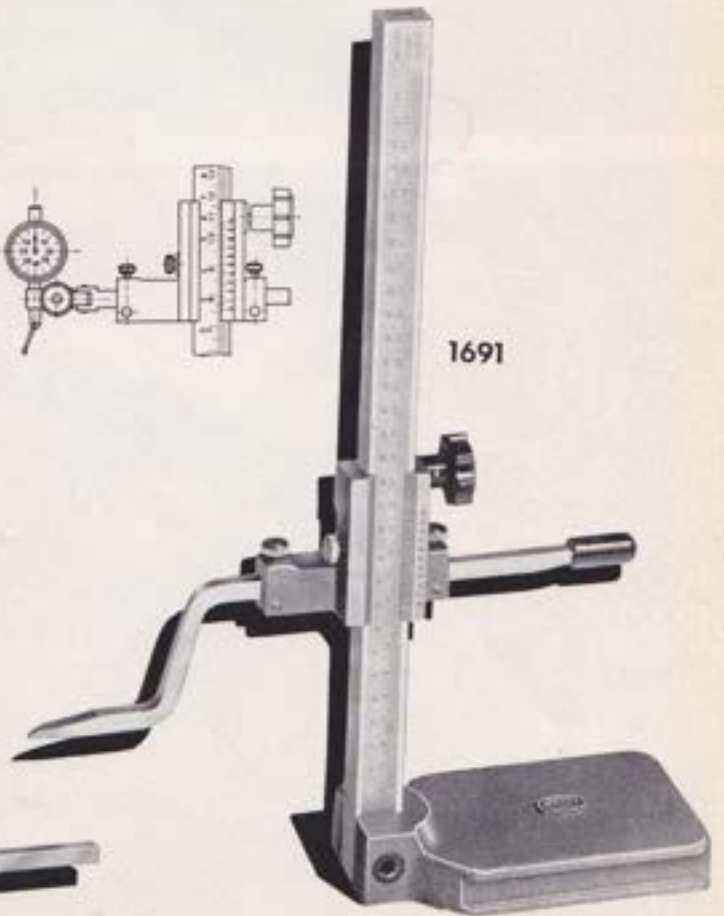

1516 R

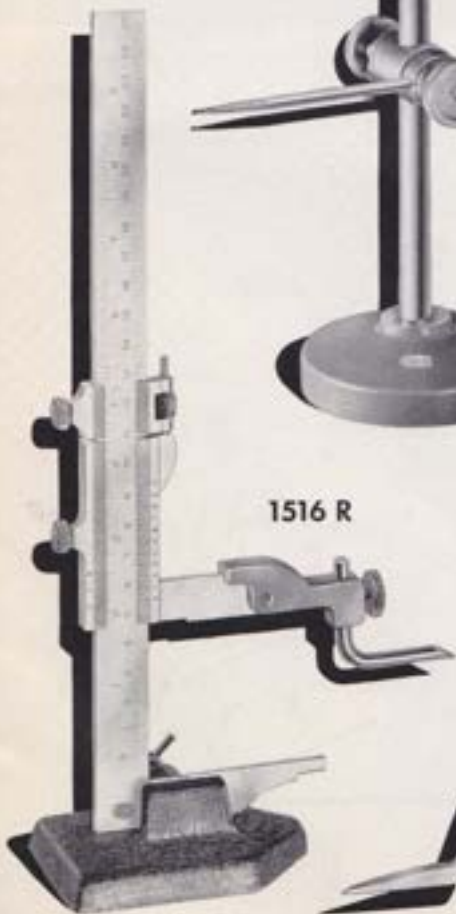

1670

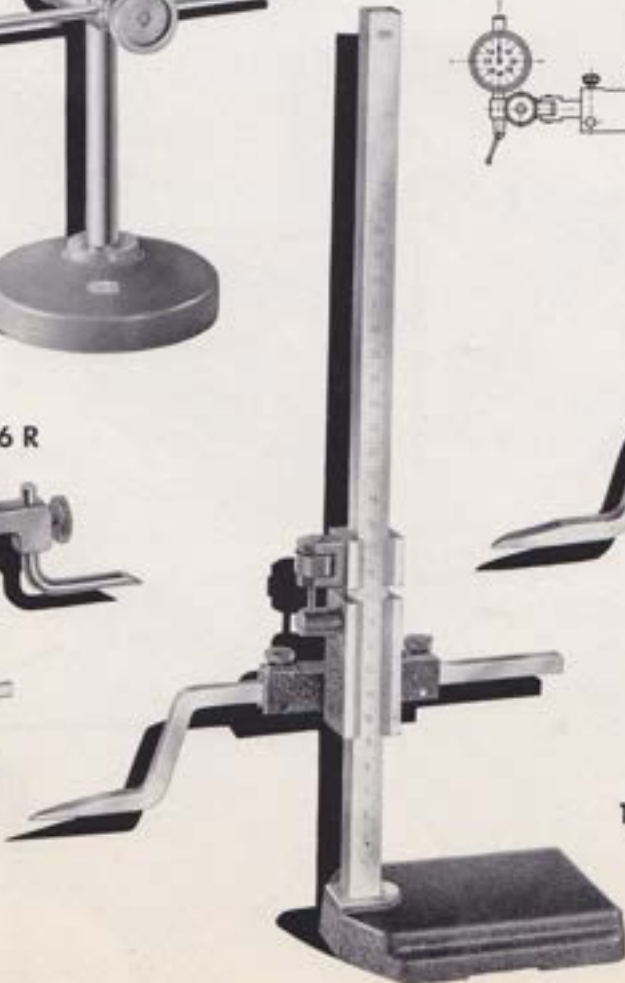

MAUSER

261



MAUSER

2425

2201

2171





240

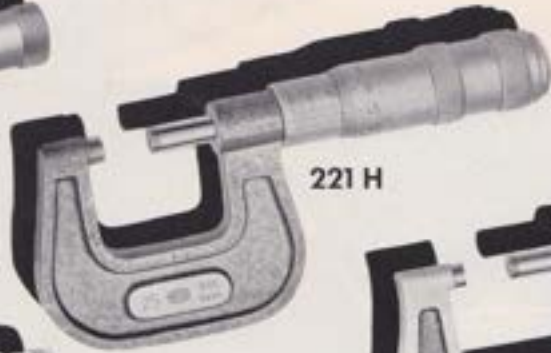

221 H



241 H



241 cZX



241/211



241/I

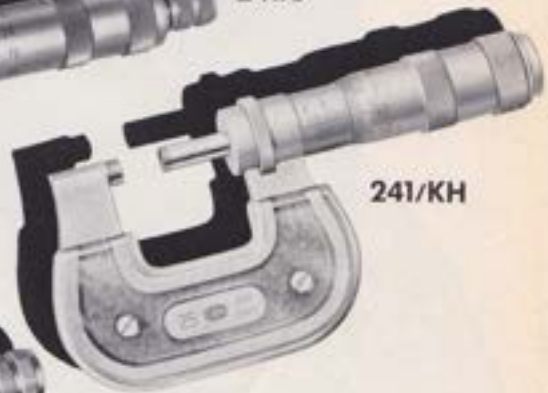

241/KH



261



281/NH



2433



281

2121



2121/215

MAUSER



241/K



2171



2181



2161 H



281/NZ

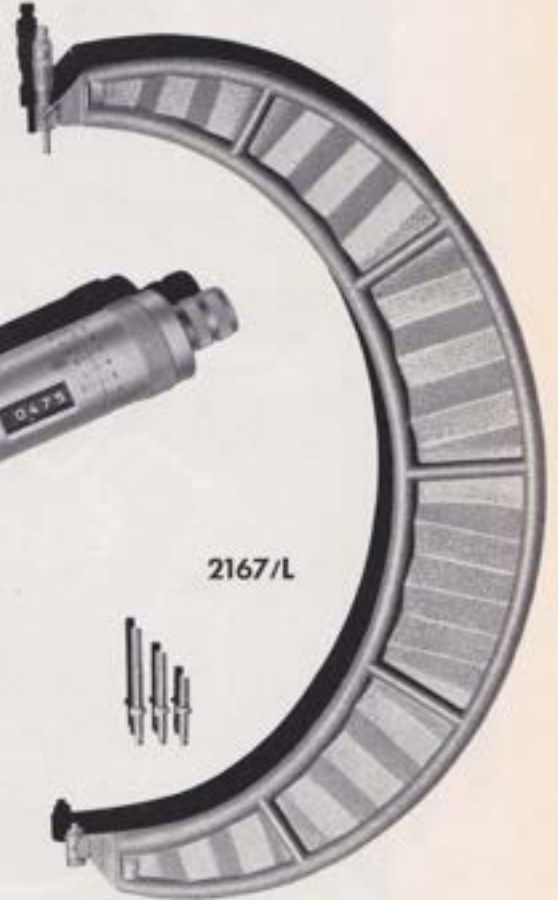

2167/L



2201



2354



2232



2231



2431

MAUSER



241/I



2272



2274



2278/NH



2301-04



2421



2425



2423



2426



2428



2427/I



2281



2441



2451



2501



2504 a



2503



2507 a



2502



2503



2562





2502



2503



2504 a



2507 a



2562



2501



2581



2592/1



2621



2611



2591/2



2262



2601



241

2291



2802



2702



2703



2825

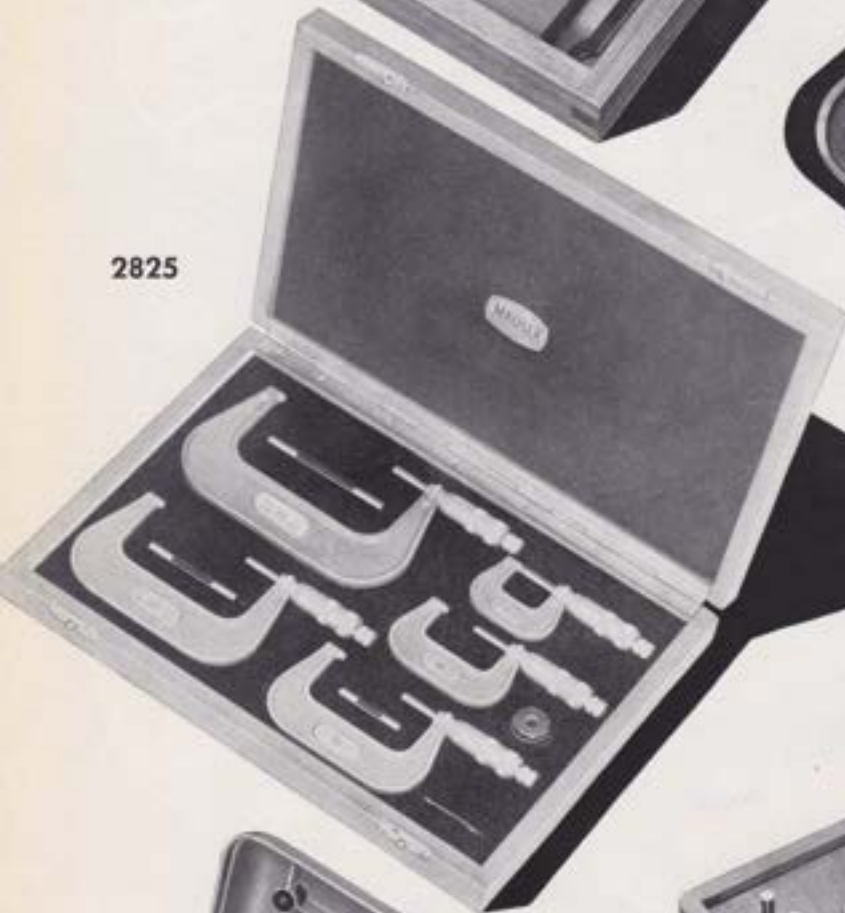

2827



2701







331



331 H



331 H



333

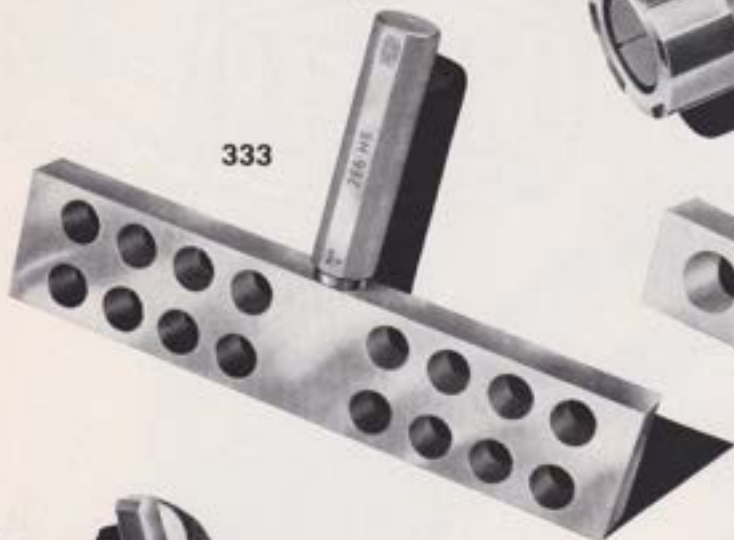

333

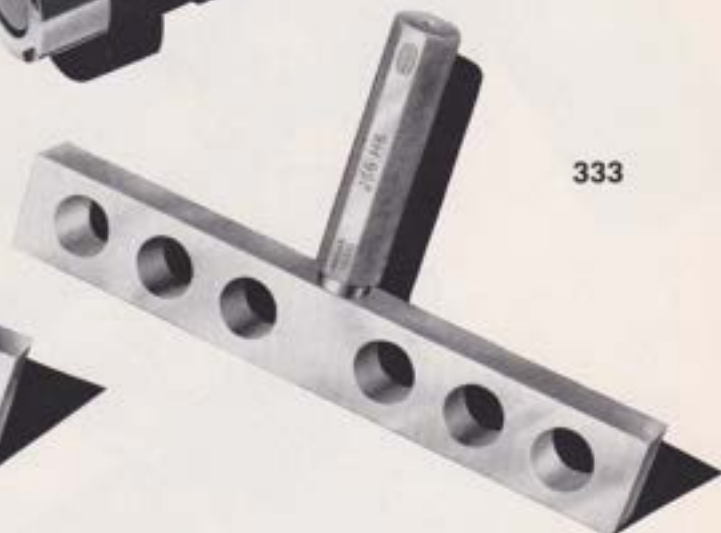

351 H

334



351



361

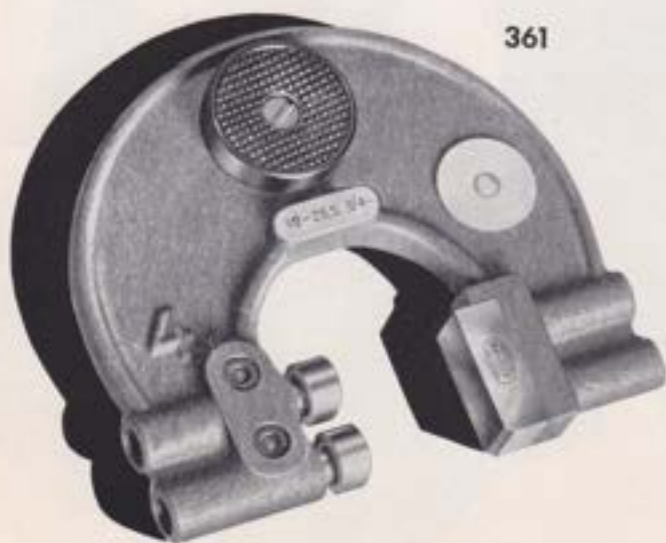

351 e





3111



3112



3113



411



41

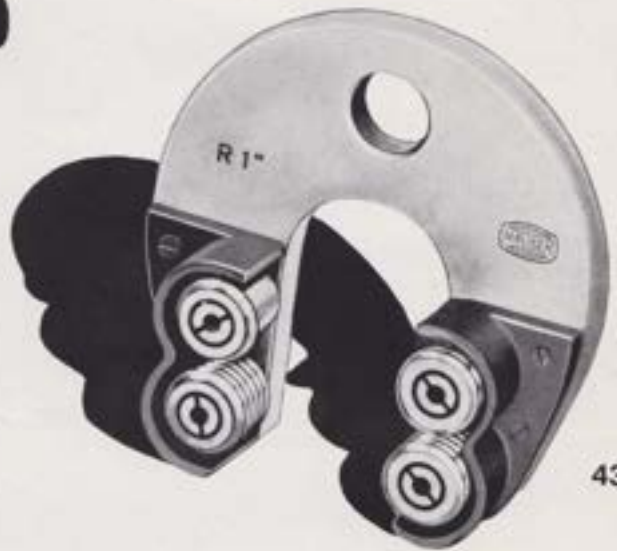

434



431



441



451



461



471



444



481



444a



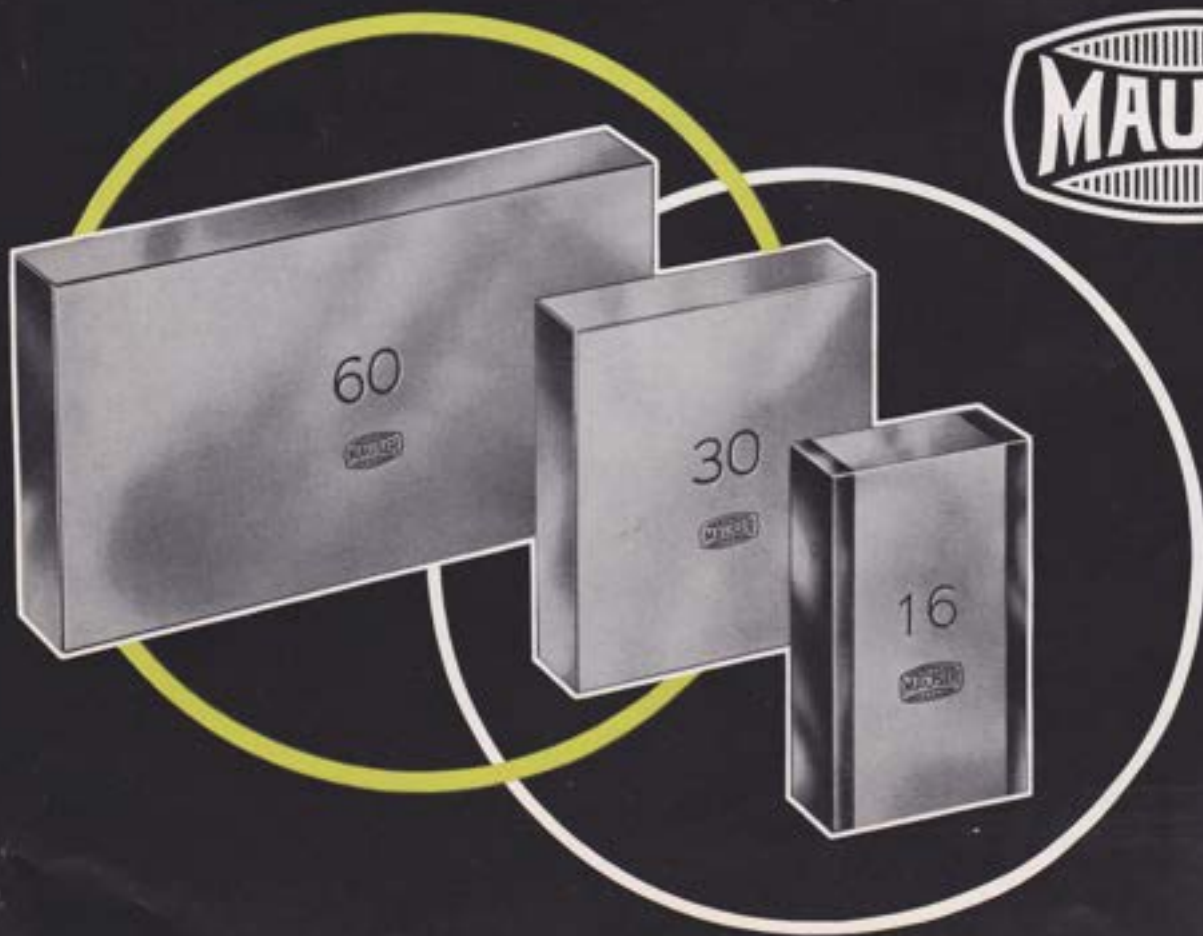
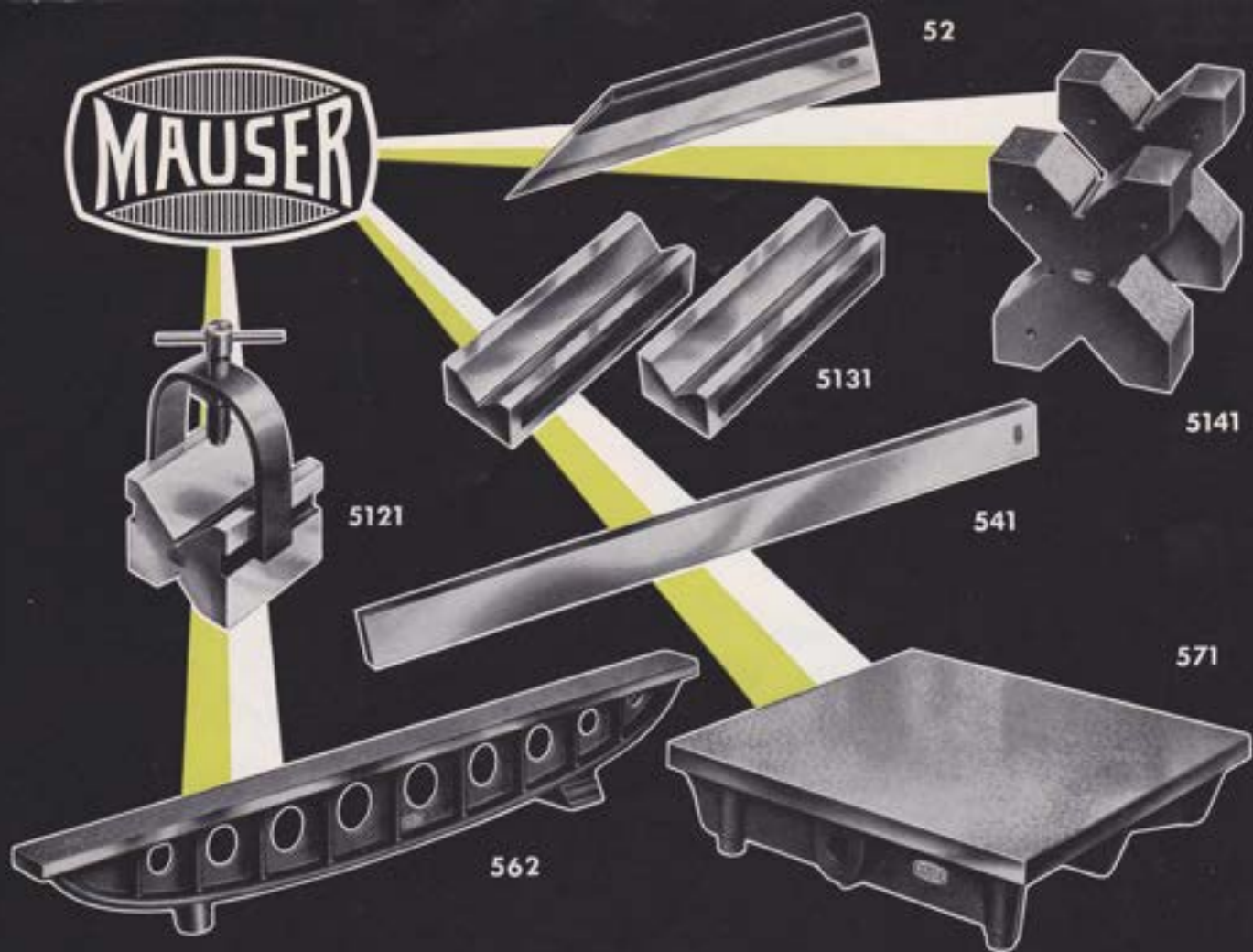



54



5504



541



531



562

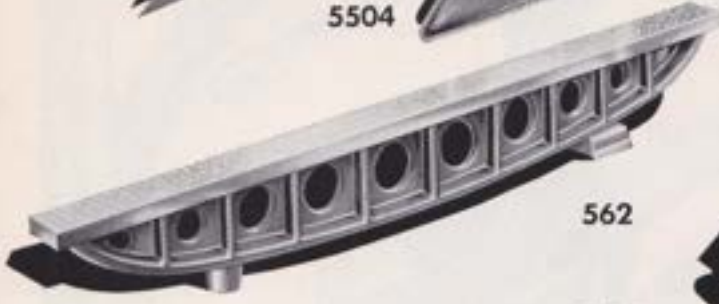

567

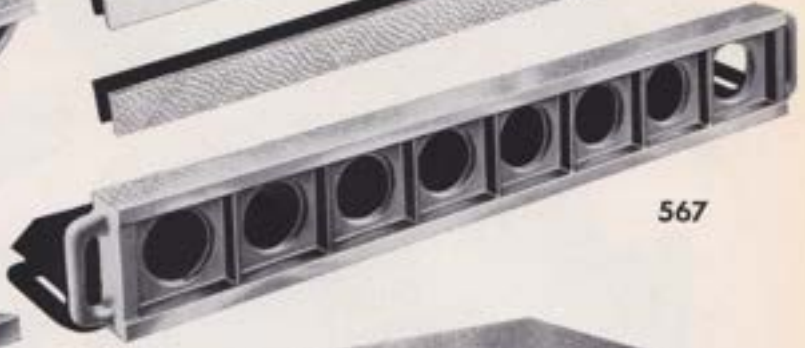

575



571



581

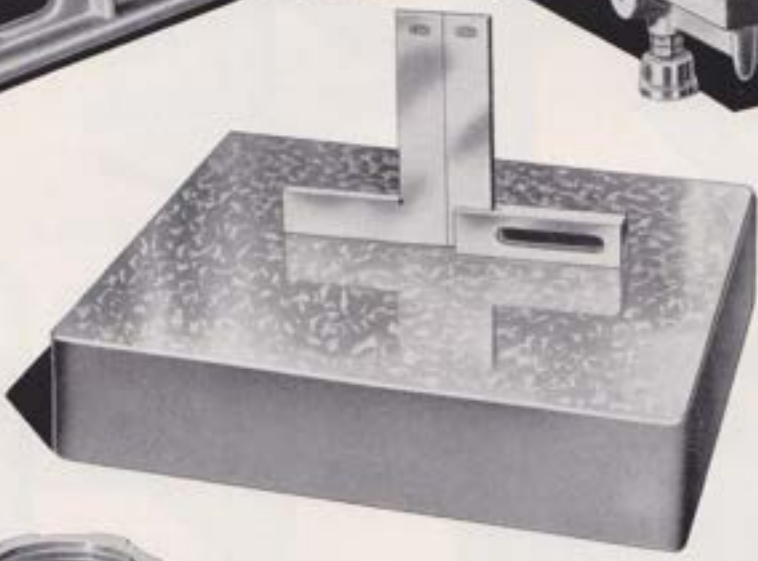

5121

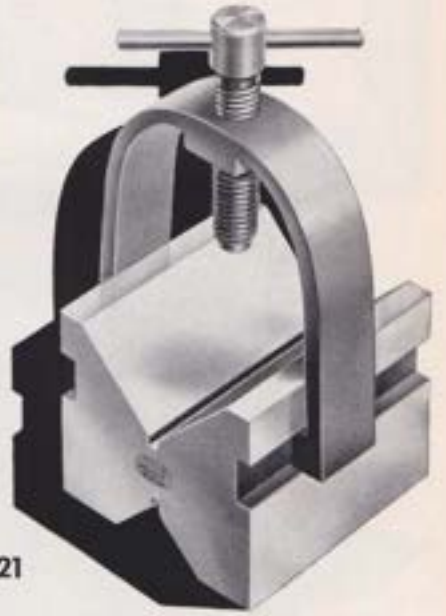

5232

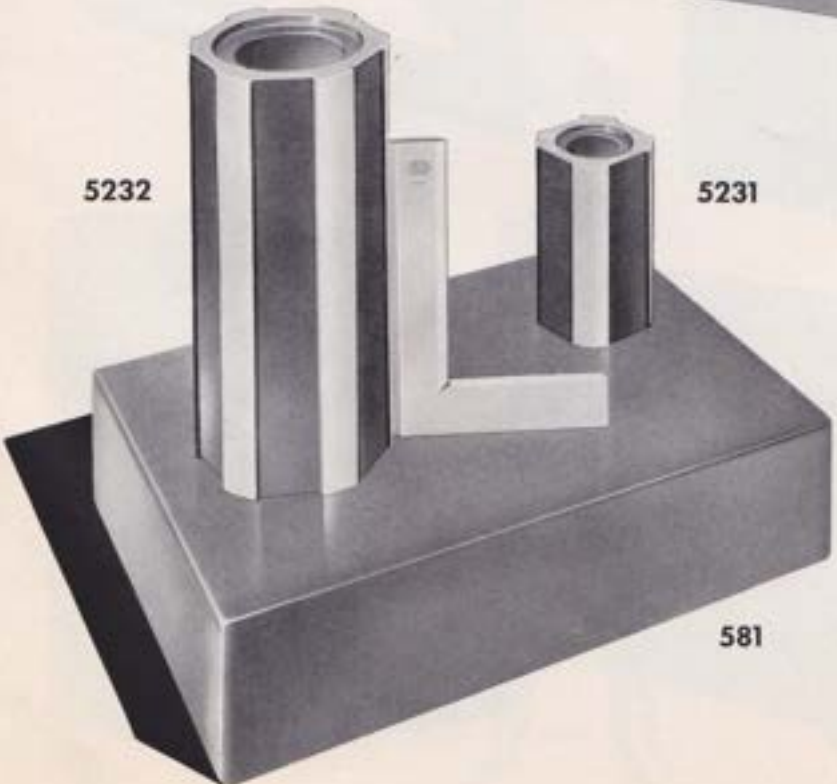

5231



581

5141





596



5102

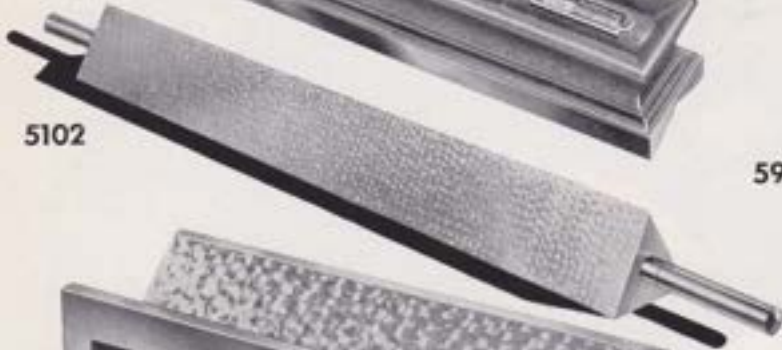

591

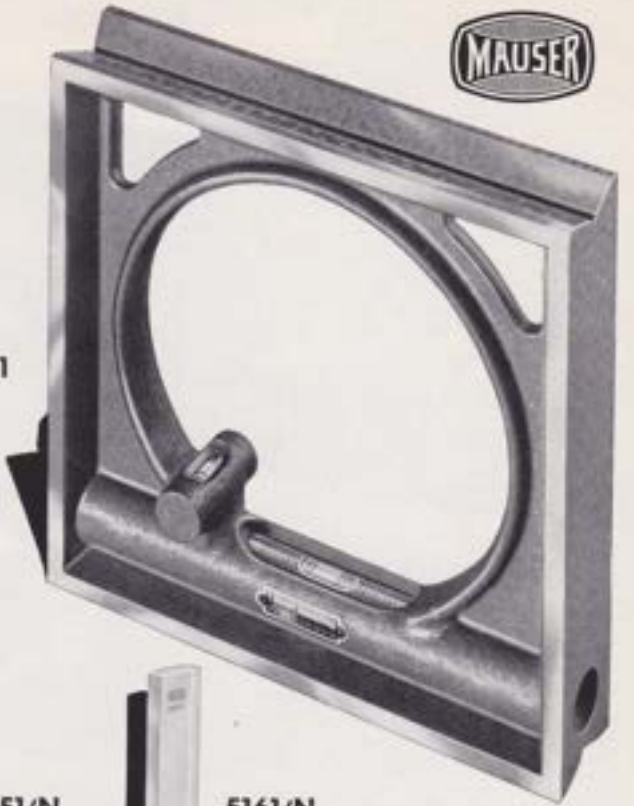

5131



5201/N



5211/N



5151/N



5161/N



5171



5172



5144

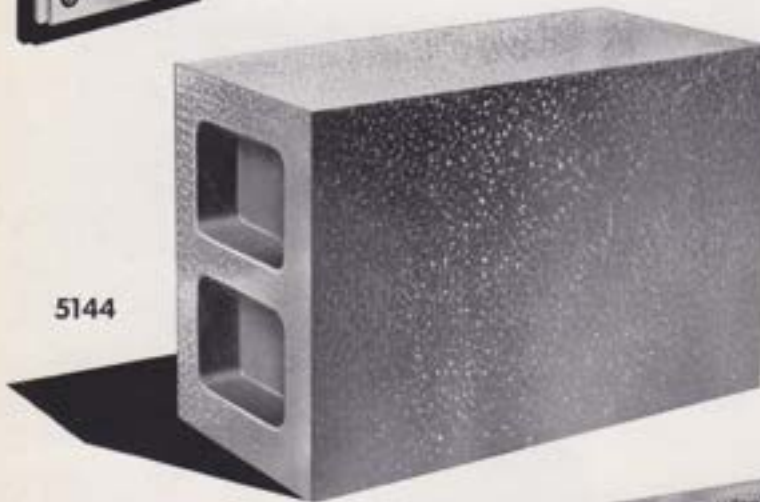

5149

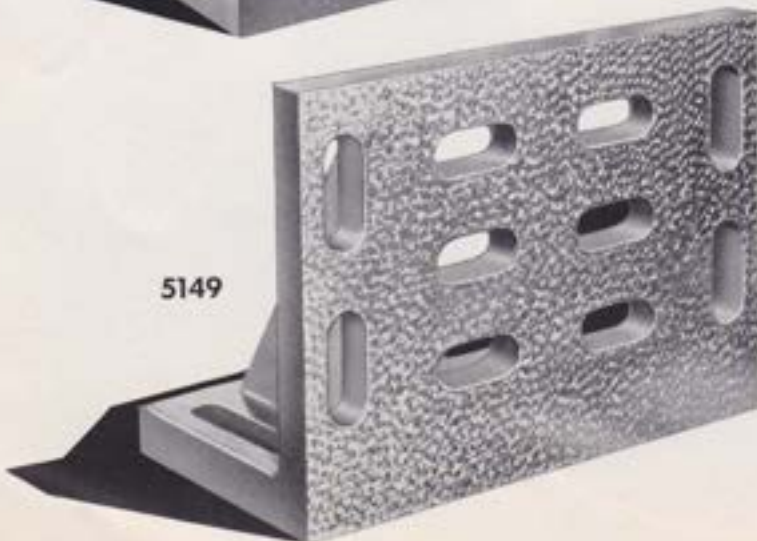

5146



5261



5266

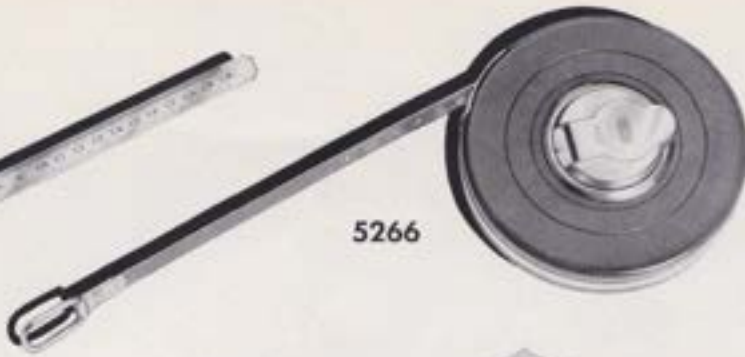

5281



5244

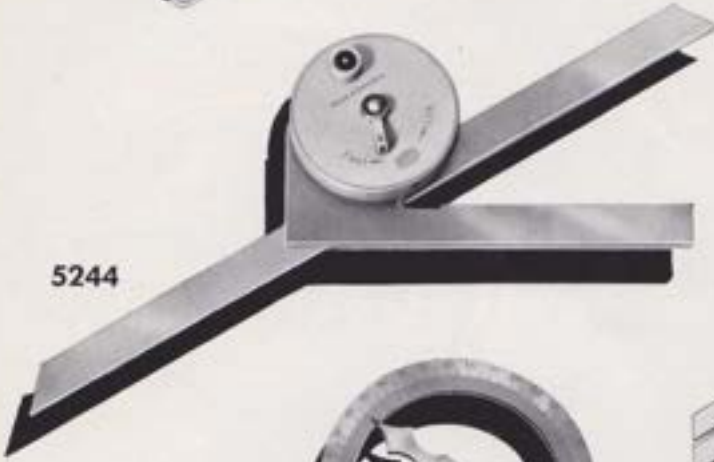

5242

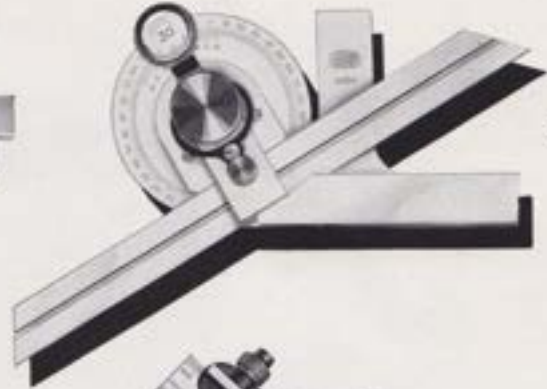

5275/1



5272



5277/2

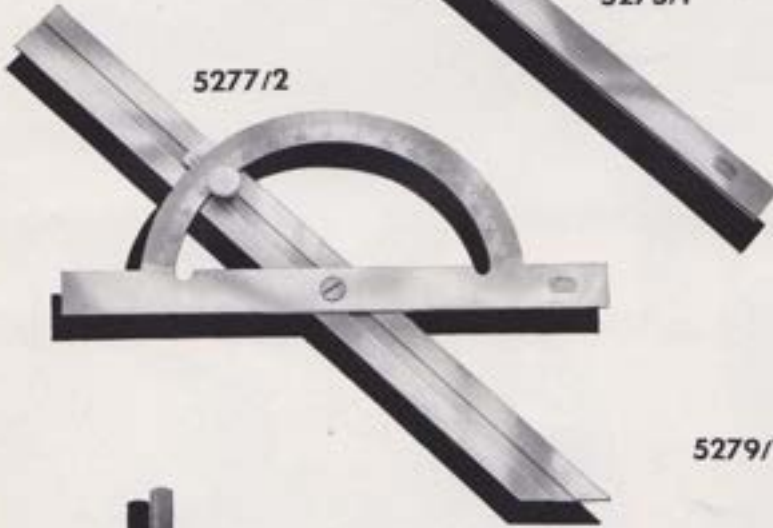

5279/1



5301



5311

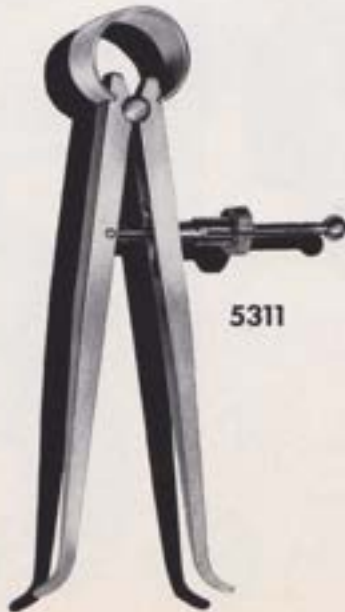

5321





5401

5411



5441

5492



5491



5497



5496

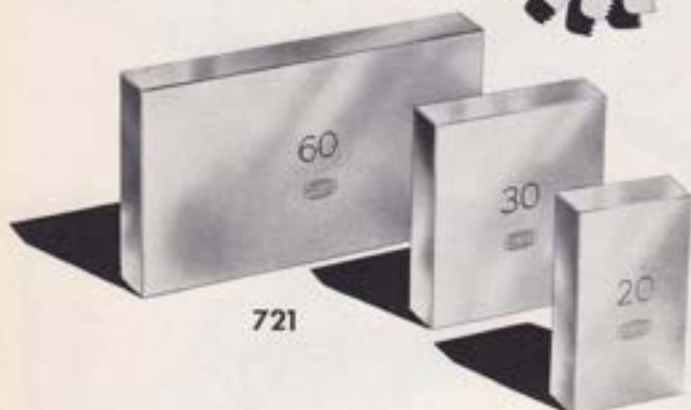

721

71



719



718



720

721



762

723/2

722



715

724

722

723/1

751/R

MAUSER

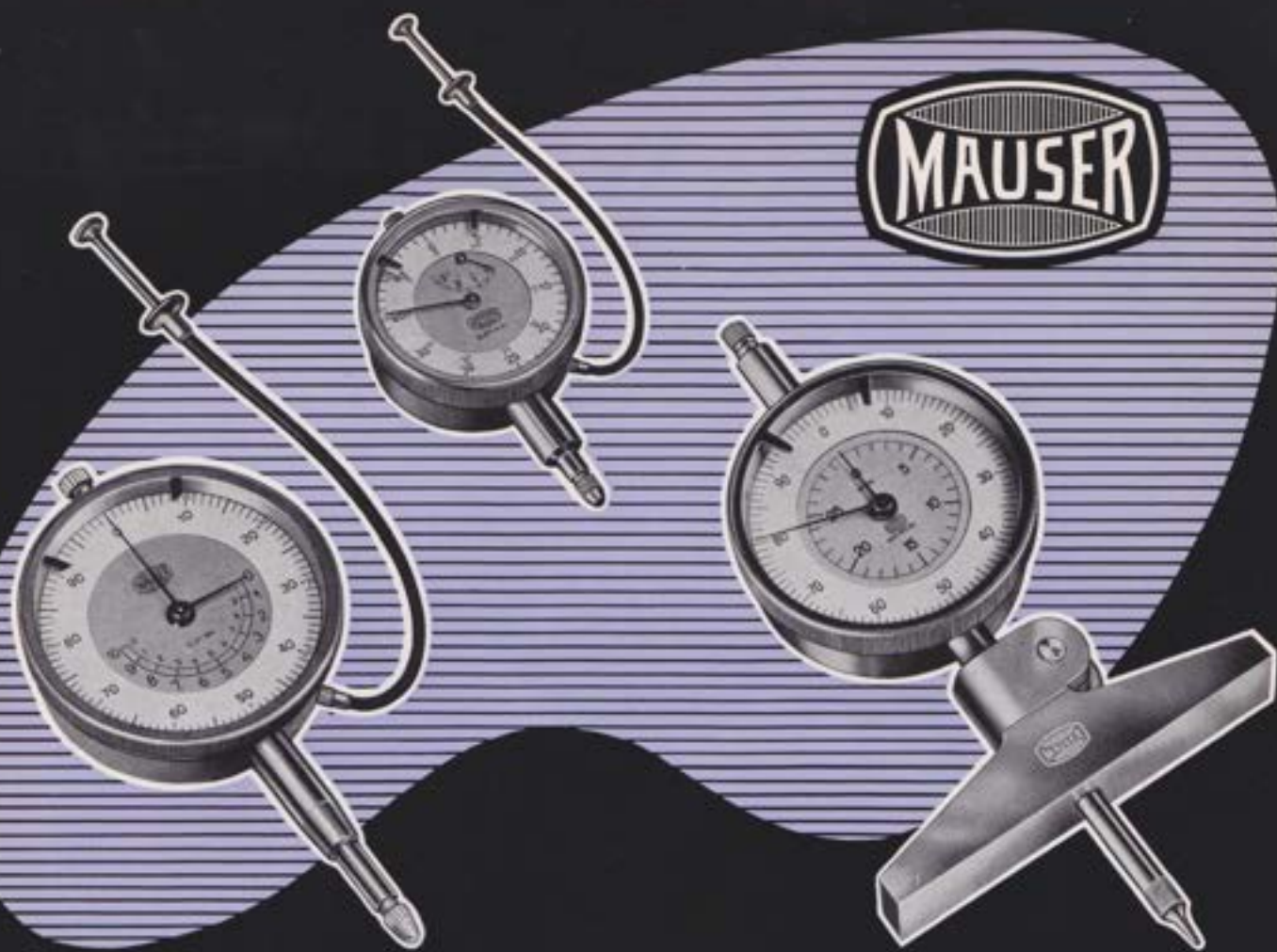

MAUSER

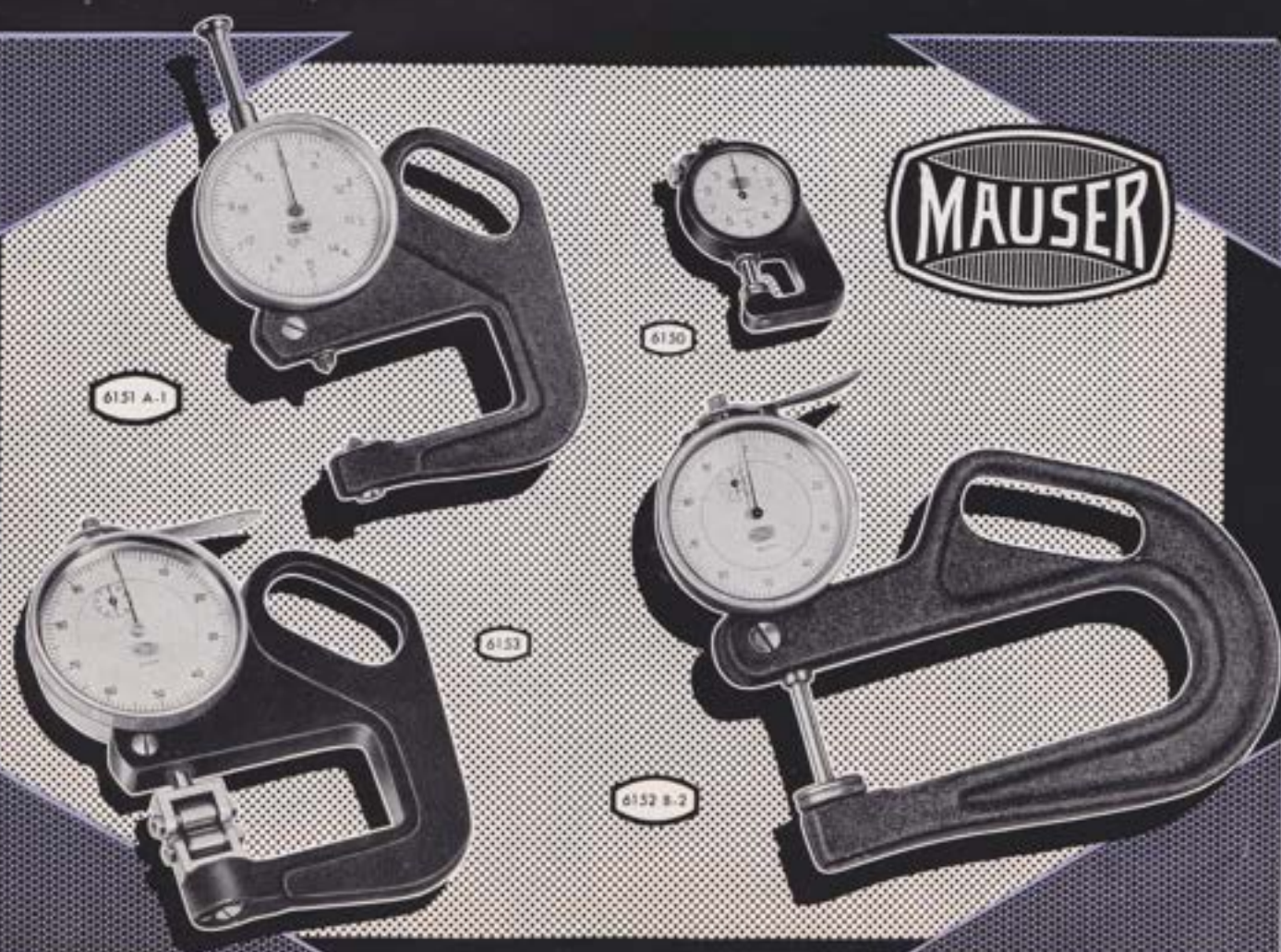

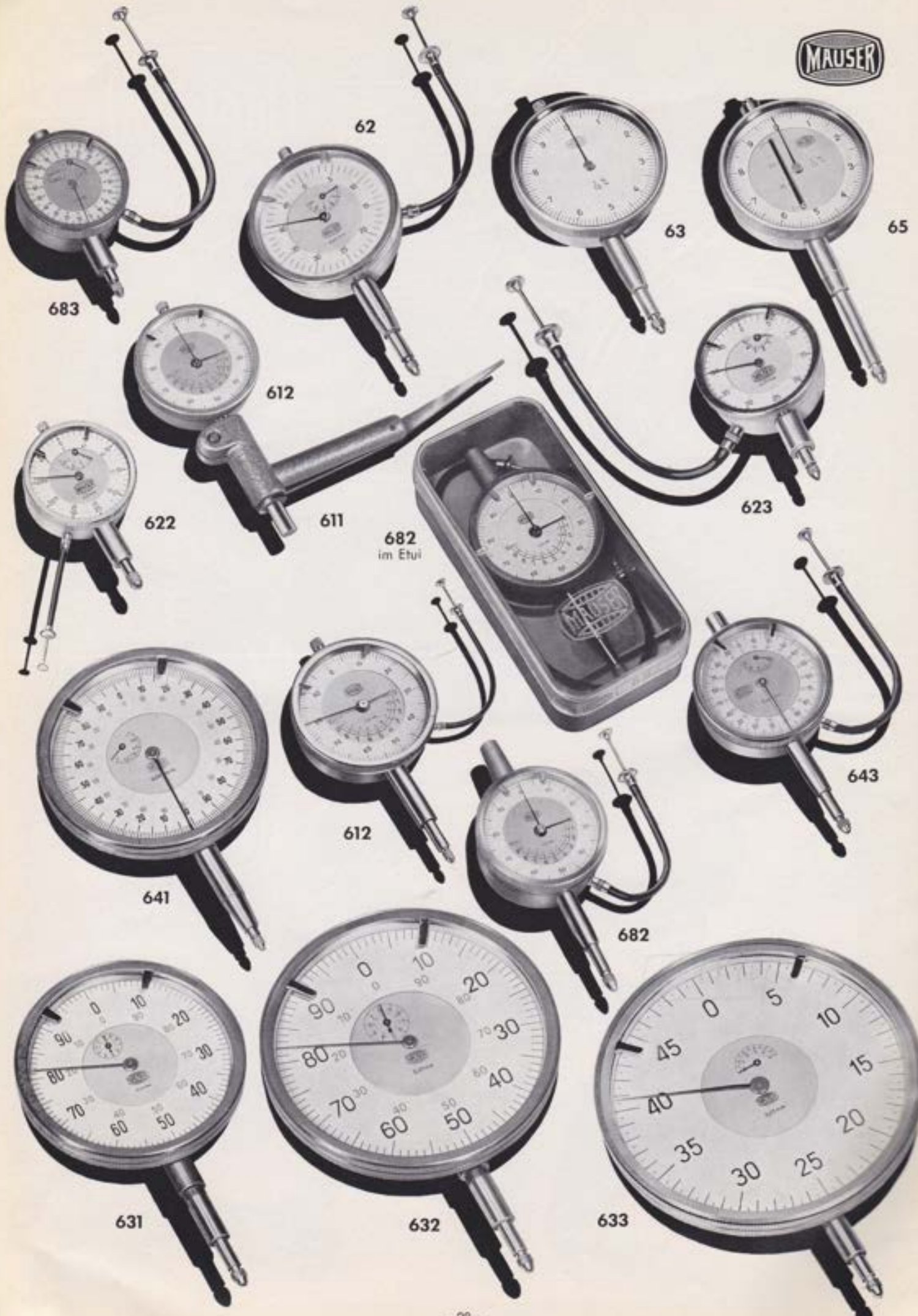

683

62

63

65

612

622

611

682
im Etui

623

643

641

612

682

631

632

633

658





650



649



653



651



652



654



657



677



655



658



662



661



680 67.50



681 67.50

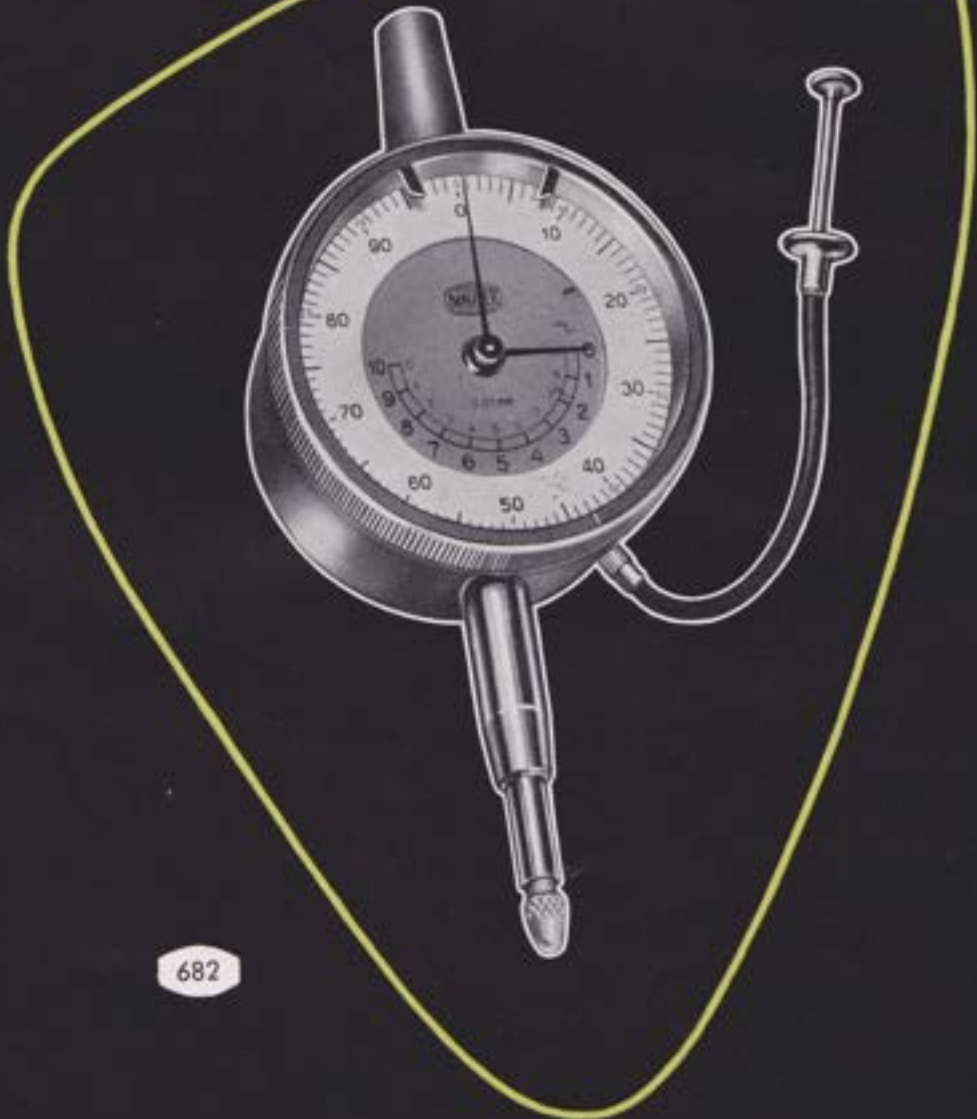

682

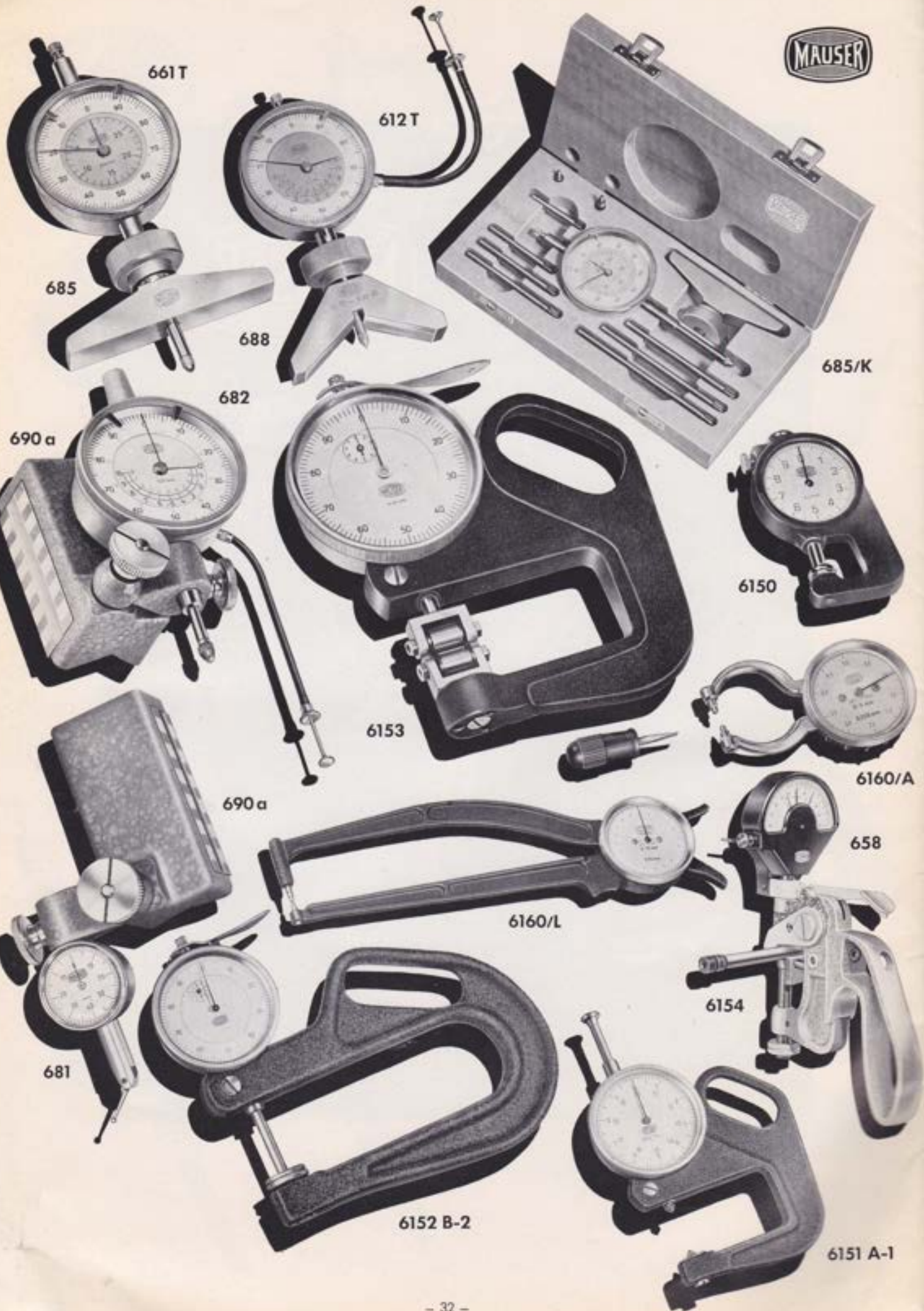

661T

612T

685

688

685/K

682

690 a

6150

6153

6160/A

690 a

658

6160/L

6154

681

6152 B-2

6151 A-1

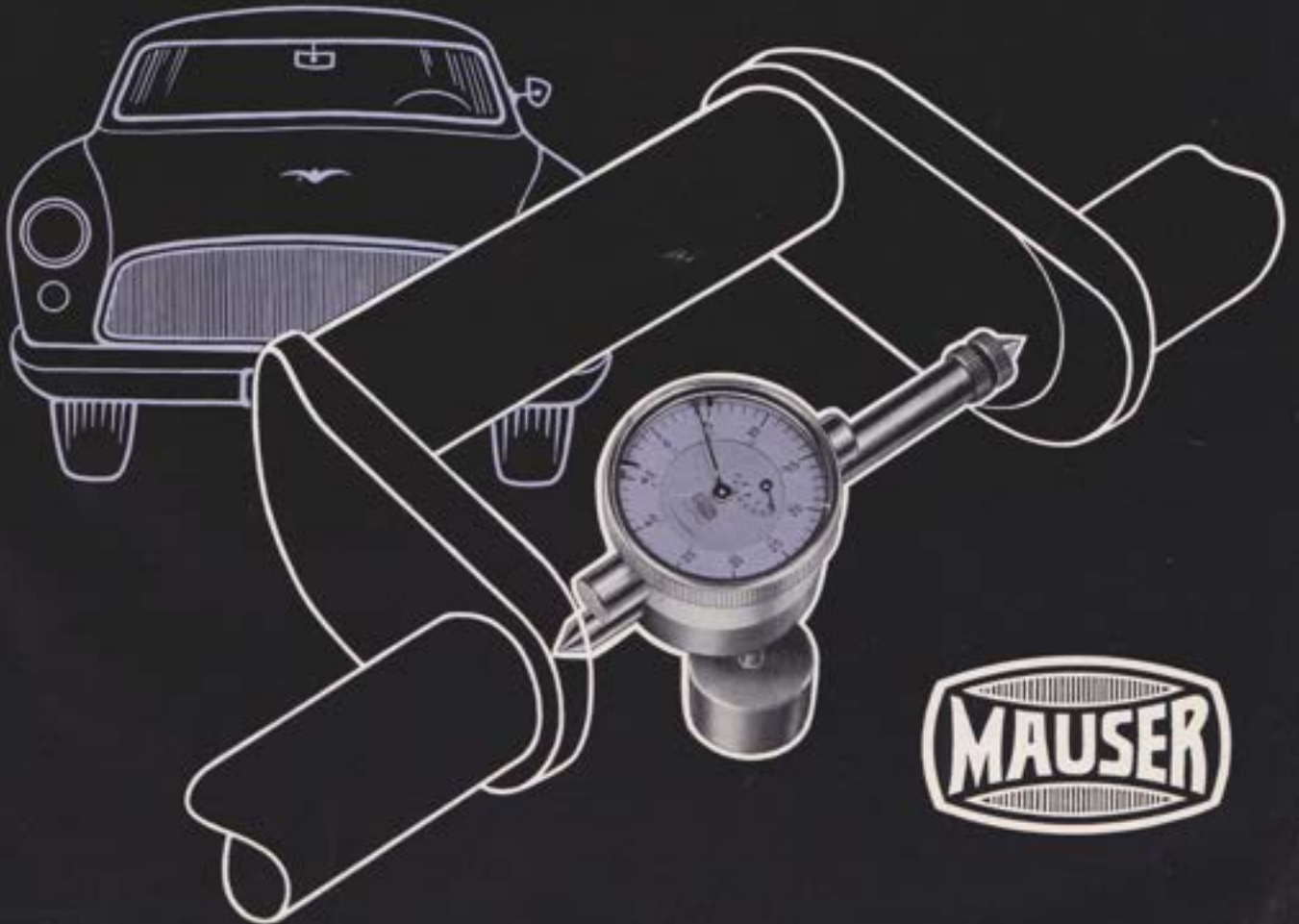
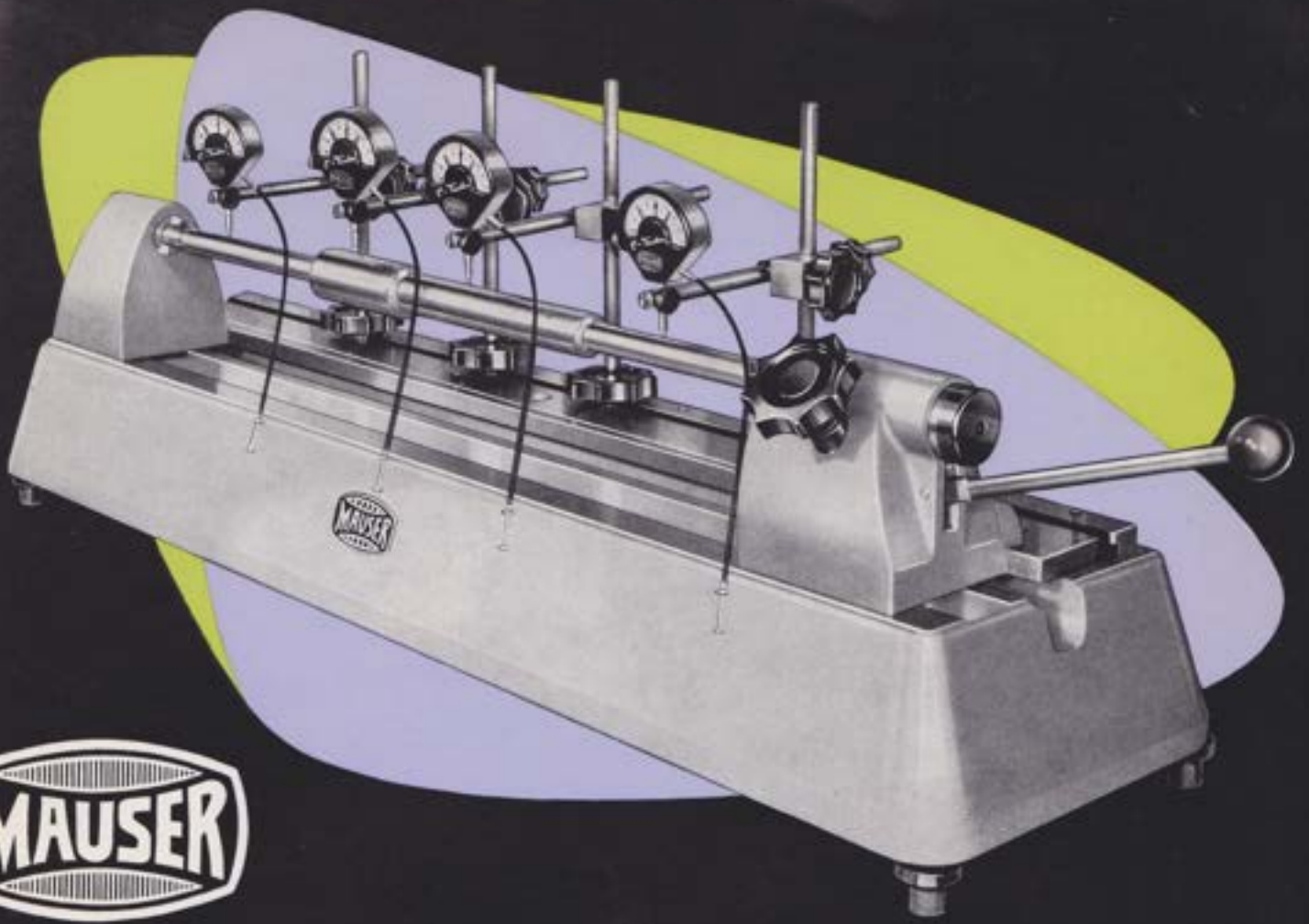



6551



6501



6201



6501

6502



642



6202

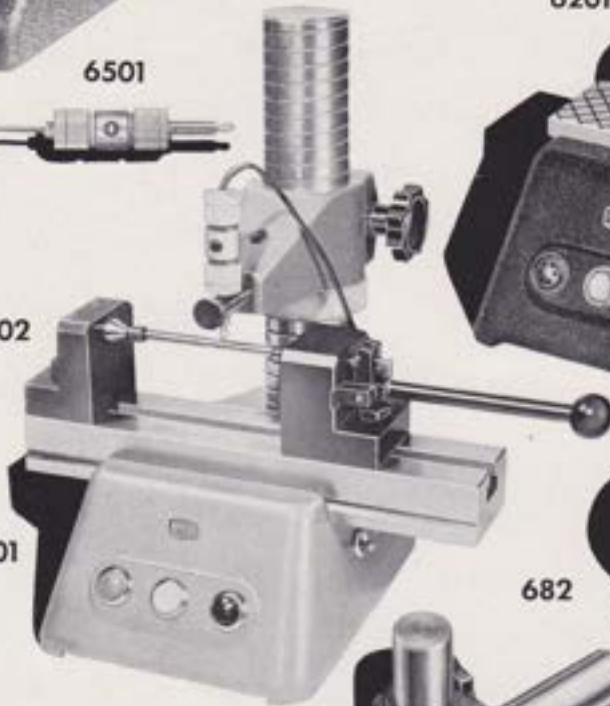

6201



682



682



6102 F

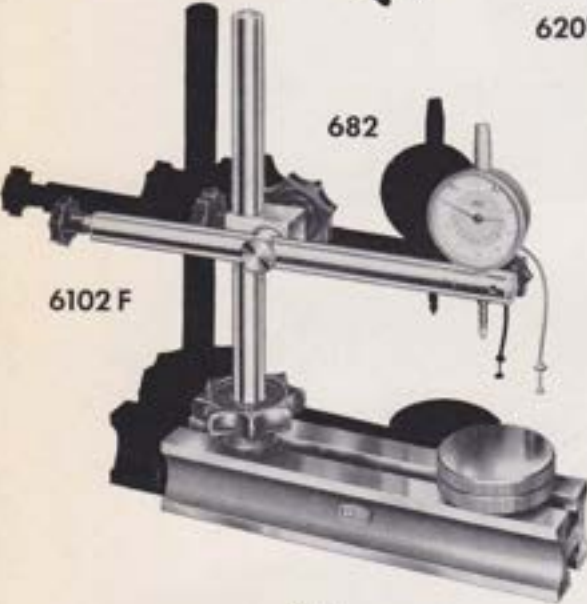

6136 F



6131 F



682



6148 F

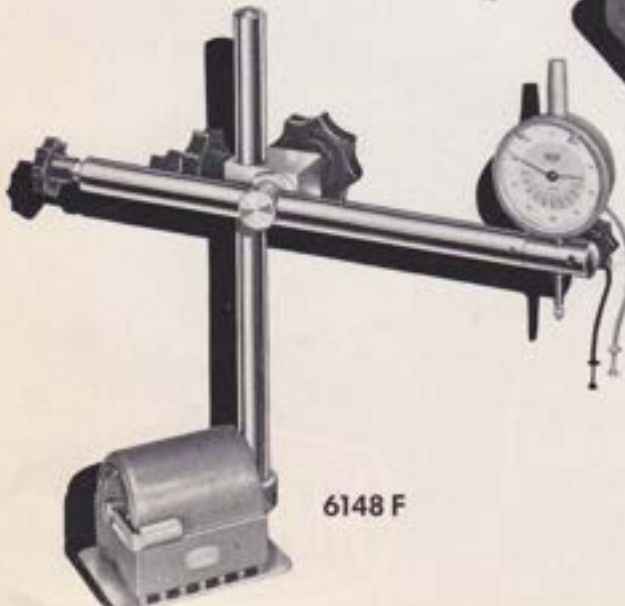

6142 F

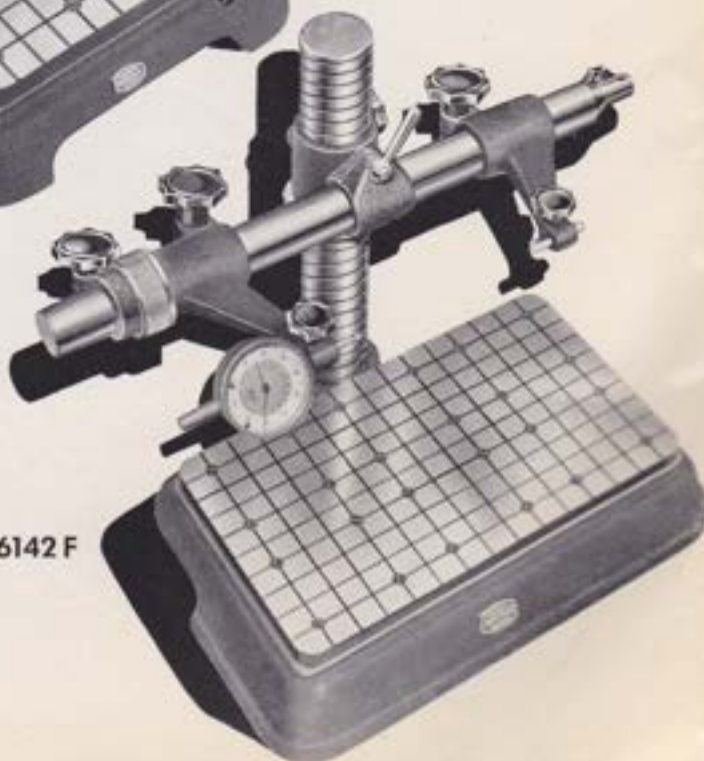



6701



6700/3



6721

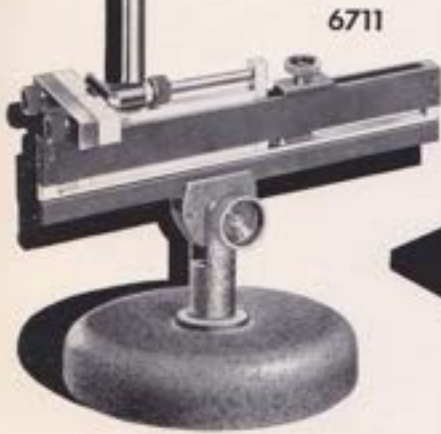

6711



6701-E

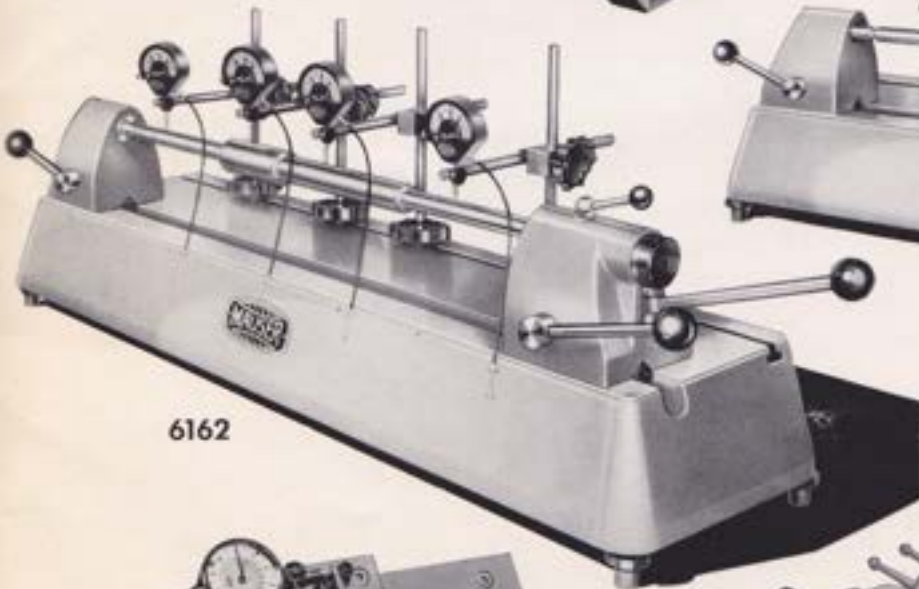

6162



6161

