

STANDARD CATALOG OF®

LUGER

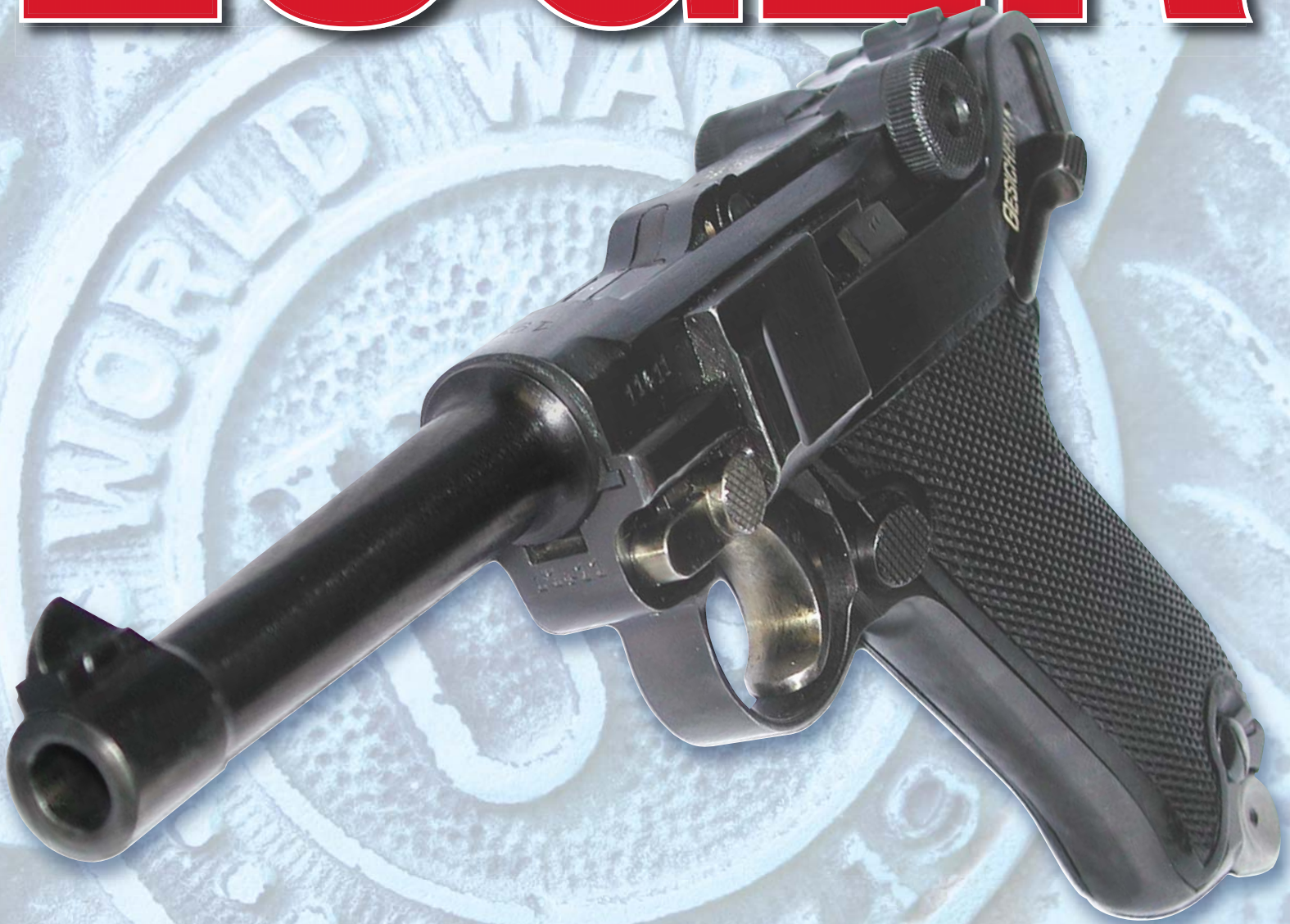

**Identification &
Pricing For All Models,
Every Variation**

Aarron Davis

STANDARD CATALOG OF®

LUGER

Aarron Davis

©2006 by
Aarron M. Davis

Published by



Our toll-free number to place an order or obtain a free catalog is 800-258-0929.

All rights reserved.

No portion of this publication may be reproduced or transmitted in any form or by any means, electronic or mechanical, including photocopy, recording, or any information storage and retrieval system, without permission in writing from the publisher, except by a reviewer who may quote brief passages in a critical article or review to be printed in a magazine or newspaper, or electronically transmitted on radio, television, or the Internet.

Library of Congress Catalog Number: 2006922210

ISBN 13: 978-0-89689-411-2

ISBN 10: 0-89689-411-8

Designed by Patsy Howell
Edited by Kevin Michalowski

Printed in the United States of America

Contents

<i>Dedication</i>	4
<i>Foreword</i>	4
<i>Chapter 1</i>	Luger History	5
<i>Chapter 2</i>	Luger Mechanics	7
<i>Chapter 3</i>	Luger Markings	11
<i>Chapter 4</i>	Lugers by Era and User	19
<i>Chapter 5</i>	Lugers by Manufacturer	24
<i>Chapter 6</i>	Lugers by Features	27
<i>Chapter 7</i>	Lugers in Detail	28
<i>Chapter 8</i>	Luger Accessories	240
<i>Chapter 9</i>	Luger Collecting Advice	246
<i>Chapter 10</i>	Summary of Values	248

Dedication

To my recently deceased father, a shooter, gun collector, and inspiration in so many ways.

Foreword

The organized (usually) mind of a future engineer made me set out on a task back in elementary school. That task was to organize what seemed to me the jumble of Luger data. I remember leafing through my first (now worn out) copy of Kenyon like other kids would look through the Christmas toy catalog. I remember using gun-cleaning patches as bookmarks to flag Lugers I wanted to find out more about. I fondly remember many dealers at the gun shows that would let me inspect the Luger pistols on their tables. My own three-ring binder of notes would draw much attention at gun shows and

at estate sales. About the third or fourth time someone asked for a copy of my notes, I realized that I had them organized in a way that others would find useful.

This book is a result of 10 years of updates and refinements to my earlier work. Since my first book on this subject I have learned even more, sometimes new stuff, sometimes corrected information. At the same time, the body of knowledge of the Luger collecting community continues to grow. I sincerely hope that the humble offering of this reference will be a useful aid to Luger collectors.

Luger History

From Maxim to Borchardt to Luger

The evolution of automatic self-operating firearms was proceeding at a great pace around the end of the 1800s. Yet, with so many advances occurring, there were a small number of arms designers with a near monopoly on the field. Names like Paul Mauser, Hiram Maxim, Hugo Borchardt, Georg Luger, and the prolific John M. Browning dominated much of the work at the time.

With the exception of Browning, who was focusing on more mainstream sliding automatic pistol designs, the others all played a role in birthing, nurturing or motivating the novel toggle mechanism of the Luger.

By 1884, Maxim had proven the engineering reliability of a machine gun mechanism that pivoted two linked toggles upward where a pin connected the two links. This “toggle” mechanism became an inspiration to mechanical inventor Hugo Borchardt. Borchardt loved a challenge, and he felt challenged to prove that a reliable automatic pistol could be designed based on the toggle mechanism. He succeeded with the resulting landmark Model C93 pistol, better known as the Borchardt pistol.



The firm Ludwig Lowe began manufacture of the Borchardt design. Later Ludwig Lowe was part of a merger with DMK (Deutsche Metallpatronenfabrik of Karlsruhe), the resulting company known as DWM (Deutsche Waffen und Munitionsfabriken). However, the unwieldy C93 was quickly overshadowed by Mauser's



less clumsy C96 Broomhandle pistol. Apparently, Borchardt (thought to have been only a contractor to DWM, not an employee) felt that he had brought a toggle-action pistol to fruition, and that he had no ambition to make the design more practical for military use. For all practical purposes, Borchardt dropped off the map of small arms designers at this point. His watershed pistol ran most of the marathon, but he walked away before he crossed the final finish line.

Then enter Georg Luger. An employee of DWM, Herr Luger almost undoubtedly met, worked in proximity to, and was probably a protégé to, Herr Borchardt. Luger took the Borchardt design and improved on it with several modifications that made the toggle-action pistol easily held and used in one hand. Luger's first step in the evolution became known as the Borchardt/Luger transitional design. The name was well deserved since the pistol was a hybrid between the very long receiver of the Borchardt, and the curves of the future Luger. By 1898, the pistol's evolution had progressed to the point that it retained little resemblance with the Borchardt (apart from a toggle action), and was unmistakable as the grandfather of the Luger pistol as we know it.

Where Borchardt's ambition seems to have been merely to prove that he could bring a mechanical concept to reality, Luger had more of a mind toward military and commercial sales. He aggressively went about defending the commercial potential of a toggle-action pistol design. Luger's patent filings were lengthy, to defend all aspects of the pistol's design. Borchardt's name was not to be found in the patent filings. By 1900, the ground-breaking contributions of Maxim and Borchardt, were mere background noise to the much improved design which Georg Luger had produced for his employer DWM. However, there is little doubt, that while Georg Luger's accomplishments were monumental, he stood on the shoulders of several great predecessors to reach such heights.

In Search of a Buyer

From the start, Georg Luger had a military customer in mind for his new pistol. His vision was for an automatic pistol that would capture the attention of the military. To that end, he took part of a Latin phrase, “if one wants peace, one must prepare for war,” and named his creation, Pistol for War, or in combined German and Latin, Pistole Parabellum.

Luger's marketing genius in this regard equaled his genius in pistol design. In fact, what American collectors call the Luger pistol, is throughout the rest of the world known by the name Georg Luger himself gave

his revolutionary pistol: The Parabellum. Throughout this book, we'll use the vernacular name Luger or the military designation P.08. However, the names Parabellum or Pistole Parabellum would have a little more flair of originality to them.

With the patents in place for his design, and a solid relationship with DWM, Luger was able to put his attention to developing customers for his pistol. By 1899 the Swiss government was showing serious interest in his pistol. The 1899/1900 Swiss Test pistols were made for the Swiss military to test and evaluate. This successful courtship with the Swiss led to the successful marriage of the Luger pistol to a military customer, the offspring being the 1900 Swiss Military model. This began a long and beneficial relationship between Switzerland and the Luger pistol.

Concurrent with this, the family of 1900 commercial models (1900 Commercial, 1900 American Eagle, 1900 Swiss Commercial models) all began production.

During the next year, a number of trial submissions, and foreign contract models propagated as Luger and DWM got their name out in front of the world of sidearm consumers. A contract order from Bulgaria did not offset the lucrative opportunities lost to less than successful military trials by the US and Britain. Even winning the "home team" of the German army proved elusive in the first few years after 1900.

However, a piece of feedback from the failed US trails of 1900 proved to be the silver bullet (pun intended) for Herr Luger. The original 7.65 mm round was rightly perceived as underpowered for a military arm. Volume of fire from a semi-automatic pistol was not yet ready to overtake the reliable knockdown power of a larger caliber revolver.

This is where Georg Luger's combined engineering and marketing genius won the day. He set about creating a whole new round of ammunition made specifically for military use, which would be coupled with his Pistole Parabellum, which was made "For War". He hoped that the combination would silence all critics.

After internal trials in a number of prototype Luger pistols, the new round, the 9mm Parabellum, made its debut in 1902 with several new commercial models and a new US military trial model. While this did not help the Luger make any apparent headway with the US military, the more powerful new round, coupled with the innovative, reliable pistol design now had the attention of the German military.

As an aside, it also represented a Luger legacy that became more prolific and outlasted the glory days of his Parabellum pistol, the 9mm Parabellum cartridge.

The Parabellum Comes of Age

By 1904 the German military was looking seriously at the Luger pistol. While the army looked, analyzed and debated, it was the German Navy that first made the leap. The adoption of the 1904 Navy model was a watershed event. The Luger had been adopted by a



military branch of a top shelf European military power. Occasional reference can be found to a P.04 model Luger. This is the proper German military designation of military navy Luger models of 1904 and 1906.

By the end of 1906 DWM was making Luger pistols for Brazil, Bulgaria, the Netherlands, Portugal, and Russia. Follow-up orders were being filled for the German Navy and the Swiss military. Specific commercial models were addressing the American and French markets. A commercial look-alike of the military navy model appeared. Special presentation pieces were making rare appearances to thank those instrumental in getting this business, and to grease the wheels for future business.

By 1908 the German Army had stopped its kibitzing, and adopted the Luger pistol. Compared to anything previous, this was the big fish. It was the adoption of the 1908 Commercial, Military Contract model that gave the Parabellum its lasting military designation, P.08 (Pistole, Modell 1908).

45 Years at the Top

From its adoption, Georg Luger's Parabellum pistol was synonymous with the German military through the end of WWII. Even in the strictest accounting, the P.08 was without rival from its adoption in August of 1908 through the official adoption of its successor in 1938. Even then, manufacture of the Luger continued into 1942 for German Army and Police use, and into 1945 for Luftwaffe and post-war commercial sale. Ask any WWII ETO vet what THE most prized war souvenir was, and the answer will invariably come back, a Luger.

During that time, the Luger found favorable reviews (proven by its sales success) in America, Austria, Bolivia, Brazil, Bulgaria, Finland, France, German, Iran, Mexico, the Netherlands, Persia, Portugal, Russia, Siam, Sweden, Switzerland, and Turkey.

Although the technology of pistols eventually overtook the Luger design, and the cost in labor of machining such a precise firearm gave way to new designs, Georg Luger's invention contributed one of THE premier firearms, which reigned supreme for nearly 45 years as a sidearm. This author cannot foresee a time when it will not remain one of the premier firearms for collectibility and historical interest.

Luger Mechanics

The design and operation of the Luger pistol is innovative and elegant, even beautiful. In order to fully appreciate its beauty, the first thing one should know is how the Luger works.

The Luger's Design

There was only one major redesign of the Luger during its 45-year production life. Apart from that, only minor feature variations like the direction of the safety lever, whether or not it has a grip safety, whether or not it has a sear safety, whether or not it has a hold-open device, whether or not it has a stock lug, different barrel lengths, and different rear sights can be noted.

Early Design

The early Lugers include all 1900 and 1902 models. Within this design there are two patterns of features (see chapter 6 for details on the 1900 Pattern and the 1902 Pattern).

The early design is readily recognized by:

- The dished toggle knobs
- The toggle locking mechanism located in a slot cut in the right toggle knob
- The extractor has a flat top
- The trigger is comparatively narrow
- The trigger guard is the same width as the frame
- Internally, the main spring is a flat leaf spring

Within the early design there were subtle variations of frame (grip part) and receiver (slide part). There is a long type and a short type. Since most of us don't carry calipers with us at gun shows, two gospel rules will always keep you straight on this.

Rule # 1: The receiver and frame ALWAYS match in length. If one sticks out more than the other where they meet under barrel, something has been changed.

Rule # 2: The short variation has a flat part to the curve from the front of the trigger guard to the front of the frame. A long variation has a continuous curve, but no flat.

Late Design

The late-design Luger incorporates changes based on all test results from nations that evaluated the Luger from 1899 to 1903. The 1904 Navy model is transitional in that it has some design features from both the early- and the late-design.

The late design includes all 1906 and later models. Within this design there are several patterns of features

(see chapter 6 for details on the 1906 Pattern, 1908 Pattern, 1914 Pattern, 1929 Swiss Pattern, and the 1934 Pattern).

The late design is readily recognized by:

- The flat, checkered toggle knobs
- No toggle locking mechanism
- The extractor top has a slight curve to it
- The trigger is comparatively wider
- The trigger guard is cut to be narrower than the rest of the frame.
- Internally, the main spring is a wound coil spring.

Within the late design there is the same subtle long and short variations of frame (grip part) and receiver (slide part). The same two gospel rules apply to the late design.

Rule # 1: The receiver and frame ALWAYS match in length. If one sticks out more than the other where they meet under barrel, something has been changed.

Rule # 2: The short variation has a flat part to the curve from the front of the trigger guard to the front of the frame. A long variation has a continuous curve, but no flat.

The Luger's Feature Changes

Chapter 6 will focus on the GROUPING of features, which can be categorized as model year patterns. This section will focus on the features themselves, as well as cover the individual features that changed with the two design types. Some features are exclusive to only one of the two design types. Other features were employed with no such boundaries.

Toggle Lock

The toggle lock was a clever way to assure that the toggle joint between the front and rear toggle links did not hinge until the receiver and toggle assembly had traveled the proper distance to the rear.

Once that distance had been traversed, the lock (which hangs below the right toggle knob, is unlocked by hitting a lip on the right rear frame rail.

This is a feature found only on the early-design Lugers. The 1904 Navy is an interesting piece in this regard, because it has the slot cut, but in a late design FLAT toggle knob. Despite having the slot cut for it, this model does not actually have a toggle lock mechanism.

Safeties

Three of the four safeties that can be found on a Luger all work the same way, by disabling the sear.

It is easiest to understand this section by reading it with a Luger at hand. First, MAKE SURE THE PISTOL IS COMPLETELY UNLOADED. CHECK BOTH THE MAGAZINE AND THE CHAMBER. Now, look closely at the left side of the pistol above the magazine release button, below the front/rear toggle joint. If you pull the trigger you will notice a horizontal metal bar that hinges outward proportional to the trigger pull. This bar is the sear.

Thumb Safety

Now put the thumb safety on. You will notice that an angled piece of unfinished metal now blocks the movement of the sear we just observed. The sear can't operate, the trigger can't be pulled back, and the gun can't fire.

Every Luger has a thumb safety. There is also a variation to the thumb safety mechanism. Not a hard rule, but in general early design Lugers engaged the safety with the lever in the upper position. Generally late design Lugers engaged the safety with the lever in the lower position. There is also some commonality between safe in the upper position and the presence of a grip safety. The exceptions are too tricky to characterize other than on a model-by-model basis.

Grip Safety

The grip safety operates on the same angular bar as does the thumb safety, blocking the sear from operating when not depressed.

Most early design Lugers have a grip safety. Late design Lugers carried this feature through the 1908 Pattern models. After that, the grip safety only made a rare appearance.

Sear Safety

At some point, either something or someone caused concern that a Luger pistol could be fired while being disassembled. The resulting fix was called the Schywie Safety (presumably after the inventor). We call it the sear safety. This slick little addition required rework of the side plate and sear to fit in. Once in place, here is how it worked. The side plate held the sear safety out of the way, allowing free operation of the sear. However, when the side plate is removed for disassembly, a spring on the sear safety pushes a pin into a hole in the sear. This pin renders the sear immobile.

The sear safety could be found as a legitimate addition to almost any commercial or German military model Luger. However, the origins of this added device are with the German police. By the time Mauser took over DWM, the sear safety was found on most commercial and contract Mauser Banner models.

Magazine Safety

This safety did NOT work on the sear. This one worked by blocking the trigger from being pulled back directly. The safety was placed beneath the left grip, with a plunger extending into the magazine well, and a small wedge fit behind the trigger. Without a magazine in the

pistol, the wedge of the safety would prevent the trigger from being pulled back to the back of the trigger guard. However, inserting a magazine would push the plunger up, and pivot the safety so as to remove the wedge from the trigger's path.

Finding a Luger with the magazine safety is a hit-or-miss proposition on Lugers in the 1908 to 1920 commercial models.

Hold-Open Device

The hold-open device is a magazine spring-activated stop that holds the toggle back and the breech open when an empty magazine is in the pistol.

This device was standard on Lugers from the start. In 1908 military models this feature was removed for a short period of time, probably to speed along initial military production.

In May 1913 the German War Ministry ordered that the hold-open device would be instituted on all DWM and Erfurt military production. A program to retrofit existing P.08s with the hold-open device was also instituted at Erfurt.

Due to the war, not all imperial military Lugers made it back to Erfurt for the retrofit. Those that did will obviously have the hold-open device, but should also have a small proof mark added beneath the pin of the hold open lever.

Stock Lug

Words mean things. This rail on the backstrap of all Lugers (starting with the 1914 Pattern models) certainly started life appropriately named. From the earliest carbine models, to the stocked navy and artillery models, the lug certainly was there to accommodate a stock.

However, many people wonder why this feature is found on standard, non-stocked military Luger models right up through the end of WWII.

The answer is simple. In addition to being a convenient place to attach a stock to the pistol, it was also a convenient place to attach the pistol to a workbench. The fitting, finishing and assembly of a Luger pistol were facilitated by having the frame secured to a fixture which fit and attached just like a detachable shoulder stock.

The author has seen video footage of WWII Luger production utilizing this technique.

One might wonder how these steps were performed on Luger models that do not have a stock lug. Removing the grips and exposing the frame's skeleton will answer that question. There is a concealed mounting-lug hole inside the frame.

The Luger's Operation

First a loaded magazine is inserted up into the grip, until it "clicks" in place with the magazine catch. Then the pistol is charged by manually pulling the toggle knobs up and back, the pistol is cocked and the main spring is compressed.

Then releasing the toggle knobs will allow the mainspring to force the breechblock and toggle forward and down respectively. This will chamber a round and bring the firearm into battery. It is now loaded and ready to fire.

Upon firing, the recoil of the barrel and receiver forces the assembly rearward, but with the toggle still closed on the chamber and locked. After about a centimeter of rearward movement, the toggle knobs make contact with the curved rails on the rear of the frame. As the rearward motion of the barrel and receiver continues, the curve of these rails causes the toggle to unlock and the toggle joint to hinge upward.

With the toggle assembly now unlocked, it moves rearward within the receiver, extracting and ejecting the empty cartridge casing, and cocking the pistol in the process. The timing is such that the bolt link of the toggle assembly does not go out of battery until the bullet has exited the barrel, and the chamber pressure has dissipated.

Free of the force of chamber gases, and having absorbed the recoil energy, the main spring, which was compressed by the rearward travel of the barreled receiver and toggle, concludes the firing cycle. It forces the barreled receiver and toggle assembly forward. The toggle knobs follow the frame rails back down, hinging downward, back in line with the bore.

In the process of this spring-activated motion forward, the bolt section of the toggle assembly strips the top round forward and out of the magazine. The round is chambered as the toggle assembly relocks with the bolt section back in battery.

This process will repeat each time the trigger is pulled until the magazine is empty.

Some later model Lugers have a hold-open device which would lock the toggle back on an empty magazine.

A checkered push button on the left side of the frame will release the magazine for removal, ready to be replaced by a loaded one.

The safety on a Luger is an angled metal bar on the left side of the receiver which physically blocks the sear from operating. On all Luger models but one (the exception is the rare baby model, which employs a sliding button) this safety is activated by a lever, accessible by the right hand thumb when the Luger is grasped to fire.

On early models, this safety was also activated (deactivated would be more correct) by depressing a grip safety bar on the back grip strap.

Field Stripping the Luger

1. Make sure that the pistol is unloaded. Remove the magazine by pushing the magazine catch.
2. With the pistol in your right hand, place the muzzle against a hard, flat surface and push until the barrel/receiver assembly is all the way to the rear.
3. With your left hand, turn the takedown lever downward (clockwise).
4. Remove the side plate by pulling it toward the muzzle and outward.
5. Slide the barrel/receiver assembly forward and off the frame.
6. Push the pin connecting the toggle assembly and the receiver to the left and remove it.
7. Slide the toggle assembly rearward and out of the barreled receiver.

Luger Markings

Manufacturer's Marks

The first mark most people notice when looking at a Luger is the manufacturer's identification. This mark is stamped into the top of the forward toggle link.

This is a dependable rule, with only two types of exceptions.

The first, most common type of exception is an unmarked toggle. These exceptions are:

1. The 1899/1900 Swiss Test Model
2. The 1925/1926 Baby Models
3. DWM Factory Sneaks
4. The Simson Rework, Unmarked Model
5. The Mauser Rework, Unmarked Model
6. The Krieghoff Post-War Unmarked Models

The second is the 1908 Bulgarian model, which has the Bulgarian national crest on the toggle, and the maker's mark atop the chamber.

The inscription was always blued after it was stamped, never stamped after bluing or left "in the white". Sometimes collectors will fill in the inscription with white paint or crayon to aid in photographing the Luger.

Lugers made prior to the Nazi era in 1933 have the manufacturer's logo, initials or name as the identification. Following 1933, all commercial, foreign contract, Luftwaffe and police Lugers continued to carry the undisguised manufacturer's logo as the identification. Nazi-era German Army Lugers have a series of manufacturer codes (fertigungskennzeichen) intended to disguise who the manufacturer was.





The manufacturer's marks that can be found on Lugers are reproduced in table 3.1.

Date Marks and Other Chamber Marks

There are three categories of marks that can be found on the top of a Luger's chamber.

First, and most common, is a date. The date will sometimes be a two-digit, but usually a four-digit year. In 1934 and 1935 the date was coded as a single letter. The German Army prior to WWI mandated chamber dates. This requirement continued through the end of WWII. It is the rare occasion that chamber dates will appear on commercial or contract models.

The second form of chamber mark is a national crest. There are several of these found throughout Luger production. The American Eagle, Bulgarian, Portuguese, Russian, and Swiss crests are examples of this type of chamber mark. Sometimes this was for purely consumer

Deutsche Waffen und Munitionsfabriken	
Erfurt Arsenal	
Waffenfabrik Bern	
Vickers	VICKERS LTD.
Simson	Simson and Co. Suhl
Mauser Werke	
Mauser	42
Military	S/42
Codes	byf
Krieghoff and Sohn	

appeal (like with the American Eagle, and the Swiss commercial models). On contract models this was to cater to the requirements of the contracting nation.

The third, and most rare, category of Luger chamber marks is initials. Pre-WWI presentation models had the intertwined script initials of the intended recipient (sometimes with gold inlay).

Except for the gold inlay initials, chamber dates and crests were always blued after being stamped, never stamped after bluing or left "in the white". As with toggle marks, collectors sometimes fill these in with white paint to aid in contrast for photographing.

Proof and Acceptance Marks

Luger experts have traveled the world over to research this firearm, yet some variations remain undocumented, or at the very best under documented.

Since all Lugers look pretty much alike, it is necessary to learn and recognize proof marks to aid in differentiating otherwise similar models. Also, when a model was made for both military and commercial sales, the proofs tell which one it is. The bad part about proof marks being the difference between common and rare Lugers is the temptation to counterfeiters. If you are contemplating buying a rare or expensive Luger, do your research first. It will save you much heartache.

German military collectors (this author included) often lump both acceptance marks and true proof marks under the generic category called proof marks. However, there is a difference that is important to understand.

Acceptance Marks

Acceptance marks were placed on major components and on the pistol as a whole to indicate inspection and acceptance. They are only found on German military Lugers, not on contract or commercial Lugers. Following are examples of the more commonly encountered acceptance marks. The acceptance marks found on each individual model and variation are shown in chapter 7.



**Imperial Navy
Acceptance Mark**

The crown/M acceptance mark is the highly desired indication of an Imperial Navy P.08.



**WWI Army
Acceptance Mark**

This inspection/acceptance mark is found only on the first military contract model P.08.



**WWI Army
Acceptance Mark**

This inspection/acceptance mark is found only on the 1908 undated military model P.08.



**WWI DWM
Acceptance mark**

This inspection/acceptance mark is found on dated 1908-pattern DWM military model P.08s.



**Late DWM
Acceptance Mark**

This inspection/acceptance mark is found on dated 1914-pattern DWM military model P.08s.



**Early Erfurt
Acceptance Mark**

This inspection/acceptance mark is found on 1908-pattern Erfurt military model P.08s.



**Late Erfurt
Acceptance Mark**

This inspection/acceptance mark is found on Erfurt 1914-pattern and artillery model P.08s.



**Simson
Acceptance Mark**

This inspection/acceptance mark is found only on Simson Weimar-era P.08s.



Nazi Police Acceptance Marks

These inspection/acceptance marks are found on Nazi era P.08s procured for police forces. Theories vary regarding the meaning of the letters accompanying the E/swastika. Regional police offices where the pistols were delivered, and types of police forces are the two most common.



Luftwaffe Inspection Marks

The preceding marks represent the marks found to denote passing inspection LWaA inspectors.

Proof Marks

A big fear during the late 19th Century was that someone would accidentally confuse ammunition using modern smokeless (nitrocellulose based) gunpowder for older black powder ammunition. As a result, Germany (for one) had a law dating from the early 1890s that mandated that specific marks be displayed as "proof" that a firearm was capable of handling the higher pressure of the new technology. The same legal overkill of today that requires ladders to have a sticker saying "this device is not for suppository use" and causes bubble wrap to state "not a significant source of protein," was prevalent at the turn of last century.

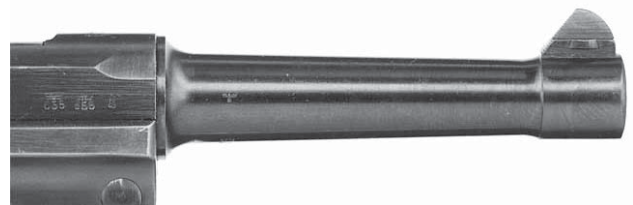

The difference between a proof mark and an inspection or acceptance mark is shown on the photo above. The Eagle/655 (two of them actually) signifies the inspection of the receiver (left most) and the acceptance of the whole firearm (in the middle). The Eagle/Swastika (right most mark on the receiver and on the barrel) signifies the successful test firing of the firearm.

All commercial Luger models will have a commercial test fire proof. The most common examples are shown below.



The BUG Proof

Some combination of this set of marks was used on commercial Luger production starting in 1900 and proceeding through the 1906 pattern guns. The crown/B and crown/U indicated the actual proof, while the crown/G is thought to indicate a rifled barrel. Later the crown/G was dropped, with the other two marks being applied sideways.



The NITRO Proof

This mark is the most common proof mark found on Lugers. It is found on Lugers starting in 1906 up until Mauser took over Luger production in the late 1920s. The “nitro” comes from the chemical composition of the newer gunpowder, which was nitrocellulose based.



The Mauser Proof

Mauser used a crown/U to proof mark P.08s they made. It is found as early as the DWM/Mauser transitional guns, and was used up until the Nazi law that changed the mark to an eagle/N in April 1940.



The Nazi Commercial Proof

Hitler, National Socialist that he was, mandated the replacement of the former crown-over-letter to eagle-over-letter proof marking. It will be found on Mauser commercial and police P.08s from its introduction in April 1940 through the end of the war.

Many contract Luger models will have the same commercial proof in addition to a combined proof/acceptance mark specific to the purchasing nation. These marks were usually specific to the contracting nation.

All German military models will have a military test fire proof, usually stamped next to the inspection and acceptance marks. Commonly encountered examples are shown below.



The Imperial Navy Proof

The Imperial German Navy appears to have marked their P.08s in the opposite direction (from front to back) from the German Army. The mark actually indicating test proof appears last (to the left of the inspection/acceptance marks). This mark was used from the first 1904 through the 1920 Commercial Navy models (which used spare military parts).



The Imperial Army Proof

This mark is found on both the barrel and receiver of most all WWI and earlier German Army P.08s. This is true of DWM and Erfurt made guns.



The Breechblock Proof

This mark is found on both the breechblock of most all WWI and earlier German Army P.08s.



The Simson Proof

This proof mark is found only on Simson Weimar era P.08s.



Krieghoff Test Proof

This proof mark will be found on all Nazi era Krieghoff made P.08s. This applies to both commercial and military pistols, since all Krieghoff components were made with a military customer in mind.



Early Nazi Military Proof

With the decline of Jewish-run Simson, Mauser took over the role of P.08 maker for the German military. This proof mark was the first variation found on early Nazi era military firearms. It can be found in use from 1933 to mid 1936.



Mid Nazi Military Proof

This is the second variation of Nazi era military proof mark. It can be found in use from 1936 to mid-1939.



Late Nazi Military Proof

This is the final Nazi era military test-fire proof mark. It is found from mid 1939 through the end of the war.

The acceptance and proof marks were always stamped before the pistol was blued, never stamped after bluing or left "in the white." When we see Lugers with white filled marks, that is simply something done by collectors to make the marks easier to read.

Unit Markings

On January 28, 1909 the Prussian Army issued publication number 185. This booklet covered the regulations for unit marking small arms. In 1910 the Bavarian military issued Instruction No. 448 to cover the same topic.

With the approach and then start of WWI, the various constituent forces of the German Army issued new, simplified regulations regarding unit marking.

Then around 1920, following the Versailles Treaty when the distinction between army and police became blurred, police unit marks emerged in both Bavaria and Prussia.

In addition, Imperial German Navy and Weimar era Reichswehr (military) specific unit marks had their own flavors.

To exhaust the topic of Imperial and Weimar unit marks is beyond the scope of this book. The intent here is to give the reader a reasonably thorough introduction and overview to the topic. For those interested in delving further, I recommend the excellent work on the subject by Görtz and Bryans.

Prussian 1909 Unit Marking Instruction

Specific instructions for unit marking the Pistole 08 were as follows:

- 4.2 mm Roman numeral dies were to be used to identify the higher command (i.e. corps, army, or army group)
- 4.2 mm letter dies were to be used to identify the Landwehr district (when appropriate) and unit type.
- 3.1 mm Arabic numeral dies were to be used to identify the unit number.

- 2.1 mm Arabic numeral dies were to be used to identify the weapon number within the unit

The unit mark was to be placed on the front strap starting at the bottom. Let's look at an example:

51.K.6.49

The first portion (in this case 51) stands for the unit (in this case regiment) number. So we have the 51st Regiment. The second portion (in this case a K) stands for type of unit (in this case a cavalry unit). So we have the 51st Cavalry Regiment. The third portion is the lower level unit number (battery, company, squadron, etc.). So we have the 51st Cavalry Regiment, 6th Company. The last portion is the weapon number within that unit. So this marking would appear on sidearm 49 of the 6th Company, 51st Cavalry Regiment. In addition, when a unit was not a Prussian unit, the regiment number would be preceded with a letter for the country.

Landwehr Unit Marking Abbreviations

- A. Anstalt, Augsburg
- Am. Amberg
- An. Ansbach
- As. Aschaffenburg
- B. Bayrisch, Bayreuth
- Ch. Chevaulegers Regiment
- D. Dillingen
- De. Deggendorf
- E. Erlangen
- G. Garde, Gendarmerie
- H. Hilfs
- ℌ. Hartschiere
- I. Ingolstadt
- K. Kempten
- Ka. Kaiserslautern
- Ks. Kissingen
- Kz. Kitzingen
- L. Landau, Lastkraftwagenpark, Leibregiment
- Lh. Landshut
- Lhn. Ludwigshafen
- M. Militaerschiessschule, München
- Mi. Mindelheim
- N. Nürnberg
- Ne. Neustade a.H.
- P. Passau
- R. Regensburg
- ℔. Reiter-Regiment, Militar-Reitschule
- S. Straubing
- St. Straf
- W. Würzburg
- Wa. Wasserburg
- Wd. Weiden
- We. Weilheim
- Z. Zweibrücken

Unit Type Marking Abbreviations

<u>A.</u>	<i>Feldartillerie</i> – Field Artillery
<u>A.F.</u>	<i>Fussartillerie</i> – Foot Artillery
A.	<i>Abteilung</i> – Unit
B.A.	<i>Bekleidungsamt des Armeekorps</i> – Army Corps Clothing Depot
<u>Ch.</u>	<i>Chevaulegers</i> – Bavarian light cavalry unit
<u>D.</u>	<i>Dragoner</i> – Cavalry
<u>E.</u>	<i>Eisenbahn Regiment</i> – Railroad Regiment
E.	<i>Erzatz</i> – Replacement or Substitute
<u>F.</u>	<i>Fuss</i> – Foot
F.A.	<i>Flieger-Abteilung</i> – Air Detachment
<u>G.</u>	<i>Garde</i> – Guard
G.G.	<i>Garde Grenadier</i> – Guard Grenadier
G.G.R	<i>Garde Grenadier Regiment</i> – Guard Grenadier Regiment
G.R.	<i>Grenadier Regiment</i>
<u>H.</u>	<i>Husar</i> – Hussars, cavalry
<u>I.</u>	<i>Infanterie</i> – Infantry
J.	<i>Jäger</i> – Rifle
J.M.G.	<i>Maschinengewehr Kompanie des Jäger Battallions</i> – Machine Gun Company of a Rifle Battalion
<u>K.</u>	<i>Kavallerie</i> – Cavalry
K.	<i>Kürassier</i> – Cavalry
<u>K.</u>	<i>Küsten</i> – Moerser – Coastal Howitzer
K.	<i>Kommando</i> – Command
l.	<i>leichte</i> – light
L.	<i>Landwehr</i> – Substitute reserves
L.	<i>Lazarett</i> – Hospital
L.	<i>Luftschiffer</i> – Airship/Ballon Personnel
M.	Munitions
<u>M.G.</u>	<i>Maschinengewehr</i> – Machine Gun
P.	<i>Pionier</i> – Combat Engineer
<u>R.</u>	<i>Infanterie Regiment</i> – Infantry Regiment
<u>R.</u>	<i>Reserve Infanterie Regiment</i> – Reserve Infantry Regiment
R.	<i>Reserve Reiter Regiment</i> – Reserve Cavalry Regiment
S.	<i>Feldsignal</i> – Field Signals
S.	<i>Sanitaets</i> – Medical
s.	<i>schwer</i> – heavy
<u>T.</u>	Supply
T.	Telegraph
<u>U.</u>	<i>Ulanen</i> – Lancers, cavalry

Imperial Naval Unit Markings

Unlike the Prussian Army regulation that required the unit mark to be placed on the front strap of the pistol grip, Imperial Navy Lugers are unit marked on the back strap of the grip just above the stock lug.

Naval Unit Marking Abbreviations

W.K.	Werft zu Kiel - Dockyard at Kiel
------	----------------------------------

W.W.	Werft zu Wilhelmshaven - Dockyard at Wilhelmshaven
I M.D.	Erste Matrosen Division - 1st Sailor Division
II M.D.	Zweite Matrosen Division – 2nd Sailor Division
I W.D.	Erste Werft Division – 1st Dockyard Division
II W.D.	Zweite Werft Division – 2nd Dockyard Division
I T.D.	Erste Torpedo Division – 2nd Dockyard Division
II T.D.	Zweite Torpedo Division – 3rd Dockyard Division
I S.B.	Erste Seebataillon – 1st Marine Infantry Battalion
II S.B.	Zweites Seebataillon – 2nd Marine Infantry Battalion
III S.B.	Drittes Seebataillon 3rd Marine Infantry Battalion
GOUV	Gouvernement Kiautschou - KIAU Government of Kiaochow (the German concession in China)
M.A.A.	Matrosen-artillery Abteilung – Naval Artillery Section
U.A.	Unterseeboots-Abteilung Submarine Division, Kiel
M.A. or M.a.	Meaning unknown.
	Other unidentified naval unit marks are documented.

Weimar Reichswehr Unit Markings

The Reichswehr (Weimar-era German army) employed both reused and newly manufactured Lugers. Their unit marks were generally followed the Imperial-era guidelines, but would precede the high-level unit marking (typically the Regiment) with the lower level unit (typically the battalion, battery or company) designation.

Following is a list of specifically approved traditional (Imperial) unit designations that could be used after WWI.

Weimar Era Unit Marking Abbreviations

Gr.Kdo.1	Gruppenkommando 1
W.K.II	Wehrkreiskommando II
1. Div.	1. Division
1.K.D.	1. Kavallerie Division
Inf.F.I.	Infanterieführer der 1. Division
Art.F.I.	Artillerieführer der 1. Division
I.R.1	1st (Prussian) Infantry Regiment (hereafter abbreviated 1st Reg.)
I./I.R.1.	1st Battalion, 1st Infantry Regiment
1./I.R.1	1st Company, 1st Infantry Regiment
4./I.R.1	4th MG Company, 1st Infantry Reg.

M.W./I.R.	1st Minenwerfer Company, 1st Reg.
A.I.R.1	Ausbildungs Battalion, 1st Reg.
R.R.1	1st (Prussian) Reiter Regiment
1./R.R.1	1st Squadron, 1st Reiter Regiment
A./R.R.1	Ausbildungs Squadron, 1st Reiter Reg.
A.R.3	3rd (Prussian) Artillery Regiment
I./A.R.3	1st Abteilung, 3rd Artillery Regiment
1./A.R.3	1st Battery, 3rd Artillery Regiment
9.(Kw.)/A.R.3	9th Kraftwagen Battery 3rd Artillery Regiment
A./A.R.3	Ausbildungs Battery 3, 3rd Art. Reg.
IV.(r.)/A.R.3	4th Reitende Abteilung, 3rd Artillery Regiment
11.(r.)/A.R.3	11th Reitende Battery, 3rd Artillery Regiment
6.(Geb.)/A.R.7	6th (Mountain) Battery, 7th Artillery Regiment
Pi.B.1	1st (Prussian) Pioneer Battalion
1./Pi.1	1st Company, 1st Pioneer Battalion
N.A.1	1st (Prussian) Nachrichten Abteilung
1./N.1	1st Company, 1st Nachrichten Abteilung
K.A.1	1st (Prussian) Kraftfahr Abteilung
1./K.1	1st Company, 1st Kraftfahr Abteilung
F.A.7	7th (Bavarian) Fahr Abteilung
4.(Geb.)/F.7	4th (Mountain) Squadron, 7th Fahr Abteilung

When an Imperial-era unit mark was present on a reused Luger, the original unit mark will be "X"ed out and the new unit mark will be placed above or below in on the now crowded front grip strap.

Police Unit Marks

Consistent with the fuzzy line between German police and army forces, Weimar-era police unit markings appear much like Reichswehr military unit markings. They will be on the front strap of the pistol grip, written up from the bottom.

One thing that will help distinguish police unit marks is that they almost always begin with one of three-letter codes. S.something. was used to designate district or regional municipal police forces. P.something. was used to designate police schools. L.something. was used to designate rural police districts. H.something carries a meaning that is as yet only speculated.

Unique Unit Marks

R.G. Inscription

A variation of the 1914 Commercial model will have a side frame inscription of R.G. followed by a number. The R.G. stands for the Reichs-Gendarmerie, a paramilitary police brigade in the Alsace-Lorraine area. The pistols were consecutively numbered.

The Alsace-Lorraine region had long been a sore point between Germany and France regarding control. The Versailles Treaty removed this area from German control and returned it to France, which had lost it in the Franco-Prussian War. With the loss of the region the Reichs-Gendarmerie was disbanded.

EWB Stamp

In post-WWI Germany there was extreme political unrest. Countless paramilitary groups sprung up to join the chaos. Some were no more than brute squads. One, the Einwohnerwehr (Citizens Defense Force) was actually created by the Interior Ministry to help keep order. The more patriotic members of this group stamped or even carved the initials EWB into the grips and stocks of their firearms. Luger pistols are known to evidence this mark.

Dutch Unit Markings

Dutch army Lugers usually have a brass plate soldered to the left side of the frame that is marked with the unit. In many cases, these have been removed or worn off over time. In the rare case where a Dutch army model Luger has never had such a plate attached, the pistol in question was likely issued to an officer. For anyone interested in delving deeper into Dutch unit markings, I highly recommend the excellent work on Dutch Lugers by Martens and de Vries.

Some Dutch Navy Lugers have a K.M. unit mark stamped on the front strap of the grip. This seems to be the only type of unit mark on Dutch Navy Lugers.

Serial Numbering

An understanding of serial numbering on Lugers requires a classification on serial number sequencing, and of number placement.

Sequencing

Serial numbers were sequenced in one of three ways. Commercial style numbers started at 1 and simply counted up from there. Many commercial models that were contemporaries to each other share the same serial number sequence block (e.g., all of the commercial 1900 models). This style of numbering gets its name from that fact that most (but not all) commercial model Lugers are numbered according to this sequence. Krieghoff Lugers (both Luftwaffe and commercial) follow a commercial serial number sequencing.



A second style of serial number sequencing is that of contract serial numbers. In the case of contract models, the serial numbers were usually sequenced as its own block starting from 1 and counting up from there. In other words, there were many serial number 1 Lugers. At least one for each contract model, and for the beginning of the commercial number sequence.

The third style of serial number sequencing is the military style. From the beginning of German military Luger models in 1904 through the last byf 42, military Lugers were serial number sequenced as follows: starting at serial number 1 the numbers counted up to 10000, and then they started over at 1 with a letter "a" suffix. From 1a the sequence counted up to 10000 and then started over with a "b" suffix. In this way, each block (no letter, the "a" block, the "b" block, etc.) contains 10,000 Lugers. Contrary to popular myth, the numbering did not roll over at 9999, with a four-digit limit. There are enough examples of P.08s and P.38s (which used the same numbering scheme) with serial number 10000 to substantiate that it was 10000 pistols per suffix, not just 9999. Regardless, this numbering style gets its name from the fact that military model Lugers are numbered according to this sequence. Krieghoff P.08s are an exception to this.

Oddly enough, some commercial models are also numbered in this military style. Specifically, once Mauser acquired DWM and exhausted all the DWM parts, the various Mauser-banner commercial models have serial numbers in the v block and w block. It is also common to find letter-block serial numbers on 1920 Commercial model Lugers. This is indicative of parts and whole pistols left over from military production.

One could always argue that prototype and presentation serial number sequencing both represent additional styles of serial numbering.

Placement

There are two main styles of serial number placement on Lugers.

First is commercial placement. This style is found on most contract, navy and commercial model Lugers. Commercial serial number placement will have the full serial number on the bottom of the barrel, again right below it on the front of the frame, and on the left side of the receiver. In addition, the last two digits of the serial number will be found on the breechblock (lower left side), front toggle link (bottom), rear toggle link (back), side plate (bottom edge), takedown lever (bottom), trigger (top left), grip safety (under grip) and grips (inside). The two digits were placed so as to detract as little as possible from the exterior appearance of the pistol.

The second style of serial number placement is the military style. This style is found on all WWI, Weimar and WWII era German army Lugers. Like the commercial style serial number placement method, military serial number placement will show the full serial number on the bottom of the barrel, the front of the frame, and

left side of the receiver. The last two digits of the serial number are on the breechblock, extractor, front toggle link, rear toggle link, sear bar, side plate, takedown lever, thumb safety lever, trigger, and grips (inside).

The main difference from commercial number placement is that the two digits found on the small parts are not hidden. They are prominently placed in the middle of otherwise perfect part surfaces. The military did not care about appearance and this sped up production.

A common feature that is inconsistently applied to both commercial and military models is that the toggle link pin will occasionally be stamped with the last two digits of the serial number.

Safety Marking

The German habit on Lugers was to mark the safety such that the marking showed when the lever was in the safe position. This is true of early safeties that have a rounded rectangular area polished bright white steel (not blued), and of the later German standard safety marking "GESICHERT" (meaning SAFE).



This carried over to many foreign contract and commercial models like the American Eagles.

Some foreign models were marked to indicate the safe position in the intended native language. Examples include "SEGURANCA" on the Portuguese GNR, "emniyet" on the Turkish models, "S" on Swiss made models, and "SAFE" on some models sold in the US. The safe position on Persian models is marked in Farsi.

However, some foreign contract models were marked to indicate the ready-to-fire position. The Bulgarian and Russian models are examples of this, with the marking in Cyrillic lettering.

The German Luftwaffe trialed experimental safety configurations on Krieghoff-made Lugers. At least one is noted marked FEUER (German for fire).



Different from all these were the various Dutch Lugers. These were idiot-proof with the Dutch word for SAFE (RUST) and an arrow pointing in the appropriate direction.

The safety is the one mark that was usually filled in with white pigment in order for it to stand out.

Finally, there were a few models (test, trial and presentation grade carbines) noted with no safety marking at all.

Side Inscriptions

There are a small number of models noted for possessing personalized or company inscriptions on the left side of the frame.

These were usually added after the Luger was blued, meaning they should appear in the white, not blued over.

OTHER MARKS

Lugers originally sold commercially in the US were stamped similar to the photo below.

The series "Band of Brothers" has a scene with a US paratrooper admiring the Luger souvenir of British



Tommy. Well, a Luger in British hands would have been marked like the photo below before it would have been released for private ownership.



The author has seen photos of a P.08 with five- and six-pedal clover-leaf stamps. Another Luger is reported with the word "Freise" marked on the side of the receiver. What do these marks mean? We don't know. Examples like these abound.

Chapter 4

Lugers by Era and User

This section is to give the reader just enough historical context to be able to “speak” Luger.

Three Different Germanys

From before the 20th Century through mid-1945, Germany saw three vastly different types of government. Each government avoided, sought, or engaged in war in its own way. These three forms of government represent three eras of German history that help categorize the Luger pistol. There are some commercial and contract Luger models that have nothing to do with German politics. However, they were still made, marked and marketed within the context, laws and circumstances of Germany and her politics.

Imperial Era

From 1871 when Otto von Bismarck declared the foundation of the empire of Germany from the halls of the Versailles Palace at the conclusion of the Franco-Prussian War, Germany was governed as a monarchy. The Kaiser was the German name for the reigning monarch. From the Luger’s initial appearance in 1899 through the end of WWI, the Kaiser was Wilhelm II. The Imperial era ended with Kaiser Wilhelm’s abdication on November 9, 1918. Lugers produced during this roughly 20 years are generically characterized as Imperial Era Lugers.

Actually, many of the Lugers made during the imperial era have absolutely nothing to do with the Kaiser’s empire. The many commercial models would display, at most, proof and acceptance marks in accordance with imperial law for any firearm using modern smokeless (nitrocellulose based) gunpowder. The several foreign (to Germany) contract models made during these years usually exhibit no evidence whatsoever (besides their features) that they trace their origin to this era.

Weimar Era

The terms that ended WWI were dictated to (certainly not negotiated with) Germany in a document known as the Treaty of Versailles. Among the outcomes sought by the Big Four (remember them from high school history class? US President Wilson, England’s Prime Minister Lloyd George, Italy’s Orlando, and Clemenceau of France) at Versailles was to create a German democracy which they hoped would prevent a future belligerent Germany.

The result was a new German constitution written in the city of Weimar Germany. This Weimar Constitution,

and the representative government it established would govern Germany from 1919, through the passing of the Enabling Acts by the German parliament (the Reichstag) in 1933. Lugers produced during this roughly 14 years are generically characterized as Weimar Era Lugers.

Ironically, despite his failed uprising in 1924, Adolf Hitler used legal means within the Weimar constitution to maneuver himself into the Chancellorship by 1933.

Nazi Era

With a heavy hand applied to the Reichstag members elected from the rival Communist party, and the torching of the Reichstag building itself (blamed on a retarded Dutchman with “communist” links), Hitler persuaded the Reichstag to grant him “temporary” extraordinary powers to deal with the powder keg social situation. Once granted, Hitler was able to manipulate the strings of authority more and more in his favor until Germany became a fully Nazi state under his dictatorship.

Lugers produced during this roughly 12 years are generically characterized as Nazi Era Lugers.

Links Between The Eras

Despite the sharp distinction between the German governments of these three eras, there are “Luger Links” between each era.

The over abundance of Imperial era military Luger pistols led to a huge rework/reissue program for the Versailles-limited Weimar police/military force. This was all done under the control of an Allied commission.

This close scrutiny was still not enough to prevent an active clandestine arms build-up by proud German military leaders. This fledgling remilitarization became the seedlings for a vast crop of new weapons, just ripening on the vine for Hitler and the Nazis to pluck and feed to the Wehrmacht.

The Value Of Knowing History

What would you think if you found a G Date Luger with British BNP proofs? Or a Dutch Luger brought back from the Pacific by a US Marine, far from any German? A couple months prior to this writing, the author has a chance to personally inspect a Luger with WWI German Navy proofs, police unit markings on the front strap, AND early Nazi acceptance marks. Did the pistol have providence, or did the fakers go too far in putting together a Luger with a fantastic story to tell? A solid comfort with history allows a collector to approach a find (or fake) like that with increased confidence.

At the risk of repeating part of Chapter 3, this section is to give the reader a perspective on the intended user community of categories of Lugers.

Commercial

Commercial Lugers own both ends of the rarity and value scale for production models. Commercial Lugers were exactly what the name implies. They were made as commercial guns, for commercial sales, to consumers for retail consumption. They existed in all three eras, although the commercial market within Germany during the Nazi era was really that of military officers, para-military members, and those with Nazi party connections.

Proof Marks

Commercial-type proof marking is the best way to tell commercial model Lugers. These commercial proof marks were required by German law to show that the firearm is capable of using modern smokeless powder.

Pre-1906 commercial model Lugers will have what is known as the BUG commercial proof. It consisted of a Crown over B, Crown over U, Crown over G, often side by side looking like the word BUG in all caps, with each letter surmounted by a crown. Sometimes the Crown/B and Crown/U will appear sideways without an accompanying Crown/G. Either configuration denotes a commercial piece.

By 1906 a more standard mark, Crown/N replaced the BUGs. The Crown/N remained the standard commercial proof until April 1940.

Mauser instituted an acceptable substitute commercial proof mark. Sometimes referred to as the Mauser Oberndorf proof, it was a Crown/U. This mark is only found on arms made by Mauser at its main plant at Oberndorf.

Hitler and the Nazi movement were by definition, anti-monarchy. One result was that in 1940 German law changed to replace any and all crown/whatever commercial proofs with an Eagle over N. This style of commercial proof mark lasted until the end of WWII.

Serial Numbers and Serial Number Placement

This method of identifying and characterizing Lugers is only a secondary one. Proof marks remain the primary method. Changes in serial numbering during the 45 years of Luger production, many exceptions, overlaps and repetition in numbers make identification by serial numbering tricky (but still possible).

Serial numbers for commercial Lugers will not usually be letter suffixed (see the Military section below for a complete description). They will run sequentially in production, up into six-digit numbers. The full serial number will appear across the bottom of the barrel and on the front of the frame. In later models, from about 1934 on, the full number will also be stamped on the left side of the receiver just back of the barrel. Commercial Lugers do not have serial numbers on the magazines.

The main exception to the serial numbering sequence and placement is the post-WWI 1920

Commercial model. This model was a clearinghouse to get some money in the door, while using up a ready supply of parts and assembled pistols sitting in DWM and Erfurt inventory. Many of these Lugers will display military-style serial numbering, as well as military serial number placement. Lugers dating from 1914 through 1919 with military marks AND commercial marks are probably 1920 Commercial models converted to commercial sale from military inventory after the war.

In any other case this author can think of, a mix of commercial and military marks on a Luger indicates a gun that started life as a commercial model, and then got converted to military use.

Contract

In the context of Luger collecting, contract means foreign government contract. When the military or police of any non-German government purchased Lugers, they were under the terms of a specific contract. These models will often have extractor and/or thumb safety marks in the language of the purchasing nation (e.g., Brazilian, Dutch, Persian, and Russian to name but a few). Frequently contract Lugers will bear some sort of national symbol from the purchasing nation (examples include Bulgarian, Portuguese, Swiss, and Turkish contract models).

Proof Marks

Since Lugers of this category were for neither German military use, nor for commercial sales, (and therefore not subject to commercial proof mark laws) they were usually marked in whatever manner and with whatever marks the purchasing nation desired. Portuguese Lugers have the mark for Portuguese royalty. Russian Lugers have the arsenal mark for the Russian arsenal at Tula. Swiss Lugers are marked with a Swiss cross. And so it goes.

Serial Numbers and Serial Number Placement

The serial numbers on contract Lugers will be in specific contract number blocks. These serial numbers could easily duplicate the same numbers from standard commercial production, early military production, and even from contract to contract. They will not be letter suffixed. In some cases (a couple Swiss models) the serial number will be prefixed with a letter. They will run sequentially for each contract model in production, up into 4 or sometimes 5 digit numbers. The full serial number will appear across the bottom of the barrel and on the front of the frame. In later models, from about 1934 on, the full number will also be stamped on the left side of the receiver just back of the barrel. Contract Lugers do not have serial numbers on the small parts or the magazines.

Military

In the context of Luger collecting, military means German military. Foreign military (including any German allies from either world war) would fall into

the previously discussion contract category. Regardless of the military branch concerned (Army, Navy or Air Forces), military Lugers are the most popular area of Luger collecting.

Through the end of WWI, German Navy Lugers were easy to distinguish due to the 6-inch barrel and compact adjustable rear sight. Between the wars, there was such a severe size restriction placed on German naval forces (they were limited to river and coastal patrol), that no new Lugers would have been needed. The good old left over WWI inventory sufficed. I would be skeptical of a navy marked Simson (Weimar era) Luger. By the time the Kriegsmarine rearmed for WWII, it no longer had its own naval style of P.08. Instead it issued standard-featured Lugers with special fleet inventory marks.

It is safe to assume that Lugers carried by WWI German pilots would have been unit marked for flieger (or flying) units. Between the wars, Germany was forbidden to have any air forces, so there is no such thing as a Weimar-era air services Luger. By WWII, not only did the Luftwaffe exist as an independent branch of the military, it had secured a sole-source contract with a manufacturer which had not previously made Luger pistols.

As neat as navy- and air force-marked Lugers are, the majority of military P.08s were army guns. The WWI or imperial P.08s were carried by various infantry, cavalry, and other ground forces. Following the German defeat in WWI, the Weimar era saw a smaller military force known as the Reichswehr. In order to control arms production, the IMKK directed all Luger production to be by one, well-monitored maker. Despite this, during the Weimar era, secret illegal rearming took place, with variations like the Luger sneak. This secret rearming became a useful inheritance to Hitler and the Nazis. After less than a year in power, he secretly moved military Luger production to a manufacturer outside of watchful eyes. By 1936, military P.08 production for the new Wehrmacht was being done out in the open. The P.08 remained THE German military sidearm until the introduction of the P.38. Even then, the P.08 remained in army use through the end of the war.

Chamber Dates

Almost all German military P.08s have a two- or four-digit year date stamped atop the chamber. In a few cases the date was coded as a single letter stamped atop the chamber. Some commercial models also have a dated chamber, so don't use just this feature to distinguish commercial from military Lugers.

Proof Marks

A military Luger can be determined as such by the acceptance and proof marks. This is a gospel rule. The German military was fastidious regarding these marks. In fact, if a collector goes by purely physical features, a complete Luger collection would consist of about 15 pieces. It is exactly the little marks (makers, dates, proofs, language marks, chamber crests) which make the difference between a \$500 Luger and a \$50,000 one. The model-by-model pages in Chapter 7 is where this

detail is provided. At a high level, there are WWI DWM type marks, WWI Erfurt type marks, WWI Navy type marks, Weimar Simson type marks, late Weimar/early Nazi type marks, and Nazi era type marks.

Serial Numbers and Serial Number Placement

The serial numbers on military Lugers are different than commercial and contract style number sequencing. In order to disguise production levels, German military serial numbers start a 1 and proceed to 1000 a. They then start over at 1 with a letter "a" suffix. After 10000 a, the next serial number in the sequence is 1 b. This allowed for 270,000 numbers before a repeat. Since German military inventory control of firearms also included the maker code and year, there would never be a duplication of the FULL identification of a specific P.08.

Police

In the context of Luger collecting, police means German civil police and paramilitary. As the Versailles Treaty emasculated the German military, it left a national armed force barely adequate for border patrol, law enforcement and civil unrest control (a big issue in the depression, inflation and political agitation of the 1920s). Until the end of WWI, the terms "German Police" and "Luger" did not have a common conversation. During the Weimar era, the boundary between soldier and police was muddy. There were the misdemeanor traffic type cops (ordnungs-polizei). There was the felony crime investigation police (kriminal-polizei). There was also the military (Reichswehr) itself, which was the only national force that the constitutionally elected, but perennially weak presidents could call upon to oppose the Communist and Fascist extremes.

By the time Hitler was fully in charge, the real police power was in the Secret State Police (Geheim Staatspolizei or Gestapo) within Germany and occupied countries, and the Einsatzgruppen (special exploitation groups), the brute squads especially found on the Germany's WWII Eastern front.

In this regard, police marked Lugers were definitely weapons issued to units of the overall German military. However, a deeper dive into Weimar and Nazi era politics shows a distinction between the German Army (whether Reichswehr or Wehrmacht) and the government police (whether Weimar ordnungs-polizei or paramilitary Nazi Einsatzgruppen). Another way to view the distinction is to consider Military Lugers as the sidearm of front line combatants, while viewing Police Lugers as the sidearm of home front police and rear-area military police.

Prototypes

Prototype Lugers were made for internal manufacturer use in testing and evaluating machining techniques, assembly methods and new Luger features. DWM began Luger production with the 1899 Luger-Borchardt Prototype. Later prototypes included a 1902 series all with a unique combination of features, a

prototype Luger carbine, a seven-shot prototype, and a series of smaller caliber "baby" Lugers.

Later, Mauser Werke would utilize prototype pieces for workshop purposes.

Many collectors do not actively pursue prototype model Lugers. This is partly due to their extreme rarity, and associated high values. This is also due in part to the fact that prototypes were not issued. However, there is not a self-respecting Luger collector alive that would not gladly score one of these nearly unique pieces if the price was right.

Features, markings and serial numbers are not easily characterized for prototypes. Detail on a model-by-model basis can be found in Chapter 7.

Cut-aways

Closely akin to prototype model Lugers are cut-away examples. As the name indicates, these literally have portions cut away to expose the internal mechanism. The two main variations are factory cut-aways and training cut-aways.

Factory cut-aways were, as one might guess, made at the factory. These were usually demonstration or sales pieces, not meant for actual sale at the time. Since these were never fired or carried, they are usually found in exceptional condition. These could have some inspection marks but should not have a test fire proof. A test fire proof on a commercial model cut-away is likely a sign of a forgery.



Training cut-aways were real, full-blown pistols that were later adapted by the military or police for



training purposes. Unlike their factory-made cousins, these pistols should be fully inspection marked and test fire proofed. They also tend to exhibit substantial use and wear. Since nearly any Imperial military P.08 could have been put to use as a training cut-away, many possibilities exist, both for different variations and for fraud pieces to be made. *Caveat Emptor*.

Test/Trial

Test/trial model Lugers were made with a specific customer's (usually a nation's military) in mind. We know that Lugers were submitted for military test and evaluation to the Swiss military (successful tests led to a contract and long-term business relationship), US Army (at least 3 different submissions of test Lugers over about six years, not successful enough to win out over the Colt automatic pistol) Great Britain (little is known, but the outcome was obviously to not adopt the Luger), and of course to the German military (the Navy in 1904, the Germany Army up through 1908, the Luftwaffe with the Krieghoff Grip Safety model).

Sometimes a test trial submission constituted a production run of several hundred to a thousand pieces. Other times, the submission consisted of fewer than four Lugers. These are often landmark pieces since they represent the first exposure of, say the US Army, to the Luger as a potential sidearm.

Engraved Lugers

Engraved Lugers are definitely a specialty within Luger collecting. One of my mentors in collecting likened engraving style to someone's accent or handwriting. It is influenced by both where they learned their art, and by their individually developed style. German engraving tends to be heavy in oak leaves and acorns. Some were blued. Some were gilded.

There is also a category of "poor man's" decorated Lugers. These were often GI bring-backs, and will have some sort of German military heraldry, rank, or NSDAP emblem added to the grips. This was relatively easy to do to any Luger, and added to the appearance in the eyes of the GI. Unfortunately, these don't get much respect from collectors since they are altered in a non-factory way. This is even more common on Luger holsters, with German hat eagles added to the top flap.

Special Presentation Pieces

There are a couple categories of presentation pistols. One is as an award for some accomplishment. This was a common practice for German shooting competitions, where the winner often won a trophy rifle or trophy pistol. Nazi pistol collectors are familiar with the boxed Himmler signature Sauer pistols. The giver of these was usually someone of significance, while the receiver was someone obscure, apart from the specific competition accomplishment. Since P.08s were combat side arms, they were usually not used for this purpose.

The other type of presentation Luger was as a gift to someone of prominence, to either influence a decision or express thanks. Chapter 7 includes several presentation Lugers from the 1900-1906 years, which were part of a limited production, but still represent non-unique pieces (apart from the initials).

However, there is one presentation Luger that stands alone, in its historical significance and breathtaking beauty.

Chapter 5 recounts the story of how Heinrich Krieghoff Company came to be the sole supplier of P.08s for the Luftwaffe. Anyone who has read anything about Luftwaffe chief Herman Goering knows that he was a collector. He collected art, wine, uniforms, titles,



and firearms. HK Krieghoff and Sohn appealed to that passion by presenting Goering with a plated, engraved, gold-inlaid, ivory-gripped Luger pistol in a blue velvet lined case.

Back in the mid 1970s documentation from the Krieghoff company confirmed that there were actually two examples of this pistol. The original one was exposed to corrosive chemicals used to make the leather case, so a replacement was made and forwarded to Hitler's deputy.

Spanish Civil War Lugers

Starting in the summer of 1936, Germany began providing military aid to Spain's Generalissimo Francisco Franco, who was fighting the communists for control of Spain. We know from photo evidence that Franco's men had some Lugers. There is even report of one with a Spanish Guards chamber crest. What is not known with certainty is if these were Mauser Banner commercial, Mauser Banner contract or S/42 military pistols. This is an area that could benefit from a focused study and well-written article.

Chapter 5

Lugers by Manufacturer

Luger Production



DWM

Most commercial, contract and military Lugers through the end of WWI were made by Deutsche Waffen und Munitionsfabriken, known by their initials DWM. DWM was the result of a merger in 1897 between DMK (Deutsche Metallpatronenfabrik of Karlsruhe) and Ludwig Lowe. While the Karlsruhe operation continued to focus on ammunition, the Berlin based big brother focused on firearms manufacture. With Georg Luger as an employee, and with his patented design to fuel orders from its manufacturing line, DWM soon became a household name in Germany.

DWM produced all Lugers from its inception until 1908. From 1908 through the end of WWI, DWM produced well over half of all military P.08s. Finally, Even though Simson and Co. (see below) was the only sanctioned supplier of Lugers to the Weimar government, DWM made thousands upon thousands of commercial model Lugers, plus the reworked Weimar models.

DWM ceased to exist as a stand-alone company when they were merged into Mauser Werke in 1930. Within a couple years, all DWM marked pistols and parts had been exhausted in what could be called some hybrid DWM/Mauser models. By 1934 Mauser had put its fingerprints on the Luger regarding finish, serial numbering and markings.

All totaled, DWM made nearly 1 million Lugers, or about 38 percent of all Lugers.

DWM manufactured Lugers are high-quality, beautiful blue finished, with precise fitting and crisp operation. Even the military model DWM Lugers up through WWI are as quality and attractive as any commercial pistol made during that period.



Erfurt

Within a year of the German army adopting the P.08, Georg Luger's design was licensed to the royal government arsenal in Erfurt Germany. Erfurt only made army military models from 1910 to 1918. They were also believed to be involved in the 1920 rework program.

All totaled, Erfurt made nearly 520,000 Lugers, or just under 21 percent of all Lugers.

Erfurt-manufactured Lugers are the least attractive of any made. Their reliability and safety is no less, but the finishing was a little rougher, a little looser, showing more machining marks. Remember that prior to 1908, DWM made most of its money on commercial and contract sales. They only knew how to make an attractive pistol. Erfurt only ever made Lugers for military use. This author has long used the term "functionally ugly" to describe Erfurt Lugers.

One of the most fascinating threads of irony around the Luger is tied up in the Erfurt machines, tools, dies and fixtures for making the P.08. See the whole story toward the end of this chapter.

Vickers

The Netherlands had been using the DWM-made 1906 Dutch model Luger. In 1923 the Dutch government desired to purchase more of this now-discontinued pattern of Luger.

However, the under the Treaty of Versailles, DWM was forbidden to manufacture a firearm of this configuration. In stepped the British company Vickers Armstrong, Ltd. to broker the deal.

DWM provided the rough machined parts for 1906-pattern Lugers to Vickers. Vickers performed minimal final machining and assembly, and marked them with their name. These were sold to the Dutch government as the Vickers Dutch, Military model. There was a small overrun in production (probably spares to allow for breakage at Vickers), which was sold as the Vickers Dutch, Commercial model. These two variations in this one production run constitute the total of Vickers contribution to Luger production.

All totaled, Vickers made 10,100 Lugers, or about .4 percent of all Lugers.

Vickers Lugers have an almost rough, bead blasted metal finishing beneath standard rust blue.

Swiss/Bern

The Swiss were the first and a steady consumer of Georg Luger's fabulous design. Despite that, they made an attempt to improve upon the design with their own Luger. Waffenfabrik Bern made Lugers for Swiss military and domestic commercial consumption within Switzerland. These non-Luger Lugers closely resemble the traditional Luger, but the grips, toggle knobs, takedown lever and thumb safety are all noticeably different.

Waffenfabrik Bern produced its Lugers from 1924 to 1929. In the mid 1930s Mauser made a new Swiss commercial model, but the Swiss military had made its own Luger wannabe completely on its own.

All totaled, Bern made about 48,000 Lugers, or just under 2 percent of all Lugers.



Simson

Following the German surrender in WWI, the victorious allies wanted to keep a tight reign on German military capability. The commercial company DWM was seen as an untrustworthy part of the Kaiser's former military industrial complex. Erfurt was closed and disassembled.

Erfurt equipment found its way to a company called Simson and Co. in Suhl Germany. Under the watchful eye of an allied military commission, Simson produced military and police P.08s from 1922 to 1934.

Simson was born out of the desire of the WWI victors to prevent German rearmament. Little more than 10 years later, that much feared rearmament was about to begin under the newly empowered Nazi political party.

The handwriting was on the wall for Simson Co. Not only was it a Jewish-owned company, and thus the Nazi-defined quintessence of evil, but it was an agent of a weak republic which Hitler and his Nazi party wanted to replace with a National Socialist state. Simson ended Luger production by 1934.

All totaled, Simson made 12,000 Lugers, or about .5 percent of all Lugers.

Simson Lugers look closely akin to DWM Lugers. They are well-finished, tight fitting pistols of a commercial quality.



Mauser

In 1930 Mauser Werke of Oberndorf Germany absorbed a company named Berlin-Karlsruhe Industrie Werke (BKIW). BKIW was the post-WWI holding company that had owned DWM since 1922. Through 1933 Mauser assembled and sold several commercial and contract Luger models made from existing DWM inventory. By 1934 Mauser had its own distinct Luger, finding success both in the commercial market and with the new German Reich.

Mauser continued as the primary Luger producer through early 1942. The only thing that ceased Mauser Luger production was the introduction of the new Walther designed P.38 pistol. By late 1942 Mauser had retooled its production line and was augmenting P.38 production from Walther and fellow contract producer Spreewerke.

All totaled, Mauser made nearly 1 million Lugers, or about 38 percent of all Lugers.

Mauser Lugers are high-quality, tight-fitting, good-looking pistols. Two subtle differences in the finish of

Lugers are credited to Mauser; (1) A salt or immersion blue and (2) eventually an all blue (no straw) gun.



Krieghoff

Heinrich Krieghoff Waffenfabrik in Suhl Germany made fabulous hunting rifles and sporting shotguns. The firm had wanted to get into military firearms as well, but the Versailles Treaty made chances of this remote at best.

When the Nazi era rearmament began, Krieghoff rightly saw that no company had a standing relationship with the Luftwaffe (unlike the first position which Mauser and Walther had with the army). Krieghoff also shrewdly sought a relatively low-profit contract to satisfy the Herman Goering's desire for a front-line combat sidearm.

Krieghoff acquired the tooling from the now-defunct cross-town rival Simson and Co. Krieghoff won the Luftwaffe contract for 10,000 Lugers, and began production in 1934. As an aside, the shrewdness of this strategy proved itself when Krieghoff secured lucrative additional contracts on survival shotguns for Luftwaffe bombers, flare pistols, and most importantly MG-15s and later FG-42 rifles.

By the end of 1937 Krieghoff had made components for 13,580 Lugers. The overrun was in anticipation of a follow-up contract above the 10,000. Between 1938 and 1944 an additional 2,000 or so P.08s were delivered to the Luftwaffe by Krieghoff. The remaining 1,500 to 1,600 were sold as commercial Lugers from 1937 through the end of the war.

All totaled, Krieghoff made 13,580 Lugers, or about .5 percent of all Lugers.

Krieghoff Lugers have their own look. All were salt blue, like Mauser Lugers. Compared to its contemporary Luger maker, Mauser, Krieghoff Lugers exhibited an impressive ability for parts interchangeability, which secured its position as a Luftwaffe arms supplier.

Tinkers, To Evers, To Chance

Lesser known, but more interesting is the trio of Erfurt, to Simson, to Krieghoff.

Since the Erfurt arsenal was an entity of the defeated German WWI military, it was shut down, disbanded and its equipment confiscated and sold to ERMA Werke.

However, the same Versailles Treaty that emasculated the Erfurt arsenal, provided for a single provider of military sidearms for the German military. That supplier was Simson and Co., Suhl. Simson was tightly controlled by the commission that monitored post-WWI Germany for compliance with the Versailles Treaty.

Since the standard German sidearm was the P.08, but Simson and Co. was not equipped to make the Luger pistol, the Erfurt manufacturing line was given/sold to Simson. The Erfurt equipment became the Simson equipment.

Using the same equipment, Simson put a little more finishing work into its Lugers, resulting in a pistol closer to the class of a DWM Luger than to the rugged-looking Erfurt. However, Simson was a Jewish-owned company. Therefore, as the Nazi's came to power it was obvious that a Jewish company with official ties to the Weimar Republic would not find favor with the party of an anti-Semite like Hitler.

As the Nuremberg Laws drove Jewish companies out of business, Nazi-owned companies like Gustloff Werke and Berliner-Suhler-Waffenfabrik bought and stole the assets of companies like Simson.

About this same time, Herman Goering was looking for top-notch sidearms for his Luftwaffe. Army production occupied Mauser's facilities. So, a new supplier was sought. As we have already covered, the Heinrich Krieghoff Waffenfabrik of Suhl Germany both won the Luftwaffe contract for making the P.08, and acquired the former Erfurt, former Simson, Luger manufacturing line from Gustloff.

There is some debate over whether Krieghoff employed the now 25-year-old equipment, or simply used it as a starting point to build its own line from new equipment. It is almost certain that Krieghoff only used the equipment as a template for its own, new line. In either case, Krieghoff produced some absolutely stunningly beautiful and pristine looking Lugers. This is a rare case of ugly genes producing a supermodel.

Importers

Lugers were imported into the United States by several companies. Early on Georg Luger tried it himself under the name Luger Sales Company. Later on a DWM sales agent named Hans Tauscher was the sole importer of Lugers up to the start of WWI. Then A.F. Stoeger and later Abercrombie and Fitch became the main post-WWI Luger importers. While their imports did bear their inscriptions, neither Stoeger nor Abercrombie and Fitch manufactured Lugers.

In addition to these main importers, companies like Pacific Arms imported quantities of various military and commercial model Lugers. These will fall into the categories of the various original model pistols with whatever importer marks (like PA in the case of Pacific Arms) added.

Lugers by Feature Pattern

Description of the Features

Chart of the Features

The Luger pistol only underwent one substantial redesign during its 45 years in the sun.

A few features like the stock lug and sear safety were added over time. The grip safety was deleted as a standard feature, only to be specifically added to later Simson, Mauser and Krieghoff models.

Collectors characterize the common configurations by the year that combination of features became a standard.

The 1900 Pattern

These were the first commercially successful Lugers. In 1900 and 1901 the Luger was only made in 7.65 mm (.30 Luger).

1900 Pattern Lugers will have the following features in common:

- * The dished-type toggle knobs with the toggle lock feature.
- * A metal grip safety.
- * No stock lug (except carbine models).
- * They will be chambered for 7.65 mm (.30 Luger).
- * Four-groove rifling, 1 turn in 25 cm.

The 1900 Pattern will be found in commercial and contract models. Military test models are also found in this pattern, but no German military production models.

The 1900 Pattern was produced and sold from 1900 through 1905.

The 1902 Pattern

Some refer to a 1902 Pattern, which is simply the 1900 Pattern chambered for 9mm Parabellum. Feedback from military test trails with several nations made Georg Luger begin offering the Luger chambered for this new round of his invention.

The 1902 Pattern will have the following features in common:

- * The dished-type toggle knobs with the toggle lock feature.
- * A metal grip safety.
- * No stock lug (except carbine models).
- * 9mm Parabellum.
- * Six-groove rifling, 1 turn in 25 cm.

One exception to this classification is the 1902 Carbine, which was still in 7.65 mm. It is not typically called a 1900 Carbine to prevent confusion with a prior carbine model.

The 1902 Pattern will be found in commercial and contract models. New military test models are also found in this pattern, but no German military production models.

The 1902 Pattern was produced and sold from 1902 through 1905.

The 1904 Pattern

This is actually not a pattern, but a preview of some 1906 Pattern features that first made their debut on the first German military model, the 1904 Navy.

The 1906 Pattern

The 1906 Pattern saw the only substantial redesign of the Luger. Externally the design change is identified by

- * Flat, checkered toggle knobs.
- * Grip safety.
- * No stock lug (accept carbine and navy models).
- * Six-groove rifling, 1 turn in 25 cm.

The 1908 Pattern

The 1908 pattern is the configuration of features which, coupled with the 9mm Parabellum cartridge, captured the attention of the German army.

1908 pattern Lugers will have the following features in common:

- * Flat, checkered toggle knobs.
- * No grip safety.
- * No stock lug (except carbine models).
- * Six-groove rifling, 1 turn in 25 cm.

The 1914 Pattern

The 1914 pattern represents the combination of features that constituted the majority of military and commercial Lugers in WWI and through the Weimar era.

The 1914 pattern is identifiable by the following features:

- * Flat, checkered toggle knobs.
- * No grip safety (except for special models like the Simson grip safety, and the Swiss Bern model).
- * Stock lug.
- * Rust blue finish.
- * Wood-base magazine.
- * Six-groove rifling, 1 turn in 25 cm.

The 1929 Swiss Pattern

- * Flat, smooth toggle knobs.
- * Grip safety.
- * No stock lug.
- * Straight-grip front strap.

The 1934 Pattern

The 1934 pattern is not so much a new pattern as a few changed features, all introduced by Mauser. The 1934 pattern constituted all Nazi-era commercial and military Lugers, with the exception of a few throw-back 1906 pattern models.

The 1934 pattern is identified by the following features:

- * Flat, checkered toggle knobs.
- * No grip safety (except for special models like the Mauser Banner grip safety and the Krieghoff grip safety models).
- * Stock lug.
- * Salt blue finish.
- * Aluminum-base magazine.
- * Six-groove rifling, 1 turn in 25 cm.

Chapter 7

Lugers in Detail

Names for some Luger variations have become accepted and well established. Others struggle to find a consistent, accurate name. For example, what some call a 1934/06 model (made in 1934 in a 1906 pattern), herein is called a grip safety model. In particular, the naming for Weimar military and police models is new enough that an outline precedes these variations.

Regardless of the name, Luger model identification starts by looking at the big, obvious features, which narrows the possibilities down to the likely suspects. Then, proceed to the finer features, the acceptance and proof marks, and the serial number range and placement. I've tried to organize that process in a step by step systematic way. When looking at a Luger, there are several obvious features:

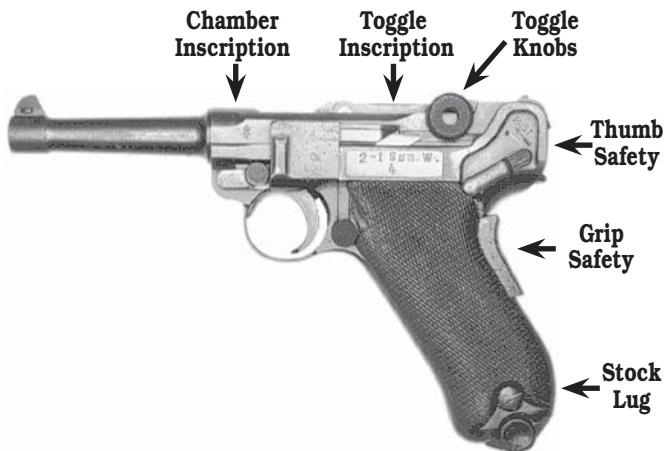

By tracing these features through the following charts, you can identify the possible models. Then just turn to the Look-Up Index number(s) in the chart to read about that model.



=> See Index Look-Up Charts 1 and 2

//

THE TOGGLE IS MARKED

\\

OTHERWISE => See Index Look-Up Charts 3 and 4

EXAMPLE 1:

You are looking at a Luger. Its toggle is marked "DWM." From that you know to go to either Index Look-Up Chart 1 or 2.

The chamber is unmarked, so you go to Index Look-Up Chart 1.

It has late type toggle knobs, which takes you down the "Late Toggle" branch of the tree.

It has a stock lug, which takes you down the "Stock Lug" branch of the tree.

It has no grip safety, which takes you down the "No grip safety" branch of the tree.

The safety is marked "GESICHERT" , and it has a 4-inch barrel.

Finally, it has a Crown/U proof mark.

A reading of the detailed descriptions of Index Look-Up #s 124 and 135 will tell you whether you are looking at a DWM/Mauser Finnish Military, or a DWM/Mauser Oberndorf.

EXAMPLE 2:

You are looking at a Luger. Its toggle is marked with the Mauser Banner. From that you know to go to either Index Look-Up Chart 3 or 4.

The Mauser Banner marked toggle is found on Chart 4.

It has a blank chamber, so there are four variations to check for proof markings and serial number ranges to determine exactly which Luger you are looking at.

Good Luger hunting!

INDEX LOOK UP CHART 1

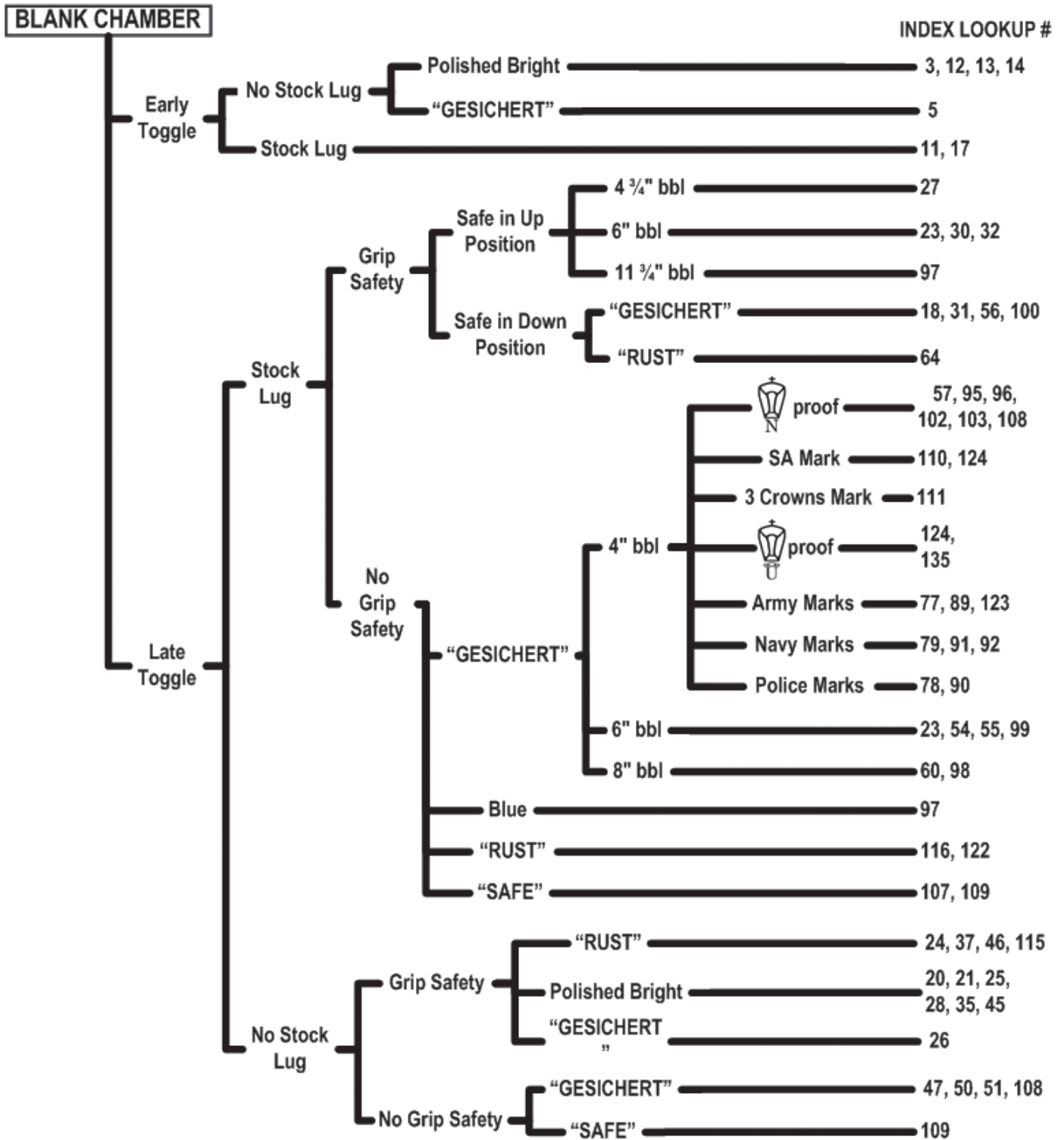

INDEX LOOK UP CHART 2

CHAMBER MARKED		INDEX LOOKUP #	
DATED	Stock Lug	4" bbl 58, 71-73, 85-88, 102	
		6" bbl 63	
		8" bbl 62, 98	
	No Stock Lug 52		
DATED WITH SKULL 127			
DOUBLE DATED 65, 66, 67, 83, 84			
EAGLE	Early Toggle	Polished Bright 8, 9, 15	
		Blue 16	
	Late Toggle	Stock Lug	"GESICHERT" 108
			"SAFE" 109, 133
		No Stock Lug	Grip Safety 33, 34
			No Grip Safety 108, 109
Kl. 1933 128			
Lion	Early Toggle 10		
	Late Toggle 22, 36		
CROSS IN SUNBURST	Early Toggle 6,7		
	Late Toggle	Stock Lug 134	
		No Stock Lug 42, 44, 101, 104	
CROSS IN SHIELD 43			
CROSSED RIFLES 41			
ANCHOR 39, 40			
CROWN OVER INTERTWINED M2 38			
"Ejercito de Bolivia" 48			
Engraved Initials	Early Toggle 4		
	Late Toggle 29		

INDEX LOOK UP CHART 3

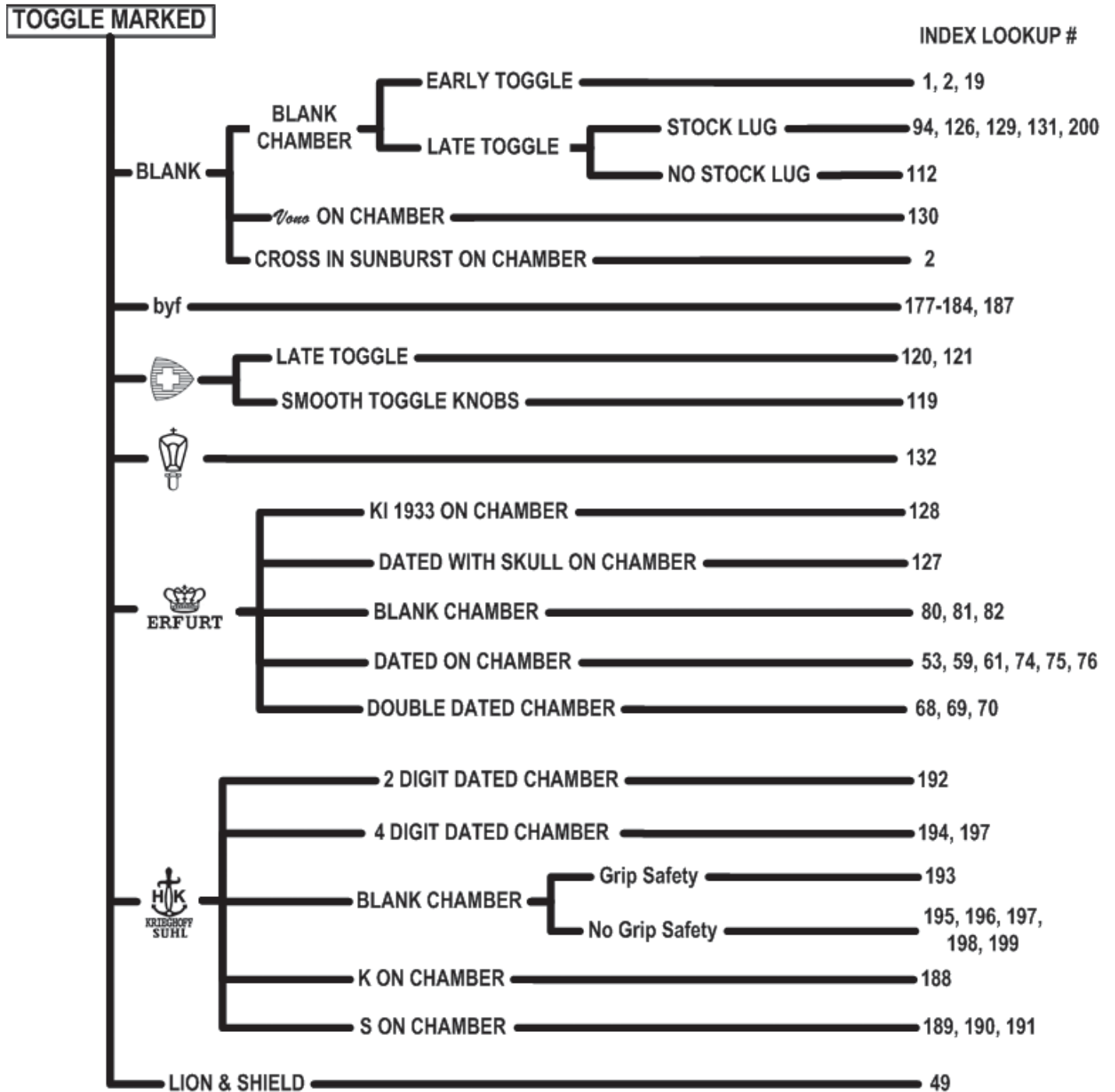

INDEX LOOK UP CHART 4

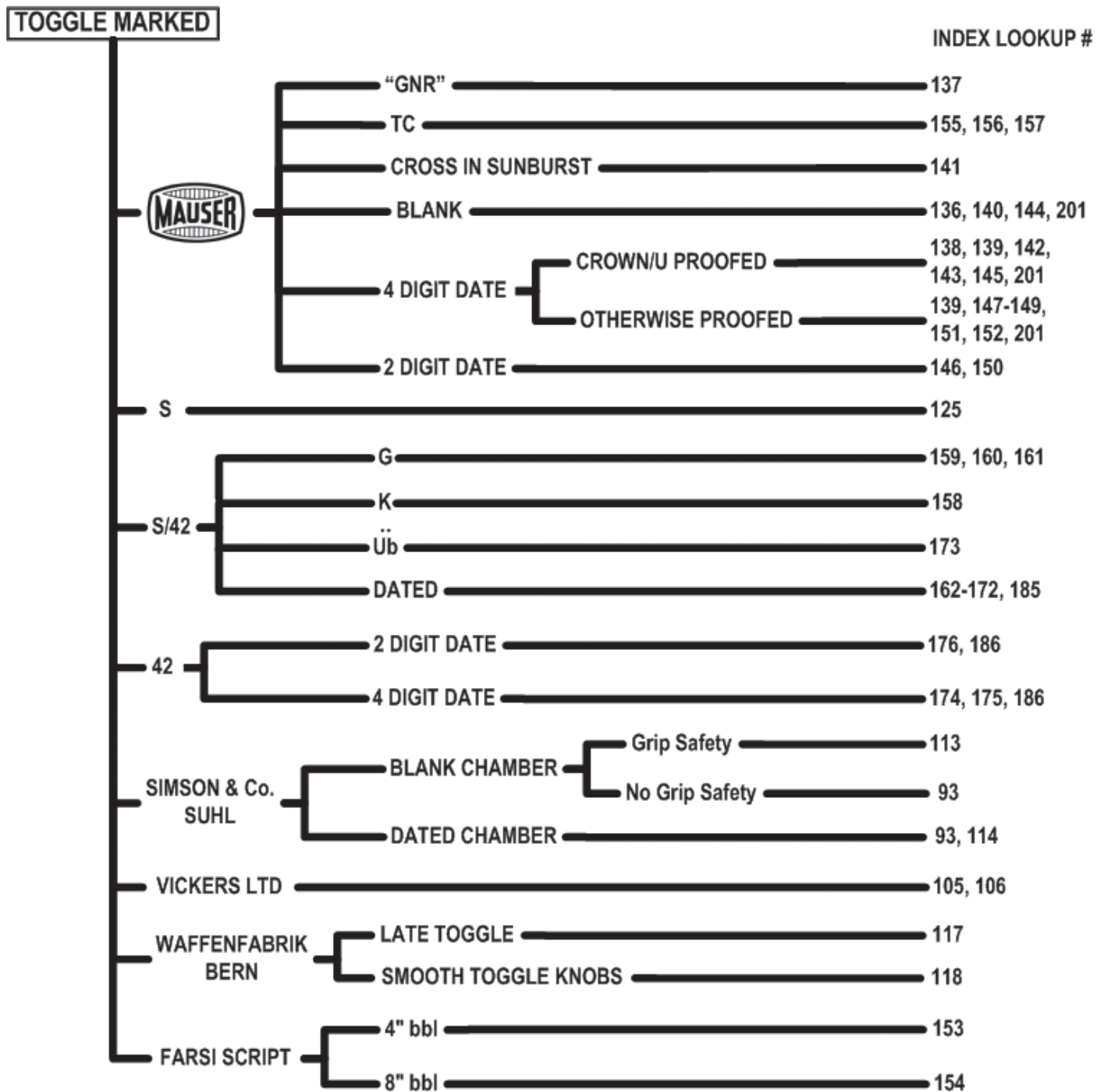

Look-up Index # 1

LUGER-BORCHARDT TRANSITIONAL

BACKGROUND

The Luger-Borchardt Transitional model was the first true Luger pistol. It was produced for military testing and evaluation by the Swiss military.

HOW TO TELL A LUGER-BORCHARDT TRANSITIONAL

The Luger-Borchardt Transitional can be distinguished from other Lugers by one distinct feature.

1. The area behind the toggle rails is not relieved down to accept the thumb safety. This area is all the same width as the rails themselves, and the thumb safety lever is uniquely short.

QUANTITY MADE

Less than 10.

RARITY RATING

9, Nearly unique.

FEATURES IN DEPTH

MANUFACTURER: This model was manufactured by DWM (Deutsche Waffen and Munitionsfabriken) of Berlin.

TOGGLE: This model should have the early-type toggle with the dished toggle knobs and the toggle lock mechanism.

TOGGLE MARK: This model should have a blank toggle.

BARREL: This model should have a 5-inch(125mm) barrel with a slim, tapered look. It should be chambered for 7.65mm (.30 Luger).

FRAME: The frame on this model should be the early, long transitional type with a removable section on the left frame rail, grip safety, narrow trigger and wide trigger guard.

RECEIVER: The receiver on this model should be the early, long type. The chamber should be blank.

THUMB SAFETY: The thumb safety on this model should be a shorter than normal smooth safety lever. Safe is in the upper position.

SIGHTS: The front sight on this model should be a saw tooth shaped blade, dovetail fit on the barrel. The rear sight should be a fixed V notch in the rear toggle link.

EXTRACTOR: The extractor on this model should be the early-type. It should be unmarked.

GRIPS: The grips on this model should be checkered walnut with a smooth border.

MAGAZINE: The magazines original to this model should have a nickel-plated, wrap-around body with a wood base. They should not be serial numbered or proof marked.

FINISH: The main finish on this model should be a high-quality rust blue. The ejector, extractor, magazine catch/release, takedown lever, toggle lock and trigger should all be straw colored.

SERIAL NUMBER RANGE: Serial numbers on this model run from 1 to two digits.

SERIAL NUMBER LOCATION: This model should have the full number on the bottom of the barrel and the REAR of the frame above the lanyard loop.

INTERESTING VARIATIONS

There are no notable variations of this model.

MARKINGS

MARK	LOCATION/DESCRIPTION
------	----------------------

This model has no acceptance or proof marks.

VALUES

This model is too rare to price.

Look-Up Index # 2

1899/1900 TEST

BACKGROUND

The 1899/1900 Test model was the first true Luger pistol. It was produced for military testing and evaluation by the Swiss military.

HOW TO TELL AN 1899/1900 TEST

The 1899/1900 Test can be distinguished from other Lugers by four features in combination.

1. Early, dished style toggle knobs.
2. No inscription on the toggle.
3. No proof marks.
4. 4¾-inch barrel.

QUANTITY MADE

Approximately 50.

RARITY RATING

8, Extremely rare, about 20 known.

FEATURES IN DEPTH

MANUFACTURER: This model was manufactured by DWM (Deutsche Waffen and Munitionsfabriken) of Berlin.

TOGGLE: This model should have the early-type toggle with the dished toggle knobs and the toggle lock mechanism.

TOGGLE MARK: This model should have a blank toggle.

BARREL: This model should have a 4¾-inch (120mm) barrel with a slim, tapered look. It should be chambered for 7.65mm (.30 Luger).

FRAME: The frame on this model should be the early, long type with a grip safety, narrow trigger and wide trigger guard.

RECEIVER: The receiver on this model should be the early, long type. The chamber should be blank or marked with a Swiss Cross in Sunburst inscription.

THUMB SAFETY: The thumb safety on this model should have a checkered safety lever. The lower position is polished (not blued). Safe is in the upper position.

SIGHTS: The front sight on this model should be a saw tooth shaped blade, dovetail fit on the barrel. The rear sight should be a fixed V notch in the rear toggle link.

EXTRACTOR: The extractor on this model should be the early-type. It should be unmarked.

GRIPS: The grips on this model should be checkered walnut. The left grip should be slotted for the grip safety.

MAGAZINE: The magazines original to this model should have a nickel-plated, wrap-around body with a wood base. They should not be serial numbered or proof marked.

FINISH: The main finish on this model should be a high-quality rust blue. The ejector, extractor, magazine catch/release, takedown lever, thumb safety lever, toggle lock and trigger should all be straw colored.

SERIAL NUMBER RANGE: 1 to 50.

SERIAL NUMBER LOCATION: This model should have the full number on the bottom of the barrel and the REAR of the frame above the lanyard loop.

INTERESTING VARIATIONS

Serial numbers up through # 5 are thought to have no thumb safety.

Several examples of this model have a Swiss Cross in Sunburst on the chamber. The Swiss tested these.

MARKINGS

MARK	LOCATION/DESCRIPTION
	This model has no acceptance or proof marks.

VALUES

This model is too rare to price.

Look-Up Index # 3

1900 COMMERCIAL



BACKGROUND

The 1900 Commercial model was the first full production Luger. As the name indicates, it was produced for commercial sales (both domestic and outside of Germany). Examples of this model were sold to at least 13 countries for military test and evaluation. This was in addition to models like the American and Swiss specific models of the same pattern.

HOW TO TELL A 1900 COMMERCIAL

The 1900 Commercial can be distinguished from other Lugers by six features in combination.

1. Early, dished style toggle knobs.
2. No inscription above the chamber.
3. The "BUG" proof (see proof marks below) on the right side of the receiver.
4. Chambered in 7.65mm
5. Safe in the up position.
6. 4¾-inch or 7-inch barrel.

QUANTITY MADE

Approximately 6,000 in 4¾-inch barrel, 500 in 7-inch barrel.

RARITY RATING

4. Scarce in the 4¾-inch barrel configuration.
7. Very rare in the 7-inch barrel configuration.

FEATURES IN DEPTH

MANUFACTURER: This model was manufactured by DWM (Deutsche Waffen and Munitionsfabriken) of Berlin.

TOGGLE: This model should have the early-type toggle with the dished toggle knobs and the toggle lock mechanism.

TOGGLE MARK: 

BARREL: This model should have a 4¾-inch (120mm) barrel with a slim, tapered look. It should be chambered for 7.65mm (.30 Luger). Some are in 7-inch (see the Spanish country variation below).

FRAME: The frame on this model should be the early, long type with a grip safety, narrow trigger and wide trigger guard. Some examples were exported to the US and appropriately marked "GERMANY." The 7-inch barrel examples will have a stock lug.

RECEIVER: The receiver on this model should be the early, long type. The chamber should be blank. At least two examples have engraved, gold inlay initials on the chamber.

THUMB SAFETY: The thumb safety on this model should have a checkered safety lever. The lower position is polished (not blued). Safe is in the upper position.

SIGHTS: The front sight on this model should be a saw tooth shaped blade, dovetail fit on the barrel. The rear sight should be a fixed V notch in the rear toggle link.

EXTRACTOR: The extractor on this model should be the early-type. It should be unmarked.

GRIPS: The grips on this model should be checkered walnut. The left grip should be slotted for the grip safety.

MAGAZINE: The magazines original to this model should have a nickel-plated, wrap-around body with a wood base. They should not be serial numbered or proof marked.

FINISH: The main finish on this model should be a high-quality rust blue. The ejector, extractor, magazine catch/release, takedown lever, thumb safety lever, toggle lock and trigger should all be straw colored.

SERIAL NUMBER RANGE:

01 to 19294 in 4¾-inch barrel;
10000 to 10500 in 7-inch barrel.

Note that all commercial 1900 models (the American Eagle, Commercial, and Swiss) will be found within the 1 to approximately 21220 serial number range.

SERIAL NUMBER LOCATION: The full serial number is found on the bottom of the barrel and on the front of the frame. The last two digits of the serial number are on the breechblock (lower left side), front toggle link (bottom), rear toggle link (back), receiver (rear), side plate (bottom edge), takedown lever (bottom), trigger (top left), grip safety (under grip) and grips (inside).

INTERESTING VARIATIONS

HISPANIC VARIATION

The 7-inch barrel examples were sold exclusively in Spanish-speaking countries, possible South America.

DUTCH TEST VARIATION

Two specimens (serial numbers 35 and 36) were sold to the Netherlands in March 1900 for military test and evaluation.

The success of this testing is shown by the follow up order for an additional 10 test pistols for mounted artillery troop trials. Although ordered in July 1900, extensive customization (including the addition of an adjustable rear sight) delayed the delivery of these 10 pistols until October 1901.

Although the Luger was not adopted for the Dutch artillery troops, yet another 10 pistols were ordered in 1904 for a new set of trials for a new infantry sidearm. Ordered in September 1903, a more timely delivery was achieved three months later. These were 1900 Pattern pistols, with a 4-inch (102mm) barrel chambered in 7.65mm. They also had the likely first use of a coil main spring. The serial numbers of these 10 Lugers are known: 10084 to 10089, 10095, 10098 to 100100. One of these is also documented to have been equipped with a cartridge-counting set up (see the American Eagle 1902 Cartridge Counter model for a description).

These tests would eventually lead to the Dutch adoption of the Luger pistol, but not until after evaluating one more test model (see the 1905 Dutch Test model).

BRITISH TEST VARIATION

In 1901 the British government is known to have purchased a small number of 1900 Commercial Luger pistols for test and evaluation. Little is known about the serial number range, but serial number 167 is the lowest known number. Theoretically, any found in private hands would have the Crown over BNP release proof marks common to small arms released from British military use.

SWEDISH TEST VARIATION

Not much is known about marks or serial numbers of this variation, other than to know that Sweden tested the Parabellum pistol in 1903 and 1904.

AUSTRIAN TEST VARIATION

Not much is known about marks or serial numbers of this variation, other than that Austria tested the Parabellum pistol in 1904.

PORTUGUESE TEST VARIATION

Examples found in the serial number range 18000-19000 may also have an added "issue" number on the left side of the receiver. These were purchased by Portugal for military test trials.

There is also evidence that 1900 Commercial models were evaluated by the following:

- * Brazil
- * Canada
- * Chile

- * Luxemburg
- * The Netherlands
- * Norway
- * Portugal
- * Russia
- * Spain

- * GHP for G.H. Powell, the designer of the Powell Indicating device used in the American Eagle Cartridge Counter model.

MARKINGS

MARK **LOCATION/DESCRIPTION**



Toggle
Manufacturer's Logo



Toggle or Receiver
Commercial Proof

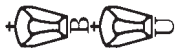

Barrel
German Commercial Proof

VALUES

POOR	FAIR	GOOD	VG	EXC
Standard Model				
\$750	\$1,000	\$2,000	\$3,500	\$5,000
7-inch barrel				
\$1,500	\$2,000	\$2,750	\$4,000	\$7,500
Dutch				
\$1,500	\$2,000	\$2,750	\$4,000	\$7,500
Portuguese				
\$1,500	\$2,000	\$2,500	\$4,000	\$6,000

Look-Up Index # 4

1900 PRESENTATION

BACKGROUND

The 1900 Presentation Model specimens were made as gifts to dignitaries, officials, and people of influence whose favor Georg Luger hoped to curry.

The intended recipient of each pistol can be identified by the intertwined initials inscribed above the chamber. Known examples include:

- * TD for Trevor Dawson of the British Royal Arsenal.

HOW TO TELL A 1900 PRESENTATION

The 1900 Presentation can be distinguished from other Lugers by three features in combination.

1. Early, dished style toggle knobs.
2. The chamber is engraved with the initials of the intended recipient.
3. 4¾-inch barrel.

QUANTITY MADE

Probably less than 12.

RARITY RATING

8, Extremely rare.

FEATURES IN DEPTH

MANUFACTURER: This model was manufactured by DWM (Deutsche Waffen and Munitionsfabriken) of Berlin.

TOGGLE: This model should have the early-type toggle with the dished toggle knobs and the toggle lock mechanism.

TOGGLE MARK: 

BARREL: This model should have a 4¾-inch (120mm) barrel with a slim, tapered look. It should be chambered for 7.65mm (.30 Luger).

FRAME: The frame on this model should be the early, long type with a grip safety, narrow trigger and wide trigger guard.

RECEIVER: The receiver on this model should be the early, long type. The chamber should be blank.

THUMB SAFETY: The thumb safety on this model should have a checkered safety lever. The lower position is polished (not blued). Safe is in the upper position.

SIGHTS: The front sight on this model should be a saw tooth shaped blade, dovetail fit on the barrel. The rear sight should be a fixed V notch in the rear toggle link.

EXTRACTOR: The extractor on this model should be the early-type. It should be unmarked.

GRIPS: The grips on this model should be checkered walnut. The left grip should be slotted for the grip safety.

MAGAZINE: The magazines original to this model should have a nickel-plated, wrap-around body with a wood base. They should not be serial numbered or proof marked.

FINISH: The main finish on this model should be a high-quality rust blue. The ejector, extractor, magazine catch/release, takedown lever, thumb safety lever, toggle lock and trigger should all be straw colored.



SERIAL NUMBER RANGE: In the 01 to 19294 range.

SERIAL NUMBER LOCATION: The full serial number is found on the bottom of the barrel and on the front of the frame. The last two digits of the serial number are on the breechblock (lower left side), front toggle link (bottom), rear toggle link (back), receiver (rear), side plate (bottom edge), takedown lever (bottom), trigger (top left), grip safety (under grip) and grips (inside).

INTERESTING VARIATIONS

There are no notable variations of this model.

MARKINGS

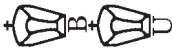
MARK	LOCATION/DESCRIPTION
	Toggle Manufacturer's Logo
	Toggle or Receiver Commercial Proof
	Barrel German Commercial Proof

VALUES

This model is too rare to price.

Look-Up Index # 5

1900 COMMERCIAL, SAFETY EXPERIMENT

BACKGROUND

The 1900 Commercial, Safety Experiment model was an early experimental block of Lugers without a grip safety, and with the late style thumb safety (safe is in the lower position). These were assembled for internal evaluation, and not for commercial sales.

HOW TO TELL A 1900 COMMERCIAL, SAFETY EXPERIMENT

The 1900 Commercial, Safety Experiment can be distinguished from other Lugers by two features in combination.

1. Early, dished style toggle knobs.
2. Safe is in the lower position.
3. 4¾-inch barrel.

QUANTITY MADE

Estimated at less than 100.

RARITY RATING

8, Extremely rare.

FEATURES IN DEPTH

MANUFACTURER: This model was manufactured by DWM (Deutsche Waffen and Munitionsfabriken) of Berlin.

TOGGLE: This model should have the early-type toggle with the dished toggle knobs and the toggle lock mechanism.

TOGGLE MARK: 

BARREL: This model should have a 4¾-inch (120mm) barrel with a slim, tapered look. It should be chambered for 7.65mm (.30 Luger).

FRAME: The frame on this model should be the early, long type with a narrow trigger and wide trigger guard.

RECEIVER: The receiver on this model should be the early, long type. The chamber should be blank.

THUMB SAFETY: The thumb safety on this model should have a checkered safety lever. The upper position is marked "GESICHERT." Safe is in the lower position.

SIGHTS: The front sight on this model should be a saw tooth shaped blade, dovetail fit on the barrel. The rear sight should be a fixed V notch in the rear toggle link.

EXTRACTOR: The extractor on this model should be the early-type. It should be unmarked.

GRIPS: The grips on this model should be checkered walnut.

MAGAZINE: The magazines original to this model should have a nickel-plated, wrap-around body with a wood base. They should not be serial numbered or proof marked.

FINISH: The main finish on this model should be a high-quality rust blue. The ejector, extractor, magazine catch/release, takedown lever, thumb safety lever, toggle lock and trigger should all be straw colored.

SERIAL NUMBER RANGE: 9900 range.

SERIAL NUMBER LOCATION: The full serial number is found on the bottom of the barrel and on the front of the frame. The last two digits of the serial number are on the breechblock (lower left side), front toggle link (bottom), rear toggle link (back), receiver (rear), side plate (bottom edge), takedown lever (bottom), trigger (top left), and grips (inside).

INTERESTING VARIATIONS

There are no notable variations of this model.

MARKINGS

MARK LOCATION/DESCRIPTION



Toggle
Manufacturer's Logo



Toggle or Receiver
Commercial Proof

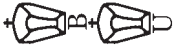

Barrel
German Commercial Proof

VALUES

POOR	FAIR	GOOD	VG	EXC
\$2,000	\$2,800	\$5,000	\$7,500	\$10,000

Look-Up Index # 6

1900 SWISS COMMERCIAL



BACKGROUND

The 1900 Swiss Commercial model was made specifically for commercial sales in Switzerland.

HOW TO TELL A 1900 SWISS COMMERCIAL

The 1900 Swiss Commercial can be distinguished from other Lugers by four features in combination.

1. Early, dished style toggle knobs.
2. DWM marked toggle.
3. Cross in Sunburst crest inscription above the chamber.
4. Serial number OUTSIDE THE RANGE 2001-5000.

QUANTITY MADE

Approximately 2,000.

RARITY RATING

6, Rare.

FEATURES IN DEPTH

MANUFACTURER: This model was manufactured by DWM (Deutsche Waffen and Munitionsfabriken) of Berlin.

TOGGLE: This model should have the early-type toggle with the dished toggle knobs and the toggle lock mechanism.

TOGGLE MARK: 

BARREL: This model should have a 4¾-inch (120mm) barrel with a slim, tapered look. It should be chambered for 7.65mm (.30 Luger).

FRAME: The frame on this model should be the early, long type with a grip safety, narrow trigger and wide trigger guard.

RECEIVER: The receiver on this model should be the early, long type. The chamber should be marked with the Swiss Cross in Sunburst inscription.

THUMB SAFETY: The thumb safety on this model should have a checkered safety lever. The lower position is polished (not blued). Safe is in the upper position.

SIGHTS: The front sight on this model should be a saw tooth shaped blade, dovetail fit on the barrel. The rear sight should be a fixed V notch in the rear toggle link.

EXTRACTOR: The extractor on this model should be the early-type. It should be unmarked.

GRIPS: The grips on this model should be checkered walnut. The left grip should be slotted for the grip safety.

MAGAZINE: The magazines original to this model should have a nickel-plated, wrap-around body. It should have a wood base with a metal insert. They should not be serial numbered or proof marked.

FINISH: The main finish on this model should be a high-quality rust blue. The ejector, extractor, magazine catch/release, takedown lever, thumb safety lever, toggle lock and trigger should all be straw colored.

SERIAL NUMBER RANGE:

01 to 21250, 5001 a to 5100 a.

Note that all commercial 1900 models (the American Eagle, Commercial, and Swiss) will be found within the 1 to approximately 21220 serial number range.

SERIAL NUMBER LOCATION: The full serial number is found on the bottom of the barrel and on the front of the frame. The last two digits of the serial number are on the breechblock (lower left side), front toggle link (bottom), rear toggle link (back), receiver (rear), side plate (bottom edge), takedown lever (bottom), trigger (top left), grip safety (under grip) and grips (inside).

INTERESTING VARIATIONS

At least one example of this model has been reported with an usually wide trigger.

MARKINGS

MARK LOCATION/DESCRIPTION



Toggle
Manufacturer's Logo



Toggle or Receiver
Commercial Proof

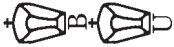

Barrel
German Commercial Proof

VALUES

POOR	FAIR	GOOD	VG	EXC
\$1,000	\$1,500	\$2,500	\$4,000	\$5,000

Look-Up Index # 7

1900 SWISS MILITARY

BACKGROUND

The 1900 Swiss Military model was made specifically for military contract sales to Switzerland.

HOW TO TELL A 1900 SWISS MILITARY

The 1900 Swiss Military can be distinguished from other Lugers by four features in combination.

1. Early, dished style toggle knobs.
2. DWM marked toggle.
3. Cross in Sunburst crest inscription above the chamber.
4. Serial number in the range 2001-5000.

QUANTITY MADE

3,000.

RARITY RATING

5. Somewhat rare.

FEATURES IN DEPTH

MANUFACTURER: This model was manufactured by DWM (Deutsche Waffen and Munitionsfabriken) of Berlin.

TOGGLE: This model should have the early-type toggle with the dished toggle knobs and the toggle lock mechanism.

TOGGLE MARK: 

BARREL: This model should have a 4¾-inch (120mm) barrel with a slim, tapered look. It should be chambered for 7.65mm (.30 Luger).

FRAME: The frame on this model should be the early, long type with a grip safety, narrow trigger and wide trigger guard.

RECEIVER: The receiver on this model should be the early, long type. The chamber should be marked with the Swiss Cross in Sunburst inscription.

THUMB SAFETY: The thumb safety on this model should have a checkered safety lever. The lower position is polished (not blued). Safe is in the upper position.

SIGHTS: The front sight on this model should be a saw tooth shaped blade, dovetail fit on the barrel. The rear sight should be a fixed V notch in the rear toggle link.

EXTRACTOR: The extractor on this model should be the early-type. It should be unmarked.

GRIPS: The grips on this model should be checkered walnut. The left grip should be slotted for the grip safety.

MAGAZINE: The magazines original to this model should have a nickel-plated, wrap-around body. It should have a wood base with a metal insert. They should not be serial numbered or proof marked.

FINISH: The main finish on this model should be a high-quality rust blue. The ejector, extractor, magazine catch/release, takedown lever, thumb safety lever, toggle lock and trigger should all be straw colored.

SERIAL NUMBER RANGE: 2001-5000.

SERIAL NUMBER LOCATION: The full serial number is found on the bottom of the barrel and on the front of the frame. The last three digits of the serial number are on the rear toggle link. The last two digits of the serial number are on the breechblock (lower left side), front toggle link (bottom), receiver (rear), side plate (bottom edge), takedown lever (bottom), trigger (top left), grip safety (under grip) and grips (inside).

INTERESTING VARIATIONS

Some examples are found marked with a "P"(for prevat, meaning private) and a two-digit year. These marks indicate a gun that was released by the Swiss police or military and the date of release.

Two rework features can occasionally be found, either individually or together. One is a reworked U cut rear sight. The other is a Swiss replaced extractor. Either feature will have a Swiss cross proof.

An example of what would be called a 1902 Swiss (9mm Parabellum) is reported. This specimen is either a

rare example of a factory 1902 Pattern Luger with Swiss markings, or it is a rebarreled 1900 Swiss.

MARKINGS

MARK LOCATION/DESCRIPTION



Toggle
Manufacturer's Logo



Toggle or Receiver
Commercial Proof

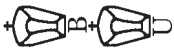

Barrel
German Commercial Proof



Barrel & Receiver
Swiss Rework Proof



Receiver Rework Proof for
Swiss Inspectors
Herr Vogelsang
or



Herr Nievergelt
or



Colonel Muhlemann

VALUES

POOR	FAIR	GOOD	VG	EXC
\$1,000	\$1,500	\$2,500	\$4,000	\$5,500

Look-Up Index # 8

1900 AMERICAN EAGLE COMMERCIAL



BACKGROUND

The 1900 American Eagle Commercial model was made specifically for commercial sales in the United States.

HOW TO TELL A 1900 AMERICAN EAGLE COMMERCIAL

The 1900 American Eagle Commercial can be distinguished from other Lugers by four features in combination.

1. Early, dished style toggle knobs.
2. US Eagle inscription above the chamber.
3. Serial number in the range 2000-20000.
4. Frame marked "MADE IN GERMANY" or just "GERMANY."

QUANTITY MADE

6,000 to 8,000.

RARITY RATING

4, Scarce.

FEATURES IN DEPTH

MANUFACTURER: This model was manufactured by DWM (Deutsche Waffen and Munitionsfabriken) of Berlin.

TOGGLE: This model should have the early-type toggle with the dished toggle knobs and the toggle lock mechanism.

TOGGLE MARK: 

BARREL: This model should have a 4¾-inch (120mm) barrel with a slim, tapered look. It should be chambered for 7.65mm (.30 Luger).

FRAME: The frame on this model should be the early, long type with a grip safety, narrow trigger and wide trigger guard. It should be marked "MADE IN GERMANY" or just "GERMANY," indicating export and sale in the US.

RECEIVER: The receiver on this model should be the early, long type. The chamber should be marked with a US Eagle inscription.

THUMB SAFETY: The thumb safety on this model should have a serrated safety lever. The lower position is polished (not blued). Safe is in the upper position.

SIGHTS: The front sight on this model should be a saw tooth shaped blade, dovetail fit on the barrel. The rear sight should be a fixed V notch in the rear toggle link.

EXTRACTOR: The extractor on this model should be the early-type. It should be unmarked.

GRIPS: The grips on this model should be checkered walnut. The left grip should be slotted for the grip safety.

MAGAZINE: The magazines original to this model should have a nickel-plated, wrap-around body with a wood base. They should not be serial numbered or proof marked.

FINISH: The main finish on this model should be a high-quality rust blue. The ejector, extractor, magazine

catch/release, takedown lever, thumb safety lever, toggle lock and trigger should all be straw colored.

SERIAL NUMBER RANGE: 2000 to 20000.



Note that all commercial 1900 models (the American Eagle, Commercial, and Swiss) will be found within the 1 to approximately 21220 serial number range.

SERIAL NUMBER LOCATION: The full serial number is found on the bottom of the barrel and on the front of the frame. The last two digits of the serial number are on the breechblock (lower left side), front toggle link (bottom), rear toggle link (back), receiver (rear), side plate (bottom edge), takedown lever (bottom), trigger (top left), grip safety (under grip) and grips (inside).

INTERESTING VARIATIONS

See the 1900 American Eagle Military trial variation below.

MARKINGS

MARK	LOCATION/DESCRIPTION
	Toggle Manufacturer's Logo
	Toggle or Receiver Commercial Proof
	Barrel German Commercial Proof

VALUES

POOR	FAIR	GOOD	VG	EXC
\$1,000	\$1,500	\$2,000	\$3,500	\$4,500

Look-Up Index # 9

1900 AMERICAN EAGLE MILITARY

BACKGROUND

The US Military for test trials purchased the 1900 American Eagle Military model. It lost to a Colt-made John Browning design. The 1,000 Luger pistols were sold as surplus.

HOW TO TELL A 1900 AMERICAN EAGLE MILITARY

The 1900 American Eagle Military can be distinguished from other Lugers by four features in combination.

1. Early, dished style toggle knobs.
2. US Eagle inscription above the chamber.
3. Serial number in the range 6100-7100 or 7200-7300.
4. Frames NOT marked "Germany" or "Made in Germany."

QUANTITY MADE

1,000.

RARITY RATING

7, Very rare.

FEATURES IN DEPTH

MANUFACTURER: This model was manufactured by DWM (Deutsche Waffen and Munitionsfabriken) of Berlin.

TOGGLE: This model should have the early-type toggle with the dished toggle knobs and the toggle lock mechanism.

TOGGLE MARK: 

BARREL: This model should have a 4¾-inch (120mm) barrel with a slim, tapered look. It should be chambered for 7.65mm (.30 Luger).

FRAME: The frame on this model should be the early, long type with a grip safety, narrow trigger and wide trigger guard.

RECEIVER: The receiver on this model should be the early, long type. The chamber should be marked with a US Eagle inscription.

THUMB SAFETY: The thumb safety on this model should have a checkered safety lever. The lower position is polished (not blued). Safe is in the upper position.

SIGHTS: The front sight on this model should be a saw tooth shaped blade, dovetail fit on the barrel. The rear sight should be a fixed V notch in the rear toggle link.

EXTRACTOR: The extractor on this model should be the early-type. It should be unmarked.

GRIPS: The grips on this model should be checkered walnut. The left grip should be slotted for the grip safety.

MAGAZINE: The magazines original to this model should have a nickel-plated, wrap-around body with a wood base. They should not be serial numbered or proof marked.

FINISH: The main finish on this model should be a high-quality rust blue. The ejector, extractor, magazine catch/release, takedown lever, thumb safety lever, toggle lock and trigger should all be straw colored.

SERIAL NUMBER RANGE: 6100 to 7100 range.

SERIAL NUMBER LOCATION: The full serial number is found on the bottom of the barrel and on the front of the

INTERESTING VARIATIONS

Those 1900 Bulgarians rebarreled were so done during their service in Bulgaria. These represent a genuine, historical valid variation of an already hard-to-find model of the Luger.

MARKINGS

MARK	LOCATION/DESCRIPTION
------	----------------------



	Toggle Manufacturer's Logo
--	-------------------------------

VALUES

POOR	FAIR	GOOD	VG	EXC
9mm Parabellum				
\$1,500	\$2,000	\$3,750	\$6,000	\$8,000
7.65mm				
\$1,750	\$2,500	\$5,000	\$8,000	\$12,500

Look-Up Index # 11

1900 CARBINE

BACKGROUND

The 1900 Carbine model remains mysterious. Only serial number 58 is known. Speculation ranges from commercial, presentation or prototype. The unique adjustable rear sight is what sets this Luger apart.

HOW TO TELL A 1900 CARBINE

The 1900 Carbine can be distinguished from other Lugers by three features in combination.

1. Early, dished style toggle knobs.
2. 11¼-inch barrel with a walnut forearm.
3. Adjustable rear sight located at the rear of the toggle assembly.

QUANTITY MADE

Estimated at less than 100.

RARITY RATING

9, Nearly unique. Only one is known.

FEATURES IN DEPTH

MANUFACTURER: This model was manufactured by DWM (Deutsche Waffen and Munitionsfabriken) of Berlin.

TOGGLE: This model should have the early-type toggle with the dished toggle knobs and the toggle lock mechanism. It should have Georg Luger's distinct intertwined "GL" initials on the rear toggle link.

TOGGLE MARK: 

BARREL: This model should have an 11¼-inch barrel with a walnut forearm. It should be chambered for 7.65mm (.30 Luger).

FRAME: The frame on this model should be the early, long type with an extension below the barrel (for the forearm), grip safety, stock lug, narrow trigger and wide trigger guard.

RECEIVER: The receiver on this model should be the early, long type. The chamber should be blank.

THUMB SAFETY: The thumb safety on this model should have a checkered safety lever. The lower position is polished (not blued). Safe is in the upper position.

SIGHTS: The front sight on this model should be a dorsal fin shaped blade, dovetail fit on the barrel. The rear sight should be a five-position adjustable V notch located on the rear toggle link.

EXTRACTOR: The extractor on this model should be the early-type. It should be unmarked.

GRIPS: The grips on this model should be checkered walnut. The left grip should be slotted for the grip safety.

FOREARM: This model has a checkered walnut forearm with a sling swivel.

MAGAZINE: The magazines original to this model should have a nickel-plated, wrap-around body with a wood base. They should not be serial numbered or proof marked.

FINISH: The main finish on this model should be a high-quality rust blue. The ejector, extractor, magazine catch/release, takedown lever, thumb safety lever, toggle lock and trigger should all be straw colored.

SERIAL NUMBER RANGE: 1 to two digits.

SERIAL NUMBER LOCATION: The full serial number is found on the bottom of the barrel, on the front of the frame, and on the forearm extension. The last two digits of the serial number are on the breechblock (lower left side), front toggle link (bottom), rear toggle link (back), receiver (rear), side plate (bottom edge), takedown lever (bottom), trigger (top left), grip safety (under grip) and grips (inside).

INTERESTING VARIATIONS

There are no notable variations of this model.

MARKINGS

MARK **LOCATION/DESCRIPTION**



Toggle
Manufacturer's Logo

VALUES

This model is too rare to price.

Look-Up Index # 12

1900 MEXICAN TEST

BACKGROUND

The 1900 Mexican Test model was made specifically for Mexican military test trials of the new pistol design.

HOW TO TELL A 1900 MEXICAN TEST

The 1900 Mexican Test can be distinguished from other Lugers by one distinct feature.

1. The left side of the frame is marked "EJERCITO MEXICANO."

QUANTITY MADE

Approximately 200

RARITY RATING

7, Very rare. Only four are known.

FEATURES IN DEPTH

MANUFACTURER: This model was manufactured by DWM (Deutsche Waffen and Munitionsfabriken) of Berlin.

TOGGLE: This model should have the early-type toggle with the dished toggle knobs and the toggle lock mechanism.

TOGGLE MARK: 

BARREL: This model should have a 4¾-inch (120mm) barrel with a slim, tapered look. It should be chambered for 7.65mm (.30 Luger).

FRAME: The frame on this model should be the early, long type with a grip safety, narrow trigger and wide trigger guard. The left side is marked "EJERCITO MEXICANO."

RECEIVER: The receiver on this model should be the early, long type. The chamber should be blank.

THUMB SAFETY: The thumb safety on this model should have a serrated safety lever. The lower position is polished (not blued). Safe is in the upper position.

SIGHTS: The front sight on this model should be a saw tooth shaped blade, dovetail fit on the barrel. The rear sight should be a fixed V notch in the rear toggle link.

EXTRACTOR: The extractor on this model should be the early-type. It should be unmarked.

GRIPS: The grips on this model should be checkered walnut. The left grip should be slotted for the grip safety.

MAGAZINE: The magazines original to this model should have a nickel-plated, wrap-around body with a wood base. They should not be serial numbered or proof marked.

FINISH: The main finish on this model should be a high-quality rust blue. The ejector, extractor, magazine catch/release, takedown lever, thumb safety lever, toggle lock and trigger should all be straw colored.

SERIAL NUMBER RANGE: 12800 to 13000.

Note that all commercial 1900 models will be found within the 1 to approximately 21220 serial number range.

SERIAL NUMBER LOCATION: The full serial number is found on the bottom of the barrel and on the front of the frame. The last two digits of the serial number are on the breechblock (lower left side), front toggle link (bottom), rear toggle link (back), receiver (rear), side plate (bottom edge), takedown lever (bottom), trigger (top left), grip safety (under grip) and grips (inside).

INTERESTING VARIATIONS

There are no notable variations of this model.

MARKINGS

MARK **LOCATION/DESCRIPTION**



Toggle
Manufacturer's Logo



Toggle or Receiver
Commercial Proof



Barrel
German Commercial Proof

VALUES

POOR	FAIR	GOOD	VG	EXC
\$1,500	\$2,000	\$2,750	\$5,000	\$7,500

Look-Up Index # 13

1902 PROTOTYPE

BACKGROUND

The 1902 Prototype model is really a group of different prototypes. Each has a different barrel length. It appears to have been a test series of pistols for the new 9mm Parabellum round.

HOW TO TELL A 1902 PROTOTYPE

The 1902 Prototype can be distinguished from other Lugers by three features in combination.

1. Early, dished style toggle knobs.
2. Chambered for 9mm Parabellum.
3. Devoid of proof marks.

QUANTITY MADE

Less than 10, each one unique.

RARITY RATING

9, Nearly unique.

FEATURES IN DEPTH

MANUFACTURER: This model was manufactured by DWM (Deutsche Waffen and Munitionsfabriken) of Berlin.

TOGGLE: This model should have the early-type toggle with the dished toggle knobs and the toggle lock mechanism.

TOGGLE MARK: 

BARREL: This model is found with several barrel lengths chambered in 9mm Parabellum (4-inch , 4³/₄-inch , 5 7/8-inch, 6-inch). There is also a 4-inch barrel example known chambered for 7.65mm (.30 Luger).

FRAME: The frame on this model should be either an early short or long type (it will always match the receiver). It will have a unique grip safety, narrow trigger and wide trigger guard.

RECEIVER: The receiver on this model should be either the early short or long type (it will always match the frame). The chamber should be unmarked.

THUMB SAFETY: The thumb safety on this model should have a serrated safety lever. The lower position is polished (not blued). Safe is in the upper position.

SIGHTS: The front sight on this model should be a dorsal fin shaped blade, dovetail fit on the barrel. The rear sight should be a fixed V notch in the rear toggle link.

EXTRACTOR: The extractor on this model should be the early-type. It should be unmarked.

GRIPS: The grips on this model should be checkered walnut. The left grip should be slotted for the grip safety.

MAGAZINE: The magazines original to this model should have a nickel-plated, wrap-around body with a wood base. They should not be serial numbered or proof marked.

FINISH: The main finish on this model should be a high-quality rust blue. The ejector, extractor, magazine catch/release, takedown lever, thumb safety lever, toggle lock and trigger should all be straw colored.

SERIAL NUMBER RANGE: In the low 10000 with a “B” or “C” suffix.

SERIAL NUMBER LOCATION: The full serial number is found on the bottom of the barrel and on the front of the frame. The last two digits of the serial number are on the breechblock (lower left side), front toggle link (bottom), rear toggle link (back), receiver (rear), side plate (bottom edge), takedown lever (bottom), trigger (top left), grip safety (under grip) and grips (inside).

INTERESTING VARIATIONS

Less than 10 examples are reported in 7.65mm that resemble the fatter 9mm barrel more than they do the previously slim 7.65mm barrel. These barrels are identical to the new thick barrel used on the 1903 Commercial pistols (see below). It is likely that this variation was a transition to that later model.

MARKINGS

MARK	LOCATION/DESCRIPTION
------	----------------------



Toggle
Manufacturer's Logo

VALUES

POOR	FAIR	GOOD	VG	EXC
\$12,000	\$15,000	\$20,000	\$25,000	\$30,000

Look-Up Index # 14

1902 COMMERCIAL

BACKGROUND

The 1902 Commercial model was made for commercial sales in Germany. This model was the basis for the 9mm Parabellum Luger that soon began to take root in military and commercial circles through out the world.

HOW TO TELL A 1902 AMERICAN EAGLE

The 1902 American Eagle can be distinguished from other Lugers by four features in combination.

1. Early, dished style toggle knobs.
2. US Eagle inscription above the chamber.
3. Serial number in the range 22300-22400 and 22900-23500.
4. Chambered for 9mm Parabellum.

QUANTITY MADE

600-700.

RARITY RATING

7, Very rare.

FEATURES IN DEPTH

MANUFACTURER: This model was manufactured by DWM (Deutsche Waffen and Munitionsfabriken) of Berlin.

TOGGLE: This model should have the early-type toggle with the dished toggle knobs and the toggle lock mechanism.

TOGGLE MARK: 

BARREL: This model should have a 4-inch (100mm) barrel with a fat appearance. It should be chambered for 9mm Parabellum.

FRAME: The frame on this model should be the early, short type with a grip safety, narrow trigger and wide trigger guard. It should be marked "MADE IN GERMANY" or just "GERMANY."

RECEIVER: The receiver on this model should be the early, short type. The chamber should be marked with a US Eagle inscription.

THUMB SAFETY: The thumb safety on this model should have a serrated safety lever. The lower position is polished (not blued). Safe is in the upper position.

SIGHTS: The front sight on this model should be a dorsal fin shaped blade, dovetail fit on the barrel. The rear sight should be a fixed V notch in the rear toggle link.

EXTRACTOR: The extractor on this model should be the early-type. It should be unmarked.

GRIPS: The grips on this model should be checkered walnut. The left grip should be slotted for the grip safety.

MAGAZINE: The magazines original to this model should have a nickel-plated, wrap-around body with a wood base. They should not be serial numbered or proof marked. The base should be marked "".

FINISH: The main finish on this model should be a high-quality rust blue. The ejector, extractor, magazine catch/release, takedown lever, thumb safety lever, toggle lock and trigger should all be straw colored.

SERIAL NUMBER RANGE: 22100 to 22400 and 22451 to 23362. Both the 1902 Commercial and the 1902 American Eagle can be found throughout the 22100 to 23500 serial number range.

SERIAL NUMBER LOCATION: The full serial number is found on the bottom of the barrel and on the front of the frame. The last two digits of the serial number are on the breechblock (lower left side), front toggle link (bottom), rear toggle link (back), receiver (rear), side plate (bottom edge), takedown lever (bottom), trigger (top left), grip safety (under grip) and grips (inside).

INTERESTING VARIATIONS

See the 1902 American Eagle Cartridge Counter model below.

MARKINGS

MARK	LOCATION/DESCRIPTION
------	----------------------



Toggle
Manufacturer's Logo



Toggle or Receiver
Commercial Proof



Barrel
German Commercial Proof

VALUES

POOR	FAIR	GOOD	VG	EXC
\$1,500	\$3,500	\$5,000	\$7,500	\$9,000

Look-Up Index # 16

1902 AMERICAN EAGLE CARTRIDGE COUNTER

BACKGROUND

The 1902 American Eagle Cartridge Counter model was made for US Army evaluation and test. It should be noted that the failure of the 1900 American Eagle Military to win US military favor was based in part on the perceived low power of the 7.65mm cartridge it fired. This model indicated Georg Luger's renewed attempt to win a lucrative US military contract.

HOW TO TELL A 1902 AMERICAN EAGLE CARTRIDGE COUNTER

The 1902 American Eagle Cartridge Counter can be distinguished from other Lugers by three features in combination.

1. Early, dished style toggle knobs.
2. US Eagle inscription above the chamber.
3. Serial number in the range 22401-22450.

QUANTITY MADE

50.

RARITY RATING

8, Extremely rare.

FEATURES IN DEPTH

MANUFACTURER: This model was manufactured by DWM (Deutsche Waffen and Munitionsfabriken) of Berlin.

TOGGLE: This model should have the early-type toggle with the dished toggle knobs and the toggle lock mechanism.

TOGGLE MARK: 

BARREL: This model should have a 4-inch (100mm) barrel with a fat appearance. It should be chambered for 9mm Parabellum.

FRAME: The frame on this model should be the early, short type with a grip safety, narrow trigger and wide trigger guard.

RECEIVER: The receiver on this model should be the early, short type. The chamber should be marked with a US Eagle inscription.

THUMB SAFETY: The thumb safety on this model should have a serrated safety lever. Both positions are blued. Safe is in the upper position.

SIGHTS: The front sight on this model should be a dorsal fin shaped blade, dovetail fit on the barrel. The rear sight should be a fixed V notch in the rear toggle link.

EXTRACTOR: The extractor on this model should be the early-type. It should be unmarked.

GRIPS: The grips on this model should be checkered walnut. The left grip should be slotted for the grip safety. The left grip should also have an additional slot cut in it to reveal the numbered metal strip cartridge counter (officially known as the Powell Indicating Device).

MAGAZINE: The magazines original to this model should have a nickel-plated, wrap-around body. The left side of the body should be slotted similar to the left grip for visibility of the remaining ammo. It should have a wood base with a metal insert. They should not be serial numbered or proof marked. The base should be marked "Cal 9 m/m."

FINISH: The main finish on this model should be a high-quality rust blue. The ejector, extractor, magazine catch/release, takedown lever, thumb safety lever, toggle lock and trigger should all be straw colored.

SERIAL NUMBER RANGE: 22401 to 22450.

SERIAL NUMBER LOCATION: The full serial number is found on the bottom of the barrel and on the front of the frame. The last two digits of the serial number are on the breechblock (lower left side), front toggle link (bottom), rear toggle link (back), receiver (rear), side plate (bottom edge), takedown lever (bottom), trigger (top left), grip safety (under grip) and grips (inside).

INTERESTING VARIATIONS

There are no notable variations of this model.

MARKINGS

MARK	LOCATION/DESCRIPTION
	Toggle Manufacturer's Logo

VALUES

POOR	FAIR	GOOD	VG	EXC
\$3,500	\$8,500	\$17,500	\$25,000	\$32,000

Look-Up Index # 17

1902 CARBINE

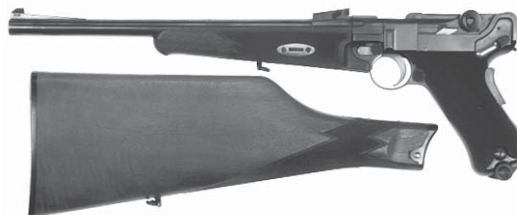

BACKGROUND

The 1902 Carbine model was made for general commercial sales in both Germany and abroad.

HOW TO TELL A 1902 CARBINE

The 1902 Carbine can be distinguished from other Lugers by three features in combination.

1. Early, dished style toggle knobs.
2. 11¾-inch barrel with a walnut forearm.
3. Adjustable rear sight located on the rear of the barrel, just forward of the chamber.

Look-Up Index # 18

1902/06 TRANSITION CARBINE

BACKGROUND

The 1902/06 Transition Carbine model was made for commercial sales in Germany and abroad. It is transitional in that it combines features from before and after the only major Luger pistol redesign.

HOW TO TELL A 1902/06 TRANSITION CARBINE

The 1902/06 Transition Carbine can be distinguished from other Lugers by four features in combination.

1. Late, flat, checkered style toggle knobs.
2. 11¼-inch barrel with a walnut forearm.
3. Adjustable rear sight located on the rear of the barrel, just forward of the chamber.
4. The Crown/B and Crown/U proofs on the left side of the receiver.

QUANTITY MADE

Less than 100.

RARITY RATING

8, Extremely rare.

FEATURES IN DEPTH

MANUFACTURER: This model was manufactured by DWM (Deutsche Waffen and Munitionsfabriken) of Berlin.

TOGGLE: This model should have the late, flat, checkered-type toggle knobs.

TOGGLE MARK: 

BARREL: This model should have an 11¼-inch barrel with a walnut forearm. It should be chambered for 7.65mm (.30 Luger).

FRAME: The frame on this model should be the early, long type with an extension below the barrel (for the forearm), grip safety, stock lug, narrow trigger and wide trigger guard. Some examples were exported to the US and appropriately marked "MADE IN GERMANY" or just "GERMANY."

RECEIVER: The receiver on this model should be the early, long type. The chamber should be blank.

THUMB SAFETY: The thumb safety on this model should have a serrated safety lever. The upper position should be marked "GESICHERT." Safe is in the lower position.

SIGHTS: The front sight on this model should be a bead atop a ramp that is integral with the barrel. The

rear sight should be a four-position adjustable V notch on the rear of the barrel just forward of the chamber.

EXTRACTOR: The extractor on this model should be the late type. It should be marked "GELADEN" on the left side.

GRIPS: The grips on this model should be checkered walnut. The left grip should be slotted for the grip safety.

FOREARM: This model should have a checkered walnut forearm with a sling swivel.

MAGAZINE: The magazines original to this model should have a nickel-plated, wrap-around body with a wood base. They should not be serial numbered or proof marked.

FINISH: The main finish on this model should be a high-quality rust blue. The ejector, extractor, magazine catch/release, takedown lever, thumb safety lever, toggle lock and trigger should all be straw colored.

SERIAL NUMBER RANGE: 23600 to 23700.

SERIAL NUMBER LOCATION: The full serial number is found on the bottom of the barrel and on the front of the frame. The last two digits of the serial number are on the breechblock (lower left side), front toggle link (bottom), rear toggle link (back), receiver (rear), side plate (bottom edge), takedown lever (bottom), trigger (top left), grip safety (under grip) and grips (inside).

INTERESTING VARIATIONS

There are no notable variations of this model.

MARKINGS

MARK	LOCATION/DESCRIPTION
------	----------------------



Toggle
Manufacturer's Logo



Barrel
German Commercial Proof

VALUES

POOR	FAIR	GOOD	VG	EXC
\$3,500	\$6,500	\$8,000	\$10,000	\$15,000

Look-Up Index # 19

1903 DANZIG TEST

BACKGROUND

The 1903 Danzig Test model was made for Germany military evaluation and test. Similar to Luger's failed

attempt to secure a US military contract, the German Army had not been impressed with the earlier 7.65mm Luger pistols. Now that Herr Luger had a cartridge more to the liking of the German army, he was knocking on their door again. Both Mannlicher and Mauser submitted pistols for the tests being conducted at Germany's Danzig Arsenal.

HOW TO TELL A 1903 DANZIG TEST

The 1903 Danzig Test can be distinguished from other Lugers by four features in combination.

1. Early, dished style toggle knobs.
2. No inscription on the toggle.
3. Serial number in the range 22300-22400.
4. Chambered for 9mm Parabellum.

QUANTITY MADE

55.

RARITY RATING

8, Extremely rare.

FEATURES IN DEPTH

MANUFACTURER: This model was manufactured by DWM (Deutsche Waffen and Munitionsfabriken) of Berlin.

TOGGLE: This model should have the early-type toggle with the dished toggle knobs and the toggle lock mechanism.

TOGGLE MARK: The toggle on this model is blank.

BARREL: This model should have a 4-inch (100mm) barrel with a fat appearance. It can be found chambered for either 7.65mm (.30 Luger) or 9mm Parabellum.

FRAME: The frame on this model should be the early, short type with a grip safety, narrow trigger and wide trigger guard.

RECEIVER: The receiver on this model should be the early, short type. The chamber should be blank.

THUMB SAFETY: The thumb safety on this model should have a serrated safety lever. Both positions are blued. Safe is in the upper position.

SIGHTS: The front sight on this model should be a dorsal fin shaped blade, dovetail fit on the barrel. The rear sight should be a fixed V notch in the rear toggle link.

EXTRACTOR: The extractor on this model should be the early-type. It should be unmarked.

GRIPS: The grips on this model should be checkered walnut. The left grip should be slotted for the grip safety.

MAGAZINE: The magazines original to this model should have a nickel-plated, wrap-around body with a wood base. They should not be serial numbered or proof marked. The base may have been marked

"Cal 9 m/m."

FINISH: The main finish on this model should be a high-quality rust blue. The ejector, extractor, magazine catch/release, takedown lever, thumb safety lever, toggle lock and trigger should all be straw colored.

SERIAL NUMBER RANGE: 22300 to 22400.

SERIAL NUMBER LOCATION: The full serial number is found on the bottom of the barrel and on the front of the frame. The last three digits of the serial number are on the rear toggle link. The last two digits of the serial number are on the breechblock (lower left side), front toggle link (bottom), rear toggle link (back), receiver (rear), side plate (bottom edge), takedown lever (bottom), trigger (top left), grip safety (under grip) and grips (inside).

INTERESTING VARIATIONS

Examples with later modifications suggest reuse after the test trials.

MARKINGS

MARK	LOCATION/DESCRIPTION
------	----------------------



Receiver
Danzig Arsenal Proof

VALUES

POOR	FAIR	GOOD	VG	EXC
\$3,000	\$7,500	\$12,500	\$20,000	\$25,000

Look-Up Index # 20

1903 COMMERCIAL

BACKGROUND

The 1903 Commercial model was made specifically for commercial and/or military sales to France.

HOW TO TELL A 1903 COMMERCIAL

The 1903 Commercial can be distinguished from other Lugers by one distinct feature:

1. Late, flat, checkered style toggle knobs WITH the toggle lock mechanism.

A good double check on this model is to examine the extractor for the word "CHARGE" on the left side. One can safely accomplish this by chambering a dummy round or a spent case. Upon closing, the extractor will be pushed up (since it doubles as the loaded chamber indicator).

QUANTITY MADE

Approximately 50.

RARITY RATING

8, Extremely rare.

FEATURES IN DEPTH

MANUFACTURER: This model was manufactured by DWM (Deutsche Waffen and Munitionsfabriken) of Berlin.

TOGGLE: This model should have the late type toggle with the flat, checkered toggle knobs and the toggle lock mechanism.

TOGGLE MARK: 

BARREL: This model should have a 4-inch (100mm) barrel chambered for 7.65mm (.30 Luger).

FRAME: The frame on this model should be the early, short type with a grip safety, narrow trigger and wide trigger guard.

RECEIVER: The receiver on this model should be the late, short type. The chamber should be blank.

THUMB SAFETY: The thumb safety on this model should have a serrated safety lever. The lower position is polished (not blued). Safe is in the upper position.

SIGHTS: The front sight on this model should be a dorsal fin shaped blade, dovetail fit on the barrel. The rear sight should be a fixed V notch in the rear toggle link.

EXTRACTOR: The extractor on this model should be the late type. It should be marked "CHARGE."

GRIPS: The grips on this model should be checkered walnut. The left grip should be slotted for the grip safety.

MAGAZINE: The magazines original to this model should have a nickel-plated, wrap-around body with a wood base. They should not be serial numbered or proof marked.

FINISH: The main finish on this model should be a high-quality rust blue. The ejector, magazine catch/release, takedown lever, thumb safety lever, toggle lock and trigger should all be straw colored.

SERIAL NUMBER RANGE: 25000 to 25050 range.

SERIAL NUMBER LOCATION: The full serial number is found on the bottom of the barrel and on the front of the frame. The last two digits of the serial number are on the breechblock (lower left side), front toggle link (bottom), rear toggle link (back), receiver (rear), side plate (bottom edge), takedown lever (bottom), trigger (top left), grip safety (under grip) and grips (inside).

INTERESTING VARIATIONS

There are no notable variations of this model.

MARKINGS

MARK **LOCATION/DESCRIPTION**



Toggle
Manufacturer's Logo

VALUES

POOR	FAIR	GOOD	VG	EXC
\$2,500	\$3,500	\$5,000	\$10,000	\$12,500

Look-Up Index # 21

SEVEN-SHOT PROTOTYPE

BACKGROUND

The Seven-shot Prototype model was personally built and carried by Georg Luger himself. It bears his distinctive intertwined GL on the rear toggle link.

HOW TO TELL THE 7 SHOT PROTOTYPE

In one respect, the vast majority of us (author included) need never worry about having to identify this pistol as a sleeper that shows up at a gun show. However, hope springs eternal. So here is what your fantasy should contain.

1. Late, flat, checkered-style toggle knobs.
2. Grip safety, but no stock lug.
3. No marks apart from the DWM and the GL on the toggle.
4. Noticeably shortened grip and barrel.
5. Uniquely narrower girth across the toggle knobs.

QUANTITY MADE

Only 1.

RARITY RATING

10, they don't get any more rare than this one!

FEATURES IN DEPTH

MANUFACTURER: This model was manufactured by DWM (Deutsche Waffen and Munitionsfabriken) of Berlin.

TOGGLE: This model should have the new type toggle, with the flat, checkered toggle knobs. The width across the toggle knobs is more narrow than normal.

TOGGLE MARK: 

BARREL: This model should have an 3 1/3-inch (85mm) barrel. It should be chambered for 9mm Parabellum.

FRAME: The frame on this model is a unique prototype. It has been shortened from a normal Luger frame. It has a grip safety, wide trigger and narrow trigger guard.

RECEIVER: The receiver on this model should be a unique, short prototype. The chamber should be blank.

THUMB SAFETY: The thumb safety on this model should have a checkered safety lever. The lower position is polished (not blued). Safe is in the upper position.

SIGHTS: The front sight on this model should be a dorsal fin shaped blade, dovetail fit on the barrel. The rear sight should be a fixed V notch in the rear toggle link.

EXTRACTOR: The extractor on this model should be the early-type. It should be marked "GELADEN."

GRIPS: The grips on this model should be checkered walnut. The left grip should be slotted for the grip safety.

MAGAZINE: The magazine original to this model should have a nickel-plated, wrap-around body with a wood base. The body was shortened to hold only seven rounds. It should not be serial numbered or proof marked.

FINISH: The main finish on this model should be a high-quality rust blue. The ejector, magazine catch/release, takedown lever, thumb safety lever and trigger should all be straw colored.

SERIAL NUMBER RANGE: 10077 B.

SERIAL NUMBER LOCATION: The full serial number is found on the bottom of the barrel and on the front of the frame. The last two digits of the serial number are on the breechblock (lower left side), front toggle link (bottom), rear toggle link (back), receiver (rear), side plate (bottom edge), takedown lever (bottom), trigger (top left), grip safety (under grip) and grips (inside).

INTERESTING VARIATIONS

There are no notable variations of this model.

MARKINGS

MARK	LOCATION/DESCRIPTION
------	----------------------



	Toggle Manufacturer's Logo
--	-------------------------------

VALUES

This model is too rare to price.

Look-Up Index # 22

SEVEN-SHOT BULGARIAN PROTOTYPE

BACKGROUND

The Seven-Shot Bulgarian Prototype model was only recently discovered. It is physically identical to Georg Luger's personal weapon. It differs only in its markings and in the fact that it has a full-width toggle knob. So far, the community of Luger collectors believe this new discovery has providence. Research is ongoing to place this piece into its proper historical relationship.

HOW TO TELL THE SEVEN-SHOT BULGARIAN PROTOTYPE

The Seven-Shot Bulgarian Prototype can be distinguished from other Lugers by four features in combination:

1. Late, flat, checkered style toggle knobs.
2. Grip safety, but no stock lug.
3. The Bulgarian Lion crest on the chamber.
4. Noticeably shortened grip and barrel.

QUANTITY MADE

Only 1.

RARITY RATING

10, they don't get any more rare than this one!

FEATURES IN DEPTH

MANUFACTURER: This model was manufactured by DWM (Deutsche Waffen and Munitionsfabriken) of Berlin.

TOGGLE: This model should have the new type toggle, with the flat, checkered toggle knobs.

TOGGLE MARK: 

BARREL: This model should have an 3 1/3-inch (85mm) barrel. It should be chambered for 9mm Parabellum.

FRAME: The frame on this model is unique. It has been shortened from a normal Luger frame. It has a grip safety, wide trigger and narrow trigger guard.

RECEIVER: The receiver on this model should be a unique short prototype. The chamber should be marked with the Bulgarian Lion crest inscription.

THUMB SAFETY: The thumb safety on this model should have a checkered safety lever. The lower position is polished (not blued). Safe is in the upper position.

SIGHTS: The front sight on this model should be a dorsal fin shaped blade, dovetail fit on the barrel. The rear sight should be a fixed V notch in the rear toggle link.

EXTRACTOR: The extractor on this model should be the early-type. It should be marked in Cyrillic.

GRIPS: The grips on this model should be checkered walnut. The left grip should be slotted for the grip safety.

MAGAZINE: The magazine original to this model should have a nickel-plated, wrap-around body with a wood base. The body was shortened to hold only seven rounds. It should not be serial numbered or proof marked.

FINISH: The main finish on this model should be a high-quality rust blue. The ejector, magazine catch/release, takedown lever, thumb safety lever and trigger should all be straw colored.

SERIAL NUMBER RANGE: Unknown, probably close to 10077 B.

SERIAL NUMBER LOCATION: The full serial number is found on the bottom of the barrel and on the front of the frame. The last two digits of the serial number are on the breechblock (lower left side), front toggle link (bottom), rear toggle link (back), receiver (rear), side plate (bottom edge), takedown lever (bottom), trigger (top left), grip safety (under grip) and grips (inside).

INTERESTING VARIATIONS

There are no notable variations of this model.

MARKINGS

MARK **LOCATION/DESCRIPTION**



Toggle
Manufacturer's Logo

VALUES

This model is too rare to price.

Look-Up Index # 23

1904 NAVY



BACKGROUND

The 1904 Navy model was an interim variation made specifically to satisfy a German Navy request for 2,000 pistols at the earliest opportunity with which to begin training.

HOW TO TELL A 1904 NAVY

The 1904 Navy can be distinguished from other Lugers by three features in combination.

1. Late, flat, checkered style toggle knobs, but with a slot cut on the right one for a toggle lock.
2. 6-inch barrel.
3. Old, wide trigger guard.

QUANTITY MADE

Less than 2000.

RARITY RATING

6, Rare.

FEATURES IN DEPTH

MANUFACTURER: This model was manufactured by DWM (Deutsche Waffen and Munitionsfabriken) of Berlin.

TOGGLE: This model should have the new type toggle, with the flat, checkered toggle knobs and a toggle lock mechanism. The checkering on the toggle knobs is at 90° (perpendicular), whereas the standard Selbstladepestole 1904 (know by collectors as the 1906 Navy) examples were cross-hatched with tiny diamond shapes having 60° and 120° angles.

TOGGLE MARK: 

BARREL: This model should have 6-inch barrel with a fat look. It should be chambered for 9mm Parabellum.

FRAME: The frame on this model should be the early, long type. It should have a grip safety (some are noted without), stock lug, narrow trigger and wide trigger guard.

RECEIVER: The receiver on this model should be the late, long type. The chamber should be blank.

THUMB SAFETY: The thumb safety on this model should have a serrated safety lever. The lower position should be marked "GESICHERT." Safe is in the upper position. Many of these were later reworked to function as safe in the lower position and restamped "GESICHERT" in the upper position. Look carefully for removed, added safety markings.

SIGHTS: The front sight on this model should be a dorsal fin shaped blade, dovetail fit on the barrel. The rear sight should be a two-position adjustable V notch located on the back of the rear toggle link.

EXTRACTOR: The extractor on this model should be the early-type. It should be marked "GELADEN."

GRIPS: The grips on this model should be checkered walnut. The left grip should be slotted for the grip safety.

MAGAZINE: The magazines original to this model should have a nickel-plated, wrap-around body. It should have a wood base with concentric circles cut

RECEIVER: The receiver on this model should be the late, short type. The chamber should be blank.

THUMB SAFETY: The thumb safety on this model should have a serrated safety lever. It is marked "RUST" with a curved arrow pointing to the safe, upper position.

SIGHTS: The front sight on this model should be a dorsal fin shaped blade, dovetail fit on the barrel. The rear sight should be a fixed V notch in the rear toggle link.

EXTRACTOR: The extractor on this model should be the late type. It should be marked "GELADEN" on both sides.

GRIPS: The grips on this model should be checkered walnut. The left grip should be slotted for the grip safety.

MAGAZINE: The magazines original to this model should have a nickel-plated, wrap-around body with a wood base. They should not be serial numbered or proof marked.

FINISH: The main finish on this model should be a high-quality rust blue. The ejector, magazine catch/release, takedown lever, thumb safety lever, and trigger should all be straw colored.

SERIAL NUMBER RANGE: 22200 to 22400 range.

SERIAL NUMBER LOCATION: The full serial number is found on the bottom of the barrel and on the front of the frame. The last two digits of the serial number are on the breechblock (lower left side), front toggle link (bottom), rear toggle link (back), receiver (rear), side plate (bottom edge), takedown lever (bottom), trigger (top left), grip safety (under grip) and grips (inside).

INTERESTING VARIATIONS

Ten of the 9mm Parabellum pistols were serial numbered in the early 10000 range with a B suffix. These will have a few minor breechblock, extractor and grip screw modifications, which are only found on these Dutch Model Lugers.

MARKINGS

MARK	LOCATION/DESCRIPTION
------	----------------------

No specimens of this model have been observed. What little we do came from records.



Toggle
Manufacturer's Logo

VALUES

POOR	FAIR	GOOD	VG	EXC
\$750	\$1,000	\$2,000	\$3,500	\$5,000

Look-Up Index # 25

1906 COMMERCIAL



BACKGROUND

The 1906 Commercial model was generally made for commercial and contract sales both within Germany and abroad.

HOW TO TELL A 1906 COMMERCIAL

The 1906 Commercial can be distinguished from other Lugers by six features in combination.

1. Late, flat, checkered style toggle knobs.
2. The toggle is marked with the scroll DWM logo.
3. Grip safety.
4. No inscription above the chamber.
5. The thumb safety lower position is polished.
6. No inscription along the top of the barrel.

QUANTITY MADE

3,500 to 4,000 in 9mm Parabellum
Approximately 5,000 in 7.65mm.

RARITY RATING

4, Scarce.

FEATURES IN DEPTH

MANUFACTURER: This model was manufactured by DWM (Deutsche Waffen and Munitionsfabriken) of Berlin.

TOGGLE: This model should have the new type toggle, with the flat, checkered toggle knobs.

TOGGLE MARK: 

BARREL: This model should have either a 4-inch (100mm) barrel chambered for 9mm Parabellum, or a 4¾-inch barrel chambered for 7.65mm (.30 Luger).

FRAME: The frame on this model should be the late, short type with a grip safety, wide trigger and narrow trigger guard. A very few were marked "GERMANY" indicating export to the US.

RECEIVER: The receiver on this model should be the late, short type. The chamber should be blank.

THUMB SAFETY: The thumb safety on this model should have a serrated safety lever. The lower position is polished (not blued). Safe is in the upper position.

SIGHTS: The front sight on this model should be a saw tooth shaped blade if chambered for 7.65mm, or a dorsal fin shaped blade if chambered for 9mm. Either one should be dovetail fit on the barrel. The rear sight should be a fixed V notch in the rear toggle link.

EXTRACTOR: The extractor on this model should be the late type. It should be marked "GELADEN" on the left side. A few in 7.65mm are marked "LOADED."

GRIPS: The grips on this model should be checkered walnut. The left grip should be slotted for the grip safety.

MAGAZINE: The magazines original to this model should have a nickel-plated, wrap-around body with a wood base. They should not be serial numbered or proof marked. Some bases on the 9mm examples are marked "Cal 9 m/m."

FINISH: The main finish on this model should be a high-quality rust blue. The ejector, magazine catch/release, takedown lever, thumb safety lever, and trigger should all be straw colored.

SERIAL NUMBER RANGE: 25050 to 69000.

SERIAL NUMBER LOCATION: The full serial number is found on the bottom of the barrel and on the front of the frame. The last two digits of the serial number are on the breechblock (lower left side), extractor (bottom), front toggle link (bottom), rear toggle link (back), receiver (rear), side plate (bottom edge), takedown lever (bottom), trigger (top left), grip safety (under grip) and grips (inside).

INTERESTING VARIATIONS

At least one specimen of this model has been found with a chamber inscription of a French fleur-de-lis over a banner containing the words St. Etienne, and "CHARGÉ" marked on the left side of the extractor. This is thought to be a unique piece for opening the marketing door with Manufacture Francaise d'Armes and Cycles de Saint Etienne. Apparently, these marketing efforts were successful. As proof, see the 1906 Commercial, French Marked model, and catalogs from that firm containing Lugers and holsters.

An authenticated factory cut-away exists of this model.

MARKINGS

MARK LOCATION/DESCRIPTION



Toggle
Manufacturer's Logo



Toggle or Receiver
Commercial Proof



Barrel
German Commercial Proof



Receiver
Nitro Commercial Proof

VALUES

POOR	FAIR	GOOD	VG	EXC
\$750	\$1,200	\$2,000	\$2,500	\$3,500

Look-Up Index # 26

1906 COMMERCIAL, SAFETY MARKED

BACKGROUND

The 1906 Commercial, Safety Marked model was generally made for commercial and contract sales both within Germany and abroad.

HOW TO TELL A 1906 COMMERCIAL, SAFETY MARKED

The 1906 Commercial, Safety Marked can be distinguished from other Lugers by six features in combination.

1. Late, flat, checkered style toggle knobs.
2. The toggle is marked with the scroll DWM logo.
3. Grip safety.
4. No inscription above the chamber.
5. The thumb safety lower position is marked "GESICHERT"
6. No stock lug.

QUANTITY MADE

Approximately 750.

RARITY RATING

7, Very rare.

FEATURES IN DEPTH

MANUFACTURER: This model was manufactured by DWM (Deutsche Waffen and Munitionsfabriken) of Berlin.

TOGGLE: This model should have the new type toggle, with the flat, checkered toggle knobs.

TOGGLE MARK: 

BARREL: This model should have a 4¾-inch (120mm) barrel. It should be chambered for 7.65mm (.30 Luger).

FRAME: The frame on this model should be the late, long type with a grip safety, wide trigger and narrow trigger guard.

RECEIVER: The receiver on this model should be the late, long type. The chamber should be blank.

THUMB SAFETY: The thumb safety on this model should have a serrated safety lever. The lower position is marked "GESICHERT." Safe is in the upper position.

SIGHTS: The front sight on this model should be a saw tooth shaped blade, dovetail fit on the barrel. The rear sight should be a fixed V notch in the rear toggle link.

EXTRACTOR: The extractor on this model should be the late type. It should be marked "GELADEN" on the left side.

GRIPS: The grips on this model should be checkered walnut. The left grip should be slotted for the grip safety.

MAGAZINE: The magazines original to this model should have a nickel-plated, wrap-around body with a wood base. They should not be serial numbered or proof marked.

FINISH: The main finish on this model should be a high-quality rust blue. The ejector, magazine catch/release, takedown lever, thumb safety lever, and trigger should all be straw colored.

SERIAL NUMBER RANGE: 25050 to 26800.

SERIAL NUMBER LOCATION: The full serial number is found on the bottom of the barrel and on the front of the frame. The last two digits of the serial number are on the breechblock (lower left side), extractor (bottom), front toggle link (bottom), rear toggle link (back), receiver (rear), side plate (bottom edge), takedown lever (bottom), trigger (top left), grip safety (under grip) and grips (inside).

INTERESTING VARIATIONS

There are no notable variations of this model.

MARKINGS

MARK **LOCATION/DESCRIPTION**



Toggle
Manufacturer's Logo



Toggle or Receiver
Commercial Proof

VALUES

POOR	FAIR	GOOD	VG	EXC
\$750	\$1,200	\$2,000	\$3,000	\$4,000

Look-Up Index # 27

1906 COMMERCIAL, STOCK LUG

BACKGROUND

The 1906 Commercial, Stock Lug model was generally made for commercial and contract sales both within Germany and abroad.

HOW TO TELL A 1906 COMMERCIAL, STOCK LUG

The 1906 Commercial, Stock Lug can be distinguished from other Lugers by six features in combination.

1. Late, flat, checkered style toggle knobs.
2. The toggle is marked with the scroll DWM logo.
3. Grip safety.
4. No inscription above the chamber.
5. The thumb safety lower position is marked "GESICHERT"
6. Has a stock lug.

QUANTITY MADE

Unknown, but very few.

RARITY RATING

8, Extremely rare.

FEATURES IN DEPTH

MANUFACTURER: This model was manufactured by DWM (Deutsche Waffen and Munitionsfabriken) of Berlin.

TOGGLE: This model should have the new type toggle, with the flat, checkered toggle knobs.

TOGGLE MARK: 

BARREL: This model should have a 4¾-inch (120mm) barrel. It should be chambered for 7.65mm (.30 Luger).

FRAME: The frame on this model should be the late, long type with a grip safety, stock lug, wide trigger and narrow trigger guard. Some were marked "GERMANY" indicating export to the US.

RECEIVER: The receiver on this model should be the late, long type. The chamber should be blank.

THUMB SAFETY: The thumb safety on this model should have a serrated safety lever. The lower position is marked "GESICHERT." Safe is in the upper position.

SIGHTS: The front sight on this model should be a saw tooth shaped blade, dovetail fit on the barrel. The rear sight should be a fixed V notch in the rear toggle link.

EXTRACTOR: The extractor on this model should be the late type. It should be marked "GELADEN" on the left side.

GRIPS: The grips on this model should be checkered walnut. The left grip should be slotted for the grip safety.

MAGAZINE: The magazines original to this model should have a nickel-plated, wrap-around body with a wood base. They should not be serial numbered or proof marked.

FINISH: The main finish on this model should be a high-quality rust blue. The ejector, magazine catch/release, takedown lever, thumb safety lever, and trigger should all be straw colored.

SERIAL NUMBER RANGE: In the 27000 range.

SERIAL NUMBER LOCATION: The full serial number is found on the bottom of the barrel and on the front of the frame. The last two digits of the serial number are on the breechblock (lower left side), extractor (bottom), front toggle link (bottom), rear toggle link (back), receiver (rear), side plate (bottom edge), takedown lever (bottom), trigger (top left), grip safety (under grip) and grips (inside).

INTERESTING VARIATIONS

There are no notable variations of this model.

MARKINGS

MARK	LOCATION/DESCRIPTION
------	----------------------



	Toggle Manufacturer's Logo
--	-------------------------------

VALUES

POOR	FAIR	GOOD	VG	EXC
\$1,000	\$1,500	\$2,250	\$3,500	\$4,200

Look-Up Index # 28

1906 COMMERCIAL, FRENCH MARKED

BACKGROUND

The 1906 Commercial, French Marked model was made specifically for commercial sales in France.

HOW TO TELL A 1906 COMMERCIAL, FRENCH MARKED

The 1906 Commercial, French Marked can be distinguished from other Lugers by one distinct feature.

1. An inscription along the top of the barrel reads "Manufacture Francaise d'Armes and Cycles de Saint-Etienne"

QUANTITY MADE

Very few, only two are reported.

RARITY RATING

9, Nearly unique.

FEATURES IN DEPTH

MANUFACTURER: This model was manufactured by DWM (Deutsche Waffen and Munitionsfabriken) of Berlin.

TOGGLE: This model should have the new type toggle, with the flat, checkered toggle knobs.

TOGGLE MARK: 

BARREL: This model should have a 4¾-inch (120mm) barrel. It should be chambered for 7.65mm (.30 Luger).

FRAME: The frame on this model should be the late, short type with a grip safety, wide trigger and narrow trigger guard.

RECEIVER: The receiver on this model should be the late, short type. The chamber should be blank.

THUMB SAFETY: The thumb safety on this model should have a serrated safety lever. The lower position is polished (not blued). Safe is in the upper position.

SIGHTS: The front sight on this model should be a saw tooth shaped blade, dovetail fit on the barrel. The rear sight should be a fixed V notch in the rear toggle link.

EXTRACTOR: The extractor on this model should be the late type. It should be marked "GELADEN" on the left side.

GRIPS: The grips on this model should be checkered walnut. The left grip should be slotted for the grip safety.

MAGAZINE: The magazines original to this model should have a nickel-plated, wrap-around body with a wood base. They should not be serial numbered or proof marked.

FINISH: The main finish on this model should be a high-quality rust blue. The ejector, magazine catch/release, takedown lever, thumb safety lever, and trigger should all be straw colored.

SERIAL NUMBER RANGE: In the 51000 range.



SERIAL NUMBER LOCATION: The full serial number is found on the bottom of the barrel and on the front of the frame. The last two digits of the serial number are

on the breechblock (lower left side), extractor (bottom), front toggle link (bottom), rear toggle link (back), receiver (rear), side plate (bottom edge), takedown lever (bottom), trigger (top left), grip safety (under grip) and grips (inside).

INTERESTING VARIATIONS

There are no notable variations of this model.

MARKINGS

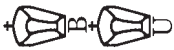
MARK	LOCATION/DESCRIPTION
	Toggle Manufacturer's Logo
	Toggle or Receiver Commercial Proof
	Barrel German Commercial Proof

VALUES

POOR	FAIR	GOOD	VG	EXC
\$800	\$1,200	\$2,000	\$2,500	\$3,500

Look-Up Index # 29

1906 PRESENTATION

BACKGROUND

The 1906 Presentation examples were personally made by Georg Luger (evidenced by the intertwined "GL" on the rear toggle link) for presentation to specific individuals. The initials of the receiving person were inscribed with gold inlay above the chamber.

HOW TO TELL A 1906 PRESENTATION

The 1906 Presentation can be distinguished from other Lugers by three features in combination.

1. Late, flat, checkered style toggle knobs.
2. 4-inch barrel length.
3. A gold inlay inscription found over the chamber.

QUANTITY MADE

Extremely few.

RARITY RATING

9, Nearly unique.

FEATURES IN DEPTH

MANUFACTURER: This model was manufactured by DWM (Deutsche Waffen and Munitionsfabriken) of Berlin.

TOGGLE: This model should have the new type toggle, with the flat, checkered toggle knobs. It should be marked with an intertwined "GL" on the rear toggle link.

TOGGLE MARK: 

BARREL: This model should have a 4-inch (100mm) barrel. It should be chambered for 9mm Parabellum.

FRAME: The frame on this model should be the late, short type with a grip safety, wide trigger and narrow trigger guard.

RECEIVER: The receiver on this model should be the late, short type. The chamber should be inscribed with the gold inlaid initials of the intended recipient.

THUMB SAFETY: The thumb safety on this model should have a serrated safety lever. The lower position is polished (not blued). Safe is in the upper position.

SIGHTS: The front sight on this model should be a dorsal fin shaped blade, dovetail fit on the barrel. The rear sight should be a fixed V notch in the rear toggle link.

EXTRACTOR: The extractor on this model should be the late type. It should be marked "GELADEN" on the left side.

GRIPS: The grips on this model should be checkered walnut. The left grip should be slotted for the grip safety.

MAGAZINE: The magazines original to this model should have a nickel-plated, wrap-around body with a wood base. They should not be serial numbered or proof marked.

FINISH: The main finish on this model should be a high-quality rust blue. The ejector, magazine catch/release, takedown lever, thumb safety lever, and trigger should all be straw colored.

SERIAL NUMBER RANGE: In the 10000 B prototype range.

SERIAL NUMBER LOCATION: The full serial number is found on the bottom of the barrel and on the front of the frame. The last two digits of the serial number are on the breechblock (lower left side), extractor (bottom), front toggle link (bottom), rear toggle link (back), receiver (rear), side plate (bottom edge), takedown lever (bottom), trigger (top left), grip safety (under grip) and grips (inside).

INTERESTING VARIATIONS

Each specimen of this model is unique regarding the initials above the chamber.

MARKINGS

MARK **LOCATION/DESCRIPTION**



Toggle
Manufacturer's Logo

VALUES

POOR	FAIR	GOOD	VG	EXC
\$6,000	\$7,500	\$10,000	\$15,000	\$18,000

Look-Up Index # 30

1906 NAVY MILITARY, 1st ISSUE



BACKGROUND

The 1906 Navy Military, 1st Issue model was made specifically for military sales to the German navy. The 1906 designation in the name is based on the date these were delivered to the navy. However, the official Germany Navy designation of these was the Selbstladepestole 1904 (Self Loading Pistol, model of 1904). Then in early 1907, the official designation was changed to Pistole 1904.

HOW TO TELL A 1906 NAVY MILITARY, 1st ISSUE

The 1906 Navy Military, 1st Issue can be distinguished from other Lugers by four features in combination.

1. Late, flat, checkered style toggle knobs, not slotted on the right.
2. Military Crown/M proofs.
3. Thumb safety lower position **ORIGINALLY** marked "GESICHERT."
4. Has a grip safety.

A key thing to know about navy model Lugers is the look of an originally marked "GESICHERT" on the thumb safety indicator. Many were later reworked and remarked to be safe in the lower position (and therefore marked "GESICHERT" in the upper position. Others were made

safe with the lever down from the factory (see the 1906 Military, 2nd Issue model). Learn to look for a different typeface of stamping, evidence of removal of a previous inscription, etc.

QUANTITY MADE

20,000.

RARITY RATING

6, Rare. Even though a larger number of this variation was made, most had the thumb safety converted to the 2nd Issue variation.

FEATURES IN DEPTH

MANUFACTURER: This model was manufactured by DWM (Deutsche Waffen and Munitionsfabriken) of Berlin.

TOGGLE: This model should have the new type toggle, with the flat, checkered toggle knobs.

TOGGLE MARK: 

BARREL: This model should have a six-inch barrel. It should be chambered for 9mm Parabellum.

FRAME: The frame on this model should be the late, short type with a grip safety, stock lug, wide trigger and narrow trigger guard.

RECEIVER: The receiver on this model should be the late, short type. The chamber should be blank.

THUMB SAFETY: The thumb safety on this model should have a serrated safety lever. The lower position is marked "GESICHERT." Safe is in the upper position.

SIGHTS: The front sight on this model should be a dorsal fin shaped blade, dovetail fit on the barrel. The rear sight should be a two-position adjustable V notch located on the rear toggle link. The rear sight adjusts to 100- or 200-meter positions.

EXTRACTOR: The extractor on this model should be the late type. It should be marked "GELADEN" on the left side.

GRIPS: The grips on this model should be checkered walnut. The left grip should be slotted for the grip safety.

MAGAZINE: The magazines original to this model should have a nickel-plated, wrap-around body. It should have a wood base with concentric circles cut into each side. They should be proof marked and serial numbered to the pistol.

FINISH: The main finish on this model should be a high-quality rust blue. The ejector, magazine catch/release, takedown lever, thumb safety lever, and trigger should all be straw colored.

SERIAL NUMBER RANGE: 1 to 9999 a range.

SERIAL NUMBER LOCATION: The full serial number is found on the bottom of the barrel and on the front of





the frame. The last two digits of the serial number are on the breechblock (lower left side), extractor (bottom), front toggle link (bottom), rear toggle link (back), receiver (rear), side plate (bottom edge), takedown lever (bottom), trigger (top left), grip safety (under grip) and grips (inside).

INTERESTING VARIATIONS

More often than not, when specimens are encountered they have had the safety altered to the newer configuration of safety engaged with the lever in the lower position. One should inspect the uniformity and case of the GESICHERT to differentiate a reworked 1st Issue from a 2nd Issue 1906 Navy Military.

There were 12 German Navy Lugers confiscated by the Dutch when submarine UC-8 ran aground on Terschelling Island in November 1915. These 12 pistols were subsequently pressed into service (along with 28 newly purchased pistols. See the 1918 Dutch Navy Model for details) by Dutch Naval Artillery. These would likely have both German naval and Dutch unit marks.

MARKINGS

MARK	LOCATION/DESCRIPTION
	Toggle Manufacturer's Logo
	Barrel Imperial Navy Proof Mark
	Barrel Imperial Navy Proof Mark
	Receiver Imperial Navy Acceptance Mark
	Receiver Imperial Navy Acceptance Mark

VALUES

POOR	FAIR	GOOD	VG	EXC
\$1,000	\$1,500	\$2,500	\$4,800	\$6,500

Look-Up Index # 31

1906 NAVY MILITARY, 2nd ISSUE

BACKGROUND

The 1906 Navy Military, 2nd Issue model was made specifically for military sales to the German navy. It differs from the 1st Issue model by the thumb safety arrangement.

HOW TO TELL A 1906 NAVY MILITARY, 2nd ISSUE

The 1906 Navy Military, 2nd Issue can be distinguished from other Lugers by four features in combination.

1. Late, flat, checkered style toggle knobs, not slotted on the right.
2. Military Crown/M proofs.
3. Thumb safety upper position **ORIGINALLY** marked "GESICHERT."
4. Has a grip safety.

If the "GESICHERT" looks like it could have been added at a point after manufacture, or there is evidence that it was once stamped in the lower position, this may actually be a 1st Issue rework, or even a 1904 Navy rework.

QUANTITY MADE

Approximately 1,000.

RARITY RATING

7, Very rare.

FEATURES IN DEPTH

MANUFACTURER: This model was manufactured by DWM (Deutsche Waffen and Munitionsfabriken) of Berlin.

TOGGLE: This model should have the new type toggle, with the flat, checkered toggle knobs.

TOGGLE MARK: 

BARREL: This model should have a six-inch barrel. It should be chambered for 9mm Parabellum.

FRAME: The frame on this model should be the late, short type with a grip safety, stock lug, wide trigger and narrow trigger guard.

RECEIVER: The receiver on this model should be the late, short type. The chamber should be blank.

THUMB SAFETY: The thumb safety on this model should have a serrated safety lever. The position is marked "GESICHERT." Safe is in the lower position. The safe position change is the difference between the 1st and 2nd Issue models.

SIGHTS: The front sight on this model should be a dorsal fin shaped blade, dovetail fit on the barrel. The rear sight should be a two-position adjustable V notch located on the back of the rear toggle link.

EXTRACTOR: The extractor on this model should be the late type. It should be marked "GELADEN" on the left side.

GRIPS: The grips on this model should be checkered walnut. The left grip should be slotted for the grip safety.

MAGAZINE: The magazines original to this model should have a nickel-plated, wrap-around body. It should have a wood base with concentric circles cut into each side. They should be proof marked and serial numbered to the pistol.

FINISH: The main finish on this model should be a high-quality rust blue. The ejector, magazine catch/release, takedown lever, thumb safety lever, and trigger should all be straw colored.

SERIAL NUMBER RANGE: 1 b to 1000 b.

SERIAL NUMBER LOCATION: The full serial number is found on the bottom of the barrel and on the front of the frame. The last two digits of the serial number are on the breechblock (lower left side), extractor (bottom), front toggle link (bottom), rear toggle link (back), receiver (rear), side plate (bottom edge), takedown lever (bottom), trigger (top left), grip safety (under grip) and grips (inside).

INTERESTING VARIATIONS

One should inspect the uniformity and case of the GESICHERT to differentiate a reworked 1st Issue from a 2nd Issue 1906 Navy Military.

One reported with a backstrap mark "1 MD" over "41."

MARKINGS

MARK LOCATION/DESCRIPTION



Toggle
Manufacturer's Logo



Barrel
Imperial Navy Proof Mark



Barrel
Imperial Navy Proof Mark



Receiver
Imperial Navy Acceptance Mark



Receiver
Imperial Navy Acceptance Mark

VALUES

POOR	FAIR	GOOD	VG	EXC
\$800	\$1,200	\$2,000	\$3,500	\$5,000

Look-Up Index # 32

1906 NAVY COMMERCIAL

BACKGROUND

The 1906 Navy Commercial model was generally made for commercial sales both domestically within Germany and abroad.

HOW TO TELL A 1906 NAVY COMMERCIAL

The 1906 Navy Commercial can be distinguished from other Lugers by three features in combination.

1. Late, flat, checkered style toggle knobs.
2. Commercial Crown B, Crown U proofs.
3. Has a grip safety.

QUANTITY MADE

Approximately 3,000.

RARITY RATING

5, Somewhat rare.

FEATURES IN DEPTH

MANUFACTURER: This model was manufactured by DWM (Deutsche Waffen and Munitionsfabriken) of Berlin.

TOGGLE: This model should have the new type toggle, with the flat, checkered toggle knobs.

TOGGLE MARK: 

BARREL: This model should have a six-inch barrel. It should be chambered for 9mm Parabellum.

FRAME: The frame on this model should be the late, long type with a grip safety, stock lug, wide trigger and narrow trigger guard.

RECEIVER: The receiver on this model should be the late, long type. The chamber should be blank.

THUMB SAFETY: The thumb safety on this model should have a serrated safety lever. The lower position is

marked "GESICHERT." A very few are polished. Safe is in the upper position.

SIGHTS: The front sight on this model should be a dorsal fin shaped blade, dovetail fit on the barrel. The rear sight should be a two-position adjustable V notch located on the back of the rear toggle link.

EXTRACTOR: The extractor on this model should be the late type. It should be marked "GELADEN" on the left side.

GRIPS: The grips on this model should be checkered walnut. The left grip should be slotted for the grip safety.

MAGAZINE: The magazines original to this model should have a nickel-plated, wrap-around body. It should have a wood base with cut into each side. They should concentric circles not be serial numbered or proof marked. Some bases were marked "*Cal 9 m/m.*"

FINISH: The main finish on this model should be a high-quality rust blue. The ejector, magazine catch/release, takedown lever, thumb safety lever, and trigger should all be straw colored.

SERIAL NUMBER RANGE: 25050 to 67580.

SERIAL NUMBER LOCATION: The full serial number is found on the bottom of the barrel and on the front of the frame. The last two digits of the serial number are on the breechblock (lower left side), extractor (bottom), front toggle link (bottom), rear toggle link (back), receiver (rear), side plate (bottom edge), takedown lever (bottom), trigger (top left), grip safety (under grip) and grips (inside).

INTERESTING VARIATIONS

Some commercial examples are reported in 7.65mm.

One example with the chamber inscription "LOEWE and CO OBERNDORF A/N" is reported, suspected as a special presentation piece.

MARKINGS

MARK	LOCATION/DESCRIPTION
------	----------------------



	Toggle Manufacturer's Logo
--	-------------------------------

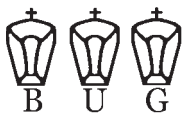

	Toggle or Receiver Commercial Proof
--	--



	Barrel German Commercial Proof
--	-----------------------------------



	Receiver Nitro Commercial Proof
--	------------------------------------

VALUES

POOR	FAIR	GOOD	VG	EXC
\$1,000	\$2,000	\$3,000	\$5,000	\$8,000

Look-Up Index # 33

1906 AMERICAN EAGLE



BACKGROUND

The 1906 American Eagle model was made specifically for commercial sales in the US.

HOW TO TELL A 1906 AMERICAN EAGLE

The 1906 American Eagle can be distinguished from other Lugers by four features in combination.

1. Late, flat, checkered style toggle knobs.
2. US Eagle inscription above the chamber.
3. With a grip safety.
4. The lower position on the thumb safety is polished bright.

QUANTITY MADE

Approximately 3,000 in 9mm Parabellum.
Approximately 8,000 in 7.65mm.

RARITY RATING

3, Uncommon.

FEATURES IN DEPTH

MANUFACTURER: This model was manufactured by DWM (Deutsche Waffen and Munitionsfabriken) of Berlin.

TOGGLE: This model should have the new type toggle, with the flat, checkered toggle knobs.

TOGGLE MARK: 

BARREL: This model should have either a 4-inch (100mm) barrel chambered for 9mm Parabellum, or a 4¾-inch (120mm) barrel chambered for 7.65mm (.30 Luger).

FRAME: The frame on this model should be the late, short type with a grip safety, wide trigger and narrow trigger guard.

RECEIVER: The receiver on this model should be the late, short type. The chamber should be marked with a US Eagle inscription.

THUMB SAFETY: The thumb safety on this model should have a serrated safety lever. The lower position is polished (not blued). Safe is in the upper position.

SIGHTS: The front sight on this model should be a dorsal fin shaped blade, dovetail fit on the barrel. The rear sight should be a fixed V notch in the rear toggle link.

EXTRACTOR: The extractor on this model should be the late type. It should be marked "LOADED" on the left side.

GRIPS: The grips on this model should be checkered walnut. The left grip should be slotted for the grip safety.

MAGAZINE: The magazines original to this model should have a nickel-plated, wrap-around body with a wood base. They should not be serial numbered or proof marked. The bases on some 9mm examples are marked "Cal 9 m/m."

FINISH: The main finish on this model should be a high-quality rust blue. The ejector, magazine catch/release, takedown lever, thumb safety lever and trigger should all be straw colored.





SERIAL NUMBER RANGE: 25500 to 69000.

SERIAL NUMBER LOCATION: The full serial number is found on the bottom of the barrel and on the front of the frame. The last two digits of the serial number are on the breechblock (lower left side), extractor (bottom), front toggle link (bottom), rear toggle link (back), receiver (rear), side plate (bottom edge), takedown lever (bottom), trigger (top left), grip safety (under grip) and grips (inside).

INTERESTING VARIATIONS

There are no notable variations of this model.

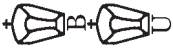
MARKINGS

MARK	LOCATION/DESCRIPTION
	Toggle Manufacturer's Logo
	Toggle or Receiver Commercial Proof
	Barrel German Commercial Proof
	Receiver Nitro Commercial Proof

VALUES

POOR	FAIR	GOOD	VG	EXC
9mm Parabellum (subtract 10 percent if magazine NOT marked "Cal 9 m/m")				
\$750	\$1,200	\$2,000	\$2,800	\$3,500
7.65mm				
\$500	\$1,000	\$1,800	\$2,500	\$3,200

Look-Up Index # 34

1906 AMERICAN EAGLE SAFETY MARKED

BACKGROUND

The 1906 American Eagle Safety Marked model was made specifically for commercial sales in the US. This variation is interesting because of the marked safety.

HOW TO TELL A 1906 AMERICAN EAGLE SAFETY MARKED

The 1906 American Eagle Safety Marked can be distinguished from other Lugers by four features in combination.

1. Late, flat, checkered style toggle knobs.
2. US Eagle inscription above the chamber.
3. Grip safety.
4. The lower position on the thumb safety is marked "GESICHERT."

QUANTITY MADE

Slightly more than 10,000.

RARITY RATING

4, Scarce.

FEATURES IN DEPTH

MANUFACTURER: This model was manufactured by DWM (Deutsche Waffen and Munitionsfabriken) of Berlin.

TOGGLE: This model should have the new type toggle, with the flat, checkered toggle knobs.

TOGGLE MARK: 

BARREL: This model should have a 4¾-inch (120mm) barrel. It should be chambered for 7.65mm (.30 Luger).

FRAME: The frame on this model should be the late, long type with a grip safety, wide trigger and narrow trigger guard.

GRIPS: The grips on this model should be checkered walnut. The left grip should be slotted for the grip safety.

MAGAZINE: The magazines original to this model should have a nickel-plated, wrap-around body with a wood base. They should not be serial numbered or proof marked.

FINISH: The main finish on this model should be a high-quality rust blue. The ejector, magazine catch/release, takedown lever, thumb safety lever and trigger should all be straw colored.

SERIAL NUMBER RANGE: 1 to 5000. The highest number reported is 4920.

SERIAL NUMBER LOCATION: The full serial number is found on the bottom of the barrel and on the front of the frame. The last two digits of the serial number are on the breechblock (lower left side), extractor (bottom), front toggle link (bottom), rear toggle link (back), receiver (rear), side plate (bottom edge), takedown lever (bottom), trigger (top left), grip safety (under grip) and grips (inside).

INTERESTING VARIATIONS

Some examples are reported in 9mm Parabellum, with 4-inch barrels.

MARKINGS

MARK	LOCATION/DESCRIPTION
------	----------------------



	Toggle Manufacturer's Logo
--	-------------------------------



	Receiver Brazilian Military Proof
--	--------------------------------------

VALUES

POOR	FAIR	GOOD	VG	EXC
\$750	\$1,200	\$2,000	\$3,200	\$4,000

Look-Up Index # 36

1906 BULGARIAN

BACKGROUND

The 1906 Bulgarian model was made specifically for military contract sales to Bulgaria. This order was placed in approximately 1908 as a follow up order to the

1900 Bulgarian contract the 1906 reference in the model name is from these being made in the 1906 pattern.

HOW TO TELL A 1906 BULGARIAN

The 1906 Bulgarian can be distinguished from other Lugers by five features in combination.

1. Late, flat, checkered style toggle knobs.
2. The toggle is marked with the scroll DWM logo.
3. Has a grip safety.
4. Royal lion crest inscription above the chamber.
5. Thumb safety marked in Cyrillic.

QUANTITY MADE

Estimated at 1,500.

RARITY RATING

6, Rare.

FEATURES IN DEPTH

MANUFACTURER: This model was manufactured by DWM (Deutsche Waffen and Munitionsfabriken) of Berlin.

TOGGLE: This model should have the new type toggle, with the flat, checkered toggle knobs.

TOGGLE MARK: 

BARREL: This model should have a 4¾-inch (120mm) barrel. It should be chambered for 7.65mm (.30 Luger).

FRAME: The frame on this model should be the late, short type with a grip safety, narrow trigger and wide trigger guard.

RECEIVER: The receiver on this model should be the early, long type. The chamber should be marked with the Bulgarian Lion crest inscription.

THUMB SAFETY: The thumb safety on this model should have a serrated safety lever. The upper position should be marked in Cyrillic lettering. Safe is in the upper position.

SIGHTS: The front sight on this model should be a saw tooth shaped blade if chambered for 7.65mm, or a dorsal fin shaped blade if rebarreled for 9mm. Either should be dovetail fit on the barrel. The rear sight should be a fixed V notch in the rear toggle link.

EXTRACTOR: The extractor on this model should be the late type. It should be marked in Cyrillic lettering on the left side.

GRIPS: The grips on this model should be checkered walnut. The left grip should be slotted for the grip safety.

MAGAZINE: The magazines original to this model should have a nickel-plated, wrap-around body with a wood base. They should not be serial numbered or proof marked.

FINISH: The main finish on this model should be a high-quality rust blue. The ejector, magazine catch/release, takedown lever, thumb safety lever and trigger should all be straw colored.

SERIAL NUMBER RANGE: 1 to 1500.

SERIAL NUMBER LOCATION: The full serial number is found on the bottom of the barrel and on the front of the frame. The last two digits of the serial number are on the breechblock (lower left side), extractor (bottom), front toggle link (bottom), rear toggle link (back), receiver (rear), side plate (bottom edge), takedown lever (bottom), trigger (top left), grip safety (under grip) and grips (inside).

INTERESTING VARIATIONS

Most examples were arsenal reworked to 9mm Parabellum and 4-inch barrels. These were reworked over several decades from around 1910 until the early to mid 1930s under the Nazi-era.

MARKINGS

MARK **LOCATION/DESCRIPTION**



Toggle
Manufacturer's Logo

VALUES

POOR	FAIR	GOOD	VG	EXC
9mm Parabellum				
\$800	\$1,750	\$3,000	\$5,000	\$7,500
7.65mm				
\$1,500	\$3,500	\$6,000	\$7,500	\$10,000

Look-Up Index # 37

1906 DUTCH



BACKGROUND

The 1906 Dutch model was made specifically for military contract sales to the Netherlands. The Dutch had finally decided to adopt the Luger pistol. As is common with Lugers, the 1906 is in reference to the 1906 pattern. The Dutch referred to the Luger as the M 11. These were actually delivered in 4 groups: 1,391 in early 1912, 750 in late summer 1912, 1,290 in late 1913 and 750 in early summer 1914. All of these were sent to the Dutch East Indies.

HOW TO TELL A 1906 DUTCH

The 1906 Dutch can be distinguished from other Lugers by five features in combination.

1. The toggle is marked with the scroll DWM logo.
2. 4-inch barrel length.
3. Has a grip safety.
4. Thumb safety marked "RUST."
5. Crown over W (for Queen Wilhelmina) proof mark found on either side of the receiver.

QUANTITY MADE

Exactly 4,181.

RARITY RATING

5, Somewhat rare.

FEATURES IN DEPTH

MANUFACTURER: This model was manufactured by DWM (Deutsche Waffen and Munitionsfabriken) of Berlin.

TOGGLE: This model should have the new type toggle, with the flat, checkered toggle knobs.

TOGGLE MARK: 

BARREL: This model should have a 4-inch (100mm) barrel. It should be chambered for 9mm Parabellum. Some have a date on the barrel indicating acceptance and/or rework dates.

FRAME: The frame on this model should be the late, short type with a grip safety, narrow trigger and wide trigger guard. Approximately 3,000 of these were issued to enlisted men and were unit marked on the backstrap of the grip. The 1,181 remaining pieces were issued to NCOs and officers and were therefore not unit marked.

RECEIVER: The receiver on this model should be the late, short type. The chamber should be blank.

THUMB SAFETY: The thumb safety on this model should have a serrated safety lever. It is marked "RUST" with a curved arrow pointing to the safe, upper position.

SIGHTS: The front sight on this model should be a dorsal fin shaped blade, dovetail fit on the barrel. The rear sight should be a fixed V notch in the rear toggle link.

EXTRACTOR: The extractor on this model should be the late type. It should be marked "GELADEN" on both sides.

GRIPS: The grips on this model should be checkered walnut. The left grip should be slotted for the grip safety.

MAGAZINE: The magazines original to this model should have a nickel-plated, wrap-around body with a wood base. They should not be serial numbered or proof marked.

FINISH: The main finish on this model should be a high-quality rust blue. The ejector, magazine catch/release, takedown lever, thumb safety lever and trigger should all be straw colored.

SERIAL NUMBER RANGE: 1 to 4184.

SERIAL NUMBER LOCATION: The full serial number is found on the bottom of the barrel and on the front of the frame. The last two digits of the serial number are on the breechblock (lower left side), extractor (bottom), front toggle link (bottom), rear toggle link (back), receiver (rear), side plate (bottom edge), takedown lever (bottom), trigger (top left), grip safety (under grip) and grips (inside).

INTERESTING VARIATIONS

Many examples have been arsenal reworked. The unit marks on these were usually removed and displayed on a brass plate mounted on the flat of the left side of the frame.

MARKINGS

MARK **LOCATION/DESCRIPTION**



Toggle
Manufacturer's Logo



Receiver
Dutch Royal Proof

VALUES

POOR	FAIR	GOOD	VG	EXC
\$700	\$1,000	\$1,500	\$2,500	\$4,250

Look-Up Index # 38

1906 ROYAL PORTUGUESE ARMY

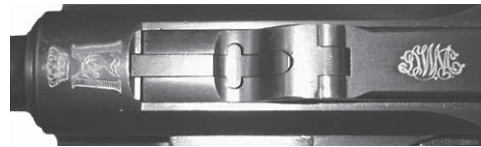

BACKGROUND

The 1906 Royal Portuguese Army model was made for military sales to the Royal Portuguese Army. Successful testing as early as 1902 (see reference under the 1900 Commercial model) led to this order placed early in 1909 for 1906 pattern Lugers. This model was known as the Model of 1909 to the Portuguese. The chamber inscription is that of King Manuel II.

HOW TO TELL A 1906 ROYAL PORTUGUESE ARMY

The 1906 Royal Portuguese Army can be distinguished from other Lugers by one feature.

1. A crown over an intertwined M and 2 inscription above the chamber.

QUANTITY MADE

5,000.

RARITY RATING

5, Somewhat rare.

FEATURES IN DEPTH

MANUFACTURER: This model was manufactured by DWM (Deutsche Waffen and Munitionsfabriken) of Berlin.

TOGGLE: This model should have the new type toggle, with the flat, checkered toggle knobs.

TOGGLE MARK: 

BARREL: This model should have a 4¾-inch (120mm) barrel. It should be chambered for 7.65mm (.30 Luger).

FRAME: The frame on this model should be the late, short type with a grip safety, narrow trigger and wide trigger guard.

RECEIVER: The receiver on this model should be the late, short type. The chamber should be marked with a Crown over M over 2 inscription.

THUMB SAFETY: The thumb safety on this model should have a serrated safety lever. The lower position is polished (not blued). Safe is in the upper position.

SIGHTS: The front sight on this model should be a saw tooth shaped blade, dovetail fit on the barrel. The

rear sight should be a fixed V notch in the rear toggle link.

EXTRACTOR: The extractor on this model should be the late type. The left side should be marked "CARREGADA."

GRIPS: The grips on this model should be checkered walnut. The left grip should be slotted for the grip safety.

MAGAZINE: The magazines original to this model should have a nickel-plated, wrap-around body with a wood base. They should not be serial numbered or proof marked.

FINISH: The main finish on this model should be a high-quality rust blue. The ejector, magazine catch/release, takedown lever, thumb safety lever and trigger should all be straw colored.

SERIAL NUMBER RANGE: 1 to 5000. The highest number reported is 4460.

SERIAL NUMBER LOCATION: The full serial number is found on the bottom of the barrel and on the front of the frame. The last two digits of the serial number are on the breechblock (lower left side), extractor (bottom), front toggle link (bottom), rear toggle link (back), receiver (rear), side plate (bottom edge), takedown lever (bottom), trigger (top left), grip safety (under grip) and grips (inside).

INTERESTING VARIATIONS

Several examples have been reported with the royal crest removed. This is believed to have been done in 1910 with the end of the monarchy and the establishment of the Republic of Portugal.

Some examples are found with a 4-inch barrel in 9mm Parabellum. Opinion is split as to whether these are rebarreled (see the Royal Portuguese Navy and the Republic of Portugal Navy models for other Portuguese Lugers, which were both in 9mm).

MARKINGS

MARK **LOCATION/DESCRIPTION**



Toggle
Manufacturer's Logo



Receiver
Portuguese Navy Proof

VALUES

POOR	FAIR	GOOD	VG	EXC
\$750	\$1,250	\$2,000	\$3,250	\$4,500

Look-Up Index # 39

1906 ROYAL PORTUGUESE NAVY

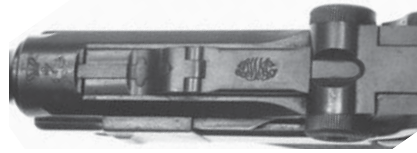

BACKGROUND

The 1906 Royal Portuguese Navy model was made for military sales to the Royal Portuguese Navy. This navy order for 1,000 pistols was placed in late 1909, following the Portuguese Army contract. These were for the imperial era under King Manuel II, not to be confused with the republican era (see the next model).

HOW TO TELL A 1906 ROYAL PORTUGUESE NAVY

The 1906 Royal Portuguese Navy can be distinguished from other Lugers by one feature.

1. A crown over an anchor inscription above the chamber.

QUANTITY MADE

Less than 1,000.

RARITY RATING

8, Extremely rare. Only 6 reported.

FEATURES IN DEPTH

MANUFACTURER: This model was manufactured by DWM (Deutsche Waffen and Munitionsfabriken) of Berlin.

TOGGLE: This model should have the new type toggle, with the flat, checkered toggle knobs.

TOGGLE MARK: 

BARREL: This model should have a 4-inch (100mm) barrel. It should be chambered for 9mm Parabellum.

FRAME: The frame on this model should be the late, short type with a grip safety, narrow trigger and wide trigger guard.

RECEIVER: The receiver on this model should be the late, short type. The chamber should be marked with a Crown over anchor inscription.



THUMB SAFETY: The thumb safety on this model should have a serrated safety lever. The lower position is polished (not blued). Safe is in the upper position.

SIGHTS: The front sight on this model should be a dorsal fin shaped blade, dovetail fit on the barrel. The rear sight should be a fixed V notch in the rear toggle link.

EXTRACTOR: The extractor on this model should be the late type. The left side should be marked "CARREGADA."

GRIPS: The grips on this model should be checkered walnut. The left grip should be slotted for the grip safety.

MAGAZINE: The magazines original to this model should have a nickel-plated, wrap-around body with a wood base. They should not be serial numbered or proof marked. The bases on some examples are marked "Cal 9 m/m."

FINISH: The main finish on this model should be a high-quality rust blue. The ejector, magazine catch/release, takedown lever, thumb safety lever and trigger should all be straw colored.

SERIAL NUMBER RANGE: 1 to 1000. The highest number reported is 769.

SERIAL NUMBER LOCATION: The full serial number is found on the bottom of the barrel and on the front of the frame. The last two digits of the serial number are on the breechblock (lower left side), extractor (bottom), front toggle link (bottom), rear toggle link (back), receiver (rear), side plate (bottom edge), takedown lever (bottom), trigger (top left), grip safety (under grip) and grips (inside).

INTERESTING VARIATIONS

There are no notable variations of this model.

MARKINGS

MARK	LOCATION/DESCRIPTION
	Toggle Manufacturer's Logo
	Receiver Marinha Portuguesa Proof

VALUES

POOR	FAIR	GOOD	VG	EXC
\$2,500	\$3,500	\$6,000	\$10,000	\$12,000

Look-Up Index # 40

1906 REPUBLIC OF PORTUGAL NAVY

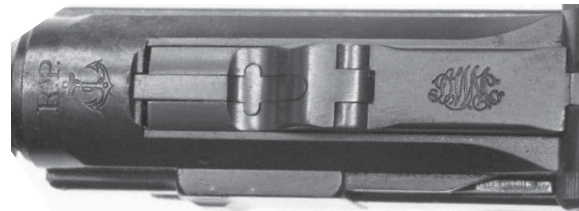

BACKGROUND

The 1906 Republic of Portugal Navy model was made specifically for military contract sales to the post-monarchical Portuguese Navy. The Royal Portuguese Navy contract had not been fully filled when King Victor Manuel II's monarchy was overthrown and replaced by the Republic of Portugal. DWM, always eager to please its customers, quickly replaced the royal chamber crest with a new navy mark, which would be more to the liking of the new republic.

HOW TO TELL A 1900 REPUBLIC OF PORTUGAL NAVY

The 1906 Republic of Portugal Navy can be distinguished from other Lugers by one feature.

1. An R.P. over Anchor inscription above the chamber.

QUANTITY MADE

Less than 1,000.

RARITY RATING

7, Very rare.

FEATURES IN DEPTH

MANUFACTURER: This model was manufactured by DWM (Deutsche Waffen and Munitionsfabriken) of Berlin.

TOGGLE: This model should have the new type toggle, with the flat, checkered toggle knobs.

TOGGLE MARK: 

BARREL: This model should have a 4-inch (100mm) barrel. It should be chambered for 9mm Parabellum.

FRAME: The frame on this model should be the late, short type with a grip safety, narrow trigger and wide trigger guard.



RECEIVER: The receiver on this model should be the late, short type. The chamber should be marked with an R.P. over Anchor inscription.

THUMB SAFETY: The thumb safety on this model should have a serrated safety lever. The lower position is polished (not blued). Safe is in the upper position.

SIGHTS: The front sight on this model should be a dorsal fin shaped blade, dovetail fit on the barrel. The rear sight should be a fixed V notch in the rear toggle link.

EXTRACTOR: The extractor on this model should be the late type. The left side should be marked "CARREGADA."

GRIPS: The grips on this model should be checkered walnut. The left grip should be slotted for the grip safety.

MAGAZINE: The magazines original to this model should have a nickel-plated, wrap-around body with a wood base. They should not be serial numbered or proof marked.

FINISH: The main finish on this model should be a high-quality rust blue. The ejector, magazine catch/release, takedown lever, thumb safety lever and trigger should all be straw colored.



SERIAL NUMBER RANGE: 1 to 1000.

SERIAL NUMBER LOCATION: The full serial number is found on the bottom of the barrel and on the front of the frame. The last two digits of the serial number are on the breechblock (lower left side), extractor (bottom), front toggle link (bottom), rear toggle link (back), receiver (rear), side plate (bottom edge), takedown lever (bottom), trigger (top left), grip safety (under grip) and grips (inside).

INTERESTING VARIATIONS

There are no notable variations of this model.

MARKINGS

MARK	LOCATION/DESCRIPTION
	Toggle Manufacturer's Logo
	Receiver Marinha Portuguesa Proof

VALUES

POOR	FAIR	GOOD	VG	EXC
\$2,500	\$3,500	\$6,000	\$10,000	\$12,000

Look-Up Index # 41

1906 RUSSIAN

BACKGROUND

The 1906 Russian model was made specifically for military contract sales to Russia. Documents show evidence of Russian consideration of the Luger as early as 1902. Between 1906 and 1909 Russia ordered 1,000 Lugers in the 1906 pattern.

HOW TO TELL A 1906 RUSSIAN

The 1906 Russian can be distinguished from other Lugers by one feature.

1. An inscription of crossed rifles above the chamber.

QUANTITY MADE

Approximately 1,000.

RARITY RATING

7, Very rare.

FEATURES IN DEPTH

MANUFACTURER: This model was manufactured by DWM (Deutsche Waffen and Munitionsfabriken) of Berlin.

TOGGLE: This model should have the new type toggle, with the flat, checkered toggle knobs.

TOGGLE MARK: 

BARREL: This model should have a 4-inch (100mm) barrel. It should be chambered for 9mm Parabellum.

FRAME: The frame on this model should be the late, short type with a grip safety, wide trigger and narrow trigger guard.

RECEIVER: The receiver on this model should be the late short type. The chamber should be marked with an inscription of crossed rifles.

THUMB SAFETY: The thumb safety on this model should have a serrated safety lever. The upper position is marked in Cyrillic lettering. Safe is in the upper position.

SIGHTS: The front sight on this model should be a dorsal fin shaped blade, dovetail fit on the barrel. The rear sight should be a fixed V notch in the rear toggle link.

EXTRACTOR: The extractor on this model should be the late type. It should be marked in Cyrillic lettering on the left side.

GRIPS: The grips on this model should be checkered walnut. The left grip should be slotted for the grip safety.

MAGAZINE: The magazines original to this model should have a nickel-plated, wrap-around body with a

wood base. They should not be serial numbered or proof marked. The base should be marked “*Cal 9 m/m.*”

FINISH: The main finish on this model should be a high-quality rust blue. The ejector, magazine catch/release, takedown lever, thumb safety lever and trigger should all be straw colored.

SERIAL NUMBER RANGE: 1 to 1000 range.

SERIAL NUMBER LOCATION: The full serial number is found on the bottom of the barrel and on the front of the frame. The last two digits of the serial number are on the breechblock (lower left side), extractor (bottom), front toggle link (bottom), rear toggle link (back), receiver (rear), side plate (bottom edge), takedown lever (bottom), trigger (top left), grip safety (under grip) and grips (inside).

INTERESTING VARIATIONS

There are no notable variations of this model.

MARKINGS

MARK **LOCATION/DESCRIPTION**



Toggle
Manufacturer’s Logo



Receiver
Russian Military Proof

VALUES

POOR	FAIR	GOOD	VG	EXC
\$2,750	\$4,500	\$7,500	\$15,000	\$18,000

Look-Up Index # 42

**1906 SWISS MILITARY
(CROSS IN SUNBURST)**



BACKGROUND

The 1906 Swiss Military model (also known as the Cross in Sunburst) was made specifically for military contract sales to Switzerland.

HOW TO TELL A 1906 SWISS MILITARY

The 1906 Swiss Military can be distinguished from other Lugers by six features in combination.

1. Late, flat, checkered style toggle knobs.
2. Cross in Sunburst crest inscription above the chamber.
3. Not serial numbered on the left side of the receiver.
4. Serial number in the range 5001 to 15215.
5. No barrel inscription referencing Abercrombie and Fitch.
6. Swiss military proof marks.

QUANTITY MADE

10,215 (includes both the 1906 Swiss Military and the 1906 Swiss Police).

RARITY RATING

4, Scarce.

FEATURES IN DEPTH

MANUFACTURER: This model was manufactured by DWM (Deutsche Waffen and Munitionsfabriken) of Berlin.

TOGGLE: This model should have the new type toggle, with the flat, checkered toggle knobs.

TOGGLE MARK: 

BARREL: This model should have a 4¾-inch (120mm) barrel. It should be chambered for 7.64 mm (.30 Luger).

FRAME: The frame on this model should be the late, long type with a grip safety, wide trigger and narrow trigger guard.

RECEIVER: The receiver on this model should be the late, long type. The chamber should be marked with the Swiss Cross in Sunburst inscription.

THUMB SAFETY: The thumb safety on this model should have a serrated safety lever. The lower position is polished (not blued). Safe is in the upper position.

SIGHTS: The front sight on this model should be a saw tooth shaped blade, dovetail fit on the barrel. The rear sight should be a fixed V notch in the rear toggle link.

EXTRACTOR: The extractor on this model should be the late type. It should be marked “GELADEN” on the left side.

GRIPS: The grips on this model should be checkered walnut. The left grip should be slotted for the grip safety.

MAGAZINE: The magazines original to this model should have a nickel-plated, wrap-around body and a wood base. Some bases have a metal insert. They should not be serial numbered or proof marked.

FINISH: The main finish on this model should be a high-quality rust blue. The ejector, magazine catch/release, takedown lever, thumb safety lever and trigger should all be straw colored.

SERIAL NUMBER RANGE: 5001 to 10000.

SERIAL NUMBER LOCATION: The full serial number is found on the bottom of the barrel and on the front of the frame. The last two digits of the serial number are on the breechblock (lower left side), extractor (bottom), front toggle link (bottom), rear toggle link (back), receiver (rear), side plate (bottom edge), takedown lever (bottom), trigger (top left), grip safety (under grip) and grips (inside).

INTERESTING VARIATIONS

Some examples are found marked with a “P” and a two-digit year. These marks indicate a gun that was released by the Swiss police or military and the date of release.

Many were reworked for WW I military use and/or 1920 commercial sales. These are less desirable than specimens in original configuration.

There is a specimen imported to the US which had been reworked (chamber and toggle marks removed), with the toggle restamped “MAUSER OBERNDORF a N..”

MARKINGS

MARK **LOCATION/DESCRIPTION**



Toggle
Manufacturer’s Logo



Barrel & Receiver
Swiss Rework Proof



Receiver Rework Proof for
Swiss Inspectors
Herr Vogelsang
or



Herr Nievergelt
or



Colonel Muhlemann

VALUES

POOR	FAIR	GOOD	VG	EXC
Original Configuration				
\$750	\$1,000	\$2,200	\$3,400	\$4,500
Rework				
\$500	\$750	\$1,250	\$1,750	\$2,500

Look-Up Index # 43

**1906 SWISS POLICE
(CROSS IN SHIELD)**

BACKGROUND

The 1906 Swiss Police model (also known as the Cross in Shield) was made specifically for police contract sales to Switzerland.

HOW TO TELL A 1906 SWISS POLICE

The 1906 Swiss Police can be distinguished from other Lugers by one distinct feature.

1. Cross in Shield crest inscription above the chamber.

QUANTITY MADE

10,215 (includes both the 1906 Swiss Military and the 1906 Swiss Police).

RARITY RATING

4, Scarce.

FEATURES IN DEPTH

MANUFACTURER: This model was manufactured by DWM (Deutsche Waffen and Munitionsfabriken) of Berlin.

TOGGLE: This model should have the new type toggle, with the flat, checkered toggle knobs.

TOGGLE MARK:

BARREL: This model should have a 4¾-inch (120mm) barrel. It should be chambered for 7.64 mm (.30 Luger).

FRAME: The frame on this model should be the late, long type with a grip safety, wide trigger and narrow trigger guard.

RECEIVER: The receiver on this model should be the late, long type. The chamber should be marked with the Swiss Cross in Shield inscription.

THUMB SAFETY: The thumb safety on this model should have a serrated safety lever. The lower position is polished (not blued). Safe is in the upper position.

SIGHTS: The front sight on this model should be a saw tooth shaped blade, dovetail fit on the barrel. The rear sight should be a fixed V notch in the rear toggle link.

EXTRACTOR: The extractor on this model should be the late type. It should be marked “GELADEN” on the left side.

GRIPS: The grips on this model should be checkered walnut. The left grip should be slotted for the grip safety.

EXTRACTOR: The extractor on this model should be the late type. It should be marked "GELADEN" on the left side.

GRIPS: The grips on this model should be checkered walnut. The left grip should be slotted for the grip safety.

MAGAZINE: The magazines original to this model should have a nickel-plated, wrap-around body and a wood base. Some bases have a metal insert. They should not be serial numbered or proof marked.

FINISH: The main finish on this model should be a high-quality rust blue. The ejector, magazine catch/release, takedown lever, thumb safety lever and trigger should all be straw colored.

SERIAL NUMBER RANGE: 35000 to 55000.

SERIAL NUMBER LOCATION: The full serial number is found on the bottom of the barrel and on the front of the frame. The last two digits of the serial number are on the breechblock (lower left side), extractor (bottom), front toggle link (bottom), rear toggle link (back), receiver (rear), side plate (bottom edge), takedown lever (bottom), trigger (top left), grip safety (under grip) and grips (inside).

INTERESTING VARIATIONS

There are no notable variations of this model.

MARKINGS

MARK **LOCATION/DESCRIPTION**



Toggle
Manufacturer's Logo



Toggle or Receiver
Commercial Proof

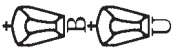

Barrel
German Commercial Proof



Receiver
Nitro Commercial Proof

VALUES

POOR	FAIR	GOOD	VG	EXC
\$800	\$1,500	\$2,500	\$3,500	\$5,000

Look-Up Index # 45

1906 U.S. ARMY TEST

BACKGROUND

The 1906 U.S. Army Test model was made specifically for military test trails by the US Army in 1907. The Colt .45 Automatic won the competition (designed by Luger's competitor John M. Browning). The only known specimen is serial number 2. Serial number 1 is thought to have been all but destroyed in the testing (whereabouts unknown). If a serial number 3 or higher ever existed, we may never know.

HOW TO TELL A 1906 U.S. ARMY TEST

The 1906 U.S. Army Test can be distinguished from other Lugers by either of two features.

1. The trigger has a change in curvature, bordering on a bend. This was necessary due to the oversized frame needed to handle the larger .45 ACP cartridge.
2. This is the only original Luger pistol chambered for .45 ACP.

QUANTITY MADE

2, maybe 3.

RARITY RATING

10, Absolutely Unique.

FEATURES IN DEPTH

MANUFACTURER: This model was manufactured by DWM (Deutsche Waffen and Munitionsfabriken) of Berlin.

TOGGLE: New, flat, checkered type, marked with an intertwined "GL" on the rear toggle link.

TOGGLE MARK:

BARREL: This model should have a 5-inch barrel. It should be chambered for .45 ACP.

FRAME: The frame on this model is unique. It is larger overall to accommodate the bigger cartridge. It has a grip safety, wide trigger and narrow trigger guard.

RECEIVER: The receiver on this model is unique. It is larger overall to accommodate the bigger cartridge. The chamber should be blank.

THUMB SAFETY: The thumb safety on this model should have a serrated safety lever. The lower position is polished (not blued). Safe is in the upper position.

SIGHTS: The front sight on this model should be a dorsal fin shaped blade, dovetail fit on the barrel. The rear sight should be a fixed V notch in the rear toggle link.

EXTRACTOR: The extractor on this model should be the late type. It should be marked "LOADED" on the left side.

GRIPS: The grips on this model should be checkered walnut. The left grip should be slotted for the grip safety.

MAGAZINE: The magazines original to this model should have a nickel-plated, wrap-around body with a wood base. They should not be serial numbered or proof marked.

FINISH: The main finish on this model should be a high-quality rust blue. The ejector, magazine catch/release, takedown lever, thumb safety lever and trigger should all be straw colored.

SERIAL NUMBER RANGE: 1 digit.

SERIAL NUMBER LOCATION: Since the serial number of this variation is a single digit, all appearances of the serial number are the full number, even though some were undoubtedly intended as the last two digits. The serial number is found on the bottom of the barrel, on the front of the frame and on the breechblock (lower left side), extractor (bottom), front toggle link (bottom), rear toggle link (back), receiver (rear), side plate (bottom edge), takedown lever (bottom), trigger (top left), grip safety (under grip) and grips (inside).

INTERESTING VARIATIONS

There are no notable variations of this model.

MARKINGS

MARK	LOCATION/DESCRIPTION
None.	

VALUES

This model is too rare to price.

Look-Up Index # 46

1907 DUTCH EAST INDIES TEST

BACKGROUND

The 1907 Dutch East Indies Test model was made specifically for military test and evaluation for the Dutch military. It is unclear as to why the Dutch felt compelled to retest a pistol they had just adopted.

HOW TO TELL A 1907 DUTCH EAST INDIES TEST

The 1907 Dutch East Indies Test can be distinguished from other Lugers by five features in combination.

1. The toggle is marked with the scroll DWM logo.
2. 4-inch barrel length.
3. Has a grip safety.
4. Thumb safety marked RUST.
5. Serial numbers in the range of 43000.

QUANTITY MADE

10.

RARITY RATING

8-9, Extremely rare to nearly unique.

FEATURES IN DEPTH

MANUFACTURER: This model was manufactured by DWM (Deutsche Waffen and Munitionsfabriken) of Berlin.

TOGGLE: This model should have the new type toggle, with the flat, checkered toggle knobs.

TOGGLE MARK: 

BARREL: This model should have a 4-inch (100mm) barrel chambered for 9mm Parabellum.

FRAME: The frame on this model should be the late, short type with a grip safety, wide trigger and narrow trigger guard.

RECEIVER: The receiver on this model should be the late, short type. The chamber should be blank.

THUMB SAFETY: The thumb safety on this model should have a serrated safety lever. It is marked "RUST" with a curved arrow pointing to the safe, upper position.

SIGHTS: The front sight on this model should be a dorsal fin shaped blade, dovetail fit on the barrel. The rear sight should be a fixed V notch in the rear toggle link.

EXTRACTOR: The extractor on this model should be the late type. It should be marked "GELADEN" on just the left side.

GRIPS: The grips on this model should be checkered walnut. The left grip should be slotted for the grip safety.

MAGAZINE: The magazines original to this model should have a nickel-plated, wrap-around body with a wood base. They should not be serial numbered or proof marked.

FINISH: The main finish on this model should be a high-quality rust blue. The ejector, magazine catch/release, takedown lever, thumb safety lever, and trigger should all be straw colored.

SERIAL NUMBER RANGE: 43900 to 43999 range.

SERIAL NUMBER LOCATION: The full serial number is found on the bottom of the barrel and on the front of the frame. The last two digits of the serial number are on the breechblock (lower left side), extractor (bottom), front toggle link (bottom), rear toggle link (back), receiver (rear), side plate (bottom edge), takedown lever (bottom), trigger (top left), grip safety (under grip) and grips (inside).

INTERESTING VARIATIONS

10 of the 9mm Parabellum pistols were serial numbered in the early 10000 range with a B suffix. These will have a few minor breechblock, extractor and grip screw modifications which are only found on these Dutch Model Lugers.

MARKINGS

MARK	LOCATION/DESCRIPTION
------	----------------------

No specimens of this model have been observed. We know what little we do from records.



Toggle
Manufacturer's Logo

VALUES

POOR	FAIR	GOOD	VG	EXC
\$1,000	\$1,500	\$3,000	\$5,000	\$7,500

Look-Up Index # 47

1908 COMMERCIAL

BACKGROUND

The 1908 Commercial model was generally made for commercial sales both domestically within Germany and abroad.

HOW TO TELL A 1908 COMMERCIAL

The 1908 Commercial can be distinguished from other Lugers by five features in combination.

1. Late, flat, checkered style toggle knobs.
2. No stock lug.
3. No grip safety.
4. Commercial BUG proofs.
5. Standard fixed sights.

QUANTITY MADE

10,000.

RARITY RATING

4, Scarce.

FEATURES IN DEPTH

MANUFACTURER: This model was manufactured by DWM (Deutsche Waffen and Munitionsfabriken) of Berlin.

TOGGLE: This model should have the new type toggle, with the flat, checkered toggle knobs.



BARREL: This model should have a 4-inch (100mm) barrel. It should be chambered for 9mm Parabellum.

FRAME: The frame on this model should be the late, short type with a wide trigger and narrow trigger guard.

RECEIVER: The receiver on this model should be the late, short type. The chamber should be blank.

THUMB SAFETY: The thumb safety on this model should have a serrated safety lever. The upper position is marked "GESICHERT." Safe is in the lower position.

SIGHTS: The front sight on this model should be a dorsal fin shaped blade, dovetail fit on the barrel. The rear sight should be a fixed V notch in the rear toggle link.

EXTRACTOR: The extractor on this model should be the late type. It should be marked "GELADEN" on the left side.

GRIPS: The grips on this model should be checkered walnut.

MAGAZINE: The magazines original to this model should have a tin-plated, wrap-around body with a wood base. They should not be serial numbered or proof marked.

FINISH: The main finish on this model should be a high-quality rust blue. The ejector, magazine catch/release, takedown lever, thumb safety lever and trigger should all be straw colored.

SERIAL NUMBER RANGE: 39000 to 71500

SERIAL NUMBER LOCATION: The full serial number is found on the bottom of the barrel and on the front of the frame. The last two digits of the serial number are on the breechblock (lower left side), extractor (bottom), front toggle link (bottom), rear toggle link (back), receiver (rear), side plate (bottom edge), takedown lever (bottom), trigger (top left), and grips (inside).

INTERESTING VARIATIONS

Two reported examples (one verified by photos) have a chamber inscription of a number over "G.M.S.G." The verified specimen also has a unit marked front strap "M.S.G. 1195."

MARKINGS

MARK LOCATION/DESCRIPTION



Toggle
Manufacturer's Logo



Toggle or Receiver
Commercial Proof

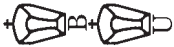

Barrel
German Commercial Proof



Receiver
Nitro Commercial Proof

VALUES

POOR	FAIR	GOOD	VG	EXC
\$500	\$600	\$750	\$1,250	\$2,250

Look-Up Index # 48

1908 BOLIVIAN

BACKGROUND

The 1908 Bolivian model was made specifically for commercial sales within Bolivia.

HOW TO TELL A 1908 BOLIVIAN

The 1908 Bolivian can be distinguished from other Lugers by one distinct feature.

1. There is an inscription atop the chamber that says "Ejercito de Bolivia."

QUANTITY MADE

Approximately 500.

RARITY RATING

7, Very rare.

FEATURES IN DEPTH

MANUFACTURER: This model was manufactured by DWM (Deutsche Waffen and Munitionsfabriken) of Berlin.

TOGGLE: This model should have the new type toggle, with the flat, checkered toggle knobs.

TOGGLE MARK: 

BARREL: This model should have a 4-inch (100mm) barrel. It should be chambered for 9mm Parabellum.

FRAME: The frame on this model should be the late, short type with a wide trigger and narrow trigger guard.

RECEIVER: The receiver on this model should be the late, short type. The chamber should be marked "Ejercito de Bolivia."

THUMB SAFETY: The thumb safety on this model should have a serrated safety lever. The upper position is marked "SEGURO." Safe is in the lower position.

SIGHTS: The front sight on this model should be a dorsal fin shaped blade, dovetail fit on the barrel. The rear sight should be a fixed V notch in the rear toggle link.

EXTRACTOR: The extractor on this model should be the late type. The left side should be marked "CARGADO."

GRIPS: The grips on this model should be checkered walnut.

MAGAZINE: The magazines original to this model should have a tin-plated, wrap-around body with a wood base. They should not be serial numbered or proof marked.

FINISH: The main finish on this model should be a high-quality rust blue. The ejector, magazine catch/release, takedown lever, thumb safety lever and trigger should all be straw colored.

SERIAL NUMBER RANGE: 64000 to 65000 range.

SERIAL NUMBER LOCATION: The full serial number is found on the bottom of the barrel and on the front of the frame. The last two digits of the serial number are on the breechblock (lower left side), extractor (bottom), front toggle link (bottom), rear toggle link (back), receiver (rear), side plate (bottom edge), takedown lever (bottom), trigger (top left), and grips (inside).

INTERESTING VARIATIONS

There are no notable variations of this model.

MARKINGS

MARK LOCATION/DESCRIPTION



Toggle
Manufacturer's Logo



Receiver
Nitro Commercial Proof

VALUES

POOR	FAIR	GOOD	VG	EXC
\$1,000	\$2,000	\$4,500	\$7,500	\$10,000

Look-Up Index # 49

1908 BULGARIAN

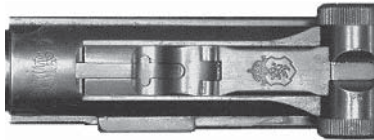

BACKGROUND

The 1908 Bulgarian model was made specifically for military contract sales to Bulgaria. This was the third and Bulgarian contract model Luger. This order was placed in 1910 for pistols in the 1908 pattern.

HOW TO TELL A 1908 BULGARIAN

The 1908 Bulgarian can be distinguished from other Lugers by one distinct feature.

1. The toggle has an inscription of a crown over a lion in a shield.

QUANTITY MADE

10,000, in two separate orders of 5,000 each.

RARITY RATING

4, Scarce

FEATURES IN DEPTH

MANUFACTURER: This model was manufactured by DWM (Deutsche Waffen and Munitionsfabriken) of Berlin.

TOGGLE: This model should have the new type toggle, with the flat, checkered toggle knobs.

TOGGLE MARK:



BARREL: This model should have a 4-inch (100mm) barrel. It should be chambered for 9mm Parabellum.



FRAME: The frame on this model should be the late, short type with a wide trigger and narrow trigger guard. These have a sling loop on the lower back strap.

RECEIVER: The receiver on this model should be the late, short type.

The chamber should be marked



THUMB SAFETY: The thumb safety on this model should have a serrated safety lever. The upper position is marked "ОГЪНЬ." Safe is in the lower position.

SIGHTS: The front sight on this model should be a dorsal fin shaped blade, dovetail fit on the barrel. The rear sight should be a fixed V notch in the rear toggle link.

EXTRACTOR: The extractor on this model should be the late type. It should be marked "ПЪЛЕНЬ" on the left side.

GRIPS: The grips on this model should be checkered walnut.

MAGAZINE: The magazines original to this model should have a tin-plated, wrap-around body with a wood base. They should not be serial numbered or proof marked.

FINISH: The main finish on this model should be a high-quality rust blue. The ejector, magazine catch/release, takedown lever, thumb safety lever and trigger should all be straw colored.

SERIAL NUMBER RANGE: 1 to 5000 and 01 c to 5000 c.

SERIAL NUMBER LOCATION: The full serial number is found on the bottom of the barrel and on the front of the frame. The last two digits of the serial number are on the breechblock (lower left side), extractor (bottom), front toggle link (bottom), rear toggle link (back), receiver (rear), side plate (bottom edge), takedown lever (bottom), trigger (top left), and grips (inside).

INTERESTING VARIATIONS

There are no notable variations of this model.

MARKINGS

MARK	LOCATION/DESCRIPTION
------	----------------------



Chamber
Manufacturer's Logo



Toggle
Bulgarian Royal Crest

VALUES

POOR	FAIR	GOOD	VG	EXC
\$1,500	\$2,000	\$2,500	\$4,500	\$6,000

THE P.08 IS BORN!

Look-Up Index # 50

1908 COMMERCIAL, MILITARY CONTRACT



BACKGROUND

The 1908 Commercial, Military Contract model was made specifically for contract military sales to the German Army. With the introduction to the 1908 models, the German Army found renewed interest and need for the Pistole Parabellum. This was the landmark model the gave the Luger it's military designation, P.08.

These 500 Lugers were taken from commercial production.

HOW TO TELL A 1908 COMMERCIAL, MILITARY CONTRACT

The 1908 Commercial, Military Contract can be distinguished from other Lugers by one distinct feature.

1. The unique triple Crown/X proofs, which were only ever found on this model.

QUANTITY MADE

Approximately 500.

RARITY RATING

7, Very rare.

FEATURES IN DEPTH

MANUFACTURER: This model was manufactured by DWM (Deutsche Waffen and Munitionsfabriken) of

Berlin.

TOGGLE: This model should have the new type toggle, with the flat, checkered toggle knobs.

TOGGLE MARK: 

BARREL: This model should have a 4-inch (100mm) barrel. It should be chambered for 9mm Parabellum.

FRAME: The frame on this model should be the late, short type with a wide trigger and narrow trigger guard.

RECEIVER: The receiver on this model should be the late, short type. The chamber should be blank.

THUMB SAFETY: The thumb safety on this model should have a serrated safety lever. The upper position is marked "GESICHERT." Safe is in the lower position.

SIGHTS: The front sight on this model should be a dorsal fin shaped blade, dovetail fit on the barrel. The rear sight should be a fixed V notch in the rear toggle link.

EXTRACTOR: The extractor on this model should be the late type. It should be marked "GELADEN" on the left side.

GRIPS: The grips on this model should be checkered walnut.

MAGAZINE: The magazines original to this model should have a tin-plated, wrap-around body with a wood base. They should be proof marked and serial numbered to the pistol.

FINISH: The main finish on this model should be a high-quality rust blue. The ejector, magazine catch/release, takedown lever, thumb safety lever and trigger should all be straw colored.

SERIAL NUMBER RANGE: 69100 to 70100. Possibly as late as 71000.

SERIAL NUMBER LOCATION: The full serial number is found on the bottom of the barrel and on the front of the frame. The last two digits of the serial number are on the breechblock (lower left side), extractor (bottom), front toggle link (bottom), rear toggle link (back), receiver (rear), side plate (bottom edge), takedown lever (bottom), trigger (top left) and grips (inside).

INTERESTING VARIATIONS

There are no notable variations of this model.

MARKINGS

MARK	LOCATION/DESCRIPTION
------	----------------------



Toggle
Manufacturer's Logo



Receiver
German Military Proof only found on the 1908 Military Contract



Barrel, Breechblock and Receiver
German Military Test Fire Proof

VALUES

POOR	FAIR	GOOD	VG	EXC
\$750	\$1,200	\$2,000	\$2,500	\$3,000

Look-Up Index # 51

1908 MILITARY



BACKGROUND

The 1908 Military model (sometimes called the 1908 Military and Commercial due to the serial number placement) was made specifically for military sales to the German Army.

The subtle difference between the 1908 Commercial, Military Contact model and this model is that the former was a commercial production run from which a few hundred military guns were pulled. Whereas this model is in all respects a military production.

HOW TO TELL A 1908 MILITARY

The 1908 Military can be distinguished from other Lugers by one distinct feature.

1. The unique double Crown/CF proofs, which were only ever found on this model.

QUANTITY MADE

Several thousand, up to 25,000.

RARITY RATING

3, Uncommon.

FEATURES IN DEPTH

MANUFACTURER: This model was manufactured by DWM (Deutsche Waffen and Munitionsfabriken) of Berlin.

TOGGLE MARK: 

BARREL: This model should have a 4-inch (100mm) barrel. It should be chambered for 9mm Parabellum.

FRAME: The frame on this model should be the late, short type with a wide trigger and narrow trigger guard.

RECEIVER: The receiver on this model should be the late, short type. The chamber should be blank.

THUMB SAFETY: The thumb safety on this model should have a serrated safety lever. The upper position is marked "GESICHERT." Safe is in the lower position.

SIGHTS: The front sight on this model should be a dorsal fin shaped blade, dovetail fit on the barrel. The rear sight should be a fixed V notch in the rear toggle link.

EXTRACTOR: The extractor on this model should be the late type. It should be marked "GELADEN" on the left side.

GRIPS: The grips on this model should be checkered walnut.

MAGAZINE: The magazines original to this model should have a tin-plated, wrap-around body with a wood base. They should be proof marked and serial numbered to the pistol.

FINISH: The main finish on this model should be a high-quality rust blue. The ejector, magazine catch/release, takedown lever, thumb safety lever and trigger should all be straw colored.

SERIAL NUMBER RANGE: 01 to approximately 5000 b.



SERIAL NUMBER LOCATION: The full serial number is found on the bottom of the barrel, the front of the frame, and the left side of the receiver. The last two digits of the serial number are on the breechblock (lower left side), extractor, front toggle link (bottom), rear toggle link (back), sear (left side), sear bar safety lever, side plate, takedown lever (bottom), thumb safety lever (top), trigger (top left), and grips (inside).

INTERESTING VARIATIONS

Examples can be found with the full serial number added to the left side of the receiver. These are sometimes referred to as the 1908 Military, 2nd Issue, implying a 1st Issue description for those without the serial number added.

There are also specimens with a chamber mark of #/G.M.S.G. Noted #'s to date are 6 and 9.

MARKINGS

MARK	LOCATION/DESCRIPTION
	Toggle Manufacturer's Logo
	Receiver German Military Proof found only on the 1908 Military (undated)
	Barrel, Breechblock and Receiver German Military Test Fire Proof

VALUES

POOR	FAIR	GOOD	VG	EXC
\$400	\$500	\$650	\$750	\$1,400

Look-Up Index # 52

1908 MILITARY, DATED

BACKGROUND

The 1908 Military, Dated model was made specifically for military sales to the German Army.

HOW TO TELL A 1908 MILITARY, DATED

The 1908 Military, Dated can be distinguished from other Lugers by four features in combination.

1. Toggle has the scrolled DWM inscription.
2. A four-digit year date inscription above the chamber.
3. No stock lug.
4. No commercial proof marks (e.g., a Crown/N).

QUANTITY MADE

Approximately: 17,000 in 1910
13,000 in 1911
10,000 in 1912
18,000 in 1913

Total production of approximately 58,000.

RARITY RATING

2, Common.

FEATURES IN DEPTH

MANUFACTURER: This model was manufactured by DWM (Deutsche Waffen and Munitionsfabriken) of Berlin.

TOGGLE: This model should have the new type toggle, with the flat, checkered toggle knobs.

TOGGLE MARK: 

BARREL: This model should have a 4-inch (100mm) barrel. It should be chambered for 9mm Parabellum.

FRAME: The frame on this model should be the late, short type with a wide trigger and narrow trigger guard.

RECEIVER: The receiver on this model should be the late, short type. The chamber should be dated from 1910 through 1913.

THUMB SAFETY: The thumb safety on this model should have a serrated safety lever. The upper position is marked "GESICHERT." Safe is in the lower position.

SIGHTS: The front sight on this model should be a dorsal fin shaped blade, dovetail fit on the barrel. The rear sight should be a fixed V notch in the rear toggle link.

EXTRACTOR: The extractor on this model should be the late type. It should be marked "GELADEN" on the left side.

GRIPS: The grips on this model should be checkered walnut.

MAGAZINE: The magazines original to this model should have a tin-plated, wrap-around body with a wood base. They should be proof marked and serial numbered to the pistol.

FINISH: The main finish on this model should be a high-quality rust blue. The ejector, magazine catch/release, takedown lever, thumb safety lever and trigger should all be straw colored.

SERIAL NUMBER RANGE:

1910 dates from 5000 b to 5500 d
1911 dates from 1500 c to 4825 e
1912 dates from 599 to 9999
1913 dates from 2617 to 315 e

Military production was numbered serially, but not necessarily dated and delivered in the same serial fashion. That is why serial number blocks overlap from year to year.

SERIAL NUMBER LOCATION: The full serial number is found on the bottom of the barrel, the front of the frame, and the left side of the receiver. The last two digits of the serial number are on the breechblock (lower left side), extractor, front toggle link (bottom), rear toggle link (back), sear (left side), sear bar safety lever, side plate, takedown lever (bottom), thumb safety lever (top), trigger (top left), and grips (inside).

INTERESTING VARIATIONS

A very few dated 1914 with no stock lug are reported. For collectors by date by feature, these command a slight premium.

MARKINGS

MARK LOCATION/DESCRIPTION



Toggle
Manufacturer's Logo



Receiver
German Military Proof found only on the 1908 DWM dated model



Barrel, Breechblock and Receiver
German Military Test Fire Proof

VALUES

POOR	FAIR	GOOD	VG	EXC
Dated 1910 to 1913				
\$400	\$500	\$650	\$1,000	\$1,250
Dated 1914				
\$500	\$650	\$850	\$1,200	\$1,500

Look-Up Index # 53

1908 MILITARY, ERFURT



BACKGROUND

The 1908 Military, Erfurt model was made specifically for military sales to the German Army. Some experts believe that DWM could not meet the full demand of the Kaiser's army. Other opinion is that Imperial German military arms had always been produced by government arsenals, so it was only natural for such an arsenal to be positioned for P.08 production.

In either case, the Royal Arsenal at Erfurt began P.08 production of the 1908 pattern Luger with deliveries beginning in 1911.

The features of this model are identical to the 1908 Military, Dated in all respects. The markings differ from the DWM equivalent, however a major distinction can be noticed in the fit and finish. Erfurt Lugers were functionally ugly. Since they were not worried about commercial appeal, their P.08s do not show the fine attention to finish. Residual tool marks are common, if not expected, on Erfurt Lugers.

Erfurt Lugers also exhibit a profuse application of inspector marks to small parts.

HOW TO TELL A 1908 MILITARY, ERFURT

The 1908 Military, Erfurt can be distinguished from other Lugers by four features in combination.

1. Toggle has the Crown ERFURT inscription.
2. A four-digit year date inscription above the chamber.
3. No stock lug.
4. No commercial proof marks (e.g., a Crown/N).

QUANTITY MADE

Approximately: 10,000 in 1911
21,000 in 1912
12,000 in 1913.

Total production of approximately 43,000.

RARITY RATING

2, Common.

FEATURES IN DEPTH

MANUFACTURER: This model was made by the Royal Arsenal at Erfurt.

TOGGLE: This model should have the new type toggle, with the flat, checkered toggle knobs.

TOGGLE MARK: 
ERFURT

BARREL: This model should have a 4-inch (100mm) barrel. It should be chambered for 9mm Parabellum.

FRAME: The frame on this model should be the late, short type with a wide trigger and narrow trigger guard.

RECEIVER: The receiver on this model should be the late, short type. The chamber should be dated from 1910 through 1913.

THUMB SAFETY: The thumb safety on this model should have a serrated safety lever. The upper position is marked "GESICHERT." Safe is in the lower position.

SIGHTS: The front sight on this model should be a dorsal fin shaped blade, dovetail fit on the barrel. The rear sight should be a fixed V notch in the rear toggle link.

EXTRACTOR: The extractor on this model should be the late type. It should be marked "GELADEN" on the left side.

GRIPS: The grips on this model should be checkered walnut.

MAGAZINE: The magazines original to this model should have a tin-plated, wrap-around body with a wood base. They should be proof marked and serial numbered to the pistol.

FINISH: The main finish on this model should be a high-quality rust blue. The ejector, magazine catch/release, takedown lever, thumb safety lever and trigger should all be straw colored.

SERIAL NUMBER RANGE:

- 1911 dates from 1 to 9600.
- 1912 dates from 250 to 875 b.
- 1913 dates from 575 to 2575 b.

Military production was numbered serially, but not necessarily dated and delivered in the same serial fashion. That is why serial number blocks overlap from year to year.

SERIAL NUMBER LOCATION: The full serial number is found on the bottom of the barrel, the front of the frame, and the left side of the receiver. The last two digits of the serial number are on the breechblock (lower left side), extractor, front toggle link (bottom), rear toggle link (back), sear (left side), sear bar safety lever, side plate, takedown lever (bottom), thumb safety lever (top), trigger (top left), and grips (inside).

INTERESTING VARIATIONS

There are no notable variations of this model.

MARKINGS

MARK	LOCATION/DESCRIPTION
 ERFURT	Toggle Manufacturer's Logo
	Receiver German Military Proof found only on the 1908 Erfurt models
	Receiver Inspection/Acceptance Marks
	Barrel, Breechblock and Receiver German Military Test Fire Proof

VALUES

POOR	FAIR	GOOD	VG	EXC
\$400	\$500	\$650	\$1,200	\$1,400

Look-Up Index # 54

1914 NAVY MILITARY



BACKGROUND

The 1914 Navy Military model was made specifically military sales to the German Navy. This model is sometimes referred to as the 1908 Navy because of the similarities between the 1908 and 1914 patterns, and the mistaken belief that these were delivered starting in 1908. We now know that these were actually ordered by the Navy in late 1914, with delivery following in 1915 and 1916.

HOW TO TELL A 1914 NAVY MILITARY

The 1914 Navy Military can be distinguished from other Lugers by four features in combination.

1. Late, flat, checkered style toggle knobs.
2. No chamber inscription.
3. No grip safety.
4. Military Crown/M proof marks.

QUANTITY MADE

Approximately 8,500.

RARITY RATING

6, Rare.

FEATURES IN DEPTH

MANUFACTURER: This model was manufactured by DWM (Deutsche Waffen and Munitionsfabriken) of Berlin.

TOGGLE: This model should have the new type toggle, with the flat, checkered toggle knobs.

TOGGLE MARK: 

BARREL: This model should have a 6-inch (150mm) barrel. It should be chambered for 9mm Parabellum.

FRAME: The frame on this model should be the late, long type with a stock lug, wide trigger and narrow trigger guard.

RECEIVER: The receiver on this model should be the late, long type. The chamber should be blank.

THUMB SAFETY: The thumb safety on this model should have a serrated safety lever. The upper position is marked "GESICHERT." Safe is in the lower position.

SIGHTS: The front sight on this model should be a dorsal fin shaped blade, dovetail fit on the barrel. The rear sight should be a two-position adjustable V notch located on the back of the rear toggle link.

EXTRACTOR: The extractor on this model should be the late type. It should be marked "GELADEN" on the left side.

GRIPS: The grips on this model should be checkered walnut.

MAGAZINE: The magazines original to this model should have a tin-plated, wrap-around body with a wood base. The base should have concentric circles cut on each side. They should be proof marked and serial numbered to the pistol.

FINISH: The main finish on this model should be a high-quality rust blue. The ejector, magazine catch/release, takedown lever, thumb safety lever and trigger should all be straw colored.

SERIAL NUMBER RANGE: 1000 b to 9999 b (apparently continuing from the serial number block of the previous 1906 2nd Issue Model).

SERIAL NUMBER LOCATION: The full serial number is found on the bottom of the barrel, on the front of the frame, and on the left side of the receiver. The last two digits of the serial number are on the breechblock (lower left side), extractor (bottom), front toggle link (bottom), rear toggle link (back), receiver (rear), sear (left side), sear bar safety lever, side plate (bottom edge), takedown lever (bottom), trigger (top left), and grips (inside).

INTERESTING VARIATIONS

There are no notable variations of this model.

MARKINGS

MARK **LOCATION/DESCRIPTION**



Toggle
Manufacturer's Logo



Barrel
Imperial Navy Proof Mark



Barrel
Imperial Navy Proof Mark



Receiver
Imperial Navy Acceptance
Mark



Receiver
Imperial Navy Acceptance
Mark

VALUES

POOR	FAIR	GOOD	VG	EXC
\$850	\$1,250	\$3,000	\$4,800	\$6,000

Look-Up Index # 55

1914 NAVY COMMERCIAL



BACKGROUND

The 1914 Navy Commercial model was generally made for both domestic sales with Germany as well as abroad. This model is sometimes referred to as the 1908 Navy Commercial because of the similarities between the 1908 and 1914 patterns. Based on the now known delivery date of the 1914 Navy Military model, the author believes that this model should correctly carry the 1914 designation.

HOW TO TELL A 1914 NAVY COMMERCIAL

The 1914 Navy Commercial can be distinguished from other Lugers by four features in combination.

1. Late, flat, checkered style toggle knobs.
2. 6-inch barrel length.
3. No grip safety.
4. BUG proof marks.

QUANTITY MADE

Less than 2,000.

RARITY RATING

6, Rare.

FEATURES IN DEPTH

MANUFACTURER: This model was manufactured by DWM (Deutsche Waffen and Munitionsfabriken) of Berlin.

TOGGLE: This model should have the new type toggle, with the flat, checkered toggle knobs.

TOGGLE MARK: 

BARREL: This model should have a 6-inch (150mm) barrel. It should be chambered for 9mm Parabellum.

FRAME: The frame on this model should be the late, short type with a stock lug, wide trigger and narrow trigger guard.

RECEIVER: The receiver on this model should be the late, short type. The chamber should be blank.

THUMB SAFETY: The thumb safety on this model should have a serrated safety lever. The upper position is marked "GESICHERT." Safe is in the lower position.

SIGHTS: The front sight on this model should be a dorsal fin shaped blade, dovetail fit on the barrel. The rear sight should be a two-position adjustable V notch located on the back of the rear toggle link.

EXTRACTOR: The extractor on this model should be the late type. It should be marked "GELADEN" on the left side.

GRIPS: The grips on this model should be checkered walnut.

MAGAZINE: The magazines original to this model should have a tin-plated, wrap-around body with a wood base. The base should have concentric circles cut on each side. They should not be serial numbered or proof marked.

FINISH: The main finish on this model should be a high-quality rust blue. The ejector, magazine catch/release, takedown lever, thumb safety lever and trigger should all be straw colored.

SERIAL NUMBER RANGE: 44000 to 71500 range.

SERIAL NUMBER LOCATION: The full serial number is found on the bottom of the barrel and on the front of the frame. The last two digits of the serial number are on the breechblock (lower left side), extractor (bottom), front toggle link (bottom), rear toggle link (back), side plate (bottom edge), takedown lever (bottom), trigger (top left) and grips (inside).

INTERESTING VARIATIONS

There are no notable variations of this model.

MARKINGS

MARK **LOCATION/DESCRIPTION**



Toggle
Manufacturer's Logo

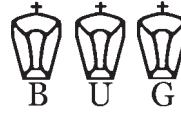

Toggle or Receiver
Commercial Proof

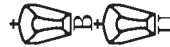

Barrel
German Commercial Proof



Receiver
Nitro Commercial Proof

VALUES

POOR	FAIR	GOOD	VG	EXC
\$1,250	\$1,750	\$2,800	\$4,500	\$6,000

Look-Up Index # 56

1913 COMMERCIAL

BACKGROUND

The 1913 Commercial model was generally made for commercial sales both domestically within Germany as well as abroad.

HOW TO TELL A 1913 COMMERCIAL

The 1913 Commercial can be distinguished from other Lugers by four features in combination.

1. Late, flat, checkered style toggle knobs.
2. Has a grip safety.
3. Has a stock lug.
4. Has only the commercial Crown/N proof.

QUANTITY MADE

1,000.

RARITY RATING

6-7, Rare to very rare. Only six of these are known.

FEATURES IN DEPTH

MANUFACTURER: This model was manufactured by DWM (Deutsche Waffen and Munitionsfabriken) of Berlin.

TOGGLE: This model should have the new type toggle, with the flat, checkered toggle knobs.

TOGGLE MARK: 

BARREL: This model should have a 4-inch (100mm) barrel. It should be chambered for 9mm Parabellum.

FRAME: The frame on this model should be the late, short type with a grip safety, stock lug, wide trigger and narrow trigger guard.

RECEIVER: The receiver on this model should be the late, short type. The chamber should be blank.

THUMB SAFETY: The thumb safety on this model should have a serrated safety lever. The upper position is marked "GESICHERT." Safe is in the lower position.

SIGHTS: The front sight on this model should be a dorsal fin shaped blade, dovetail fit on the barrel. The rear sight should be a fixed V notch in the rear toggle link.

EXTRACTOR: The extractor on this model should be the late type. It should be marked "GELADEN" on the left side.

GRIPS: The grips on this model should be checkered walnut. The left grip should be slotted for the grip safety.

MAGAZINE: The magazines original to this model should have a tin-plated, wrap-around body with a wood base. They should not be serial numbered or proof marked. The base should be marked "Cal 9 m/m."

FINISH: The main finish on this model should be a high-quality rust blue. The ejector, magazine catch/release, takedown lever, thumb safety lever and trigger should all be straw colored.

SERIAL NUMBER RANGE: 71000 to 72000.

SERIAL NUMBER LOCATION: The full serial number is found on the bottom of the barrel and on the front of the frame. The last two digits of the serial number are on the breechblock (lower left side), extractor (bottom), front toggle link (bottom), rear toggle link (back), receiver (rear), side plate (bottom edge), takedown lever (bottom), trigger (top left), grip safety (under grip) and grips (inside).

INTERESTING VARIATIONS

There are no notable variations of this model.

MARKINGS

MARK **LOCATION/DESCRIPTION**

 Toggle
Manufacturer's Logo

 Receiver
Nitro Commercial Proof

VALUES

POOR	FAIR	GOOD	VG	EXC
\$500	\$600	\$750	\$1,200	\$2,000

Look-Up Index # 57

1914 COMMERCIAL

BACKGROUND

The 1914 Commercial model was generally made for commercial sales both domestically within Germany as well as abroad.

HOW TO TELL A 1914 COMMERCIAL

The 1914 Commercial can be distinguished from other Lugers by five features in combination.

1. Late, flat, checkered style toggle knobs.
2. Has a stock lug.
3. No grip safety.
4. Has only the commercial Crown/N proof mark.
5. In the 71500 to 73500 serial number range.

These are easy to confuse with the later 1920 commercials. The serial number range is a key to differentiating them.

QUANTITY MADE

2,000.

RARITY RATING

6, Rare.

FEATURES IN DEPTH

MANUFACTURER: This model was manufactured by DWM (Deutsche Waffen and Munitionsfabriken) of Berlin.

TOGGLE: This model should have the new type toggle, with the flat, checkered toggle knobs.

TOGGLE MARK: 

BARREL: This model should have a 4-inch (100mm) barrel. It should be chambered for 9mm Parabellum.

FRAME: The frame on this model should be the late, short type with a stock lug, wide trigger and narrow trigger guard. Occasionally these will have a name inscription on the left side.

RECEIVER: The receiver on this model should be the late, short type. The chamber should be blank.

THUMB SAFETY: The thumb safety on this model should have a serrated safety lever. The upper position is marked "GESICHERT." Safe is in the lower position.

SIGHTS: The front sight on this model should be a dorsal fin shaped blade, dovetail fit on the barrel. The rear sight should be a fixed V notch in the rear toggle link.

EXTRACTOR: The extractor on this model should be the late type. It should be marked "GELADEN" on the left side.

GRIPS: The grips on this model should be checkered walnut.

MAGAZINE: The magazines original to this model should have a tin-plated, wrap-around body with a wood base. They should not be serial numbered or proof marked.

FINISH: The main finish on this model should be a high-quality rust blue. The ejector, magazine catch/release, takedown lever, thumb safety lever and trigger should all be straw colored.

SERIAL NUMBER RANGE: 71500 to 73500.

SERIAL NUMBER LOCATION: The full serial number is found on the bottom of the barrel and on the front of the frame. The last two digits of the serial number are on the breechblock (lower left side), extractor (bottom), front toggle link (bottom), rear toggle link (back), receiver (rear), side plate (bottom edge), takedown lever (bottom), trigger (top left), and grips (inside).

INTERESTING VARIATIONS

Some 1914 Commercial models are inscribed "R.G." followed by a number on the left side of the frame. These were made specifically for the Reichs-Gendarmerie, a paramilitary police brigade in the Alsace-Lorraine area.

Serial number 72302 is a near a one of a kind 1914 Commercial Luger Carbine. Proofing and serial number range distinguish it from a later model carbine.

MARKINGS

MARK	LOCATION/DESCRIPTION
------	----------------------



	Toggle Manufacturer's Logo
--	-------------------------------



	Receiver Nitro Commercial Proof
--	------------------------------------

VALUES

POOR	FAIR	GOOD	VG	EXC
\$450	\$550	\$750	\$950	\$1,250

Look-Up Index # 58

1914 MILITARY

BACKGROUND

The 1914 Military model was made specifically for military sales to the German Army.

HOW TO TELL A 1914 MILITARY

The 1914 Military can be distinguished from other Lugers by six features in combination.

1. The toggle is marked with the scroll DWM logo.
2. A four-digit year date inscription above the chamber.
3. Has a stock lug.
4. 4-inch barrel length.
5. No commercial proof marks (e.g., a Crown/N).
6. No signs of rework.

QUANTITY MADE

Approximately:	17,000 in 1913
	35,000 in 1914
	105,000 in 1915
	140,000 in 1916
	90,000 in 1917
	118,000 in 1918.

Total production of approximately 505,000.

RARITY RATING

2, Common.

FEATURES IN DEPTH

MANUFACTURER: This model was manufactured by DWM (Deutsche Waffen and Munitionsfabriken) of Berlin.

TOGGLE: This model should have the new type toggle, with the flat, checkered toggle knobs.

TOGGLE MARK: 

BARREL: This model should have a 4-inch (100mm) barrel. It should be chambered for 9mm Parabellum.

FRAME: The frame on this model should be the late, short type with a stock lug, wide trigger and narrow trigger guard.

RECEIVER: The receiver on this model should be the late, short type. The chamber should be dated from 1913 to 1918.

THUMB SAFETY: The thumb safety on this model should have a serrated safety lever. The upper position is marked "GESICHERT." Safe is in the lower position.

180,000 in 1917
175,000 in 1918.

Total production of approximately 453,000.

RARITY RATING

2, Common.

FEATURES IN DEPTH

MANUFACTURER: This model was made by the Royal Arsenal at Erfurt.

TOGGLE: This model should have the new type toggle, with the flat, checkered toggle knobs.

TOGGLE MARK: 
ERFURT

BARREL: This model should have a 4-inch (100mm) barrel. It should be chambered for 9mm Parabellum.

FRAME: The frame on this model should be the late, short type with a stock lug, wide trigger and narrow trigger guard.

RECEIVER: The receiver on this model should be the late, short type. The chamber should be dated from 1914 to 1918. 1915 dates are the most difficult to find.

THUMB SAFETY: The thumb safety on this model should have a serrated safety lever. The upper position is marked "GESICHERT." Safe is in the lower position.

SIGHTS: The front sight on this model should be a dorsal fin shaped blade, dovetail fit on the barrel. The rear sight should be a fixed V notch in the rear toggle link.

EXTRACTOR: The extractor on this model should be the late type. It should be marked "GELADEN" on the left side.

GRIPS: The grips on this model should be checkered walnut.

MAGAZINE: The magazines original to this model should have a tin-plated, wrap-around body with a wood base. They should be proof marked and serial numbered to the pistol.

FINISH: The main finish on this model should be a high-quality rust blue. The ejector, magazine catch/release, takedown lever, thumb safety lever and trigger should all be straw colored.

SERIAL NUMBER RANGE:

- 1913 dates from 575 to 2563 b
- 1914 dates from 504 to 9448 b
- 1915 dates are not reported.
- 1916 dates from 13 to 5775 g
- 1917 dates from 350 to 2860 v
- 1918 dates from 300 to 7538 t





Military production was numbered serially, but not necessarily dated and delivered in the same serial fashion. That is why serial number blocks overlap from year to year.

SERIAL NUMBER LOCATION: The full serial number is found on the bottom of the barrel, the front of the frame, and the left side of the receiver. The last two digits of the serial number are on the breechblock (lower left side), extractor, front toggle link (bottom), rear toggle link (back), sear (left side), sear bar safety lever, side plate, takedown lever (bottom), thumb safety lever (top), trigger (top left), and grips (inside).

INTERESTING VARIATIONS

There are no notable variations of this model.

MARKINGS

MARK	LOCATION/DESCRIPTION
 ERFURT	Toggle Manufacturer's Logo
	Receiver Inspector/Acceptance Mark
	Breechblock Proof Mark
	Barrel and Receiver Proof Mark
	Various Parts Inspection Mark



VALUES

POOR	FAIR	GOOD	VG	EXC
\$400	\$500	\$650	\$750	\$1,250

Look-Up Index # 60

“LANGE” PISTOL 08

BACKGROUND

The Lange Pistole '08 was made specifically as a test model for a desired long-barrel Luger variation. The German military wanted an easy to carry, “carbine-esque” small arm for artillery crewmembers. A small number of detachable-stock, long-barrel P.08s were submitted for military test and evaluation. This is a little known model that predated the well-known artillery models.

HOW TO TELL A LANGE PISTOLE '08

The Lange Pistole '08 can be distinguished from other Lugers by three features in combination.

1. 8-inch barrel with nine-position adjustable rear sight.
2. No date inscription above the chamber.
3. Devoid of all proof marks.

QUANTITY MADE

50.

RARITY RATING

8, Extremely rare.

FEATURES IN DEPTH

MANUFACTURER: This model was manufactured by DWM (Deutsche Waffen and Munitionsfabriken) of Berlin.

TOGGLE: This model should have the new type toggle, with the flat, checkered toggle knobs.

TOGGLE MARK: 

BARREL: This model should have a 8-inch (200mm) barrel. It should be chambered for 9mm Parabellum.

FRAME: The frame on this model should be the late, short type with a stock lug, wide trigger and narrow trigger guard.

RECEIVER: The receiver on this model should be the late, short type. The chamber should be blank.

THUMB SAFETY: The thumb safety on this model should have a serrated safety lever. The upper position is marked “GESICHERT.” Safe is in the lower position.

SIGHTS: The front sight on this model should be a dorsal fin shaped blade, dovetail fit on the barrel. The rear sight should be a nine-position adjustable V notch located on the barrel just forward of the chamber.

EXTRACTOR: The extractor on this model should be the late type. It should be marked “GELADEN” on the left side.

GRIPS: The grips on this model should be checkered walnut.

MAGAZINE: The magazines original to this model should have a tin-plated, wrap-around body with a wood base. They should not be proof marked or serial numbered.

FINISH: The main finish on this model should be a high-quality rust blue. The ejector, magazine catch/release, takedown lever, thumb safety lever and trigger should all be straw colored.

SERIAL NUMBER RANGE: Unconfirmed, but suspected in the 1 to 50 range.

SERIAL NUMBER LOCATION: The full serial number is found on the bottom of the barrel and on the front of the frame. The last two digits of the serial number are on the breechblock (lower left side), extractor (bottom), front toggle link (bottom), rear toggle link (back), receiver (rear), side plate (bottom edge), takedown lever (bottom), trigger (top left), and grips (inside).

INTERESTING VARIATIONS

There are no notable variations of this model.

MARKINGS

MARK	LOCATION/DESCRIPTION
------	----------------------



Toggle
Manufacturer's Logo

VALUES

POOR	FAIR	GOOD	VG	EXC
\$1,000	\$1750	\$2,500	\$4,000	\$6,000

Look-Up Index # 61

1914 ARTILLERY, ERFURT



BACKGROUND

The 1914 Artillery, Erfurt model was made specifically for military sales to the German Army. The successful testing of the Lange P.08 led to the approval of this new variation for military use in early June of 1913.

HOW TO TELL A 1914 ARTILLERY, ERFURT

The 1914 Artillery, Erfurt can be distinguished from other Lugers by three features in combination

1. Toggle has the Crown ERFURT inscription.
2. 8-inch barrel with nine-position adjustable rear sight.
3. A four-digit year date inscription above the chamber.

QUANTITY MADE

Approximately 23,000.

RARITY RATING

3, Uncommon.

FEATURES IN DEPTH

MANUFACTURER: The Royal Arsenal at Erfurt made this model.

TOGGLE: This model should have the new type toggle, with the flat, checkered toggle knobs.

TOGGLE MARK: 
ERFURT

BARREL: This model should have a 8-inch (200mm) barrel. It should be chambered for 9mm Parabellum.

FRAME: The frame on this model should be the late, short type with a stock lug, wide trigger and narrow trigger guard.

RECEIVER: The receiver on this model should be the late, short type. The chamber should be dated from 1914.

THUMB SAFETY: The thumb safety on this model should have a serrated safety lever. The upper position is marked "GESICHERT." Safe is in the lower position.

SIGHTS: The front sight on this model should be a dorsal fin shaped blade, dovetail fit on the barrel. The rear sight should be a nine-position adjustable V notch located on the barrel just forward of the chamber.

EXTRACTOR: The extractor on this model should be the late type. It should be marked "GELADEN" on the left side.

GRIPS: The grips on this model should be checkered walnut.

MAGAZINE: The magazines original to this model should have a tin-plated, wrap-around body with a wood base. They should be proof marked and serial numbered to the pistol.

FINISH: The main finish on this model should be a high-quality rust blue. The ejector, magazine catch/release, takedown lever, thumb safety lever and trigger should all be straw colored.

SERIAL NUMBER RANGE: 1914 dates from 63 to 9999 b.

SERIAL NUMBER LOCATION: The full serial number is found on the bottom of the barrel, the front of the frame, and the left side of the receiver. The last two digits of the serial number are on the breechblock (lower left side), extractor, front toggle link (bottom), rear toggle link (back), rear sight components, sear (left side), sear bar safety lever, side plate, takedown lever (bottom), thumb safety lever (top), trigger (top left), and grips (inside).

INTERESTING VARIATIONS

There are no notable variations of this model.

MARKINGS

MARK	LOCATION/DESCRIPTION
------	----------------------

 ERFURT	Toggle Manufacturer's Logo
--	-------------------------------

	Receiver Inspector/Acceptance Mark
--	---------------------------------------

	Breechblock Proof Mark
--	---------------------------

	Barrel and Receiver Proof Mark
--	-----------------------------------

	Various Parts Inspection Mark
--	----------------------------------

VALUES

POOR	FAIR	GOOD	VG	EXC
\$850	\$1,000	\$1,500	\$2,750	\$3,500

Look-Up Index # 62

1914 ARTILLERY



BACKGROUND

The 1914 Artillery model was made specifically for military sales to the German Army.

HOW TO TELL A 1914 ARTILLERY

The 1914 Artillery can be distinguished from other Lugers by four features in combination.

1. Toggle has the scrolled DWM inscription.
2. 8-inch barrel with nine-position adjustable rear sight.
3. A four-digit year date inscription above the chamber.
4. No commercial proof marks (e.g., a Crown/N).

QUANTITY MADE

Approximately: 5,000 in 1914
 15,000 in 1915
 20,000 in 1916
 90,000 in 1917
 25,000 in 1918.

Total production of approximately 155,000.

RARITY RATING

3, Uncommon.

FEATURES IN DEPTH

MANUFACTURER: This model was manufactured by DWM (Deutsche Waffen and Munitionsfabriken) of Berlin.

TOGGLE: This model should have the new type toggle, with the flat, checkered toggle knobs.

TOGGLE MARK: 

BARREL: This model should have a 8-inch (200mm) barrel. It should be chambered for 9mm Parabellum.

FRAME: The frame on this model should be the late, short type with a stock lug, wide trigger and narrow trigger guard.

RECEIVER: The receiver on this model should be the late, short type. The chamber should be dated from 1914 to 1918.

THUMB SAFETY: The thumb safety on this model should have a serrated safety lever. The upper position is marked "GESICHERT." Safe is in the lower position.

SIGHTS: The front sight on this model should be a dorsal fin shaped blade, dovetail fit on the barrel. The rear sight should be a nine-position adjustable V notch located on the barrel just forward of the chamber.

EXTRACTOR: The extractor on this model should be the late type. It should be marked "GELADEN" on the left side.

GRIPS: The grips on this model should be checkered walnut.

MAGAZINE: The magazines original to this model should have a tin-plated, wrap-around body with a wood base. They should be proof marked and serial numbered to the pistol.

FINISH: The main finish on this model should be a high-quality rust blue. The ejector, magazine catch/release, takedown lever, thumb safety lever and trigger should all be straw colored.

SERIAL NUMBER RANGE:

1914 dates from 262 to 2000 a
 1915 dates from 290 to 7285 a
 1916 dates from 200 to 2660 b
 1917 dates from 248 to 4884 w
 1918 dates from 105 to 1000 e.

Military production was numbered serially, but not necessarily dated and delivered in the same serial fashion. That is why serial number blocks overlap from year to year.

SERIAL NUMBER LOCATION: The full serial number is found on the bottom of the barrel, the front of the frame, and the left side of the receiver. The last two digits of the serial number are on the breechblock (lower left side), extractor, front toggle link (bottom), rear toggle link (back), rear sight components, sear (left side), sear bar safety lever, side plate, takedown lever (bottom), thumb safety lever (top), trigger (top left), and grips (inside).

INTERESTING VARIATIONS

There are no notable variations of this model.

MARKINGS

MARK	LOCATION/DESCRIPTION
------	----------------------



Toggle
 Manufacturer's Logo



Receiver
 Acceptance Mark



Breechblock Proof Mark



Barrel, Breechblock and
 Receiver
 German Military Test Fire
 Proof

VALUES

POOR	FAIR	GOOD	VG	EXC
\$750	\$900	\$1,500	\$2,500	\$3,000

Look-Up Index # 63

1916 NAVY

BACKGROUND

The 1916 Navy model was made specifically for military sales to the German Navy.

HOW TO TELL A 1916 NAVY

The 1916 Navy is easily distinguished from other Lugers by four features in combination.

1. Late, flat, checkered style toggle knobs.
2. Military Crown/M proofs.
3. No grip safety.
4. A four-digit year date inscription above the chamber.

QUANTITY MADE

Approximately: 8,000 in 1916
15,000 in 1917.

Total production of approximately 23,000.

RARITY RATING

4, Scarce.

FEATURES IN DEPTH

MANUFACTURER: This model was manufactured by DWM (Deutsche Waffen and Munitionsfabriken) of Berlin.

TOGGLE: This model should have the new type toggle, with the flat, checkered toggle knobs.

TOGGLE MARK: 

BARREL: This model should have a 6-inch (150mm) barrel. It should be chambered for 9mm Parabellum.

FRAME: The frame on this model should be the late, short type with a stock lug, wide trigger and narrow trigger guard.

RECEIVER: The receiver on this model should be the late, short type. The chamber should be dated from 1916 or 1917.

THUMB SAFETY: The thumb safety on this model should have a serrated safety lever. The upper position is marked "GESICHERT." Safe is in the lower position.

SIGHTS: The front sight on this model should be a dorsal fin shaped blade, dovetail fit on the barrel. The rear sight should be a two-position adjustable V notch located on the back of the rear toggle link.

EXTRACTOR: The extractor on this model should be the late type. It should be marked "GELADEN" on the left side.

GRIPS: The grips on this model should be checkered walnut.

MAGAZINE: The magazines original to this model should have a tin-plated, wrap-around body with a wood base. Some bases have concentric rings cut in each side. They should be proof marked and serial numbered to the pistol.

FINISH: The main finish on this model should be a high-quality rust blue. The ejector, magazine catch/release, takedown lever, thumb safety lever and trigger should all be straw colored.

SERIAL NUMBER RANGE:

- 1916 dates from 1 to 8000
- 1917 dates from 1 to 5000 a.

Military production was numbered serially, but not necessarily dated and delivered in the same serial fashion. That is why serial number blocks overlap from year to year.

SERIAL NUMBER LOCATION: The full serial number is found on the bottom of the barrel, the front of the frame, and the left side of the receiver. The last two digits of the serial number are on the breechblock (lower left side), extractor, front toggle link (bottom), rear toggle link (back), sear (left side), sear bar safety lever, side plate, takedown lever (bottom), thumb safety lever (top), trigger (top left), and grips (inside).

INTERESTING VARIATIONS

There are no notable variations of this model.

MARKINGS

MARK	LOCATION/DESCRIPTION
	Toggle Manufacturer's Logo
	Barrel Imperial Navy Proof Mark
	Barrel Imperial Navy Proof Mark
	Receiver Imperial Navy Acceptance Mark
	Receiver Imperial Navy Acceptance Mark

VALUES

POOR	FAIR	GOOD	VG	EXC
\$850	\$1,250	\$2,000	\$3,000	\$4,500

Look-Up Index # 64

1918 DUTCH NAVY

BACKGROUND

The 1918 Dutch Navy model was made specifically for military sales to the Dutch Navy. We only know about this model from documentation. No actual specimens are reported. A German submarine had run aground on Dutch territory back in 1915. The Dutch confiscated 12 German Navy P.04s (presumed to be 1906 Navy Models). Then in 1918, an order for 28 additional Lugers was authorized by the Inspector of Dutch Naval Artillery. This would provide 40 total pistols with which to arm the 39 spotter pilots of the Naval Air Service. These jointly became known as the Automatic Pistol No. 1, German Navy Model.

We can safely assume that the 12 confiscated Lugers were 1906 Navy models (either 1st or 2nd issue, we are not sure). There is less certainty as to the pattern of the 28 new purchased pistols. The 1914 pattern had subsequently discontinued the grip safety. The position of the thumb safety with the safety engaged is uncertain. We don't even know for a fact if the new Lugers had navy type sights on a 6-inch barrel. What follows is a best educated guess.

HOW TO TELL A 1918 DUTCH NAVY

The 1918 Dutch Navy can be distinguished from other Lugers by four features in combination.

1. Late, flat, checkered style toggle knobs.
2. 6-inch barrel length.
3. Has a grip safety.
4. Safety marked "RUST" with a downward arrow.

QUANTITY MADE

28.

RARITY RATING

8, Extremely rare.

FEATURES IN DEPTH

MANUFACTURER: This model was manufactured by DWM (Deutsche Waffen and Munitionsfabriken) of Berlin.

TOGGLE: This model should have the new type toggle, with the flat, checkered toggle knobs.

TOGGLE MARK: 

BARREL: This model should have a 6-inch (150mm) barrel. It should be chambered for 9mm Parabellum.

FRAME: The frame on this model should be the late, long type with a grip safety, stock lug, wide trigger and narrow trigger guard.

RECEIVER: The receiver on this model should be the late, long type. The chamber should be blank.

THUMB SAFETY: The thumb safety on this model should have a serrated safety lever. It is marked "RUST" with a curved arrow pointing to the safe position (probably down).

SIGHTS: The front sight on this model should be a dorsal fin shaped blade, dovetail fit on the barrel. The rear sight should be a two-position adjustable V notch located on the back of the rear toggle link.

EXTRACTOR: The extractor on this model should be the late type. It should be marked "GELADEN" on both sides.

GRIPS: The grips on this model should be checkered walnut. The left grip might possibly be slotted for a grip safety.

MAGAZINE: The magazines original to this model should have a tin-plated, wrap-around body with a wood base. The base might possibly have concentric circles cut on each side.

FINISH: The main finish on this model should be a high-quality rust blue. The ejector, magazine catch/release, takedown lever, thumb safety lever and trigger should all be straw colored.

SERIAL NUMBER RANGE: Unknown

SERIAL NUMBER LOCATION: The full serial number is found on the bottom of the barrel and on the front of the frame. The last two digits of the serial number are on the breechblock (lower left side), extractor (bottom), front toggle link (bottom), rear toggle link (back), receiver (rear), side plate (bottom edge), takedown lever (bottom), trigger (top left), grip safety (under grip) and grips (inside).

INTERESTING VARIATIONS

There are no notable variations of this model.

MARKINGS

MARK	LOCATION/DESCRIPTION
------	----------------------



Toggle
Manufacturer's Logo

VALUES

POOR	FAIR	GOOD	VG	EXC
\$850	\$1,250	\$2,000	\$3,200	\$4,500

THE WEIMAR ERA BEGINS

SPECIAL NOTE:

The next several Luger models represent a dizzying array of post-WW I reworks and newly manufactured P.08s for various military and paramilitary purposes.

Individually, these can be difficult to differentiate. This outline should help.

I. Reworks

- i. Originally DWM Made P.08s
 - 1. Reworked by Erfurt (Double Dates)
 - a. Reworked for Army use
 - b. Reworked for Police use
 - c. Reworked for Navy use
 - 2. Reworked by DWM (Dated)
 - a. Dated Rework Models
 - i. Reworked for Army use
 - ii. Reworked for Police use
 - iii. Reworked for Navy use
 - b. No Date Rework Models
 - i. Reworked for Army use
 - ii. Reworked for Police use
 - iii. Reworked for Navy use
- ii. Originally Erfurt Made P.08s
 - 1. Reworked by Erfurt (double dates)
 - a. Reworked for Army use
 - b. Reworked for Police use
 - c. Reworked for Navy use
 - 2. Reworked by DWM
 - a. Dated
 - i. Reworked for Army use
 - ii. Reworked for Police use
 - iii. Reworked for Navy use
 - b. No Date
 - i. Reworked for Army use
 - ii. Reworked for Police use
 - iii. Reworked for Navy use

II. New Manufacture (DWM Only)

- i. New Manufacture Double Dated P.08s
 - 1. Made for Army use
 - 2. Made for Police use
 - 3. THERE ARE NO KNOWN NEW MANUFACTURED NAVY DOUBLE DATES.

- ii. New Manufacture Single Dated P.08s
 - 1. Made for Army use
 - 2. Made for Police use
 - 3. Made for Navy use
 - a. Standard Markings
 - b. M/A Marked
- iii. New Manufacture No Date P.08s
 - 1. Made for Army use
 - 2. Made for Police use
 - 3. Made for Navy use
 - a. Standard Markings
 - b. M/A Marked
- III. Simson Marked Reworks
- IV. Factory Sneaks

Look-Up Index # 65

DWM DOUBLE DATE, ARMY REWORK



BACKGROUND

The DWM Double Date, Army Rework model was made specifically for Army consumption within the Weimar military (known as the Reichswehr). The Versailles Treaty placed tight controls on arms available to the Reichswehr. This model was the first type to fill that limited allowance.

This model actually constituted reworked DWM 1908 and 1914 Military models. The second date (1920) was actually a Reichswehr property stamp, was used to enforce the firearms controls dictated by the Versailles Treaty.

It is believed that these reworks were all processed and marked at Erfurt.

HOW TO TELL A DWM DOUBLE DATE, ARMY REWORK

The DWM Double Date, Army Rework can be distinguished from other Lugers by five features in combination.

- 1. The toggle is marked with the scroll DWM logo.
- 2. The chamber inscription consists of two four-digit year dates.
- 3. The lower date should be 1918 or earlier.

4. Make sure it does not have any police type (sear safety, police unit marks or police acceptance marks) indications.
5. No Kriegsmarine marks.

QUANTITY MADE

Many thousand (including the Double Date Navy and Police Rework models).

RARITY RATING

3, Uncommon.

FEATURES IN DEPTH

MANUFACTURER: The pistols of this model were originally manufactured by DWM (Deutsche Waffen and Munitionsfabriken).

TOGGLE: This model should have the new type toggle, with the flat, checkered toggle knobs.

TOGGLE MARK: 

BARREL: This model should have a 4-inch (100mm) barrel. It should be chambered for 9mm Parabellum.

FRAME: This model should retain the same frame as the original P.08 being reworked. This would likely be the late, short type with a stock lug (some without), a wide trigger and narrow trigger guard.

RECEIVER: This model should retain the same receiver as the original P.08 being reworked. This would likely be the late, short type. It should have two different four-digit year date inscriptions. The lower date should be from 1908 through 1918. The upper (added) date should be 1920.

THUMB SAFETY: The thumb safety on this model should have a serrated safety lever. The upper position is marked "GESICHERT." Safe is in the lower position.

SIGHTS: The front sight on this model should be a dorsal fin shaped blade, dovetail fit on the barrel. The rear sight should be a fixed V notch in the rear toggle link.

EXTRACTOR: The extractor on this model should be the late type. It should be marked "GELADEN" on the left side.

GRIPS: The grips on this model should be checkered walnut.

MAGAZINE: The magazines original to this model should have a tin-plated, wrap-around body with a wood base. They should be proof marked and serial numbered to the pistol.

FINISH: The main finish on this model should be a high-quality rust blue. The ejector, magazine catch/release, takedown lever, thumb safety lever and trigger should all be straw colored.

SERIAL NUMBER RANGE: The pistols of this model should retain the original serial number of the model being reworked.

SERIAL NUMBER LOCATION: The full serial number is found on the bottom of the barrel, the front of the frame, and the left side of the receiver. The last two digits of the serial number are on the breechblock (lower left side), extractor, front toggle link (bottom), rear toggle link (back), sear (left side), sear bar safety lever, side plate, takedown lever (bottom), thumb safety lever (top), trigger (top left), and grips (inside).

INTERESTING VARIATIONS

There are rare naval and artillery length barrel variations of this model. Perhaps most rare are Imperial naval models which are either rebarreled or have been cut down to 4-inch barrels.

MARKINGS

MARK	LOCATION/DESCRIPTION
------	----------------------



	Toggle Manufacturer's Logo
--	-------------------------------

The pistols of this model usually retain most of their original military proof marks (see the Imperial Naval and 1908 and 1914 military models for details). In addition, these will occasionally have some combination of the following marks added.



	Receiver This mark's meaning is unknown
--	--

Weimar era reworks will also occasionally be found with an ordnance depot rework stamp. Examples of common types are shown below.

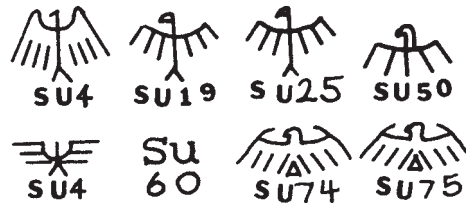

Other eagle/su number combinations possible.

VALUES

POOR	FAIR	GOOD	VG	EXC
\$375	\$775	\$1,100	\$1,500	\$2,000

Look-Up Index # 66

DWM DOUBLE DATE, POLICE REWORK

BACKGROUND

The DWM Double Date, Police Rework model has the same origin as the Double Date Army Rework model (see the preceding model), but with different proofing for Weimar Police use.

HOW TO TELL A DWM DOUBLE DATE, POLICE REWORK

The DWM Double Date, Police Rework can be distinguished from other Lugers by four features in combination.

1. The toggle is marked with the scroll DWM logo.
2. The chamber inscription consists of two four-digit year dates.
3. The lower date should be 1918 or earlier.
4. It has some indication of police use (sear safety added, police unit marks or police acceptance marks).

QUANTITY MADE

Many thousand (including the Double Date Army and Navy Rework models).

RARITY RATING

- 3, Uncommon.

FEATURES IN DEPTH

MANUFACTURER: The pistols of this model were originally manufactured by DWM (Deutsche Waffen and Munitionsfabriken).

TOGGLE: This model should have the new type toggle, with the flat, checkered toggle knobs.

TOGGLE MARK: 

BARREL: This model should have a 4-inch (100mm) barrel. It should be chambered for 9mm Parabellum.

FRAME: This model should retain the same frame as the original P.08 being reworked. This would likely be the late, short type with a stock lug (some without), a wide trigger and narrow trigger guard.

RECEIVER: This model should retain the same receiver as the original P.08 being reworked. This would likely be the late, short type. It should have two different four-digit year date inscriptions. The lower date should be from 1908 through 1918. The upper (added) date should be 1920.

THUMB SAFETY: The thumb safety on this model should have a serrated safety lever. The upper position is marked "GESICHERT." Safe is in the lower position.

SIGHTS: The front sight on this model should be a dorsal fin shaped blade, dovetail fit on the barrel. The rear sight should be a fixed V notch in the rear toggle link.

EXTRACTOR: The extractor on this model should be the late type. It should be marked "GELADEN" on the left side.

GRIPS: The grips on this model should be checkered walnut.

MAGAZINE: The magazines original to this model should have a tin-plated, wrap-around body with a wood base. They should be proof marked and serial numbered to the pistol.

FINISH: The main finish on this model should be a high-quality rust blue. The ejector, magazine catch/release, takedown lever, thumb safety lever and trigger should all be straw colored.

SERIAL NUMBER RANGE: The pistols of this model should retain the original serial number of the model being reworked.

SERIAL NUMBER LOCATION: The full serial number is found on the bottom of the barrel, the front of the frame, and the left side of the receiver. The last two digits of the serial number are on the breechblock (lower left side), extractor, front toggle link (bottom), rear toggle link (back), sear (left side), sear bar safety lever, side plate, takedown lever (bottom), thumb safety lever (top), trigger (top left), and grips (inside).

INTERESTING VARIATIONS

There are no notable variations of this model.

MARKINGS

MARK	LOCATION/DESCRIPTION
------	----------------------



	Toggle Manufacturer's Logo
--	-------------------------------

The pistols of this model usually retain most of their original military proof marks (see the Imperial Naval and 1908 and 1914 military models for details). In addition, these will occasionally have some combination of the following marks added.



	Receiver This mark's meaning is unknown
--	--



	Barrel Berlin Police Armory Acceptance Stamp
--	--

Following are some variations of this mark.



Weimar era reworks will also occasionally be found with an ordnance depot rework stamp. Examples of common types are shown below.

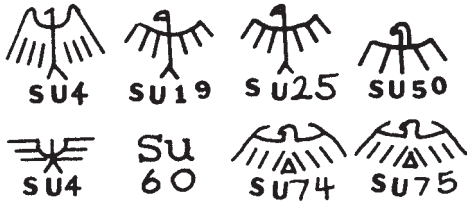

Other eagle/su number combinations possible.

VALUES

POOR	FAIR	GOOD	VG	EXC
\$375	\$775	\$1,100	\$1,500	\$2,000

Look-Up Index # 67

DWM DOUBLE DATE, NAVY REWORK

BACKGROUND

The DWM Double Date, Navy Rework model has the same origin as the Double Date Army Rework model (see the preceding model), but with different proofing for Weimar Navy use.

HOW TO TELL A DWM DOUBLE DATE, NAVY REWORK

The DWM Double Date, Navy Rework can be distinguished from other Lugers by four features in combination.

1. The toggle is marked with the scroll DWM logo.
2. The chamber inscription consists of two four-digit year dates.
3. The lower date should be 1918 or earlier.
4. Weimar Navy type rework marks.

QUANTITY MADE

Many thousand (including the Double Date Army and Police Rework models).

RARITY RATING

3, Uncommon.

FEATURES IN DEPTH

MANUFACTURER: The pistols of this model were originally manufactured by DWM (Deutsche Waffen and Munitionsfabriken).

TOGGLE: This model should have the new type toggle, with the flat, checkered toggle knobs.



BARREL: This model should have a 4-inch (100mm) barrel. It should be chambered for 9mm Parabellum.

FRAME: This model should retain the same frame as the original P.08 being reworked. This would likely be the late, short type with a stock lug (some without), a wide trigger and narrow trigger guard.

RECEIVER: This model should retain the same receiver as the original P.08 being reworked. This would likely be the late, short type. It should have two different four-digit year date inscriptions. The lower date should be from 1908 through 1918. The upper (added) date should be 1920.

THUMB SAFETY: The thumb safety on this model should have a serrated safety lever. The upper position is marked "GESICHERT." Safe is in the lower position.

SIGHTS: The front sight on this model should be a dorsal fin shaped blade, dovetail fit on the barrel. The rear sight should be a fixed V notch in the rear toggle link.

EXTRACTOR: The extractor on this model should be the late type. It should be marked "GELADEN" on the left side.

GRIPS: The grips on this model should be checkered walnut.

MAGAZINE: The magazines original to this model should have a tin-plated, wrap-around body with a wood base. They should be proof marked and serial numbered to the pistol.

FINISH: The main finish on this model should be a high-quality rust blue. The ejector, magazine catch/release, takedown lever, thumb safety lever and trigger should all be straw colored.

SERIAL NUMBER RANGE: The pistols of this model should retain the original serial number of the model being reworked.

SERIAL NUMBER LOCATION: The full serial number is found on the bottom of the barrel, the front of the frame, and the left side of the receiver. The last two digits of the serial number are on the breechblock (lower left side), extractor, front toggle link (bottom), rear toggle link (back), sear (left side), sear bar safety lever, side plate, takedown lever (bottom), thumb safety lever (top), trigger (top left), and grips (inside).

INTERESTING VARIATIONS

There are rare naval length barrel variations of this model. Perhaps most rare are Imperial naval models

which are either rebarreled or have been cut down to 4-inch barrels.

MARKINGS

MARK LOCATION/DESCRIPTION



Toggle
Manufacturer's Logo

The pistols of this model usually retain most of their original military proof marks (see the Imperial Naval and 1908 and 1914 military models for details). In addition, these will have some combination of the following marks added.



Receiver
This mark's meaning is unknown

N. Number
or
O. Number

Grip Strap
Nordsee Fleet Property Number
Ostsee Fleet Property Number



Grip Strap
Navy Acceptance Mark

or



Barrel
Navy Acceptance Mark

Weimar era reworks will also occasionally be found with an ordnance depot rework stamp. Examples of common types are shown below.

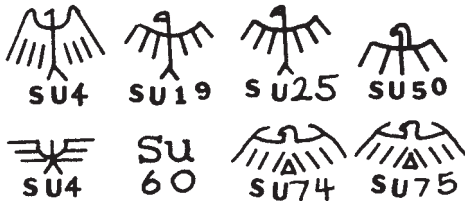

Other eagle/su number combinations possible.

VALUES

POOR	FAIR	GOOD	VG	EXC
\$500	\$1,000	\$1,500	\$2,500	\$3,000

Look-Up Index # 68

ERFURT DOUBLE DATE, ARMY REWORK

BACKGROUND

The Erfurt Double Date, Army Rework model was made specifically for military and police consumption within the Weimar military (known as the Reichswehr). The Versailles Treaty placed tight controls on arms available to the Reichswehr. Like the DWM Double Date Reworks, this model was the first type to fill that limited allowance.

This model actually constituted reworked Erfurt 1908 and 1914 Military models. The second date (1920) was actually a Reichswehr property stamp, used to enforce the firearms controls dictated by the Versailles Treaty were monitored.

It is believed that these reworks were all processed and marked at Erfurt.

HOW TO TELL AN ERFURT DOUBLE DATE, ARMY REWORK

The Erfurt Double Date, Army Rework can be distinguished from other Lugers by five features in combination.

1. The toggle is marked with the Crown Erfurt logo.
2. The chamber inscription consists of two four-digit year dates.
3. The lower date should be 1918 or earlier.
4. Make sure it does not have any police type (safety, police unit marks or police acceptance marks) indications.
5. No Kriegsmarine marks.

QUANTITY MADE

Many thousand (including the Double Date Navy and Police Rework models).

RARITY RATING

3, Uncommon.

FEATURES IN DEPTH

MANUFACTURER: The pistols of this model were originally manufactured by the Royal Arsenal at Erfurt.

TOGGLE: This model should have the new type toggle, with the flat, checkered toggle knobs.

TOGGLE MARK: 
ERFURT

BARREL: This model should have a 4-inch (100mm) barrel. It should be chambered for 9mm Parabellum.

1. The toggle is marked with the Crown Erfurt logo.
2. The chamber inscription consists of two four-digit year dates.
3. The lower date should be 1918 or earlier.
4. It has some indication of police use (sear safety added, police unit marks or police acceptance marks).

QUANTITY MADE

Many thousand (including the Double Date Army and Navy Rework models).

RARITY RATING

3, Uncommon.

FEATURES IN DEPTH

MANUFACTURER: The pistols of this model were originally manufactured by the Royal Arsenal at Erfurt.

TOGGLE: This model should have the new type toggle, with the flat, checkered toggle knobs.

TOGGLE MARK: 
ERFURT

BARREL: This model should have a 4-inch (100mm) barrel. It should be chambered for 9mm Parabellum.

FRAME: This model should retain the same frame as the original P.08 being reworked. This would likely be the late, short type with a stock lug (some without), a wide trigger and narrow trigger guard.

RECEIVER: This model should retain the same receiver as the original P.08 being reworked. This would likely be the late, short type. It should have two different four-digit year date inscriptions. The lower date should be from 1908 through 1918. The upper (added) date should be 1920.

THUMB SAFETY: The thumb safety on this model should have a serrated safety lever. The upper position is marked "GESICHERT." Safe is in the lower position.

SIGHTS: The front sight on this model should be a dorsal fin shaped blade, dovetail fit on the barrel. The rear sight should be a fixed V notch in the rear toggle link.

EXTRACTOR: The extractor on this model should be the late type. It should be marked "GELADEN" on the left side.

GRIPS: The grips on this model should be checkered walnut.

MAGAZINE: The magazines original to this model should have a tin-plated, wrap-around body with a wood base. They should be proof marked and serial numbered to the pistol.

FINISH: The main finish on this model should be a high-quality rust blue. The ejector, magazine catch/

release, takedown lever, thumb safety lever and trigger should all be straw colored.

SERIAL NUMBER RANGE: The pistols of this model should retain the original serial number of the model being reworked.

SERIAL NUMBER LOCATION: The full serial number is found on the bottom of the barrel, the front of the frame, and the left side of the receiver. The last two digits of the serial number are on the breechblock (lower left side), extractor, front toggle link (bottom), rear toggle link (back), sear (left side), sear bar safety lever, side plate, takedown lever (bottom), thumb safety lever (top), trigger (top left), and grips (inside).

INTERESTING VARIATIONS

There is a rare artillery length barrel variation of this model.

MARKINGS

MARK	LOCATION/DESCRIPTION
 ERFURT	Toggle Manufacturer's Logo

The pistols of this model usually retain most of their original military proof marks (see the 1908 and 1914 military models for details). In addition, these will occasionally have some combination of the following marks added.

 Receiver
This mark's meaning is unknown

 Barrel
Berlin Police Armory
Acceptance Stamp

Following are some variations of this mark.



Weimar era reworks will also occasionally be found with an ordnance depot rework stamp. Examples of common types are shown on top of next page.

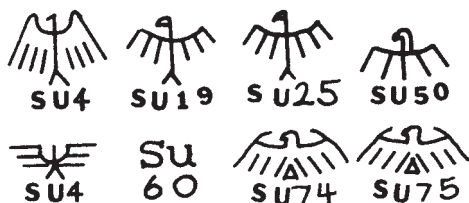

Other eagle/su number combinations possible.

VALUES

POOR	FAIR	GOOD	VG	EXC
\$375	\$775	\$1,100	\$1,500	\$2,000

Look-Up Index # 70

ERFURT DOUBLE DATE, NAVY REWORK

BACKGROUND

The Erfurt Double Date, Navy Rework model has the same origin as the Double Date Army Rework model (see the preceding model), but with different proofing for Weimar Navy use.

HOW TO TELL AN ERFURT DOUBLE DATE, NAVY REWORK

The Erfurt Double Date, Navy Rework can be distinguished from other Lugers by four features in combination.

1. The toggle is marked with the Crown Erfurt logo.
2. The chamber inscription consists of two four-digit year dates.
3. The lower date should be 1918 or earlier.
4. Weimar Navy type rework marks.

QUANTITY MADE

Many thousand (including the Double Date Army and Police Rework models).

RARITY RATING

3, Uncommon.

FEATURES IN DEPTH

MANUFACTURER: The pistols of this model were originally manufactured by the Royal Arsenal at Erfurt.

TOGGLE: This model should have the new type toggle, with the flat, checkered toggle knobs.

TOGGLE MARK:



BARREL: This model should have a 4-inch (100mm) barrel. It should be chambered for 9mm Parabellum.

FRAME: This model should retain the same frame as the original P.08 being reworked. This would likely be the late, short type with a stock lug (some without), a wide trigger and narrow trigger guard.

RECEIVER: This model should retain the same receiver as the original P.08 being reworked. This would likely be the late, short type. It should have two different four-digit year date inscriptions. The lower date should be from 1908 through 1918. The upper (added) date should be 1920.

THUMB SAFETY: The thumb safety on this model should have a serrated safety lever. The upper position is marked "GESICHERT." Safe is in the lower position.

SIGHTS: The front sight on this model should be a dorsal fin shaped blade, dovetail fit on the barrel. The rear sight should be a fixed V notch in the rear toggle link.

EXTRACTOR: The extractor on this model should be the late type. It should be marked "GELADEN" on the left side.

GRIPS: The grips on this model should be checkered walnut.

MAGAZINE: The magazines original to this model should have a tin-plated, wrap-around body with a wood base. They should be proof marked and serial numbered to the pistol.

FINISH: The main finish on this model should be a high-quality rust blue. The ejector, magazine catch/release, takedown lever, thumb safety lever and trigger should all be straw colored.

SERIAL NUMBER RANGE: The pistols of this model should retain the original serial number of the model being reworked.

SERIAL NUMBER LOCATION: The full serial number is found on the bottom of the barrel, the front of the frame, and the left side of the receiver. The last two digits of the serial number are on the breechblock (lower left side), extractor, front toggle link (bottom), rear toggle link (back), sear (left side), sear bar safety lever, side plate, takedown lever (bottom), thumb safety lever (top), trigger (top left), and grips (inside).

INTERESTING VARIATIONS

There are no notable variations of this model.

MARKINGS

MARK **LOCATION/DESCRIPTION**



Toggle
Manufacturer's Logo

The pistols of this model usually retain most of their original military proof marks (see the 1908 and 1914 military models for details). In addition, these will occasionally have some combination of the following marks added.



Receiver
This mark's meaning is unknown

N. Number
or
O. Number

Grip Strap
Nordsee Fleet Property Number
Ostsee Fleet Property Number



Grip Strap
Navy Acceptance Mark

Weimar era reworks will also occasionally be found with an ordnance depot rework stamp. Examples of common types are shown below.

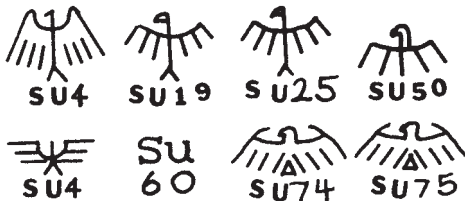

Other eagle/su number combinations possible.

VALUES

POOR	FAIR	GOOD	VG	EXC
\$500	\$1,000	\$1,500	\$2,500	\$3,000

Look-Up Index # 71

DWM DATED, ARMY REWORK

BACKGROUND

The DWM Dated, Army Rework model was made specifically for post-WW I German Army units. Sometimes this model (along with the Dated, Navy Rework and the Dated, Police Rework collectively) is

referred to as the 1920 Military and Police Rework model.

The theory is that while Erfurt reworks for the Weimar Reichswehr were the double date rework models, the removal of the original date with a 1920 date added (this model) indicates a DWM rework.

The P.08s of this model joined the DWM and Erfurt marked double dates, to satisfy part of the allowed Reichswehr inventory.

HOW TO TELL A DWM DATED, ARMY REWORK

The DWM Dated, Army Rework can be distinguished from other Lugers by four features in combination.

1. The toggle is marked with the scroll DWM logo.
2. A single four-digit year date (either 1920 or 1921) inscription above the chamber.
3. Imperial military proof marks (see the 1908 and 1914 military models for details), or signs of having had proof marks or a chamber date removed.
4. Weimar Reichswehr type rework marks.

QUANTITY MADE

Several thousand (including the Dated, Navy and Police Rework models).

RARITY RATING

2, Common.

FEATURES IN DEPTH

MANUFACTURER: This model was manufactured by DWM (Deutsche Waffen and Munitionsfabriken) of Berlin.

TOGGLE: This model should have the new type toggle, with the flat, checkered toggle knobs.



BARREL: This model should have a 4-inch (100mm) barrel. It should be chambered for 9mm Parabellum.

FRAME: The frame on this model should be the late, short type with a stock lug, wide trigger and narrow trigger guard.

RECEIVER: The receiver on this model should be the late, short type. The chamber should be dated from 1920.

THUMB SAFETY: The thumb safety on this model should have a serrated safety lever. The upper position is marked "GESICHERT." Safe is in the lower position.

SIGHTS: The front sight on this model should be a dorsal fin shaped blade, dovetail fit on the barrel. The rear sight should be a fixed V notch in the rear toggle link.

EXTRACTOR: The extractor on this model should be the late type. It should be marked "GELADEN" on the left side.

GRIPS: The grips on this model should be checkered walnut or beech.

MAGAZINE: The magazines original to this model should have a tin-plated, wrap-around body with a wood base. They should be proof marked and serial numbered to the pistol.

FINISH: The main finish on this model should be a high-quality rust blue. The ejector, magazine catch/release, takedown lever, thumb safety lever and trigger should all be straw colored.

SERIAL NUMBER RANGE: The pistols of this model should retain the original serial number of the model being reworked.

SERIAL NUMBER LOCATION: The full serial number is found on the bottom of the barrel, the front of the frame, and the left side of the receiver. The last two digits of the serial number are on the breechblock (lower left side), extractor, front toggle link (bottom), rear toggle link (back), sear (left side), sear bar safety lever, side plate, takedown lever (bottom), thumb safety lever (top), trigger (top left), and grips (inside).

INTERESTING VARIATIONS

There are rare naval and artillery length barrel variations of this model. Perhaps most rare are Imperial naval models which are either rebarreled or have been cut down to 4-inch barrels.

MARKINGS

MARK LOCATION/DESCRIPTION



Toggle
Manufacturer's Logo

The pistols of this model usually retain most of their original military proof marks (see the Imperial Naval and 1908 and 1914 military models for details). In addition, these will occasionally have some combination of the following marks added.



Receiver
This mark's meaning is unknown

Weimar era reworks will also occasionally be found with an ordnance depot rework stamp. Examples of common types are shown (top right).

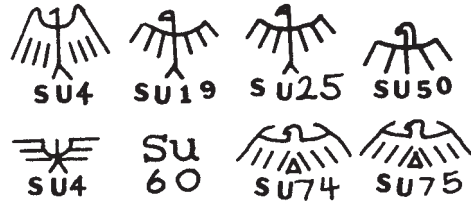

Other eagle/su number combinations possible.

VALUES

POOR	FAIR	GOOD	VG	EXC
\$375	\$500	\$750	\$1,000	\$1,250

Look-Up Index # 72

DWM DATED, POLICE REWORK

BACKGROUND

The DWM Dated, Police Rework model has the same origin as the Dated, Army Rework model (see the preceding model), but with different proofing for Weimar Police use.

HOW TO TELL A DWM DATED, POLICE REWORK

The DWM Dated, Police Rework can be distinguished from other Lugers by four features in combination.

1. The toggle is marked with the scroll DWM logo.
2. A single four-digit year date (either 1920 or 1921) inscription above the chamber.
3. Imperial military proof marks (see the 1908 and 1914 military models for details), or signs of having had proof marks or a chamber date removed.
4. Weimar Police type rework marks.

QUANTITY MADE

Several thousand (including the Dated, Army and Navy Rework models).

RARITY RATING

2, Common.

FEATURES IN DEPTH

MANUFACTURER: This model was manufactured by DWM (Deutsche Waffen and Munitionsfabriken) of Berlin.

TOGGLE: This model should have the new type toggle, with the flat, checkered toggle knobs.

TOGGLE MARK: 

BARREL: This model should have a 4-inch (100mm) barrel. It should be chambered for 9mm Parabellum.

FRAME: The frame on this model should be the late, short type with a stock lug, wide trigger and narrow trigger guard.

RECEIVER: The receiver on this model should be the late, short type. The chamber should be dated from 1920.

THUMB SAFETY: The thumb safety on this model should have a serrated safety lever. The upper position is marked "GESICHERT." Safe is in the lower position.

SIGHTS: The front sight on this model should be a dorsal fin shaped blade, dovetail fit on the barrel. The rear sight should be a fixed V notch in the rear toggle link.

EXTRACTOR: The extractor on this model should be the late type. It should be marked "GELADEN" on the left side.

GRIPS: The grips on this model should be checkered walnut or beech.

MAGAZINE: The magazines original to this model should have a tin-plated, wrap-around body with a wood base. They should be proof marked and serial numbered to the pistol.

FINISH: The main finish on this model should be a high-quality rust blue. The ejector, magazine catch/release, takedown lever, thumb safety lever and trigger should all be straw colored.

SERIAL NUMBER RANGE: The pistols of this model should retain the original serial number of the model being reworked.

SERIAL NUMBER LOCATION: The full serial number is found on the bottom of the barrel, the front of the frame, and the left side of the receiver. The last two digits of the serial number are on the breechblock (lower left side), extractor, front toggle link (bottom), rear toggle link (back), sear (left side), sear bar safety lever, side plate, takedown lever (bottom), thumb safety lever (top), trigger (top left), and grips (inside).

INTERESTING VARIATIONS

There are no notable variations of this model.

MARKINGS

MARK **LOCATION/DESCRIPTION**



Toggle
Manufacturer's Logo

The pistols of this model usually retain most of their original military proof marks (see the Imperial Naval and 1908 and 1914 military models for details). In addition, these will occasionally have some combination of the following marks added.



Receiver
This mark's meaning is unknown



Barrel
Berlin Police Armory
Acceptance Stamp

Following are some variations of this mark.



Weimar era reworks will also occasionally be found with an ordnance depot rework stamp. Examples of common types are shown below.



Other eagle/su number combinations possible.

VALUES

POOR	FAIR	GOOD	VG	EXC
\$375	\$500	\$750	\$1,000	\$1,250

Look-Up Index # 73

DWM DATED, NAVY REWORK

BACKGROUND

The DWM Dated, Navy Rework model has the same origin as the Dated, Army Rework model (see the preceding model), but with different proofing for Weimar Navy use.

HOW TO TELL A DWM DATED, NAVY REWORK

The DWM Dated, Navy Rework can be distinguished from other Lugers by four features in combination.

1. The toggle is marked with the scroll DWM logo.
2. A single four-digit year date (either 1920 or 1921) inscription above the chamber.
3. Imperial military proof marks (see the 1908 and 1914 military models for details), or signs of having had proof marks or a chamber date removed.
4. Weimar Navy type rework marks.

QUANTITY MADE

Several thousand (including the Dated, Army and Police Rework models).

RARITY RATING

2, Common.

FEATURES IN DEPTH

MANUFACTURER: This model was manufactured by DWM (Deutsche Waffen and Munitionsfabriken) of Berlin.

TOGGLE: This model should have the new type toggle, with the flat, checkered toggle knobs.

TOGGLE MARK: 

BARREL: This model should have a 4-inch (100mm) barrel. It should be chambered for 9mm Parabellum.

FRAME: The frame on this model should be the late, short type with a stock lug, wide trigger and narrow trigger guard.

RECEIVER: The receiver on this model should be the late, short type. The chamber should be dated from 1920.

THUMB SAFETY: The thumb safety on this model should have a serrated safety lever. The upper position is marked "GESICHERT." Safe is in the lower position.

SIGHTS: The front sight on this model should be a dorsal fin shaped blade, dovetail fit on the barrel. The rear sight should be a fixed V notch in the rear toggle link.

EXTRACTOR: The extractor on this model should be the late type. It should be marked "GELADEN" on the left side.

GRIPS: The grips on this model should be checkered walnut or beech.

MAGAZINE: The magazines original to this model should have a tin-plated, wrap-around body with a wood base. They should be proof marked and serial numbered to the pistol.

FINISH: The main finish on this model should be a high-quality rust blue. The ejector, magazine catch/release, takedown lever, thumb safety lever and trigger should all be straw colored.

SERIAL NUMBER RANGE: The pistols of this model should retain the original serial number of the model being reworked.

SERIAL NUMBER LOCATION: The full serial number is found on the bottom of the barrel, the front of the frame, and the left side of the receiver. The last two digits of the serial number are on the breechblock (lower left side), extractor, front toggle link (bottom), rear toggle link (back), sear (left side), sear bar safety lever, side plate, takedown lever (bottom), thumb safety lever (top), trigger (top left), and grips (inside).

INTERESTING VARIATIONS

There are rare naval and artillery length barrel variations of this model. Perhaps most rare are Imperial naval models which are either rebarreled or have been cut down to 4-inch barrels.

MARKINGS

MARK	LOCATION/DESCRIPTION
	Toggle Manufacturer's Logo

The pistols of this model usually retain most of their original military proof marks (see the Imperial Naval and 1908 and 1914 military models for details). In addition, these will have some combination of the following marks added.

	Receiver This mark's meaning is unknown
--	--

N. Number or O. Number	Grip Strap Nordsee Fleet Property Number Ostsee Fleet Property Number
------------------------------	---

	Grip Strap Navy Acceptance Mark
---	------------------------------------

Weimar era reworks will also occasionally be found with an ordnance depot rework stamp. Examples of common types are shown below.

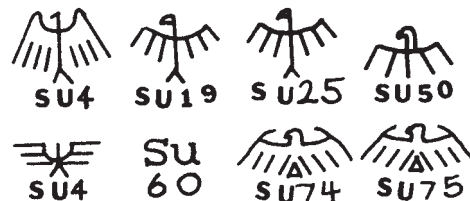

Other eagle/su number combinations possible.

VALUES

POOR	FAIR	GOOD	VG	EXC
\$500	\$1,000	\$1,500	\$2,500	\$3,000

Look-Up Index # 74

ERFURT DATED, ARMY REWORK

BACKGROUND

The Erfurt Dated, Army Rework model was made specifically for post-WW I German Army and Police units. Sometimes this model (along with the Dated, Navy Rework and the Dated, Police Rework collectively) is referred to as the 1920 Military and Police Rework model.

The theory is that while Erfurt reworks for the Weimar Reichswehr were the double date rework models, the removal of the original date with a 1920 date added tells of a DWM rework.

The P.08s of this model joined the DWM and Erfurt marked double dates, to satisfy part of the allowed Reichswehr inventory.

HOW TO TELL AN ERFURT DATED, ARMY REWORK

The Erfurt Dated, Army Rework can be distinguished from other Lugers by four features in combination.

1. The toggle is marked with the Crown Erfurt logo.
2. A single four-digit year date (either 1920 or 1921) inscription above the chamber.
3. Imperial military proof marks (see the 1908 and 1914 military models for details), or signs of having had proof marks or a chamber date removed.
4. Weimar Reichswehr type rework marks.

QUANTITY MADE

Several thousand (including the Dated, Navy and Police Rework models).

RARITY RATING

2, Common.

FEATURES IN DEPTH

MANUFACTURER: The pistols of this model were originally manufactured by the Royal Arsenal at Erfurt.

TOGGLE: This model should have the new type toggle, with the flat, checkered toggle knobs.

TOGGLE MARK: 
ERFURT

BARREL: This model should have a 4-inch (100mm) barrel. It should be chambered for 9mm Parabellum.

FRAME: The frame on this model should be the late, short type with a stock lug, wide trigger and narrow trigger guard.

RECEIVER: The receiver on this model should be the late, short type. The chamber should be dated from 1920 or 1921.

THUMB SAFETY: The thumb safety on this model should have a serrated safety lever. The upper position is marked "GESICHERT." Safe is in the lower position.

SIGHTS: The front sight on this model should be a dorsal fin shaped blade, dovetail fit on the barrel. The rear sight should be a fixed V notch in the rear toggle link.

EXTRACTOR: The extractor on this model should be the late type. It should be marked "GELADEN" on the left side.

GRIPS: The grips on this model should be checkered walnut or beech.

MAGAZINE: The magazines original to this model should have a tin-plated, wrap-around body with a wood base. They should be proof marked and serial numbered to the pistol.

FINISH: The main finish on this model should be a high-quality rust blue. The ejector, magazine catch/release, takedown lever, thumb safety lever and trigger should all be straw colored.

SERIAL NUMBER RANGE: The pistols of this model should retain the original serial number of the model being reworked.

SERIAL NUMBER LOCATION: The full serial number is found on the bottom of the barrel, the front of the frame, and the left side of the receiver. The last two digits of the serial number are on the breechblock (lower left side), extractor, front toggle link (bottom), rear toggle link (back), sear (left side), sear bar safety lever, side plate, takedown lever (bottom), thumb safety lever (top), trigger (top left), and grips (inside).

INTERESTING VARIATIONS

There is a rare artillery length barrel variations of this model.

MARKINGS

<u>MARK</u>	<u>LOCATION/DESCRIPTION</u>
-------------	-----------------------------



Toggle
Manufacturer's Logo

The pistols of this model usually retain most of their original military proof marks (see the 1908 and

1914 military models for details). In addition, these will occasionally have some combination of the following marks added.



Receiver
This mark's meaning is unknown

Weimar era reworks will also occasionally be found with an ordnance depot rework stamp. Examples of common types are shown below.



Other eagle/su number combinations possible.

VALUES

POOR	FAIR	GOOD	VG	EXC
\$375	\$500	\$750	\$1,000	\$1,250

Look-Up Index # 75

ERFURT DATED, POLICE REWORK

BACKGROUND

The Erfurt Dated, Police Rework model has the same origin as the Dated, Army Rework model (see the preceding model), but with different proofing for Weimar Police use.

HOW TO TELL A ERFURT DATED, POLICE REWORK

The Erfurt Dated, Police Rework can be distinguished from other Lugers by four features in combination.

1. The toggle is marked with the Crown Erfurt logo.
2. A single four-digit year date (either 1920 or 1921) inscription above the chamber.
3. Imperial military proof marks (see the 1908 and 1914 military models for details), or signs of having had proof marks or a chamber date removed.
4. Weimar Police type rework marks.

QUANTITY MADE

Several thousand (including the Dated, Army and Navy Rework models).

RARITY RATING

2, Common.

FEATURES IN DEPTH

MANUFACTURER: The pistols of this model were originally manufactured by the Royal Arsenal at Erfurt.

TOGGLE: This model should have the new type toggle, with the flat, checkered toggle knobs.

TOGGLE MARK:



BARREL: This model should have a 4-inch (100mm) barrel. It should be chambered for 9mm Parabellum.

FRAME: The frame on this model should be the late, short type with a stock lug, wide trigger and narrow trigger guard.

RECEIVER: The receiver on this model should be the late, short type. The chamber should be dated from 1920 or 1921.

THUMB SAFETY: The thumb safety on this model should have a serrated safety lever. The upper position is marked "GESICHERT." Safe is in the lower position.

SIGHTS: The front sight on this model should be a dorsal fin shaped blade, dovetail fit on the barrel. The rear sight should be a fixed V notch in the rear toggle link.

EXTRACTOR: The extractor on this model should be the late type. It should be marked "GELADEN" on the left side.

GRIPS: The grips on this model should be checkered walnut or beech.

MAGAZINE: The magazines original to this model should have a tin-plated, wrap-around body with a wood base. They should be proof marked and serial numbered to the pistol.

FINISH: The main finish on this model should be a high-quality rust blue. The ejector, magazine catch/release, takedown lever, thumb safety lever and trigger should all be straw colored.

SERIAL NUMBER RANGE: The pistols of this model should retain the original serial number of the model being reworked.

SERIAL NUMBER LOCATION: The full serial number is found on the bottom of the barrel, the front of the frame, and the left side of the receiver. The last two digits of the serial number are on the breechblock (lower left side), extractor, front toggle link (bottom), rear toggle link (back), sear (left side), sear bar safety lever, side plate, takedown lever (bottom), thumb safety lever (top), trigger (top left), and grips (inside).

INTERESTING VARIATIONS

There are no notable variations of this model.

MARKINGS

MARK **LOCATION/DESCRIPTION**



Toggle
Manufacturer's Logo

The pistols of this model usually retain most of their original military proof marks (see the 1908 and 1914 military models for details). In addition, these will occasionally have some combination of the following marks added.



Receiver
This mark's meaning is unknown



Barrel
Berlin Police Armory
Acceptance Stamp

Following are some variations of this mark.



Weimar era reworks will also occasionally be found with an ordnance depot rework stamp. Examples of common types are shown below.

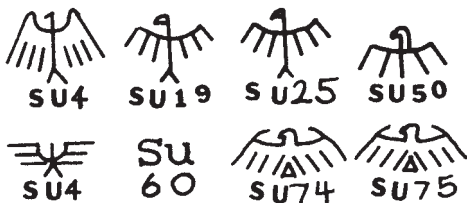

Other eagle/su number combinations possible.

VALUES

POOR	FAIR	GOOD	VG	EXC
\$375	\$500	\$750	\$1,000	\$1,250

Look-Up Index # 76

ERFURT DATED, NAVY REWORK

BACKGROUND

The Erfurt Dated, Navy Rework model has the same origin as the Dated, Army Rework model (see the preceding model), but with different proofing for Weimar Navy use.

HOW TO TELL AN ERFURT DATED, NAVY REWORK

The Erfurt Dated, Navy Rework can be distinguished from other Lugers by four features in combination.

1. The toggle is marked with the Crown Erfurt logo.
2. A single four-digit year date (either 1920 or 1921) inscription above the chamber.
3. Imperial military proof marks (see the 1908 and 1914 military models for details), or signs of having had proof marks or a chamber date removed.
4. Weimar Navy type rework marks.

QUANTITY MADE

Several thousand (including the Dated, Army and Police Rework models).

RARITY RATING

- 2, Common.

FEATURES IN DEPTH

MANUFACTURER: The pistols of this model were originally manufactured by the Royal Arsenal at Erfurt.

TOGGLE: This model should have the new type toggle, with the flat, checkered toggle knobs.

TOGGLE MARK: 
ERFURT

BARREL: This model should have a 4-inch (100mm) barrel. It should be chambered for 9mm Parabellum.

FRAME: The frame on this model should be the late, short type with a stock lug, wide trigger and narrow trigger guard.

RECEIVER: The receiver on this model should be the late, short type. The chamber should be dated from 1920 or 1921.

THUMB SAFETY: The thumb safety on this model should have a serrated safety lever. The upper position is marked "GESICHERT." Safe is in the lower position.

SIGHTS: The front sight on this model should be a dorsal fin shaped blade, dovetail fit on the barrel. The rear sight should be a fixed V notch in the rear toggle link.

HOW TO TELL A DWM NO DATE, POLICE REWORK

The DWM No Date, Police Rework can be distinguished from other Lugers by four features in combination.

1. The toggle is marked with the Scroll DWM logo.
2. The chamber should be blank.
3. Imperial military proof marks (see the 1908 and 1914 military models for details), or signs of having had proof marks or a chamber date removed.
4. Weimar Police type rework marks.

QUANTITY MADE

Several thousand (including the No Date, Army and Navy Rework models).

RARITY RATING

2, Common.

FEATURES IN DEPTH

MANUFACTURER: This model was manufactured by DWM (Deutsche Waffen and Munitionsfabriken) of Berlin.

TOGGLE: This model should have the new type toggle, with the flat, checkered toggle knobs.

TOGGLE MARK: 

BARREL: This model should have a 4-inch (100mm) barrel. It should be chambered for 9mm Parabellum.

FRAME: The frame on this model should be the late, short type with a stock lug, wide trigger and narrow trigger guard.

RECEIVER: The receiver on this model should be the late, short type. The chamber should be blank.

THUMB SAFETY: The thumb safety on this model should have a serrated safety lever. The upper position is marked "GESICHERT." Safe is in the lower position.

SIGHTS: The front sight on this model should be a dorsal fin shaped blade, dovetail fit on the barrel. The rear sight should be a fixed V notch in the rear toggle link.

EXTRACTOR: The extractor on this model should be the late type. It should be marked "GELADEN" on the left side.

GRIPS: The grips on this model should be checkered walnut or beech.

MAGAZINE: The magazines original to this model should have a tin-plated, wrap-around body with a wood base. They should be proof marked and serial numbered to the pistol.

FINISH: The main finish on this model should be a high-quality rust blue. The ejector, magazine catch/release, takedown lever, thumb safety lever and trigger should all be straw colored.

SERIAL NUMBER RANGE: The pistols of this model should retain the original serial number of the model being reworked.

SERIAL NUMBER LOCATION: The full serial number is found on the bottom of the barrel, the front of the frame, and the left side of the receiver. The last two digits of the serial number are on the breechblock (lower left side), extractor, front toggle link (bottom), rear toggle link (back), sear (left side), sear bar safety lever, side plate, takedown lever (bottom), thumb safety lever (top), trigger (top left), and grips (inside).

INTERESTING VARIATIONS

There are no notable variations of this model.

MARKINGS

MARK	LOCATION/DESCRIPTION
------	----------------------



	Toggle Manufacturer's Logo
--	-------------------------------

The pistols of this model usually retain most of their original military proof marks (see the Imperial Naval and 1908 and 1914 military models for details). In addition, these will occasionally have some combination of the following marks added.



	Receiver This mark's meaning is unknown
--	--



	Barrel Berlin Police Army Acceptance Stamp
--	--

Following are some variations of this mark.



Weimar era reworks will also occasionally be found with an ordnance depot rework stamp. Examples of common types are shown below.



Other eagle/su number combinations possible.

VALUES

POOR	FAIR	GOOD	VG	EXC
\$375	\$500	\$750	\$1,000	\$1,250

Look-Up Index # 79

DWM NO DATE, NAVY REWORK

BACKGROUND

The DWM No Date, Navy Rework model has the same origin as the No Date, Army Rework model (see the preceding model), but with different proofing for Weimar Navy use.

HOW TO TELL A DWM NO DATE, NAVY REWORK

The DWM No Date, Navy Rework can be distinguished from other Lugers by four features in combination.

1. The toggle is marked with the Scroll DWM logo.
2. The chamber should be blank.
3. Imperial military proof marks (see the 1908 and 1914 military models for details), or signs of having had proof marks or a chamber date removed.
4. Weimar Navy type rework marks.

QUANTITY MADE

Several thousand (including the No Date, Army and Police Rework models).

RARITY RATING

- 2, Common.

FEATURES IN DEPTH

MANUFACTURER: This model was manufactured by DWM (Deutsche Waffen and Munitionsfabriken) of Berlin.

TOGGLE: This model should have the new type toggle, with the flat, checkered toggle knobs.

TOGGLE MARK: 

BARREL: This model should have a 4-inch (100mm) barrel. It should be chambered for 9mm Parabellum.

FRAME: The frame on this model should be the late, short type with a stock lug, wide trigger and narrow trigger guard.

RECEIVER: The receiver on this model should be the late, short type. The chamber should be blank.

THUMB SAFETY: The thumb safety on this model should have a serrated safety lever. The upper position is marked "GESICHERT." Safe is in the lower position.

SIGHTS: The front sight on this model should be a dorsal fin shaped blade, dovetail fit on the barrel. The rear sight should be a fixed V notch in the rear toggle link.

EXTRACTOR: The extractor on this model should be the late type. It should be marked "GELADEN" on the left side.

GRIPS: The grips on this model should be checkered walnut or beech.

MAGAZINE: The magazines original to this model should have a tin-plated, wrap-around body with a wood base. They should be proof marked and serial numbered to the pistol.

FINISH: The main finish on this model should be a high-quality rust blue. The ejector, magazine catch/release, takedown lever, thumb safety lever and trigger should all be straw colored.

SERIAL NUMBER RANGE: The pistols of this model should retain the original serial number of the model being reworked.

SERIAL NUMBER LOCATION: The full serial number is found on the bottom of the barrel, the front of the frame, and the left side of the receiver. The last two digits of the serial number are on the breechblock (lower left side), extractor, front toggle link (bottom), rear toggle link (back), sear (left side), sear bar safety lever, side plate, takedown lever (bottom), thumb safety lever (top), trigger (top left), and grips (inside).

INTERESTING VARIATIONS

There are rare naval and artillery length barrel variations of this model. Perhaps most rare are Imperial naval models which are either rebarreled or have been cut down to 4-inch barrels.

MARKINGS

<u>MARK</u>	<u>LOCATION/DESCRIPTION</u>
-------------	-----------------------------



Toggle
Manufacturer's Logo

The pistols of this model usually retain most of their original military proof marks (see the Imperial Naval and 1908 and 1914 military models for details). In addition, these will have some combination of the following marks added.



Receiver
This mark's meaning is unknown

N. Number or O. Number Grip Strap Nordsee Fleet Property Number Ostsee Fleet Property Number



Grip Strap
Navy Acceptance Mark

Weimar era reworks will also occasionally be found with an ordnance depot rework stamp. Examples of common types are shown below.

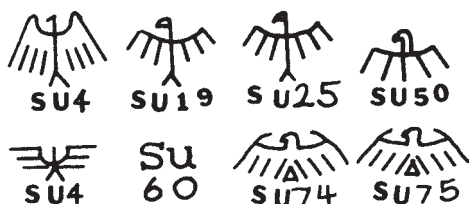

Other eagle/su number combinations possible.

VALUES

POOR	FAIR	GOOD	VG	EXC
\$500	\$1,000	\$1,500	\$2,500	\$3,000

Look-Up Index # 80

ERFURT NO DATE, ARMY REWORK

BACKGROUND

The Erfurt No Date, Army Rework model was made specifically for post-WW I German Army units. Unlike the Double Date reworks and the Dated reworks, these reworked military models had the original dates removed from the chamber, and did not receive a Weimar property date stamp on the chamber.

The theory is that along with the Dated rework models, these were reworked at DWM. Technically they could be considered Sneak Reworks, since they violated the rules of the IMKK.

HOW TO TELL A ERFURT NO DATE, ARMY REWORK

The Erfurt No Date, Army Rework can be distinguished from other Lugers by four features in combination.

1. The toggle is marked with the Crown Erfurt logo.

2. The chamber is blank.
3. Imperial military proof marks (see the 1908 and 1914 military models for details), or signs of having had proof marks or a chamber date removed.
4. Weimar Reichswehr type rework marks.

QUANTITY MADE

Several thousand (including the No Date, Navy and Police Rework models).

RARITY RATING

- 2, Common.

FEATURES IN DEPTH

MANUFACTURER: The pistols of this model were originally manufactured by the Royal Arsenal at Erfurt.

TOGGLE: This model should have the new type toggle, with the flat, checkered toggle knobs.

TOGGLE MARK: 
ERFURT

BARREL: This model should have a 4-inch (100mm) barrel. It should be chambered for 9mm Parabellum.

FRAME: The frame on this model should be the late, short type with a stock lug, wide trigger and narrow trigger guard.

RECEIVER: The receiver on this model should be the late, short type. The chamber should be blank.

THUMB SAFETY: The thumb safety on this model should have a serrated safety lever. The upper position is marked "GESICHERT." Safe is in the lower position.

SIGHTS: The front sight on this model should be a dorsal fin shaped blade, dovetail fit on the barrel. The rear sight should be a fixed V notch in the rear toggle link.

EXTRACTOR: The extractor on this model should be the late type. It should be marked "GELADEN" on the left side.

GRIPS: The grips on this model should be checkered walnut or beech.

MAGAZINE: The magazines original to this model should have a tin-plated, wrap-around body with a wood base. They should be proof marked and serial numbered to the pistol.

FINISH: The main finish on this model should be a high-quality rust blue. The ejector, magazine catch/release, takedown lever, thumb safety lever and trigger should all be straw colored.

SERIAL NUMBER RANGE: The pistols of this model should retain the original serial number of the model being reworked.

SERIAL NUMBER LOCATION: The full serial number is found on the bottom of the barrel, the front of the frame,

and the left side of the receiver. The last two digits of the serial number are on the breechblock (lower left side), extractor, front toggle link (bottom), rear toggle link (back), sear (left side), sear bar safety lever, side plate, takedown lever (bottom), thumb safety lever (top), trigger (top left), and grips (inside).

INTERESTING VARIATIONS

There is a rare artillery length barrel variation of this model.

MARKINGS

MARK **LOCATION/DESCRIPTION**



Toggle
Manufacturer's Logo

The pistols of this model usually retain most of their original military proof marks (see the 1908 and 1914 military models for details). In addition, these will occasionally have some combination of the following marks added.



Receiver
This mark's meaning is unknown

Weimar era reworks will also occasionally be found with an ordnance depot rework stamp. Examples of common types are shown below.

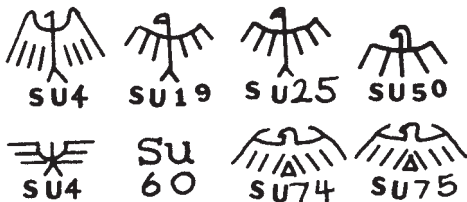

Other eagle/su number combinations possible.

VALUES

POOR	FAIR	GOOD	VG	EXC
\$375	\$500	\$750	\$1,000	\$1,250

Look-Up Index # 81

ERFURT NO DATE, POLICE REWORK

BACKGROUND

The Erfurt No Date, Police Rework model has the same origin as the No Date, Army Rework model (see the preceding model), but with different proofing for Weimar Police use.

HOW TO TELL A ERFURT NO DATE, POLICE REWORK

The Erfurt No Date, Police Rework can be distinguished from other Lugers by four features in combination.

1. The toggle is marked with the Crown Erfurt logo.
2. The chamber is blank.
3. Imperial military proof marks (see the 1908 and 1914 military models for details), or signs of having had proof marks or a chamber date removed.
4. Weimar Police type rework marks.

QUANTITY MADE

Several thousand (including the No Date, Army and Navy Rework models).

RARITY RATING

2, Common.

FEATURES IN DEPTH

MANUFACTURER: The pistols of this model were originally manufactured by the Royal Arsenal at Erfurt.

TOGGLE: This model should have the new type toggle, with the flat, checkered toggle knobs.

TOGGLE MARK: 
ERFURT

BARREL: This model should have a 4-inch (100mm) barrel. It should be chambered for 9mm Parabellum.

FRAME: The frame on this model should be the late, short type with a stock lug, wide trigger and narrow trigger guard.

RECEIVER: The receiver on this model should be the late, short type. The chamber should be blank.

THUMB SAFETY: The thumb safety on this model should have a serrated safety lever. The upper position is marked "GESICHERT." Safe is in the lower position.

SIGHTS: The front sight on this model should be a dorsal fin shaped blade, dovetail fit on the barrel. The rear sight should be a fixed V notch in the rear toggle link.

EXTRACTOR: The extractor on this model should be the late type. It should be marked "GELADEN" on the left side.

GRIPS: The grips on this model should be checkered walnut or beech.

MAGAZINE: The magazines original to this model should have a tin-plated, wrap-around body with a wood base. They should be proof marked and serial numbered to the pistol.

FINISH: The main finish on this model should be a high-quality rust blue. The ejector, magazine catch/release, takedown lever, thumb safety lever and trigger should all be straw colored.

SERIAL NUMBER RANGE: The pistols of this model should retain the original serial number of the model being reworked.

SERIAL NUMBER LOCATION: The full serial number is found on the bottom of the barrel, the front of the frame, and the left side of the receiver. The last two digits of the serial number are on the breechblock (lower left side), extractor, front toggle link (bottom), rear toggle link (back), sear (left side), sear bar safety lever, side plate, takedown lever (bottom), thumb safety lever (top), trigger (top left), and grips (inside).

INTERESTING VARIATIONS

There is a rare artillery length barrel variation of this model.

MARKINGS

MARK LOCATION/DESCRIPTION



Toggle
Manufacturer's Logo

The pistols of this model usually retain most of their original military proof marks (see the 1908 and 1914 military models for details). In addition, these will occasionally have some combination of the following marks added.



Receiver
This mark's meaning is unknown



Barrel
Berlin Police Armory
Acceptance Stamp

Following are some variations of this mark.



Weimar era reworks will also occasionally be found with an ordnance depot rework stamp. Examples of common types are shown below.



Other eagle/su number combinations possible.

VALUES

POOR	FAIR	GOOD	VG	EXC
\$375	\$500	\$750	\$1,000	\$1,250

Look-Up Index # 82

ERFURT NO DATE, NAVY REWORK

BACKGROUND

The Erfurt No Date, Navy Rework model has the same origin as the No Date, Army Rework model (see the preceding model), but with different proofing for Weimar Navy use.

HOW TO TELL AN ERFURT NO DATE, NAVY REWORK

The Erfurt No Date, Navy Rework can be distinguished from other Lugers by four features in combination.

1. The toggle is marked with the Crown Erfurt logo.
2. The chamber is blank.
3. Imperial military proof marks (see the 1908 and 1914 military models for details), or signs of having had proof marks or a chamber date removed.
4. Weimar Navy type rework marks.

QUANTITY MADE

Several thousand (including the No Date, Army and Police Rework models).

RARITY RATING

2, Common.

FEATURES IN DEPTH

MANUFACTURER: The pistols of this model were originally manufactured by the Royal Arsenal at Erfurt.

TOGGLE: This model should have the new type toggle, with the flat, checkered toggle knobs.

TOGGLE MARK: 
ERFURT

BARREL: This model should have a 4-inch (100mm) barrel. It should be chambered for 9mm Parabellum.

FRAME: The frame on this model should be the late, short type with a stock lug, wide trigger and narrow trigger guard.

RECEIVER: The receiver on this model should be the late, short type. The chamber should be blank.

THUMB SAFETY: The thumb safety on this model should have a serrated safety lever. The upper position is marked "GESICHERT." Safe is in the lower position.

SIGHTS: The front sight on this model should be a dorsal fin shaped blade, dovetail fit on the barrel. The rear sight should be a fixed V notch in the rear toggle link.

EXTRACTOR: The extractor on this model should be the late type. It should be marked "GELADEN" on the left side.

GRIPS: The grips on this model should be checkered walnut or beech.

MAGAZINE: The magazines original to this model should have a tin-plated, wrap-around body with a wood base. They should be proof marked and serial numbered to the pistol.

FINISH: The main finish on this model should be a high-quality rust blue. The ejector, magazine catch/release, takedown lever, thumb safety lever and trigger should all be straw colored.

SERIAL NUMBER RANGE: The pistols of this model should retain the original serial number of the model being reworked.

SERIAL NUMBER LOCATION: The full serial number is found on the bottom of the barrel, the front of the frame, and the left side of the receiver. The last two digits of the serial number are on the breechblock (lower left side), extractor, front toggle link (bottom), rear toggle link (back), sear (left side), sear bar safety lever, side plate, takedown lever (bottom), thumb safety lever (top), trigger (top left), and grips (inside).

INTERESTING VARIATIONS

There is a rare artillery length barrel variation of this model.

MARKINGS

MARK **LOCATION/DESCRIPTION**



Toggle
Manufacturer's Logo

The pistols of this model usually retain most of their original military proof marks (see the 1908 and 1914 military models for details). In addition, these will occasionally have some combination of the following marks added.



Receiver
This mark's meaning is unknown

N. Number
or
O. Number

Grip Strap
Nordsee Fleet Property Number
Ostsee Fleet Property Number



Grip Strap
Navy Acceptance Mark

Weimar era reworks will also occasionally be found with an ordnance depot rework stamp. Examples of common types are shown below.

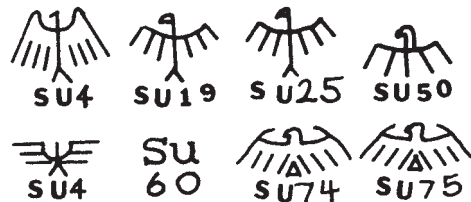

Other eagle/su number combinations possible.

VALUES

POOR	FAIR	GOOD	VG	EXC
\$500	\$1,000	\$1,500	\$2,500	\$3,000

Look-Up Index # 83

DOUBLE DATE, ARMY

BACKGROUND

The Double Date, Army model was made specifically for Army consumption within the Weimar military (known as the Reichswehr).

Unlike any of the double date rework models, this model was newly manufactured sometime from 1920

on. They then had the 1920 Reichswehr property mark added to the chamber above the date of manufacture.

After the rework candidates were exhausted, this model also filled some of the Versailles constrained inventory for military and police use. Dates of manufacture up through April of 1924 fall into this category.

This is where it gets weird. Some of these pistols will have a manufacture date AFTER 1924 (when Simson took over official production and DWM was forbidden from making a military configuration/caliber pistol), but with the Reichswehr property mark of a 1920 date added.

Apparently the German penchant for following rules for marking things uniformly sometimes overruled the logic of keeping things secret. As evidence is a K Date (1934) example with the 1920 property mark added. Conceivably any date in from 1924 to 1936 could exist.

HOW TO TELL A DOUBLE DATE, ARMY

The Double Date, Army can be distinguished from other Lugers by four features in combination.

1. The chamber inscription consists of two four-digit year dates.
2. The lower date should be 1920 or later.
3. No Imperial era type marks.
4. Weimar Reichswehr type marks.

QUANTITY MADE

5,000 (including the Double Date Police model).

RARITY RATING

5, Somewhat rare.

FEATURES IN DEPTH

MANUFACTURER: This model was manufactured by DWM (Deutsche Waffen and Munitionsfabriken). A few late ones were manufactured by Mauser Werke.

TOGGLE: This model should have the new type toggle, with the flat, checkered toggle knobs.

TOGGLE MARK: 

BARREL: This model should have a 4-inch (100mm) barrel. It should be chambered for 9mm Parabellum.

FRAME: The frame on this model should be the late, short type with a stock lug, wide trigger and narrow trigger guard.

RECEIVER: The receiver on this model should be the late, short type. The chamber should have two different four-digit year date inscriptions. The lower date should be 1920 or later. The upper (added) date should be 1920.

THUMB SAFETY: The thumb safety on this model should have a serrated safety lever. The upper position is marked "GESICHERT." Safe is in the lower position.

SIGHTS: The front sight on this model should be a dorsal fin shaped blade, dovetail fit on the barrel. The rear sight should be a fixed V notch in the rear toggle link.

EXTRACTOR: The extractor on this model should be the late type. It should be marked "GELADEN" on the left side.

GRIPS: The grips on this model should be checkered walnut.

MAGAZINE: The magazines original to this model should have a tin-plated, wrap-around body with a wood base (some with aluminum). They should be proof marked and serial numbered to the pistol.

FINISH: The main finish on this model should be a high-quality rust blue. The ejector, magazine catch/release, takedown lever, thumb safety lever and trigger should all be straw colored.

SERIAL NUMBER RANGE: In the no suffix, a, and b serial number suffix blocks.

SERIAL NUMBER LOCATION: The full serial number is found on the bottom of the barrel, the front of the frame, and the left side of the receiver. The last two digits of the serial number are on the breechblock (lower left side), extractor, front toggle link (bottom), rear toggle link (back), sear (left side), sear bar safety lever, side plate, takedown lever (bottom), thumb safety lever (top), trigger (top left), and grips (inside).

INTERESTING VARIATIONS

There are variations of the 1920 Reichswehr property stamp being applied as late as K Date (1934) Mauser Lugers.

MARKINGS

MARK

LOCATION/DESCRIPTION



Toggle
Manufacturer's Logo



Receiver
Weimar Acceptance Mark
Sometimes over ArA4 or WaA4



Receiver
Test Fire Proof Mark
Sometimes over WaA4 instead

VALUES

POOR	FAIR	GOOD	VG	EXC
\$400	\$850	\$1,250	\$1,500	\$2,000

Look-Up Index # 84

DOUBLE DATE, POLICE

BACKGROUND

The Double Date, Police model was made has the same origin as the Double Date Army model (see the preceding model), but with different proofing for Weimar Police use.

HOW TO TELL A DOUBLE DATE, POLICE

The Double Date, Police can be distinguished from other Lugers by three features in combination.

1. The chamber inscription consists of two four-digit year dates.
2. The lower date should be 1920 or later.
3. No Imperial era type marks.
4. Weimar Police type marks.

QUANTITY MADE

5,000 (including the Double Date, Army model).

RARITY RATING

5, Somewhat rare.

FEATURES IN DEPTH

MANUFACTURER: This model was manufactured by DWM (Deutsche Waffen and Munitionsfabriken). A few late ones were manufactured by Mauser Werke.

TOGGLE: This model should have the new type toggle, with the flat, checkered toggle knobs.

TOGGLE MARK: 

BARREL: This model should have a 4-inch (100mm) barrel. It should be chambered for 9mm Parabellum.

FRAME: The frame on this model should be the late, short type with a stock lug, wide trigger and narrow trigger guard.

RECEIVER: The receiver on this model should be the late, short type. The chamber should have two different four-digit year date inscriptions. The lower date should be 1920 or later. The upper (added) date should be 1920.

THUMB SAFETY: The thumb safety on this model should have a serrated safety lever. The upper position is marked "GESICHERT." Safe is in the lower position.

SIGHTS: The front sight on this model should be a dorsal fin shaped blade, dovetail fit on the barrel. The rear sight should be a fixed V notch in the rear toggle link.

EXTRACTOR: The extractor on this model should be the late type. It should be marked "GELADEN" on the left side.

GRIPS: The grips on this model should be checkered walnut.

MAGAZINE: The magazines original to this model should have a tin-plated, wrap-around body with a wood base (some with aluminum). They should be proof marked and serial numbered to the pistol.

FINISH: The main finish on this model should be a high-quality rust blue. The ejector, magazine catch/release, takedown lever, thumb safety lever and trigger should all be straw colored.

SERIAL NUMBER RANGE: In the no suffix, a, and b serial number suffix blocks.

SERIAL NUMBER LOCATION: The full serial number is found on the bottom of the barrel, the front of the frame, and the left side of the receiver. The last two digits of the serial number are on the breechblock (lower left side), extractor, front toggle link (bottom), rear toggle link (back), sear (left side), sear bar safety lever, side plate, takedown lever (bottom), thumb safety lever (top), trigger (top left), and grips (inside).

INTERESTING VARIATIONS

There are no notable variations of this model.

MARKINGS

MARK	LOCATION/DESCRIPTION
------	----------------------

The pistols of this model could retain any, all or none of their original military proof marks (see the 1908 and 1914 military models for details). In addition, these will usually have some combination of the following marks added.



Toggle
Manufacturer's Logo



Receiver
Weimar Acceptance Mark
Sometimes over ArA4 or WaA4



Receiver
Test Fire Proof Mark
Sometimes over WaA4 instead

VALUES

POOR	FAIR	GOOD	VG	EXC
\$400	\$650	\$800	\$1,250	\$1,500

Look-Up Index # 85

MILITARY & POLICE DATED, ARMY

BACKGROUND

The Military & Police Dated, Army model was made specifically for post-WW I German Army and Police units. Unlike the DWM and Erfurt 1920 Military & Police rework models, this model was newly manufactured in 1920 and 1921. They then had the 1920 Reichswehr property mark on the chamber.

HOW TO TELL A MILITARY & POLICE DATED, ARMY

The Military & Police Dated, Army can be distinguished from other Lugers by four features in combination.

1. The toggle is marked with the Scroll DWM logo.
2. A single four-digit year date (either 1920 or 1921) inscription above the chamber.
3. No Imperial military proofs, nor signs of having had proof marks or a chamber date removed.
4. Weimar Reichswehr type marks.

QUANTITY MADE

A few thousand (including the Military & Police Dated, Police model).

RARITY RATING

3, Uncommon.

FEATURES IN DEPTH

MANUFACTURER: This model was manufactured by DWM (Deutsche Waffen and Munitionsfabriken) of Berlin.

TOGGLE: This model should have the new type toggle, with the flat, checkered toggle knobs.

TOGGLE MARK: 

BARREL: This model should have a 4-inch (100mm) barrel. It should be chambered for 9mm Parabellum.

FRAME: The frame on this model should be the late, short type with a stock lug, wide trigger and narrow trigger guard.

RECEIVER: The receiver on this model should be the late, short type. The chamber should be dated from 1920 or 1921.

THUMB SAFETY: The thumb safety on this model should have a serrated safety lever. The upper position is marked "GESICHERT." Safe is in the lower position.

SIGHTS: The front sight on this model should be a dorsal fin shaped blade, dovetail fit on the barrel. The rear sight should be a fixed V notch in the rear toggle link.

EXTRACTOR: The extractor on this model should be the late type. It should be marked "GELADEN" on the left side.

GRIPS: The grips on this model should be checkered walnut or beech.

MAGAZINE: The magazines original to this model should have a tin-plated, wrap-around body with a wood base. They should be proof marked and serial numbered to the pistol.

FINISH: The main finish on this model should be a high-quality rust blue. The ejector, magazine catch/release, takedown lever, thumb safety lever and trigger should all be straw colored.

SERIAL NUMBER RANGE: In the no suffix, a, and b serial number suffix blocks.

SERIAL NUMBER LOCATION: The full serial number is found on the bottom of the barrel, the front of the frame, and the left side of the receiver. The last two digits of the serial number are on the breechblock (lower left side), extractor, front toggle link (bottom), rear toggle link (back), sear (left side), sear bar safety lever, side plate, takedown lever (bottom), thumb safety lever (top), trigger (top left), and grips (inside).

INTERESTING VARIATIONS

There are no notable variations of this model.

MARKINGS

MARK	LOCATION/DESCRIPTION
-------------	-----------------------------



Toggle
Manufacturer's Logo



Receiver
Weimar Acceptance Mark
Sometimes over ArA4 or WaA4



Receiver
Test Fire Proof Mark
Sometimes over WaA4 instead

VALUES

POOR	FAIR	GOOD	VG	EXC
\$400	\$850	\$1,250	\$1,500	\$2,000

Look-Up Index # 87

MILITARY & POLICE DATED, NAVY

BACKGROUND

The Military & Police Dated, Navy model has the same origin as the 1920 Military & Police, Army model (see the preceding model), but with different proofing for Weimar Navy use.

HOW TO TELL A MILITARY & POLICE DATED, NAVY

The Military & Police Dated, Navy can be distinguished from other Lugers by four features in combination.

1. The toggle is marked with the Scroll DWM logo.
2. A single four-digit year date (either 1920 or 1921) inscription above the chamber.
3. No Imperial military proofs, nor signs of having had proof marks or a chamber date removed.
4. Weimar Navy type marks.

QUANTITY MADE

A few thousand (including the Military & Police Dated Army and Police models).

RARITY RATING

3, Uncommon.

FEATURES IN DEPTH

MANUFACTURER: This model was manufactured by DWM (Deutsche Waffen and Munitionsfabriken) of Berlin.

TOGGLE: This model should have the new type toggle, with the flat, checkered toggle knobs.

TOGGLE MARK: 

BARREL: This model should have a 4-inch (100mm) barrel. It should be chambered for 9mm Parabellum.

FRAME: The frame on this model should be the late, short type with a stock lug, wide trigger and narrow trigger guard.

RECEIVER: The receiver on this model should be the late, short type. The chamber should be dated from 1920 or 1921.

THUMB SAFETY: The thumb safety on this model should have a serrated safety lever. The upper position is marked "GESICHERT." Safe is in the lower position.

SIGHTS: The front sight on this model should be a dorsal fin shaped blade, dovetail fit on the barrel. The rear sight should be a fixed V notch in the rear toggle link.

EXTRACTOR: The extractor on this model should be the late type. It should be marked "GELADEN" on the left side.

GRIPS: The grips on this model should be checkered walnut or beech.

MAGAZINE: The magazines original to this model should have a tin-plated, wrap-around body with a wood base. They should be proof marked and serial numbered to the pistol.

FINISH: The main finish on this model should be a high-quality rust blue. The ejector, magazine catch/release, takedown lever, thumb safety lever and trigger should all be straw colored.

SERIAL NUMBER RANGE: In the no suffix, a, and b serial number suffix blocks.

SERIAL NUMBER LOCATION: The full serial number is found on the bottom of the barrel, the front of the frame, and the left side of the receiver. The last two digits of the serial number are on the breechblock (lower left side), extractor, front toggle link (bottom), rear toggle link (back), sear (left side), sear bar safety lever, side plate, takedown lever (bottom), thumb safety lever (top), trigger (top left), and grips (inside).

INTERESTING VARIATIONS

There are no notable variations of this model.

MARKINGS

MARK	LOCATION/DESCRIPTION
------	----------------------



Toggle
Manufacturer's Logo



Receiver
Nitro Commercial Proof



Front Strap
Reichsmarine Property Mark

N. Number

Front Strap
Nordsee Fleet Inventory
Number

VALUES

POOR	FAIR	GOOD	VG	EXC
\$400	\$650	\$800	\$1,250	\$1,500

Look-Up Index # 88

**MILITARY & POLICE DATED,
NAVY MA**

BACKGROUND

The Military & Police Dated, Navy MA model was proofed and accepted at the Marine Arsenal (thus the M/A stamp) at Kiel.

Previously the M/A mark on this model was thought to stand for Mauser Arbeiten, or Mauser Rework. More recent research and correlation with the presence of N. or O. fleet property numbers has shown the real story.

HOW TO TELL A MILITARY & POLICE DATED, NAVY MA

The Military & Police Dated, Navy MA is easily distinguished from other Lugers by two features in combination.

1. The chamber is marked with single four-digit year date (either 1920 or 1921).
2. The Marine Arsenal (M/A) inscription on the left side of the receiver.

QUANTITY MADE

Unknown.

RARITY RATING

7, Very rare.

FEATURES IN DEPTH

MANUFACTURER: This model was manufactured by DWM (Deutsche Waffen and Munitionsfabriken) of Berlin.

TOGGLE: This model should have the new type toggle, with the flat, checkered toggle knobs.

TOGGLE MARK: 

BARREL: This model should have a 4-inch (100mm) barrel. It should be chambered for 9mm Parabellum.

FRAME: The frame on this model should be the late, short type with a stock lug, wide trigger and narrow trigger guard.

RECEIVER: The receiver on this model should be the late, short type. The chamber should be marked with a four-digit year date, most likely 1920.

THUMB SAFETY: The thumb safety on this model should have a serrated safety lever. The upper position is marked "GESICHERT." Safe is in the lower position.

SIGHTS: The front sight on this model should be a dorsal fin shaped blade, dovetail fit on the barrel. The

rear sight should be a fixed V notch in the rear toggle link.

EXTRACTOR: The extractor on this model should be the late type. It should be marked "GELADEN" on the left side.

GRIPS: The grips on this model should be checkered walnut.

MAGAZINE: The magazines original to this model should have a tin-plated, wrap-around body with a wood base. They should be proof marked and serial numbered to the pistol.

FINISH: The main finish on this model should be a high-quality rust blue. The ejector, magazine catch/release, takedown lever, thumb safety lever and trigger should all be straw colored.

SERIAL NUMBER RANGE: In the m, n and o serial number suffix blocks.

SERIAL NUMBER LOCATION: The full serial number is found on the bottom of the barrel, the front of the frame, and the left side of the receiver. The last two digits of the serial number are on the breechblock (lower left side), extractor, front toggle link (bottom), rear toggle link (back), sear (left side), sear bar safety lever, side plate, takedown lever (bottom), thumb safety lever (top), trigger (top left), and grips (inside).

INTERESTING VARIATIONS

There are no notable variations of this model.

MARKINGS

MARK	LOCATION/DESCRIPTION
------	----------------------



Toggle
Manufacturer's Logo



Receiver
Marine Arsenal Acceptance
Mark

O. Number

Front Strap
Ostsee Fleet Inventory
Number

VALUES

POOR	FAIR	GOOD	VG	EXC
\$750	\$1,000	\$1,500	\$2,500	\$4,000

Look-Up Index # 89

MILITARY & POLICE NO DATE, ARMY

BACKGROUND

The Military & Police No Date, Army model was made specifically for post-WW I German Army units. Unlike the DWM and Erfurt 1920 Military & Police rework models, this model was newly manufactured in 1920 and 1921. They then had the 1920 Reichswehr property mark on the chamber.

HOW TO TELL A MILITARY & POLICE NO DATE, ARMY

The Military & Police No Date, Army can be distinguished from other Lugers by four features in combination.

1. The toggle is marked with the Scroll DWM logo.
2. The chamber is blank.
3. No Imperial military proofs, nor signs of having had proof marks or a chamber date removed.
4. Weimar Reichswehr type marks.

QUANTITY MADE

A few thousand (including the Military & Police No Date, Police model).

RARITY RATING

- 3, Uncommon.

FEATURES IN DEPTH

MANUFACTURER: This model was manufactured by DWM (Deutsche Waffen and Munitionsfabriken) of Berlin.

TOGGLE: This model should have the new type toggle, with the flat, checkered toggle knobs.

TOGGLE MARK: 

BARREL: This model should have a 4-inch (100mm) barrel. It should be chambered for 9mm Parabellum.

FRAME: The frame on this model should be the late, short type with a stock lug, wide trigger and narrow trigger guard.

RECEIVER: The receiver on this model should be the late, short type. The chamber should be blank.

THUMB SAFETY: The thumb safety on this model should have a serrated safety lever. The upper position is marked "GESICHERT." Safe is in the lower position.

SIGHTS: The front sight on this model should be a dorsal fin shaped blade, dovetail fit on the barrel. The rear sight should be a fixed V notch in the rear toggle link.

EXTRACTOR: The extractor on this model should be the late type. It should be marked "GELADEN" on the left side.

GRIPS: The grips on this model should be checkered walnut or beech.

MAGAZINE: The magazines original to this model should have a tin-plated, wrap-around body with a wood base. They should be proof marked and serial numbered to the pistol.

FINISH: The main finish on this model should be a high-quality rust blue. The ejector, magazine catch/release, takedown lever, thumb safety lever and trigger should all be straw colored.

SERIAL NUMBER RANGE: In the s, t and u serial number suffix blocks.

SERIAL NUMBER LOCATION: The full serial number is found on the bottom of the barrel, the front of the frame, and the left side of the receiver. The last two digits of the serial number are on the breechblock (lower left side), extractor, front toggle link (bottom), rear toggle link (back), sear (left side), sear bar safety lever, side plate, takedown lever (bottom), thumb safety lever (top), trigger (top left), and grips (inside).

INTERESTING VARIATIONS

There are no notable variations of this model.

MARKINGS

MARK	LOCATION/DESCRIPTION
------	----------------------



Toggle
Manufacturer's Logo



Receiver
Nitro Commercial Proof
Indicative of commercial purchase

VALUES

POOR	FAIR	GOOD	VG	EXC
\$400	\$850	\$1,250	\$1,500	\$2,000

Look-Up Index # 90

MILITARY & POLICE NO DATE, POLICE

BACKGROUND

The Military & Police No Date, Police model has the same origin as the Military & Police, Army model (see the

preceding model), but with different proofing for Weimar Police use.

HOW TO TELL A MILITARY & POLICE NO DATE, POLICE

The Military & Police No Date, Police can be distinguished from other Lugers by four features in combination.

1. The toggle is marked with the Scroll DWM logo.
2. The chamber is blank.
3. No Imperial military proofs, nor signs of having had proof marks or a chamber date removed.
4. Weimar Police type marks.

QUANTITY MADE

A few thousand (including the Military & Police No Date, Army model).

RARITY RATING

- 3, Uncommon.

FEATURES IN DEPTH

MANUFACTURER: This model was manufactured by DWM (Deutsche Waffen and Munitionsfabriken) of Berlin.

TOGGLE: This model should have the new type toggle, with the flat, checkered toggle knobs.

TOGGLE MARK: 

BARREL: This model should have a 4-inch (100mm) barrel. It should be chambered for 9mm Parabellum.

FRAME: The frame on this model should be the late, short type with a stock lug, wide trigger and narrow trigger guard.

RECEIVER: The receiver on this model should be the late, short type. The chamber should be blank.

THUMB SAFETY: The thumb safety on this model should have a serrated safety lever. The upper position is marked "GESICHERT." Safe is in the lower position.

SIGHTS: The front sight on this model should be a dorsal fin shaped blade, dovetail fit on the barrel. The rear sight should be a fixed V notch in the rear toggle link.

EXTRACTOR: The extractor on this model should be the late type. It should be marked "GELADEN" on the left side.

GRIPS: The grips on this model should be checkered walnut or beech.

MAGAZINE: The magazines original to this model should have a tin-plated, wrap-around body with a wood base. They should be proof marked and serial numbered to the pistol.

FINISH: The main finish on this model should be a high-quality rust blue. The ejector, magazine catch/release, takedown lever, thumb safety lever and trigger should all be straw colored.

SERIAL NUMBER RANGE: In the s, t and u serial number suffix blocks.

SERIAL NUMBER LOCATION: The full serial number is found on the bottom of the barrel, the front of the frame, and the left side of the receiver. The last two digits of the serial number are on the breechblock (lower left side), extractor, front toggle link (bottom), rear toggle link (back), sear (left side), sear bar safety lever, side plate, takedown lever (bottom), thumb safety lever (top), trigger (top left), and grips (inside).

INTERESTING VARIATIONS

There are no notable variations of this model.

MARKINGS

MARK	LOCATION/DESCRIPTION
------	----------------------



Toggle
Manufacturer's Logo



Receiver
Nitro Commercial Proof
Indicative of commercial purchase



Police Acceptance Mark
On side plate



Barrel
Berlin Police Armory
Acceptance Stamp

Following are some variations of this mark.



Found on Receiver and/or barrel

VALUES

POOR	FAIR	GOOD	VG	EXC
\$400	\$650	\$800	\$1,250	\$1,500

Look-Up Index # 91

MILITARY & POLICE NO DATE, NAVY

BACKGROUND

The Military & Police No Date, Navy model has the same origin as the Military & Police, Army model (see the preceding model), but with different proofing for Weimar Navy use.

HOW TO TELL A MILITARY & POLICE NO DATE, NAVY

The Military & Police No Date, Navy is easily distinguished from other Lugers by four features in combination.

1. The toggle is marked with the Scroll DWM logo.
2. The chamber is blank.
3. No Imperial military proofs, nor signs of having had proof marks or a chamber date removed.
4. Weimar Navy type marks.

QUANTITY MADE

Unknown.

RARITY RATING

7, Very rare.

FEATURES IN DEPTH

MANUFACTURER: This model was manufactured by DWM (Deutsche Waffen and Munitionsfabriken) of Berlin.

TOGGLE: This model should have the new type toggle, with the flat, checkered toggle knobs.

TOGGLE MARK: 

BARREL: This model should have a 4-inch (100mm) barrel. It should be chambered for 9mm Parabellum.

FRAME: The frame on this model should be the late, short type with a stock lug, wide trigger and narrow trigger guard.

RECEIVER: The receiver on this model should be the late, short type. The chamber should be blank.

THUMB SAFETY: The thumb safety on this model should have a serrated safety lever. The upper position is marked "GESICHERT." Safe is in the lower position.

SIGHTS: The front sight on this model should be a dorsal fin shaped blade, dovetail fit on the barrel. The rear sight should be a fixed V notch in the rear toggle link.

EXTRACTOR: The extractor on this model should be the late type. It should be marked "GELADEN" on the left side.

GRIPS: The grips on this model should be checkered walnut.

MAGAZINE: The magazines original to this model should have a tin-plated, wrap-around body with a wood base. They should be proof marked and serial numbered to the pistol.

FINISH: The main finish on this model should be a high-quality rust blue. The ejector, magazine catch/release, takedown lever, thumb safety lever and trigger should all be straw colored.

SERIAL NUMBER RANGE: In the s and t serial number suffix blocks.

SERIAL NUMBER LOCATION: The full serial number is found on the bottom of the barrel, the front of the frame, and the left side of the receiver. The last two digits of the serial number are on the breechblock (lower left side), extractor, front toggle link (bottom), rear toggle link (back), sear (left side), sear bar safety lever, side plate, takedown lever (bottom), thumb safety lever (top), trigger (top left), and grips (inside).

INTERESTING VARIATIONS

There are legitimate variations that seem just like this model, but in the m and o serial number blocks, and are in 7.65mm (.30 Luger). These are undoubtedly commercial guns purchased to fill immediate needs, despite the caliber.

MARKINGS

MARK	LOCATION/DESCRIPTION
------	----------------------



Toggle
Manufacturer's Logo



Receiver
Nitro Commercial Proof



Front Strap
Reichsmarine Property Mark

N. Number

Front Strap
Nordsee Fleet Inventory
Number

VALUES

POOR	FAIR	GOOD	VG	EXC
\$750	\$1,000	\$1,500	\$2,500	\$4,000

Look-Up Index # 92

MILITARY & POLICE NO DATE, NAVY MA

BACKGROUND

The Military & Police Dated, Navy MA model was proofed and accepted at the Marine Arsenal (thus the M/A stamp) at Kiel. Previously the M/A mark on this model was thought to stand for Mauser Arbeiten, or Mauser Rework.

More recent research and correlation with the presence of N. or O. fleet property numbers has shown the real story.

HOW TO TELL A MILITARY & POLICE NO DATE, NAVY MA

The Military & Police Dated, Navy MA is easily distinguished from other Lugers by four distinct feature.

1. The toggle is marked with the Scroll DWM logo.
2. The chamber is blank.
3. No Imperial military proofs, nor signs of having had proof marks or a chamber date removed.
4. The Marine Arsenal (M/A) inscription on the left side of the receiver.

QUANTITY MADE

Unknown.

RARITY RATING

7, Very rare.

FEATURES IN DEPTH

MANUFACTURER: This model was manufactured by DWM (Deutsche Waffen and Munitionsfabriken) of Berlin.

TOGGLE: This model should have the new type toggle, with the flat, checkered toggle knobs.

TOGGLE MARK: 

BARREL: This model should have a 4-inch (100mm) barrel. It should be chambered for 9mm Parabellum.

FRAME: The frame on this model should be the late, short type with a stock lug, wide trigger and narrow trigger guard.

RECEIVER: The receiver on this model should be the late, short type. The chamber could be blank or dated.

THUMB SAFETY: The thumb safety on this model should have a serrated safety lever. The upper position is marked "GESICHERT." Safe is in the lower position.

SIGHTS: The front sight on this model should be a dorsal fin shaped blade, dovetail fit on the barrel. The rear sight should be a fixed V notch in the rear toggle link.

EXTRACTOR: The extractor on this model should be the late type. It should be marked "GELADEN" on the left side.

GRIPS: The grips on this model should be checkered walnut.

MAGAZINE: The magazines original to this model should have a tin-plated, wrap-around body with a wood base. They should be proof marked and serial numbered to the pistol.

FINISH: The main finish on this model should be a high-quality rust blue. The ejector, magazine catch/release, takedown lever, thumb safety lever and trigger should all be straw colored.

SERIAL NUMBER RANGE: In the s and t serial number suffix blocks.

SERIAL NUMBER LOCATION: The full serial number is found on the bottom of the barrel, the front of the frame, and the left side of the receiver. The last two digits of the serial number are on the breechblock (lower left side), extractor, front toggle link (bottom), rear toggle link (back), sear (left side), sear bar safety lever, side plate, takedown lever (bottom), thumb safety lever (top), trigger (top left), and grips (inside).

INTERESTING VARIATIONS

There are no notable variations of this model.

MARKINGS

MARK	LOCATION/DESCRIPTION
------	----------------------



Toggle
Manufacturer's Logo



Receiver
Marine Arsenal Acceptance
Mark

O. Number

Front Strap
Ostsee Fleet Inventory
Number

VALUES

POOR	FAIR	GOOD	VG	EXC
\$750	\$1,000	\$1,500	\$2,500	\$4,000

Look-Up Index # 93

SIMSON & COMPANY



BACKGROUND

The Simson & Co. model was the official model that filled out the last of the post-WW I German military P.08 needs. Simson commenced work on this model in April of 1924. They would remain the only sanctioned supplier of P.08s to the Reichswehr until the Nazi-era.

This model actually consists of three variations; reworked earlier models, newly assembled Lugers from parts, newly manufactured Lugers.

Simson also made a small number of Lugers for commercial sales within Germany.

HOW TO TELL A SIMSON & CO.

The Simson & Co. can be distinguished from other Lugers by three features in combination.

1. The toggle is inscribed "SIMSON & CO SUHL."
2. It has no grip safety
3. The chamber is blank or dated 1917 or 1918.

QUANTITY MADE

Several thousand.

RARITY RATING

3-4, Uncommon to scarce.

FEATURES IN DEPTH

MANUFACTURER: This model was made by Simson & Co., Suhl.

TOGGLE: This model should have the new type toggle, with the flat, checkered toggle knobs.

TOGGLE MARK: SIMSON & Co. SUHL

BARREL: This model usually has a 4-inch (100mm) barrel chambered for 9mm Parabellum. Some with 3 7/8-inch barrels. Either length occasionally found in 7.65mm as well.

FRAME: The frame on this model should be the late, short type with a stock lug, wide trigger and narrow trigger guard.

RECEIVER: The receiver on this model should be the late, short type with a stock lug, wide trigger and narrow trigger guard. The chamber markings differ depending

on the variation. A rework or assembly will either be dated 1917 or 1918, or (more commonly) be blank but show signs of having had the date removed. A newly manufactured specimen will have a blank chamber.

THUMB SAFETY: The thumb safety on this model should have a serrated safety lever. The upper position is marked "GESICHERT." Safe is in the lower position.

SIGHTS: The front sight on this model should be a dorsal fin shaped blade, dovetail fit on the barrel. The rear sight should be a fixed V notch in the rear toggle link.

EXTRACTOR: The extractor on this model should be the late type. It should be marked "GELADEN" on the left side.

GRIPS: The grips on this model should be checkered walnut.

MAGAZINE: The magazines original to this model should have a tin-plated, wrap-around body with either an aluminum or wood base. They should be proof marked and serial numbered to the pistol.

FINISH: The main finish on this model should be a high-quality rust blue. The ejector, magazine catch/release, takedown lever, thumb safety lever and trigger should all be straw colored.

SERIAL NUMBER RANGE: Starting from 1 and proceeding into at least 1700 a.

SERIAL NUMBER LOCATION: The full serial number is found on the bottom of the barrel, the front of the frame, and the left side of the receiver. The last two digits of the serial number are on the breechblock (lower left side), extractor, front toggle link (bottom), rear toggle link (back), sear (left side), sear bar safety lever, side plate, takedown lever (bottom), thumb safety lever (top), trigger (top left), and grips (inside).

INTERESTING VARIATIONS

Just to repeat, this is one of the few models that accurately consists of three variations. Another way to tell reworks from new manufacture would to look for earlier era proof marks.

MARKINGS

MARK	LOCATION/DESCRIPTION
------	----------------------



Receiver
Simson Acceptance Marks

Other numbers and eagle variations include these





Parts
Simson Inspection Mark



Receiver and Barrel
Simson Test Fire Proof

VALUES

POOR	FAIR	GOOD	VG	EXC
\$700	\$1,000	\$2,000	\$2,500	\$3,250

Look-Up Index # 94

1920 SNEAK

BACKGROUND

The 1920 Sneak model is a collector’s catchall for post-WW I Lugers that are missing some or all expected proof marks. There are two common categories of these pistols. First is the individual “lunch box special” smuggled out of the factory by a worker. The second was more sinister than simple theft.

The restriction on military pistol calibers imposed by the Versailles Treaty created a dilemma for DWM. There was an underground desire for pistols that could only legally be made by Simson. Yet their production was closely monitored. DWM for forbidden to make the Luger in 9mm Parabellum. Apparently, DWM either looked the other way, or even outright endorsed the practice as unmarked pistols found their way to users.

HOW TO TELL A 1920 SNEAK

The 1920 Sneak, by its definition as a model variation, is such a collection of features, markings, and serial number styles, that it is difficult to capture it all in any understandable manner. However, this is a more or less “average” description.

1. Late, flat, checkered style toggle knobs.
2. The toggle is unmarked.
3. The chamber is unmarked.
4. No proof marks.

QUANTITY MADE

Unknown. Most likely in the few thousand.

RARITY RATING

4, Scarce

FEATURES IN DEPTH

MANUFACTURER: This model was manufactured by DWM (Deutsche Waffen and Munitionsfabriken) of Berlin.

TOGGLE: This model should have the new type toggle, with the flat, checkered toggle knobs.

TOGGLE MARK: The toggle on this model should be blank.

BARREL: This model should have a 4-inch (100mm) barrel. It should be chambered for 9mm Parabellum.

FRAME: The receiver on this model should be the late, short type with a stock lug, wide trigger and narrow trigger guard.

RECEIVER: The receiver on this model should be the late, short type. The chamber should be blank.

THUMB SAFETY: The thumb safety on this model should have a serrated safety lever. The upper position is marked “GESICHERT.” Safe is in the lower position.

SIGHTS: The front sight on this model should be a dorsal fin shaped blade, dovetail fit on the barrel. The rear sight should be a fixed V notch in the rear toggle link.

EXTRACTOR: The extractor on this model should be the late type. It should be marked “GELADEN” or “LOADED” on the left side.

GRIPS: The grips on this model should be checkered walnut.

MAGAZINE: The magazines original to this model should have a tin-plated, wrap-around body with a wood base. They were typically not serial numbered or proof marked.

FINISH: The main finish on this model should be a high-quality rust blue. The ejector, magazine catch/release, takedown lever, thumb safety lever and trigger should all be straw colored.

SERIAL NUMBER RANGE: 1 to four-digits with military style letter suffixing. Some may not be numbered.

SERIAL NUMBER LOCATION: The full serial number is found on the bottom of the barrel and on the front of the frame. The last two digits of the serial number are on the breechblock (lower left side), extractor (bottom), front toggle link (bottom), rear toggle link (back), receiver (rear), side plate (bottom edge), takedown lever (bottom), trigger (top left), and grips (inside).

INTERESTING VARIATIONS

These could have a combination of missing and present marks.

MARKINGS

MARK	LOCATION/DESCRIPTION
None.	

VALUES

POOR	FAIR	GOOD	VG	EXC
\$300	\$400	\$500	\$750	\$950

Look-Up Index # 95

1919 COMMERCIAL

BACKGROUND

The 1919 Commercial model was generally made for commercial sales immediately following the WW I. These have previously been referred to as the 1923 Commercial model, in the belief that they followed the military style numbered 1920 Commercials. Research now shows that these PRECEDED the military style numbered commercials.

HOW TO TELL A 1919 COMMERCIAL

The 1919 Commercial can be distinguished from other Lugers by six features in combination.

1. Late, flat, checkered style toggle knobs.
2. Toggle has the scrolled DWM inscription.
3. Chamber is unmarked.
4. Has a stock lug.
5. Commercial Crown over N proof on left side of receiver.
6. In the 73500 to 96000 serial number range.

QUANTITY MADE

Approximately 13,000.

RARITY RATING

3, Uncommon.

FEATURES IN DEPTH

MANUFACTURER: This model was manufactured by DWM (Deutsche Waffen and Munitionsfabriken) of Berlin.

TOGGLE: This model should have the new type toggle, with the flat, checkered toggle knobs.

TOGGLE MARK: 

BARREL: This model should have an 3 5/8-inch barrel. It should be chambered for 7.65mm (.30 Luger).

FRAME: The frame on this model should be the late, short type with a stock lug, wide trigger and narrow trigger guard.

RECEIVER: The receiver on this model should be the late, short type. The chamber should be blank.

THUMB SAFETY: The thumb safety on this model should have a serrated safety lever. The upper position is marked "GESICHERT." Safe is in the lower position.

SIGHTS: The front sight on this model should be a dorsal fin shaped blade, dovetail fit on the barrel. The rear sight should be a fixed V notch in the rear toggle link.

EXTRACTOR: The extractor on this model should be the late type. It should be marked "GELADEN" on the left side.

GRIPS: The grips on this model should be checkered walnut.

MAGAZINE: The magazines original to this model should have a tin-plated, wrap-around body with either an aluminum or wood base. They should not be proof marked or serial numbered.

FINISH: The main finish on this model should be a high-quality rust blue. The ejector, magazine catch/release, takedown lever, thumb safety lever and trigger should all be straw colored.

SERIAL NUMBER RANGE:

74845 to 92000 in 7.65mm.

75441 to 87000 in 9mm.

SERIAL NUMBER LOCATION: The full serial number is found on the bottom of the barrel and on the front of the frame. The last two digits of the serial number are on the breechblock (lower left side), extractor (bottom), front toggle link (bottom), rear toggle link (back), receiver (rear), side plate (bottom edge), takedown lever (bottom), trigger (top left), and grips (inside).

INTERESTING VARIATIONS

Fewer than 500 of these were purchased by the Swiss Basel police. These were in 9mm Parabellum, and found in the serial number range 75441 to 76049. Unfortunately, these do not carry any distinguishing marks. The best means of identification is to find one accompanied by the Basel Police holster.

MARKINGS

MARK	LOCATION/DESCRIPTION
------	----------------------



Toggle
Manufacturer's Logo



Receiver
Nitro Commercial Proof

VALUES

POOR	FAIR	GOOD	VG	EXC
\$450	\$650	\$950	\$1,250	\$1,500

Look-Up Index # 96**1920 COMMERCIAL****BACKGROUND**

The 1920 Commercial model was made to keep DWM alive (financially) in the difficult years following WW I.

During the war, DWM had become nearly completely dependent on German military sales. Since many of the sidearms for the size restricted Reichswehr came from existing supplies (see the 1920 Double Date and 1920 Military and Police models), DWM had to rekindle commercial markets.

However, money tied up in parts inventory, and a lack of new venture capital forced DWM to commercially market Lugers made up from military marked parts. The result was the 1920 Commercial model.

It was an excellent strategy, which brought DWM back to its former financial health.

HOW TO TELL A 1920 COMMERCIAL

The 1920 Commercial has such a collection of features, markings, and serial number styles, that it is difficult to capture it all in any understandable manner. However, this is a more or less “average” description.

1. Late, flat, checkered style toggle knobs.
2. Toggle has the scrolled DWM inscription.
3. Chamber is unmarked.
4. Has a stock lug.
5. Commercial Crown over N proof on left side of receiver.
6. 4-inch or shorter barrel, chambered for 7.65mm.
7. Serial number of no more than four-digits.

QUANTITY MADE

Many many thousand.

RARITY RATING

- 1, As common as they get.

FEATURES IN DEPTH

MANUFACTURER: This model was manufactured by DWM (Deutsche Waffen and Munitionsfabriken) of Berlin.

TOGGLE: This model should have the new type toggle, with the flat, checkered toggle knobs.

TOGGLE MARK:



BARREL: This model should have a 4-inch (100mm) barrel. It should be chambered for 7.65mm (.30 Luger).

Occasionally found in 9mm Parabellum, usually with a 3 7/8" length barrel.

FRAME: The frame on this model should be the late, short type with a stock lug, wide trigger and narrow trigger guard. Many are marked “MADE IN GERMANY” or simply “GERMANY,” indicating export and sale in the US.

RECEIVER: The receiver on this model should be the late, short type. The chamber should be blank. A dated chamber is uncommon.

THUMB SAFETY: The thumb safety on this model should have a serrated safety lever. The upper position is marked “GESICHERT.” Safe is in the lower position.

SIGHTS: The front sight on this model should be a dorsal fin shaped blade, dovetail fit on the barrel. The rear sight should be a fixed V notch in the rear toggle link.

EXTRACTOR: The extractor on this model should be the late type. It should be marked “GELADEN” or “LOADED” on the left side.

GRIPS: The grips on this model should be checkered walnut.

MAGAZINE: The magazines original to this model should have a tin-plated, wrap-around body with a wood base. They were typically not serial numbered or proof marked.

FINISH: The main finish on this model should be a high-quality rust blue. The ejector, magazine catch/release, takedown lever, thumb safety lever and trigger should all be straw colored.

SERIAL NUMBER RANGE: The use of spare and left over military serial numbered parts, created multiple ranges.

7.65mm Undated: In the i to r suffix blocks.

9mm 1920 Dated: 83970 to 85260 range.

9mm 1921 Dated: 85473 to 89572 range
and the i suffix block.

SERIAL NUMBER LOCATION: The full serial number is found on the bottom of the barrel and on the front of the frame. The last two digits of the serial number are on the breechblock (lower left side), extractor (bottom), front toggle link (bottom), rear toggle link (back), receiver (rear), side plate (bottom edge), takedown lever (bottom), trigger (top left), and grips (inside).

INTERESTING VARIATIONS

DWM did not turn down many orders during this time. Different barrel lengths and sight configurations, navy, artillery, even longer length barrels are known.

There is a Luger reported with what looks like a Crown over backwards “N.” Some have dubbed this a 1923 Russian Contract, it is in all probability just a 1920 commercial stamped with a defective die.

MARKINGS

MARK **LOCATION/DESCRIPTION**



Toggle
Manufacturer's Logo



Receiver
Nitro Commercial Proof

VALUES

POOR	FAIR	GOOD	VG	EXC
4-inch Barrel Lengths				
\$350	\$500	\$650	\$1,000	\$1,250
10- to 24-inch Barrel Lengths				
\$850	\$1,000	\$1,500	\$2,250	\$3,250

Look-Up Index # 97

1920 CARBINE

BACKGROUND

The 1920 Carbine model was made for general commercial sales both domestically within Germany and abroad.

HOW TO TELL A 1920 CARBINE

The 1920 Carbine can be distinguished from other Lugers by four features in combination.

1. Late, flat, checkered style toggle knobs.
2. 11¾-inch barrel with a walnut forearm.
3. Adjustable rear sight located on the rear of the barrel, just forward of the chamber.
4. The Crown/N commercial proof

QUANTITY MADE

Very few.

RARITY RATING

7, Very rare.

FEATURES IN DEPTH

MANUFACTURER: This model was manufactured by DWM (Deutsche Waffen and Munitionsfabriken) of Berlin.

TOGGLE: This model should have the new type toggle, with the flat, checkered toggle knobs.

TOGGLE MARK:

BARREL: This model should have an 11¾-inch barrel with a walnut forearm. It should be chambered for 7.65mm (.30 Luger). Examples are reported in 9mm Parabellum.

FRAME: The frame on this model should be the late, short type with a stock lug, wide trigger and narrow trigger guard. Some will have a grip safety. Most are marked "MADE in GERMANY" or just "GERMANY."

RECEIVER: The receiver on this model should be the late, short type. The chamber should be blank.

THUMB SAFETY: The thumb safety on this model should have a serrated safety lever. Both positions are blue and unmarked. Safe is in the upper position.

SIGHTS: The front sight on this model should be a bead atop a ramp that is integral with the barrel. The rear sight should be a four-position adjustable V notch on the rear of the barrel just forward of the chamber.

EXTRACTOR: The extractor on this model should be the late type. It should be marked "GELADEN" or "LOADED" on the left side.

GRIPS: The grips on this model should be checkered walnut. The left grip should be slotted for the grip safety when a grip safety is present.

FOREARM: This model should have a checkered walnut forearm with a sling swivel and an actuator spring mechanism. The actuator mechanism stores energy from the recoil of firing, and then assists in returning the heavier barreled receiver assembly to battery.

MAGAZINE: The magazines original to this model should have a tin-plated, wrap-around body with a wood base. They should not be serial numbered or proof marked.

FINISH: The main finish on this model should be a high-quality rust blue. The ejector, magazine catch/release, takedown lever, thumb safety lever and trigger should all be straw colored.



SERIAL NUMBER RANGE: 1 to four-digits, likely without military style letter suffixing.

SERIAL NUMBER LOCATION: The full serial number is found on the bottom of the barrel and on the front of the frame. The last two digits of the serial number are on the breechblock (lower left side), extractor (bottom), front toggle link (bottom), rear toggle link (back), receiver (rear), side plate (bottom edge), takedown lever (bottom), trigger (top left), grip safety (under grip) and grips (inside).

INTERESTING VARIATIONS

Some examples are reported in 9mm Parabellum.

MARKINGS

MARK	LOCATION/DESCRIPTION
	Toggle Manufacturer's Logo
	Receiver Nitro Commercial Proof

VALUES				
POOR	FAIR	GOOD	VG	EXC
\$1,500	\$3,200	\$5,000	\$6,000	\$9,500

Look-Up Index # 98

1920 ARTILLERY COMMERCIAL

BACKGROUND

The 1920 Artillery Commercial model was generally made for commercial sales both domestically within Germany and abroad. This model consists of reworked WW I military models, newly assembled Lugers from surplus military parts, and totally new manufactured Lugers.

HOW TO TELL A 1920 ARTILLERY COMMERCIAL

The 1920 Artillery Commercial can be distinguished from other Lugers by four features in combination.

1. Late, flat, checkered style toggle knobs.
2. 8-inch barrel.
3. Adjustable rear sight located on the rear of the barrel, just forward of the chamber.
4. Commercial, Crown/N proof.

QUANTITY MADE

Very few.

RARITY RATING

4, Scarce.

FEATURES IN DEPTH

MANUFACTURER: This model was manufactured by DWM (Deutsche Waffen and Munitionsfabriken) of Berlin.

TOGGLE: This model should have the new type toggle, with the flat, checkered toggle knobs.

TOGGLE MARK: 

BARREL: This model should have a 8-inch (200mm) barrel. It should be chambered for 9mm Parabellum.

FRAME: The frame on this model should be the late, short type with a stock lug, wide trigger and narrow trigger guard. Some are marked "GERMANY" or "MADE IN GERMANY," indicating export and sale in the US.

RECEIVER: The receiver on this model should be the late, short type. The chamber should be blank. A very few have a four-digit year date from 1914 through 1918.

THUMB SAFETY: The thumb safety on this model should have a serrated safety lever. The upper position is marked "GESICHERT." Safe is in the lower position.

SIGHTS: The front sight on this model should be a dorsal fin shaped blade, dovetail fit on the barrel. The rear sight should be a nine-position adjustable V notch located on the barrel just forward of the chamber.

EXTRACTOR: The extractor on this model should be the late type. It should be marked "GELADEN" or "LOADED" on the left side.

GRIPS: The grips on this model should be checkered walnut.

MAGAZINE: The magazines original to this model should have a tin-plated, wrap-around body with a wood base. They should not be serial numbered or proof marked.

FINISH: The main finish on this model should be a high-quality rust blue. The ejector, magazine catch/release, takedown lever, thumb safety lever and trigger should all be straw colored.

SERIAL NUMBER RANGE: 1 to four-digits with military style letter suffixing.

SERIAL NUMBER LOCATION: The full serial number is found on the bottom of the barrel, on the front of the frame, and sometimes on the left side of the receiver. The last two digits of the serial number are on the breechblock (lower left side), extractor, front toggle link, rear toggle link (back), sear (left side), sear bar safety lever, side plate, takedown lever, thumb safety lever (top), trigger (top left), and grips (inside).

INTERESTING VARIATIONS

Some examples are reported in 7.65mm (.30 Luger).

MARKINGS

MARK	LOCATION/DESCRIPTION
	Toggle Manufacturer's Logo



Receiver
Nitro Commercial Proof

VALUES

POOR	FAIR	GOOD	VG	EXC
\$500	\$1,200	\$1,650	\$2,500	\$4,000

Look-Up Index # 99

1920 NAVY COMMERCIAL

BACKGROUND

The 1920 Navy Commercial model was generally assembled from surplus Navy military Lugers for commercial sales both domestically within Germany and abroad.

HOW TO TELL A 1920 NAVY COMMERCIAL

The 1920 Navy Commercial can be distinguished from other Lugers by three features in combination.

1. Late, flat, checkered style toggle knobs.
2. 6-inch barrel.
3. Crown/N commercial proof.

QUANTITY MADE

Very few.

RARITY RATING

5-6, Somewhat rare to rare.

FEATURES IN DEPTH

MANUFACTURER: This model was manufactured by DWM (Deutsche Waffen and Munitionsfabriken) of Berlin.

TOGGLE: This model should have the new type toggle, with the flat, checkered toggle knobs.

TOGGLE MARK: 

BARREL: This model should have a 6-inch (150mm) barrel. It should be chambered for 9mm Parabellum.

FRAME: The frame on this model should be the late, short type with a stock lug, wide trigger and narrow trigger guard. Some are marked "GERMANY" or "MADE IN GERMANY," indicating export and sale in the US.

RECEIVER: The receiver on this model should be the late, short type. The chamber should be blank.

THUMB SAFETY: The thumb safety on this model should have a serrated safety lever. The upper position is marked "GESICHERT." Safe is in the lower position.

SIGHTS: The front sight on this model should be a dorsal fin shaped blade, dovetail fit on the barrel. The rear sight should be a two-position adjustable V notch located on the rear toggle link. The rear sight adjusts to 100- or 200-meter positions.

EXTRACTOR: The extractor on this model should be the late type. It should be marked "GELADEN" on the left side.

GRIPS: The grips on this model should be checkered walnut.

MAGAZINE: The magazines original to this model should have a tin-plated, wrap-around body with a wood base. They should not be serial numbered or proof marked.

FINISH: The main finish on this model should be a high-quality rust blue. The ejector, magazine catch/release, takedown lever, thumb safety lever and trigger should all be straw colored.

SERIAL NUMBER RANGE: 1 to four-digits in the m and o blocks.

SERIAL NUMBER LOCATION: The full serial number is found on the bottom of the barrel, on the front of the frame, and sometimes on the left side of the receiver. The last two digits of the serial number are on the breechblock (lower left side), extractor, front toggle link, rear toggle link (back), side plate, takedown lever, thumb safety lever (top), trigger (top left), and grips (inside).

INTERESTING VARIATIONS

Some examples are reported in 7.65mm (.30 Luger).

MARKINGS

MARK	LOCATION/DESCRIPTION
------	----------------------



Toggle
Manufacturer's Logo



Receiver
Nitro Commercial Proof



Barrel
Imperial Navy Proof Mark



Barrel
Imperial Navy Proof Mark



Receiver
Imperial Navy Acceptance
Mark



Receiver
Imperial Navy Acceptance
Mark

VALUES

POOR	FAIR	GOOD	VG	EXC
\$900	\$1,200	\$1,500	\$2,250	\$5,000

Look-Up Index # 100

1920 NAVY COMMERCIAL CARBINE

BACKGROUND

The 1920 Navy Commercial Carbine model was generally assembled from surplus Navy military Lugers for commercial sales both domestically within Germany and abroad.

HOW TO TELL A 1920 NAVY COMMERCIAL CARBINE

The 1920 Navy Commercial Carbine can be distinguished from other Lugers by three features in combination.

1. Late, flat, checkered style toggle knobs.
2. 11¾-inch barrel with a walnut forearm.
3. Adjustable rear sight located on the rear toggle link.

QUANTITY MADE

Very few.

RARITY RATING

8, Extremely rare.

FEATURES IN DEPTH

MANUFACTURER: This model was manufactured by DWM (Deutsche Waffen and Munitionsfabriken) of Berlin.

TOGGLE: This model should have the new type toggle, with the flat, checkered toggle knobs.

TOGGLE MARK: 

BARREL: This model should have an 11¾-inch barrel with a walnut forearm. It could be chambered for 9mm Parabellum or 7.65mm (.30 Luger). Examples are reported in 9mm Parabellum.

FRAME: The frame on this model should be the late, long type with a grip safety, stock lug, wide trigger and narrow trigger guard. Some are marked "MADE IN

GERMANY" or just "GERMANY," indicating export and sale in the US.

RECEIVER: The receiver on this model should be the late, long type. The chamber should be blank.

THUMB SAFETY: The thumb safety on this model should have a serrated safety lever. The upper position is marked "GESICHERT." Safe is in the lower position.

SIGHTS: The front sight on this model should be a bead atop a ramp, which is integral with the barrel. The rear sight should be a two-position adjustable V notch located on the rear toggle link. The rear sight adjusts to 100- or 200-meter positions.

EXTRACTOR: The extractor on this model should be the late type. It should be marked "GELADEN" on the left side.

GRIPS: The grips on this model should be checkered walnut. The left grip should be slotted for the grip safety.

FOREARM: This model should have a checkered walnut forearm with a sling swivel. There is a variation of the forearm with a simpler checkering pattern, which attaches via screw from the bottom.

MAGAZINE: The magazines original to this model should have a tin-plated, wrap-around body with a wood base. They should not be serial numbered or proof marked.

FINISH: The main finish on this model should be a high-quality rust blue. The ejector, magazine catch/release, takedown lever, thumb safety lever and trigger should all be straw colored.

SERIAL NUMBER RANGE: 1 to three digits.

SERIAL NUMBER LOCATION: The full serial number is found on the bottom of the barrel and on the front of the frame. The last two digits of the serial number are on the breechblock (lower left side), extractor (bottom), front toggle link (bottom), rear toggle link (back), receiver (rear), side plate (bottom edge), takedown lever (bottom), trigger (top left), grip safety (under grip) and grips (inside).

INTERESTING VARIATIONS

There are no notable variations of this model.

MARKINGS

MARK **LOCATION/DESCRIPTION**



Toggle
Manufacturer's Logo



Receiver
Nitro Commercial Proof



Barrel
Imperial Navy Proof Mark



Barrel
Imperial Navy Proof Mark



Receiver
Imperial Navy Acceptance
Mark



Receiver
Imperial Navy Acceptance
Mark

VALUES

POOR	FAIR	GOOD	VG	EXC
\$900	\$1,200	\$1,500	\$2,250	\$5,000

Look-Up Index # 101

1920 SWISS

BACKGROUND

The 1920 Swiss model was generally made for commercial sales in Switzerland.

HOW TO TELL A 1920 SWISS

The 1920 Swiss can be distinguished from other Lugers by six features in combination.

1. Late, flat, checkered style toggle knobs.
2. The toggle is marked with the Scroll DWM logo.
3. Cross in Sunburst crest inscription above the chamber.
4. Crown/N commercial proof.
5. In the 87130 to 87150 serial number range, or in the i serial number block.
6. No barrel inscription referencing Abercrombie and Fitch.

QUANTITY MADE

Several thousand.

RARITY RATING

3, Uncommon.

FEATURES IN DEPTH

MANUFACTURER: This model was manufactured by DWM (Deutsche Waffen and Munitionsfabriken) of Berlin.

TOGGLE: This model should have the new type toggle, with the flat, checkered toggle knobs.

TOGGLE MARK:

BARREL: This model is found with various barrel lengths from 3 5/8 inches up to 6 inches. The 4 3/4-inch (120mm) is most common. It should usually be chambered for 7.65mm, although 9mm Parabellum examples can be found.

FRAME: The frame on this model should be the late, long type with a grip safety, wide trigger and narrow trigger guard.

RECEIVER: The receiver on this model should be the late, long type. The chamber should be marked with the Swiss Cross in Sunburst inscription.

THUMB SAFETY: The thumb safety on this model should have a serrated safety lever. The lower position is polished (not blued). Safe is in the upper position.

SIGHTS: The front sight on this model should be a saw tooth shaped blade, dovetail fit on the barrel. The rear sight should be a fixed V notch in the rear toggle link.

EXTRACTOR: The extractor on this model should be the late type. It should be marked "GELADEN" on the left side.

GRIPS: The grips on this model should be checkered walnut. The left grip should be slotted for the grip safety.

MAGAZINE: The magazines original to this model should have a tin-plated, wrap-around body with a wood base. They should not be proof marked or serial numbered.

FINISH: The main finish on this model should be a high-quality rust blue. The ejector, magazine catch/release, takedown lever, thumb safety lever and trigger should all be straw colored.

SERIAL NUMBER RANGE: 87130 to 87150 range and in the i serial number suffix block.

SERIAL NUMBER LOCATION: The full serial number is found on the bottom of the barrel, on the front of the frame, and the left side of the receiver. The last two digits of the serial number are on the breechblock (lower left side), extractor (bottom), front toggle link (bottom), rear toggle link (back), side plate (bottom edge), takedown lever (bottom), trigger (top left), grip safety (under grip) and grips (inside).

INTERESTING VARIATIONS

There is also a variation of this model that consists of reworked surplus military Lugers. These generally have the new short frame and receiver (of the original model that was reworked), and had the "GESICHERT" thumb safety mark removed. These reworks were often rebarreled.

MARKINGS

MARK	LOCATION/DESCRIPTION
------	----------------------



Toggle
Manufacturer's Logo



Receiver
Nitro Commercial Proof



Barrel and Receiver
Swiss Rework Proof

VALUES

POOR	FAIR	GOOD	VG	EXC
\$850	\$1,100	\$2,000	\$3,000	\$4,500

Look-Up Index # 102

DWM/KRIEGHOFF, BACKFRAME INSCRIPTION



BACKGROUND

The DWM/Krieghoff, Backframe Inscription model was generally made for commercial sales by Krieghoff. These should not be confused with any of the later Krieghoff manufactured P.08s. These were completely made by DWM.

HOW TO TELL A DWM/KRIEGHOFF, BACKFRAME INSCRIPTION

The DWM/Krieghoff, Backframe Inscription can be distinguished from other Lugers by one distinct feature.

1. The back of the frame just above the lanyard loop is stamped "Krieghoff Suhl" The second "f" in Krieghoff is slightly deformed on all these.

QUANTITY MADE

5,000 (includes the DWM/Krieghoff Side Frame Inscription model).

RARITY RATING

5, Somewhat rare.

FEATURES IN DEPTH

MANUFACTURER: This model was manufactured by DWM (Deutsche Waffen and Munitionsfabriken) of Berlin.

TOGGLE: This model should have the new type toggle, with the flat, checkered toggle knobs.

TOGGLE MARK: 

BARREL: This model should have either a 4-inch (100mm) barrel chambered for 9mm Parabellum, or a 3 7/8-inch (90mm) barrel chambered for 7.65mm (.30 Luger). The shorter barrel and smaller caliber were requirements for commercially produced small arms under the Versailles Treaty.

FRAME: The frame on this model should be the late, short type with a stock lug, wide trigger and narrow trigger guard.

RECEIVER: The receiver on this model should be the late, short type. The chamber should either be unmarked or dated from 1921.

THUMB SAFETY: The thumb safety on this model should have a serrated safety lever. The upper position is marked "GESICHERT." Safe is in the lower position.

SIGHTS: The front sight on this model should be a dorsal fin shaped blade, dovetail fit on the barrel. The rear sight should be a fixed V notch in the rear toggle link.

EXTRACTOR: The extractor on this model should be the late type. It should be marked "GELADEN" on the left side.

GRIPS: The grips on this model should be checkered walnut.

MAGAZINE: The magazines original to this model should have a tin-plated, wrap-around body with a wood base. They should not be proof marked or serial numbered.

FINISH: The main finish on this model should be a high-quality rust blue. The ejector, magazine catch/release, takedown lever, thumb safety lever and trigger should all be straw colored.

SERIAL NUMBER RANGE: 2190 i to 9900 i (same range as the DWM/Krieghoff Side Frame Inscription model).

SERIAL NUMBER LOCATION: The full serial number is found on the bottom of the barrel and on the front of the frame. The last two digits of the serial number are on the breechblock (lower left side), extractor (bottom), front toggle link (bottom), rear toggle link (back), receiver (rear), side plate (bottom edge), takedown lever (bottom), trigger (top left), and grips (inside).

INTERESTING VARIATIONS

There are no notable variations of this model.

MARKINGS

MARK **LOCATION/DESCRIPTION**



Toggle
Manufacturer's Logo



Receiver
Nitro Commercial Proof

VALUES

POOR	FAIR	GOOD	VG	EXC
\$500	\$650	\$1,000	\$1,800	\$2,500

Look-Up Index # 103

DWM/KRIEGHOFF, FRAME INSCRIPTION

BACKGROUND

The DWM/Krieghoff, Frame Inscription model was generally made for commercial sales by Krieghoff. These should not be confused with any of the later Krieghoff manufactured P.08s. These were completely made by DWM.

HOW TO TELL A DWM/KRIEGHOFF, FRAME INSCRIPTION

The DWM/ Krieghoff, Frame Inscription can be distinguished from other Lugers by two features in combination.

1. The toggle is marked with the scroll DWM logo.
2. The left side of the frame is inscribed "Heinrich Krieghoff Waffenfabrik Suhl."

QUANTITY MADE

5,000 (includes the DWM/Krieghoff, Backframe Inscription model)

RARITY RATING

5, Somewhat rare.

FEATURES IN DEPTH

MANUFACTURER: This model was manufactured by DWM (Deutsche Waffen and Munitionsfabriken) of Berlin.

TOGGLE: This model should have the new type toggle, with the flat, checkered toggle knobs.

TOGGLE MARK: 

BARREL: This model should have either a 4-inch (100mm) barrel chambered for 9mm Parabellum, or a 3 7/8-inch (90mm) barrel chambered for 7.65mm (.30 Luger). The shorter barrel and smaller caliber were requirements for commercially produced small arms under the Versailles Treaty.

FRAME: The frame on this model should be the late, short type with a stock lug, wide trigger and narrow trigger guard.

RECEIVER: The receiver on this model should be the late, short type. The chamber should be blank.

THUMB SAFETY: The thumb safety on this model should have a serrated safety lever. The upper position is marked "GESICHERT." Safe is in the lower position.

SIGHTS: The front sight on this model should be a dorsal fin shaped blade, dovetail fit on the barrel. The rear sight should be a fixed V notch in the rear toggle link.

EXTRACTOR: The extractor on this model should be the late type. It should be marked "GELADEN" on the left side.

GRIPS: The grips on this model should be checkered walnut.

MAGAZINE: The magazines original to this model should have a tin-plated, wrap-around body with a wood base. They should not be proof marked or serial numbered.

FINISH: The main finish on this model should be a high-quality rust blue. The ejector, magazine catch/release, takedown lever, thumb safety lever and trigger should all be straw colored.

SERIAL NUMBER RANGE: 2190 i to 9900 i (same range as the DWM/Krieghoff, Backframe Inscription model)



SERIAL NUMBER LOCATION: The full serial number is found on the bottom of the barrel and on the front of the frame. The last two digits of the serial number are on the breechblock (lower left side), extractor (bottom), front toggle link (bottom), rear toggle link (back), receiver

(rear), side plate (bottom edge), takedown lever (bottom), trigger (top left), and grips (inside).

INTERESTING VARIATIONS

One example is known with a Krieghoff dagger/ anchor logo marked toggle. This specimen does not have the Krieghoff inscription on the side of the frame. What gives this piece providence is that the curve of the anchor points in the toggle stamp is different from all subsequent Krieghoff toggle logo stamps. Likely not just a mismatched toggle.

MARKINGS

MARK	LOCATION/DESCRIPTION
	Toggle Manufacturer's Logo
	Receiver Nitro Commercial Proof

VALUES				
POOR	FAIR	GOOD	VG	EXC
\$500	\$650	\$1,000	\$1,800	\$2,500

Look-Up Index # 104

1922 ABERCROMBIE & FITCH

BACKGROUND

The 1922 Abercrombie & Fitch model actually consisted of earlier DWM made Swiss Lugers, with Swiss made replacement barrels, imported specifically for US commercial sales through the sporting goods retailer Abercrombie & Fitch.

HOW TO TELL AN ABERCROMBIE & FITCH

The 1922 Abercrombie & Fitch can be distinguished from other Lugers by one distinct feature.

1. The top of the barrel bears the inscription "ABERCROMBIE & FITCH Co. NEW YORK. MADE IN SWITZERLAND."

QUANTITY MADE

100 Total, 51 in 7.65mm, 49 in 9mm Parabellum.

RARITY RATING

7 to 8, Very rare to extremely rare.

FEATURES IN DEPTH

MANUFACTURER: This model was manufactured by DWM (Deutsche Waffen and Munitionsfabriken) of Berlin.

TOGGLE: This model should have the new type toggle, with the flat, checkered toggle knobs.

TOGGLE MARK: 

BARREL: This model should have either a 4¾-inch (120mm) barrel chambered for either 9mm Parabellum or for 7.65mm (.30 Luger). It should be marked "ABERCROMBIE & FITCH Co. NEW YORK. MADE IN SWITZERLAND."

The 9mm Parabellum specimens have the barrel inscription in one line of text. The 7.65mm specimens have "MADE IN SWITZERLAND" on a second line below the Abercrombie name and city.

FRAME: The frame on this model should be the late, long type with a grip safety, wide trigger and narrow trigger guard.

RECEIVER: The receiver on this model should be the late, long type. The chamber should have the Swiss Cross in Sunburst inscription.

THUMB SAFETY: The thumb safety on this model should have a serrated safety lever. The lower position is polished (not blued). Safe is in the upper position.

SIGHTS: The front sight on this model should be a saw tooth shaped blade, dovetail fit on the barrel. The rear sight should be a fixed V notch in the rear toggle link.

EXTRACTOR: The extractor on this model should be the late type. It should be marked "GELADEN" on the left side.

GRIPS: The grips on this model should be checkered walnut. The left grip should be slotted for the grip safety.

MAGAZINE: The magazines original to this model should have a tin-plated, wrap-around body. It should have a wood base with a metal insert. They should not be proof marked or serial numbered.

FINISH: The main finish on this model should be a high-quality rust blue. The ejector, magazine catch/release, takedown lever, thumb safety lever and trigger should all be straw colored.

SERIAL NUMBER RANGE: four-digits, most with an "i" suffix.

SERIAL NUMBER LOCATION: The full serial number is found on the bottom of the barrel, on the front of the frame, and the left side of the receiver. The last two digits of the serial number are on the breechblock (lower left side), extractor (bottom), front toggle link (bottom), rear toggle link (back), side plate (bottom edge), takedown

lever (bottom), trigger (top left), grip safety (under grip) and grips (inside).

INTERESTING VARIATIONS

One example of a 1920-featured carbine marked with the Abercrombie & Fitch name is reported.

MARKINGS

MARK LOCATION/DESCRIPTION



Toggle
Manufacturer's Logo

VALUES

POOR	FAIR	GOOD	VG	EXC
\$2,000	\$3,200	\$5,000	\$8,000	\$10,000

Look-Up Index # 105

VICKERS DUTCH



BACKGROUND

The Vickers Dutch model was made specifically for military sales to the Netherlands. This model represents one of the more interesting Luger stories. These were actually manufactured in 1921 or 1922 in the 1906 style. The Dutch military knew and liked this configuration of Luger, but due to the Versailles Treaty, DWM could not legally produce or sell pistols with both this barrel length, and in this caliber. The result was a contact with Vickers to manufacture the Luger design licensed from DWM.

HOW TO TELL A VICKERS DUTCH

The Vickers Dutch can be distinguished from other Lugers by two features in combination.

1. The toggle is marked "VICKERS LTD."
2. The serial number is below 10182.

QUANTITY MADE

6,000.

RARITY RATING

4, Scarce.

FEATURES IN DEPTH

MANUFACTURER: This model was made by Vickers LTD., London.

TOGGLE: This model should have the new type toggle, with the flat, checkered toggle knobs.

TOGGLE MARK: VICKERS LTD

BARREL: This model should have a 4-inch (100mm) barrel. It should be chambered for 9mm Parabellum.

FRAME: The frame on this model should be the late, short type with a grip safety, wide trigger and narrow trigger guard. Most have a brass plate brazed to the left side of the frame that is unit marked.

RECEIVER: The receiver on this model should be the late, short type. The chamber should be blank.

THUMB SAFETY: The thumb safety on this model should have a serrated safety lever. It is marked "RUST" with a curved arrow pointing to the safe, upper position.

SIGHTS: The front sight on this model should be a dorsal fin shaped blade, dovetail fit on the barrel. The rear sight should be a fixed V notch in the rear toggle link.

EXTRACTOR: The extractor on this model should be the late type. It should be marked "GELADEN" on both sides.

GRIPS: The grips on this model should be checkered walnut. The checkering should be noticeably more coarse than normal. The left grip should be slotted for the grip safety.

MAGAZINE: The magazines original to this model should have a tin-plated, wrap-around body with a wood base. They should not be proof marked or serial numbered.

FINISH: The main finish on this model should be a high-quality rust blue. The ejector, magazine catch/release, takedown lever, thumb safety lever and trigger should all be straw colored. These are usually found in rough condition.

SERIAL NUMBER RANGE: 4182 to 10181.

SERIAL NUMBER LOCATION: The full serial number is found on the bottom of the barrel and on the front of the frame. The last two digits of the serial number are on the breechblock (lower left side), extractor (bottom), front toggle link (bottom), rear toggle link (back), receiver (rear), side plate (bottom edge), takedown lever (bottom), trigger (top left), grip safety (under grip) and grips (inside).

INTERESTING VARIATIONS

Some examples have been arsenal refinished. These will have a date on the barrel indicating when the refinishing occurred.

MARKINGS

MARK LOCATION/DESCRIPTION

VICKERS LTD. Toggle
Manufacturer's Logo



Receiver
Dutch Royal Proof

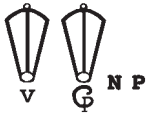

Receiver
British Vickers Proof

VALUES

POOR	FAIR	GOOD	VG	EXC
\$900	\$1,250	\$1,750	\$2,750	\$3,500

Look-Up Index # 106

VICKERS DUTCH COMMERCIAL

BACKGROUND

The 1906 Vickers Dutch Commercial model was an overrun of the Vickers Dutch (military) contract. Not a lot is known about this variation, which only recently came to light as a distinct model. The one known example is in a tailor-made Victors factory wood box.

HOW TO TELL A VICKERS DUTCH COMMERCIAL

The Vickers Dutch Commercial can be distinguished from other Lugers by two features in combination.

1. The toggle is marked "VICKERS LTD."
2. The serial number is above 10181.

QUANTITY MADE

Less than 100.

RARITY RATING

8, Extremely rare.

FEATURES IN DEPTH

MANUFACTURER: This model was made by Vickers LTD., London.

TOGGLE: This model should have the new type toggle, with the flat, checkered toggle knobs.

TOGGLE MARK: VICKERS LTD

BARREL: This model should have a 4-inch (100mm) barrel. It should be chambered for 9mm Parabellum.

FRAME: The frame on this model should be the late, short type with a grip safety, wide trigger and narrow trigger guard.

RECEIVER: The receiver on this model should be the late, short type. The chamber should be blank.

THUMB SAFETY: The thumb safety on this model should have a serrated safety lever. It is marked "SAFE" with a curved arrow pointing to the safe, upper position.

SIGHTS: The front sight on this model should be a dorsal fin shaped blade, dovetail fit on the barrel. The rear sight should be a fixed V notch in the rear toggle link.

EXTRACTOR: The extractor on this model should be the late type. It should be marked "GELADEN" on both sides.

GRIPS: The grips on this model should be checkered walnut. The checkering should be noticeably more coarse than normal. The left grip should be slotted for the grip safety.

MAGAZINE: The magazines original to this model should have a tin-plated, wrap-around body with a wood base. They should not be proof marked or serial numbered.

FINISH: The main finish on this model should be a high-quality rust blue. The ejector, magazine catch/release, takedown lever, thumb safety lever and trigger should all be straw colored. These are usually found in rough condition.

SERIAL NUMBER RANGE: 10182 to 10250. The highest serial number known is 10206.

SERIAL NUMBER LOCATION: The full serial number is found on the bottom of the barrel and on the front of the frame. The last two digits of the serial number are on the breechblock (lower left side), extractor (bottom), front toggle link (bottom), rear toggle link (back), receiver (rear), side plate (bottom edge), takedown lever (bottom), trigger (top left), grip safety (under grip) and grips (inside).

INTERESTING VARIATIONS

There are no notable variations of this model.

MARKINGS

MARK LOCATION/DESCRIPTION

VICKERS LTD. Toggle
Manufacturer's Logo

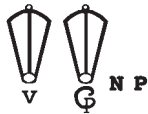

Receiver
British Vickers Proof

VALUES

POOR	FAIR	GOOD	VG	EXC
\$900	\$1,500	\$2,000	\$3,500	\$5,000

Look-Up Index # 107

1923 SAFE & LOADED



BACKGROUND

The 1923 Safe & Loaded model was made specifically for commercial within the US.

HOW TO TELL A 1923 SAFE & LOADED

The 1923 Safe & Loaded can be distinguished from other Lugers by three features in combination.

1. Late, flat, checkered style toggle knobs.
2. The chamber is blank.
3. The thumb safety is marked "SAFE."

QUANTITY MADE

Approximately 7,000.

RARITY RATING

4, Scarce.

FEATURES IN DEPTH

MANUFACTURER: This model was manufactured by DWM (Deutsche Waffen and Munitionsfabriken) of Berlin.

TOGGLE: This model should have the new type toggle, with the flat, checkered toggle knobs.

TOGGLE MARK: 

BARREL: This model should have an 3 5/8-inch barrel. It should be chambered for 7.65mm (.30 Luger). Custom order barrel lengths have been reported up to 24-inch chambered in 9mm Parabellum.

FRAME: The frame on this model should be the late, short type with a stock lug, wide trigger and narrow trigger guard.

RECEIVER: The receiver on this model should be the late, short type. The chamber should be blank.

THUMB SAFETY: The thumb safety on this model should have a serrated safety lever. The upper position is marked "SAFE." Safe is in the lower position.

SIGHTS: The front sight on this model should be a dorsal fin shaped blade, dovetail fit on the barrel. The rear sight should be a fixed V notch in the rear toggle link. Barrel lengths over 8" should have an artillery style adjustable rear sight, and may have saw tooth shaped blade front sights.

EXTRACTOR: The extractor on this model should be the late type. It should be marked "LOADED" on the left side.

GRIPS: The grips on this model should be checkered walnut.

MAGAZINE: The magazines original to this model should have a tin-plated, wrap-around body with either an aluminum or wood base. They should not be proof marked or serial numbered.

FINISH: The main finish on this model should be a high-quality rust blue. The ejector, magazine catch/release, takedown lever, thumb safety lever and trigger should all be straw colored.

SERIAL NUMBER RANGE: 72000 to 96000.

SERIAL NUMBER LOCATION: The full serial number is found on the bottom of the barrel and on the front of the frame. The last two digits of the serial number are on the breechblock (lower left side), extractor (bottom), front toggle link (bottom), rear toggle link (back), receiver (rear), side plate (bottom edge), takedown lever (bottom), trigger (top left), and grips (inside).

INTERESTING VARIATIONS

Aside from the long barrel length specimens, there are no notable variations of this model.

MARKINGS

MARK	LOCATION/DESCRIPTION
------	----------------------



Toggle
Manufacturer's Logo



Receiver
Nitro Commercial Proof

VALUES

POOR	FAIR	GOOD	VG	EXC
\$500	\$850	\$1,000	\$1,500	\$2,500

Look-Up Index # 108

1923 STOEGER AMERICAN EAGLE



BACKGROUND

The 1923 Stoeger American Eagle model was generally made for commercial sales in the United States. This model actually consists of several options all marketed through the US retail outlet A.F. Stoeger Inc.

These should not be confused with the later Mauser Stoeger model.

HOW TO TELL A 1923 STOEGER AMERICAN EAGLE

The 1923 Stoeger American Eagle can be distinguished from other Lugers by five features in combination.

1. Late, flat, checkered style toggle knobs.
2. Eagle inscription above the chamber.
3. Right side of receiver is inscribed "A.F. Stoeger Inc New York."
4. Crown over N commercial proof mark.
5. The thumb safety is marked "GESICHERT."

QUANTITY MADE

Less than 1,000 including the Stoeger Safe and Loaded model.

RARITY RATING

7, Very rare.

FEATURES IN DEPTH

MANUFACTURER: This model was manufactured by DWM (Deutsche Waffen and Munitionsfabriken) of Berlin.

TOGGLE: This model should have the new type toggle, with the flat, checkered toggle knobs.

TOGGLE MARK: 

BARREL: Nearly any barrel length is possible on this model (4-inch and 4¾-inch are the most common). It can be found chambered for either 7.65mm (.30 Luger) or 9mm Parabellum.

FRAME: The frame on this model should be the late, short type with a stock lug (also reported without), wide trigger and narrow trigger guard. Some are marked on the right frame rail to read "LUGER - REGISTERED U.S. PATENT OFFICE." Some say "ORIGINAL LUGER" or "GENUINE LUGER."



RECEIVER: The receiver on this model should be the late, short type. The chamber should be marked with an American Eagle inscription. A blank chamber is occasionally encountered. The right side is marked "A.F. STOEGER INC NEW YORK." Most are marked "GERMANY" on the left side to indicate importation to the US.

THUMB SAFETY: The thumb safety on this model should have a serrated safety lever. It is marked "GESICHERT" in the upper position. Safe is in the lower position.

SIGHTS: The front sight on this model should be a dorsal fin shaped blade, dovetail fit on the barrel. The rear sight should be a fixed V notch in the rear toggle link.

EXTRACTOR: The extractor on this model should be the late type. It should be marked "GELADEN" on the left side.

GRIPS: The grips on this model should be checkered walnut.

MAGAZINE: The magazines original to this model should have a tin-plated, wrap-around body with either an aluminum or wood base. They should not be proof marked or serial numbered.

FINISH: The main finish on this model should be a high-quality rust blue. The ejector, magazine catch/release, takedown lever, thumb safety lever and trigger should all be straw colored.

SERIAL NUMBER RANGE: 76500 to 89900 range, and in the n, p and q blocks.

SERIAL NUMBER LOCATION: The full serial number is found on the bottom of the barrel and on the front of the frame. The last two digits of the serial number are on the breechblock (lower left side), extractor (bottom), front toggle link (bottom), rear toggle link (back), receiver (rear), side plate (bottom edge), takedown lever (bottom), trigger (top left), and grips (inside).

INTERESTING VARIATIONS

There is a specimen in 7.65mm with a two-line Stoeger inscription, an American Eagle on the chamber, and a six-inch barrel with an artillery style rear sight. The safety is marked "GESICHERT." The extractor is marked "GELADEN" on the left and "LOADED" on the right. A curious if suspect specimen.

MARKINGS

MARK **LOCATION/DESCRIPTION**



Toggle
Manufacturer's Logo



Receiver
Nitro Commercial Proof

VALUES

POOR	FAIR	GOOD	VG	EXC
\$800	\$1,200	\$2,000	\$3,800	\$5,000

Look-Up Index # 109

1923 STOEGER SAFE & LOADED



BACKGROUND

The 1923 Stoeger Safe & Loaded model was generally made for commercial sales in the United States. This model actually consists of several options all marketed through the US retail outlet A.F. Stoeger Inc.

These should not be confused with the later Mauser Stoeger model.

HOW TO TELL A 1923 STOEGER SAFE & LOADED

The 1923 Stoeger Safe & Loaded can be distinguished from other Lugers by three features in combination.

1. Late, flat, checkered style toggle knobs.
2. Eagle inscription above the chamber.
3. Right side of receiver is inscribed "A.F. Stoeger Inc New York.."
4. Crown over N commercial proof mark.
5. The thumb safety is marked "SAFE."

QUANTITY MADE

Less than 1,000 including the Stoeger American Eagle model.

RARITY RATING

7, Very rare.

FEATURES IN DEPTH

MANUFACTURER: This model was manufactured by DWM (Deutsche Waffen and Munitionsfabriken) of Berlin.

TOGGLE: This model should have the new type toggle, with the flat, checkered toggle knobs.

TOGGLE MARK: 

BARREL: Nearly any barrel length is possible on this model (4-inch and 4¾-inch are the most common). It can be found chambered for either 7.65mm (.30 Luger) or 9mm Parabellum.

FRAME: The frame on this model should be the late, short type with a stock lug (also reported without), wide trigger and narrow trigger guard. Some are marked on the right frame rail to read "LUGER - REGISTERED U.S. PATENT OFFICE." Some say "ORIGINAL LUGER" or "GENUINE LUGER."

RECEIVER: The receiver on this model should be the late, short type. The chamber should be marked with an American Eagle inscription. A blank chamber is occasionally encountered. The right side is marked "A.F. STOEGER INC NEW YORK." Most are marked "GERMANY" on the left side to indicate importation to the US.

THUMB SAFETY: The thumb safety on this model should have a serrated safety lever. It is marked "SAFE" in the upper position. Safe is in the lower position.

SIGHTS: The front sight on this model should be a dorsal fin shaped blade, dovetail fit on the barrel. The rear sight should be a fixed V notch in the rear toggle link.

EXTRACTOR: The extractor on this model should be the late type. It should be marked "LOADED" on the left side. At least a couple specimens are documented to be marked "GELADEN" on the right side as well.

GRIPS: The grips on this model should be checkered walnut.

MAGAZINE: The magazines original to this model should have a tin-plated, wrap-around body with either

an aluminum or wood base. They should not be proof marked or serial numbered.

FINISH: The main finish on this model should be a high-quality rust blue. The ejector, magazine catch/release, takedown lever, thumb safety lever and trigger should all be straw colored.

SERIAL NUMBER RANGE: 76500 to 89900 range, and in the n, p and q blocks.

SERIAL NUMBER LOCATION: The full serial number is found on the bottom of the barrel and on the front of the frame. The last two digits of the serial number are on the breechblock (lower left side), extractor (bottom), front toggle link (bottom), rear toggle link (back), receiver (rear), side plate (bottom edge), takedown lever (bottom), trigger (top left), and grips (inside).

INTERESTING VARIATIONS

There is a specimen in 7.65mm with a two-line Stoeger inscription, an American Eagle on the chamber, and a 1six-inch barrel with an artillery style rear sight. The safety is marked "GESICHERT." The extractor is marked "GELADEN" on the left and "LOADED" on the right. A curious if suspect specimen.

MARKINGS

MARK **LOCATION/DESCRIPTION**



Toggle
Manufacturer's Logo



Receiver
Nitro Commercial Proof

VALUES

POOR	FAIR	GOOD	VG	EXC
\$800	\$1,200	\$2,000	\$3,800	\$5,000

Look-Up Index # 110

1923 DWM FINNISH MILITARY

BACKGROUND

The 1923 DWM Finnish Military model was made specifically for military contract sales to the Suomen Armeija (SA), meaning Finnish Army.

HOW TO TELL A 1923 DWM FINNISH MILITARY

The 1923 DWM Finnish Military can be distinguished from other Lugers by four features in combination.

1. Late, flat, checkered style toggle knobs.
2. The toggle is marked with the Scroll DWM logo.
3. SA in box acceptance mark.
4. Crown/N proof.

QUANTITY MADE

Approximately 6,500.

RARITY RATING

5, Somewhat rare.

FEATURES IN DEPTH

MANUFACTURER: This model was manufactured by DWM (Deutsche Waffen and Munitionsfabriken) of Berlin.

TOGGLE: This model should have the new type toggle, with the flat, checkered toggle knobs.

TOGGLE MARK: 

BARREL: This model should have a 3 7/8-inch (90mm) barrel. It should be chambered for 7.65mm (.30 Luger).

FRAME: The frame on this model should be the late, short type with a stock lug, wide trigger and narrow trigger guard.

RECEIVER: The receiver on this model should be the late, short type. The left side is marked "SA." The chamber should be blank.

THUMB SAFETY: The thumb safety on this model should have a serrated safety lever. The upper position is marked "GESICHERT." Safe is in the lower position.

SIGHTS: The front sight on this model should be a dorsal fin shaped blade, dovetail fit on the barrel. The rear sight should be a fixed V notch in the rear toggle link.

EXTRACTOR: The extractor on this model should be the late type. It should be marked "GELADEN" on the left side.

GRIPS: The grips on this model should be checkered walnut.

MAGAZINE: The magazines original to this model should have a tin-plated, wrap-around body with an aluminum base. They should not be proof marked or serial numbered.

FINISH: The main finish on this model should be a high-quality rust blue. The ejector, magazine catch/release, takedown lever, thumb safety lever and trigger should all be straw colored.

SERIAL NUMBER RANGE: Found in the k through r serial number suffix blocks. Most common in the q block.

SERIAL NUMBER LOCATION: The full serial number is found on the bottom of the barrel and on the front of the frame. The last two digits of the serial number are on the breechblock (lower left side), extractor (bottom), front toggle link (bottom), rear toggle link (back), receiver (rear), side plate (bottom edge), takedown lever (bottom), trigger (top left), and grips (inside).

INTERESTING VARIATIONS

There are no notable variations of this model.

MARKINGS

MARK	LOCATION/DESCRIPTION
	Toggle Manufacturer's Logo
	Receiver Nitro Commercial Proof
	Receiver Finnish Army (Suomen Armeija) Acceptance Mark

VALUES

POOR	FAIR	GOOD	VG	EXC
\$500	\$900	\$1,000	\$1,800	\$3,500

Look-Up Index # 111

1923 DWM SWEDISH MILITARY

BACKGROUND

The 1923 DWM Swedish Military model was made specifically for military contract sales to the Swedish military.

HOW TO TELL A 1923 DWM SWEDISH MILITARY

The 1923 DWM Swedish Military can be distinguished from other Lugers by three features in combination.

1. Late, flat, checkered style toggle knobs.
2. The toggle is marked with the Scroll DWM logo.
3. 3 crowns in an inverted triangle on the left side of the frame.

QUANTITY MADE

Uncertain, but probably around 1,000.

RARITY RATING

7, Very rare.

FEATURES IN DEPTH

MANUFACTURER: This model was manufactured by DWM (Deutsche Waffen and Munitionsfabriken) of Berlin.

TOGGLE: This model should have the new type toggle, with the flat, checkered toggle knobs.

TOGGLE MARK: 

BARREL: This model should have a 3 7/8-inch (90mm) barrel. It should be chambered for 7.65mm (.30 Luger).

FRAME: The frame on this model should be the late, short type with a stock lug, wide trigger and narrow trigger guard.

RECEIVER: The receiver on this model should be the late, short type. The chamber should be blank. The left side is marked with three crowns stacked in an inverted pyramid.

THUMB SAFETY: The thumb safety on this model should have a serrated safety lever. The upper position is marked "GESICHERT." Safe is in the lower position.

SIGHTS: The front sight on this model should be a dorsal fin shaped blade, dovetail fit on the barrel. The rear sight should be a fixed V notch in the rear toggle link.

EXTRACTOR: The extractor on this model should be the late type. It should be marked "GELADEN" on both sides.

GRIPS: The grips on this model should be checkered walnut.

MAGAZINE: The magazines original to this model should have a tin-plated, wrap-around body with a wood base. They should not be proof marked or serial numbered.

FINISH: The main finish on this model should be a high-quality rust blue. The ejector, magazine catch/release, takedown lever, thumb safety lever and trigger should all be straw colored.

SERIAL NUMBER RANGE: Found in the k through r blocks.

SERIAL NUMBER LOCATION: The full serial number is found on the bottom of the barrel and on the front of the frame. The last two digits of the serial number are on the breechblock (lower left side), extractor (bottom), front toggle link (bottom), rear toggle link (back), receiver (rear), side plate (bottom edge), takedown lever (bottom), trigger (top left), and grips (inside).

INTERESTING VARIATIONS

There are no notable variations of this model.

MARKINGS

MARK **LOCATION/DESCRIPTION**



Toggle
Manufacturer's Logo



Receiver
Nitro Commercial Proof

VALUES

POOR	FAIR	GOOD	VG	EXC
\$500	\$900	\$1,000	\$1,800	\$3,500

Look-Up Index # 112

1925/1926 BABY LUGER

BACKGROUND

The 1925 Baby Luger model was a prototype run of a down-sized Luger to address the pocket pistol market.

HOW TO TELL A 1925 BABY LUGER

The 1925 Baby Luger can be distinguished from other Lugers by one distinct feature.

1. The thumb safety is not a lever, but instead is a sliding button in the center top of the left grip.

QUANTITY MADE

Four total, two in .32 ACP, two in .380 ACP.

RARITY RATING

9, Nearly unique.

FEATURES IN DEPTH

MANUFACTURER: This model was manufactured by DWM (Deutsche Waffen and Munitionsfabriken) of Berlin.

TOGGLE: This model should have the new type toggle, with the flat, checkered toggle knobs. The width across the toggle knobs is more narrow than normal.

TOGGLE MARK: The toggle is blank.

BARREL: This model should have a 2 15/16-inch (76mm) barrel. It should be chambered for 7.65mm Browning (.32 ACP) or 9mm Kurtz (.380 ACP).

FRAME: The frame on this model should be a unique, extremely short prototype with a wide trigger and narrow trigger guard.

RECEIVER: The receiver on this model should be a unique, extremely short prototype. The chamber should be blank.

THUMB SAFETY: The thumb safety on this model is a unique, serrated sliding lever. It is unmarked. Safe is in the upper position.

SIGHTS: The front sight on this model should be a dorsal fin shaped blade, dovetail fit on the barrel. The rear sight should be a fixed V notch in the rear toggle link.

EXTRACTOR: The extractor on this model should be the late type. It should be unmarked.

GRIPS: The grips on this model should be checker walnut. They should be shortened to fit the smaller frame, and notched to accommodate the sliding thumb safety.

MAGAZINE: The magazines original to this model should have a tin-plated, wrap-around body shortened to accommodate the smaller frame. It should have a wood base. It should not be proof marked or serial numbered.

FINISH: The main finish on this model should be a high-quality rust blue. The ejector, magazine catch/release, takedown lever, thumb safety button, and trigger should all be straw colored.

SERIAL NUMBER RANGE: 1 to 4.

SERIAL NUMBER LOCATION: Full number on the front of the frame.

INTERESTING VARIATIONS

There are no notable variations of this model.

MARKINGS

MARK **LOCATION/DESCRIPTION**

None.

VALUES

This model is too rare to price.

Look-Up Index # 113

SIMSON GRIP SAFETY

BACKGROUND

The Simson grip safety model was generally made for commercial sales both in Germany and abroad. These were built on 1914 military model frames adapted to accept the grip safety.

HOW TO TELL A SIMSON GRIP SAFETY

The Simson grip safety can be distinguished from other Lugers by two features in combination.

1. The toggle is inscribed "SIMSON & CO SUHL."
2. It has a grip safety.

QUANTITY MADE

Very few.

RARITY RATING

7-8, Very rare to extremely rare.

FEATURES IN DEPTH

MANUFACTURER: This model was made by Simson & Co., Suhl.

TOGGLE: This model should have the new type toggle, with the flat, checkered toggle knobs.

TOGGLE MARK: SIMSON & Co. SUHL

BARREL: This model should have a 4-inch (100mm) barrel. It should be chambered for 9mm Parabellum.

FRAME: The frame on this model should be the late, short type with a grip safety, stock lug, wide trigger and narrow trigger guard.

RECEIVER: The receiver on this model should be the late, short type. The chamber should be blank.

THUMB SAFETY: The thumb safety on this model should have a serrated safety lever. The original safety markings are removed. Both positions should be blued. Safe is in the upper position.

SIGHTS: The front sight on this model should be a dorsal fin shaped blade, dovetail fit on the barrel. The rear sight should be a fixed V notch in the rear toggle link.

EXTRACTOR: The extractor on this model should be the late type. It should be marked "GELADEN" on the left side.

GRIPS: The grips on this model should be checkered walnut. The left grip should be slotted for the grip safety.

MAGAZINE: The magazines original to this model should have a tin-plated, wrap-around body with either

an aluminum or wood base. They should be proof marked and serial numbered to the pistol.

FINISH: The main finish on this model should be a high-quality rust blue. The ejector, magazine catch/release, takedown lever, thumb safety lever and trigger should all be straw colored.

SERIAL NUMBER RANGE: 1 to 10000 in commercial style.

SERIAL NUMBER LOCATION: The full serial number is found on the bottom of the barrel, the front of the frame, and the left side of the receiver. The last two digits of the serial number are on the breechblock (lower left side), extractor, front toggle link (bottom), rear toggle link (back), sear (left side), sear bar safety lever, side plate (bottom edge), takedown lever (bottom), thumb safety lever (top), trigger (top left), grip safety (under grip) and grips (inside).

INTERESTING VARIATIONS

There are no notable variations of this model.

MARKINGS

MARK	LOCATION/DESCRIPTION
------	----------------------



Receiver
Simson Acceptance Marks

Other numbers and eagle variations include these



Parts
Simson Inspection Mark



Receiver and Barrel
Simson Test Fire Proof

VALUES

POOR	FAIR	GOOD	VG	EXC
\$700	\$1,000	\$2,000	\$2,500	\$3,250

Look-Up Index # 114

SIMSON DATED

BACKGROUND

The Simson Dated model was made specifically for military sales to the German Reichswehr. It is believed that these were made as replacements of worn out P.08s from the double date, military and police and the initial Simson & Co. models.

HOW TO TELL A SIMSON DATED

The Simson Dated can be distinguished from other Lugers by two features in combination.

1. The toggle is inscribed "SIMSON & Co. SUHL."
2. A four-digit year date inscription above the chamber, from 1925 to 1928.

QUANTITY MADE

No more than 1,000.

Serial numbers observed seem to indicate the following breakdown:

- 500 dated 1925.
- 100 dated 1926.
- 100 dated 1927.
- 100 dated 1928.

RARITY RATING

6, Rare.

FEATURES IN DEPTH

MANUFACTURER: This model was made by Simson & Co., Suhl.

TOGGLE: This model should have the new type toggle, with the flat, checkered toggle knobs.

TOGGLE MARK: SIMSON & Co. SUHL

BARREL: This model should have a 4-inch (100mm) barrel. It should be chambered for 9mm Parabellum.

FRAME: The frame on this model should be the late, short type with a stock lug, wide trigger and narrow trigger guard.

RECEIVER: The receiver on this model should be the late, short type. The chamber should be marked with a four-digit year date from 1925 to 1928.

THUMB SAFETY: The thumb safety on this model should have a serrated safety lever. The upper position is marked "GESICHERT." Safe is in the lower position.

SIGHTS: The front sight on this model should be a dorsal fin shaped blade, dovetail fit on the barrel. The rear sight should be a fixed V notch in the rear toggle link.

EXTRACTOR: The extractor on this model should be the late type. It should be marked "GELADEN" on the left side.

GRIPS: The grips on this model should be checkered walnut.

MAGAZINE: The magazines original to this model should have a tin-plated, wrap-around body with an aluminum base. They should be proof marked and serial numbered to the pistol.

FINISH: The main finish on this model should be a high-quality rust blue. The ejector, magazine catch/release, takedown lever, thumb safety lever and trigger should all be straw colored.

SERIAL NUMBER RANGE: 1 to 1000 range. It appears that this is a duplicate serial number block from the initial batch of Simson & Co. model pistols.

SERIAL NUMBER LOCATION: The full serial number is found on the bottom of the barrel, the front of the frame, and the left side of the receiver. The last two digits of the serial number are on the breechblock (lower left side), extractor, front toggle link (bottom), rear toggle link (back), sear (left side), sear bar safety lever, side plate, takedown lever (bottom), thumb safety lever (top), trigger (top left), and grips (inside).

INTERESTING VARIATIONS

There are no notable variations of this model.

MARKINGS

MARK	LOCATION/DESCRIPTION
------	----------------------



Receiver
Simson Acceptance Marks

Other numbers and eagle variations include these



Parts
Simson Inspection Mark



Receiver and Barrel
Simson Test Fire Proof

VALUES

POOR	FAIR	GOOD	VG	EXC
\$700	\$1,000	\$2,000	\$2,500	\$3,250

Look-Up Index # 115

1928 DUTCH EAST INDIES

BACKGROUND

The 1928 Dutch East Indies model was made specifically for military contract sales to the Dutch. Ordered in 1928, this 1906 pattern Luger model was one of the last produced by DWM. The first (largest) portion of the contract was filled by DWM-produced pistols. The small balance of the contract was eventually filled by pistols produced by Mauser (SEE THE SUBSEQUENT MODEL DESCRIPTION), which had purchased DWM in 1930. Contrary to earlier belief, this model was not for the Dutch Air Force use. The current theory is that the KOL proof stands Department of Colonies.

HOW TO TELL A DUTCH EAST INDIES

The 1928 Dutch East Indies can be distinguished from other Lugers by six features in combination.

1. The toggle is marked with the scroll DWM logo.
2. 4-inch barrel length.
3. Has a grip safety.
4. RUST marked thumb safety.
5. KOL proof.
6. Serial number in the 10100 to 14001 range.

QUANTITY MADE

3,820.

RARITY RATING

5, Somewhat rare.

FEATURES IN DEPTH

MANUFACTURER: This model was manufactured by DWM (Deutsche Waffen and Munitionsfabriken) of Berlin.

TOGGLE: This model should have the new type toggle, with the flat, checkered toggle knobs.

TOGGLE MARK: 

BARREL: This model should have a 4-inch (100mm) barrel. It should be chambered for 9mm Parabellum.

FRAME: The frame on this model should be the late, short type with a grip safety, wide trigger and narrow trigger guard.

RECEIVER: The receiver on this model should be the late, short type. The chamber should be blank.

THUMB SAFETY: The thumb safety on this model should have a serrated safety lever. It is marked "RUST" with a curved arrow pointing to the safe, upper position.

SIGHTS: The front sight on this model should be a dorsal fin shaped blade, dovetail fit on the barrel. The rear sight should be a fixed V notch in the rear toggle link.

EXTRACTOR: The extractor on this model should be the late type. It should be marked "GELADEN" on both sides.

GRIPS: The grips on this model should be checkered walnut. The left grip should be slotted for the grip safety.

MAGAZINE: The magazines original to this model should have a tin-plated, wrap-around body with a wood base. They should not be proof marked or serial numbered.

FINISH: The main finish on this model should be a high-quality rust blue. The ejector, magazine catch/release, takedown lever, thumb safety lever and trigger should all be straw colored.

SERIAL NUMBER RANGE: 10100 to 14001.

SERIAL NUMBER LOCATION: The full serial number is found on the bottom of the barrel and on the front of the frame. The last two digits of the serial number are on the breechblock (lower left side), extractor (bottom), front toggle link (bottom), rear toggle link (back), receiver (left side), side plate (bottom edge), takedown lever (bottom), trigger (top left), grip safety (under grip) and grips (inside).

INTERESTING VARIATIONS

There is a sole specimen of this model with the no front sight, the front sight ring ground off, and a brass plate soldered to the front toggle link stamped "STARTPISTOOL."

There are a small number (thought to be less than 100) of this exact configuration and marking pattern, which fall in a much earlier serial number block. Nothing conclusive about this serial number anomaly is known.

MARKINGS

MARK	LOCATION/DESCRIPTION
	Toggle Manufacturer's Logo
	Receiver Nitro Commercial Proof
	Receiver Dutch Colonial Proof

VALUES

POOR	FAIR	GOOD	VG	EXC
\$500	\$900	\$1,000	\$1,800	\$3,500

Look-Up Index # 116

1928 DUTCH NAVY, DWM

BACKGROUND

The 1928 Dutch Navy, DWM model was made specifically for military sales to the Dutch Navy. Even though the Dutch Army and the Dutch Naval Air Service had officially adopted the Luger, it was not until 1928 that the rank and file Dutch Navy did so.

Although it kept the same nomenclature as the earlier 1918 Dutch Navy model (i.e., Automatic Pistol No. 1), these 1928 ordered pistols were a standard 1914 pattern, commercial proofed Luger with Dutch safety markings. Until recently these were sometime incorrectly called a Dutch Commercial model.

HOW TO TELL A 1928 DUTCH NAVY, DWM

The 1928 Dutch Navy, DWM can be distinguished from other Lugers by four features in combination.

1. The toggle is marked with the scrolled DWM logo.
2. No grip safety.
3. The thumb safety is marked "RUST" with a downward pointing arrow.
4. Commercial Crown/N proofs.

QUANTITY MADE

1,484.

RARITY RATING

7, Very rare.

FEATURES IN DEPTH

MANUFACTURER: This model was manufactured by DWM (Deutsche Waffen and Munitionsfabriken) of Berlin.

TOGGLE: This model should have the new type toggle, with the flat, checkered toggle knobs and a toggle lock.

TOGGLE MARK: 

BARREL: This model should have a 4-inch (100mm) barrel. It should be chambered for 9mm Parabellum.

FRAME: The frame on this model should be the late, short type with a stock lug, wide trigger and narrow trigger guard.

RECEIVER: The receiver on this model should be the late, short type. The chamber should be blank.

THUMB SAFETY: The thumb safety on this model should have a serrated safety lever. It is marked "RUST" with a curved arrow pointing to the safe, lower position.

SIGHTS: The front sight on this model should be a dorsal fin shaped blade, dovetail fit on the barrel. The rear sight should be a fixed V notch in the rear toggle link.

EXTRACTOR: The extractor on this model should be the late type. It should be marked "GELADEN" on both sides.

GRIPS: The grips on this model should be checkered walnut.

MAGAZINE: The magazines original to this model should have a tin-plated, wrap-around body with a wood base. They should not be proof marked or serial numbered.

FINISH: The main finish on this model should be a high-quality rust blue. The ejector, magazine catch/release, takedown lever, thumb safety lever and trigger should all be straw colored.

SERIAL NUMBER RANGE: 1 to 1484.

SERIAL NUMBER LOCATION: The full serial number is found on the bottom of the barrel and on the front of the frame. The last two digits of the serial number are on the breechblock (lower left side), extractor (bottom), front toggle link (bottom), rear toggle link (back), receiver (left side), side plate (bottom edge), takedown lever (bottom), trigger (top left), and grips (inside).

INTERESTING VARIATIONS

There are no notable variations of this model.

MARKINGS

MARK	LOCATION/DESCRIPTION
------	----------------------



Toggle
Manufacturer's Logo



Receiver
Nitro Commercial Proof

VALUES

POOR	FAIR	GOOD	VG	EXC
\$850	\$1,200	\$1,500	\$2,500	\$3,250

Look-Up Index # 117

SWISS BERN, 1906 PATTERN



BACKGROUND

The Swiss Bern, 1906 Pattern model was made specifically for Swiss military and police sales. Some collectors refer to this model as the 1924 Swiss, although actual production most likely predates that by at least a couple years. It was the first Luger not made in Germany.

HOW TO TELL A SWISS BERN, 1906 PATTERN

The Swiss Bern, 1906 Pattern can be distinguished from other Lugers by two features in combination.

1. The toggle is marked WAFFENFABRIK BERN.
2. No serial stamped on the left side of the receiver.

QUANTITY MADE

Exactly 17,874.

RARITY RATING

3-4, Uncommon to scarce.

FEATURES IN DEPTH

MANUFACTURER: This model was made the Swiss arsenal Waffenfabrik Bern.



TOGGLE: This model should have the new type toggle, with the flat, checkered toggle knobs.

TOGGLE MARK: 
WAFFENFABRIK
BERN

BARREL: This model should have a 4¾-inch (120mm) barrel. It should be chambered for 7.64 mm (.30 Luger).

FRAME: The frame on this model should be the late, long type with a grip safety, wide trigger and narrow trigger guard.

RECEIVER: The receiver on this model should be the late, long type. The chamber should be blank.

THUMB SAFETY: The thumb safety on this model should have a serrated safety lever. The lower position is polished (not blued). Safe is in the upper position.

SIGHTS: The front sight on this model should be a saw tooth shaped blade, dovetail fit on the barrel. The rear sight should be a fixed V notch in the rear toggle link.

EXTRACTOR: The extractor on this model should be the late type. It should be marked "GELADEN" on the left side.

GRIPS: The grips on this model should be checkered walnut with a smooth border. The left grip should be slotted for the grip safety.

MAGAZINE: The magazines original to this model should have a nickel-plated, wrap-around body with a wood base. They should not be serial numbered or proof marked.

FINISH: The main finish on this model should be a high-quality rust blue. The ejector, magazine catch/release, takedown lever, thumb safety lever and trigger should all be straw colored.





SERIAL NUMBER RANGE: 15216 to 33089.

SERIAL NUMBER LOCATION: The full serial number is found on the bottom of the barrel and on the front of the frame. The last two digits of the serial number are on the breechblock (lower left side), extractor (bottom), front toggle link (bottom), rear toggle link (back), receiver (rear), side plate (bottom edge), takedown lever (bottom), trigger (top left), grip safety (under grip) and grips (inside).

INTERESTING VARIATIONS

There are no notable variations of this model.

MARKINGS

MARK	LOCATION/DESCRIPTION
	Receiver Swiss Bernerprobe Proof
	Barrel & Receiver Swiss Rework Proof
	Receiver Rework Proof for Swiss Inspectors Herr Vogelsang or
	Herr Nievergelt or
	Colonel Muhlemann

VALUES

POOR	FAIR	GOOD	VG	EXC
\$1,000	\$2,000	\$2,500	\$3,500	\$5,000

Look-Up Index # 118

1906/29 SWISS SPECIAL ASSEMBLY

BACKGROUND

The 1906/29 Swiss Special Assembly model was made specifically for award and trophy presentation at Swiss military shooting matches. It's serial numbering was in immediate sequence following the 1906 Swiss Bern models.

HOW TO TELL A 1906/29 SWISS SPECIAL ASSEMBLY

The 1906/29 Swiss Special Assembly can be distinguished from other Lugers by two features in combination.

1. The toggle is marked WAFFENFABRIK BERN
2. The serial number is stamped on the left side of the receiver.

Many detailed features of this model are noticeably different from any German made Luger.

QUANTITY MADE

At least 4.

RARITY RATING

9, Near unique.

FEATURES IN DEPTH

MANUFACTURER: This model was made the Swiss arsenal Waffenfabrik Bern.

TOGGLE: This model should have the new type toggle, with the flat UNCHECKERED toggle knobs.

BARREL: This model should have a 4¾-inch (120mm) barrel. It should be chambered for 7.64 mm (.30 Luger).

FRAME: The frame on this model should be the late, long type with a grip safety, wide trigger and narrow trigger guard.

RECEIVER: The receiver on this model should be the late, long type. The chamber should be blank. There is a distinctive step above the chamber just back of the barrel.

THUMB SAFETY: The thumb safety on this model should have a serrated safety lever. The lower position is polished (not blued). Safe is in the upper position.

SIGHTS: The front sight on this model should be a saw tooth shaped blade, dovetail fit on the barrel. The rear sight should be a fixed V notch in the rear toggle link.

EXTRACTOR: The extractor on this model should be the late type. It should be marked "GELADEN" on the left side.

GRIPS: The grips on this model should be checkered walnut with a smooth border. The left grip should be slotted for the grip safety.

MAGAZINE: The magazines original to this model should have a tin-plated, wrap-around body with a black plastic base. They should not be serial numbered or proof marked.

FINISH: The finish on this model should be a high-quality rust blue. This includes the small parts. No straw finishing was used on this model.

SERIAL NUMBER RANGE:

P33090 to P33099 range.

P33090 and P33093 are known.

SERIAL NUMBER LOCATION: Full number found on the bottom of the barrel, the left side of the forward frame and the rear toggle link. The last two digits of the serial number are on the breechblock (lower left side), extractor (bottom), front toggle link (bottom), receiver (rear), side plate (bottom edge), takedown lever (bottom), trigger (top left), and grip safety (under grip) and grips (inside).

INTERESTING VARIATIONS

There are no notable variations of this model.

MARKINGS

MARK	LOCATION/DESCRIPTION
	Toggle Manufacturer's Logo
	Receiver Nitro Commercial Proof
	Receiver Swiss Bernerprobe Proof

VALUES

This model is too rare to price.

Look-Up Index # 119

1929 SWISS COMMERCIAL



BACKGROUND

The 1929 Swiss Commercial model was made by the Swiss firm Waffenfabrik Bern specifically for commercial sales in Switzerland. This model is also referred to as the Model 1906/29 Swiss Commercial due to the 1906 pattern features.

HOW TO TELL A 1929 SWISS COMMERCIAL

The 1929 Swiss Commercial can be distinguished from other Lugers by two features in combination.

1. The front strap of the grip is straight, lacking the distinctive Luger curve at the toe of the pistol's butt.
2. Serial number with a capital letter P prefix.

Most detailed features of this model are noticeably different from any German made Luger.

QUANTITY MADE

Exactly 1,917.

RARITY RATING

6, Rare.

FEATURES IN DEPTH

MANUFACTURER: This model was made the Swiss arsenal Waffenfabrik Bern.

TOGGLE: This model should have the new type toggle, with the flat UNCHECKERED toggle knobs.

TOGGLE MARK: 

BARREL: This model should have a 4¾-inch (120mm) barrel. It should be chambered for 7.64 mm (.30 Luger).

FRAME: The frame on this model should be the late, long type with a grip safety, wide trigger, narrow trigger guard and a straight grip front strap.

RECEIVER: The receiver on this model should be the late, long type with a distinctive step where the barrel

and chamber come together. The chamber should be blank.

THUMB SAFETY: The thumb safety on this model should have a round button on the end. The upper position should be marked "S." Safe is in the upper position.

SIGHTS: The front sight on this model should be a saw tooth shaped blade, dovetail fit on the barrel. The rear sight should be a fixed V notch in the rear toggle link.

EXTRACTOR: The extractor on this model should be the late type. It should be marked "GELADEN" on the left side.

GRIPS: The grips on this model should be molded checkered plastic. The color runs from black to brown to a red-orange. The left grip should be slotted for the grip safety.

MAGAZINE: The magazines original to this model should have a tin-plated, wrap-around body with a black plastic base. They should not be proof marked or serial numbered.

FINISH: The finish on this model should be a high-quality rust blue. This include the small parts. No straw finishing was used on this model.

SERIAL NUMBER RANGE:

P25001 to P26600 in 1940-43.

P77942 to P78258 in 1947.

SERIAL NUMBER LOCATION: The full serial number is found on the bottom of the barrel, the left side of the forward frame and the rear toggle link. The last two digits of the serial number are on the breechblock (lower left side), extractor (bottom), front toggle link (bottom), receiver (rear), side plate (bottom edge), takedown lever (bottom), trigger (top left), and grip safety (under grip).

INTERESTING VARIATIONS

There are no notable variations of this model.

MARKINGS

MARK	LOCATION/DESCRIPTION
------	----------------------



Toggle
Manufacturer's Logo



Receiver
Nitro Commercial Proof



Receiver
Swiss Bernerprobe Proof

VALUES

POOR	FAIR	GOOD	VG	EXC
\$1,000	\$1,250	\$1,750	\$2,000	\$3,000

Look-Up Index # 120

1929 SWISS MILITARY



BACKGROUND

The 1929 Swiss Military model was made by the Swiss firm Waffenfabrik Bern specifically for military use in Switzerland. This model, also called the Model 1906/29 Swiss (due to the 1906 pattern features), was made from 1930 to 1947.

HOW TO TELL A 1929 SWISS MILITARY

The 1929 Swiss Military can be distinguished from other Lugers by two features in combination.

1. The front strap of the grip is straight, lacking the distinctive Luger curve at the toe of the pistol's butt.
2. Serial number with NO letter prefix.

Most detailed features of this model are noticeably different from any German made Luger.

QUANTITY MADE

Exactly 27,940.

RARITY RATING

3, Uncommon.

FEATURES IN DEPTH

MANUFACTURER: This model was made the Swiss arsenal Waffenfabrik Bern.

TOGGLE: This model should have the new type toggle, with the flat UNCHECKERED toggle knobs.

TOGGLE MARK: 

BARREL: This model should have a 4¾-inch (120mm) barrel. It should be chambered for 7.64 mm (.30 Luger).

FRAME: The frame on this model should be the late, long type with a grip safety, wide trigger, narrow trigger guard and a straight grip front strap.

RECEIVER: The receiver on this model should be the late, long type with a distinctive step where the barrel and chamber come together. The chamber should be blank.

THUMB SAFETY: The thumb safety on this model should have a round button on the end. The upper position should be marked "S." Safe in the upper position.

SIGHTS: The front sight on this model should be a saw tooth shaped blade, dovetail fit on the barrel. The rear sight should be a fixed V notch in the rear toggle link.

EXTRACTOR: The extractor on this model should be the late type. It should be marked "GELADEN" on the left side.

GRIPS: The grips on this model should be molded checkered plastic. The color runs from black to brown to a red-orange. The left grip should be slotted for the grip safety.

MAGAZINE: The magazines original to this model should have a tin-plated, wrap-around body with a black plastic base. They should not be proof marked or serial numbered.

FINISH: The finish on this model should be a high-quality rust blue. This include the small parts. No straw finishing was used on this model.

SERIAL NUMBER RANGE: 50001 to 77941.

SERIAL NUMBER LOCATION: The full serial number is found on the bottom of the barrel, the left side of the forward frame and the rear toggle link. The last two digits of the serial number are on the breechblock (lower left side), extractor (bottom), front toggle link (bottom), receiver (rear), side plate (bottom edge), takedown lever (bottom), trigger (top left), and grip safety (under grip).

INTERESTING VARIATIONS

Following the (assumed) successful tests performed on the 1929 Swiss 9mm Prototype, approximately 200 of this model were Swiss arsenal rebarreled to 9mm Parabellum (barrels will be proofed but not serial numbered).

MARKINGS

MARK	LOCATION/DESCRIPTION
------	----------------------



Toggle
Manufacturer's Logo



Receiver
Nitro Commercial Proof



Receiver
Swiss Bernerprobe Proof

VALUES

POOR	FAIR	GOOD	VG	EXC
\$1,000	\$1,250	\$1,750	\$2,000	\$3,000

Look-Up Index # 121

1929 SWISS 9mm PROTOTYPE

BACKGROUND

The 1929 Swiss 9mm Prototype model was made specifically for testing of the 9mm Parabellum round by the Swiss.

HOW TO TELL A 1929 SWISS 9mm PROTOTYPE

The 1929 Swiss 9mm Prototype can be distinguished from other Lugers by two features in combination.

1. The front strap of the grip is straight, lacking the distinctive Luger curve at the toe of the pistol's butt.
2. No serial number at all.

Most detailed features of this model are noticeably different from any German made Luger.

QUANTITY MADE

Estimated at fewer than 10.

RARITY RATING

9, Nearly unique.

FEATURES IN DEPTH

MANUFACTURER: This model was made the Swiss arsenal Waffenfabrik Bern.

TOGGLE: This model should have the new type toggle, with the flat UNCHECKERED toggle knobs.

TOGGLE MARK: 

BARREL: This model should have a 4¾-inch (120mm) barrel. It should be chambered for 7.64 mm (.30 Luger).

FRAME: The frame on this model should be the late, long type with a grip safety, wide trigger, narrow trigger guard and a straight grip front strap.

RECEIVER: The receiver on this model should be the late, long type with a distinctive step where the barrel and chamber come together. The chamber should be blank.

THUMB SAFETY: The thumb safety on this model should have a round button on the end. The upper position should be marked "S." Safe is in the upper position.

SIGHTS: The front sight on this model should be a saw tooth shaped blade, dovetail fit on the barrel. The rear sight should be a fixed V notch in the rear toggle link.

EXTRACTOR: The extractor on this model should be the late type. It should be marked "GELADEN" on the left side.

GRIPS: The grips on this model should be molded checkered plastic. The color runs from black to brown to a red-orange. The left grip should be slotted for the grip safety.

MAGAZINE: The magazines original to this model should have a tin-plated, wrap-around body with a black plastic base. They should not be proof marked or serial numbered.

FINISH: The finish on this model should be a high-quality rust blue. This includes the small parts. No straw finishing was used on this model.

SERIAL NUMBER RANGE: The sole known example of this prototype is not serial numbered.

SERIAL NUMBER LOCATION: The sole known example of this prototype is not serial numbered.

INTERESTING VARIATIONS

There are no notable variations of this model.

MARKINGS

MARK	LOCATION/DESCRIPTION
------	----------------------



Toggle
Manufacturer's Logo



Receiver
Nitro Commercial Proof



Receiver
Swiss Bernerprobe Proof

VALUES

This model is too rare to price.

Look-Up Index # 122

1930 DUTCH NAVY, DWM/MAUSER

BACKGROUND

The 1930 Dutch Navy, DWM/Mauser was the Mauser assembled completion of the 1928 Dutch Navy contract. These were made specifically for military sales to the Dutch Navy.

HOW TO TELL A 1930 DUTCH NAVY, DWM/MAUSER

The 1930 Dutch Navy, DWM/Mauser can be distinguished from other Lugers by four features in combination.

1. The toggle is marked with the scrolled DWM logo.
2. 4-inch barrel length.

3. The thumb safety is marked "RUST" with a downward pointing arrow.
4. Commercial Crown/U proofs.

QUANTITY MADE

645.

RARITY RATING

7, Very rare.

FEATURES IN DEPTH

MANUFACTURER/REWORKER: This model was manufactured by Mauser Werke, Oberndorf.

TOGGLE: This model should have the new type toggle, with the flat, checkered toggle knobs.

TOGGLE MARK: 

BARREL: This model should have a 4-inch (100mm) barrel. It should be chambered for 9mm Parabellum.

FRAME: The frame on this model should be the late, short type with a stock lug, wide trigger and narrow trigger guard.

RECEIVER: The receiver on this model should be the late, short type. The chamber should be blank.

THUMB SAFETY: The thumb safety on this model should have a serrated safety lever. It is marked "RUST" with a curved arrow pointing to the safe, lower position.

SIGHTS: The front sight on this model should be a dorsal fin shaped blade, dovetail fit on the barrel. The rear sight should be a fixed V notch in the rear toggle link.

EXTRACTOR: The extractor on this model should be the late type. It should be marked "GELADEN" on both sides.

GRIPS: The grips on this model should be checkered walnut.

MAGAZINE: The magazines original to this model should have a tin-plated, wrap-around body with a wood base. They should not be proof marked or serial numbered.

FINISH: The main finish on this model should be a high-quality rust blue. The ejector, magazine catch/release, takedown lever, thumb safety lever and trigger should all be straw colored.

SERIAL NUMBER RANGE: 1485 to 2129.

SERIAL NUMBER LOCATION: The full serial number is found on the bottom of the barrel and on the front of the frame. The last two digits of the serial number are on the breechblock (lower left side), extractor (bottom), front toggle link (bottom), rear toggle link (back), receiver (left side), side plate (bottom edge), takedown lever (bottom), trigger (top left), and grips (inside).

INTERESTING VARIATIONS

There are no notable variations of this model.

MARKINGS

MARK **LOCATION/DESCRIPTION**



Toggle
Manufacturer's Logo



Receiver
Mauser Commercial Proof

VALUES

	POOR EXC	FAIR	GOOD	
VG	\$850	\$1,200	\$1,500	\$2,500
				\$3,250

Look-Up Index # 123

DWM MAUSER MILITARY

BACKGROUND

The DWM Mauser Military model was assembled by Mauser from mostly existing parts, for the German Reichswehr. This model represents Mauser's first German military Luger contract.

HOW TO TELL A DWM MAUSER MILITARY

The DWM Mauser Military can be distinguished from other Lugers by three features in combination.

1. Late, flat, checkered style toggle knobs.
2. The toggle is marked with the Scroll DWM logo.
3. Eagle/H, Eagle/63 or Eagle/WaA66 acceptance marks.

QUANTITY MADE

Approximately 2,000.

RARITY RATING

6, Rare.

FEATURES IN DEPTH

MANUFACTURER: This model was manufactured by DWM (Deutsche Waffen and Munitionsfabriken) of Berlin, assembled at BKIW-Mausier.

TOGGLE: This model should have the new type toggle, with the flat, checkered toggle knobs.

TOGGLE MARK: 

BARREL: This model should have a 4-inch (100mm) barrel. It should be chambered for 9mm Parabellum.

FRAME: The frame on this model should be the late, short type with a stock lug, wide trigger and narrow trigger guard.

RECEIVER: The receiver on this model should be the late, short type. The chamber should be blank.

THUMB SAFETY: The thumb safety on this model should have a serrated safety lever. The upper position is marked "GESICHERT." Safe is in the lower position.

SIGHTS: The front sight on this model should be a dorsal fin shaped blade, dovetail fit on the barrel. The rear sight should be a fixed V notch in the rear toggle link.

EXTRACTOR: The extractor on this model should be the late type. It should be marked "GELADEN" on the left side.

GRIPS: The grips on this model should be checkered walnut.

MAGAZINE: The magazines original to this model should have a tin-plated, wrap-around body with a wood base. They should be marked with an E/63. They should serial numbered to the pistol.

FINISH: The main finish on this model should be a high-quality rust blue. The ejector, magazine catch/release, takedown lever, thumb safety lever and trigger should all be straw colored.

SERIAL NUMBER RANGE: In the s, t and u serial number blocks.

SERIAL NUMBER LOCATION: The full serial number is found on the bottom of the barrel and on the front of the frame. The last two digits of the serial number are on the breechblock (lower left side), extractor (bottom), front toggle link (bottom), rear toggle link (back), side plate (bottom edge), takedown lever (bottom), trigger (top left), and grips (inside).

INTERESTING VARIATIONS

There are no notable variations of this model.

MARKINGS

MARK **LOCATION/DESCRIPTION**



Toggle
Manufacturer's Logo



Receiver
Military Inspection
Acceptance Mark

and/or



Receiver
Military Inspection
Acceptance Mark

and/or



Receiver
Waffenamt Acceptance Mark

and/or



Receiver
Waffenamt Acceptance Mark

VALUES

POOR	FAIR	GOOD	VG	EXC
\$500	\$900	\$1,000	\$1,800	\$3,500

Look-Up Index # 124

DWM MAUSER FINNISH MILITARY

BACKGROUND

The DWM Mauser Finnish Military model was the fulfillment of the completion of the 1923 DWM Finnish Military contract, with DWM marked toggles and parts, but with Mauser proofing. These were made specifically to complete the contract sales to the Suomen Armeija (SA), meaning Finnish Army.

HOW TO TELL A DWM MAUSER FINNISH MILITARY

The DWM Mauser Finnish Military can be distinguished from other Lugers by four features in combination.

1. Late, flat, checkered style toggle knobs.
2. The toggle is marked with the Scroll DWM logo.
3. SA in box acceptance mark.
4. Crown/U Oberndorf proof.

QUANTITY MADE

Approximately 1,500.

RARITY RATING

6, Rare.

FEATURES IN DEPTH

MANUFACTURER: This model was manufactured by DWM (Deutsche Waffen and Munitionsfabriken) of Berlin, assembled at BKIW-Mauser.

TOGGLE: This model should have the new type toggle, with the flat, checkered toggle knobs.

TOGGLE MARK: 

BARREL: This model should have a 3 7/8-inch (90mm) barrel. It should be chambered for 7.65mm (.30 Luger).

FRAME: The frame on this model should be the late, short type with a stock lug, wide trigger and narrow trigger guard.

RECEIVER: The receiver on this model should be the late, short type. The left side is marked "SA." The chamber should be blank.

THUMB SAFETY: The thumb safety on this model should have a serrated safety lever. The upper position is marked "GESICHERT." Safe is in the lower position.

SIGHTS: The front sight on this model should be a dorsal fin shaped blade, dovetail fit on the barrel. The rear sight should be a fixed V notch in the rear toggle link.

EXTRACTOR: The extractor on this model should be the late type. It should be marked "GELADEN" on the left side.

GRIPS: The grips on this model should be checkered walnut.

MAGAZINE: The magazines original to this model should have a tin-plated, wrap-around body with a wood base. They should not be proof marked or serial numbered.

FINISH: The main finish on this model should be a high-quality rust blue. The ejector, magazine catch/release, takedown lever, thumb safety lever and trigger should all be straw colored.

SERIAL NUMBER RANGE: In the s, t and u serial number blocks.

SERIAL NUMBER LOCATION: The full serial number is found on the bottom of the barrel and on the front of the frame. The last two digits of the serial number are on the breechblock (lower left side), extractor (bottom), front toggle link (bottom), rear toggle link (back), side plate (bottom edge), takedown lever (bottom), trigger (top left), and grips (inside).

INTERESTING VARIATIONS

There are no notable variations of this model.

MARKINGS

MARK	LOCATION/DESCRIPTION
------	----------------------



Toggle
Manufacturer's Logo



Receiver
Mauser Commercial Proof



Receiver
Finnish Army
(Suomen Armeija)
Acceptance Mark

VALUES

POOR	FAIR	GOOD	VG	EXC
\$500	\$900	\$1,000	\$1,800	\$3,500

Look-Up Index # 125

SIMSON S CODE

BACKGROUND

The Simson S Code model was made specifically for military sales to the German Reichswehr. This variation is interesting in that Simson (a Jewish owned company) was trying to downplay its name to continue to sell in the face of a growing Nazi fueled anti-Semitism.

HOW TO TELL A SIMSON S CODE

The Simson S Code can be distinguished from other Lugers by one distinct feature.

1. The toggle is marked longitudinally with the inscription "S."

QUANTITY MADE

10,000 to 12,000.

RARITY RATING

3-4, Uncommon to scarce.

FEATURES IN DEPTH

MANUFACTURER: This model was made by Simson & Co., Suhl.

TOGGLE: This model should have the new type toggle, with the flat, checkered toggle knobs.

TOGGLE MARK: Just a capital letter "S."

BARREL: This model should have a 4-inch (100mm) barrel. It should be chambered for 9mm Parabellum.

FRAME: The frame on this model should be the late, short type with a stock lug, wide trigger and narrow trigger guard.

RECEIVER: The receiver on this model should be the late, short type. The chamber should be blank.

THUMB SAFETY: The thumb safety on this model should have a serrated safety lever. The upper position is marked "GESICHERT." Safe is in the lower position.

SIGHTS: The front sight on this model should be a dorsal fin shaped blade, dovetail fit on the barrel. The rear sight should be a fixed V notch in the rear toggle link.

EXTRACTOR: The extractor on this model should be the late type. It should be marked "GELADEN" on the left side.

GRIPS: The grips on this model should be checkered walnut.

MAGAZINE: The magazines original to this model should have a tin-plated, wrap-around body with an aluminum base. They should be proof marked and serial numbered to the pistol.

FINISH: The main finish on this model should be a high-quality rust blue. The ejector, magazine catch/release, takedown lever, thumb safety lever and trigger should all be straw colored.

SERIAL NUMBER RANGE: Starting from 1 and proceeding into at least 1900 a.

SERIAL NUMBER LOCATION: The full serial number is found on the bottom of the barrel, the front of the frame, and the left side of the receiver. The last two digits of the serial number are on the breechblock (lower left side), extractor, front toggle link (bottom), rear toggle link (back), sear (left side), sear bar safety lever, side plate, takedown lever (bottom), thumb safety lever (top), trigger (top left), and grips (inside).

INTERESTING VARIATIONS

There are no notable variations of this model.

MARKINGS

MARK	LOCATION/DESCRIPTION
------	----------------------



	Receiver Simson Acceptance Marks
--	-------------------------------------

Other numbers and eagle variations include these



Parts
Simson Inspection Mark



Receiver and Barrel
Simson Test Fire Proof

VALUES

POOR	FAIR	GOOD	VG	EXC
\$750	\$1,100	\$2,000	\$2,800	\$4,000

Look-Up Index # 126

SIMSON REWORK, UNMARKED

BACKGROUND

The Simson Rework, Unmarked model was one of a number of early Nazi-era reworks of prior era Lugers for military and police use starting in 1933.

HOW TO TELL A SIMSON REWORK, UNMARKED

The Simson Rework, Unmarked can be distinguished from other Lugers by three features in combination.

1. The toggle is blank.
2. The chamber is blank.
3. Simson type proof marks.

QUANTITY MADE

Very few.

RARITY RATING

6, Rare.

FEATURES IN DEPTH

MANUFACTURER: This model was made by Simson & Co., Suhl.

TOGGLE: This model should have the new type toggle, with the flat, checkered toggle knobs.

TOGGLE MARK: The toggle is blank.

BARREL: This model should have a 4-inch (100mm) barrel. It should be chambered for 9mm Parabellum.

FRAME: The frame on this model should be the late, short type with a stock lug, wide trigger and narrow trigger guard.

RECEIVER: The receiver on this model should be the late, short type. The chamber should be blank.

THUMB SAFETY: The thumb safety on this model should have a serrated safety lever. The upper position is marked "GESICHERT." Safe is in the lower position.

SIGHTS: The front sight on this model should be a dorsal fin shaped blade, dovetail fit on the barrel. The rear sight should be a fixed V notch in the rear toggle link.

EXTRACTOR: The extractor on this model should be the late type. It should be marked "GELADEN" on the left side.

GRIPS: The grips on this model should be checkered walnut.

MAGAZINE: The magazines original to this model should have a tin-plated, wrap-around body with either an aluminum or wood base. They should be proof marked and serial numbered to the pistol.

FINISH: The main finish on this model should be a high-quality rust blue. The ejector, magazine catch/release, takedown lever, thumb safety lever and trigger should all be straw colored.

SERIAL NUMBER RANGE: These pistols usually renumbered as part of the rework. They should be up to four-digits with military style letter suffixing.

SERIAL NUMBER LOCATION: The full serial number is found on the bottom of the barrel, the front of the frame, and the left side of the receiver. The last two digits of the serial number are on the breechblock (lower left side), extractor, front toggle link (bottom), rear toggle link (back), sear (left side), sear bar safety lever, side plate, takedown lever (bottom), thumb safety lever (top), trigger (top left), and grips (inside).

INTERESTING VARIATIONS

There are no notable variations of this model.

MARKINGS

MARK	LOCATION/DESCRIPTION
	Receiver Simson Acceptance Marks

Other numbers and eagle variations include these



Parts
Simson Inspection Mark



Receiver and Barrel
Simson Test Fire Proof



Receiver
Waffenamt Acceptance Mark

VALUES

POOR	FAIR	GOOD	VG	EXC
\$700	\$1,000	\$2,000	\$2,500	\$3,250

Look-Up Index # 127

DEATH'S HEAD REWORK



BACKGROUND

This is possibly the most controversial Luger model there is. The controversy is not that it is legitimate, but regarding what the origin is.

The Death's Head (called a Totenkopf in German) consists of a skull and cross bones surmounted by a letter S on its side (called a lazy S).

Just for completeness, the reader should know that there are three theories as to the meaning of the Totenkopf.

First, is that these were unit marked by German military units in WW I. Specifically, motorized flamethrower units are documented as having used the Totenkopf as their insignia. In addition, they used an attack formation that resembled the lazy S. However, this author believes that this theory fails in two regards.

1. There are no other unit marks in the Kaiser's army that were applied in this manner. The army regulations regarding unit marking were very

clear, and did not allow for a variation such as this. If this was permissible, how come no other non-standard unit mark has come to light?

2. It would probably have been a punishable offense to deface the chamber date (as has been done to many Death's Head Lugers). The fact that they are reworks does not reconcile with weapons issued to newly formed units.

Second, is that these marks were applied by post-WW I paramilitary Freikorps. Bands of former soldiers came together to fight communism, sometimes the establishment and sometimes each other. Freikorps units are documented to have taken the Totenkopf as their insignia. This theory also holds some water in that:

1. The Freikorps would have had to arm themselves from illicit sources. The rework of WW I military model pistols (which the Death's Head Lugers are) would have filled this need.
2. The complete lack of Totenkopf-marked Lugers of Simson or later Mauser manufacture makes it highly unlikely that the Lazy S Totenkopf is associated with a later era.

However, there are a couple of problems with this theory:

1. A piece of crossover knowledge from Mauser rifle collecting says that all Death's Head-marked rifles are marked on the barrel channel of the stock with a rework date (usually in the late 1930s). A 1930s date associated with these disputes this theory.
2. We don't see evidence of similar rework and marks on Broomhandle Mausers, Roth Steyrs or other vintage small arms, which we know that the Freikorps used.

The third theory is that the Death's Head reworks were done in the early Nazi-era for SS use. This popular theory is based on the well known use of the Totenkopf as the insignia of that notorious organization. This theory is the most sound, with the following points to consider:

1. No less an authority than Karl Pawlas, who also served as a Waffen SS armorer, states that the Waffen SS Totenkopf did not have a lazy S. Since this theory states an EARLY Nazi-era SS association, the fact that the later Waffen SS did not use the mark does not contradict the logic.
2. Again, the complete lack of Totenkopf marked Simson or early Mauser Lugers does raise a question, "Why not?"
3. The fact that Mauser was making Nazi-era Lugers for foreign contract and commercial sales during the supposed time of the SS reworking of these pistols. The SS was Hitler's elite personal bodyguard. If they had wanted P.08s they would have been able to get brand new ones.

The author offers as further evidence to support his conclusions an observation from the cross-over field of Mauser rifle collecting.

Consider that the Lazy S Totenkopf has only been noted on reworked Gewehr 98 rifles, but never on K98k model rifles. Unlike the SS Totenkopf (which has a double S rune above it), which has been observed on both types of rifles. In the case of the extremely rare Double Death's Head marked Mauser, they are; (a) all reworked G98 rifles, and (b) always exhibit one Lazy S Totenkopf, and one SS rune surmounted Totenkopf.

This observation would be consistent with the author's explanation that the reworked Gewehr 98s were used by the Freikorps as well. Then some of these actually got reworked as SS rifles in the K98k configuration during the early Nazi period when the SS needed to resort to such measures to fully equip itself.

HOW TO TELL A DEATH'S HEAD REWORK

The Death's head Reworks are easily distinguished from other Lugers by one distinct feature.

1. A skull and crossbones stamped above the date on the chamber.

QUANTITY MADE

Unknown.

RARITY RATING

8, Extremely rare.

FEATURES IN DEPTH

MANUFACTURER/REWORKER: The original manufacturers were DWM and Erfurt. Who performed the rework remains unknown.

TOGGLE: This model should have the new type toggle, with the flat, checkered toggle knobs.

TOGGLE MARK:  or  **ERFURT**

BARREL: This model should have a 4-inch (100mm) barrel. It should be chambered for 9mm Parabellum.

FRAME: The frame on this model should be the late, short type with a stock lug, wide trigger and narrow trigger guard.

RECEIVER: The receiver on this model should be the late, short type. The chamber should be marked with a four-digit date from 1914 to 1918. Some have the date removed. The chamber should also have a skull and crossbones inscription.

THUMB SAFETY: The thumb safety on this model should have a serrated safety lever. The upper position is marked "GESICHERT." Safe is in the lower position.

SIGHTS: The front sight on this model should be a dorsal fin shaped blade, dovetail fit on the barrel. The rear sight should be a fixed V notch in the rear toggle link.

EXTRACTOR: The extractor on this model should be the late type. It should be marked "GELADEN" on the left side.

GRIPS: The grips on this model should be checkered walnut.

MAGAZINE: The magazines original to this model should have a tin-plated, wrap-around body with a wood base. They should be proof marked and serial numbered to the pistol.

FINISH: The main finish on this model should be a high-quality rust blue. The ejector, magazine catch/release, takedown lever, thumb safety lever and trigger should all be straw colored.

SERIAL NUMBER RANGE: These pistols usually retain the serial numbering of the original pistol. This should be up to four-digits with military style letter suffixing.

SERIAL NUMBER LOCATION: The full serial number is found on the bottom of the barrel, the front of the frame, and the left side of the receiver. The last two digits of the serial number are on the breechblock (lower left side), extractor, front toggle link (bottom), rear toggle link (back), sear (left side), sear bar safety lever, side plate, takedown lever (bottom), thumb safety lever (top), trigger (top left), and grips (inside).

INTERESTING VARIATIONS

There are no notable variations of this model.

MARKINGS

MARK **LOCATION/DESCRIPTION**



Toggle
Manufacturer's Logo



Toggle
Manufacturer's Logo



Chamber
Rework Mark

VALUES

POOR	FAIR	GOOD	VG	EXC
\$800	\$1,000	\$1,500	\$2,500	\$3,000

Look-Up Index # 128

Kl. 1933 REWORK

BACKGROUND

The Kl. 1933 Reworks were made specifically for early Nazi military use. On that point, there is no dispute. The meaning of the Kl. is still undetermined beyond any doubt.

For decades this model has been referred to as the Kadetten Institut (KI) rework. However, upon close inspection of the chamber mark, it looks more like a capital K, small L, than it does a capital K, capital I. There is now generally agreement on this by most Luger researchers.

The two theories as to the meaning of the Kl are:

One theory is that these were reworked for Konzentrationlager (concentration camp) guards. This theory holds water in that these are only ever found dated 1933. That is the year Hitler came to power, which pre-dated the earnest rearmament by a year.

However, it does not make sense that a firearm in violation of the Versailles Treaty would be so boldly date marked. Hitler did not publicly announce German rearmament until 1936. The date code "n" for 1933 would have made more sense in support of this theory.

A new, well-researched theory (which the author admits to supporting) is that these were late Simson reworks performed by a Simson affiliate, the Werkstatt Klett (Klett Workshop). Here is the supporting logic.

In 1933 Simson was the only company still officially approved by the international commission that monitored German compliance to the Versailles Treaty. However, since the Nazi's were firmly in power in 1933, we already know that Simson had dropped their name from new Luger toggles.

However, Simson did have a close association with another gunsmith workshop in Suhl named Klett. The theory is that Simson either operating under the name of its subsidiary, or having subcontracted the work to a name less offensive to the Nazi regime, was reworking P.08s as Werkstatt Klett.

This theory has no holes at the time of this writing. In its support is that the date of these is so openly marked during 1933. Only a rework officially sanctioned by the IMKK makes sense with a non-coded date in 1933. Furthermore, Simson had already dropped its name from the toggle of its Lugers. It makes sense that the increased anti-Semitism of the Nazi regime would have led Simson to take such a step during its final chance to exploit its favored position under Versailles.

HOW TO TELL A KI. 1933 REWORK

The KI. 1933 Reworks are easily distinguished from other Lugers by one distinct feature.

1. The original chamber date marking has been removed and replaced by the inscription "KI. 1933."

QUANTITY MADE

Unknown.

RARITY RATING

7-8, Very rare to extremely rare.

FEATURES IN DEPTH

MANUFACTURER/REWORKER: This model was reworked by Klett Werkstatt, Suhl.

TOGGLE: This model should have the new type toggle, with the flat, checkered toggle knobs.

TOGGLE MARK: This model will retain the toggle marking from its original manufacture, either DWM, Erfurt of Simson.

BARREL: This model should have a 4-inch (100mm) barrel. It should be chambered for 9mm Parabellum.

FRAME: The frame on this model should be the late, short type with a stock lug, wide trigger and narrow trigger guard.

RECEIVER: The receiver on this model should be late, short type. The chamber should be marked with a "KI 1933" inscription.

THUMB SAFETY: The thumb safety on this model should have a serrated safety lever. The upper position is marked "GESICHERT." Safe is in the lower position.

SIGHTS: The front sight on this model should be a dorsal fin shaped blade, dovetail fit on the barrel. The rear sight should be a fixed V notch in the rear toggle link.

EXTRACTOR: The extractor on this model should be the late type. It should be marked "GELADEN" on the left side.

GRIPS: The grips on this model should be checkered walnut.

MAGAZINE: The magazines original to this group of reworks should be the same magazine found in the original Luger. Most have a tin-plated, wrap-around body with a wood base. They should be proof marked and serial numbered to the pistol.

FINISH: The main finish on this model should be a high-quality rust blue. The ejector, magazine catch/release, takedown lever, thumb safety lever and trigger should all be straw colored.

SERIAL NUMBER RANGE: These pistols usually retain the serial numbering of the original pistol. This should be up to four-digits with military style letter suffixing.

SERIAL NUMBER LOCATION: The full serial number is found on the bottom of the barrel, the front of the frame, and the left side of the receiver. The last two digits of the serial number are on the breechblock (lower left side), extractor, front toggle link (bottom), rear toggle link (back), sear (left side), sear bar safety lever, side plate, takedown lever (bottom), thumb safety lever (top), trigger (top left), and grips (inside).

INTERESTING VARIATIONS

There are no notable variations of this model.

MARKINGS

MARK	LOCATION/DESCRIPTION
------	----------------------

Aside from the original toggle marking, the pistols of this model have had the original inspection and proof marks removed. The following new mark was then added.



Receiver and Barrel
Simson Test Fire Proof

Other marks have been noted but nothing consistent enough to document.

VALUES

POOR	FAIR	GOOD	VG	EXC
\$750	\$900	\$1,200	\$2,250	\$3,000

Look-Up Index # 129

MAUSER REWORK, UNMARKED

BACKGROUND

The Mauser Rework, Unmarked model is another one of the Nazi-era reworks of prior era Lugers for military and police use starting in 1933. This model has three variations; military (waffenamt) only marked, commercial (Nitro) only marked, or marked with both.

HOW TO TELL A MAUSER REWORK, UNMARKED

The Mauser Rework, Unmarked can be distinguished from other Lugers by three features in combination.

1. The toggle is blank.
2. The chamber is blank.
3. Mauser type proof marks.

QUANTITY MADE

Unknown, but more often encountered than most other reworks.

RARITY RATING

7, Very rare.

FEATURES IN DEPTH

MANUFACTURER: This model was manufactured by Mauser Werke, Oberndorf.

TOGGLE: This model should have the new type toggle, with the flat, checkered toggle knobs.

TOGGLE MARK: The toggle is blank

BARREL: This model should have a 4-inch (100mm) barrel. It should be chambered for 9mm Parabellum.

FRAME: The frame on this model should be the late, short type with a stock lug, wide trigger and narrow trigger guard.

RECEIVER: The receiver on this model should be the late, short type. The chamber should be blank.

THUMB SAFETY: The thumb safety on this model should have a serrated safety lever. The upper position is marked "GESICHERT." Safe is in the lower position.

SIGHTS: The front sight on this model should be a dorsal fin shaped blade, dovetail fit on the barrel. The rear sight should be a fixed V notch in the rear toggle link.

EXTRACTOR: The extractor on this model should be the late type. It should be marked "GELADEN" on the left side.

GRIPS: The grips on this model should be checkered walnut.

MAGAZINE: The magazines original to this group of reworks should the same magazine found in the original Luger. Most have a tin-plated, wrap-around body with an aluminum base. They should be proof marked and serial numbered to the pistol.

FINISH: These reworked pistols would have originally been rust blue, but may have been refinished as part of the rework. The ejector, magazine catch, takedown lever, thumb safety and trigger should all be straw colored.

SERIAL NUMBER RANGE: These pistols usually retain the serial numbering of the original pistol, although they were occasionally renumbered as part of the rework. This should be up to four-digits with military style letter suffixing.

SERIAL NUMBER LOCATION: The full serial number is found on the bottom of the barrel, the front of the frame, and the left side of the receiver. The last two digits of the serial number are on the breechblock (lower left side), extractor, front toggle link (bottom), rear toggle link (back), sear (left side), sear bar safety lever, side plate,

takedown lever (bottom), thumb safety lever (top), trigger (top left), and grips (inside).

INTERESTING VARIATIONS

There are no notable variations of this model.

MARKINGS

MARK **LOCATION/DESCRIPTION**



Receiver
Test Fire Proof



Receiver
Waffnamt Acceptance Mark

VALUES

POOR	FAIR	GOOD	VG	EXC
\$700	\$1,000	\$2,000	\$2,500	\$3,250

Look-Up Index # 130

VONO REWORK

BACKGROUND

The Vono Rework model constituted Nazi-era reworks for commercial sale. W.P. von Nordheim in Zella-Mehlis openly stamped their name on the right side of the receiver. Their logo was a script contraction of the last name (Vono), which is stamped on the chamber.

HOW TO TELL A VONO REWORK

The Vono Rework can be distinguished from other Lugers by two features in combination.

1. The toggle is blank.
2. The chamber is stamped with the script word Vono.

QUANTITY MADE

Unknown.

RARITY RATING

7, Very rare.

FEATURES IN DEPTH

REWORKER: This model was reworked by W.P. Von Nordheim, Zella-Mehlis.

TOGGLE: This model should have the new type toggle, with the flat, checkered toggle knobs.

TOGGLE MARK: The toggle is blank.

BARREL: This model should have a 4-inch (100mm) barrel. It could be chambered for either 7.65mm (.30 Luger) or 9mm Parabellum. The former has been found with marked "Kal 7.65" lengthwise atop the barrel.

FRAME: The frame on this model should be the late, short type with a stock lug, wide trigger and narrow trigger guard.

RECEIVER: The receiver on this model should be the late, short type. The right side should be marked W.P. "Vnordheim." The chamber should be marked with the inscription "Vena."

THUMB SAFETY: The thumb safety on this model should have a serrated safety lever. The upper position is marked "GESICHERT." Safe is in the lower position.

SIGHTS: The front sight on this model should be a dorsal fin shaped blade, dovetail fit on the barrel. The rear sight should be a fixed V notch in the rear toggle link.

EXTRACTOR: The extractor on this model should be the late type. It should be marked "GELADEN" on the left side.

GRIPS: The grips on this model should be checkered walnut.

MAGAZINE: The magazines original to this group of reworks should be the same magazine found in the original Luger. Most have a tin-plated, wrap-around body with either an aluminum or wood base. They should be proof marked and serial numbered to the pistol.

FINISH: The main finish on these reworks should be salt blue, whereas the original finish was probably rust blue. Ejector, magazine catch, takedown lever, thumb safety lever and trigger all straw colored.

SERIAL NUMBER RANGE: These pistols usually retain the serial numbering of the original pistol, although they were occasionally renumbered as part of the rework. This should be up to four-digits with military style letter suffixing.

SERIAL NUMBER LOCATION: The full serial number is found on the bottom of the barrel, the front of the frame, and the left side of the receiver. The last two digits of the serial number are on the breechblock (lower left side), extractor, front toggle link (bottom), rear toggle link (back), sear (left side), sear bar safety lever, side plate, takedown lever, thumb safety lever (top), trigger (top left), and grips (inside).

INTERESTING VARIATIONS

There are no notable variations of this model.

MARKINGS

MARK	LOCATION/DESCRIPTION
------	----------------------



	Receiver and Barrel Nazi-era Commercial Proof
--	--

VALUES

POOR	FAIR	GOOD	VG	EXC
\$700	\$1,000	\$2,000	\$2,500	\$3,250

Look-Up Index # 131

ANSCHUTZ REWORK

BACKGROUND

The Anschutz Rework model was another early Nazi-era rework for commercial sales. The reworker J.G. Anschutz stamped their name on the bottom of the barrel.

HOW TO TELL AN ANSCHUTZ REWORK

The Anschutz Rework can be distinguished from other Lugers by two features in combination.

1. The toggle is blank.
2. The bottom of the barrel is marked "J.G. ANSCHUTZ."

QUANTITY MADE

Unknown, but very few.

RARITY RATING

7, Very rare.

FEATURES IN DEPTH

MANUFACTURER: This model was manufactured by Mauser Werke, Oberndorf.

TOGGLE: This model should have the new type toggle, with the flat, checkered toggle knobs.

TOGGLE MARK: The toggle is blank

BARREL: This model should have a 4-inch (100mm) barrel. It should be chambered for 9mm Parabellum. The bottom of the barrel should be marked "J.G. ANSCHUTZ."

FRAME: The frame on this model should be the late, short type with a stock lug, wide trigger and narrow trigger guard.

RECEIVER: The receiver on this model should be the late, short type. The chamber should be blank.

THUMB SAFETY: The thumb safety on this model should have a serrated safety lever. The upper position is marked "GESICHERT." Safe is in the lower position.

SIGHTS: The front sight on this model should be a dorsal fin shaped blade, dovetail fit on the barrel. The rear sight should be a fixed V notch in the rear toggle link.

EXTRACTOR: The extractor on this model should be the late type. It should be marked "GELADEN" on the left side.

GRIPS: The grips on this model should be checkered walnut.

MAGAZINE: The magazines original to this group of reworks should the same magazine found in the original Luger. Most have a tin-plated, wrap-around body with an aluminum base. They should be proof marked and serial numbered to the pistol.

FINISH: The main finish on these reworks should be salt blue, whereas the original finish was probably rust blue. Ejector, magazine catch, takedown lever, thumb safety lever and trigger all straw colored.

SERIAL NUMBER RANGE: These pistols usually retain the serial numbering of the original pistol, although they were occasionally renumbered as part of the rework. This should be up to four-digits with military style letter suffixing.

SERIAL NUMBER LOCATION: The full serial number is found on the bottom of the barrel, the front of the frame, and the left side of the receiver. The last two digits of the serial number are on the breechblock (lower left side), extractor, front toggle link (bottom), rear toggle link (back), sear (left side), sear bar safety lever, side plate, takedown lever, thumb safety lever (top), trigger (top left), and grips (inside).

INTERESTING VARIATIONS

There are no notable variations of this model.

MARKINGS

MARK	LOCATION/DESCRIPTION
	Receiver and Barrel Nazi-era Commercial Proof
	Barrel Anschutz Rework Proof

VALUES

POOR	FAIR	GOOD	VG	EXC
\$700	\$1,000	\$2,000	\$2,500	\$3,250

Look-Up Index # 132

MAUSER PROTOTYPE

BACKGROUND

The Mauser Prototype model was made specifically for test and workshop usage.

HOW TO TELL A MAUSER PROTOTYPE

The Mauser Prototype can be distinguished from other Lugers by one distinct feature.

1. The Mauser Oberndorf Crown/U commercial proof is on the toggle.

QUANTITY MADE

Less than 10, only 2 are known.

RARITY RATING

9, Nearly unique.

FEATURES IN DEPTH

MANUFACTURER: This model was manufactured by Mauser Werke, Oberndorf.

TOGGLE: This model should have the new type toggle, with the flat, checkered toggle knobs.

TOGGLE MARK: 

BARREL: Of the two examples of this model known, one has a 4¾-inch (120mm) barrel chambered for 7.65mm (.30 Luger). The other has a 4-inch (100mm) barrel chambered for 9mm Parabellum.

FRAME: The frame on this model should be the late, short type with a stock lug, wide trigger and narrow trigger guard. Attached to the lanyard loop is a metal tag that reads "ACHTUNG! DAS ENTFERN DIESES PISTOLE VON DER WERKSTATTEN IST STRENGESTENS VERBOTTEN!" This translates to "Attention! The removal of this pistol from the workshop is strictly forbidden!"

RECEIVER: The receiver on this model should be the late, short type. The chamber should be blank.

THUMB SAFETY: The thumb safety on this model should have a serrated safety lever. The upper position is marked "GESICHERT." Safe is in the lower position.



SIGHTS: The front sight on this model should be a saw tooth shaped blade, dovetail fit on the barrel. The rear sight should be a fixed V notch in the rear toggle link.

EXTRACTOR: The extractor on this model should be the late type. It should be marked "GELADEN" on the left side.

INTERESTING VARIATIONS

There is an “artillery” variation of the Mauser-made Stoeger model. The differences are in the barrel (8 inches), the caliber (9mm Parabellum), the front sight (a dorsal fin, not a saw tooth shaped blade), and the rear sight (a nine-position adjustable type located on the rear of the barrel).

MARKINGS

MARK	LOCATION/DESCRIPTION
	Toggle Manufacturer’s Logo
	Receiver Mauser Commercial Proof
	Receiver Nitro Commercial Proof

VALUES

POOR	FAIR	GOOD	VG	EXC
\$800	\$1,200	\$2,000	\$3,800	\$5,000

Look-Up Index # 134

DWM/MAUSER SWISS

BACKGROUND

The DWM/Mauser Swiss model was generally made for commercial sales within Switzerland.

HOW TO TELL A DWM/MAUSER SWISS

The DWM/Mauser Oberndorf can be distinguished from other Lugers by four features in combination.

1. Late, flat, checkered style toggle knobs.
2. The toggle is marked with the scroll DWM logo.
3. The chamber has a Swiss Cross in Sunburst inscription.
4. Has a stock lug.

QUANTITY MADE

Less than 100.

RARITY RATING

8, Extremely rare.

FEATURES IN DEPTH

MANUFACTURER: This model was manufactured by Mauser Werke, Oberndorf.

TOGGLE: This model should have the new type toggle, with the flat, checkered toggle knobs.

TOGGLE MARK: 

BARREL: This model should have a 4¾-inch (120mm) barrel. It should be chambered for 7.65mm (.30 Luger).

FRAME: The frame on this model should be the late, short type with a grip safety, stock lug, wide trigger and narrow trigger guard.

RECEIVER: The receiver on this model should be the late, short type. The chamber should be marked with a Swiss Cross in Sunburst inscription.

THUMB SAFETY: The thumb safety on this model should have a serrated safety lever. The upper position is marked “GESICHERT.” Safe is in the lower position.

SIGHTS: The front sight on this model should be a saw tooth shaped blade, dovetail fit on the barrel. The rear sight should be a fixed V notch in the rear toggle link.

EXTRACTOR: The extractor on this model should be the late type. It should be marked “GELADEN” on the left side.

GRIPS: The grips on this model should be checkered walnut.

MAGAZINE: The magazines original to this model should have a tin-plated, wrap-around body with a wood base. They should not be proof marked or serial numbered.

FINISH: The main finish on this model should be a salt blue. The ejector, magazine catch/release, takedown lever, thumb safety lever and trigger should all be straw colored.

SERIAL NUMBER RANGE: Reported in the 500 v range.

SERIAL NUMBER LOCATION: The full serial number is found on the bottom of the barrel, and on the front of the frame, The last two digits of the serial number are on the breechblock (lower left side), extractor (bottom), front toggle link (bottom), rear toggle link (back), receiver (rear), side plate (bottom edge), takedown lever (bottom), trigger (top left), grip safety (under grip) and grips (inside).

INTERESTING VARIATIONS

There are no notable variations of this model.

MARKINGS

MARK LOCATION/DESCRIPTION



Toggle
Manufacturer's Logo



Receiver
Mauser Commercial Proof

VALUES

POOR	FAIR	GOOD	VG	EXC
\$800	\$1,500	\$2,250	\$3,500	\$4,000

Look-Up Index # 135

DWM/MAUSER OBERNDORF

BACKGROUND

The DWM/Mauser Oberndorf model was generally made for commercial sales both within Germany. Even though the toggle mark makes these look like a typical post WW I commercial Luger, the Mauser Oberndorf proofs are what show these to me Mauser made/assembled from parts they got in their absorbing of DWM.

HOW TO TELL A DWM/MAUSER OBERNDORF

The DWM/Mauser Oberndorf can be distinguished from other Lugers by four features in combination.

1. Late, flat, checkered style toggle knobs.
2. The toggle is marked with the scroll DWM logo.
3. The chamber is blank.
4. Mauser commercial Crown/U proof marked.

QUANTITY MADE

Approximately 300.

RARITY RATING

7, Very rare.

FEATURES IN DEPTH

MANUFACTURER: This model was manufactured by Mauser Werke, Oberndorf.

TOGGLE: This model should have the new type toggle, with the flat, checkered toggle knobs.

TOGGLE MARK: 

BARREL: This model should have a 4-inch (100mm) barrel. It should be chambered for 9mm Parabellum.

FRAME: The frame on this model should be the late, short type with a stock lug, wide trigger and narrow trigger guard.

RECEIVER: The receiver on this model should be the late, short type. The chamber should be blank.

THUMB SAFETY: The thumb safety on this model should have a serrated safety lever. The upper position is marked "GESICHERT." Safe is in the lower position.

SIGHTS: The front sight on this model should be a dorsal fin shaped blade, dovetail fit on the barrel. The rear sight should be a fixed V notch in the rear toggle link.

EXTRACTOR: The extractor on this model should be the late type. It should be marked "GELADEN" on the left side.

GRIPS: The grips on this model should be checkered walnut.

MAGAZINE: The magazines original to this model should have a tin-plated, wrap-around body with either an aluminum or wood base. They should not be proof marked or serial numbered.

FINISH: The main finish on this model should be a salt blue. The ejector, magazine catch/release, takedown lever, thumb safety lever and trigger should all be straw colored.

SERIAL NUMBER RANGE: Reported in the 600 v to 1240 v range.

SERIAL NUMBER LOCATION: The full serial number is found on the bottom of the barrel and on the front of the frame. The last two digits of the serial number are on the breechblock (lower left side), extractor (bottom), front toggle link (bottom), rear toggle link (back), receiver (rear), sear (left side), side plate (bottom edge), takedown lever (bottom), trigger (top left), and grips (inside).

INTERESTING VARIATIONS

MARKINGS

MARK LOCATION/DESCRIPTION



Toggle
Manufacturer's Logo



Receiver
Mauser Commercial Proof

VALUES

POOR	FAIR	GOOD	VG	EXC
\$800	\$1,500	\$2,250	\$3,500	\$4,000

Look-Up Index # 136

MAUSER BANNER FINNISH

BACKGROUND

The Mauser Banner Finnish model was made specifically for military contract sales to the Suomen Armeija (SA), meaning Finnish Army.

HOW TO TELL A MAUSER BANNER FINNISH

The Mauser Banner Finnish can be distinguished from other Lugers by two features in combination.

1. The toggle is marked with the Mauser banner logo.
2. An SA in box mark somewhere on the pistol.

QUANTITY MADE

Unknown. Probably less than 1,000.

RARITY RATING

7, Very rare.

FEATURES IN DEPTH

MANUFACTURER: This model was manufactured by Mauser Werke, Oberndorf.

TOGGLE: This model should have the new type toggle, with the flat, checkered toggle knobs.

TOGGLE MARK: 

BARREL: This model should have a 4-inch (100mm) barrel. It should be chambered for 9mm Parabellum.

FRAME: The frame on this model should be the late, short type with a wide trigger and narrow trigger guard.

RECEIVER: The receiver on this model should be the late, short type. The chamber should be blank.

THUMB SAFETY: The thumb safety on this model should have a serrated safety lever. The lower position is marked "GESICHERT." Safe is in the upper position.

SIGHTS: The front sight on this model should be a saw tooth shaped blade, dovetail fit on the barrel. The rear sight should be a fixed V notch in the rear toggle link.

EXTRACTOR: The extractor on this model should be the late type. It should be marked "GELADEN" on the left side.

GRIPS: The grips on this model should be checkered walnut.

MAGAZINE: The magazines original to this model should have a tin-plated, wrap-around body with an aluminum base. They should not be proof marked or serial numbered.

FINISH: The main finish on this model should be a salt blue. The ejector, magazine catch/release, takedown lever, thumb safety lever and trigger should all be straw colored.

SERIAL NUMBER RANGE: In the v serial number suffix block.

SERIAL NUMBER LOCATION: The full serial number is found on the bottom of the barrel, the front of the frame, and the left side of the receiver. The last two digits of the serial number are on the breechblock (lower left side), extractor, front toggle link (bottom), rear toggle link (back), sear (left side), sear bar safety lever, side plate, takedown lever (bottom), thumb safety lever (top), trigger (top left), grip safety (under grip) and grips (inside).

INTERESTING VARIATIONS

There are no notable variations of this model.

MARKINGS

MARK	LOCATION/DESCRIPTION
-------------	-----------------------------



Toggle
Manufacturer's Logo



Receiver
Mauser Commercial Proof



Receiver
Finnish Army
(Suomen Armeija)
Acceptance Mark

VALUES

POOR	FAIR	GOOD	VG	EXC
\$1,000	\$1,750	\$3,500	\$5,000	\$7,000

Look-Up Index # 137

MAUSER PORTUGUESE GNR



BACKGROUND

The Mauser Portuguese GNR model was made specifically for military contract sales to Portugal for use by the Garde Nationale Republicanie (Republic National Guard) or GNR.

HOW TO TELL A MAUSER PORTUGUESE GNR

The Mauser Portuguese GNR can be distinguished from other Lugers by two features in combination.

1. The Mauser banner logo on the toggle.
2. An intertwined GNR inscribed above the chamber.

QUANTITY MADE

Exactly 564.

RARITY RATING

7, Very rare.

FEATURES IN DEPTH

MANUFACTURER: This model was manufactured by Mauser Werke, Oberndorf.

TOGGLE: This model should have the new type toggle, with the flat, checkered toggle knobs.

TOGGLE MARK:



BARREL: 4¾-inch in 7.65mm.

FRAME: The frame on this model should be the late, short type with a grip safety, wide trigger and narrow trigger guard.

RECEIVER: The receiver on this model should be the late, short type. The chamber should be marked with an intertwined "GNR" inscription.



THUMB SAFETY:

The thumb safety on this model should have a serrated safety lever. The lower position is marked "SEGURANCA." Safe is in the upper position.

SIGHTS: The front sight on this model should be a saw tooth shaped blade, dovetail fit on the barrel. The rear sight should be a fixed V notch in the rear toggle link.

EXTRACTOR: The extractor on this model should be the late type. It should be marked "CARREGADA" on the left side.

GRIPS: The grips on this model should be checkered walnut. The left grip should be slotted for the grip safety.

MAGAZINE: The magazines original to this model should have a tin-plated, wrap-around body with an aluminum base. They should not be proof marked or serial numbered.

FINISH: The main finish on this model should be a salt blue. The ejector, magazine catch/release, takedown lever, thumb safety lever and trigger should all be straw colored.

SERIAL NUMBER RANGE: 1921 v to 2484 v.

SERIAL NUMBER LOCATION: The full serial number is found on the bottom of the barrel, the front of the frame, and the left side of the receiver. The last two digits of the serial number are on the breechblock (lower left side), extractor, front toggle link (bottom), rear toggle link (back), sear (left side), sear bar safety lever, side plate, takedown lever (bottom), thumb safety lever (top), trigger (top left), grip safety (under grip) and grips (inside).

INTERESTING VARIATIONS

There are no notable variations of this model.

MARKINGS

MARK	LOCATION/DESCRIPTION
------	----------------------



	Toggle Manufacturer's Logo
--	-------------------------------



	Receiver Mauser Commercial Proof
--	-------------------------------------

VALUES

POOR	FAIR	GOOD	VG	EXC
\$750	\$900	\$1,500	\$2,800	\$3,400

Look-Up Index # 138

MAUSER BANNER DUTCH NAVY

BACKGROUND

The Mauser Banner Dutch Navy model was made specifically for military contract sales to the Netherlands.

HOW TO TELL A MAUSER BANNER DUTCH NAVY

The Mauser Banner Dutch Navy can be distinguished from other Lugers by two features in combination.

1. Toggle has the Mauser banner logo inscription.
2. The thumb safety is marked "RUST."

QUANTITY MADE

- 200 dated 1937
- 100 dated 1938
- 224 dated 1939

RARITY RATING

7-8, Very rare to extremely rare.

FEATURES IN DEPTH

MANUFACTURER: This model was manufactured by Mauser Werke, Oberndorf.

TOGGLE: This model should have the new type toggle, with the flat, checkered toggle knobs.

TOGGLE MARK:



BARREL: This model should have a 4-inch (100mm) barrel. It should be chambered for 9mm Parabellum.

FRAME: The frame on this model should be the late, short type with a stock lug, wide trigger and narrow trigger guard.

RECEIVER: The receiver on this model should be the late, short type. The chamber should be dated 1936 to 1940.

THUMB SAFETY: The thumb safety on this model should have a serrated safety lever. It is marked "RUST" with a curved arrow pointing to the safe, lower position.

SIGHTS: The front sight on this model should be a dorsal fin shaped blade, dovetail fit on the barrel. The rear sight should be a fixed V notch in the rear toggle link.

EXTRACTOR: The extractor on this model should be the late type. It should be marked "GELADEN" on the left side.

GRIPS: The grips on this model should be checkered walnut.

MAGAZINE: The magazines original to this model should have a tin-plated, wrap-around body with an aluminum base. They should not be proof marked or serial numbered.

FINISH: The main finish on this model should be a high-quality rust blue. The ejector, magazine catch/release, takedown lever, thumb safety lever and trigger should all be straw colored.

SERIAL NUMBER RANGE:

- 2130 to 2329 dated 1937.
- 2330 v to 2429 v dated 1938.
- 2430 v to 2654 v dated 1939.

SERIAL NUMBER LOCATION: The full serial number is found on the bottom of the barrel, the front of the frame, and the left side of the receiver. The last two digits of the serial number are on the breechblock (lower left side), extractor, front toggle link (bottom), rear toggle link (back), sear (left side), sear bar safety lever, side plate, takedown lever (bottom), thumb safety lever (top), trigger (top left), and grips (inside).

INTERESTING VARIATIONS

There are no notable variations of this model.

MARKINGS

MARK	LOCATION/DESCRIPTION
-------------	-----------------------------



Toggle
Manufacturer's Logo



Receiver
Mauser Commercial Proof

VALUES

POOR	FAIR	GOOD	VG	EXC
\$800	\$1,500	\$2,500	\$4,000	\$6,000

Look-Up Index # 139

MAUSER BANNER DUTCH/GERMAN

BACKGROUND

The Mauser Banner Dutch/German model was intended to fulfill a contract order from the Dutch Navy. However, the German invasion of the Low Countries nullified the selling of military arms to the Netherlands. These pieces were military proofed and issued to the Wehrmacht.

HOW TO TELL A MAUSER BANNER DUTCH/GERMAN

The Mauser Banner Dutch/German can be distinguished from other Lugers by three features in combination.

1. Toggle has the Mauser banner logo inscription.
2. The thumb safety is marked "RUST."
3. German military proofs.

QUANTITY MADE

Approximately 600.

RARITY RATING

7, Very rare.

FEATURES IN DEPTH

MANUFACTURER: This model was manufactured by Mauser Werke, Oberndorf.

TOGGLE: This model should have the new type toggle, with the flat, checkered toggle knobs.

TOGGLE MARK:



BARREL: This model should have a 4-inch (100mm) barrel. It should be chambered for 9mm Parabellum.

FRAME: The frame on this model should be the late, short type with a stock lug, wide trigger and narrow trigger guard.

RECEIVER: The receiver on this model should be the late, short type. The chamber should be dated 1940.

THUMB SAFETY: The thumb safety on this model should have a serrated safety lever. It is marked "RUST" with a curved arrow pointing to the safe, lower position.

SIGHTS: The front sight on this model should be a dorsal fin shaped blade, dovetail fit on the barrel. The rear sight should be a fixed V notch in the rear toggle link.

EXTRACTOR: The extractor on this model should be the late type. It should be marked "GELADEN" on the left side.

GRIPS: The grips on this model should be checkered walnut.

MAGAZINE: The magazines original to this model should have a tin-plated, wrap-around body with an aluminum base. They should not be proof marked or serial numbered.

FINISH: The main finish on this model should be a high-quality rust blue. The ejector, magazine catch/release, takedown lever, thumb safety lever and trigger should all be straw colored.

SERIAL NUMBER RANGE: 2655 v to 3254 v.

SERIAL NUMBER LOCATION: The full serial number is found on the bottom of the barrel, the front of the frame, and the left side of the receiver. The last two digits of the serial number are on the breechblock (lower left side), extractor, front toggle link (bottom), rear toggle link (back), sear (left side), sear bar safety lever, side plate, takedown lever (bottom), thumb safety lever (top), trigger (top left), and grips (inside).

INTERESTING VARIATIONS

There are no notable variations of this model.

MARKINGS

MARK	LOCATION/DESCRIPTION
------	----------------------



Toggle
Manufacturer's Logo



Receiver (on most)
Mauser Commercial Test Proof



Receiver (on late ones)
Military Test Fire Proof



Receiver
Military Acceptance Mark

VALUES

POOR	FAIR	GOOD	VG	EXC
\$800	\$1,500	\$2,500	\$4,000	\$6,000

Look-Up Index # 140

MAUSER BANNER COMMERCIAL

BACKGROUND

The Mauser Banner Commercial model was generally made for commercial sales both within Germany and abroad.

HOW TO TELL A MAUSER BANNER COMMERCIAL

The Mauser Banner Commercial can be distinguished from other Lugers by three features in combination.

1. Toggle has the Mauser banner logo inscription.
2. Has NO grip safety.
3. Has a blank chamber.

QUANTITY MADE

500.

RARITY RATING

7, Very rare.

FEATURES IN DEPTH

MANUFACTURER: This model was manufactured by Mauser Werke, Oberndorf.

TOGGLE: This model should have the new type toggle, with the flat, checkered toggle knobs.

TOGGLE MARK: 

BARREL: This model should have a 4-inch (100mm) barrel. It should be chambered for 9mm Parabellum.

FRAME: The frame on this model should be the late, short type with a stock lug, wide trigger and narrow trigger guard. Some are marked "P.08" on the left side, near the thumb safety.

RECEIVER: The receiver on this model should be the late, short type. The chamber should be blank.

THUMB SAFETY: The thumb safety on this model should have a serrated safety lever. The upper position is marked "GESICHERT." Safe is in the lower position.

SIGHTS: The front sight on this model should be a dorsal fin shaped blade, dovetail fit on the barrel. The rear sight should be a fixed V notch in the rear toggle link.

EXTRACTOR: The extractor on this model should be the late type. It should be marked "GELADEN" on the left side.

GRIPS: The grips on this model should be checkered walnut. Some late examples have black checkered plastic grips with a smooth border.

MAGAZINE: The magazines original to this model should have a tin-plated, wrap-around body with an aluminum base. It should not be proof marked or serial numbered.

FINISH: The main finish on this model should be either a high-quality rust or a salt blue. The ejector, magazine catch/release, takedown lever, thumb safety lever and trigger should all be straw colored.

SERIAL NUMBER RANGE: 3500 v to 4000 v range.

SERIAL NUMBER LOCATION: The full serial number is found on the bottom of the barrel, the front of the frame, and the left side of the receiver. The last two digits of the serial number are on the breechblock (lower left side), extractor, front toggle link (bottom), rear toggle link (back), sear (left side), sear bar safety lever, side plate, takedown lever (bottom), thumb safety lever (top), trigger (top left), and grips (inside, wood grips only).

INTERESTING VARIATIONS

There are no notable variations of this model.

MARKINGS

MARK	LOCATION/DESCRIPTION
------	----------------------



Toggle
Manufacturer's Logo



Receiver
Nazi-era Commercial Proof

VALUES

POOR	FAIR	GOOD	VG	EXC
\$750	\$1,250	\$1,500	\$2,000	\$2,850

Look-Up Index # 141

MAUSER BANNER SWISS

BACKGROUND

The Mauser Banner Swiss model was generally made for commercial sales in Switzerland.

HOW TO TELL A MAUSER BANNER SWISS

The Mauser Banner Swiss can be distinguished from other Lugers by two features in combination.

1. The Mauser logo banner inscription on the toggle.
2. A cross in sunburst crest inscription above the chamber.

TOGGLE: This model should have the new type toggle, with the flat, checkered toggle knobs.



BARREL: This model should have a 4-inch (100mm) barrel. It should be chambered for 9mm Parabellum.

FRAME: The frame on this model should be the late, short type with a stock lug, wide trigger and narrow trigger guard. It should be marked with a Siamese Police Lion's Head seal on the rear of the frame above the lanyard loop.

RECEIVER: The receiver on this model should be the late, short type. The chamber should be marked with a four-digit year date of 1936 or 1937.

THUMB SAFETY: The thumb safety on this model should have a serrated safety lever. The lower position is marked "GESICHERT." Safe is in the upper position.

SIGHTS: The front sight on this model should be a dorsal fin shaped blade, dovetail fit on the barrel. The rear sight should be a fixed V notch in the rear toggle link.

EXTRACTOR: The extractor on this model should be the late type. It should be marked "GELADEN" on the left side.

GRIPS: The grips on this model should be checkered walnut.

MAGAZINE: The magazines original to this model should have a tin-plated, wrap-around body with an aluminum base. They should not be proof marked or serial numbered.

FINISH: The main finish on this model should be a salt blue. The ejector, magazine catch/release, takedown lever, thumb safety lever and trigger should all be straw colored.

SERIAL NUMBER RANGE: 4040 v to 4600 v.

SERIAL NUMBER LOCATION: The full serial number is found on the bottom of the barrel, the front of the frame, and the left side of the receiver. The last two digits of the serial number are on the breechblock (lower left side), extractor, front toggle link (bottom), rear toggle link (back), sear (left side), sear bar safety lever, side plate, takedown lever (bottom), thumb safety lever (top), trigger (top left), and grips (inside).

INTERESTING VARIATIONS

There are no notable variations of this model.

MARKINGS

MARK **LOCATION/DESCRIPTION**



Toggle
Manufacturer's Logo



Receiver
Mauser Commercial Proof

VALUES

POOR	FAIR	GOOD	VG	EXC
\$1,800	\$2,250	\$3,500	\$4,800	\$6,000

Look-Up Index # 143

MAUSER SIAMESE, ARTILLERY

BACKGROUND

The Mauser Siamese, Artillery model was made specifically for military contract sales to Siam (Iraq).

HOW TO TELL A MAUSER SIAMESE, ARTILLERY

The Mauser Siamese, Artillery can be distinguished from other Lugers by three features in combination.

1. The Mauser logo banner inscription on the toggle.
2. Lion's head seal on the rear frame above the lanyard loop.
3. 8-inch barrel.

QUANTITY MADE

Approximately 100.

RARITY RATING

8, Extremely rare.

FEATURES IN DEPTH

MANUFACTURER: This model was manufactured by Mauser Werke, Oberndorf.

TOGGLE: This model should have the new type toggle, with the flat, checkered toggle knobs.



BARREL: This model should have a 8"(200 mm) barrel. It should be chambered for 9mm Parabellum.

FRAME: The frame on this model should be the late, short type with a stock lug, wide trigger and narrow trigger guard. It should be marked with a Siamese Police Lion's Head seal on the rear of the frame above the lanyard loop.

RECEIVER: The receiver on this model should be the late, short type. The chamber should be marked with the four-digit year date 1936.

THUMB SAFETY: The thumb safety on this model should have a serrated safety lever. The lower position is marked "GESICHERT." Safe is in the upper position.

SIGHTS: The front sight on this model should be a dorsal fin shaped blade, dovetail fit on the barrel. The rear sight should be a nine-position adjustable V notch located on the barrel just forward of the chamber.

EXTRACTOR: The extractor on this model should be the late type. It should be marked "GELADEN" on the left side.

GRIPS: The grips on this model should be checkered walnut.

MAGAZINE: The magazines original to this model should have a tin-plated, wrap-around body with an aluminum base. They should not be proof marked or serial numbered.

FINISH: The main finish on this model should be a salt blue. The ejector, magazine catch/release, takedown lever, thumb safety lever and trigger should all be straw colored.

SERIAL NUMBER RANGE: 3450 v to 3550 v.

SERIAL NUMBER LOCATION: The full serial number is found on the bottom of the barrel, the front of the frame, and the left side of the receiver. The last two digits of the serial number are on the breechblock (lower left side), extractor, front toggle link (bottom), rear toggle link (back), sear (left side), sear bar safety lever, side plate, takedown lever (bottom), thumb safety lever (top), trigger (top left), and grips (inside).

INTERESTING VARIATIONS

There are no notable variations of this model.

MARKINGS

MARK	LOCATION/DESCRIPTION
------	----------------------



Toggle
Manufacturer's Logo



Receiver
Mauser Commercial Proof

VALUES

POOR	FAIR	GOOD	VG	EXC
\$1,800	\$2,250	\$3,500	\$4,800	\$6,000

Look-Up Index # 144

MAUSER BANNER GRIP SAFETY COMMERCIAL

BACKGROUND

The Mauser Banner grip safety Commercial model was made specifically commercial sales. This model is sometimes referred to as the 1934/06 Mauser Commercial, owing to the 1906 feature pattern of no stock lug and a grip safety.

HOW TO TELL A MAUSER BANNER GRIP SAFETY COMMERCIAL

The Mauser Banner grip safety Commercial can be distinguished from other Lugers by three features in combination.

1. Toggle has the Mauser banner logo inscription.
2. Has a grip safety.
3. Has a blank chamber.

QUANTITY MADE

Approximately 100.

RARITY RATING

8, Extremely rare.

FEATURES IN DEPTH

MANUFACTURER: This model was manufactured by Mauser Werke, Oberndorf.

TOGGLE: This model should have the new type toggle, with the flat, checkered toggle knobs.

TOGGLE MARK:



BARREL: This model should have a 4-inch (100mm) barrel. It should be chambered for 9mm Parabellum.

FRAME: The frame on this model should be the late, long type with a grip safety, wide trigger and narrow trigger guard.

RECEIVER: The receiver on this model should be the late, long type. The chamber should be blank.

THUMB SAFETY: The thumb safety on this model should have a serrated safety lever. The lower position is polished (not blued). Safe is in the upper position.

SIGHTS: The front sight on this model should be a saw tooth shaped blade, dovetail fit on the barrel. The rear sight should be a fixed V notch in the rear toggle link.

EXTRACTOR: The extractor on this model should be the late type. It should be marked "GELADEN" on the left side.

GRIPS: The grips on this model should be checkered walnut. The left grip should be slotted for the grip safety.

MAGAZINE: The magazines original to this model should have a tin-plated, wrap-around body with an aluminum base. They should not be proof marked or serial numbered.

FINISH: The main finish on this model should be a high-quality rust blue. The ejector, magazine catch/release, takedown lever, thumb safety lever and trigger should all be straw colored.

SERIAL NUMBER RANGE: In the 3700 v range.

SERIAL NUMBER LOCATION: The full serial number is found on the bottom of the barrel, the front of the frame, and the left side of the receiver. The last two digits of the serial number are on the breechblock (lower left side), extractor, front toggle link (bottom), rear toggle link (back), sear (left side), sear bar safety lever, side plate, takedown lever (bottom), thumb safety lever (top), trigger (top left), grip safety (under grip) and grips (inside).

INTERESTING VARIATIONS

There are no notable variations of this model.

MARKINGS

MARK **LOCATION/DESCRIPTION**



Toggle
Manufacturer's Logo



Receiver
Nazi-era Commercial Proof

VALUES

POOR	FAIR	GOOD	VG	EXC
\$750	\$1,250	\$2,000	\$2,500	\$3,000

Look-Up Index # 145

MAUSER BANNER DATED

BACKGROUND

The Mauser Banner Dated model was generally made for commercial sales both within Germany and abroad.

HOW TO TELL A MAUSER BANNER DATED

The Mauser Banner Dated can be distinguished from other Lugers by four features in combination.

1. Toggle has the Mauser banner logo inscription.
2. Has NO grip safety.
3. Has a dated chamber, 1936 to 1942.
4. Mauser Crown/U commercial proof marked.

QUANTITY MADE

A few thousand.

RARITY RATING

3, Uncommon.

FEATURES IN DEPTH

MANUFACTURER: This model was manufactured by Mauser Werke, Oberndorf.

TOGGLE: This model should have the new type toggle, with the flat, checkered toggle knobs.

TOGGLE MARK: 

BARREL: This model should have a 4-inch (100mm) barrel. It should be chambered for 9mm Parabellum.

FRAME: The frame on this model should be the late, short type with a stock lug, wide trigger and narrow trigger guard. Some marked "P.08" on the left side, near the thumb safety.

RECEIVER: The receiver on this model should be the late, short type. The chamber should a four-digit year date from 1936 to 1942.

THUMB SAFETY: The thumb safety on this model should have a serrated safety lever. The upper position is marked "GESICHERT." Safe is in the lower position.

SIGHTS: The front sight on this model should be a dorsal fin shaped blade, dovetail fit on the barrel. The rear sight should be a fixed V notch in the rear toggle link.

EXTRACTOR: The extractor on this model should be the late type. It should be marked "GELADEN" on the left side.

SERIAL NUMBER RANGE: 7700 w to 9200 y range.

SERIAL NUMBER LOCATION: The full serial number is found on the bottom of the barrel, the front of the frame, and the left side of the receiver. The last two digits of the serial number are on the breechblock (lower left side), extractor, front toggle link (bottom), rear toggle link (back), sear (left side), sear bar safety lever, side plate, takedown lever (bottom), thumb safety lever (top), trigger (top left), and grips (inside).

INTERESTING VARIATIONS

The majority of these were pulled from commercial inventory, military proofed and issued to German military forces. These are analogous to the commercial Model HP P.38 pistols which were waffenamt marked and used to fill military production quotas. The result is that the original commercial only proofed examples are the more rare.

MARKINGS

MARK LOCATION/DESCRIPTION



Toggle
Manufacturer's Logo



Receiver
Nazi-era Commercial Proof

VALUES

POOR	FAIR	GOOD	VG	EXC
\$800	\$1,000	\$1,500	\$2,800	\$3,500

Look-Up Index # 147

MAUSER BANNER DATED, GRIP SAFETY

BACKGROUND

The Mauser Banner Dated, grip safety model was generally made for commercial sales both within Germany and abroad. This is sometimes referred to as the 1934/06 Mauser Banner since it is built in the 1906 pattern.

HOW TO TELL A MAUSER BANNER DATED, GRIP SAFETY

The Mauser Banner Dated, grip safety can be distinguished from other Lugers by three features in combination.

1. Toggle has the Mauser banner logo inscription.
2. Has a grip safety.
3. The chamber is inscribed with a four-digit year date between 1937 and 1942.

QUANTITY MADE

Approximately 1,000.

RARITY RATING

7-8, Very rare to extremely rare.

FEATURES IN DEPTH

MANUFACTURER: This model was manufactured by Mauser Werke, Oberndorf.

TOGGLE: This model should have the new type toggle, with the flat, checkered toggle knobs.

TOGGLE MARK:



BARREL: This model should have a 4-inch (100mm) barrel. It should be chambered for 9mm Parabellum.

FRAME: The frame on this model should be the late, short type with a grip safety, wide trigger and narrow trigger guard.

RECEIVER: The receiver on this model should be the late, short type. The chamber should be dated 1937 to 1942.

THUMB SAFETY: The thumb safety on this model should have a serrated safety lever. The upper position is marked "GESICHERT." Safe is in the lower position.

SIGHTS: The front sight on this model should be a dorsal fin shaped blade, dovetail fit on the barrel. The rear sight should be a fixed V notch in the rear toggle link.

EXTRACTOR: The extractor on this model should be the late type. It should be marked "GELADEN" on the left side.

GRIPS: The grips on this model should be checkered walnut. The left grip should be slotted for the grip safety.

MAGAZINE: The magazines original to this model should have a tin-plated, wrap-around body with an aluminum base. They should not be proof marked or serial numbered.

FINISH: The main finish on this model should be a high-quality rust blue. The ejector, magazine catch/release, takedown lever, thumb safety lever and trigger should all be straw colored.

SERIAL NUMBER RANGE: 3800 v range. Occasionally found in the earlier s and t blocks as well.

SERIAL NUMBER LOCATION: The full serial number is found on the bottom of the barrel, the front of the frame, and the left side of the receiver. The last two digits of the serial number are on the breechblock (lower left side), extractor, front toggle link (bottom), rear toggle link (back), sear (left side), sear bar safety lever, side plate, takedown lever (bottom), thumb safety lever (top), trigger (top left), grip safety (under grip) and grips (inside).

INTERESTING VARIATIONS

There are no notable variations of this model.

MARKINGS

MARK LOCATION/DESCRIPTION



Toggle
Manufacturer's Logo



Receiver
Nazi-era Commercial Proof

VALUES

POOR	FAIR	GOOD	VG	EXC
\$750	\$1,250	\$1,500	\$3,000	\$4,500

Look-Up Index # 148

MAUSER BANNER SWEDISH MILITARY

BACKGROUND

The Mauser Banner Swedish Military model was made specifically for military contract sales to Sweden.

HOW TO TELL A MAUSER BANNER SWEDISH MILITARY

The Mauser Banner Swedish Military can be distinguished from other Lugers by three features in combination.

1. The Mauser logo banner inscription on the toggle.
2. Crown/U Mauser proof.
3. Dated 1938 or 1939.

QUANTITY MADE

Approximately 300 in 9mm Parabellum:
275 dated 1938.
25 dated 1939.
Approximately 30 in 7.65mm (all dated 1939).

RARITY RATING

7. Very rare.

FEATURES IN DEPTH

MANUFACTURER: This model was manufactured by Mauser Werke, Oberndorf.

TOGGLE: This model should have the new type toggle, with the flat, checkered toggle knobs.

TOGGLE MARK: 

BARREL: This model should have either a 4¾-inch (120mm) barrel chambered for 7.65mm (.30 Luger), or a 4-inch (100mm) barrel chambered for 9mm Parabellum.

FRAME: The frame on this model should be the late, short type with a stock lug, wide trigger and narrow trigger guard.

RECEIVER: The receiver on this model should be the late, short type. The chamber should be dated 1938 or 1939.

THUMB SAFETY: The thumb safety on this model should have a serrated safety lever. The upper position is marked "GESICHERT." Safe is in the lower position.

SIGHTS: The front sight on this model should be a dorsal fin shaped blade, dovetail fit on the barrel. The rear sight should be a fixed V notch in the rear toggle link.

EXTRACTOR: The extractor on this model should be the late type. It should be marked "GELADEN" on the left side.

GRIPS: The grips on this model should be checkered walnut.

MAGAZINE: The magazines original to this model should have a tin-plated, wrap-around body with an aluminum base. They should not be proof marked or serial numbered.

FINISH: The main finish on this model should be a high-quality rust blue. The ejector, magazine catch/release, takedown lever, thumb safety lever and trigger should all be straw colored.

SERIAL NUMBER RANGE: 5701 v to 6000 v.

SERIAL NUMBER LOCATION: The full serial number is found on the bottom of the barrel, the front of the frame, and the left side of the receiver. The last two digits of the serial number are on the breechblock (lower left side), extractor, front toggle link (bottom), rear toggle link (back), sear (left side), sear bar safety lever, side plate,

takedown lever (bottom), thumb safety lever (top), trigger (top left), and grips (inside).

INTERESTING VARIATIONS

There are no notable variations of this model.

MARKINGS

MARK	LOCATION/DESCRIPTION
	Toggle Manufacturer's Logo
	Receiver Nazi-era Commercial Proof

VALUES

POOR	FAIR	GOOD	VG	EXC
\$1,000	\$1,750	\$3,500	\$5,000	\$7,000

Look-Up Index # 149

MAUSER BANNER POLICE

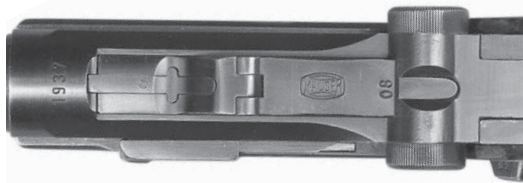

BACKGROUND

The Mauser Banner Police model was made specifically for paramilitary contract sales to German police forces.

HOW TO TELL A MAUSER BANNER POLICE

The Mauser Banner Police can be distinguished from other Lugers by four features in combination.

1. Toggle has the Mauser banner logo inscription.
2. Chamber dated from 1938 through 1942.
3. Police proof mark.

QUANTITY MADE

- 275 dated 1938.
- 7,400 dated 1939.
- 4,700 dated 1940.
- 5,915 dated 1941.
- 5,550 dated 1942.

RARITY RATING

3, Uncommon.

FEATURES IN DEPTH

MANUFACTURER: This model was manufactured by Mauser Werke, Oberndorf.

TOGGLE: This model should have the new type toggle, with the flat, checkered toggle knobs.

TOGGLE MARK: 

BARREL: This model should have a 4-inch (100mm) barrel. It should be chambered for 9mm Parabellum.

FRAME: The frame on this model should be the late, short type with a stock lug, wide trigger and narrow trigger guard.

RECEIVER: The receiver on this model should be the late, short type. The chamber should have a four-digit year date from 1939 through 1942.

THUMB SAFETY: The thumb safety on this model should have a serrated safety lever. The upper position is marked "GESICHERT." Safe is in the lower position.

SIGHTS: The front sight on this model should be a dorsal fin shaped blade, dovetail fit on the barrel. The rear sight should be a fixed V notch in the rear toggle link.

EXTRACTOR: The extractor on this model should be the late type. It should be marked "GELADEN" on the left side.

GRIPS: The grips on this model should be checkered walnut.

MAGAZINE: The magazines original to this model should have either a wrap-around body (tin-plated or chrome plated), or a blued extruded steel body. All varieties should have an aluminum base. They should be marked with a police acceptance eagle. Some are also marked "HAENEL SCHMEISSER." They should serial numbered to the pistol.

FINISH: The finish on this model should be a salt blue, including the small parts. No straw finish was used.

SERIAL NUMBER RANGE:

- 7000 v to 7275 v dated 1938.
- 7275 v to 770 x dated 1939.
- 1100 x to 5800 x dated 1940.
- 5801 x to 2340 y dated 1941.
- 2341 y to 8000 y dated 1942.

SERIAL NUMBER LOCATION: The full serial number is found on the bottom of the barrel, the front of the frame, and the left side of the receiver. The last two digits of the serial number are on the breechblock (lower left side), extractor, front toggle link (bottom), rear toggle link (back), sear (left side), sear bar safety lever, side plate, takedown lever (bottom), thumb safety lever (top), trigger (top left), and grips (inside).

INTERESTING VARIATIONS

There are no notable variations of this model.

MARKINGS

MARK **LOCATION/DESCRIPTION**



Toggle
Manufacturer's Logo



Receiver
Nazi-era Commercial Proof



Receiver
Police acceptance mark found
on 1938 - 1939 dates



Receiver
Police acceptance mark found
on 1939 dates



Receiver
Police acceptance mark found
on 1939 - 1940 dates



Receiver
Police acceptance mark found
on 1939 - 1942 dates

VALUES

POOR	FAIR	GOOD	VG	EXC
\$500	\$900	\$1,500	\$2,250	\$3,000

Look-Up Index # 150

MAUSER BANNER POLICE, TWO-DIGIT DATE

BACKGROUND

The Mauser Banner Police, Two-digit Date model was generally made for police and paramilitary use by Germany.

HOW TO TELL A MAUSER BANNER POLICE, TWO-DIGIT DATE

The Mauser Banner Police, Two-digit Date can be distinguished from other Lugers by three features in combination.

1. The Mauser logo banner inscription on the toggle.
2. The chamber has a two-digit year date inscription.
3. Eagle/K, F, C, or L police acceptance marked.

QUANTITY MADE

625 dated 41.
300 dated 42.

RARITY RATING

7, Very rare.

FEATURES IN DEPTH

MANUFACTURER: This model was manufactured by Mauser Werke, Oberndorf.

TOGGLE: This model should have the new type toggle, with the flat, checkered toggle knobs.

TOGGLE MARK: 

BARREL: This model should have a 4-inch (100mm) barrel. It should be chambered for 9mm Parabellum.

FRAME: The frame on this model should be the late, short type with a stock lug, wide trigger and narrow trigger guard.

RECEIVER: The receiver on this model should be the late, short type. The chamber should be marked with a two-digit year date of either 41 or 42.

THUMB SAFETY: The thumb safety on this model should have a serrated safety lever. The upper position is marked "GESICHERT." Safe is in the lower position.

SIGHTS: The front sight on this model should be a dorsal fin shaped blade, dovetail fit on the barrel. The rear sight should be a fixed V notch in the rear toggle link.

EXTRACTOR: The extractor on this model should be the late type. It should be marked "GELADEN" on the left side.

GRIPS: The grips on this model should be checkered walnut.

MAGAZINE: The magazines original to this model should have either a wrap-around body (tin-plated or chrome plated), or a blued extruded steel body. All varieties should have an aluminum base. They should be marked with a police acceptance eagle. Some are also marked "HAENEL SCHMEISSER." They should serial numbered to the pistol.

FINISH: The finish on this model should be a salt blue, including the small parts. No straw finish was used.

SERIAL NUMBER RANGE:

- 600 y to 1225 y dated 41.
- 8001 y to 8300 y dated 42.

SERIAL NUMBER LOCATION: The full serial number is found on the bottom of the barrel, the front of the frame, and the left side of the receiver. The last two digits of the serial number are on the breechblock (lower left side), extractor, front toggle link (bottom), rear toggle link (back), sear (left side), sear bar safety lever, side plate, takedown lever (bottom), thumb safety lever (top), trigger (top left), and grips (inside).

INTERESTING VARIATIONS

There are no notable variations of this model.

MARKINGS

MARK LOCATION/DESCRIPTION



Toggle
Manufacturer's Logo



Receiver
Nazi Commercial Test Proof



Receiver
Police acceptance mark found
on 1941 - 1942 dates

VALUES

POOR	FAIR	GOOD	VG	EXC
\$800	\$1,000	\$1,500	\$2,800	\$3,500

Look-Up Index # 151

MAUSER BANNER SWEDISH COMMERCIAL

BACKGROUND

The Mauser Banner Swedish Commercial model was generally made for commercial sales in Sweden.

HOW TO TELL A MAUSER BANNER SWEDISH

The Mauser Banner Swedish Commercial can be distinguished from other Lugers by four features in combination.

1. The Mauser logo banner inscription on the toggle.
2. Eagle/N proof.
3. Dated 1940.
4. 7.65mm.

QUANTITY MADE

Approximately 200.

RARITY RATING

7, Very rare.

FEATURES IN DEPTH

MANUFACTURER: This model was manufactured by Mauser Werke, Oberndorf.

TOGGLE: This model should have the new type toggle, with the flat, checkered toggle knobs.

TOGGLE MARK:



BARREL: This model should have a 3 7/8-inch (90mm) barrel chambered for 7.65mm (.30 Luger). It should be marked "Kal 7,65" on the left side.

FRAME: The frame on this model should be the late, short type with a stock lug, wide trigger and narrow trigger guard.

RECEIVER: The receiver on this model should be the late, short type. The chamber should be inscribed with four-digit year date stamp 1940.

THUMB SAFETY: The thumb safety on this model should have a serrated safety lever. The upper position is marked "GESICHERT." Safe is in the lower position.

SIGHTS: The front sight on this model should be a dorsal fin shaped blade, dovetail fit on the barrel. The rear sight should be a fixed V notch in the rear toggle link.

EXTRACTOR: The extractor on this model should be the late type. It should be marked "GELADEN" on the left side.

GRIPS: The grips on this model should be checkered walnut.

MAGAZINE: The magazines original to this model should have a tin-plated wrap-around body with an aluminum base. They should not be acceptance marked or serial numbered.

FINISH: The finish on these is a mixed bag. The frame and receiver is a rust blue (as expected). The barrel is a salt blue. There is the likelihood that those observed are rebarreled, and that the original ones were also rust blue. The ejector, magazine catch/release button,

takedown lever, thumb safety lever and trigger all straw colored.

SERIAL NUMBER RANGE: In the 7500 w to 7700 w range.

SERIAL NUMBER LOCATION: The full serial number is found on the bottom of the barrel, the front of the frame, and the left side of the receiver. The last two digits of the serial number are on the breechblock (lower left side), extractor, front toggle link (bottom), rear toggle link (back), sear (left side), sear bar safety lever, side plate, takedown lever (bottom), thumb safety lever (top), trigger (top left), and grips (inside).

INTERESTING VARIATIONS

There are no notable variations of this model.

MARKINGS

MARK	LOCATION/DESCRIPTION
	Toggle Manufacturer's Logo
	Receiver Nazi Commercial Test Proof

VALUES

POOR	FAIR	GOOD	VG	EXC
\$1,000	\$1,750	\$3,500	\$5,000	\$7,000

Look-Up Index # 152

MAUSER BANNER MILITARY

BACKGROUND

The Mauser Banner Military model represents a number of Mauser Banner-marked pistols that were accepted by the German military.

HOW TO TELL A MAUSER BANNER MILITARY

The Mauser Banner Military can be distinguished from other Lugers by three features in combination.

1. Toggle has the Mauser banner logo inscription.
2. Eagle/Swastika German military proof marked.
3. The thumb safety is marked "GESICHERT."

QUANTITY MADE

Approximately 500

RARITY RATING

7, Very rare.

FEATURES IN DEPTH

MANUFACTURER: This model was manufactured by Mauser Werke, Oberndorf.

TOGGLE: This model should have the new type toggle, with the flat, checkered toggle knobs.

TOGGLE MARK: 

BARREL: This model should have a 4-inch (100mm) barrel. It should be chambered for 9mm Parabellum.

FRAME: The frame on this model should be the late, short type with a stock lug, wide trigger and narrow trigger guard.

RECEIVER: The receiver on this model should be the late, short type. The chamber should be marked with a four-digit year date from 1939 through 1942. 1940 is the most common.

THUMB SAFETY: The thumb safety on this model should have a serrated safety lever. The upper position is marked "GESICHERT." Safe is in the lower position.

SIGHTS: The front sight on this model should be a dorsal fin shaped blade, dovetail fit on the barrel. The rear sight should be a fixed V notch in the rear toggle link.

EXTRACTOR: The extractor on this model should be the late type. It should be marked "GELADEN" on the left side.

GRIPS: The grips on this model should be checkered walnut. Some reported with brown plastic.

MAGAZINE: The magazines original to this model should have a blued, extruded steel body with an aluminum base.

FINISH: The finish on this model should be a salt blue, including the small parts. No straw finish was used.

SERIAL NUMBER RANGE: Mostly in the lower x suffix serial number block.

SERIAL NUMBER LOCATION: The full serial number is found on the bottom of the barrel, the front of the frame, and the left side of the receiver. The last two digits of the serial number are on the breechblock (lower left side), extractor, front toggle link (bottom), rear toggle link (back), sear (left side), sear bar safety lever, side plate, takedown lever (bottom), thumb safety lever (top), trigger (top left), and grips (inside).

INTERESTING VARIATIONS

There are isolated examples of this model dated 1938 in the v and n suffix blocks, with an E/63 acceptance mark. This is also one reported with a 41 date in the q block.

MARKINGS

MARK **LOCATION/DESCRIPTION**



Toggle
Manufacturer's Logo



Receiver (on late ones)
Military Test Fire Proof



Receiver
Military Acceptance Mark

VALUES

POOR	FAIR	GOOD	VG	EXC
\$800	\$1,500	\$2,500	\$4,000	\$6,000

Look-Up Index # 153

MAUSER PERSIAN



BACKGROUND

The Mauser Persian model was made specifically for military contract sales to Persia (Iran).

HOW TO TELL A MAUSER PERSIAN

The Mauser Persian can be distinguished from other Lugers by two features in combination.

1. Sanskrit marked toggle.
2. 4-inch barrel.

QUANTITY MADE

1,000 in 1936 and 1,000 in 1942.
2,000 total including the Persian artillery model.

RARITY RATING

7, Very rare.

FEATURES IN DEPTH

MANUFACTURER: This model was manufactured by Mauser Werke, Oberndorf.

TOGGLE: This model should have the new type toggle, with the flat, checkered toggle knobs.

TOGGLE MARK: *کشمیر*

BARREL: This model should have a 4-inch (100mm) barrel. It should be chambered for 9mm Parabellum.

FRAME: The frame on this model should be the late, short type with a stock lug, wide trigger and narrow trigger guard.



RECEIVER: The receiver on this model should be the late, short type. The chamber should be marked with the Persian crest of the Shah's Pahlavi Crown over a sword-wielding lion backed by a radiant sun.

THUMB SAFETY: The thumb safety on this model should have a serrated safety lever. The upper position is marked in Farsi. Safe is in the lower position.

SIGHTS: The front sight on this model should be a dorsal fin shaped blade, dovetail fit on the barrel. The rear sight should be a fixed V notch in the rear toggle link.

EXTRACTOR: The extractor on this model should be the late type. It should be marked in Farsi on the left side.

GRIPS: The grips on this model should be checkered walnut.

MAGAZINE: The magazines original to this model should have a tin-plated, wrap-around body with an aluminum base. They should not be proof marked or serial numbered.

FINISH: The main finish on this model should be a salt blue. The ejector, magazine catch/release, takedown lever, thumb safety lever and trigger should all be straw colored.



SERIAL NUMBER RANGE: 1 to four-digits in Farsi.

SERIAL NUMBER LOCATION: The full serial number (in Farsi) is found on the bottom of the barrel, the front of the frame, and the left side of the receiver. The last two digits (also in Farsi) of the serial number are on the breechblock (lower left side), extractor, front toggle link (bottom), rear toggle link (back), sear (left side), sear bar safety lever, side plate, takedown lever (bottom), thumb safety lever (top), trigger (top left), and grips (inside).

INTERESTING VARIATIONS

There are no notable variations of this model.

MARKINGS

MARK	LOCATION/DESCRIPTION
	Toggle Manufacturer's Name
	Receiver Mauser Commercial Proof

VALUES

POOR	FAIR	GOOD	VG	EXC
\$1,800	\$2,250	\$3,500	\$4,800	\$6,000

Look-Up Index # 154

MAUSER PERSIAN, ARTILLERY

BACKGROUND

The Mauser Persian, Artillery model was made specifically for military contract sales to Persia (Iran).

HOW TO TELL A MAUSER PERSIAN, ARTILLERY

The Mauser Persian, Artillery can be distinguished from other Lugers by two features in combination.

1. Sanskrit marked toggle.
2. 8-inch barrel.

QUANTITY MADE

1,000 in 1936 and 1,000 in 1942.
2,000 total including the Persian 4-inch barrel model.

RARITY RATING

7, Very rare.

FEATURES IN DEPTH

MANUFACTURER: This model was manufactured by Mauser Werke, Oberndorf.

TOGGLE: This model should have the new type toggle, with the flat, checkered toggle knobs.

TOGGLE MARK: 

BARREL: This model should have a 8-inch (200mm) barrel. It should be chambered for 9mm Parabellum.

FRAME: The frame on this model should be the late, short type with a stock lug, wide trigger and narrow trigger guard.



RECEIVER: The receiver on this model should be the late, short type. The chamber should be marked with the Persian crest of the Shah's Pahlavi

Crown over a sword-wielding lion backed by a radiant sun. The side of the receiver may also have this Farsi inscription.

THUMB SAFETY: The thumb safety on this model should have a serrated safety lever. The upper position is marked in Farsi. Safe is in the lower position.

SIGHTS: The front sight on this model should be a dorsal fin shaped blade, dovetail fit on the barrel. The rear sight should be a nine-position adjustable V notch located on the barrel just forward of the chamber.

EXTRACTOR: The extractor on this model should be the late type. It should be marked in Farsi on the left side.

GRIPS: The grips on this model should be checkered walnut.

MAGAZINE: The magazines original to this model should have a tin-plated, wrap-around body with an aluminum base. They should not be proof marked or serial numbered.

FINISH: The main finish on this model should be a salt blue. The ejector, magazine catch/release, takedown lever, thumb safety lever and trigger should all be straw colored.

SERIAL NUMBER RANGE: 1 to four-digits in Farsi.

SERIAL NUMBER LOCATION: The full serial number (in Farsi) is found on the bottom of the barrel, the front of the frame, and the left side of the receiver. The last two digits (also in Farsi) of the serial number are on the breechblock (lower left side), extractor, front toggle link (bottom), rear toggle link (back), sear (left side), sear bar safety lever, side plate, takedown lever (bottom), thumb safety lever (top), trigger (top left), and grips (inside).

INTERESTING VARIATIONS

There are no notable variations of this model.

MARKINGS

MARK	LOCATION/DESCRIPTION
	Toggle Manufacturer's Name
	Receiver Mauser Commercial Test Proof

VALUES

POOR	FAIR	GOOD	VG	EXC
\$1,000	\$1,250	\$1,750	\$2,800	\$3,500

Look-Up Index # 155

MAUSER TURKISH POLICE

BACKGROUND

The Mauser Turkish Police model was made specifically for contract sales to the Turkish police.

HOW TO TELL A MAUSER TURKISH POLICE

The Mauser Turkish Police can be distinguished from other Lugers by two features in combination.

1. Chamber marked with an intertwined "TC."
2. The right side of the receiver is marked "Emniyet Isleri Umum Müdürlüğü."

QUANTITY MADE

Between 500 and 1,000.

RARITY RATING

7, Very rare.

FEATURES IN DEPTH

MANUFACTURER: This model was manufactured by Mauser Werke, Oberndorf.

TOGGLE: This model should have the new type toggle, with the flat, checkered toggle knobs.

TOGGLE MARK: 

BARREL: This model should have a 4-inch (100mm) barrel. It should be chambered for 9mm Parabellum. Some are marked "Kal 9M/M" on the left side.

FRAME: The frame on this model should be the late, short type with a stock lug, wide trigger and narrow trigger guard.



RECEIVER: The receiver on this model should be the late, short type. The chamber should be marked

with an intertwined "TC" inscription. The right side the Turkish inscription "Emniyet Isleri Umum Müdürlüğü," which translates to "Security Department."

THUMB SAFETY: The thumb safety on this model should have a serrated safety lever. The upper position is marked "emniyet." Safe is in the lower position.

SIGHTS: The front sight on this model should be a dorsal fin shaped blade, dovetail fit on the barrel. The rear sight should be a fixed V notch in the rear toggle link.

EXTRACTOR: The extractor on this model should be the late type. It should be marked "ates" on the left side.

GRIPS: The grips on this model should be checkered walnut.

MAGAZINE: The magazines original to this model should have a tin-plated, wrap-around body with an aluminum base. They should not be proof marked or serial numbered.

FINISH: The main finish on this model should be a high-quality rust blue. The ejector, magazine catch/release, takedown lever, thumb safety lever and trigger should all be straw colored.

SERIAL NUMBER RANGE: 1 to 1000 (101, 128 and 628 reported).

SERIAL NUMBER LOCATION: The full serial number is found on the bottom of the barrel, the front of the frame, and the left side of the receiver. The last two digits of the serial number are on the breechblock (lower left side), extractor, front toggle link (bottom), rear toggle link (back), sear (left side), sear bar safety lever, side plate, takedown lever (bottom), thumb safety lever (top), trigger (top left), and grips (inside).

INTERESTING VARIATIONS

There are no notable variations of this model.

MARKINGS

MARK	LOCATION/DESCRIPTION
------	----------------------



Toggle
Manufacturer's Logo



Receiver
Mauser Commercial Test Proof



Receiver
Military Acceptance Stamp

or



Receiver
Military Acceptance Stamp

VALUES

POOR	FAIR	GOOD	VG	EXC
\$750	\$1,000	\$1,500	\$2,500	\$3,500

Look-Up Index # 156

MAUSER TURKISH ARMY



BACKGROUND

The Mauser Turkish Army model was made specifically for contract sales to the Turkish Army.

HOW TO TELL A MAUSER TURKISH ARMY

The Mauser Turkish Army can be distinguished from other Lugers by two features in combination.

1. Chamber marked with an intertwined "TC."
2. The right side of the receiver is marked "Subaylara mahsustur."

QUANTITY MADE

Estimated at 250.

RARITY RATING

7, Very rare.

FEATURES IN DEPTH

MANUFACTURER: This model was manufactured by Mauser Werke, Oberndorf.

TOGGLE: This model should have the new type toggle, with the flat, checkered toggle knobs.

TOGGLE MARK:



BARREL: This model should have a 4-inch (100mm) barrel. It should be chambered for 9mm Parabellum. Some are marked "Kal 9M/M" on the left side.

FRAME: The frame on this model should be the late, short type with a stock lug, wide trigger and narrow trigger guard.

RECEIVER: The receiver on this model should be the late, short type. The chamber should be marked with an intertwined "TC" inscription. The right side has another TC, a crescent and star, and the Turkish inscription "Subaylara mahsustur," which translates to "for Officer's use."

THUMB SAFETY: The thumb safety on this model should have a serrated safety lever. The upper position is marked "emniyet." Safe is in the lower position.

SIGHTS: The front sight on this model should be a dorsal fin shaped blade, dovetail fit on the barrel. The rear sight should be a fixed V notch in the rear toggle link.

EXTRACTOR: The extractor on this model should be the late type. It should be marked "ates" on the left side.

GRIPS: The grips on this model should be checkered walnut.

MAGAZINE: The magazines original to this model should have a tin-plated, wrap-around body with an aluminum base. They should not be proof marked or serial numbered.

FINISH: The main finish on this model should be a high-quality rust blue. The ejector, magazine catch/release, takedown lever, thumb safety lever and trigger should all be straw colored.

SERIAL NUMBER RANGE: 2100 v to 8750 v range.

SERIAL NUMBER LOCATION: The full serial number is found on the bottom of the barrel, the front of the frame, and the left side of the receiver. The last two digits of the serial number are on the breechblock (lower left side), extractor, front toggle link (bottom), rear toggle link (back), sear (left side), sear bar safety lever, side plate, takedown lever (bottom), thumb safety lever (top), trigger (top left), and grips (inside).

INTERESTING VARIATIONS

There are no notable variations of this model.

MARKINGS

MARK	LOCATION/DESCRIPTION
------	----------------------



	Toggle Manufacturer's Logo
--	-------------------------------



	Receiver Mauser Commercial Test Proof
--	--



	Receiver Military Acceptance Stamp
--	---------------------------------------

or



	Receiver Military Acceptance Stamp
--	---------------------------------------

VALUES

POOR	FAIR	GOOD	VG	EXC
\$750	\$1,000	\$1,500	\$2,500	\$3,500

Look-Up Index # 157

MAUSER TURKISH AIR FORCE

BACKGROUND

The Mauser Turkish Air Force model was made specifically for contract sales to the Turkish Air Force.

HOW TO TELL A MAUSER TURKISH AIR FORCE

The Mauser Turkish Air Force can be distinguished from other Lugers by two features in combination.

1. Chamber marked with an intertwined "TC."
2. The right side of the receiver is marked "Hava ordusuna mahsustur."

QUANTITY MADE

Less than 50.

RARITY RATING

8, Extremely rare.

FEATURES IN DEPTH

MANUFACTURER: This model was manufactured by Mauser Werke, Oberndorf.

TOGGLE: This model should have the new type toggle, with the flat, checkered toggle knobs.

TOGGLE MARK:



BARREL: This model should have a 4-inch (100mm) barrel. It should be chambered for 9mm Parabellum. Some are marked "Kal 9M/M" on the left side.

FRAME: The frame on this model should be the late, short type with a stock lug, wide trigger and narrow trigger guard.

RECEIVER: The receiver on this model should be the late, short type. The chamber should be marked with an intertwined "TC" inscription. The right side the Turkish inscription "Hava ordusuna mahsustur," which translates to "for Air Force use."

THUMB SAFETY: The thumb safety on this model should have a serrated safety lever. The upper position is marked "emniyet." Safe is in the lower position.

SIGHTS: The front sight on this model should be a dorsal fin shaped blade, dovetail fit on the barrel. The

rear sight should be a fixed V notch in the rear toggle link.

EXTRACTOR: The extractor on this model should be the late type. It should be marked "ates" on the left side.

GRIPS: The grips on this model should be checkered walnut.

MAGAZINE: The magazines original to this model should have a tin-plated, wrap-around body with an aluminum base. They should not be proof marked or serial numbered.

FINISH: The main finish on this model should be a high-quality rust blue. The ejector, magazine catch/release, takedown lever, thumb safety lever and trigger should all be straw colored.

SERIAL NUMBER RANGE: 9000 v serial number range.

SERIAL NUMBER LOCATION: The full serial number is found on the bottom of the barrel, the front of the frame, and the left side of the receiver. The last two digits of the serial number are on the breechblock (lower left side), extractor, front toggle link (bottom), rear toggle link (back), sear (left side), sear bar safety lever, side plate, takedown lever (bottom), thumb safety lever (top), trigger (top left), and grips (inside).

INTERESTING VARIATIONS

There is an unnumbered prototype specimen of this model. Not much detail is known about it.

MARKINGS

<u>MARK</u>	<u>LOCATION/DESCRIPTION</u>
-------------	-----------------------------



Toggle
Manufacturer's Logo



Receiver
Mauser Commercial Test Proof

VALUES

POOR	FAIR	GOOD	VG	EXC
\$750	\$1,000	\$1,500	\$2,500	\$3,500

Look-Up Index # 158

MAUSER K DATE

BACKGROUND

The Mauser K Date model was made specifically for secret German military consumption. The date code

K represented the year 1934, during which Hitler was secretly beginning German rearming in violation of the Versailles Treaty. The date of manufacture was coded to keep the secret.

HOW TO TELL A MAUSER K DATE

The Mauser K Date can be distinguished from other Lugers by two features in combination.

1. S/42 inscription on the forward toggle link.
2. A large capital K inscription above the chamber.

QUANTITY MADE

Approximately 10,500, including approximately 300 Kriegsmarine accepted and marked P.08s.

RARITY RATING

6, Rare.

FEATURES IN DEPTH

MANUFACTURER: This model was manufactured by Mauser Werke, Oberndorf.

TOGGLE: This model should have the new type toggle, with the flat, checkered toggle knobs.

TOGGLE MARK: S/42, or S/42.

BARREL: This model should have a 4-inch (100mm) barrel. It should be chambered for 9mm Parabellum.

FRAME: The frame on this model should be the late, short type with a stock lug, wide trigger and narrow trigger guard.

RECEIVER: The receiver on this model should be the late, short type. The chamber should be marked with a capital letter "K."

THUMB SAFETY: The thumb safety on this model should have a serrated safety lever. The upper position is marked "GESICHERT." Safe is in the lower position.

SIGHTS: The front sight on this model should be a dorsal fin shaped blade, dovetail fit on the barrel. The rear sight should be a fixed V notch in the rear toggle link.

EXTRACTOR: The extractor on this model should be the late type. It should be marked "GELADEN" on the left side.

GRIPS: The grips on this model should be checkered walnut.

MAGAZINE: The magazines original to this model should have a tin-plated, wrap-around body with an aluminum base. They should be marked with an I-beam, droop-wing E/63, stick-wing E/63, or E/83 inspection mark. They should serial numbered to the pistol.

FINISH: The main finish on this model should be a salt blue. The ejector, magazine catch/release, takedown lever, thumb safety lever and trigger should all be straw colored.

SERIAL NUMBER RANGE:

- 001 to 1700 all script S marked.
- 1700 to 5250 mixed S marked.
- 5200 to 9100 all gothic S marked.
- 9100 to 930 a gothic S/42.

SERIAL NUMBER LOCATION: The full serial number is found on the bottom of the barrel, the front of the frame, and the left side of the receiver. The last two digits of the serial number are on the breechblock (lower left side), extractor, front toggle link (bottom), rear toggle link (back), sear (left side), sear bar safety lever, side plate, takedown lever (bottom), thumb safety lever (top), trigger (top left), and grips (inside).

INTERESTING VARIATIONS

Variations of this model are found with all script S, mixed gothic S and script S, and all gothic S marks.

Very rarely, one can encounter this model with Kriegsmarine (German Navy) proofs.

MARKINGS

MARK	LOCATION/DESCRIPTION
S/42	Toggle Manufacturer's Code
K	Chamber Date Code

A capital letter S is stamped on both toggle links, the side plate, the takedown lever, the sear bar safety lever, the right side of the receiver.

Following are variations of the inspection and acceptance marks found on the right forward portion of the receiver.

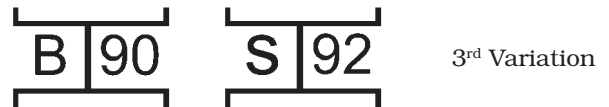
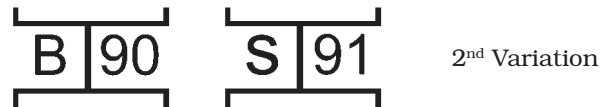

Receiver
Test Fire Proof

VALUES

POOR	FAIR	GOOD	VG	EXC
\$1,000	\$1,500	\$2,500	\$4,000	\$6,000

Look-Up Index # 159

MAUSER G DATE, EARLY ACCEPTANCE MARK



BACKGROUND

The Mauser G Date, Early Acceptance Mark model was made specifically for secret German military consumption. The date code G represented the year 1935, during which Hitler was continuing the secret German rearming in violation of the Versailles Treaty. The date of manufacture was coded to keep the secret.

HOW TO TELL A MAUSER G DATE, EARLY ACCEPTANCE MARK

The Mauser G Date, Early Acceptance Mark can be distinguished from other Lugers by two features in combination.

1. A large capital G inscription above the chamber.
2. I Beam type acceptance stamps.

QUANTITY MADE

Estimated at 34,000, including a portion of approximately 700 Kriegsmarine accepted and marked P.08s.

RARITY RATING

4, Scarce.

FEATURES IN DEPTH

MANUFACTURER: This model was manufactured by Mauser Werke, Oberndorf.

TOGGLE: This model should have the new type toggle, with the flat, checkered toggle knobs.

TOGGLE MARK: S/42

BARREL: This model should have a 4-inch (100mm) barrel. It should be chambered for 9mm Parabellum.

FRAME: The frame on this model should be the late, short type with a stock lug, wide trigger and narrow trigger guard.

RECEIVER: The receiver on this model should be the late, short type. The chamber should be marked with a capital letter "G."

THUMB SAFETY: The thumb safety on this model should have a serrated safety lever. The upper position is marked "GESICHERT." Safe is in the lower position.

SIGHTS: The front sight on this model should be a dorsal fin shaped blade, dovetail fit on the barrel. The rear sight should be a fixed V notch in the rear toggle link.

EXTRACTOR: The extractor on this model should be the late type. It should be marked "GELADEN" on the left side.

GRIPS: The grips on this model should be checkered walnut.

MAGAZINE: The magazines original to this model should have a tin-plated, wrap-around body with an aluminum base. They should be marked with an I-beam, droop-wing E/63, stick-wing E/63, or E/83 inspection mark. They should serial numbered to the pistol.

FINISH: The main finish on this model should be a salt blue. The ejector, magazine catch/release, takedown lever, thumb safety lever and trigger should all be straw colored.

SERIAL NUMBER RANGE: 930 a to 5000 d, I Beam proof.

SERIAL NUMBER LOCATION: The full serial number is found on the bottom of the barrel, the front of the frame, and the left side of the receiver. The last two digits of the serial number are on the breechblock (lower left side), extractor, front toggle link (bottom), rear toggle link (back), sear (left side), sear bar safety lever, side plate, takedown lever (bottom), thumb safety lever (top), trigger (top left), and grips (inside).

INTERESTING VARIATIONS

Very rarely, one can encounter this model with Kriegsmarine (German Navy) proofs in the d block.

MARKINGS

<u>MARK</u>	<u>LOCATION/DESCRIPTION</u>
S/42	Toggle Manufacturer's Code
K	Chamber Date Code

Following are variations of the inspection and acceptance marks found on the right forward portion of the receiver.



1st Variation



2nd Variation



3rd Variation



Receiver
Test Fire Proof

VALUES

POOR	FAIR	GOOD	VG	EXC
\$600	\$850	\$1,200	\$2,000	\$2,500

Look-Up Index # 160

MAUSER G DATE, MID ACCEPTANCE STAMP

BACKGROUND

The Mauser G Date, Early Acceptance Mark model was just a continuation of the previous model, but with a transitional mix of acceptance stamps.

HOW TO TELL A MAUSER G DATE, MID ACCEPTANCE MARK

The Mauser G Date, Mid Acceptance Mark can be distinguished from other Lugers by two features in combination.

1. A large capital G inscription above the chamber.
2. Mixed I Beam, E/211 acceptance stamps.

QUANTITY MADE

Less than 2,500, including a portion of the approximately 700 Kriegsmarine accepted and marked P.08s.

RARITY RATING

6, Rare.

FEATURES IN DEPTH

MANUFACTURER: This model was manufactured by Mauser Werke, Oberndorf.

TOGGLE: This model should have the new type toggle, with the flat, checkered toggle knobs.

TOGGLE MARK: S/42

BARREL: This model should have a 4-inch (100mm) barrel. It should be chambered for 9mm Parabellum.

FRAME: The frame on this model should be the late, short type with a stock lug, wide trigger and narrow trigger guard.

RECEIVER: The receiver on this model should be the late, short type. The chamber should be marked with a capital letter "G."

THUMB SAFETY: The thumb safety on this model should have a serrated safety lever. The upper position is marked "GESICHERT." Safe is in the lower position.

SIGHTS: The front sight on this model should be a dorsal fin shaped blade, dovetail fit on the barrel. The rear sight should be a fixed V notch in the rear toggle link.

EXTRACTOR: The extractor on this model should be the late type. It should be marked "GELADEN" on the left side.

GRIPS: The grips on this model should be checkered walnut.

MAGAZINE: The magazines original to this model should have a tin-plated, wrap-around body with an aluminum base. They should be marked with an I beam, droop-wing E/63, stick-wing E/63, or E/83 inspection mark. They should serial numbered to the pistol.

FINISH: The main finish on this model should be a salt blue. The ejector, magazine catch/release, takedown lever, thumb safety lever and trigger should all be straw colored.

SERIAL NUMBER RANGE: 5000 d to 9999 d.

SERIAL NUMBER LOCATION: The full serial number is found on the bottom of the barrel, the front of the frame, and the left side of the receiver. The last two digits of the serial number are on the breechblock (lower left side), extractor, front toggle link (bottom), rear toggle link (back), sear (left side), sear bar safety lever, side plate, takedown lever (bottom), thumb safety lever (top), trigger (top left), and grips (inside).

INTERESTING VARIATIONS

Very rarely, one can encounter this model with Kriegsmarine (German Navy) proofs.

MARKINGS

MARK **LOCATION/DESCRIPTION**

S/42

Toggle
Manufacturer's Code

G

Chamber
Date Code



Receiver
Army Acceptance
Inspection Mark



Receiver
Army Acceptance
Inspection Mark



Receiver
Test Fire Proof

VALUES

POOR	FAIR	GOOD	VG	EXC
\$600	\$850	\$1,200	\$2,000	\$2,500

Look-Up Index # 161

MAUSER G DATE, LATE ACCEPTANCE STAMP

BACKGROUND

The Mauser G Date, Late Acceptance Mark model was just a continuation of the previous model, but after the to a later acceptance stamps.

HOW TO TELL A MAUSER G DATE, LATE ACCEPTANCE MARK

The Mauser G Date, Late Acceptance Mark can be distinguished from other Lugers by two features in combination.

1. A large capital G inscription above the chamber.
2. Droop-wing E/63 acceptance marks.

QUANTITY MADE

Approximately 20,000, including a portion of the approximately 700 Kriegsmarine accepted and marked P.08s.

RARITY RATING

4, Scarce.

FEATURES IN DEPTH

MANUFACTURER: This model was manufactured by Mauser Werke, Oberndorf.

TOGGLE: This model should have the new type toggle, with the flat, checkered toggle knobs.

TOGGLE MARK: S/42

BARREL: This model should have a 4-inch (100mm) barrel. It should be chambered for 9mm Parabellum.

FRAME: The frame on this model should be the late, short type with a stock lug, wide trigger and narrow trigger guard.

RECEIVER: The receiver on this model should be the late, short type. The chamber should be marked with a capital letter "G."

THUMB SAFETY: The thumb safety on this model should have a serrated safety lever. The upper position is marked "GESICHERT." Safe is in the lower position.

SIGHTS: The front sight on this model should be a dorsal fin shaped blade, dovetail fit on the barrel. The rear sight should be a fixed V notch in the rear toggle link.

EXTRACTOR: The extractor on this model should be the late type. It should be marked "GELADEN" on the left side.

GRIPS: The grips on this model should be checkered walnut.

MAGAZINE: The magazines original to this model should have a tin-plated, wrap-around body with an aluminum base. They should be marked with a droop-wing E/63, stick-wing E/63, or an E/83. They should serial numbered to the pistol.

FINISH: The main finish on this model should be a salt blue. The ejector, magazine catch/release, takedown lever, thumb safety lever and trigger should all be straw colored.

SERIAL NUMBER RANGE: 5000 d to 5000 f.

SERIAL NUMBER LOCATION: The full serial number is found on the bottom of the barrel, the front of the frame, and the left side of the receiver. The last two digits of the serial number are on the breechblock (lower left side), extractor, front toggle link (bottom), rear toggle link (back), sear (left side), sear bar safety lever, side plate, takedown lever (bottom), thumb safety lever (top), trigger (top left), and grips (inside).

INTERESTING VARIATIONS

Very rarely, one can encounter this model with Kriegsmarine (German Navy) proofs in the d, e, and f blocks.

MARKINGS

MARK **LOCATION/DESCRIPTION**

S/42

Toggle
Manufacturer's Code

G

Chamber
Date Code



Receiver
Military Inspection
Acceptance Mark



Receiver
Test Fire Proof

VALUES

POOR	FAIR	GOOD	VG	EXC
\$600	\$850	\$1,200	\$2,000	\$2,500

Look-Up Index # 162

MAUSER S/42 1936 DATE

BACKGROUND

The Mauser S/42 1936 Date model was made specifically for military sales to Germany.

HOW TO TELL A MAUSER S/42 1936 DATE

The Mauser S/42 1936 date can be distinguished from other Lugers by four features in combination.

1. S/42 inscription on the forward toggle link.
2. The chamber has a four-digit year date 1936.
3. No sear safety.
4. No Kriegsmarine property number on the grip strap.

QUANTITY MADE

89,500.

RARITY RATING

2, Common.

FEATURES IN DEPTH

MANUFACTURER: This model was manufactured by Mauser Werke, Oberndorf.

TOGGLE: This model should have the new type toggle, with the flat, checkered toggle knobs.

TOGGLE MARK: S/42

BARREL: This model should have a 4-inch (100mm) barrel. It should be chambered for 9mm Parabellum.

FRAME: The frame on this model should be the late, short type with a stock lug, wide trigger and narrow trigger guard.

RECEIVER: The receiver on this model should be the late, short type. The chamber should have a four-digit year date of 1936.

THUMB SAFETY: The thumb safety on this model should have a serrated safety lever. The upper position is marked "GESICHERT." Safe is in the lower position.

SIGHTS: The front sight on this model should be a dorsal fin shaped blade, dovetail fit on the barrel. The rear sight should be a fixed V notch in the rear toggle link.

EXTRACTOR: The extractor on this model should be the late type. It should be marked "GELADEN" on the left side.

GRIPS: The grips on this model should be checkered walnut.

MAGAZINE: The magazines original to this model should have a blued (tin-plated up through the "m" serial number block), wrap-around body with an aluminum base. They should be marked with a droop-wing E/63, stick-wing E/63, or E/83. They should serial numbered to the pistol.

FINISH: The main finish on this model should be a salt blue. The ejector, magazine catch/release, takedown lever, thumb safety lever and trigger should all be straw colored.

SERIAL NUMBER RANGE: 5000 f to 4500 p.

SERIAL NUMBER LOCATION: The full serial number is found on the bottom of the barrel, the front of the frame, and the left side of the receiver. The last two digits of the serial number are on the breechblock (lower left side), extractor, front toggle link (bottom), rear toggle link (back), sear (left side), sear bar safety lever, side plate, takedown lever (bottom), thumb safety lever (top), trigger (top left), and grips (inside).

INTERESTING VARIATIONS

There are no notable variations of this model.

MARKINGS

MARK **LOCATION/DESCRIPTION**

S/42

Toggle
Manufacturer's Code



Receiver
Military Inspection
Acceptance Mark



Receiver
Test Fire Proof

or



Receiver
Test Fire Proof

VALUES

POOR	FAIR	GOOD	VG	EXC
\$500	\$750	\$1,000	\$1,500	\$2,000

Look-Up Index # 163

MAUSER S/42 1937 DATE, EARLY FINISH

BACKGROUND

The Mauser S/42 1937 Date, Early Finish model was made specifically for military sales to Germany.

HOW TO TELL A MAUSER S/42 1937 DATE, EARLY FINISH

The Mauser S/42 1937 Date, Early Finish can be distinguished from other Lugers by four features in combination.

1. S/42 inscription on the forward toggle link.
2. The chamber has a four-digit year date 1937.
3. The trigger, thumb safety, and take down lever are strawed.
4. No Kriegsmarine property number on the grip strap.

QUANTITY MADE

37,000.

RARITY RATING

2, Common.

FEATURES IN DEPTH

MANUFACTURER: This model was manufactured by Mauser Werke, Oberndorf.

TOGGLE: This model should have the new type toggle, with the flat, checkered toggle knobs.

TOGGLE MARK: S/42

BARREL: This model should have a 4-inch (100mm) barrel. It should be chambered for 9mm Parabellum.

FRAME: The frame on this model should be the late, short type with a stock lug, wide trigger and narrow trigger guard.

RECEIVER: The receiver on this model should be the late, short type. The chamber should have a four-digit year date of 1937.

THUMB SAFETY: The thumb safety on this model should have a serrated safety lever. The upper position is marked "GESICHERT." Safe is in the lower position.

SIGHTS: The front sight on this model should be a dorsal fin shaped blade, dovetail fit on the barrel. The rear sight should be a fixed V notch in the rear toggle link.

EXTRACTOR: The extractor on this model should be the late type. It should be marked "GELADEN" on the left side.

GRIPS: The grips on this model should be checkered walnut.

MAGAZINE: The magazines original to this model should have a blued wrap-around body with an aluminum base. They should be marked with a droop-wing E/63, stick-wing E/63, or E/83. They should serial numbered to the pistol.

FINISH: The main finish on this model should be a salt blue. The ejector, magazine catch/release, takedown lever, thumb safety lever and trigger should all be straw colored.

SERIAL NUMBER RANGE: 4501 p to 1500 t.

SERIAL NUMBER LOCATION: The full serial number is found on the bottom of the barrel, the front of the frame, and the left side of the receiver. The last two digits of the serial number are on the breechblock (lower left side), extractor, front toggle link (bottom), rear toggle link (back), sear (left side), sear bar safety lever, side plate, takedown lever (bottom), thumb safety lever (top), trigger (top left), and grips (inside).

INTERESTING VARIATIONS

There are no notable variations of this model.

MARKINGS

MARK	LOCATION/DESCRIPTION
-------------	-----------------------------

S/42

Toggle
Manufacturer's Code



Receiver
Military Inspection
Acceptance Mark

and/or



Receiver
Military Inspection
Acceptance Mark



Receiver
Test Fire Proof

VALUES

POOR	FAIR	GOOD	VG	EXC
\$500	\$750	\$1,000	\$1,500	\$2,000

Look-Up Index # 164

MAUSER S/42, EARLY FINISH, KRIEGSMARINE

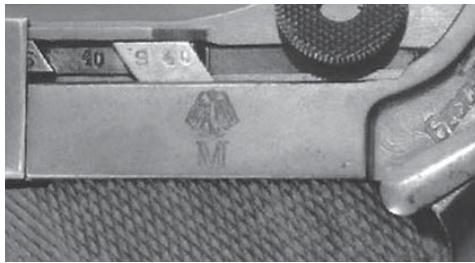

BACKGROUND

The Mauser S/42 Early Finish, Kriegsmarine model was made specifically for military sales to Germany. The pistols of this variation were marked and issued by the Kriegsmarine.

HOW TO TELL A MAUSER S/42 EARLY FINISH, KRIEGSMARINE

The Mauser S/42 Early Finish Kriegsmarine can be distinguished from other Lugers by four features in combination.

1. S/42 inscription on the forward toggle link.
2. The chamber has either a letter code date of K or G, or a four-digit year date of 1936 or 1937.
3. The trigger, thumb safety, and take down lever are strawed.
4. O. or N. property number on the grip strap.

QUANTITY MADE

1936 approximately 1,000.
1937 a few hundred.

RARITY RATING

7, Very rare.

FEATURES IN DEPTH

MANUFACTURER: This model was manufactured by Mauser Werke, Oberndorf.

TOGGLE: This model should have the new type toggle, with the flat, checkered toggle knobs.

TOGGLE MARK: S/42

BARREL: This model should have a 4-inch (100mm) barrel. It should be chambered for 9mm Parabellum.

FRAME: The frame on this model should be the late, short type with a stock lug, wide trigger and narrow trigger guard.

RECEIVER: The receiver on this model should be the late, short type. The chamber should have either a letter code date of K or G, or a four-digit year date of 1936 or 1937.

THUMB SAFETY: The thumb safety on this model should have a serrated safety lever. The upper position is marked "GESICHERT." Safe is in the lower position.

SIGHTS: The front sight on this model should be a dorsal fin shaped blade, dovetail fit on the barrel. The rear sight should be a fixed V notch in the rear toggle link.

EXTRACTOR: The extractor on this model should be the late type. It should be marked "GELADEN" on the left side.

GRIPS: The grips on this model should be checkered walnut.

MAGAZINE: The magazines original to this model should have a tin-plated, wrap-around body with an aluminum base. They should be marked with a droop-wing E/63 or stick-wing E/63. They should serial numbered to the pistol.

FINISH: The main finish on this model should be a salt blue. The ejector, magazine catch/release, takedown lever, thumb safety lever and trigger should all be straw colored.

SERIAL NUMBER RANGE:



1936 in the l and m blocks.
1937 in the r, s and early t blocks.

SERIAL NUMBER LOCATION: The full serial number is found on the bottom of the barrel, the front of the frame, and the left side of the receiver. The last two digits of the serial number are on the breechblock (lower left side), extractor, front toggle link (bottom), rear toggle link (back), sear (left side), sear bar safety lever, side plate, takedown lever (bottom), thumb safety lever (top), trigger (top left), and grips (inside).

INTERESTING VARIATIONS

There are no notable variations of this model.

MARKINGS

MARK	LOCATION/DESCRIPTION
S/42	Toggle Manufacturer's Code
	Receiver Military Inspection Acceptance Mark
	Receiver Test Fire Proof
or	
	Receiver Test Fire Proof
N. Number	Grip Strap Nordsee Fleet Inventory Number
O. Number	Grip Strap Ostsee Fleet Inventory Number

VALUES

POOR	FAIR	GOOD	VG	EXC
\$900	\$1,250	\$2,000	\$2,750	\$3,500

Look-Up Index # 165

MAUSER S/42 EARLY FINISH, POLICE

BACKGROUND

The Mauser S/42 Early Finish, Police model was by all indication made for military consumption. Only the presence of both a sear safety and magazine safety gives this model its police association.

HOW TO TELL A MAUSER S/42 EARLY FINISH, POLICE

The Mauser S/42 Early Finish, Police can be distinguished from other Lugers by three features in combination.

1. S/42 inscription on the forward toggle link.
2. The chamber has either a letter code date of K or G, or a four-digit year date of 1936 or 1937.
3. Sear safety.

QUANTITY MADE

Approximately 600 dated 1935 (G Date).
Approximately 200 dated 1936.

RARITY RATING

7, Very rare.

FEATURES IN DEPTH

MANUFACTURER: This model was manufactured by Mauser Werke, Oberndorf.

TOGGLE: This model should have the new type toggle, with the flat, checkered toggle knobs.

TOGGLE MARK: S/42

BARREL: This model should have a 4-inch (100mm) barrel. It should be chambered for 9mm Parabellum.

FRAME: The frame on this model should be the late, short type with a stock lug, wide trigger and narrow trigger guard.

RECEIVER: The receiver on this model should be the late, short type, with a sear safety. The chamber has either a letter code date of K or G, or a four-digit year date of 1936 or 1937.

THUMB SAFETY: The thumb safety on this model should have a serrated safety lever. The upper position is marked "GESICHERT." Safe is in the lower position.

SIGHTS: The front sight on this model should be a dorsal fin shaped blade, dovetail fit on the barrel. The rear sight should be a fixed V notch in the rear toggle link.

EXTRACTOR: The extractor on this model should be the late type. It should be marked "GELADEN" on the left side.

GRIPS: The grips on this model should be checkered walnut.

MAGAZINE: The magazines original to this model should have a tin-plated, wrap-around body with an aluminum base. They should be marked with a droop-wing E/63 or stick-wing E/63. They should serial numbered to the pistol.

FINISH: The main finish on this model should be a salt blue. The ejector, magazine catch/release, takedown lever, thumb safety lever and trigger should all be straw colored.

SERIAL NUMBER RANGE: 6000 g range in 1936.

SERIAL NUMBER LOCATION: The full serial number is found on the bottom of the barrel, the front of the frame, and the left side of the receiver. The last two digits of the serial number are on the breechblock (lower left side), extractor, front toggle link (bottom), rear toggle link (back), sear (left side), sear bar safety lever, side plate, takedown lever (bottom), thumb safety lever (top), trigger (top left), and grips (inside).

INTERESTING VARIATIONS

There are no notable variations of this model.

MARKINGS

MARK **LOCATION/DESCRIPTION**

S/42

Toggle
Manufacturer's Code



Receiver
Military Inspection
Acceptance Mark



Receiver
Test Fire Proof

or



Receiver
Test Fire Proof

VALUES

POOR	FAIR	GOOD	VG	EXC
\$500	\$750	\$1,000	\$1,500	\$2,000

Look-Up Index # 166

MAUSER S/42 1937 DATE, LATE FINISH



BACKGROUND

The Mauser S/42 1937 Date, Late Finish model was made specifically for military sales to Germany.

HOW TO TELL A MAUSER S/42 1937 DATE, LATE FINISH

The Mauser S/42 1937 Date, Late Finish can be distinguished from other Lugers by three features in combination.

1. S/42 inscription on the forward toggle link.
2. The chamber has a four-digit year date 1937.
3. The trigger, thumb safety, and take down lever are blued.

QUANTITY MADE

89,000.

RARITY RATING

3, Uncommon.

FEATURES IN DEPTH

MANUFACTURER: This model was manufactured by Mauser Werke, Oberndorf.

TOGGLE: This model should have the new type toggle, with the flat, checkered toggle knobs.

TOGGLE MARK: S/42

BARREL: This model should have a 4-inch (100mm) barrel. It should be chambered for 9mm Parabellum.

FRAME: The frame on this model should be the late, short type with a stock lug, wide trigger and narrow trigger guard.

RECEIVER: The receiver on this model should be the late, short type. The chamber should be dated 1937.

THUMB SAFETY: The thumb safety on this model should have a serrated safety lever. The upper position is marked "GESICHERT." Safe is in the lower position.

SIGHTS: The front sight on this model should be a dorsal fin shaped blade, dovetail fit on the barrel. The rear sight should be a fixed V notch in the rear toggle link.

EXTRACTOR: The extractor on this model should be the late type. It should be marked "GELADEN" on the left side.

GRIPS: The grips on this model should be checkered walnut.

MAGAZINE: The magazines original to this model should have a blued, wrap-around body with an aluminum base. They should be marked with a droop-wing E/63 or stick-wing E/63. They should serial numbered to the pistol.

FINISH: The finish on this model should be a salt blue, including the small parts. No straw finish was used.

SERIAL NUMBER RANGE: 1501 t to 400 b.



SERIAL NUMBER LOCATION: The full serial number is found on the bottom of the barrel, the front of the frame,

and the left side of the receiver. The last two digits of the serial number are on the breechblock (lower left side), extractor, front toggle link (bottom), rear toggle link (back), sear (left side), sear bar safety lever, side plate, takedown lever (bottom), thumb safety lever (top), trigger (top left), and grips (inside).

INTERESTING VARIATIONS

One 1937 dated example is reported with a sear safety. More examples would need to be discovered to make this more than a singular anomaly.

MARKINGS

MARK	LOCATION/DESCRIPTION
S/42	Toggle Manufacturer's Code
	Receiver Military Inspection Acceptance Mark
and/or	
	Receiver Military Inspection Acceptance Mark
	Receiver Test Fire Proof

VALUES

POOR	FAIR	GOOD	VG	EXC
\$500	\$750	\$1,000	\$1,500	\$2,000

Look-Up Index # 167

MAUSER S/42 1938 DATED

BACKGROUND

The Mauser S/42 1938 Date model was made specifically for military sales to Germany.

HOW TO TELL A MAUSER S/42 1938 DATE

The Mauser S/42 1938 Date can be distinguished from other Lugers by three features in combination.

1. S/42 inscription on the forward toggle link.
2. The chamber has a four-digit year date 1938.
3. No Kriegsmarine property number on the grip strap.

QUANTITY MADE

113,800.

RARITY RATING

3, Uncommon.

FEATURES IN DEPTH

MANUFACTURER: This model was manufactured by Mauser Werke, Oberndorf.

TOGGLE: This model should have the new type toggle, with the flat, checkered toggle knobs.

TOGGLE MARK: S/42

BARREL: This model should have a 4-inch (100mm) barrel. It should be chambered for 9mm Parabellum.

FRAME: The frame on this model should be the late, short type with a stock lug, wide trigger and narrow trigger guard.

RECEIVER: The receiver on this model should be the late, short type. The chamber should be dated 1938.

THUMB SAFETY: The thumb safety on this model should have a serrated safety lever. The upper position is marked "GESICHERT." Safe is in the lower position.

SIGHTS: The front sight on this model should be a dorsal fin shaped blade, dovetail fit on the barrel. The rear sight should be a fixed V notch in the rear toggle link.

EXTRACTOR: The extractor on this model should be the late type. It should be marked "GELADEN" on the left side.

GRIPS: The grips on this model should be checkered walnut.

MAGAZINE: The magazines original to this model should have a blued, wrap-around body with an aluminum base. They should be marked with a stick-wing E/63 or E/83. They should serial numbered to the pistol.

FINISH: The finish on this model should be a salt blue, including the small parts. No straw finish was used.

SERIAL NUMBER RANGE: 401 b to 4500 n.

SERIAL NUMBER LOCATION: The full serial number is found on the bottom of the barrel, the front of the frame, and the left side of the receiver. The last two digits of the serial number are on the breechblock (lower left side), extractor, front toggle link (bottom), rear toggle link (back), sear (left side), sear bar safety lever, side plate, takedown lever (bottom), thumb safety lever (top), trigger (top left), and grips (inside).

INTERESTING VARIATIONS

There are no notable variations of this model.

MARKINGS

MARK **LOCATION/DESCRIPTION**

S/42 Toggle
Manufacturer's Code

63 Receiver
Military Inspection
Acceptance Mark

and/or

83 Receiver
Military Inspection
Acceptance Mark

Receiver
Test Fire Proof

VALUES

POOR	FAIR	GOOD	VG	EXC
\$500	\$750	\$1,000	\$1,500	\$2,000

Look-Up Index # 168

MAUSER S/42 1939 DATED, EARLY PROOF

BACKGROUND

The Mauser S/42 1939 Date, Early Proof model was made specifically for military sales to Germany.

HOW TO TELL A MAUSER S/42 1939 DATE, EARLY PROOF

The Mauser S/42 1939 Date, Early Proof can be distinguished from other Lugers by five features in combination.

1. S/42 inscription on the forward toggle link.
2. The chamber has a four-digit year date between 1939.
3. Serial number below the r block.
4. No sear safety.
5. No Kriegsmarine property number on the grip strap.

QUANTITY MADE

32,500.

RARITY RATING

3, Uncommon.

FEATURES IN DEPTH

MANUFACTURER: This model was manufactured by Mauser Werke, Oberndorf.

TOGGLE: This model should have the new type toggle, with the flat, checkered toggle knobs.

TOGGLE MARK: S/42

BARREL: This model should have a 4-inch (100mm) barrel. It should be chambered for 9mm Parabellum.

FRAME: The frame on this model should be the late, short type with a stock lug, wide trigger and narrow trigger guard.

RECEIVER: The receiver on this model should be the late, short type. The chamber should be dated 1939.

THUMB SAFETY: The thumb safety on this model should have a serrated safety lever. The upper position is marked "GESICHERT." Safe is in the lower position.

SIGHTS: The front sight on this model should be a dorsal fin shaped blade, dovetail fit on the barrel. The rear sight should be a fixed V notch in the rear toggle link.

EXTRACTOR: The extractor on this model should be the late type. It should be marked "GELADEN" on the left side.

GRIPS: The grips on this model should be checkered walnut.

MAGAZINE: The magazines original to this model should have a blued, wrap-around body with an aluminum base. They should be marked with a stick-wing E/63 or E/83. They should serial numbered to the pistol.

FINISH: The finish on this model should be a salt blue, including the small parts. No straw finish was used.

SERIAL NUMBER RANGE: 4501 n to 10000 q.

SERIAL NUMBER LOCATION: The full serial number is found on the bottom of the barrel, the front of the frame, and the left side of the receiver. The last two digits of the serial number are on the breechblock (lower left side), extractor, front toggle link (bottom), rear toggle link (back), sear (left side), sear bar safety lever, side plate, takedown lever (bottom), thumb safety lever (top), trigger (top left), and grips (inside).

INTERESTING VARIATIONS

A rare variation verified with a 1939 date has a checkerboard shield mark next to the serial number on the left side of the receiver. These were issued to the Croatian 369th Infantry.

MARKINGS

MARK **LOCATION/DESCRIPTION**

S/42

Toggle
Manufacturer's Code



Receiver
Military Inspection
Acceptance Mark

and/or



Receiver
Military Inspection
Acceptance Mark



Receiver
Test Fire Proof

VALUES

POOR	FAIR	GOOD	VG	EXC
\$500	\$750	\$1,000	\$1,500	\$2,000

Look-Up Index # 169

**MAUSER S/42 LATE FINISH,
KRIEGSMARINE**

BACKGROUND

The Mauser S/42 Late Finish, Kriegsmarine model was made specifically for military sales to Germany. The pistols of this variation were marked and issued by the Kriegsmarine.

**HOW TO TELL A MAUSER S/42 LATE FINISH,
KRIEGSMARINE**

The Mauser S/42 Late Finish, Kriegsmarine can be distinguished from other Lugers by three features in combination.

1. S/42 inscription on the forward toggle link.
2. The chamber has a four-digit year date 1938 OR 1939.
3. O. or N. property number on the grip strap.

QUANTITY MADE

Approximately 2,400 dated 1938.
Very few (only one reported) dated 1939.

RARITY RATING

6, Rare.

FEATURES IN DEPTH

MANUFACTURER: This model was manufactured by Mauser Werke, Oberndorf.

TOGGLE: This model should have the new type toggle, with the flat, checkered toggle knobs.

TOGGLE MARK: S/42

BARREL: This model should have a 4-inch (100mm) barrel. It should be chambered for 9mm Parabellum.

FRAME: The frame on this model should be the late, short type with a stock lug, wide trigger and narrow trigger guard.

RECEIVER: The receiver on this model should be the late, short type. The chamber should be dated 1938 or 1939.

THUMB SAFETY: The thumb safety on this model should have a serrated safety lever. The upper position is marked "GESICHERT." Safe is in the lower position.

SIGHTS: The front sight on this model should be a dorsal fin shaped blade, dovetail fit on the barrel. The rear sight should be a fixed V notch in the rear toggle link.

EXTRACTOR: The extractor on this model should be the late type. It should be marked "GELADEN" on the left side.

GRIPS: The grips on this model should be checkered walnut.

MAGAZINE: The magazines original to this model should have a blued, wrap-around body with an aluminum base. They should be marked with a stick-wing E/63 or E/83. They should serial numbered to the pistol.

FINISH: The finish on this model should be a salt blue, including the small parts. No straw finish was used.

SERIAL NUMBER RANGE:



- 1938 dated in the h, i, l, and m blocks.
- 1939 dated in the p block.

SERIAL NUMBER LOCATION: The full serial number is found on the bottom of the barrel, the front of the frame, and the left side of the receiver. The last two digits of the serial number are on the breechblock (lower left side), extractor, front toggle link (bottom), rear toggle link (back), sear (left side), sear bar safety lever, side plate, takedown lever (bottom), thumb safety lever (top), trigger (top left), and grips (inside).

INTERESTING VARIATIONS

There are no notable variations of this model.

MARKINGS

MARK	LOCATION/DESCRIPTION
S/42	Toggle Manufacturer's Code
	Receiver Military Inspection Acceptance Mark
and/or	
	Receiver Military Inspection Acceptance Mark
	Receiver Test Fire Proof
N. Number	Grip Strap Nordsee Fleet Inventory Number
O. Number	Grip Strap Ostsee Fleet Inventory Number

VALUES

POOR	FAIR	GOOD	VG	EXC
\$900	\$1,250	\$2,000	\$2,750	\$3,500

Look-Up Index # 170

MAUSER S/42 LATE FINISH, POLICE

BACKGROUND

The Mauser S/42 Late Finish, Police model was made specifically for military sales to Germany.

HOW TO TELL A MAUSER S/42 LATE FINISH, POLICE

The Mauser S/42 Late Finish, Police can be distinguished from other Lugers by three features in combination.

1. S/42 inscription on the forward toggle link.
2. The chamber has a four-digit year date of 1938 or 1939.
3. Sear safety.

QUANTITY MADE

600.

RARITY RATING

7, Very rare.

FEATURES IN DEPTH

MANUFACTURER: This model was manufactured by Mauser Werke, Oberndorf.

TOGGLE: This model should have the new type toggle, with the flat, checkered toggle knobs.

TOGGLE MARK: S/42

BARREL: This model should have a 4-inch (100mm) barrel. It should be chambered for 9mm Parabellum.

FRAME: The frame on this model should be the late, short type with a stock lug, wide trigger and narrow trigger guard.

RECEIVER: The receiver on this model should be the late, short type. The chamber should be dated 1938 or 1939.

THUMB SAFETY: The thumb safety on this model should have a serrated safety lever. The upper position is marked "GESICHERT." Safe is in the lower position.

SIGHTS: The front sight on this model should be a dorsal fin shaped blade, dovetail fit on the barrel. The rear sight should be a fixed V notch in the rear toggle link.

EXTRACTOR: The extractor on this model should be the late type. It should be marked "GELADEN" on the left side.

GRIPS: The grips on this model should be checkered walnut.

MAGAZINE: The magazines original to this model should have a blued, wrap-around body with an aluminum base. They should be marked with a stick-wing E/63 or E/83. They should serial numbered to the pistol.

FINISH: The finish on this model should be a salt blue, including the small parts. No straw finish was used.

SERIAL NUMBER RANGE: In the m and n blocks.

SERIAL NUMBER LOCATION: The full serial number is found on the bottom of the barrel, the front of the frame, and the left side of the receiver. The last two digits of the serial number are on the breechblock (lower left side), extractor, front toggle link (bottom), rear toggle link (back), sear (left side), sear bar safety lever, side plate, takedown lever (bottom), thumb safety lever (top), trigger (top left), and grips (inside).

INTERESTING VARIATIONS

There are no notable variations of this model.

MARKINGS

MARK **LOCATION/DESCRIPTION**

S/42

Toggle
Manufacturer's Code



Receiver
Military Inspection
Acceptance Mark

and/or



Receiver
Military Inspection
Acceptance Mark



Receiver
Test Fire Proof

VALUES

POOR	FAIR	GOOD	VG	EXC
\$500	\$750	\$1,000	\$1,500	\$2,000

Look-Up Index # 171

MAUSER S/42 1939 DATED, LATE PROOF

BACKGROUND

The Mauser S/42 1939 Date, Late Proof model was made specifically for military sales to Germany.

HOW TO TELL A MAUSER S/42 1939 DATE, LATE PROOF

The Mauser S/42 1939 Date, Late Proof can be distinguished from other Lugers by four features in combination.

1. S/42 inscription on the forward toggle link.
2. The chamber has a four-digit year date between 1939.
3. Serial number in the r block.
4. No sear safety.

QUANTITY MADE

6,000.

RARITY RATING

4, Scarce.

FEATURES IN DEPTH

MANUFACTURER: This model was manufactured by Mauser Werke, Oberndorf.

TOGGLE: This model should have the new type toggle, with the flat, checkered toggle knobs.

TOGGLE MARK: S/42

BARREL: This model should have a 4-inch (100mm) barrel. It should be chambered for 9mm Parabellum.

FRAME: The frame on this model should be the late, short type with a stock lug, wide trigger and narrow trigger guard.

RECEIVER: The receiver on this model should be the late, short type. The chamber should be dated 1939.

THUMB SAFETY: The thumb safety on this model should have a serrated safety lever. The upper position is marked "GESICHERT." Safe is in the lower position.

SIGHTS: The front sight on this model should be a dorsal fin shaped blade, dovetail fit on the barrel. The rear sight should be a fixed V notch in the rear toggle link.

EXTRACTOR: The extractor on this model should be the late type. It should be marked "GELADEN" on the left side.

GRIPS: The grips on this model should be checkered walnut.

MAGAZINE: The magazines original to this model should have a blued, wrap-around body with an aluminum base. They should be marked with a stick-wing E/63 or E/83. They should serial numbered to the pistol.

FINISH: The finish on this model should be a salt blue, including the small parts. No straw finish was used.

SERIAL NUMBER RANGE: 1 r to 6000 r.

SERIAL NUMBER LOCATION: The full serial number is found on the bottom of the barrel, the front of the frame, and the left side of the receiver. The last two digits of the serial number are on the breechblock (lower left side), extractor, front toggle link (bottom), rear toggle link (back), sear (left side), sear bar safety lever, side plate, takedown lever (bottom), thumb safety lever (top), trigger (top left), and grips (inside).

INTERESTING VARIATIONS

There are no notable variations of this model.

MARKINGS

MARK	LOCATION/DESCRIPTION
S/42	Toggle Manufacturer's Code



Receiver
Military Inspection
Acceptance Mark

and/or



Receiver
Military Inspection
Acceptance Mark



Receiver
Test Fire Proof

VALUES

POOR	FAIR	GOOD	VG	EXC
\$500	\$750	\$1,000	\$1,500	\$2,000

Look-Up Index # 172

MAUSER S/42, COMMERCIAL

BACKGROUND

The Mauser S/42, Commercial is an odd ball. The sole known example of this commercially proofed, contract serial number, military toggle piece would normally be written off as a mismatched toggle on an otherwise Mauser Banner Commercial. However, experts who have inspected this unique piece can see no signs of its being tinkered with. Definitely "outside the box."

HOW TO TELL A MAUSER S/42, COMMERCIAL

The Mauser S/42, Commercial can be distinguished from other Lugers by two seemingly contradictory features in combination.

1. S/42 inscription on the forward toggle link.
2. Mauser Oberndorf commercial proof.

QUANTITY MADE

Maybe a few hundred, scattered through 1936 through 1939 production.

RARITY RATING

7, Very rare.

FEATURES IN DEPTH

MANUFACTURER: This model was manufactured by Mauser Werke, Oberndorf.

TOGGLE: This model should have the new type toggle, with the flat, checkered toggle knobs.

TOGGLE MARK: S/42

BARREL: This model should have a 4-inch (100mm) barrel. It should be chambered for 9mm Parabellum.

FRAME: The frame on this model should be the late, short type, with a stock lug, wide trigger and narrow trigger guard.

RECEIVER: The receiver on this model should be the late, short type. The chamber on the only documented example has the four-digit date 1938.

THUMB SAFETY: The thumb safety on this model should have a serrated safety lever. The upper position is marked "GESICHERT." Safe is in the lower position.

SIGHTS: The front sight on this model should be a dorsal fin shaped blade, dovetail fit on the barrel. The rear sight should be a fixed V notch in the rear toggle link.

EXTRACTOR: The extractor on this model should be the late type. It should be marked "GELADEN" on the left side.

GRIPS: The grips on this model should be checkered walnut.

MAGAZINE: The magazines original to this model should have a blued, wrap-around body with an aluminum base. Magazine marking and serial numbering is uncertain for this model.

FINISH: The main finish on this model should be a salt blue. The ejector, magazine catch/release, takedown lever, thumb safety lever and trigger should all be straw colored.

SERIAL NUMBER RANGE: In the 5300 v range.

SERIAL NUMBER LOCATION: The full serial number is found on the bottom of the barrel, the front of the frame, and the left side of the receiver. The last two digits of the serial number are on the breechblock (lower left side), extractor, front toggle link (bottom), rear toggle link (back), sear (left side), sear bar safety lever, side plate, takedown lever (bottom), thumb safety lever (top), trigger (top left), and grips (inside).

INTERESTING VARIATIONS

There are no notable variations of this model.

MARKINGS

MARK	LOCATION/DESCRIPTION
S/42	Toggle Manufacturer's Code



Receiver
Nazi Commercial Test Proof

VALUES

POOR	FAIR	GOOD	VG	EXC
\$500	\$750	\$1,000	\$1,800	\$2,500

Look-Up Index # 173

MAUSER PRESSURE TEST

BACKGROUND

The Mauser Pressure Test model was a workshop test piece used to determine chamber pressure during weapon firing. The “Üb” on the chamber is an abbreviation for “Übung” meaning test.

HOW TO TELL A MAUSER PRESSURE TEST

The Mauser Pressure Test can be distinguished from other Lugers by two features in combination.

1. The chamber is marked “Üb.”
2. There is a small hole located on the top of the barrel about 1 cm ahead of the chamber.

QUANTITY MADE

Probably less than 10.

RARITY RATING

9, Nearly unique.

FEATURES IN DEPTH

MANUFACTURER: This model was manufactured by Mauser Werke, Oberndorf.

TOGGLE: This model should have the new type toggle, with the flat, checkered toggle knobs.

TOGGLE MARK: S/42

BARREL: This model should have a 4-inch (100mm) barrel. It should be chambered for 9mm Parabellum. There is a small hole located on the top of the barrel about 1 cm ahead of the chamber. This hole would accept a pressure test jig that would bleed off chamber gas and deform a copper slug to measure chamber pressure.

FRAME: The frame on this model should be the late, short type with a stock lug, wide trigger and narrow trigger guard.

RECEIVER: The receiver on this model should be the late, short type. The chamber should be marked “Üb.”

THUMB SAFETY: The thumb safety on this model should have a serrated safety lever. The upper position is marked “GESICHERT.” Safe is in the lower position.

SIGHTS: The front sight on this model should be a dorsal fin shaped blade, dovetail fit on the barrel. The rear sight should be a fixed V notch in the rear toggle link.

EXTRACTOR: The extractor on this model should be the late type. It should be blank.

GRIPS: The grips on this model should be checkered walnut.

MAGAZINE: The magazines original to this model should have a blued, wrap-around body with an aluminum base. They should not be proof marked or serial numbered.

FINISH: The finish on this model should be a salt blue, including the small parts. No straw finish was used. The appearance is almost that of a dull military blue (i.e., not the traditional glossy appearance). This is due to most parts being less machined, even somewhat oversized, compared to production Lugers.

SERIAL NUMBER RANGE: These appear to have been taken from production, and hand fitted. The best-documented example is number 11809.

SERIAL NUMBER LOCATION: The full serial number is found on the bottom of the barrel, the front of the frame, and the left side of the receiver. The last two digits of the serial number are on the breechblock (lower left side), extractor, front toggle link (bottom), rear toggle link (back), sear (left side), sear bar safety lever, side plate, takedown lever (bottom), thumb safety lever (top), trigger (top left), and grips (inside).

INTERESTING VARIATIONS

There are no notable variations of this model.

MARKINGS

MARK	LOCATION/DESCRIPTION
S/42	Toggle Manufacturer’s Logo Code
Üb	Chamber Workshop Test Piece Mark

VALUES

This model is too rare to price.

Look-Up Index # 174

MAUSER 42 CODE, FOUR-DIGIT DATE

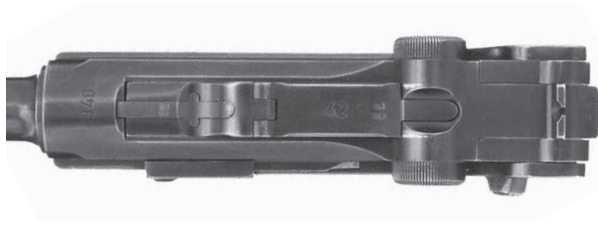

BACKGROUND

The Mauser 42 Code Four-digit Date model was made specifically for military sales to Germany.

HOW TO TELL A MAUSER 42 CODE FOUR-DIGIT DATE

The Mauser 42 Code Four-digit Dated can be distinguished from other Lugers by three features in combination.

1. The toggle is marked "42."
2. The chamber has a four-digit year date, either 1939 or 1940.
3. No Kriegsmarine property number on the grip strap.

QUANTITY MADE

Approximately 85,500 dated 1939.
Approximately 133,700 dated 1940.

RARITY RATING

2, Common.

FEATURES IN DEPTH

MANUFACTURER: This model was manufactured by Mauser Werke, Oberndorf.

TOGGLE: This model should have the new type toggle, with the flat, checkered toggle knobs.

TOGGLE MARK: 42

BARREL: This model should have a 4-inch (100mm) barrel. It should be chambered for 9mm Parabellum.

FRAME: The frame on this model should be the late, short type with a stock lug, wide trigger and narrow trigger guard.

RECEIVER: The receiver on this model should be the late, short type. The chamber should have a four-digit year date of 1939 or 1940.

THUMB SAFETY: The thumb safety on this model should have a serrated safety lever. The upper position is marked "GESICHERT." Safe is in the lower position.

SIGHTS: The front sight on this model should be a dorsal fin shaped blade, dovetail fit on the barrel. The rear sight should be a fixed V notch in the rear toggle link.

EXTRACTOR: The extractor on this model should be the late type. It should be marked "GELADEN" on the left side.

GRIPS: The grips on this model should be checkered walnut.

MAGAZINE: The magazines original to this model should have a blued, extruded steel body with an aluminum base. They should be marked "122" and "P.08," and serial numbered to the pistol. Some also marked with an E/37 proof.

FINISH: The finish on this model should be a salt blue, including the small parts. No straw finish was used.

SERIAL NUMBER RANGE:

200 r to 8250 z dated 1939.



7700 z to 7000 n dated 1940.

SERIAL NUMBER LOCATION: The full serial number is found on the bottom of the barrel, the front of the frame, and the left side of the receiver. The last two digits of the serial number are on the breechblock (lower left side), extractor, front toggle link (bottom), rear toggle link (back), sear (left side), sear bar safety lever, side plate, takedown lever (bottom), thumb safety lever (top), trigger (top left), and grips (inside).

INTERESTING VARIATIONS

There are no notable variations of this model.

MARKINGS

MARK	LOCATION/DESCRIPTION
S/42	Toggle Manufacturer's Code
	Receiver Military Test Fire Proof
	Receiver Acceptance Mark

VALUES

POOR	FAIR	GOOD	VG	EXC
\$450	\$650	\$950	\$1,800	\$2,500

Look-Up Index # 175

MAUSER 42 CODE, KRIEGSMARINE

BACKGROUND

The Mauser 42 Code, Kriegsmarine model was made specifically for military sales to Germany.

HOW TO TELL A MAUSER 42 CODE, KRIEGSMARINE

The Mauser 42 Code, Kriegsmarine can be distinguished from other Lugers by three features in combination.

1. The toggle is marked "42."
2. The chamber has a four-digit year date, either 1939 or 1940.
3. O. or N. property number on the grip strap.

QUANTITY MADE

Approximately 400 dated 1939.
Approximately 2,000 dated 1940.

RARITY RATING

6, Rare.

FEATURES IN DEPTH

MANUFACTURER: This model was manufactured by Mauser Werke, Oberndorf.

TOGGLE: This model should have the new type toggle, with the flat, checkered toggle knobs.

TOGGLE MARK: 42

BARREL: This model should have a 4-inch (100mm) barrel. It should be chambered for 9mm Parabellum.

FRAME: The frame on this model should be the late, short type with a stock lug, wide trigger and narrow trigger guard.

RECEIVER: The receiver on this model should be the late, short type. The chamber should have a four-digit year date of 1939 or 1940.

THUMB SAFETY: The thumb safety on this model should have a serrated safety lever. The upper position is marked "GESICHERT." Safe is in the lower position.

SIGHTS: The front sight on this model should be a dorsal fin shaped blade, dovetail fit on the barrel. The rear sight should be a fixed V notch in the rear toggle link.

EXTRACTOR: The extractor on this model should be the late type. It should be marked "GELADEN" on the left side.

GRIPS: The grips on this model should be checkered walnut.

MAGAZINE: The magazines original to this model should have a blued, extruded steel body with an aluminum base. They should be marked "122" and "P.08," and serial numbered to the pistol. Some also marked with an E/37 proof.

FINISH: The finish on this model should be a salt blue, including the small parts. No straw finish was used.

SERIAL NUMBER RANGE:

1939 dated in the y and z blocks.
1940 dated in the a, c, d, e and f blocks.

SERIAL NUMBER LOCATION: The full serial number is found on the bottom of the barrel, the front of the frame, and the left side of the receiver. The last two digits of the serial number are on the breechblock (lower left side), extractor, front toggle link (bottom), rear toggle link (back), sear (left side), sear bar safety lever, side plate, takedown lever (bottom), thumb safety lever (top), trigger (top left), and grips (inside).

INTERESTING VARIATIONS

There are no notable variations of this model.

MARKINGS

MARK	LOCATION/DESCRIPTION
------	----------------------

S/42	Toggle Manufacturer's Code
------	-------------------------------



	Receiver Military Test Fire Proof
--	--------------------------------------



	Receiver Acceptance Mark
--	-----------------------------

N. Number	Grip Strap Nordsee Fleet Inventory Number
-----------	---

or

O. Number	Grip Strap Ostsee Fleet Inventory Number
-----------	--

VALUES

POOR	FAIR	GOOD	VG	EXC
\$750	\$1,250	\$1,750	\$3,000	\$4,250

Look-Up Index # 176

MAUSER 41 / 42 CODE



BACKGROUND

The Mauser 41 / 42 Code model was made specifically for military sales to Germany.

HOW TO TELL A MAUSER 41 / 42 CODE

The Mauser 41 / 42 Code can be distinguished from other Lugers by two features in combination.

1. The toggle is marked "42."
2. The chamber has a two-digit year date, "41."

QUANTITY MADE

7,000 to 15,000. The serial number range covered about 18,000 pistols, but this range overlaps with the byf 41 serial number range. So we only know the quantity within a range.

RARITY RATING

2, Common.

FEATURES IN DEPTH

MANUFACTURER: This model was manufactured by Mauser Werke, Oberndorf.

TOGGLE: This model should have the new type toggle, with the flat, checkered toggle knobs.

TOGGLE MARK: 42

BARREL: This model should have a 4-inch (100mm) barrel. It should be chambered for 9mm Parabellum.

FRAME: The frame on this model should be the late, short type with a stock lug, wide trigger and narrow trigger guard. It is marked "P.08" on the left side, near the thumb safety.

RECEIVER: The receiver on this model should be the late, short type. The chamber should have a two-digit year date of 41.

THUMB SAFETY: The thumb safety on this model should have a serrated safety lever. The upper position is marked "GESICHERT." Safe is in the lower position.

SIGHTS: The front sight on this model should be a dorsal fin shaped blade, dovetail fit on the barrel. The rear sight should be a fixed V notch in the rear toggle link.

EXTRACTOR: The extractor on this model should be the late type. It should be marked "GELADEN" on the left side.

GRIPS: The grips on this model could be either checkered walnut or black plastic.

MAGAZINE: The magazines original to this model should have a blued, extruded steel body with an aluminum base. They should be marked "122" and "P.08," and serial numbered to the pistol. Some also marked with an E/37 proof.

FINISH: The finish on this model should be a salt blue, including the small parts. No straw finish was used.

SERIAL NUMBER RANGE:

- 2500 n to 1000 E/655 marked.
- 1000 to 9950 a E/135 marked.

SERIAL NUMBER LOCATION: The full serial number is found on the bottom of the barrel, the front of the frame, and the left side of the receiver. The last two digits of the serial number are on the breechblock (lower left side), extractor, front toggle link (bottom), rear toggle link (back), sear (left side), sear bar safety lever, side plate, takedown lever (bottom), thumb safety lever (top), trigger (top left), and grips (inside).

INTERESTING VARIATIONS

Kriegsmarine marked Lugers may exist in this model, but none are reported at this time.

MARKINGS

MARK	LOCATION/DESCRIPTION
S/42	Toggle Manufacturer's Code
	Receiver Test Fire Proof
	Receiver Acceptance Mark



VALUES

POOR	FAIR	GOOD	VG	EXC
\$500	\$750	\$950	\$1,250	\$1,800

Look-Up Index # 177

MAUSER byf CODE, 41 DATE, EARLY MARKS

BACKGROUND

The Mauser byf Code, 41 Date, Early Marks model was made specifically for military sales to Germany.

HOW TO TELL A MAUSER byf CODE, 41 DATE, EARLY MARKS

The Mauser byf Code, 41 Date, Early Marks can be distinguished from other Lugers by five features in combination.

1. A toggle inscription of "byf."
2. The chamber has a two-digit date of 41.
3. Walnut grips.
4. Eagle/655 military acceptance marks.
5. No sear safety.

QUANTITY MADE

- 126,000 dated 1941.
- 90,000 dated 1942.

RARITY RATING

3, Uncommon.

FEATURES IN DEPTH

MANUFACTURER: This model was manufactured by Mauser Werke, Oberndorf.

TOGGLE: This model should have the new type toggle, with the flat, checkered toggle knobs.

TOGGLE MARK: byf

BARREL: This model should have a 4-inch (100mm) barrel. It should be chambered for 9mm Parabellum.

FRAME: The frame on this model should be the late, short type with a stock lug, wide trigger and narrow trigger guard. It is marked "P.08" on the left side, near the thumb safety.

RECEIVER: The receiver on this model should be the late, short type. The chamber should have a two-digit year date of 41 or 42.

THUMB SAFETY: The thumb safety on this model should have a serrated safety lever. The upper position is marked "GESICHERT." Safe is in the lower position.

SIGHTS: The front sight on this model should be a dorsal fin shaped blade, dovetail fit on the barrel. The rear sight should be a fixed V notch in the rear toggle link.

EXTRACTOR: The extractor on this model should be the late type. It should be marked "GELADEN" on the left side.

GRIPS: The grips on this model could be either checkered walnut or black plastic.

MAGAZINE: The magazines original to this model should have a blued, extruded steel body with either an aluminum (only in early 41 dates) or black plastic base. They should be marked "fxo" and "P.08." Some also marked with an E/37 proof. Aluminum based magazines may be serial numbered to the pistol.

FINISH: The finish on this model should be a salt blue, including the small parts. No straw finish was used.



SERIAL NUMBER RANGE: 3300 n to 1000.

SERIAL NUMBER LOCATION: The full serial number is found on the bottom of the barrel, the front of the frame, and the left side of the receiver. The last two digits of the serial number are on the breechblock (lower left side), extractor, front toggle link (bottom), rear toggle link (back), sear (left side), sear bar safety lever, side plate, takedown lever (bottom), thumb safety lever (top), trigger (top left), and grips (inside).

INTERESTING VARIATIONS

There are no notable variations of this model.

MARKINGS

MARK	LOCATION/DESCRIPTION
S/42	Toggle Manufacturer's Code
	Receiver Test Fire Proof
	Receiver Acceptance Mark

VALUES

POOR	FAIR	GOOD	VG	EXC
\$750	\$1,000	\$1,850	\$2,000	\$2,500

Look-Up Index # 178

MAUSER byf, 41 DATE, EARLY BLACK WIDOW

BACKGROUND

The Mauser byf, 41 Date, Early Black Widow model was made specifically for military sales to Germany.

HOW TO TELL A MAUSER byf, 41 DATE, EARLY BLACK WIDOW

The Mauser byf Code, 41 Date, Early Black Widow can be distinguished from other Lugers by five features in combination.

1. A toggle inscription of "byf."
2. The chamber has a two-digit date of 41.
3. Black plastic grips.
4. Eagle/655 military acceptance marks.
5. No sear safety.

QUANTITY MADE

Approximately 25,000.

RARITY RATING

3, Uncommon.

FEATURES IN DEPTH

MANUFACTURER: This model was manufactured by Mauser Werke, Oberndorf.

TOGGLE: This model should have the new type toggle, with the flat, checkered toggle knobs.

TOGGLE MARK: byf

BARREL: This model should have a 4-inch (100mm) barrel. It should be chambered for 9mm Parabellum.

FRAME: The frame on this model should be the late, short type with a stock lug, wide trigger and narrow trigger guard. It is marked "P.08" on the left side, near the thumb safety.

RECEIVER: The receiver on this model should be the late, short type. The chamber should have a two-digit year date of 41 or 42.

THUMB SAFETY: The thumb safety on this model should have a serrated safety lever. The upper position is marked "GESICHERT." Safe is in the lower position.

SIGHTS: The front sight on this model should be a dorsal fin shaped blade, dovetail fit on the barrel. The rear sight should be a fixed V notch in the rear toggle link.

EXTRACTOR: The extractor on this model should be the late type. It should be marked "GELADEN" on the left side.

GRIPS: The grips on this model could be either checkered walnut or black plastic.

MAGAZINE: The magazines original to this model should have a blued, extruded steel body with either an aluminum (only in early 41 dates) or black plastic base. They should be marked "fxo" and "P.08." Some also marked with an E/37 proof. Aluminum based magazines may be serial numbered to the pistol.

FINISH: The finish on this model should be a salt blue, including the small parts. No straw finish was used.



SERIAL NUMBER RANGE: 3300 n to 1000.

SERIAL NUMBER LOCATION: The full serial number is found on the bottom of the barrel, the front of the frame, and the left side of the receiver. The last two digits of the serial number are on the breechblock (lower left side), extractor, front toggle link (bottom), rear toggle link (back), sear (left side), sear bar safety lever, side plate, takedown lever (bottom), thumb safety lever (top), trigger (top left), and grips (inside).

INTERESTING VARIATIONS

There are no notable variations of this model.

MARKINGS

MARK	LOCATION/DESCRIPTION
byf	Toggle Manufacturer's Code
	Receiver Test Fire Proof
	Receiver Acceptance Mark

VALUES

POOR	FAIR	GOOD	VG	EXC
\$750	\$1,000	\$1,850	\$2,000	\$2,500

Look-Up Index # 179

MAUSER byf CODE, POLICE

BACKGROUND

The Mauser byf Code, Police model was made specifically for military sales to Germany.

HOW TO TELL A MAUSER byf CODE, POLICE

The Mauser byf Code, Police can be distinguished from other Lugers by two features in combination.

1. A toggle inscription of "byf."
2. It has a sear safety.

QUANTITY MADE

Approximately 200.

RARITY RATING

7, Very rare.

FEATURES IN DEPTH

MANUFACTURER: This model was manufactured by Mauser Werke, Oberndorf.

TOGGLE: This model should have the new type toggle, with the flat, checkered toggle knobs.

TOGGLE MARK: byf

BARREL: This model should have a 4-inch (100mm) barrel. It should be chambered for 9mm Parabellum.

FRAME: The frame on this model should be the late, short type with a stock lug, wide trigger and narrow trigger guard. It is marked "P.08" on the left side, near the thumb safety.

RECEIVER: The receiver on this model should be the late, short type, with a sear safety. The chamber should have a two-digit year date of 41.

THUMB SAFETY: The thumb safety on this model should have a serrated safety lever. The upper position is marked "GESICHERT." Safe is in the lower position.

SIGHTS: The front sight on this model should be a dorsal fin shaped blade, dovetail fit on the barrel. The rear sight should be a fixed V notch in the rear toggle link.

EXTRACTOR: The extractor on this model should be the late type. It should be marked "GELADEN" on the left side.

GRIPS: The grips on this model could be either checkered walnut or black plastic.

MAGAZINE: The magazines original to this model should have a blued, extruded steel body with either an aluminum (only on early 41 dates) or black plastic base. They should be marked "fxo" and "P.08." Some also

marked with an E/37 proof. Aluminum based magazines may be serial numbered to the pistol.

FINISH: The finish on this model should be a salt blue, including the small parts. No straw finish was used.





SERIAL NUMBER RANGE: In the o and p blocks.

SERIAL NUMBER LOCATION: The full serial number is found on the bottom of the barrel, the front of the frame, and the left side of the receiver. The last two digits of the serial number are on the breechblock (lower left side), extractor, front toggle link (bottom), rear toggle link (back), sear (left side), sear bar safety lever, side plate, takedown lever (bottom), thumb safety lever (top), trigger (top left), and grips (inside).

INTERESTING VARIATIONS

There are no notable variations of this model.

MARKINGS

MARK	LOCATION/DESCRIPTION
byf	Toggle Manufacturer's Code
	Receiver Nazi Commercial Test Proof
	Receiver Police acceptance mark found on 1938 - 1939 dates
	Receiver Police acceptance mark found on 1939 dates
	Receiver Police acceptance mark found on 1939 - 1940 dates
	Receiver Police acceptance mark found on 1939 - 1942 dates

VALUES

POOR	FAIR	GOOD	VG	EXC
\$750	\$1,000	\$1,850	\$2,000	\$2,500

Look-Up Index # 180

MAUSER byf CODE, 41 DATE, LATE MARKS

BACKGROUND

The Mauser byf Code, 41 Date, Late Marks model was made specifically for military sales to Germany.

HOW TO TELL A MAUSER byf CODE, 41 DATE, LATE MARKS

The Mauser byf Code, 41 Date, Late Marks can be distinguished from other Lugers by five features in combination.

1. A toggle inscription of "byf."
2. The chamber has a two-digit date of 41.
3. Checkered walnut grips.
4. Eagle/135 military acceptance marks.
5. No sear safety.

QUANTITY MADE

Approximately 19,000.

RARITY RATING

3, Uncommon.

FEATURES IN DEPTH

MANUFACTURER: This model was manufactured by Mauser Werke, Oberndorf.

TOGGLE: This model should have the new type toggle, with the flat, checkered toggle knobs.

TOGGLE MARK: byf

BARREL: This model should have a 4-inch (100mm) barrel. It should be chambered for 9mm Parabellum.

FRAME: The frame on this model should be the late, short type with a stock lug, wide trigger and narrow trigger guard. It is marked "P.08" on the left side, near the thumb safety.

RECEIVER: The receiver on this model should be the late, short type. The chamber should have a two-digit year date of 41.

THUMB SAFETY: The thumb safety on this model should have a serrated safety lever. The upper position is marked "GESICHERT." Safe is in the lower position.

SIGHTS: The front sight on this model should be a dorsal fin shaped blade, dovetail fit on the barrel. The rear sight should be a fixed V notch in the rear toggle link.

EXTRACTOR: The extractor on this model should be the late type. It should be marked "GELADEN" on the left side.

GRIPS: The grips on this model should be checkered walnut.

MAGAZINE: The magazines original to this model should have a blued, extruded steel body with either an aluminum (only on early 41 dates) or black plastic base. They should be marked "fxo" and "P.08." Some also marked with an E/37 proof. Aluminum based magazines may be serial numbered to the pistol.

FINISH: The finish on this model should be a salt blue, including the small parts. No straw finish was used.



SERIAL NUMBER RANGE: 1000 to 10000 a.

SERIAL NUMBER LOCATION: The full serial number is found on the bottom of the barrel, the front of the frame, and the left side of the receiver. The last two digits of the serial number are on the breechblock (lower left side), extractor, front toggle link (bottom), rear toggle link (back), sear (left side), sear bar safety lever, side plate, takedown lever (bottom), thumb safety lever (top), trigger (top left), and grips (inside).

INTERESTING VARIATIONS

There are no notable variations of this model.

MARKINGS

MARK	LOCATION/DESCRIPTION
byf	Toggle Manufacturer's Code
	Receiver Test Fire Proof
	Receiver Inspection/Acceptance Mark

VALUES

POOR	FAIR	GOOD	VG	EXC
\$750	\$1,000	\$1,850	\$2,000	\$2,500

Look-Up Index # 181

MAUSER byf, 41 DATE, LATE BLACK WIDOW

BACKGROUND

The Mauser byf, 41 Date, Late Black Widow model was made specifically for military sales to Germany.

HOW TO TELL A MAUSER byf, 41 DATE, LATE BLACK WIDOW

The Mauser byf, 41 Date, Late Black Widow can be distinguished from other Lugers by five features in combination.

1. A toggle inscription of "byf."
2. The chamber has a two-digit date of 41.
3. Black plastic grips.
4. Eagle/135 military acceptance marks.
5. No sear safety.

QUANTITY MADE

Approximately 3,500.

RARITY RATING

5, Somewhat rare.

FEATURES IN DEPTH

MANUFACTURER: This model was manufactured by Mauser Werke, Oberndorf.

TOGGLE: This model should have the new type toggle, with the flat, checkered toggle knobs.

TOGGLE MARK: byf

BARREL: This model should have a 4-inch (100mm) barrel. It should be chambered for 9mm Parabellum.

FRAME: The frame on this model should be the late, short type with a stock lug, wide trigger and narrow trigger guard. It is marked "P.08" on the left side, near the thumb safety.

RECEIVER: The receiver on this model should be the late, short type. The chamber should have a two-digit year date of 41.

THUMB SAFETY: The thumb safety on this model should have a serrated safety lever. The upper position is marked "GESICHERT." Safe is in the lower position.

SIGHTS: The front sight on this model should be a dorsal fin shaped blade, dovetail fit on the barrel. The rear sight should be a fixed V notch in the rear toggle link.

EXTRACTOR: The extractor on this model should be the late type. It should be marked "GELADEN" on the left side.

GRIPS: The grips on this model should be checkered black plastic.

MAGAZINE: The magazines original to this model should have a blued, extruded steel body with either an aluminum (only on early 41 dates) or black plastic base. They should be marked "fxo" and "P.08." Some also marked with an E/37 proof. Aluminum based magazines may be serial numbered to the pistol.

FINISH: The finish on this model should be a salt blue, including the small parts. No straw finish was used.



SERIAL NUMBER RANGE: 1000 to 10000 a.

SERIAL NUMBER LOCATION: The full serial number is found on the bottom of the barrel, the front of the frame, and the left side of the receiver. The last two digits of the serial number are on the breechblock (lower left side), extractor, front toggle link (bottom), rear toggle link (back), sear (left side), sear bar safety lever, side plate, takedown lever (bottom), thumb safety lever (top), trigger (top left), and grips (inside).

INTERESTING VARIATIONS

There are no notable variations of this model.

MARKINGS

MARK	LOCATION/DESCRIPTION
byf	Toggle Manufacturer's Code
	Receiver Test Fire Proof
	Receiver Inspection/Acceptance Mark

VALUES

POOR	FAIR	GOOD	VG	EXC
\$750	\$1,000	\$1,850	\$2,000	\$2,500

Look-Up Index # 182

MAUSER byf CODE, 42 DATE

BACKGROUND

The Mauser byf Code, 42 Date model was made specifically for military sales to Germany.

HOW TO TELL A MAUSER byf CODE, 42 DATE

The Mauser byf Code, 42 Date, can be distinguished from other Lugers by five features in combination.

1. A toggle inscription of "byf."
2. The chamber has a two-digit date of 42.
3. Checkered walnut grips.
4. Military acceptance and proof marks.
5. No sear safety.

QUANTITY MADE

Estimated at 89,000.

RARITY RATING

3, Uncommon.

FEATURES IN DEPTH

MANUFACTURER: This model was manufactured by Mauser Werke, Oberndorf.

TOGGLE: This model should have the new type toggle, with the flat, checkered toggle knobs.

TOGGLE MARK: byf

BARREL: This model should have a 4-inch (100mm) barrel. It should be chambered for 9mm Parabellum.

FRAME: The frame on this model should be the late, short type with a stock lug, wide trigger and narrow trigger guard. It is marked "P.08" on the left side, near the thumb safety.

RECEIVER: The receiver on this model should be the late, short type. The chamber should have a two-digit year date of 42.

THUMB SAFETY: The thumb safety on this model should have a serrated safety lever. The upper position is marked "GESICHERT." Safe is in the lower position.

SIGHTS: The front sight on this model should be a dorsal fin shaped blade, dovetail fit on the barrel. The rear sight should be a fixed V notch in the rear toggle link.

EXTRACTOR: The extractor on this model should be the late type. It should be marked "GELADEN" on the left side.

GRIPS: The grips on this model should be checkered walnut.

MAGAZINE: The magazines original to this model should have a blued, extruded steel body with either an aluminum (only in early 41 dates) or black plastic base. They should be marked "fxo" and "P.08." They should not be otherwise proofed or serial numbered to the pistol.

FINISH: The finish on this model should be a salt blue, including the small parts. No straw finish was used.

SERIAL NUMBER RANGE: 500 to the early m block.



SERIAL NUMBER LOCATION: The full serial number is found on the bottom of the barrel, the front of the frame, and the left side of the receiver. The last two digits of the serial number are on the breechblock (lower left side), extractor, front toggle link (bottom), rear toggle link (back), sear (left side), sear bar safety lever, side plate, takedown lever (bottom), thumb safety lever (top), and trigger (top left).

INTERESTING VARIATIONS

A Portuguese contract is reported in the 149 m to 5322 m range.

A Bulgarian contract is reported in the 5322 m to 2197 n range.

MARKINGS

MARK	LOCATION/DESCRIPTION
byf	Toggle Manufacturer's Code
	Receiver Test Fire Proof
	Receiver Inspection/Acceptance Mark

VALUES

POOR	FAIR	GOOD	VG	EXC
\$750	\$1,000	\$1,850	\$2,000	\$2,500

Look-Up Index # 183

MAUSER byf CODE, 42 DATE BLACK WIDOW



BACKGROUND

The Mauser byf Code 42 Date Black Widow model was made specifically for military sales to Germany. It is the black plastic grips (about 20 percent of 1942 byf production) that gives this configuration of Luger its collector's model name of Black Widow.

HOW TO TELL A MAUSER byf CODE 42 DATE BLACK WIDOW

The Mauser byf Code 42 Date Black Widow can be distinguished from other Lugers by five features in combination.

1. A toggle inscription of "byf."
2. The chamber has a two-digit date of 42.
3. Plastic grips.
4. Military acceptance and proof marks.
5. No sear safety.

QUANTITY MADE

Estimated at 24,000.

RARITY RATING

3, Uncommon.

FEATURES IN DEPTH

MANUFACTURER: This model was manufactured by Mauser Werke, Oberndorf.

TOGGLE: This model should have the new type toggle, with the flat, checkered toggle knobs.

TOGGLE MARK: byf

BARREL: This model should have a 4-inch (100mm) barrel. It should be chambered for 9mm Parabellum.

FRAME: The frame on this model should be the late, short type with a stock lug, wide trigger and narrow

trigger guard. It is marked "P.08" on the left side, near the thumb safety.

RECEIVER: The receiver on this model should be the late, short type. The chamber should have a two-digit year date of 42.

THUMB SAFETY: The thumb safety on this model should have a serrated safety lever. The upper position is marked "GESICHERT." Safe is in the lower position.

SIGHTS: The front sight on this model should be a dorsal fin shaped blade, dovetail fit on the barrel. The rear sight should be a fixed V notch in the rear toggle link.

EXTRACTOR: The extractor on this model should be the late type. It should be marked "GELADEN" on the left side.

GRIPS: The grips on this model should be molded checkered black plastic.

MAGAZINE: The magazines original to this model should have a blued, extruded steel body with either an aluminum (only in early 41 dates) or black plastic base. They should be marked "fxo" and "P.08." They should not be otherwise proofed or serial numbered to the pistol.

FINISH: The finish on this model should be a salt blue, including the small parts. No straw finish was used.

SERIAL NUMBER RANGE: 500 to the early m block.



SERIAL NUMBER LOCATION: The full serial number is found on the bottom of the barrel, the front of the frame, and the left side of the receiver. The last two digits of the serial number are on the breechblock (lower left side), extractor, front toggle link (bottom), rear toggle link (back), sear (left side), sear bar safety lever, side plate, takedown lever (bottom), thumb safety lever (top), and trigger (top left).

INTERESTING VARIATIONS

A Portuguese contract is reported in the 149 m to 5322 m range.

A Bulgarian contract is reported in the 5322 m to 2197 n range.

MARKINGS

MARK	LOCATION/DESCRIPTION
byf	Toggle Manufacturer's Code
	Receiver Test Fire Proof
	Receiver Inspection/Acceptance Mark

VALUES

POOR	FAIR	GOOD	VG	EXC
\$750	\$1,000	\$1,850	\$2,000	\$2,500

Look-Up Index # 184

MAUSER CODE byf COMMERCIAL

BACKGROUND

The Mauser Code byf Commercial model is an example where a number of military maker code marked toggles got assembled on commercially sold P.08s.

HOW TO TELL A MAUSER CODE byf COMMERCIAL

The Mauser Code byf Commercial can be distinguished from other Lugers by two features in combination.

1. A chamber inscription of "byf."
2. The Mauser Oberndorf Crown/U commercial proof.

QUANTITY MADE

Very few.

RARITY RATING

6, Rare.

FEATURES IN DEPTH

MANUFACTURER: This model was manufactured by Mauser Werke, Oberndorf.

TOGGLE: This model should have the new type toggle, with the flat, checkered toggle knobs.

TOGGLE MARK: byf

BARREL: This model should have a 4-inch (100mm) barrel. It should be chambered for 9mm Parabellum.

FRAME: The frame on this model should be the late, short type with a stock lug, wide trigger and narrow trigger guard.

RECEIVER: The receiver on this model should be the late, short type. The chamber should have a two-digit year date of 42.

THUMB SAFETY: The thumb safety on this model should have a serrated safety lever. The upper position is marked "GESICHERT." Safe is in the lower position.

SIGHTS: The front sight on this model should be a dorsal fin shaped blade, dovetail fit on the barrel. The rear sight should be a fixed V notch in the rear toggle link.

EXTRACTOR: The extractor on this model should be the late type. It should be marked "GELADEN" on the left side.

GRIPS: The grips on this model should be checkered walnut.

MAGAZINE: The magazines original to this model should have a blued, extruded steel body with a black plastic base. They should be marked "fxo" and "P.08," but not serial numbered. Some also marked with an E/37 proof.

FINISH: The finish on this model should be a salt blue, including the small parts. No straw finish was used.

SERIAL NUMBER RANGE: In the v and w serial number suffix blocks.

SERIAL NUMBER LOCATION: The full serial number is found on the bottom of the barrel, the front of the frame, and the left side of the receiver. The last two digits of the serial number are on the breechblock (lower left side), extractor, front toggle link (bottom), rear toggle link (back), sear (left side), sear bar safety lever, side plate, takedown lever (bottom), thumb safety lever (top), trigger (top left), and grips (inside).

INTERESTING VARIATIONS

There are no notable variations of this model.

MARKINGS

MARK	LOCATION/DESCRIPTION
byf	Toggle Manufacturer's Code
	Receiver Nazi-era Commercial Proof

VALUES

POOR	FAIR	GOOD	VG	EXC
\$800	\$1,200	\$1,850	\$2,200	\$2,750

Look-Up Index # 185

MAUSER S/42, Kü

BACKGROUND

The Mauser S/42, Kü model is the source of much debate in the Luger world. What we know for a fact is that these are a legitimate model, made up of Mauser made parts, for military or paramilitary use by Germany. What we strongly suspect, without a smoking gun (pun intended), is that the use was in some way connected

with flying. The Kü proof, which is unique to this, the Mauser 42 Code Kü model, and the Mauser byf Kü model (see below), screams similarity to the Luftwaffe proofs found on Krieghoff P.08s and pocket pistol holsters carried by Luftwaffe aircrews.

The best treatise on the Kü controversy can be found in Gibson's excellent work on Krieghoff Lugers.

HOW TO TELL A MAUSER S/42, Kü

The Mauser S/42, Kü can be distinguished from other Lugers by two features in combination.

1. The toggle is marked "S/42."
2. The serial number on the left side of the receiver is suffixed by "Kü."

QUANTITY MADE

Less than 100.

RARITY RATING

8, Extremely rare.

FEATURES IN DEPTH

MANUFACTURER: This model was manufactured by Mauser Werke, Oberndorf.

TOGGLE: This model should have the new type toggle, with the flat, checkered toggle knobs.

TOGGLE MARK: S/42

BARREL: This model should have a 4-inch (100mm) barrel. It should be chambered for 9mm Parabellum.

FRAME: The frame on this model should be the late, short type with a stock lug, wide trigger and narrow trigger guard. It is marked "P.08" on the left side, near the thumb safety.

RECEIVER: The receiver on this model should be the late, short type. The chamber should have a two-digit year date of 41.

THUMB SAFETY: The thumb safety on this model should have a serrated safety lever. The upper position is marked "GESICHERT." Safe is in the lower position.

SIGHTS: The front sight on this model should be a dorsal fin shaped blade, dovetail fit on the barrel. The rear sight should be a fixed V notch in the rear toggle link.

EXTRACTOR: The extractor on this model should be the late type. It should be marked "GELADEN" on the left side.

GRIPS: The grips on this model should be checkered walnut.

MAGAZINE: The magazines original to this model should have a blued, extruded steel body with a black plastic base. They should be marked "SCHMEISSER," "HAENEL" and/or "fxo," but not serial numbered.

FINISH: The finish on this model should be a salt blue, including the small parts. No straw finish was used.

SERIAL NUMBER RANGE: Kü 3700 to Kü 4400 range.

SERIAL NUMBER LOCATION: The full serial number is found on the bottom of the barrel, the front of the frame, and the left side of the receiver. The last two digits of the serial number are on the breechblock (lower left side), extractor, front toggle link (bottom), rear toggle link (back), sear (left side), sear bar safety lever, side plate, takedown lever (bottom), thumb safety lever (top), trigger (top left), and grips (inside).

INTERESTING VARIATIONS

There are no notable variations of this model.

MARKINGS

MARK	LOCATION/DESCRIPTION
------	----------------------

S/42

Toggle
Manufacturer's Code



Various Parts
Kü Test Fire Proof



Barrel and sometimes Receiver
Army Acceptance Mark

VALUES

POOR	FAIR	GOOD	VG	EXC
\$900	\$1,500	\$2,000	\$2,500	\$3,000

Look-Up Index # 186

MAUSER CODE 42, Kü



BACKGROUND

The Mauser Code 42, Kü model was made for a German military (likely flying-related) customer. It is a continuation of the S/42 marked Kü model.

HOW TO TELL A MAUSER CODE 42, Kü

The Mauser Code 42, Kü can be distinguished from other Lugers by two features in combination.

1. The toggle is marked "42."
2. The serial number on the left side of the receiver is suffixed by "Kü."

QUANTITY MADE

Estimated at 2,300.

RARITY RATING

6, Rare.

FEATURES IN DEPTH

MANUFACTURER: This model was manufactured by Mauser Werke, Oberndorf.

TOGGLE: This model should have the new type toggle, with the flat, checkered toggle knobs.

TOGGLE MARK: 42

BARREL: This model should have a 4-inch (100mm) barrel. It should be chambered for 9mm Parabellum.

FRAME: The frame on this model should be the late, short type with a stock lug, wide trigger and narrow trigger guard. It is marked "P.08" on the left side, near the thumb safety.

RECEIVER: The receiver on this model should be the late, short type. The chamber should have a two-digit year date of 41.

THUMB SAFETY: The thumb safety on this model should have a serrated safety lever. The upper position is marked "GESICHERT." Safe is in the lower position.

SIGHTS: The front sight on this model should be a dorsal fin shaped blade, dovetail fit on the barrel. The rear sight should be a fixed V notch in the rear toggle link.

EXTRACTOR: The extractor on this model should be the late type. It should be marked "GELADEN" on the left side.

GRIPS: The grips on this model should be checkered walnut.

MAGAZINE: The magazines original to this model should have a blued, extruded steel body with a black plastic base. They should be marked "SCHMEISSER," "HAENEL" and/or "fxo," but not serial numbered.

FINISH: The finish on this model should be a salt blue, including the small parts. No straw finish was used.

SERIAL NUMBER RANGE: Kü 2700 to Kü 4700 range.

SERIAL NUMBER LOCATION: The full serial number is found on the bottom of the barrel, the front of the frame, and the left side of the receiver. The last two digits of the serial number are on the breechblock (lower left side),

extractor, front toggle link (bottom), rear toggle link (back), sear (left side), sear bar safety lever, side plate, takedown lever (bottom), thumb safety lever (top), trigger (top left), and grips (inside).

INTERESTING VARIATIONS

There are no notable variations of this model.

MARKINGS

MARK	LOCATION/DESCRIPTION
42	Toggle Manufacturer's Code
	Various Parts Kü Test Fire Proof
	Barrel and sometimes Receiver Army Acceptance Mark

VALUES

POOR	FAIR	GOOD	VG	EXC
\$900	\$1,500	\$2,000	\$2,500	\$3,000

Look-Up Index # 187

MAUSER byf, Kü

BACKGROUND

The Mauser byf, Kü model was made for a German military (likely flying-related) customer. It is a continuation of the code 42-marked Kü model.

HOW TO TELL A MAUSER Kü, byf

The Mauser Kü, byf can be distinguished from other Lugers by two features in combination.

1. The toggle is marked "byf."
2. The serial number on the left side of the receiver is suffixed by "Kü."

QUANTITY MADE

Estimated at 2,700.

RARITY RATING

5, Somewhat rare.

FEATURES IN DEPTH

MANUFACTURER: This model was manufactured by Mauser Werke, Oberndorf.

TOGGLE: This model should have the new type toggle, with the flat, checkered toggle knobs.

TOGGLE MARK: byf

BARREL: This model should have a 4-inch (100mm) barrel. It should be chambered for 9mm Parabellum.

FRAME: The frame on this model should be the late, short type with a stock lug, wide trigger and narrow trigger guard. It is marked "P.08" on the left side, near the thumb safety.

RECEIVER: The receiver on this model should be the late, short type. The chamber should have a two-digit year date of 41 or 42.

THUMB SAFETY: The thumb safety on this model should have a serrated safety lever. The upper position is marked "GESICHERT." Safe is in the lower position.

SIGHTS: The front sight on this model should be a dorsal fin shaped blade, dovetail fit on the barrel. The rear sight should be a fixed V notch in the rear toggle link.

EXTRACTOR: The extractor on this model should be the late type. It should be marked "GELADEN" on the left side.

GRIPS: The grips on this model should be checkered walnut.

MAGAZINE: The magazines original to this model should have a blued, extruded steel body with a black plastic base. They should be marked "SCHMEISSER," "HAENEL" and/or "fxo," but not serial numbered.

FINISH: The finish on this model should be a salt blue, including the small parts. No straw finish was used.

SERIAL NUMBER RANGE: K 1 to K 2700, and sporadically in the K 3550 to K 4300 range.

SERIAL NUMBER LOCATION: The full serial number is found on the bottom of the barrel, the front of the frame, and the left side of the receiver. The last two digits of the serial number are on the breechblock (lower left side), extractor, front toggle link (bottom), rear toggle link (back), sear (left side), sear bar safety lever, side plate, takedown lever (bottom), thumb safety lever (top), trigger (top left), and grips (inside).

INTERESTING VARIATIONS

There are no notable variations of this model.

MARKINGS

MARK	LOCATION/DESCRIPTION
byf	Toggle Manufacturer's Code



Various Parts
Kü Test Fire Proof



Barrel and sometimes Receiver
Army Acceptance Mark

VALUES

POOR	FAIR	GOOD	VG	EXC
\$900	\$1,500	\$2,000	\$2,500	\$3,000

Look-Up Index # 188

KRIEGHOFF K DATE

BACKGROUND

The Krieghoff K Date model was made specifically for Luftwaffe use. This model is likely the first military Krieghoff P.08. These are interspersed with the early S Code model P.08s.

As with the Mauser K Date P.08s, the K date code is for small arms made in 1935, which is before Hitler openly announced German rearmament.

HOW TO TELL A KRIEGHOFF K DATE

The Krieghoff K Date can be distinguished from other Lugers by two features in combination.

1. The Krieghoff Anchor logo on the front toggle link.
2. The chamber is year date marked with a "K," the code for 1935.

QUANTITY MADE

Approximately 50.

RARITY RATING

8, Extremely rare.

FEATURES IN DEPTH

MANUFACTURER: This model was made by Heinrich Krieghoff and Sohn, Suhl.

TOGGLE: This model should have the new type toggle, with the flat, checkered toggle knobs.



BARREL: This model should have a 4-inch (100mm) barrel. It should be chambered for 9mm Parabellum.

FRAME: The frame on this model should be the late, short type with a stock lug, wide trigger and narrow trigger guard.

RECEIVER: The receiver on this model should be the late, short type. The chamber must have the "K" year code mark for 1935.

THUMB SAFETY: The thumb safety on this model should have a serrated safety lever. The upper position is marked "GESICHERT." Safe is in the lower position.

SIGHTS: The front sight on this model should be a dorsal fin shaped blade, dovetail fit on the barrel. The rear sight should be a fixed V notch in the rear toggle link.

EXTRACTOR: The extractor on this model should be the late type. It should be marked "GELADEN" on the left side.

GRIPS: The grips on this model should be molded checkered walnut.

MAGAZINE: The magazines original to this model should have a nickel-plated, wrap-around body with an aluminum base. They should be marked with the LWaA stage 1 acceptance mark and be serial numbered to the pistol.

FINISH: The main finish on this model should be a salt blue. The ejector, magazine catch/release, takedown lever, thumb safety lever and trigger should all be straw colored. The sear bar safety lever is in the white.

SERIAL NUMBER RANGE: 1 to 100.

SERIAL NUMBER LOCATION: The full serial number is found on the front of the frame, the left side of the receiver, the breechblock (lower left side). The barrel on this model usually does NOT have the serial number. The last two digits of the serial number are on the front toggle link (bottom), rear toggle link (back), side plate, takedown lever, trigger (top left), and grips (inside).

INTERESTING VARIATIONS

There are no notable variations of this model.

MARKINGS

MARK **LOCATION/DESCRIPTION**



Toggle
Manufacturer's Mark



Parts & Magazine
Luftwaffe Component
Inspection Mark



Receiver and Barrel
Luftwaffe Test Fire Proof Mark



Receiver and Barrel
Luftwaffe Acceptance/
Inspection Mark

VALUES

POOR	FAIR	GOOD	VG	EXC
\$1,000	\$1,500	\$2,500	\$5,000	\$8,000

Look-Up Index # 189

KRIEGHOFF S CODE, EARLY

BACKGROUND

The Krieghoff S Code, Early model was made specifically for military sales to the Luftwaffe (German Air Force).

HOW TO TELL A KRIEGHOFF S CODE, EARLY

The Krieghoff S Code, Early can be distinguished from other Lugers by three features in combination.

1. The HK anchor logo (without the word Krieghoff) on the front toggle link.
2. A capital "S" inscription above the chamber.
3. The small parts are serial numbered.

QUANTITY MADE

Approximately 2,000.

RARITY RATING

6, Rare.

FEATURES IN DEPTH

MANUFACTURER: This model was made by Heinrich Krieghoff and Sohn, Suhl.

TOGGLE: This model should have the new type toggle, with the flat, checkered toggle knobs.



BARREL: This model should have a 4-inch (100mm) barrel. It should be chambered for 9mm Parabellum.

FRAME: The frame on this model should be the late, short type with a stock lug, wide trigger and narrow trigger guard.

RECEIVER: The receiver on this model should be the late, short type. The Chamber should be marked with the date code "S."

THUMB SAFETY: The thumb safety on this model should have a serrated safety lever. The upper position is marked "GESICHERT." Safe is in the lower position.

SIGHTS: The front sight on this model should be a dorsal fin shaped blade, dovetail fit on the barrel. The rear sight should be a fixed V notch in the rear toggle link.

EXTRACTOR: The extractor on this model should be the late type. It should be marked "GELADEN" on the left side.

GRIPS: The grips on this model should be molded checkered walnut.

MAGAZINE: The magazines original to this model should have a nickel-plated, wrap-around body with an aluminum base. They should be marked with the LWaA stage 1 acceptance mark and be serial numbered to the pistol.

FINISH: The main finish on this model should be a salt blue. The ejector, magazine catch/release, takedown lever, thumb safety lever and trigger should all be straw colored. The sear bar safety lever is in the white.





SERIAL NUMBER RANGE: 1 to 2500 range.

SERIAL NUMBER LOCATION: The full serial number is found on the front of the frame, the left side of the receiver, the breechblock (lower left side). The barrel on this model usually does NOT have the serial number. The last two digits of the serial number are on the front toggle link (bottom), rear toggle link (back), side plate, takedown lever, trigger (top left), and grips (inside).

INTERESTING VARIATIONS

Some examples are found with the thumb safety marked "emin" and extractor marked "ates." These are thought to be of a small number for the Turkish Air Force. There are an estimated 50 of this variation clustered in the 200 to 800 serial number range.

MARKINGS

MARK	LOCATION/DESCRIPTION
	Toggle Manufacturer's Mark
	Parts & Magazine Luftwaffe Component Inspection Mark
	Receiver and Barrel Luftwaffe Test Fire Proof Mark
	Receiver and Barrel Luftwaffe Acceptance/ Inspection Mark

VALUES

POOR	FAIR	GOOD	VG	EXC
\$800	\$1,000	\$1,750	\$3,000	\$5,000

Look-Up Index # 190

KRIEGHOFF S CODE, TRANSITIONAL

BACKGROUND

The Krieghoff S Code, Transitional model was made specifically for military sales to the Luftwaffe (German Air Force). The transitional aspect was merely in the continued use of the Krieghoff logo WITHOUT the word Krieghoff, but the discontinuation of the practice of serial numbering the small parts.

HOW TO TELL A KRIEGHOFF S CODE, TRANSITIONAL

The Krieghoff S Code, Transitional can be distinguished from other Lugers by three features in combination.

1. The HK anchor logo (without the word Krieghoff) on the front toggle link.
2. A capital "S" inscription above the chamber.
3. The small parts are NOT serial numbered.

QUANTITY MADE

Approximately 600.

RARITY RATING

7, Very rare.

FEATURES IN DEPTH

MANUFACTURER: This model was made by Heinrich Krieghoff and Sohn, Suhl.

TOGGLE: This model should have the new type toggle, with the flat, checkered toggle knobs.

TOGGLE MARK: 

BARREL: This model should have a 4-inch (100mm) barrel. It should be chambered for 9mm Parabellum.

FRAME: The frame on this model should be the late, short type with a stock lug, wide trigger and narrow trigger guard.

RECEIVER: The receiver on this model should be the late, short type. The Chamber should be marked with the date code "S."

THUMB SAFETY: The thumb safety on this model should have a serrated safety lever. The upper position is marked "GESICHERT." Safe is in the lower position.

SIGHTS: The front sight on this model should be a dorsal fin shaped blade, dovetail fit on the barrel. The rear sight should be a fixed V notch in the rear toggle link.

EXTRACTOR: The extractor on this model should be the late type. It should be marked "GELADEN" on the left side.

GRIPS: The grips on this model could be either checkered walnut or molded checkered brown plastic with a smooth border. The brown plastic grips should have the fine checkering pattern.

MAGAZINE: The magazines original to this model should have a nickel-plated, wrap-around body with an aluminum base. They should be marked with the LWaA stage 1 acceptance mark and be serial numbered to the pistol.

FINISH: The main finish on this model should be a salt blue. The ejector, magazine catch/release, takedown lever, thumb safety lever and trigger should all be straw colored. The sear bar safety lever is in the white.





SERIAL NUMBER RANGE: 1600 to 3000 range.

SERIAL NUMBER LOCATION: The full serial number is found on the bottom of the barrel, the front of the frame, and the left side of the receiver. The last two digits of the serial number are on the breechblock (lower left side), extractor (bottom), firing pin (random until about 7000), front toggle link (bottom), rear toggle link (back), sear bar, sear bar safety lever, side plate (inside front end), takedown lever (inside), thumb safety lever, trigger (top left), and grips (inside, only on wood grips).

INTERESTING VARIATIONS

There are no notable variations of this model.

MARKINGS

MARK	LOCATION/DESCRIPTION
	Toggle Manufacturer's Mark
	Parts & Magazine Luftwaffe Component Inspection Mark
	Receiver and Barrel Luftwaffe Test Fire Proof Mark
	Receiver and Barrel Luftwaffe Acceptance/ Inspection Mark

VALUES

POOR	FAIR	GOOD	VG	EXC
\$800	\$1,000	\$1,750	\$3,000	\$5,000

Look-Up Index # 191

KRIEGHOFF S CODE, LATE

BACKGROUND

The Krieghoff S Code, Late model was made specifically for military sales to the Luftwaffe (German Air Force).

HOW TO TELL A KRIEGHOFF S CODE, LATE

The Krieghoff S Code, Late can be distinguished from other Lugers by two features in combination.

1. The Krieghoff Anchor logo (with the Krieghoff name) on the front toggle link.
2. A capital "S" inscription above the chamber.

QUANTITY MADE

Approximately 1,750.

RARITY RATING

6, Rare.

FEATURES IN DEPTH

MANUFACTURER: This model was made by Heinrich Krieghoff and Sohn, Suhl.

TOGGLE: This model should have the new type toggle, with the flat, checkered toggle knobs.

TOGGLE MARK:



BARREL: This model should have a 4-inch (100mm) barrel. It should be chambered for 9mm Parabellum.

FRAME: The frame on this model should be the late, short type with a stock lug, wide trigger and narrow trigger guard.

RECEIVER: The receiver on this model should be the late, short type. The Chamber should be marked with the date code "S."

THUMB SAFETY: The thumb safety on this model should have a serrated safety lever. The upper position is marked "GESICHERT." Safe is in the lower position.

SIGHTS: The front sight on this model should be a dorsal fin shaped blade, dovetail fit on the barrel. The rear sight should be a fixed V notch in the rear toggle link.

EXTRACTOR: The extractor on this model should be the late type. It should be marked "GELADEN" on the left side.

GRIPS: The grips on this model could be either checkered walnut or molded checkered brown plastic with a smooth border. The brown plastic grips should have the fine checkering pattern.

MAGAZINE: The magazines original to this model should have a nickel-plated, wrap-around body with an aluminum base. They should be marked with the LWaA stage 1 acceptance mark and be serial numbered to the pistol.

FINISH: The main finish on this model should be a salt blue. The ejector, magazine catch/release, takedown lever, thumb safety lever and trigger should all be straw colored. The sear bar safety lever is in the white.

SERIAL NUMBER RANGE: 2100 to 4200 range.

SERIAL NUMBER LOCATION: The full serial number is found on the bottom of the barrel, the front of the frame, and the left side of the receiver. The last two digits of the serial number are on the breechblock (lower left side), extractor (bottom), firing pin (random until about 7000), front toggle link (bottom), rear toggle link (back), sear bar, sear bar safety lever, side plate (inside front end), takedown lever (inside), thumb safety lever, trigger (top left), and grips (inside, only on wood grips).

INTERESTING VARIATIONS

A very few specimens are known with Turkish marked extractors. One of these has a flat top blade front sight and a square cut notch rear sight. Little is known about the story behind either of these feature differences.

MARKINGS

MARK	LOCATION/DESCRIPTION
------	----------------------



Toggle
Manufacturer's Mark



Parts & Magazine
Luftwaffe Component
Inspection Mark



Receiver and Barrel
Luftwaffe Test Fire Proof Mark



Receiver and Barrel
Luftwaffe Acceptance/
Inspection Mark

VALUES

POOR	FAIR	GOOD	VG	EXC
\$800	\$1,000	\$1,750	\$3,000	\$5,000

Look-Up Index # 192

KRIEGHOFF 36 DATE

BACKGROUND

The Krieghoff 36 Date model was made specifically for Luftwaffe use. This model is interesting in that it was the earliest P.08 to have a two-digit date. Close inspection of the chamber date of these will show irregularities associated with hand cut dies. Since Nazi Germany was still coding the date on small arms in 1935, it is likely that 1936 dated dies were not yet available, and this was a stop-gap measure.

HOW TO TELL A KRIEGHOFF 36 DATE

The Krieghoff 36 Date can be distinguished from other Lugers by two features in combination.

1. The Krieghoff Anchor logo on the front toggle link.
2. The chamber is two-digit year date marked "36."

QUANTITY MADE

Approximately 700.

RARITY RATING

7, Very rare.

FEATURES IN DEPTH

MANUFACTURER: This model was made by Heinrich Krieghoff and Sohn, Suhl.

TOGGLE: This model should have the new type toggle, with the flat, checkered toggle knobs.

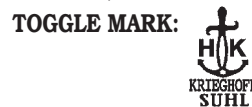

BARREL: This model should have a 4-inch (100mm) barrel. It should be chambered for 9mm Parabellum.

FRAME: The frame on this model should be the late, short type with a stock lug, wide trigger and narrow trigger guard.

RECEIVER: The receiver on this model should be the late, short type. The chamber should have a two-digit year date of 36.

THUMB SAFETY: The thumb safety on this model should have a serrated safety lever. The upper position is marked "GESICHERT." Safe is in the lower position.

SIGHTS: The front sight on this model should be a dorsal fin shaped blade, dovetail fit on the barrel. The rear sight should be a fixed V notch in the rear toggle link.

EXTRACTOR: The extractor on this model should be the late type. It should be marked "GELADEN" on the left side.

GRIPS: The grips on this model should be molded checkered brown plastic with a smooth border. The checkering should be the fine pattern checkering.

MAGAZINE: The magazines original to this model should have a nickel-plated, wrap-around body with an aluminum base. Some very late ones could be found with extruded chromium plated bodies. In either case, they should be marked with the LWaA stage 1 acceptance mark and be serial numbered to the pistol.

FINISH: The main finish on this model should be a salt blue. The ejector, magazine catch/release, takedown lever, thumb safety lever and trigger should all be straw colored. The sear bar safety lever is in the white.





SERIAL NUMBER RANGE: 3800 to 4700 range. There is overlap in the lower portion of the range with the Late S dated model, and in the upper portion of the range with the 1936 dated models.

SERIAL NUMBER LOCATION: The full serial number is found on the front of the frame, the left side of the receiver, the breechblock (lower left side). The barrel on this model usually does NOT have the serial number. The last two digits of the serial number are on the front toggle link (bottom), rear toggle link (back), side plate, takedown lever, trigger (top left), and grips (inside).

INTERESTING VARIATIONS

There is one specimen documented with a Krieghoff proofed, S/42 (Mauser) marked toggle. There are no Mauser inspection or proof marks on the piece.

MARKINGS

MARK	LOCATION/DESCRIPTION
	Toggle Manufacturer's Mark
	Parts & Magazine Luftwaffe Component Inspection Mark
	Receiver and Barrel Luftwaffe Test Fire Proof Mark
	Receiver and Barrel Luftwaffe Acceptance/ Inspection Mark

VALUES

POOR	FAIR	GOOD	VG	EXC
\$900	\$1,200	\$2,250	\$3,500	\$5,000

Look-Up Index # 193

KRIEGHOFF GRIP SAFETY

BACKGROUND

Some Luger models are enigmatic and defy concise explanation. The Krieghoff grip safety model is one of them. Some believe these were made for test and evaluation by the Luftwaffe. Apparently the Luftwaffe wished to evaluate various safety markings and configurations. However, the fact that the few known examples appear to be reworks raises the question of the original and final purpose for these pistols.

HOW TO TELL A KRIEGHOFF GRIP SAFETY

The Krieghoff grip safety can be distinguished from other Lugers by two features in combination.

1. The Krieghoff Anchor logo on the front toggle link.
2. A grip safety on the backstrap of the grip.

QUANTITY MADE

Only 5 known.

RARITY RATING

8, Extremely rare.

FEATURES IN DEPTH

MANUFACTURER: This model was made by Heinrich Krieghoff and Sohn, Suhl.

TOGGLE: This model should have the new type toggle, with the flat, checkered toggle knobs.



BARREL: This model should have a 4-inch (100mm) barrel. It should be chambered for 9mm Parabellum.

FRAME: The frame on this model should be the late, short type with a wide trigger and narrow trigger guard. It could be found either with or without a stock lug.

RECEIVER: The receiver on this model should be the late, short type. The chamber should be blank.

THUMB SAFETY: The thumb safety on this model should have a serrated safety lever. It could be marked either "FEUER" in the lower position or "GESICHERT" in the upper position. Safe is in the lower position.

SIGHTS: The front sight on this model should be a dorsal fin shaped blade, dovetail fit on the barrel. The rear sight should be a fixed V notch in the rear toggle link.

EXTRACTOR: The extractor on this model should be the late type. It should be marked "GELADEN" on the left side.

GRIPS: The grips on this model should be molded checkered brown plastic with a smooth border. The left grip should be slotted for the grip safety. The checkering could be either the course or fine pattern checkering.

MAGAZINE: The magazines original to this model should have a nickel-plated, wrap-around body with an aluminum base. They may be either serial numbered to the pistol or marked with the LWaA stage 1 acceptance mark, or both.

FINISH: The main finish on this model should be a salt blue. The ejector, magazine catch/release, takedown lever, thumb safety lever and trigger should all be straw colored. The sear bar safety lever is in the white.

SERIAL NUMBER RANGE: 1 to three-digits, no letter suffix.

SERIAL NUMBER LOCATION: The full serial number is found on the bottom of the barrel and on the front of the frame. The last two digits of the serial number may be found on some of the small parts.

INTERESTING VARIATIONS

The thumb safety markings and stock lug options constitute the only known variation in this model.

MARKINGS

MARK **LOCATION/DESCRIPTION**



Toggle
Manufacturer's Mark



Receiver and Parts
Krieghoff Acceptance Mark



Receiver
Krieghoff Acceptance Mark

VALUES

POOR	FAIR	GOOD	VG	EXC
\$850	\$1,500	\$2,500	\$4,000	\$6,000

Look-Up Index # 194

KRIEGHOFF DATED

BACKGROUND

The Krieghoff Dated model was made specifically for military sales to the Luftwaffe (German Air Force).

HOW TO TELL A KRIEGHOFF DATED

The Krieghoff Dated can be distinguished from other Lugers by two features in combination.

1. The Krieghoff Anchor logo on the front toggle link.
2. A four-digit year date inscription, from 1936 to 1944, above the chamber.

QUANTITY MADE

Approximately 10,000 broken down by year as follows:

1936	2,850
1937	3,000
1938	450
1939	None made
1940	1,100
1941	225
1942	300
1943	300
1944	100

RARITY RATING

Rarity differs by year.

Dates 1936 to 1940 rate a 6, Rare.

Dates 1941 to 1944 rate an 8, Extremely rare.

FEATURES IN DEPTH

MANUFACTURER: This model was made by Heinrich Krieghoff and Sohn, Suhl.

TOGGLE: This model should have the new type toggle, with the flat, checkered toggle knobs.

TOGGLE MARK:



BARREL: This model should have a 4-inch (100mm) barrel. It should be chambered for 9mm Parabellum.

FRAME: The frame on this model should be the late, short type with a stock lug, wide trigger and narrow trigger guard.

RECEIVER: The receiver on this model should be the new, short type. The chamber should have a four-digit year date from 1936 to 1944.

THUMB SAFETY: The thumb safety on this model should have a serrated safety lever. The upper position is marked "GESICHERT." Safe is in the lower position.

SIGHTS: The front sight on this model should be a dorsal fin shaped blade, dovetail fit on the barrel. The rear sight should be a fixed V notch in the rear toggle link.

EXTRACTOR: The extractor on this model should be the late type. It should be marked "GELADEN" on the left side.

GRIPS: The grips on this model should be molded coarse checkered brown plastic with a smooth border found up through 1938. 1940 dated and later should have molded coarse checkered black plastic grips.

MAGAZINE: The magazines original to this model underwent several changes over a short period of time.

- * Early 1936 dates should have a nickel-plated wrap-around body with an aluminum base. They should be marked with the LWaA stage 1 inspection mark and be serial numbered to the pistol.
- * Mid 1936 through 1937 dates should have a chromium plated wrap-around body with an aluminum base. They should be marked with the LWaA stage 1 inspection mark and be serial numbered to the pistol.
- * Some late 1937 dates and early 1938 dates could have a blued wrap-around body with an aluminum base. They should be marked with the LWaA stage 1 acceptance mark and be serial numbered to the pistol.
- * 1938 through 1940 dates should have a blued extruded body with an aluminum base. They should be marked "fxo," "P.08," with the LWaA stage 1 acceptance mark, and be serial numbered to the pistol.
- * A few 1938 dates and most 1940 through 1943 dates should have a blued extruded body with an aluminum base. They should be marked "122," with the E/37 acceptance mark, and be serial numbered to the pistol.
- * 1944 dates should have a blued extruded body with a black plastic base. They should be marked "fxo," "P.08," with an LWaA stage 1 acceptance mark, and be serial numbered to the pistol.

FINISH: The main finish on this model should be a salt blue. The ejector, magazine catch/release, takedown lever, thumb safety lever and trigger should all be straw colored. The sear bar safety lever is in the white.

SERIAL NUMBER RANGE:

- 4400 to 14000 range.
- 4400 to 7500 in 1936.
- 6800 to 10000 in 1937.
- 9500 to 10100 in 1938.
- None dated 1939.
- 10000 to 12000 in 1940.
- 11000 to 12000 in 1941.
- 11100 to 12000 in 1942.
- 11300 to 11800 in 1943.
- 11200 to 12000 in 1944.

SERIAL NUMBER LOCATION: The full serial number is found on the bottom of the barrel, the front of the frame, and the left side of the receiver. The last two digits of the serial number are on the breechblock (lower left side), extractor (bottom), firing pin (random until about 7000), front toggle link (bottom), rear toggle link (back), sear bar, sear bar safety lever, side plate (inside front end), takedown lever (inside), thumb safety lever, and trigger (top left).

INTERESTING VARIATIONS

There are about 100 1941 dated specimens which have a smaller size chamber date. These tend to be clustered in the 11100 to 11300 and 11600 to 12000 ranges. The full size 1941 dates seem to be the more rare.

WARNING: 1945-dated Krieghoff Lugers should be treated with much skepticism. No verified examples are known. A now well-known string of fake 1945 dates was recently shown as such. All 1945 dates are phony until proven otherwise.

MARKINGS

MARK	LOCATION/DESCRIPTION
------	----------------------



Toggle
Manufacturer's Mark



Parts & Magazine
Luftwaffe Component
Inspection Mark

and/or



Parts & Magazine
Luftwaffe Component
Inspection Mark

and/or



Parts & Magazine
Luftwaffe Component
Inspection Mark

The three preceding marks represent the evolution of the Luftwaffe Component Inspection Mark from 1936 to 1944. The top mark has been observed on Krieghoff P.08s as late as 1940. The second one (curved wings) first appeared in very late 1936. Parts so marked seem to have been exhausted during 1940. The third one (trapezoid) was the standard part inspection mark, showing up in 1937 and used for the rest of the war.



Receiver and Barrel
Luftwaffe Test Fire Proof Mark



Receiver and Barrel
Luftwaffe Acceptance
Inspection Mark

and/or



Receiver and Barrel
Luftwaffe Acceptance
Inspection Mark

The two preceding marks represent the evolution of the Luftwaffe Acceptance/Inspection mark from 1936 to 1944. The top mark has been observed on Krieghoff P.08s as late as 1937. The bottom one (trapezoid) first appeared in 1938 and ran through the rest of Luftwaffe Krieghoff production.



Frame under Grip
Krieghoff Inspection Mark
Not always present

VALUES

POOR	FAIR	GOOD	VG	EXC
\$800	\$1,000	\$2,000	\$4,000	\$7,500

Look-Up Index # 195

KRIEGHOFF P CODE, SIDE INSCRIBED

BACKGROUND

The Krieghoff P Code, Side Inscribed model was generically made for commercial sales within Germany. Most of these were built following the initial Luftwaffe contract from rejected Lugers.

HOW TO TELL A KRIEGHOFF P CODE, SIDE INSCRIBED

The Krieghoff P Code, Side Inscribed can be distinguished from other Lugers by three features in combination.

1. The Krieghoff Anchor logo on the front toggle link.
2. The left side of the receiver is inscribed "Heinrich Krieghoff Waffenfabrik Suhl."
3. The serial number is prefixed by a capital P.

QUANTITY MADE

1,000.

RARITY RATING

6, Rare.

FEATURES IN DEPTH

MANUFACTURER: This model was made by Heinrich Krieghoff and Sohn, Suhl.

TOGGLE: This model should have the new type toggle, with the flat, checkered toggle knobs.

TOGGLE MARK:



BARREL: This model should have a 4-inch (100mm) barrel. Most are chambered for 9mm Parabellum. A very few are chambered for 7.65mm (.30 Luger). Examples exist with 6-inch (150mm) barrels in either caliber.

FRAME: The frame on this model should be the late, short type with a stock lug, wide trigger and narrow trigger guard.

RECEIVER: The receiver on this model should be the late, short type. The chamber should be blank.

THUMB SAFETY: The thumb safety on this model should have a serrated safety lever. The upper position is marked "GESICHERT." Safe is in the lower position.

SIGHTS: The front sight on this model should be a dorsal fin shaped blade, dovetail fit on the barrel. The rear sight should be a fixed V notch in the rear toggle link.

EXTRACTOR: The extractor on this model should be the late type. It should be marked "GELADEN" on the left side.

GRIPS: The grips on this model should be molded checkered brown plastic with a smooth border. The checkering should be the course pattern checkering.

MAGAZINE: The magazines original to this model should have either a nickel-plated, wrap-around body or a extruded chromium plated body. In either case it should have an aluminum base. They most likely are neither serial numbered nor proof marked.

FINISH: The main finish on this model should be a salt blue. The ejector, magazine catch/release, takedown lever, thumb safety lever and trigger should all be straw colored. The sear bar safety lever is in the white.

SERIAL NUMBER RANGE: P1 to P1000.

SERIAL NUMBER LOCATION: The full serial number is found on the bottom of the barrel, the front of the frame, and the left side of the receiver. The last two digits of the serial number are on the breechblock (lower left side), extractor (bottom), firing pin (random until about 7000), front toggle link (bottom), rear toggle link (back), sear bar, sear bar safety lever, side plate (inside front end), takedown lever (inside), thumb safety lever, and trigger (top left).

INTERESTING VARIATIONS

One unverified example with an 8-inch (200mm) barrel is reported.

MARKINGS

MARK **LOCATION/DESCRIPTION**



Toggle
Manufacturer's Mark



Parts
Luftwaffe Component
Inspection Mark

and/or



Parts
Luftwaffe Component
Inspection Mark

and/or



Parts
Luftwaffe Component
Inspection Mark

The three preceding marks represent the evolution of the Luftwaffe Component Inspection Mark from 1936 to 1944. The top mark has been observed on Krieghoff P.08s as late as 1940. The second one (curved wings) first appeared in very late 1936. Parts so marked seem to have been exhausted during 1940. The third one (trapezoid) was the standard part inspection mark, showing up in 1937 and used for the rest of the war.



Receiver
Reject Mark

or



Receiver
Reject Mark



Receiver
Nitro Commercial Proof

VALUES

POOR	FAIR	GOOD	VG	EXC
\$850	\$1,250	\$2,750	\$3,250	\$4,000

Look-Up Index # 196

KRIEGHOFF PRE-WAR COMMERCIAL

BACKGROUND

The Krieghoff Pre-War Commercial model was generically made for commercial sales within Germany. Like all Krieghoff Lugers, these began life on the military production line. What sets these apart is that they were SERIAL NUMBERED in the military range, but were rejected and later made into commercial pistols.

HOW TO TELL A KRIEGHOFF PRE-WAR COMMERCIAL

The Krieghoff Pre-War Commercial can be distinguished from other Lugers by three features in combination.

1. The Krieghoff Anchor logo on the front toggle link.
2. The serial number is NOT preceded by a capital P.
3. The test fire proof is the pre-war Crown/N type.

QUANTITY MADE

50.

RARITY RATING

8, Extremely rare.

FEATURES IN DEPTH

MANUFACTURER: This model was made by Heinrich Krieghoff and Sohn, Suhl.

TOGGLE: This model should have the new type toggle, with the flat, checkered toggle knobs.

TOGGLE MARK:



BARREL: This model should have a 4-inch (100mm) barrel. Most chambered for 9mm Parabellum. A very few chambered for 7.65mm (.30 Luger).

FRAME: The frame on this model should be the late, short type with a stock lug, wide trigger and narrow trigger guard.

RECEIVER: The receiver on this model should be the late, short type. The chamber should be blank.

THUMB SAFETY: The thumb safety on this model should have a serrated safety lever. The upper position is marked "GESICHERT." Safe is in the lower position.

SIGHTS: The front sight on this model should be a dorsal fin shaped blade, dovetail fit on the barrel. The rear sight should be a fixed V notch in the rear toggle link.

EXTRACTOR: The extractor on this model should be the late type. It should be marked “GELADEN” on the left side.

GRIPS: The grips on this model should be molded checkered brown plastic with a smooth border. The checkering should be the course pattern checkering.

MAGAZINE: The magazines original to this model should have an extruded blued body with an aluminum base. They most likely are neither serial numbered nor proof marked.

FINISH: The main finish on this model should be a salt blue. The ejector, magazine catch/release, takedown lever, thumb safety lever and trigger should all be straw colored. The sear bar safety lever is in the white.

SERIAL NUMBER RANGE: 10600 to 10900.

SERIAL NUMBER LOCATION: The full serial number is found on the bottom of the barrel, the front of the frame, and the left side of the receiver. The last two digits of the serial number are on the breechblock (lower left side), extractor (bottom), firing pin (random until about 7000), front toggle link (bottom), rear toggle link (back), sear bar, sear bar safety lever, side plate (inside front end), takedown lever (inside), thumb safety lever, and trigger (top left).

INTERESTING VARIATIONS

There are no notable variations of this model.

MARKINGS

MARK **LOCATION/DESCRIPTION**



Toggle
Manufacturer’s Mark



Parts
Luftwaffe Component
Inspection Mark

and/or



Parts
Luftwaffe Component
Inspection Mark

and/or



Parts
Luftwaffe Component
Inspection Mark

The three preceding marks represent the evolution of the Luftwaffe Component Inspection Mark from 1936 to 1944. The top mark has been observed on Krieghoff P.08s as late as 1940. The second one (curved wings) first appeared in very late 1936. Parts so marked seem to have been exhausted during 1940. The third one

(trapezoid) was the standard part inspection mark, showing up in 1937 and used for the rest of the war.



Frame (under grip)
Krieghoff Inspection Mark
Not always present



Receiver
Reject Mark

or



Receiver
Reject Mark



Receiver
Nitro Commercial Proof

VALUES

POOR	FAIR	GOOD	VG	EXC
\$800	\$1,250	\$2,000	\$3,200	\$4,000

Look-Up Index # 197

KRIEGHOFF P CODE, PRE-WAR

BACKGROUND

The Krieghoff P Code, Pre-War model was generically made for commercial sales within Germany.

HOW TO TELL A KRIEGHOFF P CODE, PRE-WAR

The Krieghoff P Code, Pre-War can be distinguished from other Lugers by three features in combination.

1. The Krieghoff Anchor logo on the front toggle link.
2. The left side of the receiver is NOT inscribed “Heinrich Krieghoff Waffenfabrik Suhl.”
3. Serial number above P1000 and preceded by a capital P.

QUANTITY MADE

200.

RARITY RATING

7, Very rare.

FEATURES IN DEPTH

MANUFACTURER: This model was made by Heinrich Krieghoff and Sohn, Suhl.

TOGGLE: This model should have the new type toggle, with the flat, checkered toggle knobs.

TOGGLE MARK:



BARREL: This model should have a 4-inch (100mm) barrel. Most chambered for 9mm Parabellum. A very few chambered for 7.65mm (.30 Luger).

FRAME: The frame on this model should be the late, short type with a stock lug, wide trigger and narrow trigger guard.

RECEIVER: The receiver on this model should be the late, short type. The chamber should be blank. A few are dated 1937.

THUMB SAFETY: The thumb safety on this model should have a serrated safety lever. The upper position is marked "GESICHERT." Safe is in the lower position.

SIGHTS: The front sight on this model should be a dorsal fin shaped blade, dovetail fit on the barrel. The rear sight should be a fixed V notch in the rear toggle link.

EXTRACTOR: The extractor on this model should be the late type. It should be marked "GELADEN" on the left side.

GRIPS: The grips on this model should be molded checkered brown plastic with a smooth border. The checkering should be the course pattern checkering.

MAGAZINE: The magazines original to this model should have an extruded blued body with an aluminum base. They are neither proof marked nor serial numbered.

FINISH: The main finish on this model should be a salt blue. The ejector, magazine catch/release, takedown lever, thumb safety lever and trigger should all be straw colored. The sear bar safety lever is in the white.

SERIAL NUMBER RANGE: P1001 to P1280. The 1937 dated examples are in the P1240 to P1260 range.

SERIAL NUMBER LOCATION: The full serial number is found on the bottom of the barrel, the front of the frame, and the left side of the receiver. The last two digits of the serial number are on the breechblock (lower left side), extractor (bottom), firing pin (random until about 7000), front toggle link (bottom), rear toggle link (back), sear bar, sear bar safety lever, side plate (inside front end), takedown lever (inside), thumb safety lever, and trigger (top left).

INTERESTING VARIATIONS

There are no notable variations of this model.

MARKINGS

MARK LOCATION/DESCRIPTION



Toggle
Manufacturer's Mark



Parts
Luftwaffe Component
Inspection Mark

and/or

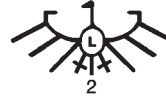

Parts
Luftwaffe Component
Inspection Mark

and/or



Parts
Luftwaffe Component
Inspection Mark

The three preceding marks represent the evolution of the Luftwaffe Component Inspection Mark from 1936 to 1944. The top mark has been observed on Krieghoff P.08s as late as 1940. The second one (curved wings) first appeared in very late 1936. Parts so marked seem to have been exhausted during 1940. The third one (trapezoid) was the standard part inspection mark, showing up in 1937 and used for the rest of the war.



Frame (under grip)
Krieghoff Inspection Mark
Not always present



Receiver
Reject Mark

or



Receiver
Reject Mark



Receiver
Nitro Commercial Proof

VALUES

POOR	FAIR	GOOD	VG	EXC
\$800	\$1,250	\$2,000	\$3,200	\$4,000

Look-Up Index # 198

KRIEGHOFF WARTIME COMMERCIAL

BACKGROUND

The Krieghoff Wartime Commercial model was generically made for commercial sales within Germany.

HOW TO TELL A KRIEGHOFF WARTIME COMMERCIAL

The Krieghoff Wartime Commercial can be distinguished from other Lugers by three features in combination.

1. The Krieghoff Anchor logo on the front toggle link.
2. The left side of the receiver is NOT inscribed "Heinrich Krieghoff Waffenfabrik Suhl."
3. Serial number in the range of P1 to P100.

QUANTITY MADE

At least 100.

RARITY RATING

8, Extremely rare.

FEATURES IN DEPTH

MANUFACTURER: This model was made by Heinrich Krieghoff and Sohn, Suhl.

TOGGLE: This model should have the new type toggle, with the flat, checkered toggle knobs.

TOGGLE MARK:



BARREL: This model should have a 4-inch (100mm) barrel. Most chambered for 9mm Parabellum. A very few chambered for 7.65mm (.30 Luger).

FRAME: The frame on this model should be the late, short type with a stock lug, wide trigger and narrow trigger guard.

RECEIVER: The receiver on this model should be the late, short type. The chamber should be blank.

THUMB SAFETY: The thumb safety on this model should have a serrated safety lever. The upper position is marked "GESICHERT." Safe is in the lower position.

SIGHTS: The front sight on this model should be a dorsal fin shaped blade, dovetail fit on the barrel. The rear sight should be a fixed V notch in the rear toggle link.

EXTRACTOR: The extractor on this model should be the late type. It should be marked "GELADEN" on the left side.

GRIPS: The grips on this model should be molded checkered black plastic with a smooth border.

MAGAZINE: The magazines original to this model should have an extruded blued body with either an aluminum or plastic base. They are neither proof marked nor serial numbered.

FINISH: The main finish on this model should be a salt blue. The ejector, magazine catch/release, takedown lever, thumb safety lever and trigger should all be straw colored. The sear bar safety lever is in the white.

SERIAL NUMBER RANGE: P1 to P100 (perhaps slightly beyond that. Reported as high as P503). Note: this is a completely different (repeated) serial number run from the P Code, Side Inscription model.

SERIAL NUMBER LOCATION: The full serial number is found on the bottom of the barrel, the front of the frame, and the left side of the receiver. The last two digits of the serial number are on the breechblock (lower left side), extractor (bottom), firing pin (random until about 7000), front toggle link (bottom), rear toggle link (back), sear bar, sear bar safety lever, side plate (inside front end), takedown lever (inside), thumb safety lever, and trigger (top left).

INTERESTING VARIATIONS

There are no notable variations of this model.

MARKINGS

MARK	LOCATION/DESCRIPTION
------	----------------------



Toggle
Manufacturer's Mark



Parts
Luftwaffe Component
Inspection Mark

and/or

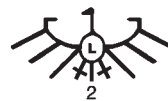

Parts
Luftwaffe Component
Inspection Mark

and/or



Parts
Luftwaffe Component
Inspection Mark

The three preceding marks represent the evolution of the Luftwaffe Component Inspection Mark from 1936 to 1944. The top mark has been observed on Krieghoff P.08s as late as 1940. The second one (curved wings) first appeared in very late 1936. Parts so marked seem to have been exhausted during 1940. The third one

(trapezoid) was the standard part inspection mark, showing up in 1937 and used for the rest of the war.



Receiver
Reject Proof



Receiver
Nitro Commercial Proof

VALUES

POOR	FAIR	GOOD	VG	EXC
\$800	\$1,250	\$2,000	\$3,200	\$4,000

Look-Up Index # 199

KRIEGHOFF POST-WAR COMMERCIAL

BACKGROUND

The Krieghoff Post-War Commercial model was made for general commercial sales (possibly PX sales) to post war occupation forces. This model used up the last of the Krieghoff marked toggles.

By this point, the pursuit of war trophies by GIs was fueling the cobbling together as just about any available parts which would still constitute a complete pistol. There are probably up to a dozen nearly unique Krieghoff post-war Lugers known to exist. Some differences are in having unfinished or oddly strawed parts, unusual, incomplete or missing serial numbering, and unusual barrel lengths.

HOW TO TELL A KRIEGHOFF POST-WAR COMMERCIAL

The Krieghoff Post-War Commercial 9mm can be distinguished from other Lugers by two features in combination.

1. It has the Krieghoff Anchor logo on the front toggle link.
2. It has no test fire proof (either commercial or military).

QUANTITY MADE

Approximately 230.

RARITY RATING

7, Very rare.

FEATURES IN DEPTH

MANUFACTURER: This model was made by Heinrich Krieghoff and Sohn, Suhl.

TOGGLE: This model should have the new type toggle, with the flat, checkered toggle knobs.

TOGGLE MARK:



BARREL: This model should have a 4-inch (100mm) barrel. It should be chambered for 9mm Parabellum.

FRAME: The frame on this model should be the late, short type with a stock lug, wide trigger and narrow trigger guard.

RECEIVER: The receiver on this model should be the late, short type. The chamber should be blank.

THUMB SAFETY: The thumb safety on this model should have a serrated safety lever. The upper position is marked "GESICHERT." Safe is in the lower position.

SIGHTS: The front sight on this model should be a dorsal fin shaped blade, dovetail fit on the barrel. The rear sight should be a fixed V notch in the rear toggle link.

EXTRACTOR: The extractor on this model should be the early-type. It should be marked "GELADEN."

GRIPS: The grips on this model should be molded coarse checkered black plastic with a smooth border.

MAGAZINE: The magazines original to this model should have a blued, extruded steel body with either an aluminum or black plastic base. The latter should be marked "SCHMEISSER," "HAENEL" and/or "fxo," but not serial numbered.

FINISH: The main finish on this model should be a salt blue. The ejector, magazine catch/release, takedown lever, thumb safety lever and trigger should all be straw colored.

SERIAL NUMBER RANGE: 10 to 250.

SERIAL NUMBER LOCATION: The full serial number is found on the front of the frame and the left side of the receiver. The barrel is typically NOT serial numbered. The numbering on the receiver is noticeably larger than normal.

INTERESTING VARIATIONS

A very few are documented with an early HK Anchor Suhl (without the word KRIEGHOFF) marked toggle.

MARKINGS

MARK **LOCATION/DESCRIPTION**



Toggle
Manufacturer's Mark

or



Toggle
Manufacturer's Mark



Parts
Luftwaffe Component
Inspection Mark

and/or



Parts
Luftwaffe Component
Inspection Mark

and/or



Parts
Luftwaffe Component
Inspection Mark

The three preceding marks represent the evolution of the Luftwaffe Component Inspection Mark from 1936 to 1944. The top mark has been observed on Krieghoff P.08s as late as 1940. The second one (curved wings) first appeared in very late 1936. Parts so marked seem to have been exhausted during 1940. The third one (trapezoid) was the standard part inspection mark, showing up in 1937 and used for the rest of the war.



Frame (under grip)
Krieghoff Inspection Mark
Not always present



Receiver and Barel
Luftwaffe Acceptance
Inspection Mark



Receiver
Reject Mark

or



Receiver
Reject Mark

or



Receiver
Reject Proof

VALUES

POOR	FAIR	GOOD	VG	EXC
\$1,250	\$1,500	\$1,750	\$2,500	\$3,500

Look-Up Index # 200

KRIEGHOFF POST-WAR UNMARKED

BACKGROUND

The Krieghoff Post-War Unmarked model was made for general commercial sales (possibly PX sales) to post-war occupation forces. It represents the sunset to original German Luger production.

By this point, the pursuit of war trophies by GIs was fueling the cobbling together of just about any available parts which would still constitute a complete pistol. There are probably up to a dozen nearly unique Krieghoff post-war Lugers known to exist. Some differences are in having unfinished or oddly strawed parts, unusual, incomplete or missing serial numbering, and unusual barrel lengths.

HOW TO TELL A KRIEGHOFF POST-WAR UNMARKED

The Krieghoff Post-War Unmarked can be distinguished from other Lugers by two features in combination.

1. Unmarked toggle.
2. It has some form of LWaA component inspection mark.

QUANTITY MADE

Approximately 200.

RARITY RATING

7, Very rare.

FEATURES IN DEPTH

MANUFACTURER: This model was made by Heinrich Krieghoff and Sohn, Suhl.

TOGGLE: This model should have the new type toggle, with the flat, checkered toggle knobs.

TOGGLE MARK: The toggle on this model should be blank.

BARREL: This model should have a 4-inch (100mm) barrel. Most chambered for 9mm Parabellum. A very few chambered for 7.65mm (.30 Luger).

FRAME: The frame on this model should be the late, short type with a stock lug, wide trigger and narrow trigger guard.

RECEIVER: The receiver on this model should be the late, short type. The chamber should be blank.

THUMB SAFETY: The thumb safety on this model should have a serrated safety lever. The upper position is marked "GESICHERT." Safe is in the lower position.

SIGHTS: The front sight on this model should be a dorsal fin shaped blade, dovetail fit on the barrel. The rear sight should be a fixed V notch in the rear toggle link.

EXTRACTOR: The extractor on this model should be the late type. The left side could be marked "GELADEN" or it could be blank.

GRIPS: The grips on this model should be molded coarse checkered black plastic with a smooth border.

MAGAZINE: The magazines original to this model should have a blued, extruded steel body with either an aluminum or black plastic base. They should be marked "SCHMEISSER," "HAENEL" and/or "fxo," but not serial numbered.

FINISH: The main finish on this model should be a salt blue. The ejector, magazine catch/release, takedown lever, thumb safety lever and trigger should all be straw colored.

SERIAL NUMBER RANGE: 1 to 200 range.

SERIAL NUMBER LOCATION: The full serial number is found on the front of the frame. The barrel is typically NOT serial numbered. The left side of the receiver is sometimes serial numbered. The numbering on the receiver is noticeably larger than normal.

INTERESTING VARIATIONS

There are no notable variations of this model.

MARKINGS

MARK	LOCATION/DESCRIPTION
------	----------------------



Toggle
Manufacturer's Mark

or



Toggle
Manufacturer's Mark



Parts
Luftwaffe Component
Inspection Mark

and/or

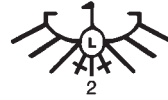

Parts
Luftwaffe Component
Inspection Mark

and/or



Parts
Luftwaffe Component
Inspection Mark

The three preceding marks represent the evolution of the Luftwaffe Component Inspection Mark from 1936 to 1944. The top mark has been observed on Krieghoff P.08s as late as 1940. The second one (curved wings) first appeared in very late 1936. Parts so marked seem to have been exhausted during 1940. The third one (trapezoid) was the standard part inspection mark, showing up in 1937 and used for the rest of the war.



Frame (under grip)
Krieghoff Inspection Mark
Not always present



Receiver and Barel
Luftwaffe Acceptance
Inspection Mark



Receiver
Reject Mark

or



Receiver
Reject Mark

or



Receiver
Reject Proof



Frame
Krieghoff Wartime Test Fire
Proof Mark



Frame
Luftwaffe Proof

VALUES

POOR	FAIR	GOOD	VG	EXC
\$1,250	\$1,500	\$1,750	\$2,500	\$3,500

Look-Up Index # 201

AUSTRIAN BUNDES HEER REWORK

BACKGROUND

The Austrian Bundes Heer Rework model was a post WW II rework of captured and surrendered Lugers for the Austrian Federal Army (Bundes Heer).

Even though these are a post WW II rework, since they were Austrian (as was Hitler) their reuse in a post Nazi-era makes a nice final model which absolutely closed the book on original Luger pistols.

HOW TO TELL AN AUSTRIAN BUNDES HEER REWORK

The Austrian Bundes Heer Rework can be distinguished from other Lugers by one distinct feature.

1. The Austrian BH proof is on the left side of the receiver, just below the takedown lever.

QUANTITY MADE

Estimated at a couple thousand.

RARITY RATING

5, Somewhat rare.

FEATURES IN DEPTH

MANUFACTURER: These reworks could theoretically be from any manufacture. Mauser Banner models are most noted.

TOGGLE: This model should have the new type toggle, with the flat, checkered toggle knobs.

TOGGLE MARK:  , others possible.

BARREL: This model should have a 4-inch (100mm) barrel. It should be chambered for 9mm Parabellum.

FRAME: The frame on this model should be the late, short type with a stock lug, wide trigger and narrow trigger guard. Some marked "P.08" on the left side, near the thumb safety.

RECEIVER: The receiver on this model should be the late, short type. The chamber could be blank or dated.

THUMB SAFETY: The thumb safety on this model should have a serrated safety lever. The upper position is marked "GESICHERT." Safe is in the lower position.

SIGHTS: The front sight on this model should be a dorsal fin shaped blade, dovetail fit on the barrel. The

rear sight should be a fixed V notch in the rear toggle link.

EXTRACTOR: The extractor on this model should be the late type. It should be marked "GELADEN" on the left side.

GRIPS: The grips on this model should be checkered walnut.

MAGAZINE: These reworks should have the magazines from the original model.

FINISH: The main finish on this model should be a high-quality rust blue. The ejector, magazine catch/release, takedown lever, thumb safety lever and trigger should all be straw colored.

SERIAL NUMBER RANGE: These reworks should retain the serial numbering from the original model.

SERIAL NUMBER LOCATION: The full serial number is found on the bottom of the barrel, the front of the frame, and the left side of the receiver. The last two digits of the serial number are on the breechblock (lower left side), extractor, front toggle link (bottom), rear toggle link (back), sear (left side), sear bar safety lever, side plate, takedown lever (bottom), thumb safety lever (top), trigger (top left), and grips (inside).

INTERESTING VARIATIONS

There are no notable variations of this model.

MARKINGS

MARK	LOCATION/DESCRIPTION
------	----------------------

The pistols of this model should retain their original acceptance and proof marks (which could be commercial or military). In addition, the defining feature of this rework model is the following mark.



Receiver
Austrian Bundes Heer Proof

VALUES

POOR	FAIR	GOOD	VG	EXC
\$500	\$750	\$1,250	\$2,000	\$2,500

Chapter 8

Luger Accessories

There was a TV commercial for laptop computers in which one guy was bragging about having the thinnest, most portable, high performance machine available. It made him a *ëplayeri*. The guy next to him pulls out the same model high-end laptop and flaunts his leather carrying case. The first guy emotionally deflates as his bragging rights have been trumped.

In the same way, accessories are what set a great Luger collection apart from a very good one. The bragging rights of the alpha male are based on complete rigs, extra magazines, detachable shoulder stocks, manuals, and boxes.

BOXES

When you get a new watch or a new TV, do you keep the box? If you are like me, that answer is probably no. Well for that same reason, original boxes for commercial Parabellum Pistols are very rare.



CLEANING EQUIPMENT

Cleaning accessories for the Parabellum pistol included a cleaning rod, oiler, a brush and a screwdriver for removing the grips. By WW II, the standard Wehrmacht tobacco can cleaning kit was used for all small arms, including the P.08.



This is a combination brass container for a brush and screwdriver.

The barrel-shaped wood handle on this cleaning rod is indicative of a WW I-era rod (shown top right).



The bent metal loop handle on this cleaning rod is found on Weimar and WW II-era rods.

HOLSTERS

There's almost as much variety in Luger holsters as there is in Lugers themselves. This section will only scratch the surface on this vast topic.

Foreign (i.e., non-German) Luger holsters vary greatly. Different styles, belt attachments, and spare magazine pouch configurations abound.

German Luger holsters are identified by one or more of the following features. First is the pocket for the magazine tool in the lid of the holster.

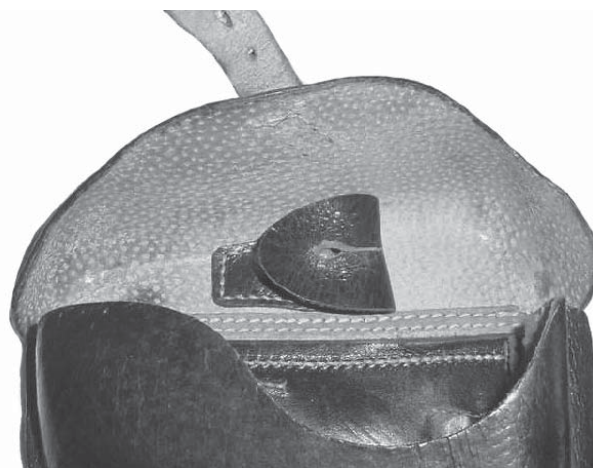

Second, is a half moon cut at the top of the spare magazine pouch to accommodate the mag base.

Third, is a stamp on the back right side that says "P.08" which is on most, but not all, Luger holsters.

Imperial, Weimar and early Nazi-era holsters will have the maker's name and city, and the year stamped into them.



Late Weimar and Nazi holsters also have a waffenamt stamp. By 1940 the maker stamp on military holsters started to change to a maker code, replacing the name and city.



Most military holsters will have the strap sewn to the flap, which buckles to the body. German police holsters had the strap sewn to the holster body and fasten to a stud on the flap. Police holsters usually also have a cleaning rod pocket and flap inside the lid. Holsters for artillery models can be found both ways.



Most WW I and Weimar holsters were brown leather, like the one shown above. By 1941 the majority of P.08 holsters were black leather.



LANYARDS

Every Luger had a lanyard loop, yet an original Luger lanyard is one of the rarest accessories. They were usually leather, but sometimes webbed with metal hardware similar to the buckle-and-roller hardware found on holsters.

MAGAZINES

The standard magazine for all Luger models (excepting the seven-shot and the Baby models) was an eight-round magazine. Commercial Luger pistols were sold with up to three unnumbered magazines. Military Luger pistols were issued with two matching serial numbered magazines. Details are sketchy on how contract Luger models were issued, but it is likely that they also each were issued with at least one spare magazine.

One thing about the 9mm Parabellum round was that it used the same magazine as the 7.65mm round. However, in the early days of the commercial 9mm

Standard Catalog of Luger

Parabellums, the magazine was stamped on the base to indicate that the pistol was not 7.65mm.



There are several variations of Luger magazine. The mag body itself started as a wrap-around construction, which later gave way to an extruded method.

The finish on the body started out as nickel-plated, later became tin- or zinc-plated, and finally blued.

Variations in the base include wood, aluminum and plastic with and without visible retaining rivets.



This magazine is an example with the nickel-plated, wrap-around body and a wood base.



This magazine has the wood base with the metal insert found on some Swiss model Lugers.



This is an example of the Imperial Navy model magazine with the circles cut in the wood base.



This magazine is an example of the tin-plated wrap-around body variation with a black plastic base issued with 1929 Swiss models.



This tin-plated wrap-around body magazine with an aluminum base is typical of Weimar P.08s.

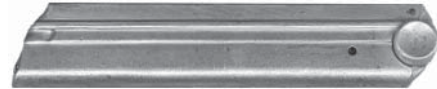

This magazine is common to commercial and contract P.08s from the late 1920s.



This blued wrap-around body magazine with aluminum base is the type found with most Mauser WW II era P.08s up through about 1939.

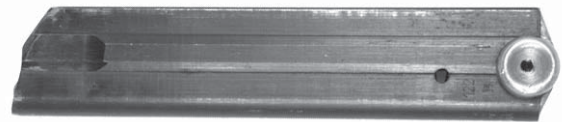

This blued extruded body magazine with riveted aluminum base is found in Krieghoff and Nazi-era Mauser P.08s from 1939 to 1941.



The final evolution of P.08 magazines was this blued extruded body with a black plastic base.

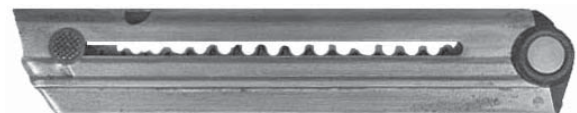

The subtlety of what makes this magazine different is that there is a slot cut on both sides to allow the contents of the mag to be seen.



Luger military magazines were serial numbered to match the gun. The number was applied across the base with the serial number suffix below. A waffenamt is usually applied as well.

This ingenious little piece of metal has a screwdriver on one end and a hole near the middle that fits over the button on a Luger magazine elevator. The bend in the metal then made a handy surface with which to depress the mag spring and load the magazine.

These tools were usually acceptance marked. They should therefore carry the same era and variation mark as the pistols they go with.

Magazine Loading Tool

Trommelmagazin



An Austrian named Friedrich Blum, living in Budapest had patented some innovative drum magazine designs. In October of 1916 the German War Ministry conducted trials of a Blum-designed 32-round drum magazine with the Lange Pistole. Production began the next month at Gebruder Bing AG in Nuremberg, A.E.G. in Berlin, and Vereinigten Automaten-Fabriken Pelzer and Co. in Berlin.

1917 saw wide scale availability of the large-capacity magazine, usually distributed in a set of five magazines, five dust covers, a special loading tool, and ammunition in a wooden crate.

Collectors call this a snail drum because of the spiral in mechanism of the drum.

MAGAZINE TOOLS



Loading the 32 rounds into a snail drum would wear out one's thumbs if it were not for this tool. It would fit over the magazine and depress the spring, making it easier to load.

MANUALS

These are just a few examples of the various Luger manuals one can very rarely find.

Military Manual

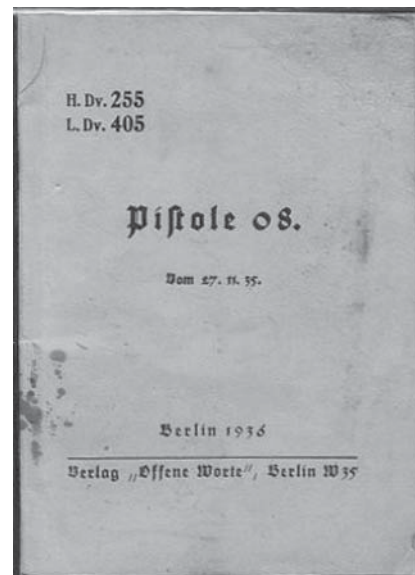

Commercial Manuals

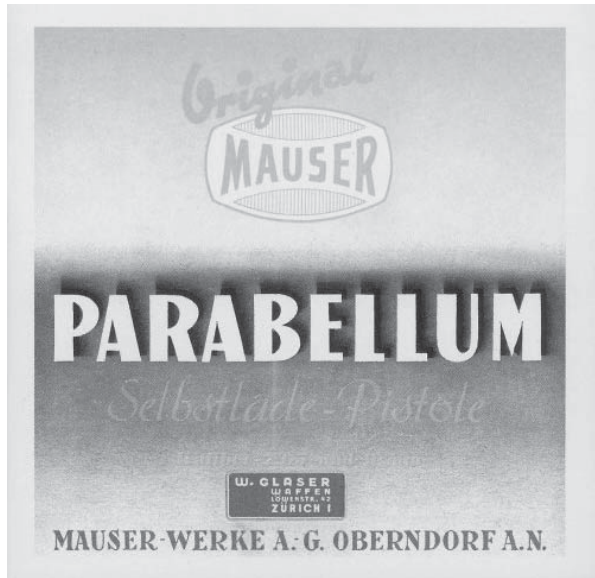

STOCKS

Most Lugers have a lug on the backstrap. It is a little-known fact that most Lugers were never intended to have a stock. This lug was used to hold the frame in a fixture during the manufacturing process. Take the grips off of a Luger variation that did not have a stock lug, and you will see the holes used in place of the lug. However, those few Lugers that were intended to have a stock, had some of the most beautiful furniture found on firearms.

Carbine Model Stocks

The top of the hit parade is the extra wood found on the various Luger carbines. A forearm and detachable



buttstock set apart one of the most valuable Luger variations that exists.



There was a little-known stock that came out for the 1900 models. It looks roughly like a stylized artillery stock, but with a push-button attachment mechanism.

Artillery Model Stocks



A flat wooden shoulder stock/holster was supplied with most artillery models. Occasionally, the collector is lucky enough to find one of these with the leather holster still attached.

Even more rare than the flat board artillery stock, is the wood holster stock. It is similar in design to the better-known Broomhandle stock.

Naval Model Stocks



The Imperial Navy flat board is an extremely rare accessory. While it resembles the artillery flat board, it is shorter. German military ones (as opposed to contract or commercial ones) have a metal disk with naval unit markings.

Commercial Aftermarket Stocks

The Benke-Thiemann Shoulder Stock looks like a prop from a B sci-fi movie. Despite an unorthodox appearance, this stock commands many times the value of the pistol it would go on.

The Gomann-Grunow Telescoping Shoulder Stock consists of two metal tubes, with a small butt plate. Less than 10 are known.

The Ideal Holster Stock (shown below) is probably the best-known 1920s-era aftermarket Luger stock. It came with special grips that held the stock in place.



There was a prototype sheet metal telescoping shoulder stock/holster that is believed to have been considered as survival gear for the Luftwaffe.

SMALL-CALIBER KITS

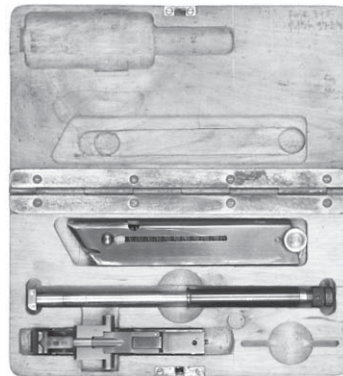

There were two variations of military sub-caliber conversion kits for the P.08. The main difference is that the larger kit included cleaning equipment. Also note the different magazines.

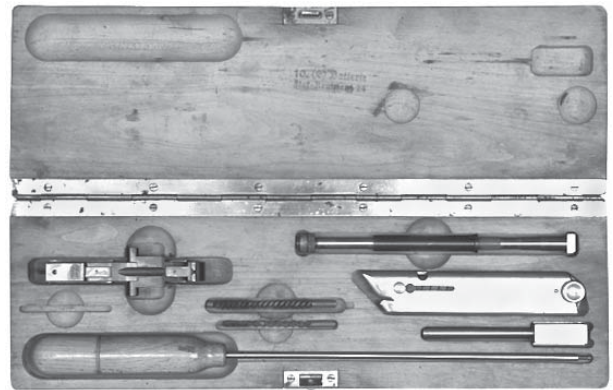

There was also a commercial after market sub-caliber kit. It came in a cardboard box. These kits were single-shot, with a special tool to load the frustratingly small ammo.

Chapter 9

Luger Collecting Advice

Many fine reference books on Lugers (or other small arms for that matter) will spend an inordinate amount of time emphasizing type collections, or quintessential models that “are required to round out an admirable collection.”

Certainly there is nothing wrong with collecting by some category (military, commercial, Imperial, Weimar, Nazi, Swiss). This author’s advice on collecting is five simple points which have served me extremely well over my gun-collecting life.

COLLECT WHAT YOU ENJOY

Just because you don’t own (or particularly want) a landmark piece like one of the first 9mm Parabellum 1902 models, or you don’t like the quirky looking Swiss Bern pistols, or a police proofed pistol would be just on the periphery of your military combat pistol interests, WHO CARES! It is YOUR collection. Collect what you enjoy, and by all means, enjoy what you collect.

READ, STUDY, OBSERVE, ABSORB

Whatever flavor(s) of the Luger trip your trigger, learn as much as you can about those models, their markings, and the history around that era. Knowledge is power in Luger collecting. The more you know about the Luger models you are pursuing, the more confidence, success and fun you will have in your collecting. Unfortunately, there are many scoundrels out there making and selling fake, redone, bogus guns. Every serious collector out there has been burned at least once. These unfortunate and painfully expensive lessons can be minimized by homework in books like this one.

In addition to time in the books (which I liken to my time as a kid looking through the Christmas toy catalogs), spend time looking at the real thing. Look at color, machining marks, wear patterns, typefaces. Look for inconsistent condition from outside to inside as a sign of a likely rework. Look at the grips. Wood does not lie.

Find someone whom you can trust and learn from and absorb as much material as your brain can hold.

Get multiple opinions. The loud masses don’t always outweigh the wise words of one in the know. However, getting a consistent story on whether a piece is right or not is important.

COLLECT QUALITY

Admittedly this may contradict some of what was written earlier about collecting what you enjoy, and

telling the rest of the world to stick it in their snail drum. However, rarity and original unaltered condition drives Luger values.

Think about this. You have found a model of Luger you’ve been looking for. In fact you found two of them. One is well within your budget. It is an all-matching, 85 percent gun. Nothing wrong with it, no rust, no rash. Just honest wear. Now there is the exact same model. Same variation. In fact it is within 1,000 serial numbers of the first one. This one is about a 95 percent condition, all matching gun. This one is about \$150 more than the top dollar you predetermined to buy. All else being equal, will you be going home with the lesser pistol and an extra \$100, or will you be going home with the better condition piece and a withdrawal slip for \$150 from the ATM?

Now think about all the other buyers out there that might be shopping for your Luger some day. Which do you think would be easier to sell? I rest my case.

WATCH OUT FOR FAKES

Lugers might be the most faked, redone, and tinkered with group of guns out there. I don’t know too many collectors that have not been taken at least once. I can attest that there is nothing more sickening than having someone later point out an obvious indication of tinkering on what you thought was a 98 percent pistol.

The “magic shops” are getting better and better and bringing life back to well worn pistols. The honest ones will only do work for those that are willing to collect a quality restoration. In fact, some restoration artisans’ work is starting to become collectible in its own right.

However, you deserve to know if something is a restoration before you buy it. A good quality restoration, passed off as original by a dishonest seller might leave you with a good-looking piece, but it is still dishonest.

The next level of fakes includes pieces that have a mark or two added to an otherwise authentic pistol, in order to increase their value. Nazi SS, SA, Kriegsmarine and K marks are classic examples of value-enhancing marks which get faked. If you collect on the rarity fringes where a mark or two makes a big price difference, look closely. These are the dangerous ones in my estimation. These are fakes which still color inside the lines, easily catching many collectors.

However, the most dishonest ones have gone so far as to create new Luger variations out of thin air. I won’t go so far as to say that this book is exhaustive. However, it does cover the vast, vast majority of the variations that are known out there. If you find something that is outside the descriptions in this book, I would recommend caution. There are almost certainly

Luger variations that have not come to the surface for documentation. However, your research, fellow collectors and the instincts you'll develop over time should guide you. If Hitler's barber's neighbor's Luger is out there for an outrageous amount of money, you better be sure before you bet the farm on it.

The advent of the Internet has both changed things quite a bit for collectors, and turned up the heat on this subject. One can now buy a holster from Russia, a lanyard from Australia, and Luger manual from Jamaica. The bad news is that what you can find up for auction, others can find up for auction. When you win an online auction, congratulations! You've just paid more for that item any anyone else on the planet. It is not likely that one of the online gun show sites will lead you

to a multi-thousand dollar piece for \$300. Not unless everyone else out there (including the seller) has fallen asleep.

CONSIDER THE SOURCE

If someone has a reputation for selling fakes, avoid them. If everything on their table is the same color and hue, be suspicious. If they dither on a matter of fact description, assume the worst (i.e., "Well, I've been told its been redone, but it looks like it could be good to me."). If you see them buying mid-condition pieces, but only selling top-condition pieces, wake up and smell the salt blue. A reputable seller will stand behind a gun to stand up under inspection.

Chapter 10

Summary of Values

Luger values (like the values of any collectible firearm) are based on the economic principals of supply and demand. On the supply side, there are the factors of rarity and original condition. On the demand side, there is the popularity of some models compared to less desire for others.

MATCHING SERIAL NUMBERS

All values listed assume a piece with all matching serial numbers. A mismatch cuts the price in half.

ORIGINAL FINISH

All values listed assume a piece in original finish. Refinishing reduces the value. Following are my personal rules of thumb:

- * If the piece has been nicked, the value is that of a shooter. There is NO collector value left.
- * An average quality reblue drops the value to that of a poor quality original condition piece of the same model. A very rare piece that has been reblued might still have some residual collector value. For me personally, it would have to be so rare as to preclude my likelihood of ever finding the same piece in original condition. However, there are entire collections of redone pieces, owned by satisfied collectors.
- * There is a newly emerging category of condition recognized as legitimate by serious collectors. A quality restoration commands almost as much as an original condition piece. A reblue attempts to cover up bare metal, holster wear, rust pits and abuse. A restoration attempts to put the piece back to an original condition. The attention to absolute detail regarding metal finishing, color, preserving stamps, repairing wear, rust and abuse; these are the things which set a restoration far ahead of a reblue, but still short of an original condition piece. Depending on the quality of the restoration work, the value drops from 10 percent to one entire category (e.g. excellent to very good).

MATCHING MAGAZINES

Values given for commercial and contract models assume a correct magazine for that model. It is usually expected that these models retained their proper magazines over time.

Values given for German military and police models assume a proper era magazine with a mismatched serial

number. This is the most common way these models are found.

In the rare case when one finds a Luger with a proper matching serial numbered magazine, the value goes up from 25 percent to 50 percent. In the extremely rare case when one finds a Luger with BOTH proper matching serial numbered magazines, the value goes up as much as double. It should be noted that the cottage industry of renumbering magazines to create "matched" rigs is spreading. Evaluate the style of numbering, the size, and the surface beneath the number stamp when determining originality.

COMPLETE RIGS

A Luger with both matching numbered mags, and a properly dated holster constitutes what we call a complete rig! By rights, such an ensemble should not be worth more than the sum of its parts. After all, many of these holsters and guns have been mated together only recently.

However, there are those willing to pay a slight premium for someone else to track down the holster with the appropriate date and condition to complete the set. A proper, complete rig should add a holster's value on top of a two matching mag gun.

VALUES BY MODEL

The following pages list observed values as of when this book went to press. Values are given across five degrees of original condition from poor to excellent.

LUGER-BORCHARDT TRANSITIONAL

This model is too rare to price.

1899/1900 TEST

This model is too rare to price.

1900 COMMERCIAL

	POOR	FAIR	GOOD	VERY GOOD	EXCELLENT
Standard Model	\$750	\$1,000	\$2,000	\$3,500	\$5,000
7-inch Barrel	\$1,500	\$2,000	\$2,750	\$4,000	\$7,500
Dutch	\$1,500	\$2,000	\$2,750	\$4,000	\$7,500
Portuguese	\$1,500	\$2,000	\$2,500	\$4,000	\$6,000

1900 PRESENTATION

This model is too rare to price.

1900 COMMERCIAL, SAFETY EXPERIMENT

POOR	FAIR	GOOD	VERY GOOD	EXCELLENT
\$2,000	\$2,800	\$5,000	\$7,500	\$10,000

1900 SWISS COMMERCIAL

POOR	FAIR	GOOD	VERY GOOD	EXCELLENT
\$1,000	\$1,500	\$2,500	\$4,000	\$5,000

1900 SWISS MILITARY

POOR	FAIR	GOOD	VERY GOOD	EXCELLENT
\$1,000	\$1,500	\$2,500	\$4,000	\$5,500

1900 AMERICAN EAGLE COMMERCIAL

POOR	FAIR	GOOD	VERY GOOD	EXCELLENT
\$1,000	\$1,500	\$2,000	\$3,500	\$4,500

1900 AMERICAN EAGLE MILITARY

POOR	FAIR	GOOD	VERY GOOD	EXCELLENT
\$1,800	\$2,500	\$3,500	\$5,000	\$7,500

1900 BULGARIAN

POOR	FAIR	GOOD	VERY GOOD	EXCELLENT
9mm Parabellum				
\$1,500	\$2,000	\$3,750	\$6,000	\$8,000
7.65mm				
\$1,750	\$2,500	\$5,000	\$8,000	\$12,500

1900 CARBINE

This model is too rare to price.

1900 MEXICAN TEST

POOR	FAIR	GOOD	VERY GOOD	EXCELLENT
\$1,500	\$2,000	\$2,750	\$5,000	\$7,500

1902 PROTOTYPE

POOR	FAIR	GOOD	VERY GOOD	EXCELLENT
\$12,000	\$15,000	\$20,000	\$25,000	\$30,000

1902 COMMERCIAL

POOR	FAIR	GOOD	VERY GOOD	EXCELLENT
\$1,200	\$3,000	\$5,000	\$8,000	\$9,500

A 1902 AMERICAN EAGLE

POOR	FAIR	GOOD	VERY GOOD	EXCELLENT
\$1,500	\$3,500	\$5,000	\$7,500	\$9,000

1902 AMERICAN EAGLE CARTRIDGE COUNTER

POOR	FAIR	GOOD	VERY GOOD	EXCELLENT
\$3,500	\$8,500	\$17,500	\$25,000	\$32,000

1902 CARBINE

POOR	FAIR	GOOD	VERY GOOD	EXCELLENT
Standard Carbine (subtract 30 percent without stock)				
\$4,000	\$6,500	\$9,000	\$12,500	\$18,000
American Eagle				
\$6,000	\$8,000	\$10,000	\$14,000	\$20,000
Presentation				

This model is too rare to price.

1902/06 TRANSITION CARBINE

POOR	FAIR	GOOD	VERY GOOD	EXCELLENT
\$3,500	\$6,500	\$8,000	\$10,000	\$15,000

1903 DANZIG TEST

POOR	FAIR	GOOD	VERY GOOD	EXCELLENT
\$3,000	\$7,500	\$12,500	\$20,000	\$25,000

1903 COMMERCIAL

POOR	FAIR	GOOD	VERY GOOD	EXCELLENT
\$2,500	\$3,500	\$5,000	\$10,000	\$12,500

7-SHOT PROTOTYPE

This model is too rare to price.

7-SHOT BULGARIAN PROTOTYPE

This model is too rare to price.

A 1904 NAVY

POOR	FAIR	GOOD	VERY GOOD	EXCELLENT
4-inch Barrel				
\$1,000	\$1,500	\$2,000	\$3,000	\$4,000
6-inch Barrel				
\$5,000	\$8,000	\$20,000	\$30,000	\$40,000

1905 DUTCH TEST

POOR	FAIR	GOOD	VERY GOOD	EXCELLENT
\$750	\$1,000	\$2,000	\$3,500	\$5,000

1906 COMMERCIAL

POOR	FAIR	GOOD	VERY GOOD	EXCELLENT
\$750	\$1,200	\$2,000	\$2,500	\$3,500

1906 COMMERCIAL, SAFETY MARKED

POOR	FAIR	GOOD	VERY GOOD	EXCELLENT
\$750	\$1,200	\$2,000	\$3,000	\$4,000

1906 COMMERCIAL, STOCK LUG

POOR	FAIR	GOOD	VERY GOOD	EXCELLENT
\$1,000	\$1,500	\$2,250	\$3,500	\$4,200

1906 COMMERCIAL, FRENCH MARKED

POOR	FAIR	GOOD	VERY GOOD	EXCELLENT
\$800	\$1,200	\$2,000	\$2,500	\$3,500

Standard Catalog of Luger

1906 PRESENTATION

POOR	FAIR	GOOD	VERY GOOD	EXCELLENT
\$6,000	\$7,500	\$10,000	\$15,000	\$18,000

1906 NAVY MILITARY, 1st ISSUE

POOR	FAIR	GOOD	VERY GOOD	EXCELLENT
\$1,000	\$1,500	\$2,500	\$4,800	\$6,500

1906 NAVY MILITARY, 2nd ISSUE

POOR	FAIR	GOOD	VERY GOOD	EXCELLENT
\$800	\$1,200	\$2,000	\$3,500	\$5,000

1906 NAVY COMMERCIAL

POOR	FAIR	GOOD	VERY GOOD	EXCELLENT
\$1,000	\$2,000	\$3,000	\$5,000	\$8,000

1906 AMERICAN EAGLE

POOR	FAIR	GOOD	VERY GOOD	EXCELLENT
9mm Parabellum (subtract 10 percent if magazine NOT marked "Cal 9 m/m")				
\$750	\$1,200	\$2,000	\$2,800	\$3,500
7.65mm				
\$500	\$1,000	\$1,800	\$2,500	\$3,200

1906 AMERICAN EAGLE SAFETY MARKED

POOR	FAIR	GOOD	VERY GOOD	EXCELLENT
\$1,000	\$1,500	\$2,000	\$3,500	\$5,000

1906 BRAZILIAN

POOR	FAIR	GOOD	VERY GOOD	EXCELLENT
\$750	\$1,200	\$2,000	\$3,200	\$4,000

1906 BULGARIAN

POOR	FAIR	GOOD	VERY GOOD	EXCELLENT
9mm Parabellum				
\$800	\$1,750	\$3,000	\$5,000	\$7,500
7.65mm				
\$1,500	\$3,500	\$6,000	\$7,500	\$10,000

1906 DUTCH

POOR	FAIR	GOOD	VERY GOOD	EXCELLENT
\$700	\$1,000	\$1,500	\$2,500	\$4,250

1906 ROYAL PORTUGUESE ARMY

POOR	FAIR	GOOD	VERY GOOD	EXCELLENT
\$750	\$1,250	\$2,000	\$3,250	\$4,500

1906 ROYAL PORTUGUESE NAVY

POOR	FAIR	GOOD	VERY GOOD	EXCELLENT
\$2,500	\$3,500	\$6,000	\$10,000	\$12,000

1900 REPUBLIC OF PORTUGAL NAVY

POOR	FAIR	GOOD	VERY GOOD	EXCELLENT
\$2,500	\$3,500	\$6,000	\$10,000	\$12,000

1906 RUSSIAN

POOR	FAIR	GOOD	VERY GOOD	EXCELLENT
\$2,750	\$4,500	\$7,500	\$15,000	\$18,000

1906 SWISS MILITARY

POOR	FAIR	GOOD	VERY GOOD	EXCELLENT
Original Configuration				
\$750	\$1,000	\$2,200	\$3,400	\$4,500
Rework				
\$500	\$750	\$1,250	\$1,750	\$2,500

1906 SWISS POLICE

POOR	FAIR	GOOD	VERY GOOD	EXCELLENT
Original Configuration				
\$750	\$1,000	\$2,200	\$3,400	\$4,500
Rework				
\$500	\$750	\$1,250	\$1,750	\$2,500

1906 SWISS COMMERCIAL

POOR	FAIR	GOOD	VERY GOOD	EXCELLENT
\$800	\$1,500	\$2,500	\$3,500	\$5,000

1906 US ARMY TEST

This model is too rare to price.

1907 DUTCH EAST INDIES TEST

POOR	FAIR	GOOD	VERY GOOD	EXCELLENT
\$1,000	\$1,500	\$3,000	\$5,000	\$7,500

1908 COMMERCIAL

POOR	FAIR	GOOD	VERY GOOD	EXCELLENT
\$500	\$600	\$750	\$1,250	\$2,250

1908 BOLIVIAN

POOR	FAIR	GOOD	VERY GOOD	EXCELLENT
\$1,000	\$2,000	\$4,500	\$7,500	\$10,000

1908 COMMERCIAL, MILITARY CONTRACT

POOR	FAIR	GOOD	VERY GOOD	EXCELLENT
\$750	\$1,200	\$2,000	\$2,500	\$3,000

1908 MILITARY

POOR	FAIR	GOOD	VERY GOOD	EXCELLENT
\$400	\$500	\$650	\$750	\$1,400

1908 MILITARY, DATED

POOR	FAIR	GOOD	VERY GOOD	EXCELLENT
Dated 1910 to 1913				
\$400	\$500	\$650	\$1,000	\$1,250
Dated 1914				
\$500	\$650	\$850	\$1,200	\$1,500

1908 MILITARY, ERFURT

POOR	FAIR	GOOD	VERY GOOD	EXCELLENT
\$400	\$500	\$650	\$1,200	\$1,400

1914 NAVY MILITARY

POOR	FAIR	GOOD	VERY GOOD	EXCELLENT
\$850	\$1,250	\$3,000	\$4,800	\$6,000

1914 NAVY COMMERCIAL

POOR	FAIR	GOOD	VERY GOOD	EXCELLENT
\$1,250	\$1,750	\$2,800	\$4,500	\$6,000

1908 BULGARIAN

POOR	FAIR	GOOD	VERY GOOD	EXCELLENT
\$1,500	\$2,000	\$2,500	\$4,500	\$6,000

1913 COMMERCIAL

POOR	FAIR	GOOD	VERY GOOD	EXCELLENT
\$500	\$600	\$750	\$1,200	\$2,000

1914 COMMERCIAL

POOR	FAIR	GOOD	VERY GOOD	EXCELLENT
\$450	\$550	\$750	\$950	\$1,250

1914 MILITARY

POOR	FAIR	GOOD	VERY GOOD	EXCELLENT
\$350	\$425	\$500	\$750	\$1,000

1914 ERFURT

POOR	FAIR	GOOD	VERY GOOD	EXCELLENT
\$400	\$500	\$650	\$750	\$1,250

LANGE PISTOLE .08

POOR	FAIR	GOOD	VERY GOOD	EXCELLENT
\$1,000	\$1750	\$2,500	\$4,000	\$6,000

1914 ARTILLERY, ERFURT

POOR	FAIR	GOOD	VERY GOOD	EXCELLENT
\$850	\$1,000	\$1,500	\$2,750	\$3,500

1914 ARTILLERY

POOR	FAIR	GOOD	VERY GOOD	EXCELLENT
\$750	\$900	\$1,500	\$2,500	\$3,000

1916 NAVY

POOR	FAIR	GOOD	VERY GOOD	EXCELLENT
\$850	\$1,250	\$2,000	\$3,000	\$4,500

1918 DUTCH NAVY

POOR	FAIR	GOOD	VERY GOOD	EXCELLENT
\$850	\$1,250	\$2,000	\$3,200	\$4,500

DWM DOUBLE DATE, ARMY REWORK

POOR	FAIR	GOOD	VERY GOOD	EXCELLENT
\$375	\$775	\$1,100	\$1,500	\$2,000

DWM DOUBLE DATE, POLICE REWORK

POOR	FAIR	GOOD	VERY GOOD	EXCELLENT
\$375	\$775	\$1,100	\$1,500	\$2,000

DWM DOUBLE DATE, NAVY REWORK

POOR	FAIR	GOOD	VERY GOOD	EXCELLENT
\$500	\$1,000	\$1,500	\$2,500	\$3,000

ERFURT DOUBLE DATE, ARMY REWORK

POOR	FAIR	GOOD	VERY GOOD	EXCELLENT
\$375	\$775	\$1,100	\$1,500	\$2,000

ERFURT DOUBLE DATE, POLICE REWORK

POOR	FAIR	GOOD	VERY GOOD	EXCELLENT
\$375	\$775	\$1,100	\$1,500	\$2,000

ERFURT DOUBLE DATE, NAVY REWORK

POOR	FAIR	GOOD	VERY GOOD	EXCELLENT
\$500	\$1,000	\$1,500	\$2,500	\$3,000

DWM DATED, ARMY REWORK

POOR	FAIR	GOOD	VERY GOOD	EXCELLENT
\$375	\$500	\$750	\$1,000	\$1,250

DWM DATED, POLICE REWORK

POOR	FAIR	GOOD	VERY GOOD	EXCELLENT
\$375	\$500	\$750	\$1,000	\$1,250

DWM DATED, NAVY REWORK

POOR	FAIR	GOOD	VERY GOOD	EXCELLENT
\$500	\$1,000	\$1,500	\$2,500	\$3,000

ERFURT DATED, ARMY REWORK

POOR	FAIR	GOOD	VERY GOOD	EXCELLENT
\$375	\$500	\$750	\$1,000	\$1,250

ERFURT DATED, POLICE REWORK

POOR	FAIR	GOOD	VERY GOOD	EXCELLENT
\$375	\$500	\$750	\$1,000	\$1,250

ERFURT DATED, NAVY REWORK

POOR	FAIR	GOOD	VERY GOOD	EXCELLENT
\$500	\$1,000	\$1,500	\$2,500	\$3,000

DWM NO DATE, ARMY REWORK

POOR	FAIR	GOOD	VERY GOOD	EXCELLENT
\$375	\$500	\$750	\$1,000	\$1,250

Standard Catalog of Luger

DWM NO DATE, POLICE REWORK

POOR	FAIR	GOOD	VERY GOOD	EXCELLENT
\$375	\$500	\$750	\$1,000	\$1,250

DWM NO DATE, NAVY REWORK

POOR	FAIR	GOOD	VERY GOOD	EXCELLENT
\$500	\$1,000	\$1,500	\$2,500	\$3,000

ERFURT NO DATE, ARMY REWORK

POOR	FAIR	GOOD	VERY GOOD	EXCELLENT
\$375	\$500	\$750	\$1,000	\$1,250

ERFURT NO DATE, POLICE REWORK

POOR	FAIR	GOOD	VERY GOOD	EXCELLENT
\$375	\$500	\$750	\$1,000	\$1,250

ERFURT NO DATE, NAVY REWORK

POOR	FAIR	GOOD	VERY GOOD	EXCELLENT
\$500	\$1,000	\$1,500	\$2,500	\$3,000

DOUBLE DATE, ARMY

POOR	FAIR	GOOD	VERY GOOD	EXCELLENT
\$400	\$850	\$1,250	\$1,500	\$2,000

DOUBLE DATE, POLICE

POOR	FAIR	GOOD	VERY GOOD	EXCELLENT
\$400	\$650	\$800	\$1,250	\$1,500

MILITARY & POLICE DATED, ARMY

POOR	FAIR	GOOD	VERY GOOD	EXCELLENT
\$400	\$850	\$1,250	\$1,500	\$2,000

MILITARY & POLICE DATED, POLICE

POOR	FAIR	GOOD	VERY GOOD	EXCELLENT
\$400	\$650	\$800	\$1,250	\$1,500

MILITARY & POLICE DATED, NAVY

POOR	FAIR	GOOD	VERY GOOD	EXCELLENT
\$400	\$650	\$800	\$1,250	\$1,500

MILITARY & POLICE DATED, NAVY MA

POOR	FAIR	GOOD	VERY GOOD	EXCELLENT
\$750	\$1,000	\$1,500	\$2,500	\$4,000

MILITARY & POLICE NO DATE, ARMY

POOR	FAIR	GOOD	VERY GOOD	EXCELLENT
\$400	\$850	\$1,250	\$1,500	\$2,000

MILITARY & POLICE NO DATE, POLICE

POOR	FAIR	GOOD	VERY GOOD	EXCELLENT
\$400	\$650	\$800	\$1,250	\$1,500

MILITARY & POLICE NO DATE, NAVY

POOR	FAIR	GOOD	VERY GOOD	EXCELLENT
\$750	\$1,000	\$1,500	\$2,500	\$4,000

MILITARY & POLICE NO DATE, NAVY MA

POOR	FAIR	GOOD	VERY GOOD	EXCELLENT
\$750	\$1,000	\$1,500	\$2,500	\$4,000

SIMSON & CO.

POOR	FAIR	GOOD	VERY GOOD	EXCELLENT
\$700	\$1,000	\$2,000	\$2,500	\$3,250

1920 SNEAK

POOR	FAIR	GOOD	VERY GOOD	EXCELLENT
\$300	\$400	\$500	\$750	\$950

1919 COMMERCIAL

POOR	FAIR	GOOD	VERY GOOD	EXCELLENT
\$450	\$650	\$950	\$1,250	\$1,500

1920 COMMERCIAL

POOR	FAIR	GOOD	VERY GOOD	EXCELLENT
4-inch Barrel Lengths				
\$350	\$500	\$650	\$1,000	\$1,250
10- to 24-inch Barrel Lengths				
\$850	\$1,000	\$1,500	\$2,250	\$3,250

1920 CARBINE

POOR	FAIR	GOOD	VERY GOOD	EXCELLENT
\$1,500	\$3,200	\$5,000	\$6,000	\$9,500

1920 ARTILLERY COMMERCIAL

POOR	FAIR	GOOD	VERY GOOD	EXCELLENT
\$500	\$1,200	\$1,650	\$2,500	\$4,000

1920 NAVY COMMERCIAL

POOR	FAIR	GOOD	VERY GOOD	EXCELLENT
\$900	\$1,200	\$1,500	\$2,250	\$5,000

1920 NAVY COMMERCIAL CARBINE

POOR	FAIR	GOOD	VERY GOOD	EXCELLENT
\$900	\$1,200	\$1,500	\$2,250	\$5,000

1920 SWISS

POOR	FAIR	GOOD	VERY GOOD	EXCELLENT
\$850	\$1,100	\$2,000	\$3,000	\$4,500

DWM/KRIEGHOFF, BACKFRAME INSCRIPTION

POOR	FAIR	GOOD	VERY GOOD	EXCELLENT
\$500	\$650	\$1,000	\$1,800	\$2,500

DWM/KRIEGHOFF, FRAME INSCRIPTION

POOR	FAIR	GOOD	VERY GOOD	EXCELLENT
\$500	\$650	\$1,000	\$1,800	\$2,500

ABERCROMBIE & FITCH

POOR	FAIR	GOOD	VERY GOOD	EXCELLENT
\$2,000	\$3,200	\$5,000	\$8,000	\$10,000

VICKERS DUTCH

POOR	FAIR	GOOD	VERY GOOD	EXCELLENT
\$900	\$1,250	\$1,750	\$2,750	\$3,500

VICKERS DUTCH COMMERCIAL

POOR	FAIR	GOOD	VERY GOOD	EXCELLENT
\$900	\$1,500	\$2,000	\$3,500	\$5,000

1923 SAFE & LOADED

POOR	FAIR	GOOD	VERY GOOD	EXCELLENT
\$500	\$850	\$1,000	\$1,500	\$2,500

1923 STOEGER AMERICAN EAGLE

POOR	FAIR	GOOD	VERY GOOD	EXCELLENT
\$800	\$1,200	\$2,000	\$3,800	\$5,000

1923 STOEGER SAFE & LOADED

POOR	FAIR	GOOD	VERY GOOD	EXCELLENT
\$800	\$1,200	\$2,000	\$3,800	\$5,000

1923 DWM FINNISH MILITARY

POOR	FAIR	GOOD	VERY GOOD	EXCELLENT
\$500	\$900	\$1,000	\$1,800	\$3,500

1923 DWM SWEDISH MILITARY

POOR	FAIR	GOOD	VERY GOOD	EXCELLENT
\$500	\$900	\$1,000	\$1,800	\$3,500

1925 BABY LUGER

This model is too rare to price.

SIMSON GRIP SAFETY

POOR	FAIR	GOOD	VERY GOOD	EXCELLENT
\$700	\$1,000	\$2,000	\$2,500	\$3,250

SIMSON DATED

POOR	FAIR	GOOD	VERY GOOD	EXCELLENT
\$700	\$1,000	\$2,000	\$2,500	\$3,250

DUTCH EAST INDIES

POOR	FAIR	GOOD	VERY GOOD	EXCELLENT
\$500	\$900	\$1,000	\$1,800	\$3,500

1928 DUTCH NAVY, DWM

POOR	FAIR	GOOD	VERY GOOD	EXCELLENT
\$850	\$1,200	\$1,500	\$2,500	\$3,250

SWISS BERN, 1906 PATTERN

POOR	FAIR	GOOD	VERY GOOD	EXCELLENT
\$1,000	\$2,000	\$2,500	\$3,500	\$5,000

1906/29 SWISS SPECIAL ASSEMBLY

This model is too rare to price.

1929 SWISS COMMERCIAL

POOR	FAIR	GOOD	VERY GOOD	EXCELLENT
\$1,000	\$1,250	\$1,750	\$2,000	\$3,000

1929 SWISS MILITARY

POOR	FAIR	GOOD	VERY GOOD	EXCELLENT
\$1,000	\$1,250	\$1,750	\$2,000	\$3,000

1929 SWISS 9mm PROTOTYPE

This model is too rare to price.

1930 DUTCH NAVY, DWM/MAUSER

POOR	FAIR	GOOD	VERY GOOD	EXCELLENT
\$850	\$1,200	\$1,500	\$2,500	\$3,250

DWM MAUSER FINNISH MILITARY

POOR	FAIR	GOOD	VERY GOOD	EXCELLENT
\$500	\$900	\$1,000	\$1,800	\$3,500

SIMSON S CODE

POOR	FAIR	GOOD	VERY GOOD	EXCELLENT
\$750	\$1,100	\$2,000	\$2,800	\$4,000

SIMSON REWORK, UNMARKED

POOR	FAIR	GOOD	VERY GOOD	EXCELLENT
\$700	\$1,000	\$2,000	\$2,500	\$3,250

DEATH'S HEAD REWORK

POOR	FAIR	GOOD	VERY GOOD	EXCELLENT
\$800	\$1,000	\$1,500	\$2,500	\$3,000

Kl. 1933 REWORK

POOR	FAIR	GOOD	VERY GOOD	EXCELLENT
\$750	\$900	\$1,200	\$2,250	\$3,000

MAUSER REWORK, UNMARKED

POOR	FAIR	GOOD	VERY GOOD	EXCELLENT
\$700	\$1,000	\$2,000	\$2,500	\$3,250

VONO REWORK

POOR	FAIR	GOOD	VERY GOOD	EXCELLENT
\$700	\$1,000	\$2,000	\$2,500	\$3,250

ANSCHUTZ REWORK

POOR	FAIR	GOOD	VERY GOOD	EXCELLENT
\$700	\$1,000	\$2,000	\$2,500	\$3,250

MAUSER PROTOTYPE

This model is too rare to price.

Standard Catalog of Luger

MAUSER STOEGER

POOR	FAIR	GOOD	VERY GOOD	EXCELLENT
\$800	\$1,200	\$2,000	\$3,800	\$5,000

DWM/MAUSER SWISS

POOR	FAIR	GOOD	VERY GOOD	EXCELLENT
\$800	\$1,500	\$2,250	\$3,500	\$4,000

DWM/MAUSER OBERNDORF

POOR	FAIR	GOOD	VERY GOOD	EXCELLENT
\$800	\$1,500	\$2,250	\$3,500	\$4,000

MAUSER BANNER FINNISH

POOR	FAIR	GOOD	VERY GOOD	EXCELLENT
\$1,000	\$1,750	\$3,500	\$5,000	\$7,000

MAUSER PORTUGUESE GNR

POOR	FAIR	GOOD	VERY GOOD	EXCELLENT
\$750	\$900	\$1,500	\$2,800	\$3,400

MAUSER BANNER DUTCH NAVY

POOR	FAIR	GOOD	VERY GOOD	EXCELLENT
\$800	\$1,500	\$2,500	\$4,000	\$6,000

MAUSER BANNER DUTCH/GERMAN

POOR	FAIR	GOOD	VERY GOOD	EXCELLENT
\$800	\$1,500	\$2,500	\$4,000	\$6,000

MAUSER BANNER COMMERCIAL

POOR	FAIR	GOOD	VERY GOOD	EXCELLENT
\$750	\$1,250	\$1,500	\$2,000	\$2,850

MAUSER BANNER SWISS

POOR	FAIR	GOOD	VERY GOOD	EXCELLENT
\$1,000	\$1,750	\$3,500	\$5,000	\$7,000

MAUSER SIAMESE

POOR	FAIR	GOOD	VERY GOOD	EXCELLENT
\$1,800	\$2,250	\$3,500	\$4,800	\$6,000

MAUSER SIAMESE, ARTILLERY

POOR	FAIR	GOOD	VERY GOOD	EXCELLENT
\$1,800	\$2,250	\$3,500	\$4,800	\$6,000

MAUSER BANNER GRIP SAFETY COMMERCIAL

POOR	FAIR	GOOD	VERY GOOD	EXCELLENT
\$750	\$1,250	\$2,000	\$2,500	\$3,000

MAUSER BANNER DATED

POOR	FAIR	GOOD	VERY GOOD	EXCELLENT
\$750	\$1,250	\$1,500	\$2,000	\$2,850

MAUSER BANNER TWO-DIGIT DATE

POOR	FAIR	GOOD	VERY GOOD	EXCELLENT
\$800	\$1,000	\$1,500	\$2,800	\$3,500

MAUSER BANNER DATED, GRIP SAFETY

POOR	FAIR	GOOD	VERY GOOD	EXCELLENT
\$750	\$1,250	\$1,500	\$3,000	\$4,500

MAUSER BANNER SWEDISH MILITARY

POOR	FAIR	GOOD	VERY GOOD	EXCELLENT
\$1,000	\$1,750	\$3,500	\$5,000	\$7,000

MAUSER BANNER POLICE

POOR	FAIR	GOOD	VERY GOOD	EXCELLENT
\$500	\$900	\$1,500	\$2,250	\$3,000

MAUSER BANNER POLICE, TWO-DIGIT DATE

POOR	FAIR	GOOD	VERY GOOD	EXCELLENT
\$800	\$1,000	\$1,500	\$2,800	\$3,500

MAUSER BANNER SWEDISH

POOR	FAIR	GOOD	VERY GOOD	EXCELLENT
\$1,000	\$1,750	\$3,500	\$5,000	\$7,000

MAUSER BANNER MILITARY

POOR	FAIR	GOOD	VERY GOOD	EXCELLENT
\$800	\$1,500	\$2,500	\$4,000	\$6,000

MAUSER PERSIAN

POOR	FAIR	GOOD	VERY GOOD	EXCELLENT
\$1,800	\$2,250	\$3,500	\$4,800	\$6,000

MAUSER PERSIAN, ARTILLERY

POOR	FAIR	GOOD	VERY GOOD	EXCELLENT
\$1,000	\$1,250	\$1,750	\$2,800	\$3,500

MAUSER TURKISH POLICE

POOR	FAIR	GOOD	VERY GOOD	EXCELLENT
\$750	\$1,000	\$1,500	\$2,500	\$3,500

MAUSER TURKISH ARMY

POOR	FAIR	GOOD	VERY GOOD	EXCELLENT
\$750	\$1,000	\$1,500	\$2,500	\$3,500

MAUSER TURKISH AIR FORCE

POOR	FAIR	GOOD	VERY GOOD	EXCELLENT
\$750	\$1,000	\$1,500	\$2,500	\$3,500

MAUSER K DATE

POOR	FAIR	GOOD	VERY GOOD	EXCELLENT
\$1,000	\$1,500	\$2,500	\$4,000	\$6,000

MAUSER G DATE, EARLY ACCEPTANCE MARK

POOR	FAIR	GOOD	VERY GOOD	EXCELLENT
\$600	\$850	\$1,200	\$2,000	\$2,500

MAUSER G DATE, MID ACCEPTANCE MARK

POOR	FAIR	GOOD	VERY GOOD	EXCELLENT
\$600	\$850	\$1,200	\$2,000	\$2,500

MAUSER G DATE, LATE ACCEPTANCE MARK

POOR	FAIR	GOOD	VERY GOOD	EXCELLENT
\$600	\$850	\$1,200	\$2,000	\$2,500

MAUSER S/42 1936 DATE

POOR	FAIR	GOOD	VERY GOOD	EXCELLENT
\$500	\$750	\$1,000	\$1,500	\$2,000

MAUSER S/42 1937 DATE, EARLY FINISH

POOR	FAIR	GOOD	VERY GOOD	EXCELLENT
\$500	\$750	\$1,000	\$1,500	\$2,000

MAUSER S/42 EARLY FINISH, KRIEGSMARINE

POOR	FAIR	GOOD	VERY GOOD	EXCELLENT
\$900	\$1,250	\$2,000	\$2,750	\$3,500

MAUSER S/42 EARLY FINISH, POLICE

POOR	FAIR	GOOD	VERY GOOD	EXCELLENT
\$500	\$750	\$1,000	\$1,500	\$2,000

MAUSER S/42 1937 DATE, LATE FINISH

POOR	FAIR	GOOD	VERY GOOD	EXCELLENT
\$500	\$750	\$1,000	\$1,500	\$2,000

MAUSER S/42 1938 DATE

POOR	FAIR	GOOD	VERY GOOD	EXCELLENT
\$500	\$750	\$1,000	\$1,500	\$2,000

MAUSER S/42 1939 DATE, EARLY PROOF

POOR	FAIR	GOOD	VERY GOOD	EXCELLENT
\$500	\$750	\$1,000	\$1,500	\$2,000

MAUSER S/42 LATE FINISH, KRIEGSMARINE

POOR	FAIR	GOOD	VERY GOOD	EXCELLENT
\$900	\$1,250	\$2,000	\$2,750	\$3,500

MAUSER S/42 LATE FINISH, POLICE

POOR	FAIR	GOOD	VERY GOOD	EXCELLENT
\$500	\$750	\$1,000	\$1,500	\$2,000

MAUSER S/42 1939 DATE, LATE PROOF

POOR	FAIR	GOOD	VERY GOOD	EXCELLENT
\$500	\$750	\$1,000	\$1,500	\$2,000

MAUSER S/42, COMMERCIAL

POOR	FAIR	GOOD	VERY GOOD	EXCELLENT
\$500	\$750	\$1,000	\$1,800	\$2,500

MAUSER PRESSURE TEST

This model is too rare to price.

MAUSER 42 CODE FOUR-DIGIT DATE

POOR	FAIR	GOOD	VERY GOOD	EXCELLENT
\$450	\$650	\$950	\$1,800	\$2,500

MAUSER 42 CODE, KRIEGSMARINE

POOR	FAIR	GOOD	VERY GOOD	EXCELLENT
\$750	\$1,250	\$1,750	\$3,000	\$4,250

MAUSER 41 / 42 CODE

POOR	FAIR	GOOD	VERY GOOD	EXCELLENT
\$500	\$750	\$950	\$1,250	\$1,800

MAUSER byf CODE, 41 DATE, EARLY MARKS

POOR	FAIR	GOOD	VERY GOOD	EXCELLENT
\$750	\$1,000	\$1,850	\$2,000	\$2,500

MAUSER byf, 41 DATE, EARLY BLACK WIDOW

POOR	FAIR	GOOD	VERY GOOD	EXCELLENT
\$750	\$1,000	\$1,850	\$2,000	\$2,500

MAUSER byf, POLICE

POOR	FAIR	GOOD	VERY GOOD	EXCELLENT
\$750	\$1,000	\$1,850	\$2,000	\$2,500

MAUSER byf CODE, 41 DATE, LATE MARKS

POOR	FAIR	GOOD	VERY GOOD	EXCELLENT
\$750	\$1,000	\$1,850	\$2,000	\$2,500

MAUSER byf, 41 DATE, LATE BLACK WIDOW

POOR	FAIR	GOOD	VERY GOOD	EXCELLENT
\$750	\$1,000	\$1,850	\$2,000	\$2,500

MAUSER byf CODE, 42 DATE

POOR	FAIR	GOOD	VERY GOOD	EXCELLENT
\$750	\$1,000	\$1,850	\$2,000	\$2,500

MAUSER CODE byf, 42 DATE BLACK WIDOW

POOR	FAIR	GOOD	VERY GOOD	EXCELLENT
\$750	\$1,000	\$1,850	\$2,000	\$2,500

MAUSER CODE byf COMMERCIAL

POOR	FAIR	GOOD	VERY GOOD	EXCELLENT
\$800	\$1,200	\$1,850	\$2,200	\$2,750

Standard Catalog of Luger

MAUSER S/42, Kü

POOR	FAIR	GOOD	VERY GOOD	EXCELLENT
\$900	\$1,500	\$2,000	\$2,500	\$3,000

MAUSER CODE 42, Kü

POOR	FAIR	GOOD	VERY GOOD	EXCELLENT
\$900	\$1,500	\$2,000	\$2,500	\$3,000

MAUSER CODE byf, Kü

POOR	FAIR	GOOD	VERY GOOD	EXCELLENT
\$900	\$1,500	\$2,000	\$2,500	\$3,000

KRIEGHOFF K DATE

POOR	FAIR	GOOD	VERY GOOD	EXCELLENT
\$1,000	\$1,500	\$2,500	\$5,000	\$8,000

KRIEGHOFF S CODE, EARLY

POOR	FAIR	GOOD	VERY GOOD	EXCELLENT
\$800	\$1,000	\$1,750	\$3,000	\$5,000

KRIEGHOFF S CODE, TRANSITIONAL

POOR	FAIR	GOOD	VERY GOOD	EXCELLENT
\$800	\$1,000	\$1,750	\$3,000	\$5,000

KRIEGHOFF S CODE, LATE

POOR	FAIR	GOOD	VERY GOOD	EXCELLENT
\$800	\$1,000	\$1,750	\$3,000	\$5,000

KRIEGHOFF 36 DATE

POOR	FAIR	GOOD	VERY GOOD	EXCELLENT
\$900	\$1,200	\$2,250	\$3,500	\$5,000

KRIEGHOFF GRIP SAFETY

POOR	FAIR	GOOD	VERY GOOD	EXCELLENT
\$850	\$1,500	\$2,500	\$4,000	\$6,000

KRIEGHOFF DATED

POOR	FAIR	GOOD	VERY GOOD	EXCELLENT
\$800	\$1,000	\$2,000	\$4,000	\$7,500

KRIEGHOFF P CODE, SIDE INSCRIBED

POOR	FAIR	GOOD	VERY GOOD	EXCELLENT
\$850	\$1,250	\$2,750	\$3,250	\$4,000

KRIEGHOFF PRE-WAR COMMERCIAL

POOR	FAIR	GOOD	VERY GOOD	EXCELLENT
\$800	\$1,250	\$2,000	\$3,200	\$4,000

KRIEGHOFF P CODE, PRE-WAR

POOR	FAIR	GOOD	VERY GOOD	EXCELLENT
\$800	\$1,250	\$2,000	\$3,200	\$4,000

KRIEGHOFF WARTIME COMMERCIAL

POOR	FAIR	GOOD	VERY GOOD	EXCELLENT
\$800	\$1,250	\$2,000	\$3,200	\$4,000

KRIEGHOFF POST-WAR COMMERCIAL

POOR	FAIR	GOOD	VERY GOOD	EXCELLENT
\$1,250	\$1,500	\$1,750	\$2,500	\$3,500

KRIEGHOFF POST-WAR UNMARKED

POOR	FAIR	GOOD	VERY GOOD	EXCELLENT
\$1,250	\$1,500	\$1,750	\$2,500	\$3,500

AUSTRIAN BUNDES HEER REWORK

POOR	FAIR	GOOD	VERY GOOD	EXCELLENT
\$500	\$750	\$1,250	\$2,000	\$2,500

The Source for Specifications, History and Pricing

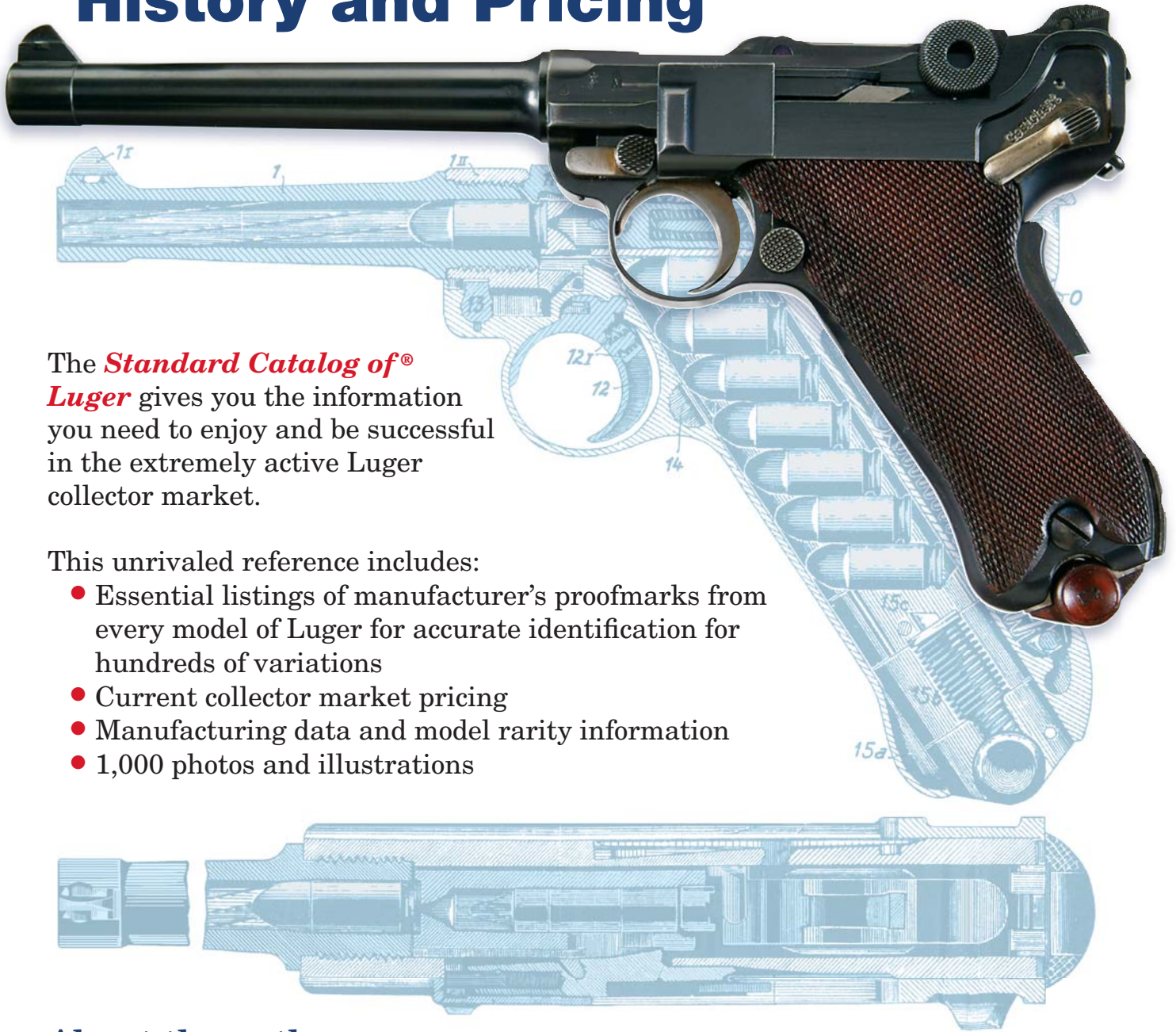

The *Standard Catalog of® Luger* gives you the information you need to enjoy and be successful in the extremely active Luger collector market.

This unrivaled reference includes:

- Essential listings of manufacturer's proofmarks from every model of Luger for accurate identification for hundreds of variations
- Current collector market pricing
- Manufacturing data and model rarity information
- 1,000 photos and illustrations

About the author

Aarron Davis is the pre-eminent authority on Luger pistols. He has 30+ years of gun collecting experience, and a personal collection that includes hundreds of firearms, many WWII and other military weapons. He is also the author of the best-selling book, *The Luger Handbook*.

ISBN-13: 978-0-89689-411-2 \$29.99 U.S.
ISBN-10: 0-89689-411-8 (\$39.99 CAN)

UPC



0 74962 00411 6



Gun Digest Books

An imprint of F+W Publications
888-457-2873
www.gunlistonline.com



9 780896 894112



52999