



**Mi CASITA**  
come dream. come build. 

  
come dream. come build.





# A Man-made Housing Disaster

We have a man-made disaster that has created a much broader and systemically unjust disaster of inadequate, unhealthy and unaffordable housing.



# The Housing Industry Is Broken

- Funding cuts or no funding at all
- Never a holistic approach or solution
- Not enough housing to meet the need
- One size fits all, no cultural fit
- Siloed lending, design, education or construction





# MiCASiTA Foundation

- **Choice Empowers** | *People First*
- **Grow Home** | *Meet The Need Now*
- **Grow Equity** | *Build Wealth*
- **Build Sustainability** | *Build Reasonably*
- **Offsite Manufacturing** | *Build Better*



# Choice Empowers

Choice is critical to racial equity in housing, and MiCASiTA is based on client choice. Our inclusive and collaborative design focus draws on a community-engaged process wherein residents make decisions about the home they are buying.

MiCASiTA will look to evolve these practices digitally through the development of the Choice Empowers app, a cloud-based design tool that helps a homebuyer clearly see how changes to their home design will affect their mortgage - seeing the price in real time, helping them better plan for the future.



# Design Options

All the ways clients can make their MiCASiTA home their own.

## Floor Plan



## Interior Finishes



## Exterior Material

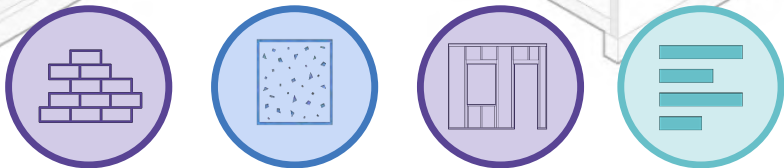

## Type of Porch



## Paint Colors



Mi  
**CASiTA**  
come dream. come build.

**PRODUCT CATALOG &  
CONFIGURATIONS**

# Interior Options

Clients can select from levels of interior finishes and appliances. Selections are made box by box.

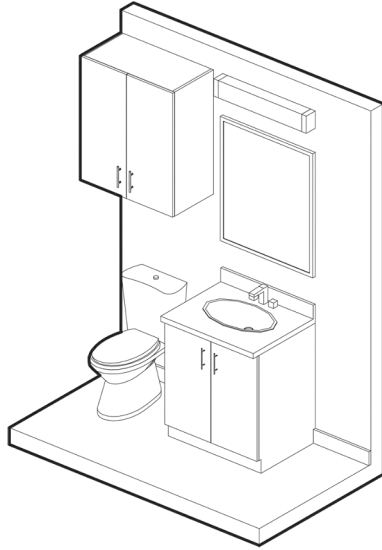
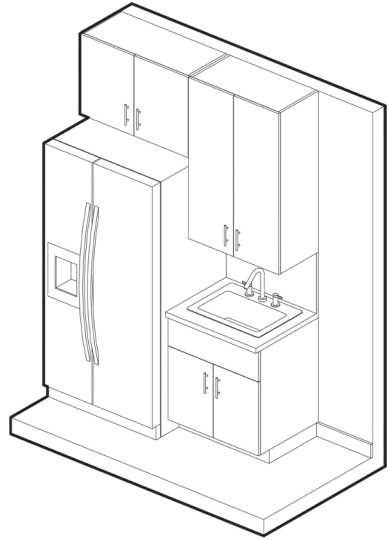

## Packages Include Options inc.

- Appliance
- Cabinet hardware
- Cabinet color
- Flooring
- Door hardware
- Bathroom fixtures
- Cabinets
- Flooring





L Core\_No Porch\_Half brick & Half lap Siding

# Porch Options

Porch additions offer additional living space at a lower cost, while also giving the front of the home greater street presence and individuality.

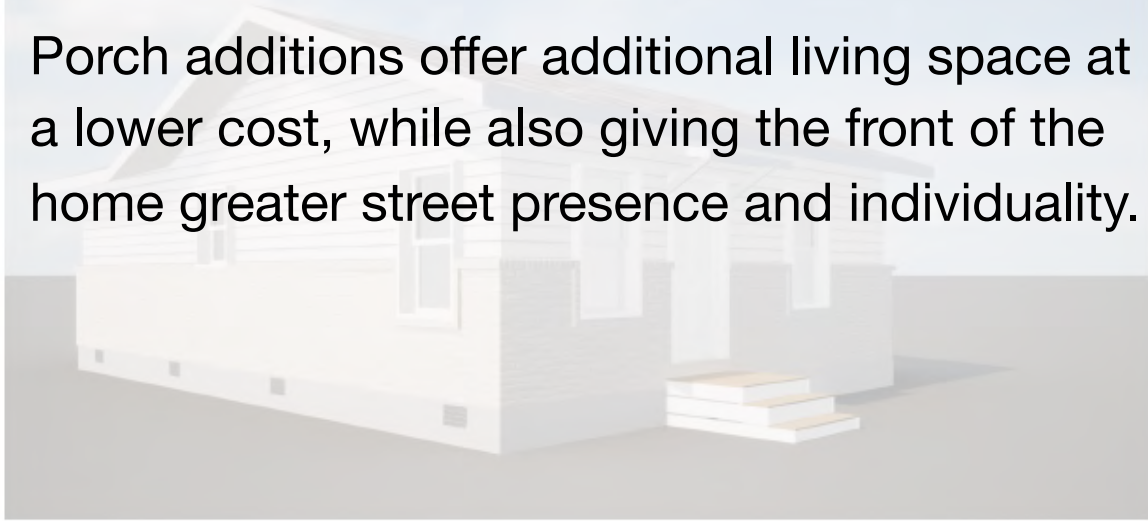

L Core\_Half Porch\_Full brick



L Core\_Full Porch\_Full brick



L Core\_Full Porch\_Lap Siding





# Grow Home

MiCASiTA's GROW Home design and construction process allows families to start with what they can afford today and grow the home over time as their income and credit improves and the family grows.

Starting with a small Core made up of a living/dining area, bathroom and one bedroom and then growing that home to three bedrooms and a porch, all designed by the family each step of the way.

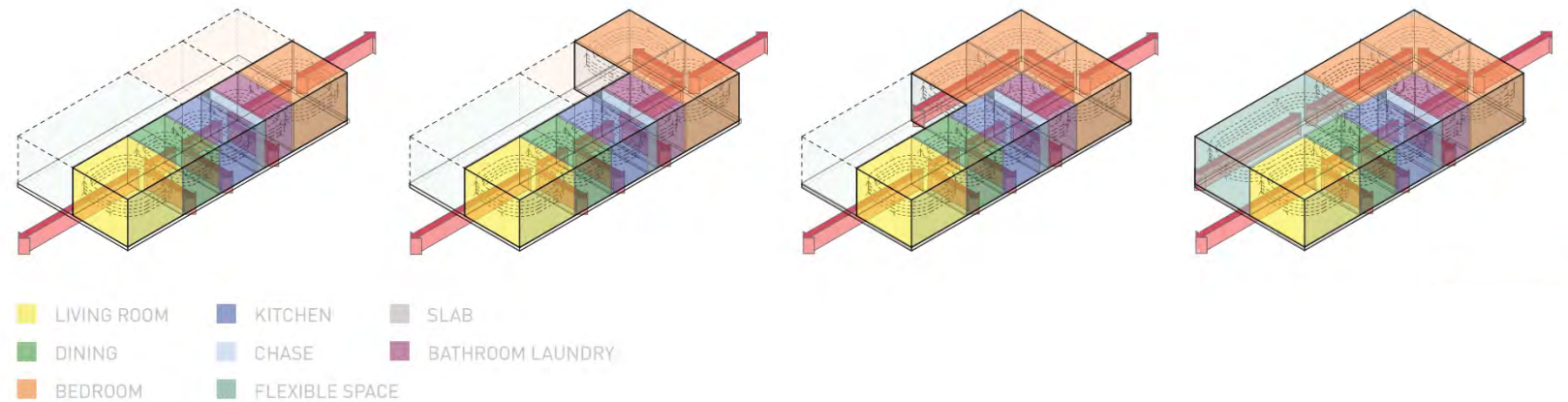
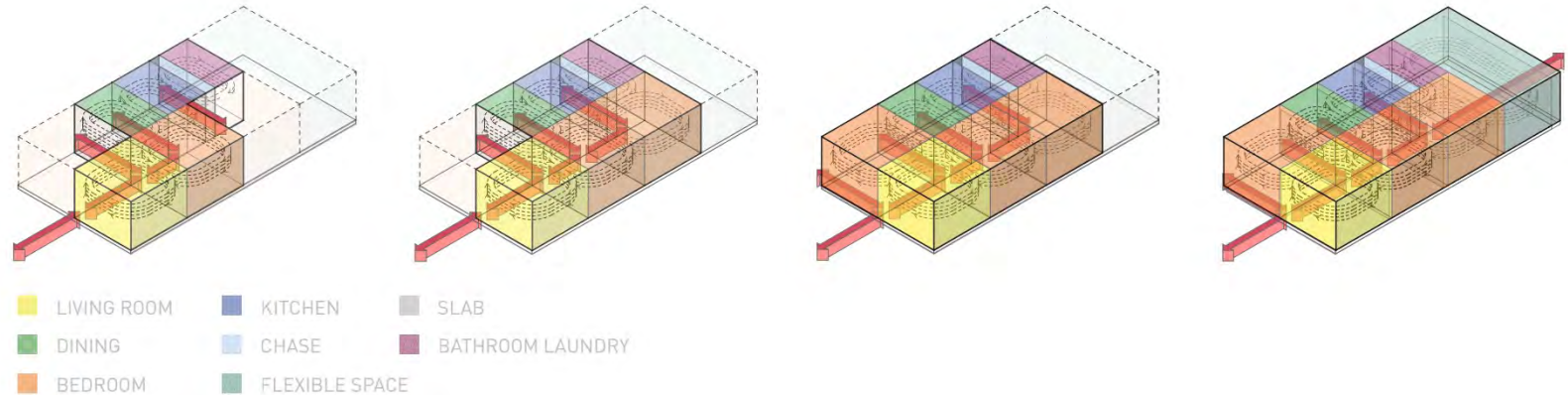



# Green Building

- Environmentally-conscious construction
- Designing and building homes that meets Enterprise Green Communities standards
- Families save on monthly expenses helping to build equity more quickly
- Moving towards solar options with TEPRI





# L-CORE

The L-CORE configures the Wet and Dry box in an L configuration. Depending on the clients lot size it can be positioned horizontally or vertically

The L-CORE is best suited for more traditional subdivision long narrow lots, but could be located a larger rural lot as well.

## 576 Sq Ft Total

1. Bathroom
2. Washer / Dryer
3. Kitchen / Dining
4. Living Room
5. Bedroom

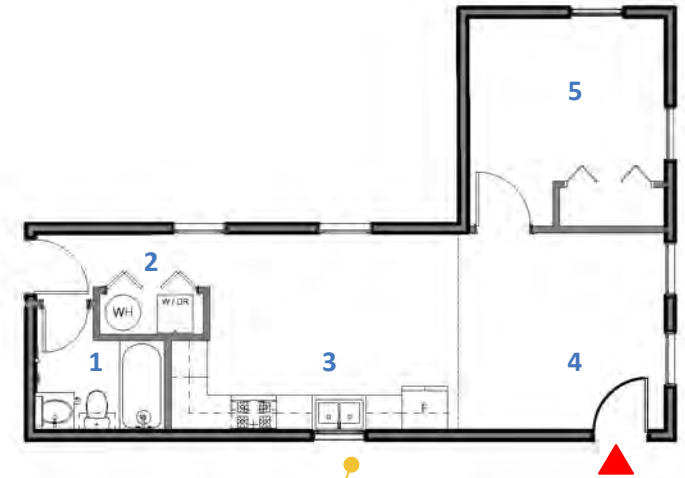
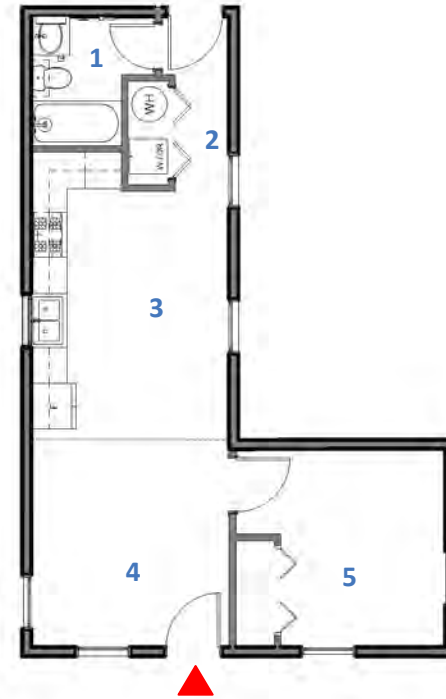

The L is ideal if you want to expand towards the rear.

The L kitchen window can overlook the side or front yard depending on it's orientation.



# O-CORE

The O-CORE configures the Wet and Dry box side-by-side in an O, or square, configuration.

The O-CORE is best suited for wide, shallow lots as it best grows to the right.

It can be orientated to enter into the kitchen / dining room, or living room.

## 576 Sq Ft Total

1. Bathroom
2. Washer / Dryer
3. Kitchen / Dining
4. Living Room
5. Bedroom

The O core kitchen overlooks the back or side yard depending on the orientation.

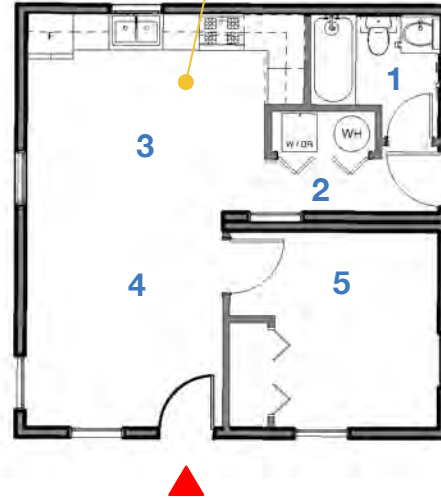

The O core easily expands outward, or to the sides

# Mi CASITA\_BOX OPTIONS



**WET BOX**  
12' X 24'  
288 SQ. FT.

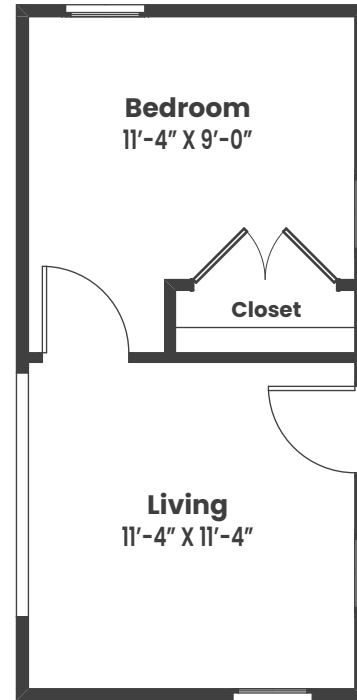

**DRY BOX**  
12' X 24'  
288 SQ. FT.

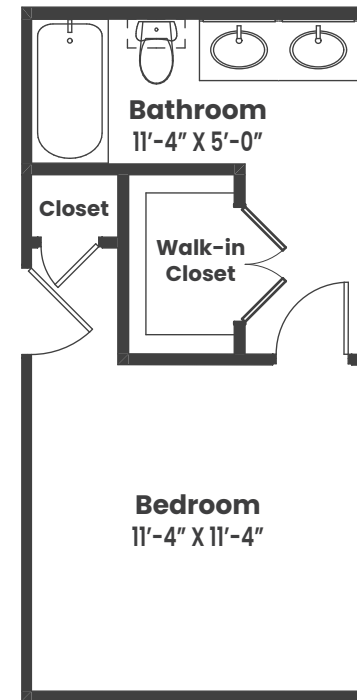

**SUITE BOX**  
12' X 24'  
288 SQ. FT.

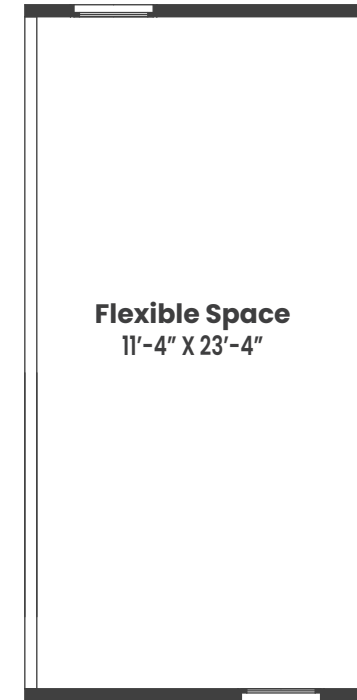

**FLEX BOX**  
12' X 24'  
288 SQ. FT.

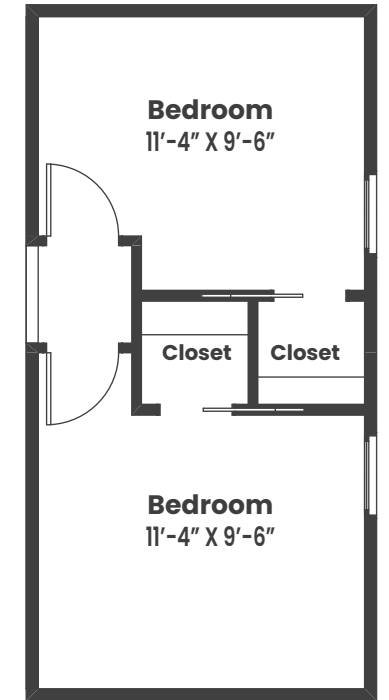

**Pending Licensing**  
**KIDS BOX**  
12' X 24'  
288 SQ. FT.



# Mi CASITA\_STARTING CORE OPTION

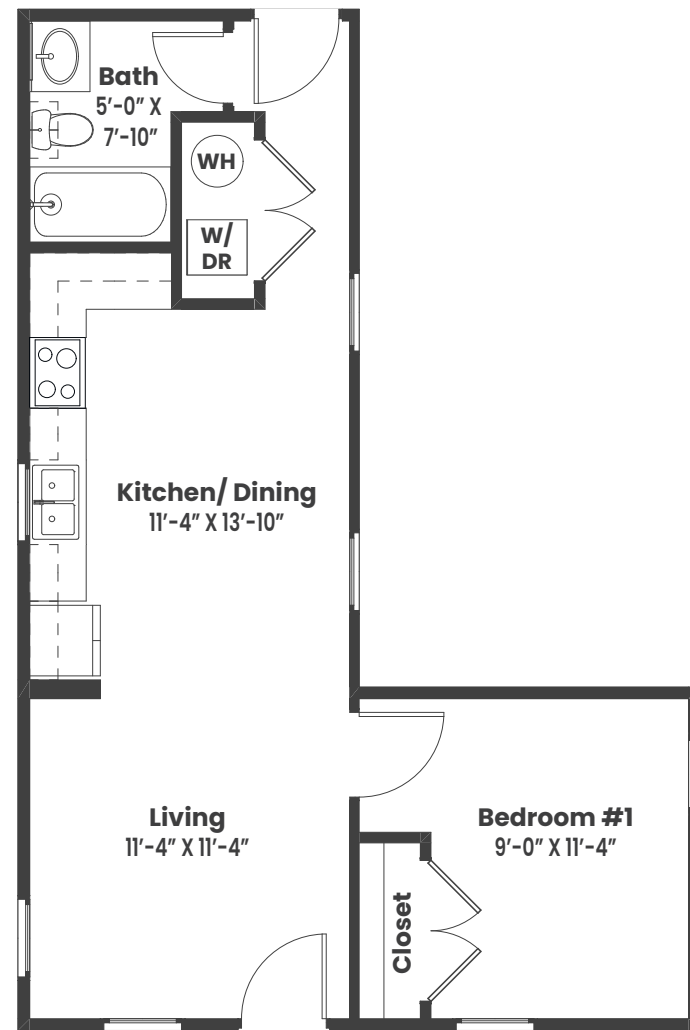

**L-Core (Wet Box + Dry Box)**  
1 bed/ 1 bath  
576 sq. ft.



**L-Core**  
1 bed/ 1 bath  
576 sq. ft.

# Mi CASITA\_STARTING CORE OPTION

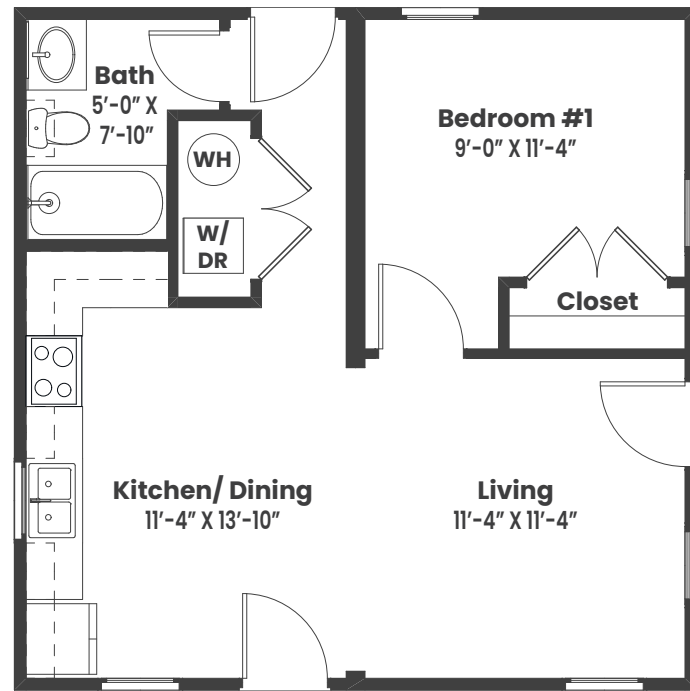

**O-Core (Wet Box + Dry Box)**  
1 bed/ 1 bath  
576 sq. ft.



**O-Core**  
1 bed/ 1 bath  
576 sq. ft.



# Mi CASITA\_L-CORE COMBINATIONS

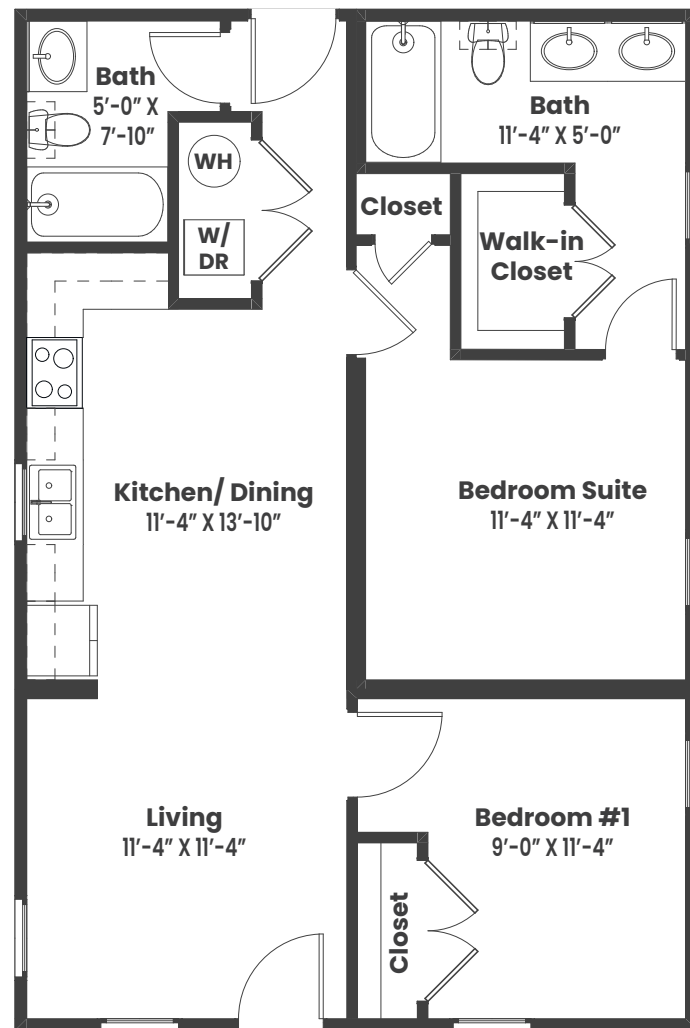

**Combination #1**  
**L-Core + Suite Box**  
 2 bed/ 2 bath  
 864 sq. ft.

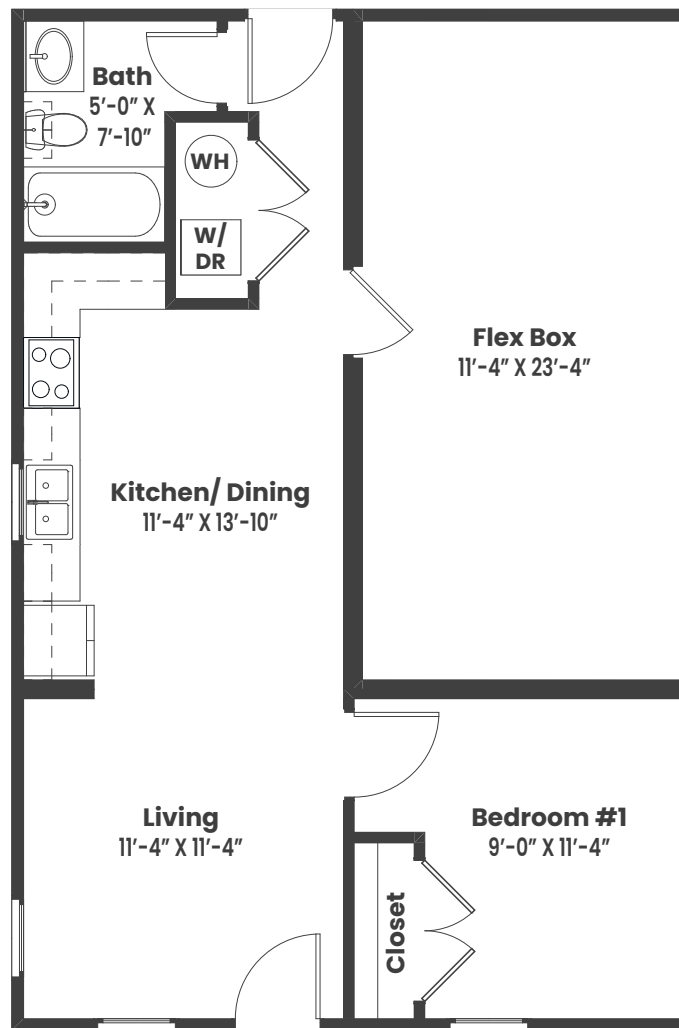

**Combination #2**  
**L-Core + Flex Box**  
 1 bed/ 1 bath  
 864 sq. ft.

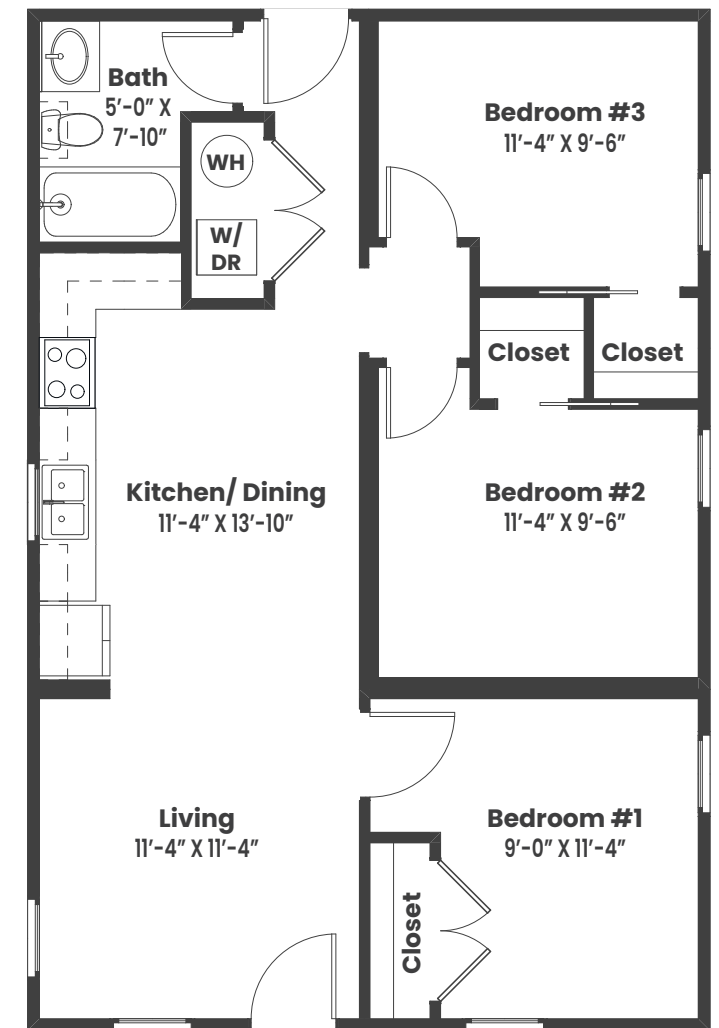

**Pending Licensing**  
**L-Core + Kids Box**  
 3 bed/ 1 bath  
 864 sq. ft.

# Mi CASITA\_L-CORE COMBINATIONS



**Combination #1  
L-Core + Suite Box**



**Combination #2  
L-Core + Flex Box**



# Mi CASITA\_L-CORE COMBINATIONS



**Combination #3**  
**L-Core + Suite Box**  
 2 bed/ 2 bath  
 864 sq. ft.



**Combination #4**  
**L-Core + Flex Box**  
 1 bed/ 1 bath  
 864 sq. ft.

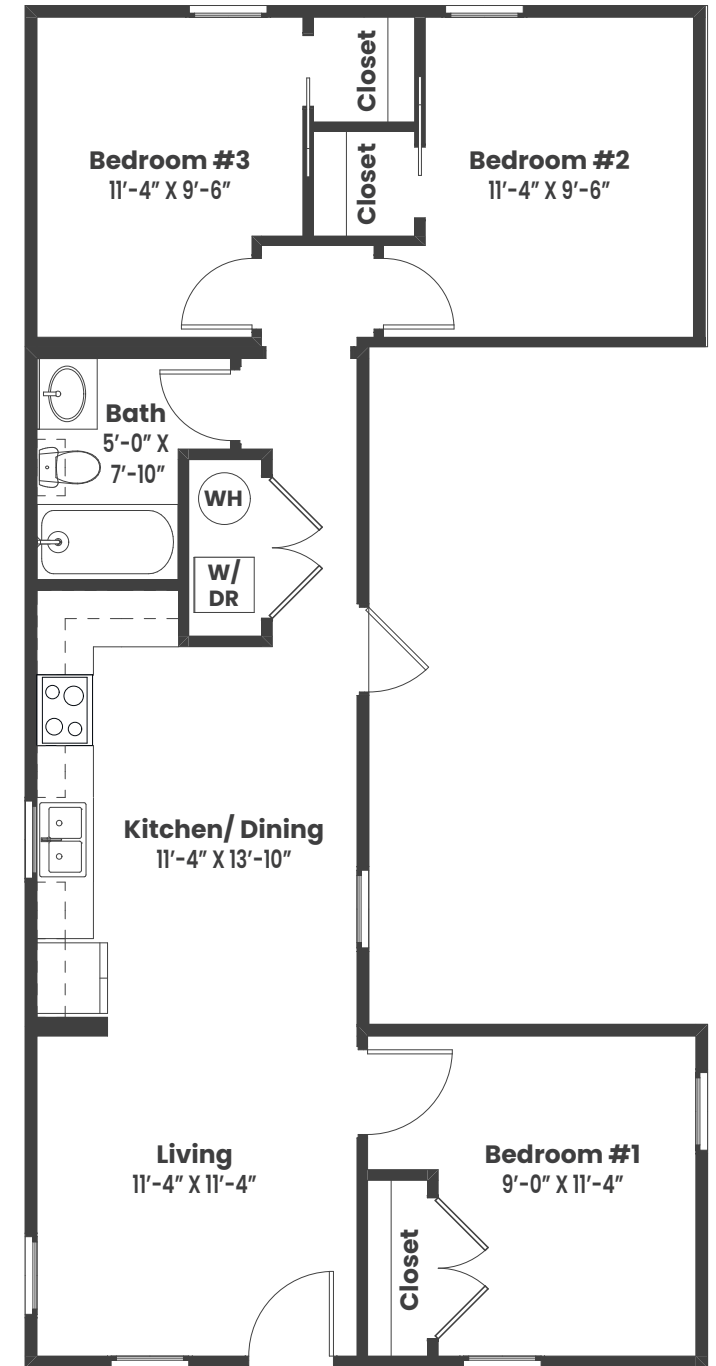

**Pending Licensing**  
**L-Core + Kids Box**  
 3 bed/ 1 bath  
 864 sq. ft.

# Mi CASITA\_L-CORE COMBINATIONS



**Combination #3**  
**L-Core + Suite Box**



**Combination #4**  
**L-Core + Flex Box**



# Mi CASITA\_L-CORE COMBINATIONS

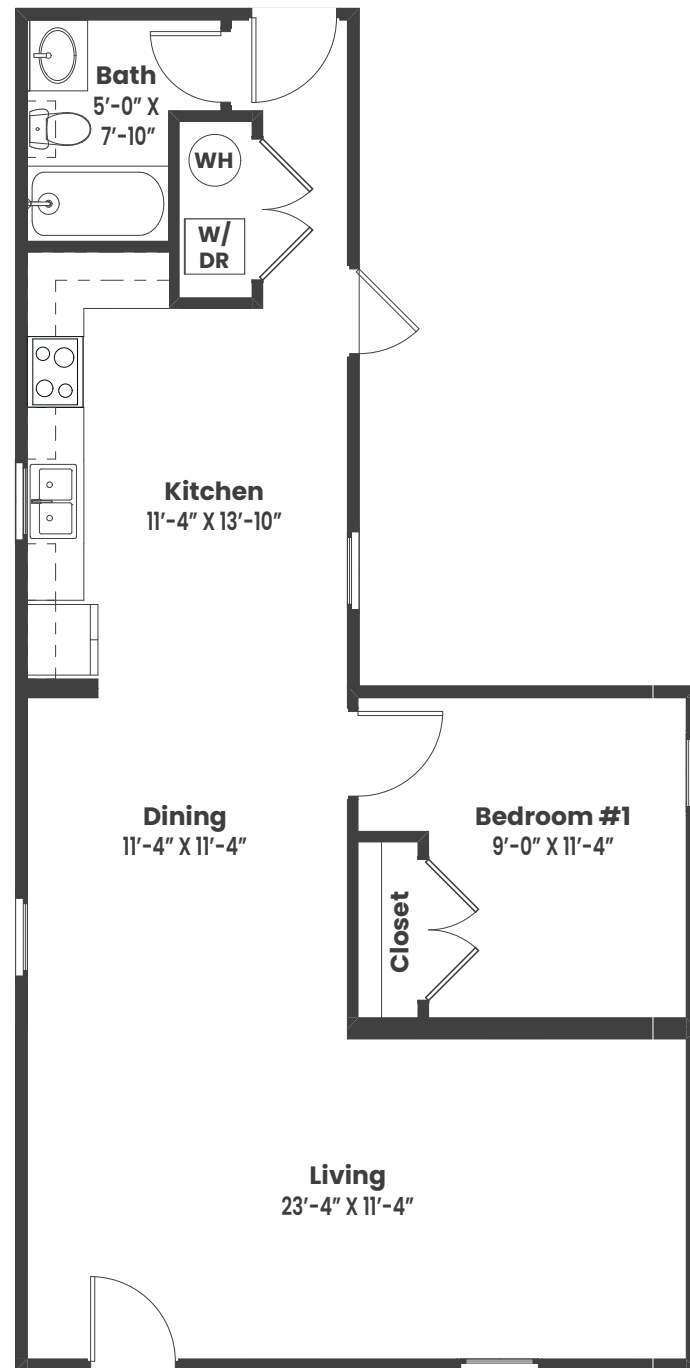

**Combination #5**  
**L-Core + Flex Box**  
 1 bed/ 1 bath  
 864 sq. ft.



**Combination #6**  
**L-Core + (2) Suite Box**  
 3 bed/ 3 bath  
 1,152 sq. ft.



**Combination #7**  
**L-Core + (2) Flex Box**  
 1 bed/ 1 bath  
 1,152 sq. ft.

# Mi CASITA\_L-CORE COMBINATIONS



**Combination #5**  
**L-Core + Flex Box**



**Combination #6**  
**L-Core + (2) Suite Box**



**Combination #7**  
**L-Core + (2) Flex Box**



# Mi CASITA\_L-CORE COMBINATIONS



**Combination #8**  
**L-Core + Flex Box + Suite Box**  
 2 bed/ 2 bath  
 1,152 sq. ft.

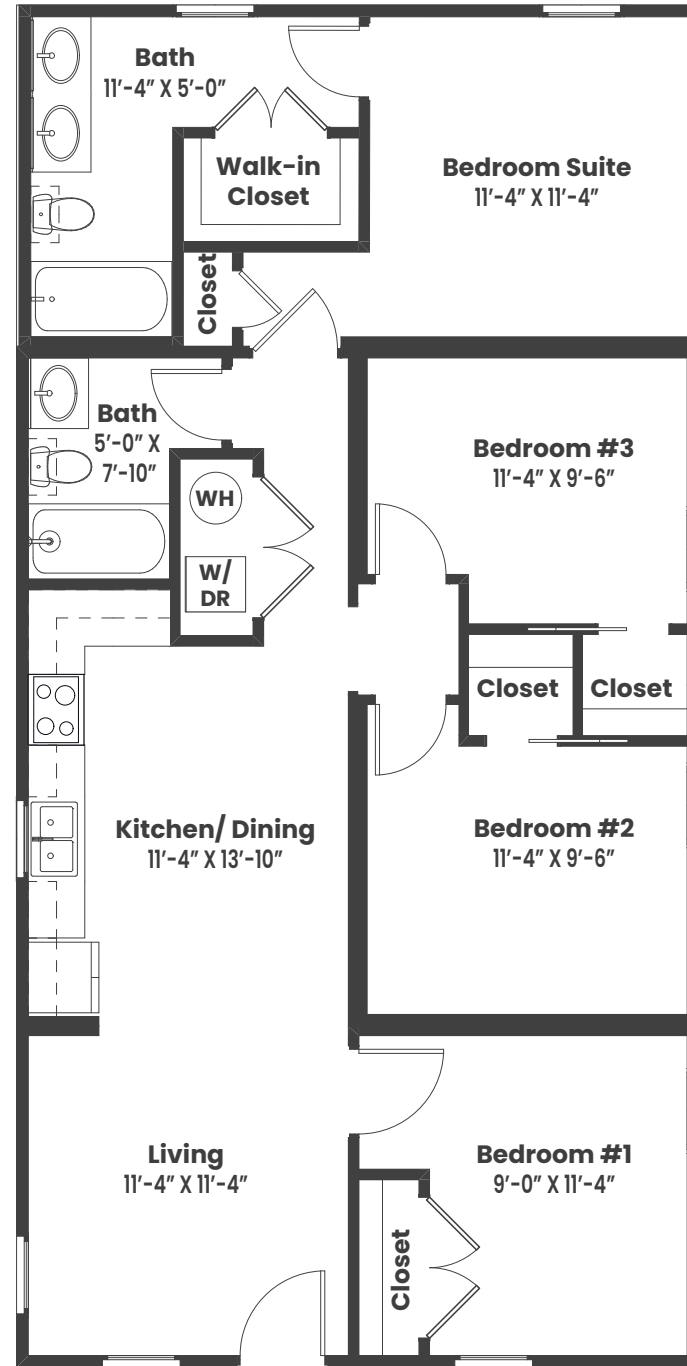

**Pending Licensing**  
**L-Core + Kids Box + Suite Box**  
 4 bed/ 2 bath  
 1,152 sq. ft.



**Combination #8**  
**L-Core + Flex Box + Suite Box**

# Mi CASITA\_L-CORE COMBINATIONS



**Combination #9**  
**L-Core + Flex Box + Suite Box**  
 2 bed/ 2 bath  
 1,152 sq. ft.



**Pending Licensing**  
**L-Core + Kids Box + Suite Box**  
 4 bed/ 2 bath  
 1,152 sq. ft.



**Combination #9**  
**L-Core + Flex Box + Suite Box**



# Mi CASITA\_O-CORE COMBINATIONS

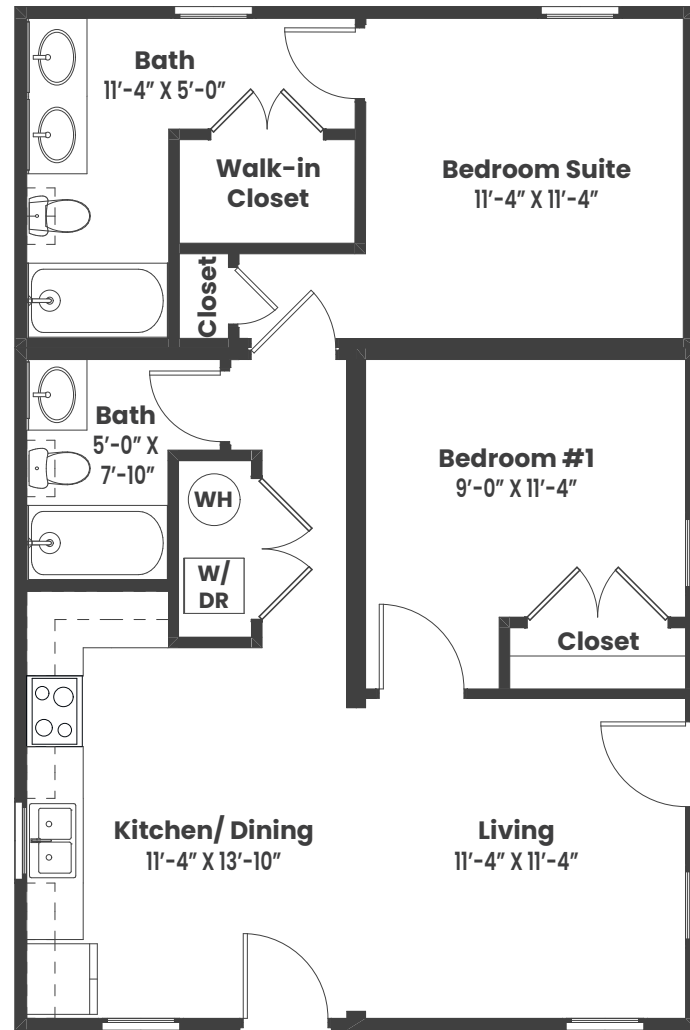

**Combination #1**  
**O-Core + Suite Box**  
 2 bed/ 2 bath  
 864 sq. ft.

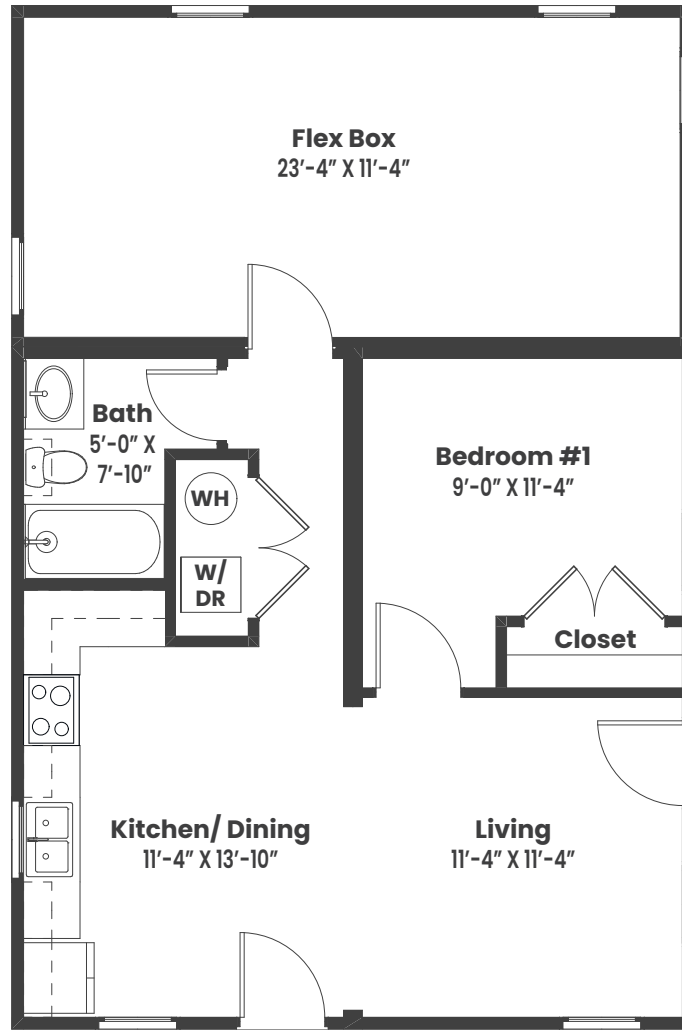

**Combination #2**  
**O-Core + Flex Box**  
 1 bed/ 1 bath  
 864 sq. ft.

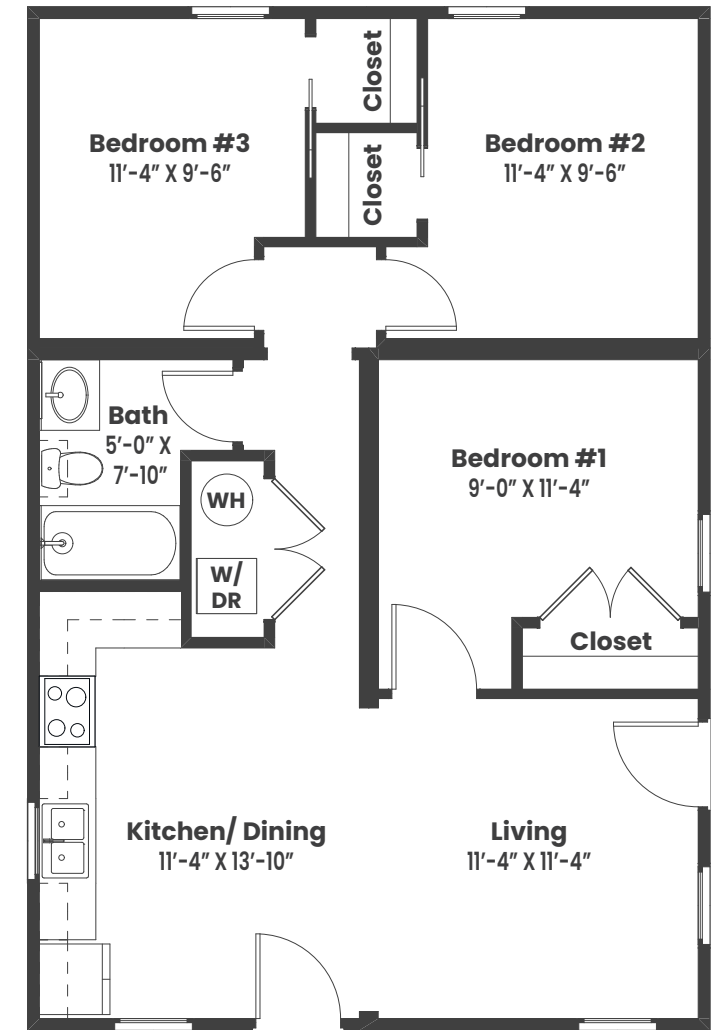

**Pending Licensing**  
**O-Core + Kids Box**  
 3 bed/ 1 bath  
 864 sq. ft.

# Mi CASITA\_O-CORE COMBINATIONS



**Combination #1**  
**O-Core + Suite Box**



**Combination #2**  
**O-Core + Flex Box**



# Mi CASITA\_O-CORE COMBINATIONS



**Combination #3**  
**O-Core + Suite Box + Flex Box**  
 2 bed/ 2 bath  
 1,152 sq. ft.

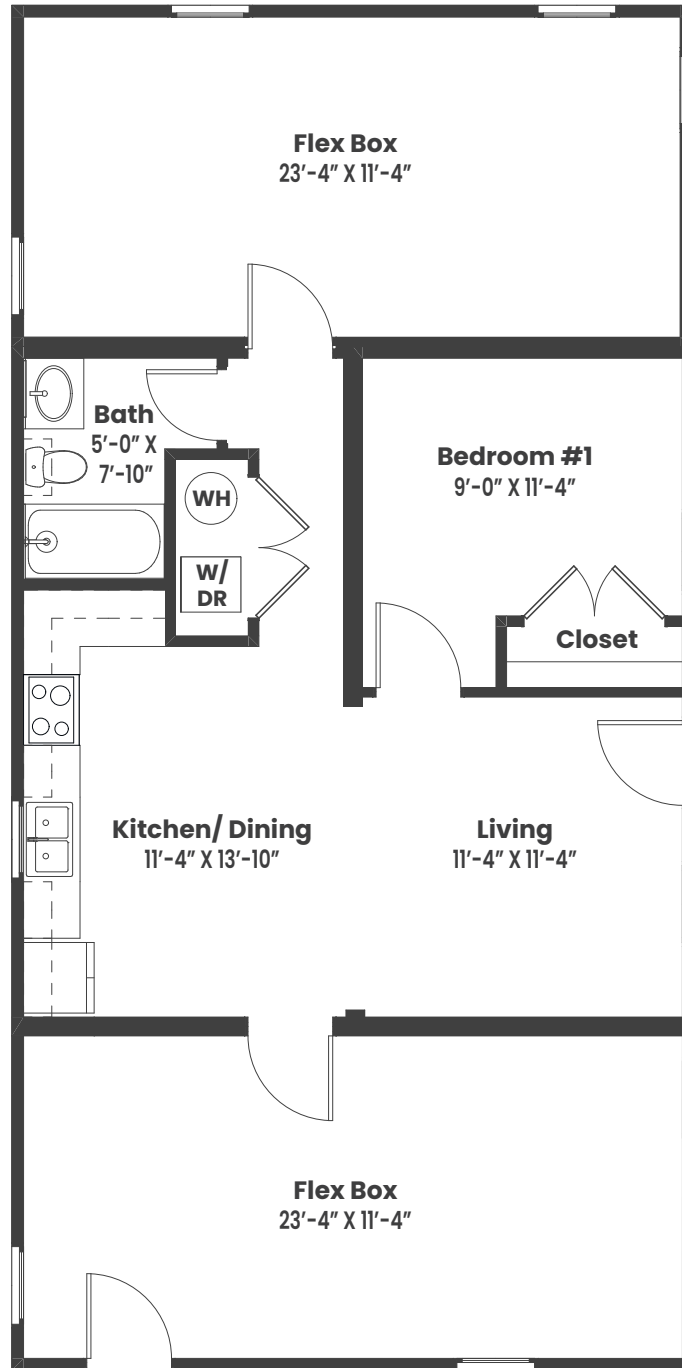

**Combination #4**  
**O-Core + (2)Flex Box**  
 1 bed/ 1 bath  
 1,152 sq. ft.

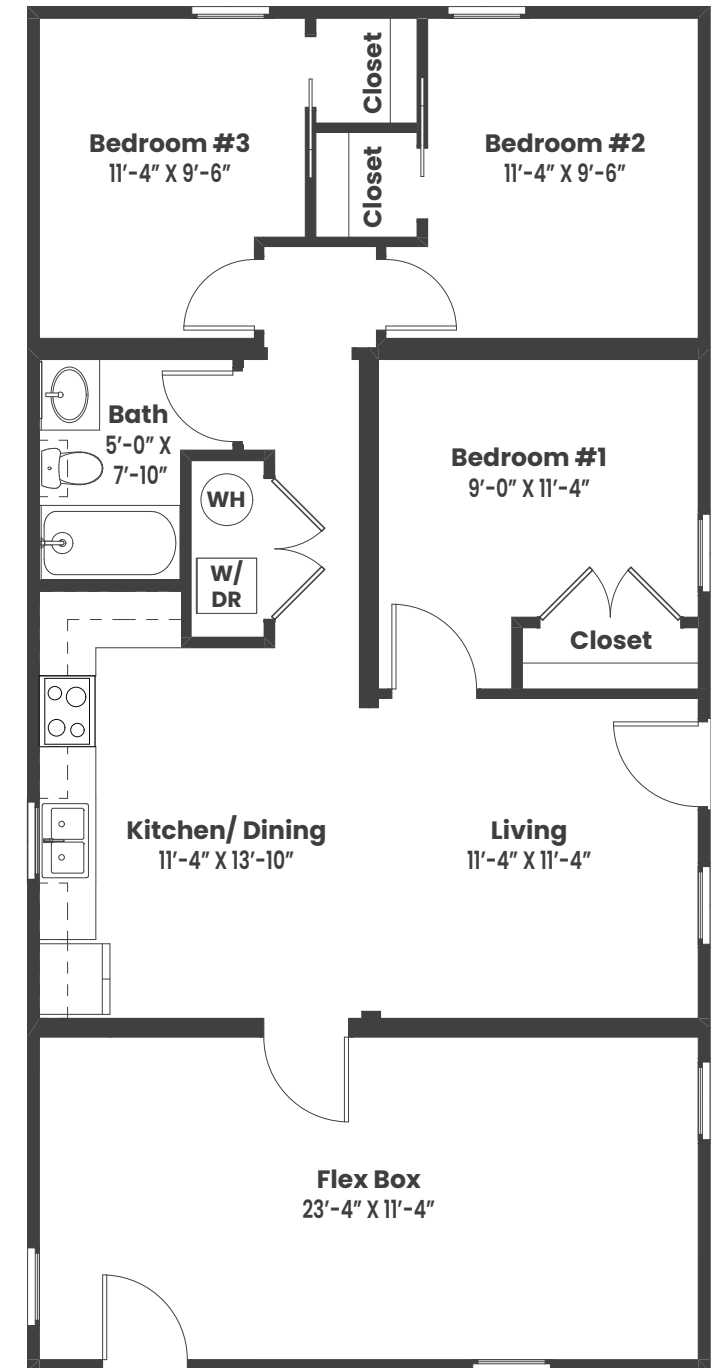

**Pending Licensing**  
**O-Core + Flex Box + Kids Box**  
 3 bed/ 1 bath  
 1,152 sq. ft.

# Mi CASITA\_O-CORE COMBINATIONS



**Combination #3**  
**O-Core + Suite Box + Flex Box**



**Combination #4**  
**O-Core + (2)Flex Box**



# Grow Equity – Day 1

- Financing for Completion Ensures Homebuyer Success.
- Phased Construction + Phased Financing = Success + Equity.

## Payment / Equity / Loan

- Loan increases as boxes are added.
- Equity increases as down payment is applied per new loan.
- P&I Payment increases as loan increases

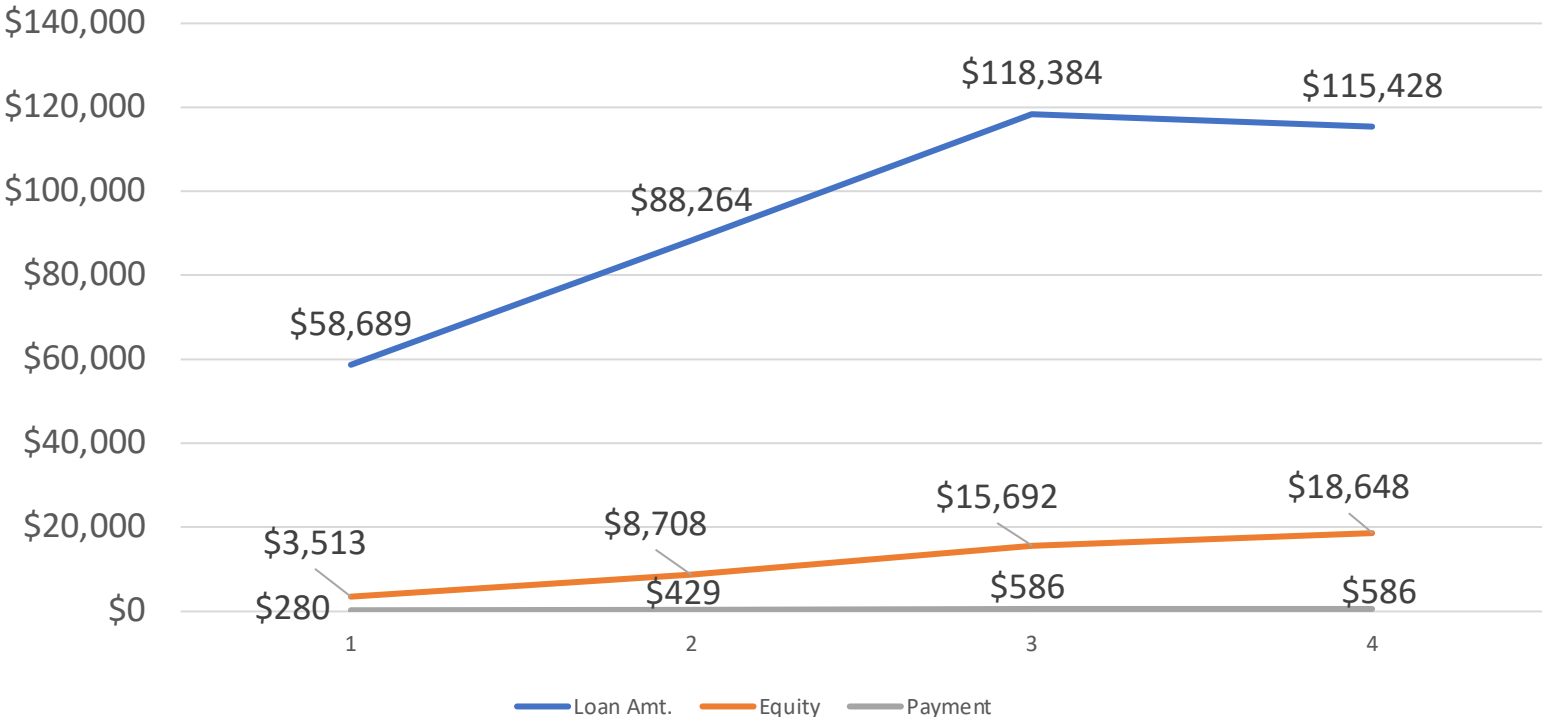

# Offsite Manufacturing

The offsite manufacturing model will allow for distribution across a large regional rural market in a half to a quarter of the time it takes to build a standard site-built stick home.

The MiCASiTA design and construction method will allow for a high quality “pop-up” manufacturing process, created to set-up, operate and scale in different markets with few changes to the overall system.





# Modular Home & Manufacturing

This is not Standard Construction it is Volumetric Modular Home Manufacturing.

- Quality – Always watching and keeping quality at its highest level
- Speed – Produce each box within 5 days
- Volume – Produce up to 70 Boxes within 12 months on 12,000 sf. of manufacturing space.





# Code & Building Standards

Approved by NTA. Licensed by  
The State of Texas TDLR.

- International Residential Code (IRC) with Texas Amendments
- 2015 Edition National Electrical Code (NEC) with Texas Amendments 2014 Edition
- 2015 IECC with Texas Amendments
- 16 TAC, Chapter 70, Industrialized Housing and Buildings Administrative Rules
- Enterprise Green Communities Certifiable Units

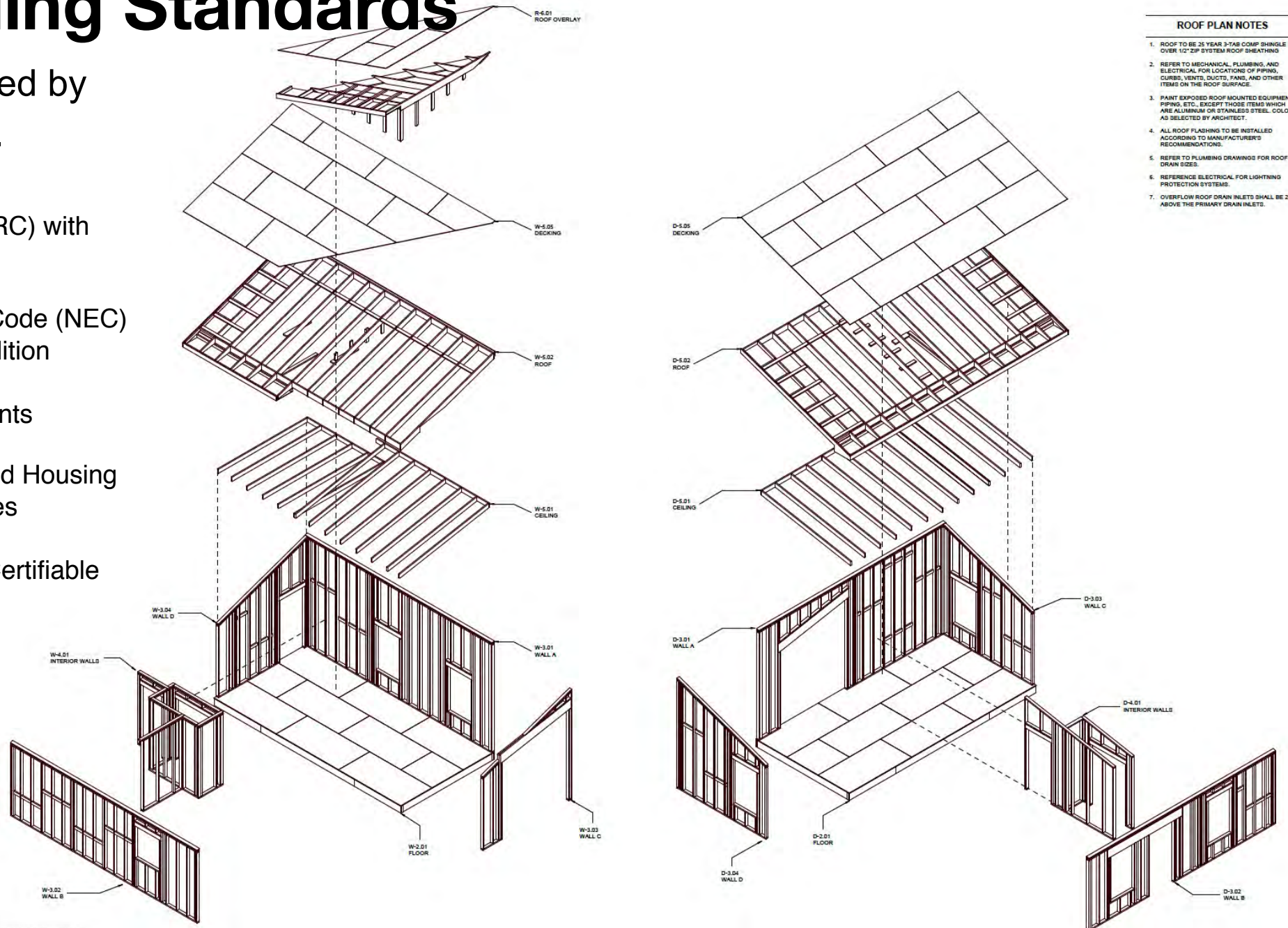

## ROOF PLAN NOTES

1. ROOF TO BE 25 YEAR 3-TAB COMP SHINGLE OVER 1/2" ZIP SYSTEM ROOF SHEATHING.
2. REFER TO MECHANICAL, PLUMBING, AND ELECTRICAL FOR LOCATIONS OF PIPING, DUMBS, VENTS, DUCTS, FANS, AND OTHER ITEMS ON THE ROOF SURFACE.
3. PAINT EXPOSED ROOF MOUNTED EQUIPMENT PIPING, ETC., EXCEPT THOSE ITEMS WHICH ARE ALUMINUM OR STAINLESS STEEL. COLOR AS SELECTED BY ARCHITECT.
4. ALL ROOF FLASHING TO BE INSTALLED ACCORDING TO MANUFACTURER'S RECOMMENDATIONS.
5. REFER TO PLUMBING DRAWINGS FOR ROOF DRAIN SIZES.
6. REFERENCE ELECTRICAL FOR LIGHTNING PROTECTION SYSTEMS.
7. OVERFLOW ROOF DRAIN INLETS SHALL BE 2" ABOVE THE PRIMARY DRAIN INLETS.



# Completed Homes







615

2









9  
0  
3  
6







**Our goal is to re-tool the entire affordable housing delivery system**







- Increase choice and empowering buyers by being fully engaged in the design process using our Choice Empowers app.
- Building a franchise model that has built-in systems, processes and technology to support market diversity and context, both culturally and economically.
- Localizing the response for true “community building and empowerment”, giving buyers the opportunity to ensure intergenerational transfer of wealth and build equity through homeownership.