



REQUEST FOR BIDS (by Email)

Date: January 29, 2024	To: Potential Bidders for SHA Solicitation #5858		
The work described below is subject to the conditions described on Attachment A, version 1 <input type="checkbox"/> version 2 <input checked="" type="checkbox"/>			
SHA Reference No.: 5858 Various Hope VI Shower Upgrades - LP Non-Federal Funding	(Federal Prevailing Wages) Federal Wage Decision No.: N/A	OR	(State Prevailing Wages) Date of State Prevailing Wage Schedule: 02/20/2024
Number of Calendar Days to Complete Work: 365 Plus up to two (2) optional 1-year extensions	For Questions Contact: Veronica Sharp, Design and Construction Contract Administrator	Phone No.:	206-239-1553
		FAX No.:	N/A
		E-mail:	purchasing@seattlehousing.org
Project Description <ul style="list-style-type: none"> Scope of Work: <input checked="" type="checkbox"/> See Scope of Work attached. Asbestos Disclosure: SHA is reasonably certain that asbestos will not be disturbed by this project. <p style="text-align: center;">Bid range estimated to be between \$50,000 and \$60,000 per year.</p>			
PRE-BID MEETING: <u>Wednesday, February 14, 2024, at 3:00 PM</u> , on Microsoft Teams. Meeting link provided at end of form, after submission checklist.			
DEADLINE FOR QUESTIONS is <u>Thursday, February 15, 2024, no later than 5:00 PM</u> . Email your questions to: purchasing@seattlehousing.org			
BID DUE DATE AND TIME: <u>Thursday, February 29, 2024, by 2:00 PM</u> . The bidder is responsible for ensuring that its Bid is received prior to the deadline. Bids received after the deadline will not be considered.			
Bids for Small Works Roster advertised projects will only be accepted from contractors who are listed on Seattle Housing Authority's Small Works Roster at the time bid is due. SHA utilizes the Small Public Works Roster maintained by MRSC to solicit bids from contractors for this solicitation. Register for FREE at www.mrscrosters.org and select Seattle Housing Authority. All companies on the roster must meet the agency's minimum qualifications for licensing bonding, and insurance and not be on any state or federal debarment lists.			
EMAIL YOUR BID TO: purchasing@seattlehousing.org or deliver to the address above.			
BIDDER ACKNOWLEDGES RECEIPT OF ADDENDA(S) NUMBER(S): _____			
BIDDER MUST COMPLETE THE INFORMATION BELOW. In addition, if bidder has never done business with SHA, it must submit a vendor fact sheet with its bid form. Bidder must also submit the required Section 3 forms with its bid form.			
<input checked="" type="checkbox"/> If checked, Bidder must complete the attached Detailed Bid Price Form and provide the total bid price below.			
Basic Bid Price (without Sales Tax)	Sales Tax on Materials and Labor (see Attachment A)	Total Bid Price (with Sales Tax)	
Bidder's Business Name:	Telephone No.:	E-Mail Address:	
Address:		City, State, Zip Code:	
Business Classification: <input type="checkbox"/> WBE <input type="checkbox"/> MBE <input type="checkbox"/> MWBE <input type="checkbox"/> Section 3		Contractor Registration No.:	
Signature:	Date:	Printed Name and Title of Person Signing Bid:	

By signing above, the Bidder acknowledges receipt of Attachment A and any addenda issued for this project and proposes to furnish all material and labor and to perform all work described herein for the Bid Price noted above. The Bidder also certifies the following: to have personally and carefully evaluated the Project Description and Attachment A, and to have a clear understanding of the same, including the requirement to pay prevailing wages.

- ATTACHMENT A: Version 2**
- ATTACHMENT B: Requirements**
 - 1. **Scope of Work**
 - a. **ADA Section 608**
 - b. **Substitution Request Form**
 - 2. **General Conditions of The Contract For Construction_12.05.2022**
- ATTACHMENT C: Prevailing Wage Rates – Washington State Prevailing Wages Effective Date: 02/20/2024**
- ATTACHMENT D: Sample Documents**
 - 1. **Sample Contract**
 - 2. **Sample Work Order**
- ATTACHMENT E: Forms**
 - 0. **Bid Price Form**
 - 1. **SHA Vendor Fact Sheet**
 - 2. **Section 3 documents – not used for this solicitation**
 - 3. **Suspension and Debarment Compliance Certificate for Contractor/Subcontractor**
 - 4. **For-Profit Subgrantee and Contractor Certifications and Assurances – not used for this solicitation**
 - 5. **Certification of Compliance with Wage Payment Statutes (SSB5301)**
 - 6. **Non-Collusive Affidavit**

SUBMISSION CHECKLIST - THE FOLLOWING FORMS NEED TO BE COMPLETED, SIGNED AND RETURNED

- _____ **Request for Bids (Page 1 and Page 2)**
- _____ **Bid Price Form (Page 1 and Page 2)**
- _____ **Bid Bond**
- _____ **SHA Vendor Fact Sheet**
- _____ **Suspension and Debarment Compliance Certificate for Contractor/Subcontractor**
- _____ **Certification of Compliance with Wage Payment Statutes**
- _____ **Non-Collusive Affidavit**

PRE-BID MEETING INFORMATION

Wednesday, February 14, 2024, at 3:00 PM, on Microsoft Teams.

Microsoft Teams meeting

Join on your computer, mobile app or room device

[Click here to join the meeting](#)

Meeting ID: 263 152 250 493

Passcode: j6jriR

[Download Teams](#) | [Join on the web](#)

Join with a video conferencing device

[507130161@t.plcm.vc](tel:507130161@t.plcm.vc)

Video Conference ID: 116 955 656 7

[Alternate VTC instructions](#)

Or call in (audio only)

[+1 206-257-3799,,99348323#](tel:+12062573799,99348323#) United States, Seattle

Phone Conference ID: 993 483 23#

[Find a local number](#) | [Reset PIN](#)



[Learn More](#) | [Meeting options](#)



Attachment A, Version 2

Request For Bid (by e-mail)

The work described in the Request For Bid (by e-mail) is subject to the following terms and conditions:

Bidder Responsibility: The bidder must meet the mandatory bidder responsibility criteria described below and as specified in RCW 39.04 or 2 CFR 200 in order to be considered a responsible contractor and be eligible for award consideration:

1. At the time of bid submittal, have a current certificate of registration in compliance with chapter 18.27 RCW, which must have been in effect at the time of the bid submittal.
2. Have a current Washington Unified Business Identifier (UBI) number.
3. If applicable:
 - Have Industrial Insurance (workers' compensation) coverage for the bidder's employees working in Washington, as required in Title 51 RCW;
 - Have a Washington Employment Security Department number, as required in Title 50 RCW;
 - Have a Washington Department of Revenue state excise tax registration number, as required in Title 82 RCW;
 - Electrical Contractor License, if required by Chapter 19.28 RCW
 - Elevator Contractor License, if required by Chapter 70.87 RCW
 - Plumbing Contractor License, if required by Chapter 18.106 RCW
4. Not be disqualified from bidding on any public works contract under RCW 39.06.010 or RCW 39.12.065(3).
5. Has not been debarred, suspended, or otherwise ineligible to contract with SHA and is not included on the Excluded Parties List System (EPLS) on GSA's SAM (System for Award Management) <https://www.sam.gov/portal/public/SAM/> or the Department of Housing and Urban Development's "Limited Denial of Participation" list. This requirement also applies to the Bidder's principals.
6. Have completed training requirements under RCW 39.04.350 before bidding on public works projects as determined by the Washington State Department of Industries OR are exempt from the training requirements under RCW 39.04.350.
7. Within the three-year period immediately preceding the date of the proposal submittal, has not have been determined by a final and binding citation and notice of assessment issued by the department of labor and industries or through a civil judgment entered by a court of limited or general jurisdiction to have willfully violated, as defined in RCW 49.48.082, any provision of chapter 49.46, 49.48, or 49.52 RCW.

Prevailing Wages: The Contractor must pay all workers at least the prevailing wage rate for the type of work performed in accordance with the applicable prevailing wage rate schedule referenced on the Purchase Order or Request for Bid (by e-mail) form and included in these solicitation documents. The type of wage schedule attached i.e., HUD Determined, Davis-Bacon, or the State Prevailing Wage schedule determines the appropriate labor standards that apply to the work as outlined below and contained in the General Conditions for Construction:

- 1) Part 11.13 for projects subject to the HUD-Determined wage rate schedule.
- 2) Part 11.12 for projects subject to Davis-Bacon wage schedule.
- 3) Part 5 for projects subject to the State prevailing wage schedule.

As part of its compliance with the prevailing wage requirements, the Contractor and, if applicable, subcontractor(s) shall comply with the requirement to submit a Statement of Intent to Pay Prevailing Wages and Affidavit of Wages Paid forms approved by the State of Washington's Department of Labor and Industries. Upon written request from SHA, the Contractor shall also comply (and shall cause its subcontractors to comply) with any special, alternative, or supplemental filing instructions and requirements.

Bid Bond: SHA does not require a bid guarantee for small works roster construction projects estimated to cost \$100,000 or less.

Insurance: Within seven calendar days of award, the Contractor shall submit to SHA, and maintain throughout the contract, at no expense to SHA, the following insurance coverage at the limits noted. Refer to SHA's General Conditions Of The Contract For Construction (the "General Conditions" or "SHA's General Conditions") for more details:

1. Commercial General Liability Insurance. \$1,000,000 each occurrence, and \$2,000,000 in the aggregate.
2. Additional Insured Endorsement Ongoing Operations: SHA (and any limited partnership when applicable) must be included as an Additional Insured on a primary and non-contributory basis on all Commercial General Liability policies of the Contractor. A Certificate of insurance (and policy endorsements if needed) must be provided to SHA as evidence of additional insured coverage.
3. Additional Insured Endorsement Completed Operations: The Contractor's CGL insurance shall include SHA (and any limited partnership when applicable) as an additional insured for Contractors Completed Operations by providing additional insured status on the CG2037 endorsement, or by an equivalent policy or endorsement provision. The Contractors Completed Operations additional insured status for SHA (and any limited partnership when applicable) shall remain in effect for not less than three (3) years following the Final Acceptance of the Work by the Owner.
4. Employers Liability policy or Washington Stop Gap Liability insurance endorsement: \$1,000,000 each accident/occupational disease.
5. Workers Compensation coverage.
6. Commercial Business Auto Coverage. \$1,000,000 per accident.
7. Pollution Liability Insurance: \$1,000,000 combined single limit coverage, if the work involves handling or disposal of asbestos, lead-based paint, contaminated soil, or other hazardous materials.

Performance & Payment Bond Requirements: Within seven calendar days of award, the Contractor shall submit to SHA, in accordance with Section 2.05 of the General Conditions, a Performance and Payment bond. Failure to furnish a Performance and Payment bond within the time specified may render the Contractor ineligible for the contract. SHA may then either award the contract to the next lowest responsible bidder or solicit new bids.

1. The bond requirement can be waived for contracts up to \$100K. If this option is exercised, SHA will hold 10% retainage in lieu of bonds.

Retainage Requirements: SHA requires retainage to be withheld for small works roster construction projects costing \$50,000 or more. Standard retainage is 5%.

Tax Exempt Status of SHA: Pursuant to State law (RCW 35.82.210), SHA is exempt from paying sales tax when it obtains goods and services directly from the Contractor.

Protests: Any protest of award shall be resolved in accordance with SHA's Procurement Policies, which may be reviewed at [SHA website](#).

General Conditions: SHA's General Conditions are incorporated by reference and made a part of this Request for Bid (by e-mail) and any subsequent contract or purchase order executed for this work as if fully included herein. If the event of any discrepancy between the terms of this Attachment A and the General Conditions, the General Conditions apply, except that the types and amounts of insurance specified above, and the waiver of the Contract Bond and withholding of retainage specified above, shall take precedence over the General Conditions. The General Conditions may be viewed by accessing [SHA website](#), or upon request by calling SHA at (206) 615-3379.

Performance Evaluation: The Contractor's performance on this project will be evaluated in accordance with SHA's Contractor Performance Evaluation Program. A copy of the Program may be obtained by accessing [SHA website](#).

Section 3: Section 3 is a provision of the Housing and Urban Development Act of 1968. The purpose of Section 3 is to ensure that employment and other economic opportunities generated by certain HUD financial assistance shall, to the greatest extent feasible, and consistent with existing Federal, State, and local laws and regulations, be directed to low- and very low-income persons, particularly those who are recipients of government assistance for housing, and to business concerns which provide economic opportunities to low- and very low-income persons. Each bidder is required to submit with its Bid a Section 3 Business Certification form. Failure to complete this form may render a bid non-responsive.

- A. Section 3 Contract Language: The following language regarding Section 3 will be included as part of the contract to be executed based on this solicitation:

Contractor will comply with Section 3 of the Housing and Urban Development Act of 1968, 12 U.S.C. 1701u, and its implementing regulations set forth at 24 CFR 75 (as each of the same has been or may be amended, modified, or replaced from time to time, and including any successor statutes or regulations, collectively, "Section 3"), and with this Section.

1. The work to be performed under this Contract is subject to the requirements of Section 3.
2. Contractor will require its subcontractors to comply with Section 3. As evidenced by its execution of this Contract, Contractor certifies that it is under no contractual or other impediment that would prevent it from complying with Section 3.
3. Contractor will include this Section 3 clause in every subcontract and will take all necessary steps to ensure compliance with Section 3 by its subcontractors. Upon a finding that a subcontractor is in violation of Section 3, Contractor will take appropriate action, as provided in an applicable provision of the subcontract or in this Section 3 clause. Contractor will not subcontract with any subcontractor where the Contractor has notice or knowledge that the subcontractor has been found in violation of Section 3.
4. Contractor will provide certifications in form and substance required by Owner, at such times as Owner may request, certifying (i) Contractor's compliance with Section 3, and (ii) as to such facts and circumstances pertaining to Section 3 as Owner may require or request, including certification with respect to total number of labor hours worked under this Contract, labor hours worked by Section 3 Workers (as defined in Section 3), and labor hours worked by Targeted Section 3 Workers (as defined in Section 3).
5. Contractor's noncompliance with Section 3 may result in sanctions, termination of this Contract for default, and debarment or suspension from future HUD-assisted contracts.
6. Contractor agrees to perform any further acts and execute and deliver any further documents that may be reasonably necessary to carry out the provisions and intent of this Section or otherwise to ensure compliance with Section 3.

ATTACHMENT B - SCOPE OF WORK

SECTION 1 – GENERAL INFORMATION

1.01 BASIC SCOPE AND PROJECT CONDITIONS

- A. The Contractor will be required to furnish and install, through self-performance or the management of Subcontractors, the work as described in Section 2.
- B. There are three (3) installation types. Detailed information provided in Section 2.
 - 1. Tub and tub surround
 - 2. Walk-in shower
 - 3. Tub or walk in shower conversion to ADA accessible shower.
- C. Contractor shall remove all debris from the work site.
- D. When work order is needed, the vendor will be able to do a site visit of the unit(s) before submitting a quote for the work.
 - 1. This work will be done on an as-needed basis.
 - a. There will be a Site Maintenance Manager who requests and coordinates work.
 - 2. Every property is different so we can't guarantee the exact set up until work is needed.
 - a. There are no pictures currently. Pictures and/or site visits will be available for specific units as work is needed.
- E. Provide owner with a minimum of 72-hour advance notice for work occurring in occupied units. In occupied units, the shower is not to be out of service for more than 24 hours. If for some reason the shower cannot be returned to service within 24 hours, notify the Owner immediately.
 - 1. Timely communication with property maintenance or management is crucial part of the Contractor's responsibility's so that the Owner can assess the possible impact and communicate to the affected tenant.
- F. Hours of work will be scheduled Monday thru Friday, 8 AM – 5 PM, excluding SHA holidays.
 - 1. Exceptions can be considered on a case-by-case basis.
- G. Parking: All properties have free street parking.
- H. Additional work and site conditions:
 - 1. Work area: This will need to be on a case-by-case basis but typically some type of work area can be arranged with property maintenance.
 - 2. Water shut off: If the work requires the house main water supply to be turned off, property maintenance or management will communicate to resident and shut it off. If the work only requires the water to be shut off at the tub, contractor can shut it off.

1.02 PROJECT LOCATIONS

- A. Various locations throughout the City of Seattle. SHA anticipates a quantity of 10 showers in multiple locations in the first year. Locations as specified below are owned by SHA. Additional sites may be added as needed.
 - 1. NewHolly: 3815 S Othello St., Seattle
 - 2. Rainier Vista: 4570 Martin Luther King Jr Way S., Seattle

- B. SHA reserves the right to add or subtract properties / locations during the contract term if determined to be in the best interest of SHA. Notice of such action will be given to the contractor in writing thirty (30) days in advance.

1.03 BIDDING

- A. This Request for Bids will include and require the following:
1. Total bid price for the project to be listed on the Request for Bids form and the Bid Price Form.
 2. Unit prices for the different installation types to be listed on the Bid Price Form.
 3. Acknowledgement of addenda numbers issued.
 4. Completed information on Request for Bids form.
 5. Inclusion and completion of all documents listed on the Submission Checklist on the Request for Bids form.
 6. WA UBI number and active accounts with Employment Security Department and Department of Labor & Industries.
 7. No suspensions or debarments
 8. A commitment to provide a community participation plan.
 9. Assurances of Contractor experience.
 10. Capacity to adequately contract and perform the work.
- B. Responding to this Request for Bids, the Bidder acknowledges that for any contract signed as a result of this Request for Bids, the authority to proceed with the work is contingent upon availability of funding.

1.04 ESTIMATE

- A. This project cost is estimated between \$50,000 and \$60,000 per year, not to exceed \$150,000 for the entire contract.
1. All items listed on the Bid Price form are included in this estimate.
 2. The estimate is based on recent similar projects.
 3. Costs for unforeseen or additional repairs are included in this estimate.
 - a. Unforeseen or additional repairs: Not to Exceed \$1,000.00 total per Work Order.

1.05 SUBSTITUTIONS

- A. During the bidding period or prior to the date a Contract is signed, submit written requests to the Owner for substitutions.
1. Submit to email address on Request for Bids with attachments, covered by Substitution Request Form attached to this Section. Complete all blank lines indicated on the form.
 2. Submit ten calendar days, minimum, prior to scheduled bid date.
 3. Owner will reply to all substitution requests via addendum.
- B. After Contract date, the General Contractor and Owner may, at their option, consider certain other substitutions submitted in accordance with requirements of this section. However, unless a product has prior approval, a substitution request made after Contract date for a product may be denied even if that product is used as the basis of the bid and Contract.
- C. Indicate one or more of following reasons for request:
1. Substitution is required for compliance with final code interpretation requirements or insurance regulation.
 2. Specified product is unavailable through no fault of Contractor, subcontractor, or supplier.
 3. Subsequent information discloses specified product is unable to perform properly or fit designated space.

4. Manufacturer or fabricator refuses to certify or guarantee performance of specified product as required.
 5. Substitution saves substantial cost, time, or other considerations. (Show accurate cost data on proposed substitution in comparison with product or method specified.)
- D. In making request for substitution, Supplier represents that:
1. It has personally reviewed all procurement options for the product specified and it is either unavailable, or, not obtainable without causing delays to the project schedule.
 2. It has personally investigated proposed product, and, in its opinion, it is equal or superior in all respects to that specified.
 3. It will coordinate installation of accepted substitution and guarantees to complete it in all respects. It has outlined any changes required in accordance with form.
 4. It will provide the same guarantee for substitution as for specified product.
 5. It waives all claims for additional costs related to substitution which consequently become apparent.
 6. Cost data is complete and includes all related costs under its contract, but excludes:
 - a. Cost under separate contracts (show impact on attached form).
 - b. Design consultant's redesign, unless designated.
- E. Substitutions will not be considered if:
1. They are indicated or implied on shop drawings or other project data submittals without proper notice shown on attached form.
 2. Acceptance will require substantial revisions of contract documents.

1.06 CONTRACT TERMS

- A. Term: one year.
1. SHA reserves the right to extend the contract term for an additional 365 calendar days if determined to be in the best interest of SHA.
 - a. This 365 calendar days term extension can be exercised a maximum of two (2) times under this contract.
 - b. The contract expires at a maximum term of 3 years (if two optional extensions used) or when contract value reaches \$150,000, whichever comes first.
- B. Work Orders will be approved and issued by Owner to be performed for each project. Each limited scope Work Order shall be performed in accordance with SHA Terms and Conditions per Attachment A, Version 2. Services will be provided in connection with properties located within the City of Seattle.
- C. The estimated number of installations is being given only as the basis for the comparison of bids. SHA does not warrant, expressly or by implication that the actual amount of work will correspond therewith. SHA reserves the right to add or subtract installations during the contract term if determined to be in the best interest of SHA.
- D. Prevailing wages are updated annually.
1. If there have been significant increases in costs, unit pricing might be revisited if increased costs are substantiated.

1.07 CHANGES

- A. Due to the variety of project conditions, variances will be allowed by the contract with approval prior to start of work.

- B. The maximum total value of all changes to any Work Order shall Not to Exceed \$1,000.00.
- C. All Changes in the Work shall adhere to the provisions in the *Seattle Housing Authority – General Conditions of the Contract for Construction* Part 7.
- D. The value of any Work covered by a Change Order Proposal, or of any request for an equitable adjustment in the Contract Sum, shall be determined as set forth in the *Seattle Housing Authority – General Conditions of the Contract for Construction* Article 7.02.
- E. All Changes in the Contract Time shall adhere to the *Seattle Housing Authority – General Conditions of the Contract for Construction* Article 7.03.
- F. Upon approval of a Change Order Proposal Request, the Owner will issue a Change Order for signatures of the Owner and Contractor on an Owner generated form.

1.08 COMPLIANCE WITH REQUIREMENTS

- A. The Contractor awarded the Contract shall comply with federal, state, and local laws, statutes, and ordinances relative to the execution of the work.
- B. All required licensing must be in place at time of bid submittal.
 - 1. The Contractor is responsible for verifying with the Department of Labor and Industries whether this work requires a plumbing license.
- C. Prevailing Wage Rates: Contractor is required to pay the prevailing wages included in this solicitation.
 - 1. As this project is federally funded by HUD, wage rates are set by HUD. HUD wage rates override any local or state wage rates. You are responsible to pay at minimum the rates listed on the HUD rate sheet.
 - 2. Prevailing wages for this project are set by HUD based on the type of project and the bid due date. Prevailing wages will be reviewed annually on the contract execution anniversary date. If any HUD prevailing wages have increased, they will be incorporated into the contract through a Change Order.

1.09 CLOSEOUT

- A. Contractor's List of Incomplete Items: Prepare and submit a list of items to be completed and corrected (Contractor's punch list), indicating the value of each item on the list and reasons why the Work is incomplete.
- B. Procedures Prior to Substantial Completion: Complete the following prior to requesting inspection for determining date of Substantial Completion. List items below that are incomplete at time of request.
 - 1. Remove construction tools and similar elements.
 - 2. Complete final cleaning requirements, including touchup painting.
 - 3. Touch up and otherwise repair and restore marred exposed finishes to eliminate visual defects.
- C. Inspection: Submit a written request for inspection to determine Substantial Completion a minimum of 10 days prior to date the work will be completed and ready for final inspection and tests. On receipt of request, Project Manager will either proceed with inspection or notify Contractor of unfulfilled requirements. Project Manager will prepare the Certificate of Substantial Completion after inspection or will notify Contractor of items, either on Contractor's list or additional items that must be completed or corrected before certificate will be issued.

1. Reinspection: Request reinspection when the Work identified in previous inspections as incomplete is completed or corrected.
 2. Results of completed inspection will form the basis of requirements for final completion.
- D. Preliminary Final Completion Procedures: Before requesting final inspection for determining completion, complete the following:
1. Submit a final Application for Payment according to Seattle Housing Authority process.
 2. Certified List of Incomplete Items: Submit copy of Project Manager's Substantial Completion inspection list of items to be completed or corrected (punch list), endorsed and dated by Project Manager. List shall state that each item has been completed or otherwise resolved for acceptance.
 3. Certificate of Insurance: Submit evidence of final, continuing insurance coverage complying with insurance requirements.
- E. List of Incomplete Items (Punch List):
1. Organization of List: Include name and identification of each space and area affected by construction operations for incomplete items and items needing correction including, if necessary, areas disturbed by Contractor that are outside the limits of construction.
 2. Final payment and Release of Retainage will not be granted until all Punch List items are complete. Each punch list item, when completed by the Contractor, shall be initialed by the Contractor prior to resubmission to the Owner.
 3. Upon receipt of Punch List with all items initialed as complete, the Project Manager will perform a re-inspection.
- F. Submittal of Project Warranties: Submit written warranties on request of Project Manager for designated portions of the Work where commencement of warranties other than date of Substantial Completion is indicated, or when delay in submittal of warranties might limit Owner's rights under warranty.
- G. Final Acceptance
1. Prior to Final Acceptance final payment request with releases and supporting documentation will be completed. Include insurance certificates where required.
 2. Submit a statement, accounting for execution of Change Orders to the Contract Sum.
 3. Submit a copy of the final inspection list stating that each item has been completed or otherwise resolved for acceptance.
 4. Submit consent of surety to final payment.
 5. Submit a final settlement statement.
 6. Submit evidence of continuing insurance coverage complying with insurance requirements.
- H. Retainage Release
1. The retainage release process cannot begin until after all punch list items and project paperwork are complete and labor compliance documentation and approval are achieved.
 2. Once SHA issues Final Contract Acceptance, the Notice of Completion is also filed with L&I.
 3. Filing the Notice of Completion triggers the beginning of the retainage release process.
 4. Retainage must be held a minimum of 45 days and until all releases are received from the Department of Revenue, Department of Labor & Industries, and Employment Security Department.
 5. Because other agencies are involved an exact timeline of retainage release is impossible to know.

SECTION 2 – DETAILED SCOPE AND SPECS

2.01 PROJECT SCOPE

- A. The Contractor will be required to furnish and install, through self-performance or the management of Subcontractors one or more of, but not limited to the following elements of work:
1. Demo, as needed.
 2. Main installation types:
 - a. Installation of a custom sized acrylic one-piece shower pan over the existing shower pan.
 - b. Installation of a custom formed one-piece acrylic shower wall system over the existing shower walls.
 - 1) New tempered glass shower doors
 - c. Installation of a custom sized acrylic one-piece Tub and or tub surround over the existing tub / surround; or install new tub.
 3. Installation of accessories:
 - a. Stainless steel grab bars:
 - 1) A minimum of one grab bar to be installed in each unit, but more could be needed on a case-by-case basis.
 - b. Soap dish: To tie-in to existing floor drain and caulking.
 - c. Shower valves: Typically, shower valves will not need to be replaced.
 - 1) If this is required, then SHA will review a submittal for the extra work of installation by the contractor. If approved, a Change Order will be issued to cover the additional cost of work.
 4. Conversions:
 - a. Conversion from tub to shower.
 - b. Conversion of existing tub/shower to an ADA roll-in shower.
 5. Repairs as needed but not limited to:
 - a. Wall repair for rot/mold in walls/flooring.
 6. Finishing as needed but not limited to:
 - a. Exposed edges capped with extruded molding,
- B. Contractor shall remove all debris from the work site.
- C. There is not a specific brand required. We have provided some standard brands in the Scope of Work as a basis for pricing. Substitution requests can be submitted for SHA's review on equal to or better than original product to be installed.

2.01 TUB AND TUB SURROUND

- A. Estimated number of installations: Five (5)
- B. Tubs standard size is 60" long and 30" to 31" wide and 74" tall.
1. Some of the properties are built on slab floors, these concrete floors cannot have flat floor showers, due to the grade of the drain. The feasibility within a unit to convert a tub to shower will be made by SHA prior to requesting the work.
- C. Scope of Work:
1. Removal of tub surround.
 - a. Follow the product's requirements for preparing the walls when there is an installation over the existing tub/shower walls.
 2. Install new tub surround, acrylic or fiberglass.
 3. Reinforced sides and backs for grab bars.
 - a. Install Grab bar on back wall, if applicable.

4. Soap dishes should be included in installations unless it is not possible or feasible.
5. Repair drywall with texture and paint to match.
6. Proper disposal of items off site

D. Fixtures:

1. Single-lever Delta or Moen Faucet or approved equal product.
2. Body material: solid brass.
3. Finish: Polished chrome-plate.

2.02 WALK IN SHOWER

A. Estimated number of installations: Three (3)

B. Walk-in showers standard size is 36" long by 36" wide.

1. Some of the properties are built on slab floors, these concrete floors cannot have flat floor showers, due to the grade of the drain. The feasibility within a unit to convert a tub to shower will be made by SHA prior to requesting the work.

C. Scope of Work:

1. Removal of walk in shower pan, surround, and shower glass.
 - a. Follow the product's requirements for preparing the walls when there is an installation over the existing shower walls.
2. Install new acrylic or fiberglass shower pan and glue on shower wall system.
3. Non-skid textured bottom surfaces, reinforced with wood to meet a 300# load test.
4. Reinforced sides and backs for grab bars.
 - a. Install Grab bars on back wall, if applicable.
5. Install new classic sliding shower glass door system:
 - a. Semi-frameless, 3/8 clear glass.
6. Soap dishes should be included in installations unless it is not possible or feasible.
7. Repair drywall with texture and paint to match.
8. Proper disposal of items off site

D. Fixtures:

1. Single-lever Delta or Moen Faucet or approved equal product.
2. Body material: solid brass.
3. Finish: Polished chrome-plate.

2.03 TUB OR WALK IN SHOWER CONVERSION TO ADA ACCESSIBLE SHOWER

A. Estimated number of installations: Two (2)

B. ADA Accessible showers may vary but must meet accessibility requirements per 2010 ADA Section 608, 2009 ICC A117.1 Section 608 and PHA Chapter 7.

1. ADA Section 608 Shower Compartments attached for reference on measurements.
2. For additional information, visit [2010 ADA Standards for Accessible Design website](#).
3. All measurements will be confirmed when a work order is requested.

C. Scope of Work:

1. Removal of tub or walk in shower pan, surround, and shower glass.
 - a. Follow the product's requirements for preparing the walls when there is an installation over the existing tub/shower walls.
2. Install roll-in shower with an entry of 36" minimum shall be provided, no door allowed.
3. Reinforced sides and backs for handrails and seats.

4. Shower to be flush with adjacent wall to provide clear floor space.
 - a. 180-degree flange not allowed.
 5. Per 2010 ADA Section 608, 2009 ICC A117.1 Section 608 and PHA Chapter 7.
 6. Soap dishes should be included in installations unless it is not possible or feasible.
 7. Proper disposal of items off site
- E. Fixtures:
1. Single-lever Delta or Moen Faucet or approved equal product.
 2. Body material: solid brass.
 3. Finish: Polished chrome-plate.
- F. ADA Regulatory Requirements: Comply with requirements in ICC A117.1, "Accessible and Usable Buildings and Facilities" for plumbing fixtures for people with disabilities.

END OF ATTACHMENT B - SCOPE OF WORK



Advisory 607.6 Shower Spray Unit and Water.

Ensure that hand-held shower spray units are capable of delivering water pressure substantially equivalent to fixed shower heads.

607.7 Bathtub Enclosures. Enclosures for bathtubs shall not obstruct controls, faucets, shower and spray units or obstruct transfer from wheelchairs onto bathtub seats or into bathtubs. Enclosures on bathtubs shall not have tracks installed on the rim of the open face of the bathtub.

608 Shower Compartments



608.1 General. Shower compartments shall comply with 608.



Advisory 608.1 General.

Shower stalls that are 60 inches (1525 mm) wide and have no curb may increase the usability of a bathroom because the shower area provides additional maneuvering space.

608.2 Size and Clearances for Shower Compartments. Shower compartments shall have sizes and clearances complying with 608.2.

608.2.1 Transfer Type Shower Compartments. Transfer type shower compartments shall be 36 inches (915 mm) by 36 inches (915 mm) clear inside dimensions measured at the center points of opposing sides and shall have a 36 inch (915 mm) wide minimum entry on the face of the shower compartment. Clearance of 36 inches (915 mm) wide minimum by 48 inches (1220 mm) long minimum measured from the control wall shall be provided.

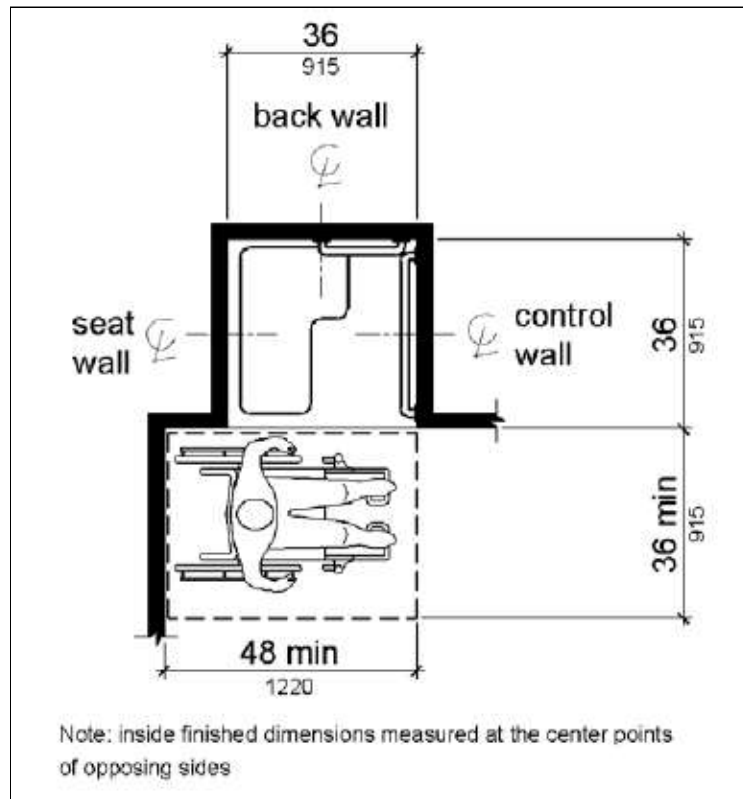
Figure 608.2.1

Transfer Type Shower Compartment Size and Clearance

608.2.2 Standard Roll-In Type Shower Compartments. Standard roll-in type shower compartments shall be 30 inches (760 mm) wide minimum by 60 inches (1525 mm) deep minimum clear inside dimensions measured at center points of opposing sides and shall have a 60 inches (1525 mm) wide minimum entry on the face of the shower compartment.

608.2.2.1 Clearance. A 30 inch (760 mm) wide minimum by 60 inch (1525 mm) long minimum clearance shall be provided adjacent to the open face of the shower compartment.

EXCEPTION: A lavatory complying with 606 shall be permitted on one 30 inch (760 mm) wide minimum side of the clearance provided that it is not on the side of the clearance adjacent to the controls or, where provided, not on the side of the clearance adjacent to the shower seat.

Figure 608.2.2

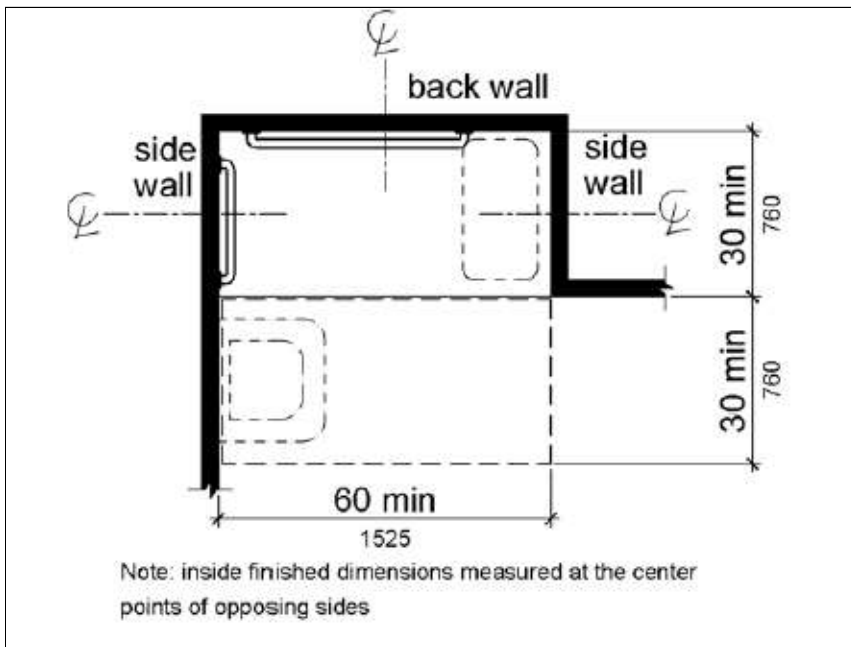

Standard Roll-In Type Shower Compartment Size and Clearance

608.2.3 Alternate Roll-In Type Shower Compartments. Alternate roll-in type shower compartments shall be 36 inches (915 mm) wide and 60 inches (1525 mm) deep minimum clear inside dimensions measured at center points of opposing sides. A 36 inch (915 mm) wide minimum entry shall be provided at one end of the long side of the compartment.

Figure 608.2.3

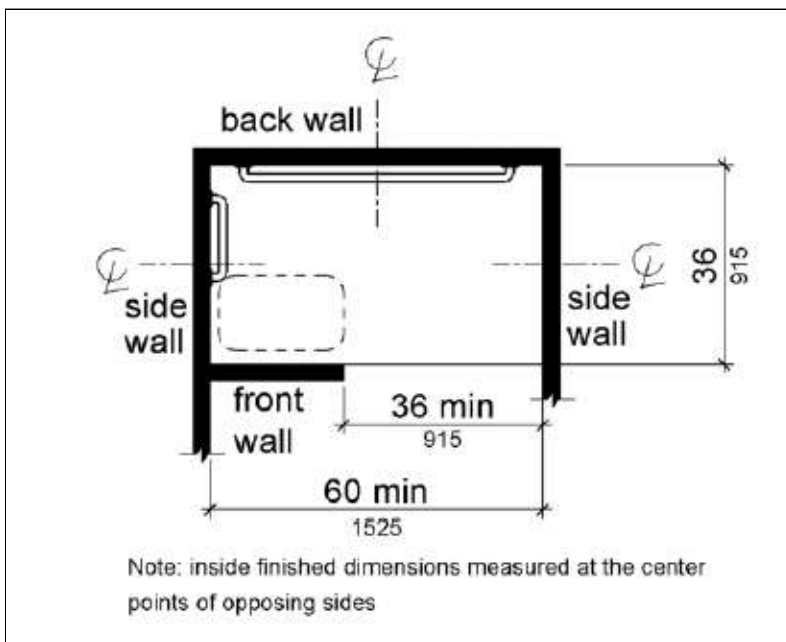

Alternate Roll-In Type Shower Compartment Size and Clearance

608.3 Grab Bars. Grab bars shall comply with 609 and shall be provided in accordance with 608.3. Where multiple grab bars are used, required horizontal grab bars shall be installed at the same height above the finish floor.

EXCEPTIONS:

1. Grab bars shall not be required to be installed in a shower located in a bathing facility for a single occupant accessed only through a private office, and not for common use or public use provided that reinforcement has been installed in walls and located so as to permit the installation of grab bars complying with 608.3.
2. In residential dwelling units, grab bars shall not be required to be installed in showers located in bathing facilities provided that reinforcement has been installed in walls and located so as to permit the installation of grab bars complying with 608.3.

608.3.1 Transfer Type Shower Compartments. In transfer type compartments, grab bars shall be provided across the control wall and back wall to a point 18 inches (455 mm) from the control wall.

Figure 608.3.1

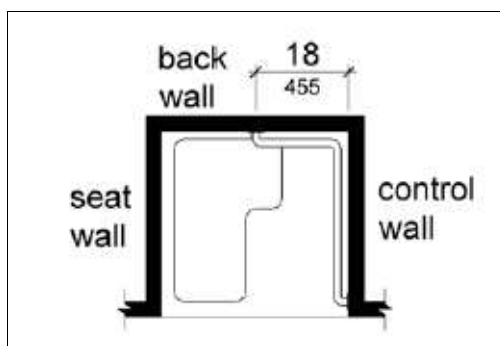

Grab Bars for Transfer Type Showers

608.3.2 Standard Roll-In Type Shower Compartments. Where a seat is provided in standard roll-in type shower compartments, grab bars shall be provided on the back wall and the side wall opposite the seat. Grab bars shall not be provided above the seat. Where a seat is not provided in standard roll-in type shower compartments,

grab bars shall be provided on three walls. Grab bars shall be installed 6 inches (150 mm) maximum from adjacent walls.

Figure 608.3.2

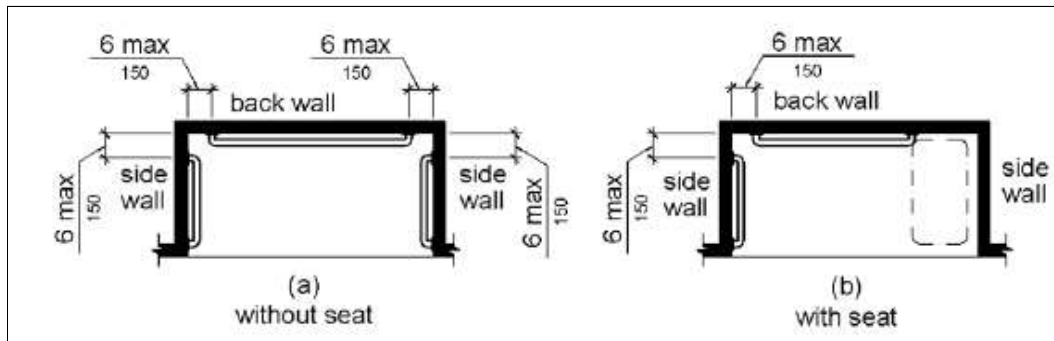

Grab Bars for Standard Roll-In Type Showers

608.3.3 Alternate Roll-In Type Shower Compartments. In alternate roll-in type shower compartments, grab bars shall be provided on the back wall and the side wall farthest from the compartment entry. Grab bars shall not be provided above the seat. Grab bars shall be installed 6 inches (150 mm) maximum from adjacent walls.

Figure 608.3.3

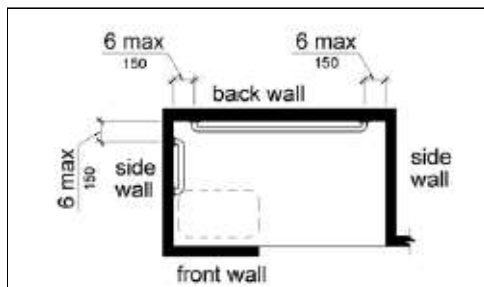

Grab Bars for Alternate Roll-In Type Showers

608.4 Seats. A folding or non-folding seat shall be provided in transfer type shower compartments. A folding seat shall be provided in roll-in type showers required in transient lodging guest rooms with mobility features complying with 806.2. Seats shall comply with 610.

EXCEPTION: In residential dwelling units, seats shall not be required in transfer type shower compartments provided that reinforcement has been installed in walls so as to permit the installation of seats complying with 608.4.

608.5 Controls. Controls, faucets, and shower spray units shall comply with 309.4.

608.5.1 Transfer Type Shower Compartments. In transfer type shower compartments, the controls, faucets, and shower spray unit shall be installed on the side wall opposite the seat 38 inches (965 mm) minimum and 48 inches (1220 mm) maximum above the shower floor and shall be located on the control wall 15 inches (380 mm) maximum from the centerline of the seat toward the shower opening.

Figure 608.5.1

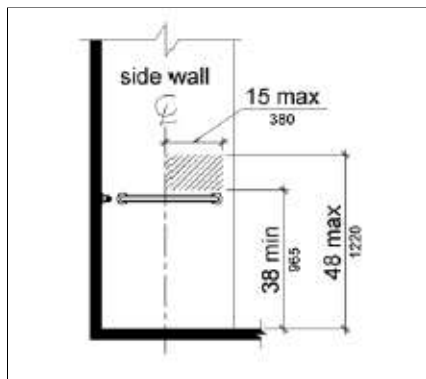

Transfer Type Shower Compartment Control Location

608.5.2 Standard Roll-In Type Shower Compartments. In standard roll-in type shower compartments, the controls, faucets, and shower spray unit shall be located above the grab bar, but no higher than 48 inches (1220 mm) above the shower floor. Where a seat is provided, the controls, faucets, and shower spray unit shall be installed on the back wall adjacent to the seat wall and shall be located 27 inches (685 mm) maximum from the seat wall.



Advisory 608.5.2 Standard Roll-in Type Shower Compartments.

In standard roll-in type showers without seats, the shower head and operable parts can be located on any of the three walls of the shower without adversely affecting accessibility.

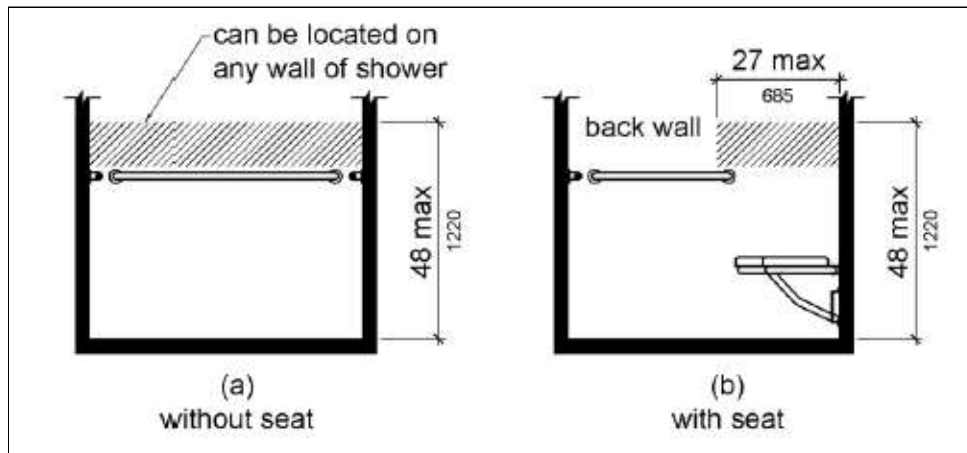
Figure 608.5.2**Standard Roll-In Type Shower Compartment Control Location**

608.5.3 Alternate Roll-In Type Shower Compartments. In alternate roll-in type shower compartments, the controls, faucets, and shower spray unit shall be located above the grab bar, but no higher than 48 inches (1220 mm) above the shower floor. Where a seat is provided, the controls, faucets, and shower spray unit shall be located on the side wall adjacent to the seat 27 inches (685 mm) maximum from the side wall behind the seat or shall be located on the back wall opposite the seat 15 inches (380 mm) maximum, left or right, of the centerline of the seat. Where a seat is not provided, the controls, faucets, and shower spray unit shall be installed on the side wall farthest from the compartment entry.

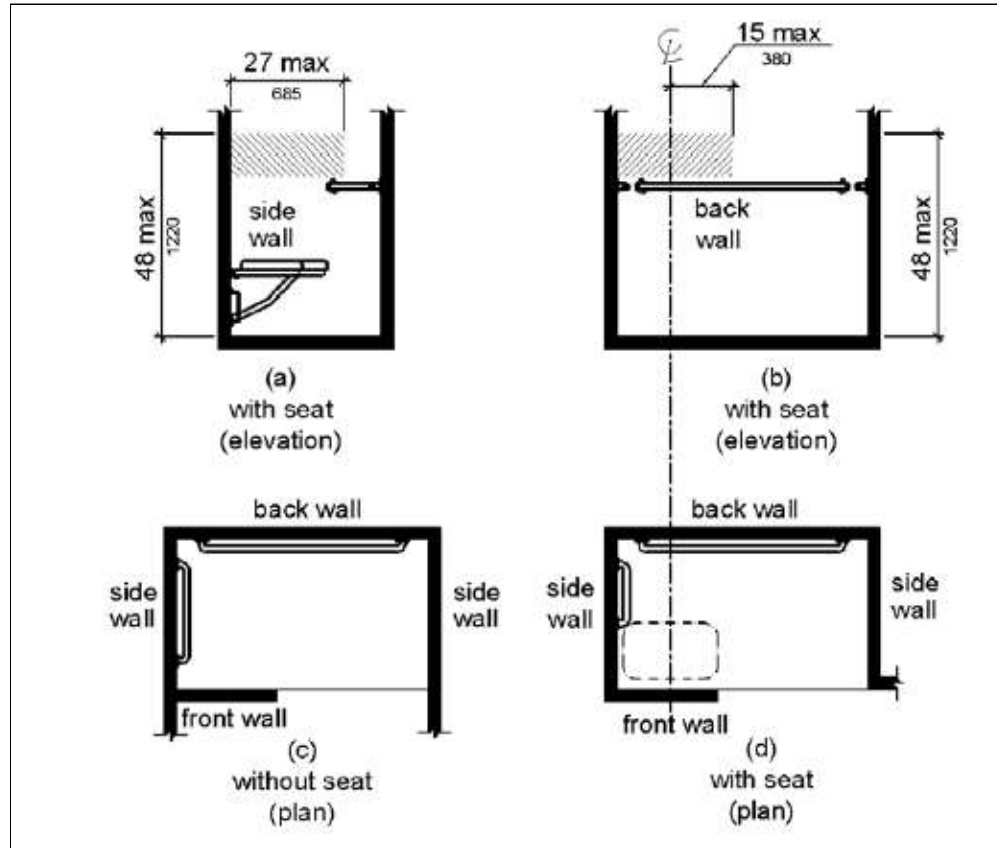
Figure 608.5.3

Alternate Roll-In Type Shower Compartment Control Location

608.6 Shower Spray Unit and Water. A shower spray unit with a hose 59 inches (1500 mm) long minimum that can be used both as a fixed-position shower head and as a hand-held shower shall be provided. The shower spray unit shall have an on/off control with a non-positive shut-off. If an adjustable-height shower head on a vertical bar is used, the bar shall be installed so as not to obstruct the use of grab bars. Shower spray units shall deliver water that is 120°F (49°C) maximum.

EXCEPTION: A fixed shower head located at 48 inches (1220 mm) maximum above the shower finish floor shall be permitted instead of a hand-held spray unit in facilities that are not medical care facilities, long-term care facilities, transient lodging guest rooms, or residential dwelling units.

Advisory 608.6 Shower Spray Unit and Water.

Ensure that hand-held shower spray units are capable of delivering water pressure substantially equivalent to fixed shower heads.

608.7 Thresholds. Thresholds in roll-in type shower compartments shall be 1/2 inch (13 mm) high maximum in accordance with 303. In transfer type shower compartments, thresholds 1/2 inch (13 mm) high maximum shall be beveled, rounded, or vertical.

EXCEPTION: A threshold 2 inches (51 mm) high maximum shall be permitted in transfer type shower compartments in existing facilities where provision of a 1/2 inch (13 mm) high threshold would disturb the structural reinforcement of the floor slab.

608.8 Shower Enclosures. Enclosures for shower compartments shall not obstruct controls, faucets, and shower spray units or obstruct transfer from wheelchairs onto shower seats.

609 Grab Bars



609.1 General. Grab bars in toilet facilities and bathing facilities shall comply with 609.

609.2 Cross Section. Grab bars shall have a cross section complying with 609.2.1 or 609.2.2.

609.2.1 Circular Cross Section. Grab bars with circular cross sections shall have an outside diameter of 1 1/4 inches (32 mm) minimum and 2 inches (51 mm) maximum.

609.2.2 Non-Circular Cross Section. Grab bars with non-circular cross sections shall have a cross-section dimension of 2 inches (51 mm) maximum and a perimeter dimension of 4 inches (100 mm) minimum and 4.8 inches (120 mm) maximum.



SUBSTITUTION REQUEST FORM

REQUEST NO. _____ (assigned by SHA)

A completed copy of this form must be submitted to the Owner for a substitution to be considered. If the substitution is given initial approval, the Contractor shall submit a completed copy of the form titled "Certification of Equal Performance and Assumption of Liability for Equal Performance," in order for the substitution to be considered fully approved.

Project: 5858 Various Hope VI Shower Upgrades - LP Non-Federal Funding

Site Name: _____

Site Address: _____

Dated: _____

In order to give proper consideration to all request for approval, the following information shall be supplied and all questions answered:

1. Nature of request: _____

2. Will the substitution affect the project schedule, and if so, state number of days added or deleted:

3. Does the change affect standard dimensions in any way?: _____
If yes, please clearly indicate changes on the submittal(s)

4. Does the change meet all applicable code or ordinance requirements? _____

5. Is there a cost or maintenance benefit to the Owner? _____

a. If cost benefit, how much? _____

b. If maintenance benefit, explain how: _____

9. Submit with request all necessary samples and substantiating data; Including shop drawings, catalog cuts, performance and test data; to prove conformance to the contract documents, equal quality and performance to that which is specified. Clearly mark manufacturer's literature to indicate quality in performance.

10. Will the undersigned pay for any engineering or detailing cost caused by the requested change? _____

Firm: _____

Address: _____

Phone: _____ Date: _____

Name of Proposer: _____

Title: _____

Signature: _____

END OF REQUEST FOR SUBSTITUTION

**CERTIFICATION OF EQUAL PERFORMANCE AND
ASSUMPTION OF LIABILITY FOR EQUAL PERFORMANCE**

Project: 5858 Various Hope VI Shower Upgrades - LP Non-Federal Funding

Site Name: _____

Site Address: _____

Description of Substitution: _____

The undersigned has thoroughly studied the contract documents for the above project and guarantees by this signature that the requested material equipment or system substitution or change in construction procedure or technique will in addition to conforming to any and all applicable code requirements, perform equal to or better than that material, or combination of materials, presently detailed and specified.

Accepted by Owner

By: _____

Date: _____

END OF CERTIFICATION



HOUSING AUTHORITY OF THE CITY OF SEATTLE
GENERAL CONDITIONS OF THE CONTRACT FOR CONSTRUCTION
December 5, 2022

Table of Contents

PART 1 - GENERAL PROVISIONS	1
1.01 DEFINITIONS.....	1
1.02 ORDER OF PRECEDENCE.....	4
1.03 EXECUTION AND INTENT.....	4
PART 2 - INSURANCE AND BONDS	5
2.01 CONTRACTOR'S LIABILITY INSURANCE.....	5
2.02 COVERAGE LIMITS.....	8
2.03 INSURANCE COVERAGE ENDORSEMENTS AND CERTIFICATES.....	8
2.04 INSURANCE NON-COMPLIANCE.....	9
2.05 PAYMENT AND PERFORMANCE BONDS.....	10
2.06 ADDITIONAL BOND SECURITY.....	10
2.07 BUILDERS RISK INSURANCE (when applicable).....	10
2.08 CRIMINAL BACKGROUND CHECKS.....	11
PART 3 - TIME AND SCHEDULE	11
3.01 PROGRESS AND COMPLETION.....	11
3.02 PROJECT SCHEDULE.....	11
3.03 OWNER'S RIGHT TO SUSPEND THE WORK FOR CONVENIENCE.....	13
3.04 OWNER'S RIGHT TO STOP THE WORK FOR CAUSE.....	13
3.05 DELAY.....	13
3.06 NOTICE TO OWNER OF LABOR DISPUTES.....	14
3.07 DAMAGES FOR FAILURE TO ACHIEVE TIMELY COMPLETION.....	14
PART 4 - SPECIFICATIONS, DRAWINGS, DETAILS AND OTHER DOCUMENTS	15
4.01 DISCREPANCIES AND DUTY TO REVIEW CONTRACT DOCUMENTS.....	15
4.02 PROJECT RECORD.....	16
4.03 SHOP DRAWINGS.....	16
4.04 ORGANIZATION OF SPECIFICATIONS.....	17
4.05 OWNERSHIP AND USE OF DRAWINGS, SPECIFICATIONS, AND OTHER DOCUMENTS.....	18
PART 5 - PERFORMANCE	18
5.01 CONTRACTOR CONTROL AND SUPERVISION.....	18
5.02 PERMITS, FEES, AND NOTICES.....	19
5.03 PATENTS AND ROYALTIES.....	20
5.04 PREVAILING WAGES. <i>[ONLY APPLICABLE TO STATE- OR CITY-FUNDED PROJECTS. see section 11.12 for federally-funded projects].</i>	20
5.05 HOURS OF LABOR. <i>[ONLY APPLICABLE TO STATE- OR CITY-FUNDED PROJECTS. see section 11.12 for federally-funded projects].</i>	20

5.06	NONDISCRIMINATION	21
5.07	SAFETY PRECAUTIONS	22
5.08	OPERATIONS, MATERIAL HANDLING, AND STORAGE AREAS.....	24
5.09	PRIOR NOTICE OF EXCAVATION.....	24
5.10	UNFORESEEN PHYSICAL CONDITIONS.....	25
5.11	PROTECTION OF EXISTING STRUCTURES, EQUIPMENT, VEGETATION, UTILITIES, AND IMPROVEMENTS.....	25
5.12	LAYOUT OF WORK	26
5.13	MATERIAL AND EQUIPMENT	26
5.14	AVAILABILITY AND USE OF UTILITY SERVICES	26
5.15	TESTS AND INSPECTIONS	27
5.16	CORRECTION OF NONCONFORMING WORK.....	28
5.17	SITE ORGANIZATION AND CLEAN UP	29
5.18	ACCESS TO WORK AND OCCUPIED RESIDENTIAL UNITS.	29
5.19	OTHER CONTRACTS.....	29
5.20	SUBCONTRACTORS AND SUPPLIERS.....	30
5.21	WARRANTY OF CONSTRUCTION	30
5.22	INDEMNIFICATION.....	31
5.23	PROHIBITION AGAINST LIENS	31
5.24	OWNER'S REPRESENTATIVE.....	32
5.25	CONFLICTS	32
5.26	APPROVAL OF OWNER'S REPRESENTATIVES.....	32
5.27	ORAL AGREEMENTS.....	32
	PART 6 - PAYMENTS AND COMPLETION	33
6.01	CONTRACT SUM.....	33
6.02	SCHEDULE OF VALUES	33
6.03	APPLICATION FOR PAYMENT	33
6.04	PROGRESS PAYMENTS.....	34
6.05	PAYMENTS WITHHELD	34
6.06	RETAINAGE AND BOND CLAIM RIGHTS.....	35
6.07	SUBSTANTIAL COMPLETION.....	35
6.08	PRIOR OCCUPANCY	35
6.09	FINAL COMPLETION, ACCEPTANCE, AND PAYMENT.....	36
	PART 7 - CHANGES.....	36
7.01	CHANGES IN THE WORK	36
7.02	CHANGES IN THE CONTRACT SUM.....	37
7.03	CHANGES IN THE CONTRACT TIME	43

PART 8 - CLAIMS AND DISPUTE RESOLUTION	45
8.01 CLAIMS PROCEDURE.....	45
8.02 DISPUTE RESOLUTION.....	46
8.03 ARBITRATION.....	46
8.04 LITIGATION.....	47
8.05 CLAIMS AUDITS	47
PART 9 - TERMINATION OF THE WORK	48
9.01 TERMINATION BY OWNER FOR CAUSE.....	48
9.02 TERMINATION BY OWNER FOR CONVENIENCE.....	50
PART 10 - MISCELLANEOUS PROVISIONS	50
10.01 GOVERNING LAW	50
10.02 SUCCESSORS AND ASSIGNS	50
10.03 MEANING OF WORDS	50
10.04 RIGHTS AND REMEDIES.....	51
10.05 CONTRACTOR REGISTRATION.....	51
10.06 TIME COMPUTATIONS	51
10.07 RECORDS RETENTION	51
10.08 THIRD-PARTY AGREEMENTS.....	51
10.09 ANTITRUST ASSIGNMENT.....	51
10.10 NOTICES.....	51
10.11 LABOR AND INDUSTRIES REQUIRED DOCUMENTS FOR HUD FUNDED PROJECTS:.....	53
PART 11 - FEDERAL PROVISIONS.....	53
11.01 PROHIBITION AGAINST USE OF LEAD-BASED PAINT	53
11.02 FEDERAL HEALTH, SAFETY, AND ACCIDENT PREVENTION	53
11.03 CLEAN AIR AND WATER APPLICABLE TO CONTRACTS IN EXCESS OF \$150,000.....	53
11.04 ENERGY EFFICIENCY	54
11.05 SUBCONTRACTING WITH SMALL AND MINORITY FIRMS, WOMEN'S BUSINESS ENTERPRISE, AND LABOR SURPLUS AREA FIRMS	54
11.06 EQUAL EMPLOYMENT OPPORTUNITY	54
11.07 EMPLOYMENT, TRAINING, AND CONTRACTING OPPORTUNITIES FOR LOW-INCOME PERSONS, SECTION 3 OF THE HOUSING AND URBAN DEVELOPMENT ACT OF 1968	55
11.08 INTEREST OF MEMBERS OF CONGRESS.....	55
11.09 INTEREST OF MEMBERS, OFFICERS, OR EMPLOYEES AND FORMER MEMBERS, OFFICERS, OR EMPLOYEES.....	56
11.10 LIMITATIONS ON PAYMENTS MADE TO INFLUENCE CERTAIN FEDERAL FINANCIAL TRANSACTIONS.....	56
11.11 EXAMINATION AND RETENTION OF CONTRACTOR'S RECORDS.....	56
11.12 LABOR STANDARDS - DAVIS-BACON AND RELATED ACTS.....	57

11.13	LABOR STANDARDS – HUD-DETERMINED NON-ROUTINE MAINTENANCE.....	63
11.14	NON-FEDERAL PREVAILING WAGE RATES.....	65
11.15	PROCUREMENT OF RECOVERED MATERIALS.....	66
	PART 12 - SOCIAL EQUITY REQUIREMENTS.....	66
12.01	EMPLOYMENT AND TRAINING GOALS AND REQUIREMENTS.....	66
12.02	WOMEN AND MINORITY BUSINESS AND HUD SECTION 3 BUSINESS UTILIZATION GOALS AND REQUIREMENTS.....	68
12.03	REPORTING REQUIREMENTS.....	69
12.04	VIOLATIONS	70

|

PART 1 - GENERAL PROVISIONS

1.01 DEFINITIONS

- A. "Advertisement for Bids" A public notice published in the official newspaper, designated by the Owner, and/or on the internet, soliciting bids for the Work.
- B. "Addendum" or "Addenda" means alteration or clarification of the plans or specifications provided to bidders or proposers by the Owner prior to bid or proposal time, which becomes part of the Contract Documents when the Contract is executed.
- C. "Application for Payment" means a written request submitted by Contractor to Owner for payment of Work completed in accordance with the Contract Documents and approved Schedule of Values, supported by substantiating data as Owner.
- D. "Architect," "Engineer," or "A/E" means a person or entity lawfully entitled to practice architecture or engineering, representing the Owner within the limits of its delegated authority.
- E. "Bid Documents" means the component parts of the proposed Contract which may include the Advertisement for Bids, Bid Form, Agreement Form, Project Manual, Drawings, Addenda and any other documents incorporated into the Contract by reference.
- F. "Change Order" means a written instrument signed by Owner and Contractor stating their agreement upon all of the following: (1) a change in the Work; (2) the amount of the adjustment in the Contract Sum, if any, and (3) the extent of the adjustment in the Contract Time, if any.
- G. "Claim" means Contractor's exclusive remedy for resolving disputes with Owner arising from the Contract documents (including disputes regarding the terms of a Change Order or a request for equitable adjustment), as more fully set forth in part 8.
- H. "Contract" The written agreement between the Owner and the Contractor, which includes the signed Agreement Form, Bid Form, Contract provisions, Drawings, Addenda, certifications, supplemental agreements, Change Orders and all other documents specifically incorporated by reference comprise the Contract
- I. "Contract Documents" means the Advertisement for Bids or Proposals, Instructions for Bidders or Proposers, completed Bid or Proposal Form, General Conditions, Supplemental Conditions, Public Works Contract, Addenda, other Special Forms, Drawings and Specifications, (and, for federally-funded projects, the applicable wage rate determinations from either the U.S. Department of Labor or Housing and Urban Development), and all addenda and modifications thereof.
- J. "Contract Sum" is the total amount payable by Owner to Contractor for performance of the Work in accordance with the Contract Documents.
- K. "Contract Time" is the number of Days allotted in the Contract Documents for achieving Substantial Completion of the Work.
- L. "Contractor" means the person or entity who has agreed via contract with Owner to perform the Work in accordance with the Contract Documents.
- M. "Critical Path" means the longest, continuous sequence of interrelated activities of the Work that begins at the start of the Project (Notice to Proceed) and

extends through Substantial Completion of the Project. These activities are critical because delay to an activity on this path will extend Contract Time.

- N. "Day" means calendar day, unless otherwise specified.
- O. "Drawings" are the graphic and pictorial portions of the Contract Documents showing the design, location, and dimensions of the Work, and may include plans, elevations, sections, details, schedules, and diagrams.
- P. "Field Directive" is a document titled Field Directive, prepared by the Owner directing the Contractor to proceed diligently with specific work and shall not, in and of itself, constitute a Change Order or entitlement to an adjustment in Contract Time and/or Contract Price.
- Q. "Final Acceptance" means the written acceptance issued to Contractor by Owner after Contractor has completed the requirements of the Contract Documents.
- R. "Final Completion" means the written completion issued to Contractor that the Work is fully and finally completed in accordance with the Contract Documents.
- S. "Force Majeure" means those acts entitling Contractor to request an equitable adjustment in the Contract Time, as more fully set forth in paragraph 3.05A.
- T. "Minority-owned Business Enterprise (MBE)" means a self-identified business or a business certified by the State of Washington to be at least fifty-one percent owned by a minority (including, but not limited to, African Americans, Native Americans, Asians, Hispanics, and Hasidic Jews) group members
- U. "Minority-owned Women Business Enterprise (MWBE)" means a self-identified business or a business certified by the State of Washington to be at least fifty-one percent owned by a minority woman.
- V. "Notice" means a written notice which has been delivered in person to the individual or a member of the firm or entity or to an officer of the corporation for which it was intended or, if delivered or sent by registered or certified mail, to the last business address known to the party giving notice.
- W. "Notice to Proceed," means a notice from Owner to Contractor that defines the date on which the Contract Time begins to run.
- X. "Overhead" means charges that may be incurred or allocated in support of the Contract but are not part of the cost of directly performing the Work. Overhead includes Site or Field Overhead and Home Office Overhead.
- Y. "Owner" means the Housing Authority of the City of Seattle. For purposes of sections 5.03 and 5.22, "Owner" also includes all commissioners, officers, agents and employees of the Housing Authority of the City of Seattle.
- Z. "Performance and Payment Bonds" means the approved form of security furnished by the Contractor and the Contractor's Surety or Sureties guaranteeing completion of the Work required by the Contractor Construction Contract and these General Conditions and payment to persons supplying labor and materials in the prosecution of the Work, in accordance with the terms and conditions of the Contract Documents.
- AA. "Person" means a corporation, partnership, or business association of any kind, trust, company, or individual.
- BB. "Prior Occupancy" means Owner's use of all or parts of the Project before Substantial Completion.

- CC. "Progress Schedule" means a schedule of the Work, in a form satisfactory to Owner, as further set forth in section 3.02.
- DD. "Project" means the total construction of which the Work is performed in accordance with the Contract Documents may be the whole or a part and which may include supplemental construction by Owner or by separate contractors.
- EE. "Project Manual" means the volume assembled for the Work, which may include the bidding requirements, sample forms, specifications, General Conditions, Supplemental Conditions and other Contract Documents.
- FF. "Project Record" means the separate set of Drawings and Specifications as further set forth in paragraph 4.02A.
- GG. "Request for Competitive Proposal" A formally advertised and competitive selection process used for obtaining construction services that will cost more than \$250,000, in which the evaluation and selection of a Contractor cannot be based on price alone, but is based on established criteria that include price and other factors.
- HH. "Request for Information" means a written submission from the Contractor seeking additional information regarding the prosecution of the Work and/or the Contract Documents governing the Work.
- II. "Schedule of Values" means a written breakdown allocating the total Contract Sum to each principle category of Work, in such detail as requested by Owner.
- JJ. "Section 3" means Section 3 of the Housing and Urban Development Act of 1968, 12 U.S.C. 1701u, and its implementing regulations set forth at 24 CFR 75 (as each of the same has been or may be amended, modified, or replaced from time to time, and including any successor statutes or regulations).
- KK. "Specifications" are the portion of the Contract Documents consisting of the written requirements for materials, equipment, construction systems, standards and workmanship for the Work, and performance of related services.
- LL. "Subcontract" means a contract entered into by a Subcontractor for the purpose of obtaining supplies, materials, equipment, or services of any kind for or in connection with the Work.
- MM. "Subcontractor" means any person, other than Contractor, who agrees to furnish or furnishes any supplies, materials, equipment, or services of any kind in connection with the Work.
- NN. "Substantial Completion" means that stage in the progress of the Work where Owner has full and unrestricted use and benefit of the facilities for the purposes intended, as more fully set forth in section 6.07.
- OO. "Unusually Severe Weather" shall be defined, documented and calculated as follows:
1. Daily rainfall equal to, or greater than, .05 inch during a month when the monthly rainfall exceeds the normal monthly average by 15 to 100 percent.
 2. Daily rainfall equal to, or greater than, 2.0 inch during a month when the monthly rainfall exceeds the normal monthly average by more than 100 percent.
 3. Daily rainfall equal to, or greater than, 1.0 inch at any time.
 4. Daily maximum temperature equal to or less than, 20 degrees F during a week when the maximum daily temperature never exceeds 35 degrees F.

PP. "Work" means the construction and services required by the Contract Documents, and includes, but is not limited to, labor, materials, supplies, equipment, services, permits, and the manufacture and fabrication of components, performed, furnished, or provided in accordance with the Contract Documents.

QQ. "Authorities Having Jurisdiction" means all federal, state and local government agencies having jurisdiction or approval authority over any aspect of the Work.

RR. **ONLY APPLICABLE TO FEDERALLY-FUNDED PROJECTS.]:** "HUD" means the United States of America acting through the Department of Housing and Urban Development including the Secretary, or any other person designated to act on its behalf. HUD has agreed, subject to the provisions of an Annual Contributions Contract (ACC), to provide financial assistance to Owner, which includes assistance in financing the work to be performed under this contract. Notwithstanding HUD's role, nothing in this contract shall be construed to create any contractual relationship between the Contractor and HUD.]

1.02 ORDER OF PRECEDENCE

Any conflict or inconsistency in the Contract Documents shall be resolved by giving the documents precedence in the following order:

- A. Signed Public Works Contract, including any Change Orders and Addenda.
- B. Supplemental Conditions.
- C. General Conditions.
- D. Specifications-as modified by Addenda or Change Orders. Provisions in Division 1 shall take precedence over provisions of any other Division.

E. Drawings and details as modified by Addenda or Change Orders-in case of conflict within the Drawings, large-scale drawings shall take precedence over small-scale drawings or details.

F. Signed and Completed Form of Bid or Proposal.

G. Instructions to Bidders.

H. Advertisement for Bids.

I. Clarification of Drawings and Detail Drawings

1. Where on any drawing a portion of the Work is drawn out and the remainder is indicated in outline, the drawn out parts shall apply also to other similar portions of the Work. Where ornament or other detail is indicated by starting only, such detail shall be continued throughout the courses or parts in which it occurs and shall apply to all other similar parts of the Work, unless otherwise indicated.

2. With regard to Drawings the following shall apply:

- a. Written dimensions shall be followed; drawings may not be to scale.
- b. Figure dimensions on drawings shall govern of scale dimensions; and detail drawings shall govern over general drawings.

1.03 EXECUTION AND INTENT

Contractor makes the following representations to Owner:

- A. The Contract Sum is reasonable compensation for the Work and the Contract Time is adequate for the performance of the Work, as represented by the Contract Documents;

- B. Contractor has carefully reviewed the Contract Documents, had an opportunity to visit and examine the Project site, has become familiar with the local conditions in which the Work is to be performed, and has satisfied itself as to the nature, location, character, quality and quantity of the Work, the labor, materials, equipment, goods, supplies, work, services and other items to be furnished and all other requirements of the Contract Documents, as well as the surface and known subsurface conditions and other matters that may be encountered at the Project site or affect performance of the Work or the cost or difficulty thereof;
- C. Contractor is financially solvent, able to pay its debts as they mature, and possesses sufficient working capital to complete the Work and perform Contractor's obligations required by the Contract Documents; and
- D. Contractor is able to furnish the plant, tools, materials, supplies, equipment and labor required to complete the Work and perform the obligations required by the Contract Documents and have sufficient experience and competence to do so.

PART 2 - INSURANCE AND BONDS

Within seven (7) days from the date of the Notice of Award, and prior to commencement of the Work, Contractor shall obtain all the insurance required by the Contract Documents and provide evidence satisfactory to Owner that such insurance has been procured. Review and approval of the Contractor's insurance by Owner shall not relieve or decrease the Contractor's liability in any respect. Failure of the Contractor to fully comply with the insurance requirements of this Contract will be considered a material breach of contract and, at the option of Owner, is cause for such remedy or relief as may be available to Owner by law or under any provision of this

Contract, including immediate termination of the Contract.

2.01 CONTRACTOR'S LIABILITY INSURANCE

- A. General Insurance Requirements: Prior to commencement of the Work, Contractor shall obtain all the insurance required by the Contract Documents and provide evidence satisfactory to Owner that such insurance has been procured. Review of the Contractor's insurance by Owner shall not relieve or decrease the liability of Contractor. The term "insurance" herein shall include but not be limited to self-insurance, alternative risk transfer techniques, capital market solutions or any other form of risk financing.
- B. Contractor shall include in its bid the cost of all insurance and bonds required to complete the base bid work and accepted alternates, no additional payments will be made.
- C. Insurance policies, deductibles, self-insured retentions, and insurance carriers will be subject to review and approval by Owner. Except for Professional Liability Insurance coverage, if applicable, each insurer must either be 1) authorized to do business in the State of Washington and maintain A.M. Best's ratings of "A VII" or higher, or 2) procured as surplus lines under the provisions of RCW Chapter 48.15 ("Unauthorized Insurers"), except as may be otherwise approved by the Owner. Insurers or reinsurers of Professional Liability (Errors and Omissions) Insurance must have a rating of "B+VII or higher.
- D. Insurance Coverage and Terms: Contractor shall maintain the following insurance coverage during the Work and for one (1) year after Final Completion, except for Products and

Completed Operations coverage which shall remain in effect for three (3) years after Final Completion. Contractor shall also maintain the following insurance coverage during the performance of any corrective Work required by section 5.16.

1. Commercial General Liability (CGL) (this shall cover the use of all equipment, hoists, and vehicles on the site(s) not covered by Automobile Liability under paragraph 2.01D.2 written on an Occurrence Form or its equivalent which shall include coverage for:
 - a. Premises/Operations
 - b. Products/Completed Operations
 - c. Personal/Advertising Injury
 - d. Contractual
 - e. Independent Contractors
 - f. Stop Gap (unless insured as Employers Liability under Part B. of a Workers Compensation Insurance Policy
 - g. Per project aggregate per ISO CG 25 03 (Aggregate Limits of Insurance per Project) or Equivalent
 - h. Explosion, collapse, and underground
 - i. Waiver of Subrogation

In the event that the services to be provided under this Contract involve the Contractor's contact with minor children or any Vulnerable Adults as defined by RCW 74.34.020, the Contractor shall provide evidence that sexual molestation coverage has not been excluded from the CGL policy.

2. Automobile Liability on owned and non-owned motor vehicles, leased or hired vehicles written on an insurance industry standard form (CA 00 01) or equivalent.

3. Contractor's Pollution Liability (CPL): When project scope of work includes any or all items below, the Contractor will provide a Contractors Pollution Liability policy against claims for bodily injury, property damage and cleanup costs/environmental damages arising from pollution conditions caused in the performance of covered operations when:

- a. The Work involves remediation, abatement, repair, maintenance or other work with asbestos containing materials, lead-containing products (paint, coatings, components), mercury, underground storage tanks, and/or other hazardous materials. A CPL policy specifically covering these exposures shall be required from the Contractor or the subcontractor performing such work.
- b. The Work involves the transporting hazardous materials or waste, a separate policy or endorsement to the CPL policy specifically providing coverage for liability and cleanup, arising from an upset or collision during transportation of hazardous materials is required from the Contractor or subcontractor performing such work.

4. Professional Liability: When applicable, in the event that services delivered pursuant to this Contract either directly or indirectly involve or require professional services, Professional Liability, Errors and Omissions coverage shall be provided.

5. Cyber Liability: When applicable, the Contractor shall provide Cyber

- Liability coverage as specified in the Supplementary Conditions section.
6. Umbrella or Excess liability: When applicable, the Contractor shall provide Excess or Umbrella Liability coverage as specified in the Supplementary Conditions section
- E. Industrial Insurance Compliance: Contractor shall comply with the Washington State Industrial Insurance Act and, if applicable, the Federal Longshoremens and Harbor Workers' Act and the Jones Act.
- F. Insurance to protect for the following: All insurance coverages shall protect against claims for damages for personal and bodily injury or death, as well as claims for property damage, which may arise from operations in connection with the Work whether such operations are by Contractor or any Subcontractor.
- G. Owner as Additional Insured: All liability policies except Professional Liability and Workers Compensation shall be endorsed to include Owner as additional insured on a primary and non-contributory basis for Work performed in accordance with the Contract Documents, and all insurance certificates shall evidence the Owner as additional insured.
- H. Waiver of Subrogation: Contractor's policy shall provide waiver of subrogation by endorsement or otherwise.
- I. The Contractor's insurance coverage shall be primary insurance as respects the Owner, its Commissioners, officers, employees, and agents to the extent of:
1. The sole negligence of Contractor or any of its Subcontractors;
 2. The concurrent negligence of Contractor, or any Subcontractor, but only to the extent of the negligence of Contractor or such Subcontractor; and
 3. The use of any design, process, or equipment which constitutes an infringement of any United States patent presently issued, or violates any other proprietary interest, including copyright, trademark, and trade secret.
- J. Deductibles or Self-Insured Retention: Any deductibles or self-insured retentions \$25,000 or higher must be declared to, and approved by the Owner. The deductible and/or self-insured retention of the policies shall not limit or apply to the Prime Contractor's liability to the Owner. Payment of deductibles shall be the responsibility of the Contractor.
- K. XCU and Subsidence Perils Not Excluded: The Contractor's Commercial General Liability insurance shall not exclude perils generally known as XCU (Explosion, Collapse and Underground Property Damage), Subsidence, Absolute Earth Movement (except as respects earthquake peril only) or any equivalent peril.
- L. Railroad Protective Liability: The Contractor and/or any subcontractor of any tier shall comply with all of a railroad's risk management requirements (including purchasing Railroad Protective Liability insurance) before performing construction services adjacent to or upon a railway's right of way and/or property.
- M. No Limitation of Liability The limits of liability specified herein are minimum limits only. Such minimum limits of liability requirements shall not be construed to limit the liability of the

Contractor or of any of their respective insurers. The Contractor shall include Owner as an additional insured for primary and non-contributory limits of liability for the full valid and collectible limits of liability maintained by the Contractor whether such limits are primary, excess, contingent or otherwise. This provision shall apply regardless of whether limits maintained by the Contractor are greater than the minimum limits required by this Contract, and regardless of whether the certification of insurance by the Contractor specifies lower minimum limits than those specified for or maintained by the Contractor.

2.02 COVERAGE LIMITS

The minimum coverage limits shall be as follows unless otherwise specified in Supplementary Conditions:

A. 1) Commercial General Liability Insurance.

- \$1,000,000 each occurrence Combined Single Limit, Bodily and Property Damage and \$2,000,000 aggregate

2) Employers Liability or Washington Stop Gap Liability. A policy of Employers Liability or a Washington Stop Gap Liability insurance endorsement with the following minimum coverage:

- \$1,000,000 Bodily Injury by Accident, Bodily Injury by Disease – Each Employee, Bodily Injury by Disease – Policy Limit; Employers Liability or Washington Stop Gap

3) Commercial Automobile Liability Insurance.

- \$1,000,000 Combined Single Limit (CSL) coverage

4) Workers Compensation. A policy of Workers Compensation. As respects Workers Compensation insurance in the State of Washington, the Prime Contractor shall secure its liability for industrial injury to its employees in accordance with the provisions of Title 51 of the Revised Code of Washington (RCW). If the Prime Contractor is qualified as a self-insurer in accordance with Chapter 51.14 RCW, the Prime Contractor shall so certify by a letter signed by a corporate officer, indicating that it is a qualified self-insured, and setting forth the limits of any policy of excess insurance covering its employees, or any similar coverage required.

5) Contractor's Pollution Liability.

- \$1,000,000 Contractor's Pollution Liability, each claim

6) Professional Liability, Errors and Omissions.

- \$1,000,000 Professional Liability, Errors and Omissions, each claim

7) Cyber Liability.

- Refer to Supplementary Conditions section for Cyber Liability Coverage

8) Umbrella or Excess Liability

- Refer to Supplementary Conditions section for Umbrella or Excess Liability Coverage

2.03 INSURANCE COVERAGE ENDORSEMENTS AND CERTIFICATES

A. Additional Insured Endorsement.

1. The Owner must be included as an Additional Insured on a primary and non-contributory basis on all

Commercial General Liability and Automobile Liability policies of the Contractor. As respects the CGL insurance such additional insured status shall be evidenced by an ISO endorsement form CG2010 or equivalent.

2. Regarding to CGL insurance, such Additional Insured status shall contain a "separation of insureds" provision.
3. The Owner must be included as an Additional Insured for Contractors Completed Operations on the Commercial General Liability policy of the Contractor. As respects to CGL insurance, such additional insured status shall be evidenced by an ISO endorsement form CG2037 or equivalent. The endorsement shall remain in effect for not less than three (3) years after Final Completion of the Work.

B. Proof of Insurance and Insurance Expiration:

1. The Prime Contractor shall furnish certificates of insurance and policy endorsements as evidence of compliance with the insurance requirements of the Contract. Such certificates and endorsements must be signed by a person authorized by that insurance company to bind coverage on its behalf.
2. All insurance certificates shall name Owner's Project number and Project title.
3. The Prime Contractor shall include all subcontractors at any tier as insureds, and ensure that the Prime Contractor's coverage of subcontractors under the Prime Contractor's policies is not excluded by any policy provision or

endorsement. Alternatively, the Prime Contractor shall:

- a. Obtain from each subcontractor not insured under the Prime Contractor's policy or policies of insurance, evidence of insurance meeting all the requirements of this Contract, and
 - b. Maintain such evidence on file for a period of one (1) year after Final Completion except for Products and Completed Operations coverage which shall remain in effect for three (3) years after Final Completion and, upon request, submit such evidence to Owner for examination,
4. The Prime Contractor's insurance shall not be reduced or canceled without forty-five (45) days prior written notice to Owner, except for cancellation for non-payment of premium, for which notice shall not be less than ten (10) days prior to such date, unless a longer period of written notice is required under the provisions of Revised Code of Washington (RCW 48.18.290). The Prime Contractor shall not permit any required insurance coverage to expire during the term of this Contract.
 5. Owner reserves the right to require complete, certified copies of all required insurance policies at any time during the term of this Contract, or to waive any of the insurance requirements of this Contract at its sole discretion.

2.04 INSURANCE NON-COMPLIANCE

- A. Failure of the Prime Contractor to fully comply with the insurance requirements of this Contract will be considered a

material breach of contract and, at the option of the Owner, will be cause for such action as may be available to Owner under other provisions of this Contract or otherwise in law, including immediate termination of the Contract.

2.05 PAYMENT AND PERFORMANCE BONDS

- A. Payment and performance bonds for 100% of the Contract Sum, including all Change Orders and state sales tax, shall be furnished for the Work, and shall be in a form acceptable to the Owner.
- B. The Contractor shall provide to the Owner a provisional Payment and Performance bonds for review and approval by SHA with the signed Contract as an assurance of completion. The Contractor shall deliver the approved Payment and Performance bonds within seven (7) calendar days from the date of Contract Execution or within an extended period granted by the Owner based upon reasons determined adequate by the Owner. Failure to furnish the Payment and Performance bonds within the time specified may render the Contractor ineligible for award. The Owner may then either award the contract to the next lowest responsible bidder or re-solicit for bids. The Owner may retain the ineligible bidder's bid bond.

2.06 ADDITIONAL BOND SECURITY

Contractor shall promptly furnish additional security required to protect Owner and persons supplying labor or materials required by the Contract Documents if:

- A. Owner has a reasonable objection to the surety; or

- B. Any surety fails to furnish reports on its financial condition if requested by Owner.

2.07 BUILDERS RISK INSURANCE (WHEN APPLICABLE)

- A. The Owner may purchase and maintain Builders Risk insurance in the amount of the Contract Sum, including all adjustments thereto by Change Order, on a replacement cost basis until Final Completion. The Builders Risk insurance shall cover the interests in the Work of the Owner by the Contractor and any subcontractor of any tier. Contractor shall be responsible for payment of deductibles from the Builders Risk insurance policy to be purchased by Owner, which deductible amount is currently \$25,000 unless otherwise specified in the Supplementary Conditions section. Deductible amount may be subject to increase or decrease by Owner from time to time upon written notice to Contractor.
- B. Builders Risk insurance does not cover Contractor's or Subcontractor's at any tier owned, hired, or leased property or tools, equipment, or supplies used for the construction and not intended to form a permanent part of the Work, for which Contractor and Subcontractor shall be responsible and at their sole option to insure.
- C. Owner and Contractor waive all subrogation rights against each other, any Subcontractors, A/E, A/E's subconsultants, separate contractors described in section 5.19, if any, and any of their subcontractors, for damages caused by fire or other perils to the extent covered by property insurance obtained pursuant to this section or other property insurance applicable to the Work, except such rights as they have to proceeds of such

insurance held by Owner as fiduciary. The policies shall provide such waivers of subrogation by endorsement or otherwise. A waiver of subrogation shall be effective to a person or entity even though that person or entity would otherwise have a duty of indemnification, contractual or otherwise, did not pay the insurance premium directly or indirectly, and whether or not the person or entity had an insurable interest in the property damaged.

2.08 CRIMINAL BACKGROUND CHECKS

Criminal Background Investigation: The Contractor shall conduct a criminal background investigation of all employees, volunteers, subcontractors and sub-consultants performing any work who may reasonably be expected to have direct or incidental contact with SHA residents, SHA staff members, or vulnerable population. In addition, a criminal background investigation shall be performed for any person performing work under this Contract who needs special entry into SHA buildings, is given temporary use of an SHA building-access card or who collects payments of any kind.

The criminal background investigation shall include, but not necessarily be limited to, a Washington State Patrol background report or if the employee, volunteer, subcontractor or subconsultant resides in a state other than Washington, the background report should be obtained from the state patrol office where the employee, subcontractor or subconsultant has resided for the last 3 years. In the event a background check provides evidence of a felony conviction within the past seven years, the results of that investigation shall be disclosed to the SHA Project Manager. If any person performing work under this Contract is charged with a felony, the Contractor agrees to remove that person from performing any further work on the project

unless and until SHA agrees in writing to allow the person to continue.

PART 3 - TIME AND SCHEDULE

3.01 PROGRESS AND COMPLETION

Contractor shall diligently plan, coordinate and prosecute the Work, with an adequate number of qualified personnel to achieve Substantial Completion within the Contract Time, and achieve Final Completion within 90 days thereafter, but for extenuating circumstances fully documented in a timely manner and confirmed by Owner.

3.02 PROJECT SCHEDULE

- A. Within ten Days of contract execution, and prior to the commencement of work, unless otherwise stipulated in the Notice to Proceed, the Contractor shall attend an Owner initiated and facilitated preconstruction conference with representatives of Owner, its Architect, and all other pertinent Sub-Contractors of the Contractor and other interested parties. The conference will serve to acquaint the participants with the general plan of the construction operation and all other requirements of the contract. Owner will provide the Contractor with the date, time, and place of the conference.

The aforementioned preconstruction conference is not intended to replace any additional preconstruction conferences deemed necessary by any and all Authorities Having Jurisdiction in conjunction with the Work.

- B. Unless otherwise provided in Division 1, Contractor shall, within [10, unless otherwise indicated here_____] Days after issuance of the Notice to Proceed, submit a preliminary Progress Schedule. The Progress Schedule shall show the sequence in which Contractor proposes to perform the Work, and the dates on which Contractor plans to start and finish major

portions of the Work. The schedule shall also indicate dates for shop drawings and other submittals, commissioning, confidence testing, dates for acquiring materials and equipment and any other items required by Owner.

C. The Preliminary Progress Schedule shall be in the form of a critical path method analysis. The Preliminary Progress Schedule must show the major portions of the Work, indicating the start and finish dates, Substantial and Final completion dates and the proposed progression of the Work.

D. Owner shall return comments on the preliminary Progress Schedule to Contractor within 14 Days of receipt. Review by Owner of Contractor's schedule does not constitute an approval or acceptance of Contractor's construction means, methods, or sequencing, or its ability to complete the Work within the Contract Time. Failure by the Owner to indicate items on the schedule that do not conform to Contract requirements shall not alter or waive Contractor's obligation to comply with all Contract Requirements. Contractor shall revise and resubmit its schedule, as deemed necessary by Owner. Owner may withhold a portion of progress payments until a Progress Schedule has been submitted which meets the requirements of this section.

E. To its fullest extent, Contractor shall utilize and comply with the Progress Schedule. On a monthly basis, or as otherwise directed by Owner, Contractor shall, at its own expense, submit an updated Progress Schedule to Owner indicating actual progress. If, in the opinion of Owner, Contractor is not in conformance with the Progress Schedule for reasons other than Force Majeure as identified in section 3.05, the Contractor shall take such steps as are necessary to bring the actual completion dates of the Work into conformance with

the Progress Schedule. This shall include, but not be limited to: increasing the number of shifts, overtime operations, and/or days of work, whether on or off the Site, and submitting for acceptance any supplementary schedule or schedules as the Owner deems necessary to demonstrate how completion dates of the Work will be brought into conformance with the Progress Schedule.

Failure of the Contractor to comply with the requirements under these provisions shall be grounds for a determination by the Owner that the Contractor is not prosecuting the Work with sufficient diligence to ensure completion within the time specified in the Contract. Upon making this determination, the Owner may pursue any right or remedies it has under the Contract or in law.

F. Contractor shall promptly notify Owner in writing of any actual or anticipated event which is delaying or could delay achievement of any milestone or performance of any critical path activity of the Work. Contractor shall indicate the expected duration of the delay, the anticipated effect of the delay on the Progress Schedule, and the action to be taken to eliminate the delay. Provision of such notice does not relieve Contractor of its obligation to complete the Work within the Contract Time.

G. FLOAT- Float in the project Schedule shall be defined as the period of time measured by the number of days each non-critical path activity may be delayed before it and its succeeding activities become part of the Critical Path. Unless indicated otherwise, float belongs to the Project and Contractor and Owner may both utilize float to offset delays to the Work.

3.03 OWNER'S RIGHT TO SUSPEND THE WORK FOR CONVENIENCE

- A. Owner may, at its sole discretion, in writing, order Contractor to suspend all or any part of the Work for such period as Owner deems necessary.
- B. Upon receipt of a written Notice suspending the Work, Contractor shall immediately comply with its terms and take all reasonable steps to minimize the incurrence of cost of performance directly attributable to such suspension. Within a period up to 90 Days after the notice is delivered to Contractor, or within any extension of that period to which the parties shall have agreed, Owner shall either:
 - 1. Authorize resumption of the Work; or
 - 2. Terminate the Work covered by the notice as provided in the termination provisions of part 9.
- C. If a Notice suspending the Work is cancelled or the period of the notice or any extension thereof expires, Contractor shall resume Work.
- D. Contractor shall be entitled to an equitable adjustment in the Contract Time, or Contract Sum, or both, for increases in the time or cost of performance directly attributable to such suspension. Contractor shall keep all costs and records related to the construction suspension separately from normal project costs and shall comply with all requirements as more fully described and set forth in Part 7.

3.04 OWNER'S RIGHT TO STOP THE WORK FOR CAUSE

- A. If Contractor fails or refuses to perform its obligations in accordance with the Contract Documents, Owner may order Contractor, in writing, to stop the Work, or

any portion thereof, until satisfactory corrective action has been taken.

- B. Contractor shall not be entitled to an equitable adjustment in the Contract Time or Contract Sum for any increased cost or time of performance attributable to Contractor's failure or refusal to perform the Work or from any reasonable remedial action taken by Owner based upon such failure.

3.05 DELAY

- A. Any delay in or failure of performance by Owner or Contractor, other than the payment of money, shall not constitute a default hereunder if and to the extent the cause for such delay or failure of performance was unforeseeable and beyond the control of the party ("Force Majeure"). Acts of Force Majeure include, but are not limited to:
 - 1. Acts of God or the public enemy;
 - 2. Acts or omissions of any government or City entity;
 - 3. Fire or other casualty for which Contractor is not responsible;
 - 4. Quarantine or epidemic;
 - 5. Strike or defensive lockout;
 - 6. Unusually severe weather conditions which could not have been reasonably anticipated; and
 - 7. Unusual delay in receipt of supplies or products which were ordered and expedited and for which no substitute reasonably acceptable to Owner was available.

- B. Contractor shall be entitled to an equitable adjustment in the Contract Time for changes in the time of performance directly attributable to an act of Force

Majeure, provided it makes a request for equitable adjustment according to section 7.03. Contractor shall not be entitled to an adjustment in the Contract Sum resulting from an act of Force Majeure.

- C. Contractor shall be entitled to an equitable adjustment in Contract Time, and may be entitled to an equitable adjustment in Contract Sum, if the cost or time of Contractor's performance is changed due to the fault or negligence of Owner, provided the Contractor makes a request according to sections 7.02 and 7.03.
- D. Contractor shall not be entitled to an adjustment in Contract Time or in the Contract Sum for any delay or failure of performance to the extent such delay or failure was caused by Contractor or anyone for whose acts Contractor is responsible.
- E. To the extent any delay or failure of performance was concurrently caused by the Owner and Contractor, Contractor shall be entitled to an adjustment in the Contract Time for that portion of the delay or failure of performance that was concurrently caused, provided Contractor makes a request for equitable adjustment according to section 7.03, but shall not be entitled to an adjustment in Contract Sum.
- F. Contractor shall make all reasonable efforts to prevent and mitigate the effects of any delay, whether occasioned by an act of Force Majeure or otherwise.
- G. Contractor shall not be entitled to an adjustment in Contract Time if the act of Force Majeure did not impact progress of the Work on the Critical Path and prevent the Contractor from completing Contract Work within the Contract Time.

3.06 NOTICE TO OWNER OF LABOR DISPUTES

- A. If Contractor has knowledge that any actual or potential labor dispute is delaying or threatens to delay timely performance in accordance with the Contract Documents, Contractor shall immediately give written notice, including all relevant information, to Owner.
- B. Contractor agrees to insert a provision in its Subcontracts and to require insertion in all sub-subcontracts, that in the event timely performance of any such contract is delayed or threatened by delay by any actual or potential labor dispute, the Subcontractor or Sub-subcontractor shall immediately notify the next higher tier Subcontractor or Contractor, as the case may be, of all relevant information concerning the dispute.

3.07 DAMAGES FOR FAILURE TO ACHIEVE TIMELY COMPLETION

- A. Liquidated Damages
 - 1. Timely performance and completion of the Work is essential to Owner and time limits stated in the Contract are of the essence. Owner will incur serious and substantial damages if Substantial Completion and Final Completion of the Work does not occur within the Contract Time. However, it would be difficult if not impossible to determine the exact amount of such damages. Consequently, liquidated damages of _____ **[\$150.00 per calendar day unless otherwise specified in the Supplemental Conditions] will be assessed.**
 - 2. The liquidated damage amounts set forth above will be assessed not as a penalty, but as damages for breach of this Contract. This amount is fixed and agreed upon by and between the Contractor and Owner because of the impracticability and extreme difficulty of fixing and ascertaining the actual damages the Owner would in such

event sustain. This amount shall be construed as the actual amount of damages sustained by the Owner, and may be retained by the Owner and deducted from any payments to the Contractor.

3. Assessment of liquidated damages shall not release Contractor from any further obligations or liabilities pursuant to the Contract Documents.
4. If different completion dates are specified in the contract for separate parts, phases or stages of the work, the amount of liquidated damages shall be assessed only on those relevant parts or stages which are immediately delayed.

B. Actual Damages

Actual damages will be assessed for failure to achieve Final Completion within the time provided. Actual damages will be calculated on the basis of direct architectural, administrative, and other related costs attributable to the Project from the date when Final Completion should have been achieved, based on the date Substantial Completion is actually achieved, to the date Final Completion is actually achieved. The amount of these costs may be retained by Owner and deducted from any payment due Contractor.

PART 4 - SPECIFICATIONS, DRAWINGS, DETAILS AND OTHER DOCUMENTS

4.01 DISCREPANCIES AND DUTY TO REVIEW CONTRACT DOCUMENTS

- A. The intent of the Specifications, Drawings and Details is to describe and depict the complete Project to be constructed in accordance with the Contract Documents. Contractor shall furnish all labor, materials, equipment, tools, transportation, permits, and supplies, and

perform the Work required in accordance with the Drawings, Details, Specifications, and other provisions of the Contract Documents, unless otherwise noted.

- B. The Contract Documents are complementary. What is required or shown in one part of the Contract Documents shall be binding as if required and shown in all parts. Anything mentioned in the Specifications and not shown on the Drawings, or shown on the Drawings and not mentioned in the Specifications, shall be of like effect as if shown or mentioned in both. Anything shown in one section of the drawings and not shown in another section of the drawings of which implies the elements are to be coordinated, shall be as if shown in both sections. The organization of the specification into divisions, provisions and parts and the organization of the drawings shall not control the Contractor in dividing the Work among Subcontractors or in establishing the extent of Work to be performed by any trade.
- C. Contractor shall carefully study, compare and reconcile the Contract Documents with each other and shall confer and coordinate with each sub-contractor. If, during the performance of the Work, Contractor finds a conflict, error, inconsistency, or omission in the Contract Documents, it shall promptly, and before proceeding with the Work affected thereby, report such conflict, error, inconsistency, or omission to Owner in writing.
- D. Contractor shall do no Work without consulting applicable Drawings, Details, Specifications, or written modifications, or Shop Drawings where required, unless instructed to do so in writing by Owner. If Contractor performs any construction activity that it knows or should have known is in conflict with Drawings, Details, Specifications, or written modifications, or Shop Drawings or is based upon an, error,

inconsistency, or omission in Drawings, Details, Specifications, or written modifications, or Shop Drawings, Contractor shall be responsible for the cost of performance and, shall bear the cost for its correction.

- E. Contractor shall provide any work or materials the provision of which is clearly implied and is within the scope of the Contract Documents even if the Contract Documents do not mention them specifically.
- F. Questions regarding interpretation of the requirements of the Contract Documents shall be submitted to the Owner.

4.02 PROJECT RECORD

- A. Contractor shall legibly mark in ink on a separate set of the Drawings and Specifications all actual construction, including depths of foundations, horizontal and vertical locations of internal and underground utilities and appurtenances referenced to permanent visible and accessible surface improvements, locations of all ducting, HVAC, mechanical, electrical, and any systems not visible in walls, floors, and ceilings, field changes of dimensions and details, actual suppliers, manufacturers and trade names, models of installed equipment, and Change Order proposals. This separate set of Drawings and Specifications shall be known as the "Project Record."
- B. The Project Record shall be maintained on the project site throughout the construction and shall be clearly labeled "PROJECT RECORD". The Project Record shall be updated at least weekly noting all current changes and shall be available for review by Owner at all times. At the time of Substantial Completion, the Contractor shall submit to the Owner's A/E, three (3) draft copies of the project record for review and comment. The

Contractor shall make all noted corrections per the comments and resubmit to A/E for final review and acceptance. Review costs incurred for additional review cycles if required, shall be at the sole expense of the Contractor.

- C. The Contractor shall indicate on the Project Record any unforeseen items that may remain on site. Whether or not the unforeseen items can remain will be determined by the Owner.
- D. Contractor shall submit the completed and finalized conformed Project Record documents with all pages of the same size, with all pages marked "Project Record" along with three (3) copies of the same in digital format to Owner prior to Final Acceptance.

4.03 SHOP DRAWINGS

- A. "Shop Drawings" means documents and other information required to be submitted to Owner by Contractor pursuant to the Contract Documents, showing in detail: the proposed fabrication and assembly of structural elements; and the installation (i.e. form, fit, and attachment details) of materials and equipment. Shop Drawings include, but are not limited to, drawings, erection drawings, diagrams, layouts, schematics, descriptive literature, illustrations, schedules, performance and test data, samples, and similar materials furnished by Contractor to explain in detail specific portions of the Work required by the Contract Documents. For materials and equipment to be incorporated into the Work, Contractor submittal shall include the name of the manufacturer, the model number, and other information concerning the performance, capacity, nature, and rating of the item. When directed, Contractor shall submit all samples at its own expense. Owner may duplicate, use, and disclose Shop Drawings provided in accordance with the Contract Documents.

- B. Contractor shall coordinate all Shop Drawings, and review them for accuracy, completeness, and compliance with the Contract Documents and shall indicate its approval thereon with a stamped date and authorized signature as evidence of such coordination and review prior to submitting them to the Owner for its review. Where required by law, Shop Drawings shall be stamped by an appropriate professional licensed by the State of Washington. Shop Drawings submitted to Owner without evidence of Contractor's approval shall be returned for resubmission. Additional review costs incurred by the Owner resulting from incomplete submissions of Shop Drawings will be at the sole expense of the Contractor. Contractor shall review, approve, and submit Shop Drawings with reasonable promptness and in such sequence as to cause no delay in the Work or in the activities of Owner or separate contractors. Contractor's submittal schedule shall allow a reasonable time for A/E review. Owner will review, approve, or take other appropriate action on the Shop Drawings. Contractor shall perform no portion of the Work requiring submittal and review of Shop Drawings until the respective full submittal has been reviewed and the Owner has accepted or taken other appropriate action. Owner shall respond to Shop Drawing submittals with reasonable promptness. Any Work by Contractor shall be in accordance with the final reviewed Shop Drawings. Submittals made by Contractor which are not required by the Contract Documents will be returned without action.
- C. Review and acceptance or other appropriate action with regard to Shop Drawings, by Owner or A/E shall not relieve Contractor of responsibility for any errors or omissions in such Shop Drawings, nor from responsibility for compliance with the requirements of the Contract Documents. Unless specified in the Contract Documents, review by Owner or A/E shall not constitute an approval of the safety precautions employed by Contractor during construction, or constitute an approval of Contractor's means or methods of construction. If Contractor fails to obtain review and acceptance before installation and the item or work is subsequently rejected, Contractor shall be responsible for all costs for any and all corrections.
- D. If Shop Drawings show variations from the requirements of the Contract Documents, Contractor shall describe such variations in writing on a separate document from the Shop Drawings, at the time it submits the Shop Drawings containing such variations. If Owner reviews and accepts any such variation, an appropriate Change Order may be issued. If the variation is considered minor and does not involve an adjustment in the Contract Sum or Contract Time, a Change Order will not be issued; however, the modification shall be recorded by the Contractor on the Project Record.
- E. Unless otherwise provided in Division 1, Contractor shall submit to Owner for review 4 copies of all Shop Drawings. Unless otherwise indicated, 3 sets of all Shop Drawings shall be retained by Owner and 1 reviewed set shall be returned to Contractor.

4.04 ORGANIZATION OF SPECIFICATIONS

Specifications are prepared in sections which conform generally with trade practices. These sections are for Owner and Contractor convenience and shall not control Contractor in dividing the Work among the Subcontractors or in establishing the extent of the Work to be performed by any trade.

4.05 OWNERSHIP AND USE OF DRAWINGS, SPECIFICATIONS, AND OTHER DOCUMENTS

- A. The Drawings, Specifications, and other documents prepared by A/E are instruments of A/E's service through which the Work to be executed by Contractor is described. Neither Contractor nor any Subcontractor shall own or claim a copyright to the Drawings, Specifications, and other documents prepared by A/E, and A/E shall be deemed the author of them and will, along with any rights of Owner, retain all common law, statutory, and other reserved rights, in addition to the copyright. All copies of these documents, except Contractor's set, shall be returned or suitably accounted for to A/E, on request, upon completion of the Work.
- B. The Drawings, Specifications, and other documents prepared by the A/E, and copies thereof furnished to Contractor, are for use solely with respect to Work of this Project. They are not to be used by Contractor or any Subcontractor on other projects or for additions to this Project outside the scope of the Work without the specific written consent of Owner and A/E. Contractor and Subcontractors are granted a limited license to use and reproduce applicable portions of the Drawings, Specifications, and other documents prepared by A/E appropriate to and for use in the execution of the Work.
- C. Contractor, and all Subcontractors of any tier, or material or equipment supplier of any tier, grant a non-exclusive license to Owner, without additional cost or royalty, to use for its own purposes (including reproduction) all Shop Drawings, together with the information and diagrams contained therein, prepared by them. In providing Shop Drawings, they warrant that they have authority to grant to Owner a license to use the Shop Drawings, and that such license is not in violation of any

copyright or other intellectual property right. Contractor agrees to defend and indemnify Owner pursuant to the indemnity provisions in section 5.03 from any violations of copyright or other intellectual property rights arising out of Owner's use of the Shop Drawings hereunder, or to secure for Owner, at Contractor's own cost, licenses in conformity with this section.

- D. The Shop Drawings and other submittals prepared by Contractor, Subcontractors of any tier, or its or their equipment or material suppliers, and copies thereof furnished to Contractor, are for use solely with respect to this Project. They are not to be used by Contractor or any Subcontractor of any tier, or material or equipment supplier of any tier, on other projects or for additions to this Project outside the scope of the Work without the specific written consent of Owner. The Contractor, Subcontractors of any tier, and material or equipment suppliers of any tier are granted a limited license to use and reproduce applicable portions of the Shop Drawings and other submittals appropriate to and for use in the execution of their Work under the Contract Documents.

PART 5 - PERFORMANCE

5.01 CONTRACTOR CONTROL AND SUPERVISION

- A. Contractor shall at all times supervise and direct the Work, using its best skill and attention, and shall perform the Work in a skillful manner with adequate resources. Contractor shall be solely responsible for, and have full control over, construction means, methods, techniques, sequences, and procedures and for coordinating all portions of the Work, unless otherwise noted in the Contract Documents. Contractor shall disclose its means and

methods of construction when requested by Owner.

1. Failure to notify the Owner of changes in the project team members and the teams staffing levels established at the start of the Project may entitle the Owner to a credit for excess General Conditions previously allocated at the start of the Project. The Owner reserves the right to withhold General Conditions for staff removed without written notice to the Owner.
2. The Contractor shall also provide sufficient staffing and supervision to review and process Requests for Information, Change Order Proposals, Change Order Requests, Change Orders, closeout documentation, and to perform all other requirements of the Contract and all Work.

- B. Performance of the Work shall be directly supervised by a competent superintendent who is satisfactory to Owner and has authority to act for Contractor. The superintendent shall be assigned only to this Project unless approved by Owner and shall not be changed without the prior written notice and consent of Owner.
- C. Contractor shall be responsible for acts and omissions of Contractor, Subcontractors, Suppliers, Vendors and their employees and agents.
- D. Contractor shall enforce strict discipline and good order among Contractor's employees and all other persons performing the Work. Contractor shall not permit employment of persons not skilled in tasks assigned to them. Contractor's employees shall at all times conduct business in a manner which assures fair, equal, and nondiscriminatory treatment of

all persons. Owner may, by written notice, request Contractor remove from the Work or Project site any employee Owner reasonably deems incompetent, careless, unsafe or otherwise objectionable.

- E. Contractor shall keep on the Project site a copy of the Drawings, Specifications, addenda, reviewed Shop Drawings, inspection reports, permits and permit drawings.
- F. The Contractor shall perform on the site, and with its own organization, work equivalent to at least **(12 percent unless otherwise indicated here____)** of the total amount of work to be performed under the contract. This percentage may be reduced by a change order to this contract if, during performance of the work, the Contractor requests a reduction and the Owner determines that the reduction would be to the advantage of the Project and Owner.

5.02 PERMITS, FEES, AND NOTICES

- A. Unless otherwise provided in the Contract Documents, Contractor shall obtain and pay for all permits, licenses, and inspections necessary for proper execution and completion of the Work. Where Owner can arrange for the issuance of all or part of these permits, fees and licenses, without cost to the Contractor, the Contract Sum shall be reduced accordingly by Change Order. Prior to Final Acceptance, all approved, signed permits and all Certificates of Occupancy shall be delivered to Owner.
- B. If allowances for permits or utility fees are called for in the Contract Documents and set forth in Contractor's bid or proposal, and the actual costs of those permits or fees differ from the allowances in the Contract Documents, the difference either increase or decrease shall be adjusted by Change Order.

- C. Contractor shall comply with and give notices required by all federal, state, and local laws, ordinances, rules, regulations, and lawful orders of public authorities applicable to performance of the Work.

5.03 PATENTS AND ROYALTIES

Contractor is responsible for, and shall pay, all royalties and license fees. Contractor shall defend, indemnify, and hold Owner harmless from any costs, expenses, and liabilities arising out of the infringement by Contractor of any patent, copyright, or other intellectual property right used in the Work; however, provided that Contractor gives prompt notice, Contractor shall not be responsible for such defense or indemnity when a particular design, process, or product of a particular manufacturer or manufacturers is required by the Contract Documents. If Contractor has reason to believe that use of the required design, process, or product constitutes an infringement of a patent or copyright, it shall promptly notify Owner of such potential infringement. Failure to give such notice shall make the Contractor responsible for resultant loss.

5.04 PREVAILING WAGES. *[ONLY APPLICABLE TO STATE- OR CITY-FUNDED PROJECTS. SEE SECTION 11.12 FOR FEDERALLY-FUNDED PROJECTS].*

- A. Contractor shall pay the prevailing rate of wages to all workers, laborers, or mechanics employed in the performance of any part of the Work in accordance with RCW 39.12 and the rules and regulations of the Department of Labor and Industries. The schedule of prevailing wage rates for the locality or localities of the Work is determined by the Industrial Statistician of the Department of Labor and Industries. It is the Contractor's responsibility to verify the applicable prevailing wage rate.

- B. Before commencing the Work, Contractor shall file a statement under oath with Owner and with the Director of Labor and Industries certifying the rate of hourly wage paid and to be paid each classification of laborers, workers, or mechanics employed upon the Work by Contractor and Subcontractors. Such rates of hourly wage shall not be less than the prevailing wage rate.

- C. Disputes regarding prevailing wage rates shall be referred for arbitration to the Director of the Department of Labor and Industries. The arbitration decision shall be final and conclusive and binding on all parties involved in the dispute as provided for by RCW 39.12.060. See Section 8.

- D. Each Application for Payment submitted by Contractor shall state that prevailing wages have been paid in accordance with the prefiled statement(s) of intent, as approved. Copies of the approved intent statement(s) shall be posted on the job site with the address and telephone number of the Industrial Statistician of the Department of Labor and Industries where a complaint or inquiry concerning prevailing wages may be made.

- E. In compliance with chapter 296-127 WAC, Contractor shall pay to the Department of Labor and Industries the currently established fee for each statement of intent and/or affidavit of wages paid submitted to the Department of Labor and Industries for certification.

5.05 HOURS OF LABOR. *[ONLY APPLICABLE TO STATE- OR CITY-FUNDED PROJECTS. SEE SECTION 11.12 FOR FEDERALLY-FUNDED PROJECTS].*

- A. Contractor shall comply with all applicable provisions of RCW 49.28 and they are incorporated herein by reference. Pursuant to that statute, no laborer, worker, or mechanic employed by Contractor, any Subcontractor, or any

other person performing or contracting to do the whole or any part of the Work, shall be permitted or required to work more than eight hours in any one Day, provided, that in cases of extraordinary emergency, such as danger to life or property, the hours of work may be extended, but in such cases the rate of pay for time employed in excess of eight hours of each Day shall be not less than one and one-half times the rate allowed for this same amount of time during eight hours' service.

- B. Notwithstanding the preceding paragraph, RCW 49.28 permits a contractor or subcontractor in any public works contract subject to those provisions, to enter into an agreement with its employees in which the employees work up to ten hours in a Day. No such agreement may provide that the employees work ten-hour days for more than four Days a week. Any such agreement is subject to approval by the employees. The overtime provisions of RCW 49.28 shall not apply to the hours, up to forty hours per week, worked pursuant to any such agreement.

5.06 NONDISCRIMINATION

- A. Discrimination in all phases of employment is prohibited by, among other laws and regulations, Title VII of the Civil Rights Act of 1964, the Vietnam Era Veterans Readjustment Act of 1974, sections 503 and 504 of the Vocational Rehabilitation Act of 1973, the Equal Employment Act of 1972, the Age Discrimination Act of 1967, the Americans with Disabilities Act of 1990, the Civil Rights Act of 1991, Presidential Executive Order 11246, Executive Order 11375, the Washington State Law Against Discrimination, RCW 49.60, and the Seattle Fair Employment Practices Ordinance. These laws and regulations establish minimum requirements for affirmative action and fair employment practices which Contractor must meet.

B. During performance of the Work:

1. Contractor shall not discriminate against any employee or applicant for employment because of race, creed, color, national origin, sex, age, marital status, the presence of any physical, sensory, or mental disability, sexual orientation, Vietnam-era veteran status, disabled veteran status or political affiliation, nor commit any unfair practices as defined in RCW 49.60.
2. The Contractor shall take affirmative action to ensure that applicants are employed, and that employees are treated during employment without regard to their race, color, religion, sex, national origin, of any physical, sensory, or mental disability, sexual orientation, Vietnam-era veteran status, disabled veteran status, or political affiliation. Such action shall include, but not be limited to, (1) employment, (2) upgrading, (3) demotion, (4) transfer, (5) recruitment or recruitment advertising, (6) layoff or termination, (7) rates of pay or other forms of compensation, and (8) selection for training, including apprenticeship.
3. The Contractor shall post in conspicuous places available to employees and applicants for employment the notices to be provided by the Owner that explain this clause.
4. Contractor shall, in all solicitations or advertisements for employees placed by or for it, state that all qualified applicants will be considered for employment, without regard to race, creed, color, national origin, sex, age, marital status, the presence of any physical, sensory, or mental disability, sexual orientation, Vietnam-era veteran status, disabled veteran status or political affiliation.

5. Contractor shall send to each labor union, employment agency, or representative of workers with which it has a collective bargaining agreement or other contract or understanding, a notice advising the labor union, employment agency, or workers' representative of Contractor's obligations according to the Contract Documents and RCW 49.60.
6. Contractor shall permit access to its books, records, and accounts, and to its premises by Owner, the Washington State Human Rights Commission, and the Seattle Office of Civil Rights, for the purpose of investigation to ascertain compliance with this section of the Contract Documents.
7. Contractor shall include the provisions of this section in every Subcontract.

5.07 SAFETY PRECAUTIONS

- A. Contractor shall be responsible for initiating, maintaining, and supervising all safety precautions and programs in connection with the performance of the Work.
- B. In carrying out its responsibilities according to the Contract Documents, Contractor shall protect the lives and health of employees performing the Work and other persons who may be affected by the Work; prevent damage to materials, supplies, and equipment whether on site or stored off-site; and prevent damage to other property at the site or adjacent thereto. Contractor shall comply with all applicable laws, ordinances, rules, regulations, and orders of any public body having jurisdiction for the safety of persons or property, or to protect them from damage, injury, or loss; shall erect and maintain all necessary safeguards for such safety and protection; and shall

notify owners of adjacent property and utilities when prosecution of the Work may affect them.

- C. Contractor shall maintain an accurate record of exposure data on all incidents relating to the Work resulting in death, traumatic injury, occupational disease including all medical treatments or damage to property, materials, supplies, or equipment. Contractor shall immediately report any such incident to Owner. Owner shall, at all times, have a right of access to all records of exposure.
- D. Contractor shall provide all persons working on the Project site with information and training on hazardous materials of the Work at the time of their initial assignment, and whenever a new hazard is introduced into their work area.

1. Information. At a minimum, Contractor shall inform persons working on the Project site of:

- a. The requirements of chapter 296-62 WAC, General Occupational Health Standards;
- b. Any operations in their work area where hazardous materials are present; and
- c. The location and availability of written hazard communication programs, including the required list(s) of hazardous chemicals and material safety data sheets required by chapter 296-62 WAC.

2. Training. At a minimum, Contractor shall provide training for persons working on the Project site which includes:

- a. Methods and observations that may be used to detect the presence or release of a hazardous materials in the work area (such as

- monitoring conducted by the employer, continuous monitoring devices, visual appearance or odor of hazardous chemicals when being released, etc.);
- b. The physical and health hazards of the materials in the work area;
 - c. The measures such persons can take to protect themselves from these hazards, including specific procedures Contractor, or its Subcontractors, or others have implemented to protect those on the Project site from exposure to hazardous materials, such as appropriate work practices, emergency procedures, and personal protective equipment to be used; and
 - d. The details of the hazard communication program developed by Contractor, or its Subcontractors, including an explanation of the labeling system and the material safety data sheet, and how employees can obtain and use the appropriate hazard information.
- E. Contractor's responsibility for hazardous, toxic, or harmful substances shall include the following duties:
1. Contractor shall not keep, use, dispose, transport, generate, or sell on or about the Project site, any materials now or hereafter designated as, or which are subject to regulation as, hazardous, toxic, dangerous, or harmful by any federal, state or local law, regulation, statute or ordinance (hereinafter collectively referred to as "hazardous materials"), in violation of any such law, regulation, statute, or ordinance, but in no case shall any such hazardous material be stored more than 90 Days on the Project site.
 2. Contractor shall promptly notify Owner of all spills or releases of any hazardous substances which are otherwise required to be reported to any regulatory agency and shall pay the full cost of cleanup. Contractor shall promptly notify Owner of all failures to comply with any federal, state, or local law, regulation, or ordinance; all inspections of the Project site by any regulatory entity concerning the same; all regulatory orders or fines; and all responses or interim cleanup actions taken by or proposed to be taken by any government entity or private party on the Project site.
- F. All Work shall be performed with due regard for the safety of the public. Contractor shall perform the Work so as to cause a minimum of interruption of vehicular traffic or inconvenience to pedestrians. All arrangements to care for such traffic shall be Contractor's responsibilities. All expenses involved in the maintenance of traffic by way of detours shall be borne by Contractor.
- G. In an emergency affecting the safety of life or the Work or of adjoining property, Contractor is permitted to act, at its discretion, to prevent such threatened loss or injury, and Contractor shall so act if so authorized or instructed.
- H. Nothing provided in this section shall be construed as imposing any duty upon Owner or A/E with regard to, or as constituting any express or implied assumption of control or responsibility over, Project site safety, or over any other safety conditions relating to employees or agents of Contractor or any of its Subcontractors, or the public.
- I. The Contractor shall be responsible for its subcontractors' compliance with the provisions of this clause. The Contractor

shall take such action with respect to any subcontract as Owner, Labor & Industries, the Secretary of Housing and Urban Development, or the Secretary of Labor shall direct as a means of enforcing such provisions.

5.08 OPERATIONS, MATERIAL HANDLING, AND STORAGE AREAS

- A. Contractor shall confine all operations, including storage of materials, to Owner-approved areas.
- B. Temporary buildings (e.g., storage sheds, shops, offices) and utilities may be provided by Contractor only with the consent of Owner and without expense to Owner. The temporary buildings and utilities shall remain the property of Contractor and shall be removed, and the site restored to the Owner's satisfaction, by Contractor at its expense upon completion of the Work.
- C. Contractor shall use only established roadways or temporary roadways authorized by Owner. When materials are transported in prosecuting the Work, vehicles shall not be loaded beyond the loading capacity recommended by the manufacturer of the vehicle or prescribed by federal, state, or local law or regulation.
- D. Ownership and control of all materials or facility components to be demolished or removed from the Project site by Contractor shall immediately vest in Contractor upon severance of the component from the facility or severance of the material from the Project site. Contractor shall be responsible for compliance with all laws governing the storage and ultimate proper/legal disposal off site. Contractor shall provide Owner with a copy of all manifests and receipts evidencing proper disposal when required by Owner or applicable law.
- E. Contractor shall be responsible for the proper care and protection of its materials and equipment delivered to the Project site. Materials and equipment may be stored on the premises subject to approval

of Owner. When Contractor uses any portion of the Project site as a shop, Contractor shall be responsible for dust control, any repairs, patching, or cleaning arising from such use.

- F. Contractor shall protect and be responsible for any damage or loss to the Work, or to the materials or equipment until the date of Substantial Completion, and shall repair or replace without cost to Owner any damage or loss that may occur, except damages or loss caused by the acts or omissions of Owner. Contractor shall also protect and be responsible for any damage or loss to the Work, or to the materials or equipment, after the date of Substantial Completion, and shall repair or replace without cost to Owner any such damage or loss that might occur, to the extent such damages or loss are caused by the acts or omissions of Contractor, or any Subcontractor.

5.09 PRIOR NOTICE OF EXCAVATION

"Excavation" means an operation in which earth, rock, or other material on or below the existing grade is moved or otherwise displaced by any means, except the tilling of soil less than 12 inches in depth for agricultural purposes, or road ditch maintenance that does not change the original road grade or ditch flow line. Before commencing any excavation, Contractor shall provide proper notice of the scheduled commencement of excavation to all owners of underground facilities or utilities, through locator services. Contractor shall provide adequate, ongoing locator services as required to accommodate the Work, during the course of the Work and pay all fees for locator services. Any utilities affected from Contractor activities or damaged due to the Contractor's failure to adequately protect or locate utilities per the Contract Documents per the requirements set forth by the Authorities

Having Jurisdiction shall be corrected and paid for by the Contractor. No additional days will be added to Contract Time due to these impacts.

5.10 UNFORESEEN PHYSICAL CONDITIONS

- A. If Contractor encounters conditions at the site which are subsurface or otherwise concealed physical conditions which differ materially from those indicated in the Contract Documents, or unknown physical conditions that differ materially from those ordinarily found and generally recognized in construction activities of the character provided for in the Contract Documents, then Contractor shall give Notice to Owner promptly and in no event later than one-work day after the first observance of the conditions. Continued disturbance of areas encountered by the Contractor before adequate Notice is provided to the Owner, or prior to allowing the Owner ample time to observe the conditions, will constitute waiver of the Contractor's right to an equitable adjustment.
- B. If such conditions differ materially and cause a change in Contractor's cost of, or time required for, performance of any part of the Work, the Contractor may be entitled to an equitable adjustment in the Contract Time or Contract Sum, or both, provided it makes a request therefor as provided in part 7.

5.11 PROTECTION OF EXISTING STRUCTURES, EQUIPMENT, VEGETATION, UTILITIES, AND IMPROVEMENTS

- A. Contractor shall protect from damage all existing conditions, including soils, structures, equipment, improvements, utilities, and vegetation at or adjacent the Project site. Damages on adjacent property of a third party, the locations of which are made known to or should be known by Contractor shall be promptly reported by either the Owner or Contractor

to the other party. Contractor shall repair any damage, including that to the property of a third party, resulting from failure to comply with the requirements of the Contract Documents, any defects of equipment, material, workmanship or design furnished by the Contractor, or failure by Contractor or subcontractor at any tier to exercise reasonable care in performing the Work. If Contractor fails or refuses to repair the damage within 7 days, Owner may have the necessary work performed and charge the cost to Contractor.

- B. Contractor shall only remove trees when specifically authorized to do so by Contract Documents and verified by owner. Contractor shall protect all vegetation that will remain in place.
- C. The Contractor shall shore up, brace, underpin, secure, and protect as necessary all foundations and other parts of existing structures adjacent to, adjoining, and in the vicinity of the site, which may be affected by the excavations or other operations connected with the construction of the project.
- D. Any equipment temporarily removed as a result of work under this contract shall be protected, cleaned, and replaced in the original condition.
- E. New work which connects to existing work shall correspond in all respects with that to which it connects and/or be similar to existing work unless otherwise required by the Contract.
- F. No structural members shall be altered or in any way weakened without the written authorization of the Owner, unless such work is clearly specified in the Contract.
- G. If the removal of the existing work exposes discolored or unfinished surfaces, or work out of alignment, such surfaces shall be refinished, or the material replaced as

necessary to make the continuous work uniform and harmonious. This, however, shall not be construed to require the refinishing or reconstruction of dissimilar finishes previously exposed, or finished surfaces in good condition, but in different planes or on different levels when brought together by the removal of intervening work, unless such refinishing or reconstruction is specified in the Contract.

- H. Contractor shall conform to requirements in Part 7 in the event conditions noted in G above generate additional costs.

5.12 LAYOUT OF WORK

- A. Contractor shall plan and lay out the Work in advance of operations so as to coordinate all work without delay or revision.
- B. Contractor shall lay out the Work from baselines and bench marks indicated on the Drawings, and shall be responsible for all field measurements in connection with the layout. Contractor shall furnish, at its own expense, all stakes, templates, platforms, equipment, tools, materials, and labor required to lay out any part of the Work. Contractor shall be responsible for executing the Work to the lines and grades that may be established. Contractor shall be responsible for maintaining or restoring all stakes and other established marks.
 - 1. Contractor shall limit tolerances of layout to an absolute minimum. Standard industry building tolerances shall govern.

5.13 MATERIAL AND EQUIPMENT

- A. All equipment, material, and articles incorporated into the Work shall be new and of the most suitable grade for the purpose intended, unless otherwise specifically provided in the Contract Documents. References in the Specifications to equipment, material, articles, or patented processes by trade

name, make, or catalog number, shall be regarded as establishing a standard quality and shall not be construed as limiting competition. Contractor may, at its option, use any equipment, material, article, or process that, in the judgment of Owner, is equal to that named in the Specifications, unless otherwise specifically provided in the Contract Documents.

- B. Contractor shall do all cutting, fitting, or patching that may be required to make its parts fit together properly, or receive or be received by work of others set forth in, or reasonably implied by, the Contract Documents. Contractor shall not endanger or compromise any work by cutting, excavating, or otherwise altering the Work and shall not cut or alter the work of any other contractor unless approved in advance by Owner.
- C. Should any of the Work be found defective, or in any way not in accordance with the Contract Documents, this work, in whatever stage of completion, may be rejected by Owner.

5.14 AVAILABILITY AND USE OF UTILITY SERVICES

- A. Owner shall make all reasonable utilities available to Contractor from existing outlets and supplies, or as specified in the Contract Documents. Unless otherwise provided in the Contract Documents, the utility service consumed shall be charged to or paid for by Contractor at current rates charged to Owner or, where the utility is produced by Owner, at reasonable rates determined by Owner. Contractor will carefully conserve any utilities.
- B. Contractor shall, at its expense and in a skillful manner satisfactory to Owner, coordinate use with the Authority, install and maintain all necessary temporary connections and distribution lines, together with appropriate protective

devices, and all meters required to measure the amount of each utility used for the purpose of determining charges. Prior to the date of Final Acceptance, Contractor shall remove all temporary connections, distribution lines, meters, and associated equipment and materials.

- C. The Contractor shall provide and pay for including but not limited to all temporary heating, electricity, water, gas, covering, and enclosures and generated power necessary to properly protect all work and materials against damage by moisture and temperature to dry out the work, and to facilitate the completion of the work. No permanent heating or cooling equipment installed during the course of the Work shall be used to facilitate the Contractors work. Contractor shall turn over to Owner all major systems. in new condition and at the time required by the Contract Documents.
- D. Commissioning of heating and cooling equipment installed during the course of the Work shall be considered "testing" of such equipment and all utilities consumed for this purpose shall be the responsibility of the Contractor to pay for. System testing activities occurring beyond Substantial Completion are subject to utility use fees and will be pro-rated by the Owner and will be the responsibility of the Contractor to pay for.

5.15 TESTS AND INSPECTIONS

- A. Contractor shall document and maintain an adequate testing and inspection program and perform such tests and inspections as are necessary or required to ensure that the Work conforms to the requirements of the Contract Documents. Contractor shall be responsible for inspection and quality surveillance of all its Work and all Work performed by any Subcontractor or other service related entity. Unless otherwise provided, Contractor shall make arrangements for

such tests, inspections, and approvals with an independent testing laboratory or entity acceptable to Owner, or with the appropriate public Authorities Having Jurisdiction, and shall bear all related costs of tests, inspections, and approvals. Contractor shall provide Owner timely notice of when and where tests and inspections are to be made. Contractor shall maintain complete inspection records and make them available to Owner.

- B. OWNER INITIATED TESTS OR INSPECTIONS Contractor shall participate, and cooperate fully with any field tests that may have performed by consultants or testing agencies on behalf of the Owner, and shall make accommodations for that testing, sampling, etc. as required by Owner.
- C. Owner may, at any time, conduct such inspections and tests as it deems necessary to ensure that the Work is in accordance with the Contract Documents. Owner shall notify Contractor when an inspection is scheduled and if an inspection or test reveals that the Work is not in accordance with the Contract Documents. Unless the subject items are expressly accepted by Owner, such Owner inspection and tests are for the sole benefit of Owner and do not:
 - 1. Constitute or imply acceptance;
 - 2. Relieve Contractor of responsibility for providing adequate quality control measures;
 - 3. Relieve Contractor of responsibility for risk of loss or damage to the Work, materials, or equipment;
 - 4. Relieve Contractor of its responsibility to comply with the requirements of the Contract Documents; or

5. Impair Owner's right to reject defective or nonconforming items, or to avail itself of any other remedy to which it may be entitled.

C. Neither observations by an inspector retained by Owner, the presence or absence of such inspector on the site, nor inspections, tests, or approvals by others, shall relieve Contractor from any requirement of the Contract Documents, nor is any such inspector authorized to change any term or condition of the Contract Documents.

D. Contractor shall promptly furnish, without additional charge to Owner, all facilities, labor, material and equipment reasonably needed for performing such safe and convenient inspections and tests as may be required by Owner. Owner may charge Contractor any additional cost of inspection or testing when Work is not ready at the time agreed to by Contractor and Owner for inspection or testing, or when prior rejection makes reinspection or retest necessary. Owner shall attempt to schedule inspections and tests in a manner that will cause no delay in the Work.

5.16 CORRECTION OF NONCONFORMING WORK

A. If a portion of the Work is covered contrary to the requirements of the Contract Documents, it must, if required in writing by Owner, be uncovered for Owner's observation and if found to be nonconforming, it shall be replaced at the Contractor's expense and without change in the Contract Time.

B. If at any time prior to Final Completion Owner desires to examine the Work, or any portion of it, which has been covered, Owner may request to see such Work and it shall be uncovered by Contractor. If such Work is in accordance with the Contract Documents, the Contractor shall

be entitled to an adjustment in the Contract Sum for the actual costs of uncovering and replacement, and, if completion of the Work is thereby delayed, an adjustment in the Contract Time, provided it makes a request as provided in part 7. If such Work is not in accordance with the Contract Documents, the Contractor shall pay the full costs of uncovering and reconstruction in accordance with the Contract Documents.

C. Contractor shall promptly correct Work found by Owner not to conform to the requirements of the Contract Documents, whether observed before or after Substantial Completion. Contractor shall bear all costs of correcting such nonconforming Work, including additional testing and inspections as required.

D. If, within one year after the date of Substantial Completion of the Work or designated portion thereof, or within one year after the date for commencement of any system warranties established under section 6.08, or within the terms of any applicable special warranty required by the Contract Documents, any of the Work that is found to be not in accordance with the requirements of the Contract Documents, Contractor shall correct the Work promptly after receipt of Notice from Owner to do so. Owner shall give such notice within 7 work days after discovery of the condition. This period of one year shall be extended, with respect to portions of Work first performed after Substantial Completion, by the period of time between Substantial Completion and the actual performance of the Work. Contractor's duty to correct with respect to Work repaired or replaced shall run for one year from the date of repair or replacement. Obligations under this paragraph shall survive Final Acceptance.

E. Contractor shall remove from the Project site portions of the Work which were found not in accordance with the requirements of

the Contract Documents and are neither corrected by Contractor nor accepted by Owner.

- F. If Contractor fails to begin correction of nonconforming Work within 15 days after Notice to do so, Owner may replace, correct, or remove the nonconforming Work and charge the full cost thereof to the Contractor.
- G. Contractor shall bear the cost of correcting destroyed or damaged Work, whether completed or partially completed, caused by Contractor's correction or removal of Work which is not in accordance with the requirements of the Contract Documents.
- H. Nothing contained in this section shall be construed to establish a period of limitation with respect to other obligations which Contractor might have according to the Contract Documents. Establishment of the time period of one year as described in paragraph 5.16D relates only to the specific obligation of Contractor to correct the Work, and has no relationship to the time within which the Contractor's obligation to comply with the Contract Documents may be sought to be enforced, including the time within which such proceedings may be commenced.
- I. If Owner prefers to accept Work which is not in accordance with the requirements of the Contract Documents, Owner may do so instead of requiring its removal and correction, in which case the Contract Sum shall be reduced as appropriate and equitable.
- J. This warranty shall not limit the Owner's rights under paragraph 6.09B with respect to latent defects, gross mistakes or fraud.

5.17 SITE ORGANIZATION AND CLEAN UP

Contractor shall at all times keep all Construction areas and Project site areas organized and orderly, including but not limited to hauling routes, infrastructures, utilities, and storage areas free from accumulations of waste materials. Contractor shall remove from the premises during the course of the Work as appropriate and upon completion of the Work, its rubbish, tools, scaffolding, equipment, and unused materials.. Upon completing the Work, Contractor shall leave the Project site in a clean, neat, and orderly condition satisfactory to Owner. If Contractor fails to clean up as provided herein, and after reasonable notice from Owner to do so, Owner may do so and the cost thereof shall be charged to Contractor.

5.18 ACCESS TO WORK AND OCCUPIED RESIDENTIAL UNITS.

- A Contractor shall provide Owner and A/E access to the Work in progress wherever located.
- B. Contractor shall conform to RCW Landlord Tenant Laws relating to accessing occupied residential units. The Owner and resident shall be notified according to RCW 59.18.070; (1) Not more than twenty-four hours, where the defective condition deprives the tenant of hot or cold water, heat, or electricity, or is imminently hazardous to life;

5.19 OTHER CONTRACTS

Owner may undertake or award other contracts for additional work at or near the Project site. Contractor shall cooperate with any other contractors and with Owner's employees and shall carefully adapt scheduling and performance of the Work in accordance with these Contract Documents to reasonably accommodate the other work. Contractor shall promptly notify Owner of unexpected conditions or

circumstances that may hamper Contractor's ability to perform the Work.

5.20 SUBCONTRACTORS AND SUPPLIERS

- A. At the time of each subcontract award, Contractor shall furnish in writing to Owner the names, addresses, telephone numbers, Tax Identification Numbers (TIN) and Unified Business Identifier Numbers (UBI) of all Subcontractors, as well as suppliers providing materials in excess of \$2,500. Contractor shall utilize Subcontractors and suppliers which are experienced and qualified, and meet the requirements of the Contract Documents. Contractor shall not utilize any Subcontractor or supplier to whom the Owner has a reasonable objection, and shall obtain Owner's written consent before making any substitutions or additions.
- B. All Subcontracts must be in writing. By appropriate written agreement, Contractor shall require each Subcontractor, so far as applicable to the Work to be performed by the Subcontractor, to be bound to Contractor by terms of those Contract Documents, and to assume toward Contractor all the obligations and responsibilities which Contractor assumes toward Owner in accordance with the Contract Documents. Each Subcontract shall preserve and protect the rights of Owner in accordance with the Contract Documents with respect to the Work to be performed by the Subcontractor so that subcontracting thereof will not prejudice such rights. Where appropriate, Contractor shall require each Subcontractor to enter into similar agreements with Sub-subcontractors. However, nothing in this paragraph shall be construed to alter the contractual relations between Contractor and its Subcontractors with respect to insurance or bonds.
- C. Contractor shall schedule, supervise, and coordinate the operations of all Subcontractors. No Subcontracting of any of the Work shall relieve Contractor from its responsibility for the performance of the Work or any other obligations in accordance with the Contract Documents.
- D. Each subcontract agreement for a portion of the Work is hereby assigned by Contractor to Owner provided that:
1. The assignment is effective only after termination by Owner for cause pursuant to section 9.01 and only for those Subcontracts which Owner accepts by notifying the Subcontractor in writing; and
 2. After the assignment is effective, Owner will assume all future duties and obligations toward the Subcontractor which Contractor assumed in the Subcontract.
 3. The assignment is subject to the prior rights of the surety, if any, obligated under any bond provided in accordance with the Contract Documents.
- E. The Contractor shall not enter into any subcontract with any subcontractor whose firm or any of its principals have been suspended, debarred, declared ineligible or otherwise excluded from participation in this transaction by any agency of the United States Government or by any state, territory, or municipality. The Contractor will submit a signed certification of compliance with this section for itself and for any of its subcontractors as subcontract agreements are issued and will submit an annual certification of compliance for Contracts extending beyond one year in duration. The Owner will provide the certification form to the Contractor.

5.21 WARRANTY OF CONSTRUCTION

A. Contractor warrants that all Work conforms to the requirements of the Contract Documents and is free of any defect in equipment, material, or design furnished, or workmanship performed by Contractor or Sub Contractors.

B. With respect to all warranties, express or implied, for Work performed or materials furnished according to the Contract Documents, Contractor shall:

1. Obtain all warranties that would be given in normal residential or commercial practice;
2. Require all warranties to be executed, in writing, for the benefit of Owner;
3. Enforce all warranties for the benefit of Owner ; and
4. Be responsible to enforce any subcontractor's, manufacturer's, or supplier's warranty should they extend beyond the period specified in the Contract Documents.

C. Contractor to perform warranty repairs pursuant to RCW 59.18.070: (1) Not more than twenty-four hours, where the defective condition deprives the tenant of hot or cold water, heat, or electricity, or is imminently hazardous to life.

Contractor shall notice the Owner so that proper entry authorization may be arranged by Owner.

D. The obligations under this section may survive Final Acceptance.

5.22 INDEMNIFICATION

A. Contractor shall defend, indemnify, and hold Owner and its officers, agents, and

employees harmless from and against all claims, demands, suits, judgments, losses, damages, costs and any other kinds of expense:

1. Arising out of or in any manner connected with the Work performed or to be performed under this Contract; or
2. Caused or occasioned by the use of any design, process, or equipment which constitutes an infringement of any United States patent presently issued or which violates any other proprietary interest, including copyright, trademark, and trade secret.

This section shall not apply to any claims, demands, suits, judgments, losses, damages, costs or any other kinds of expense that are caused by or result from the sole negligence of the Owner. This section shall apply to all claims, demands, suits, judgments, losses, damages, costs and any other kinds of expense that are caused by or result from the concurrent negligence of the Contractor or its officers, agents, or employees and the Owner or its officers, agents, or employees, but only to the extent of the negligence of the Contractor or its officers, agents, and employees.

B. In any action against Owner or its officers, agents, and employees by any employee of Contractor or any of its subcontractors, the indemnification obligations of Contractor under this section shall not be limited by any limit on the amount or type of damages, compensation, or benefits payable under RCW Title 51 or under any other employee benefit acts. In any such action, Contractor waives any immunity under RCW Title 51 as to Owner and its officers, agents, and employees.

5.23 PROHIBITION AGAINST LIENS

The Contractor is prohibited from placing a lien on the Owner's property. This prohibition shall

apply to all subcontractors of any tier and all materials suppliers.

5.24 OWNER'S REPRESENTATIVE

A. Owner's Representatives. The Owner's Project Coordinator is authorized to act on behalf of the Owner in all matters pertaining to the Work and the Contract Documents. The Owner's Project Coordinator may delegate all or part of this authority to others and will communicate this authorization in writing. No representative or employee of the Owner, other than the Owner's Project Coordinator, shall have authority to obligate the Owner for any purpose unless authorized in writing to do so by the Owner's Project Coordinator. The Owner's Project Coordinator shall have the authority to reject defective material and suspend work that is not consistent with the Contract Documents.

B. Owner's decisions, as delegated to the Owner's Representatives, will be final on all questions including, but not limited to, the following:

1. Quality and acceptability of materials and Work, as specified by the Contract Documents;
2. Measurement of unit price work;
3. Acceptability of rates of progress on the Work; and
4. Interpretation of Drawings and Specifications.

C. The following decisions are the exclusive province of the Owner's Project Coordinator, the Executive Director of Owner, and the Deputy Executive Director of Owner:

1. Determination as to the existence of Material Differing Site Conditions;
2. Fulfillment of the Contract by Contractor;
3. Payments under the Contract;

4. Issuance of a Field Authorization or Change Order; and
5. Adjustment of Critical Milestone Dates
6. Achieving Critical Milestones, Substantial Completion and Final Completion.

5.25 CONFLICTS

In the event of any conflict between the Owner's Project Coordinator and any other Owner's Representative regarding any decision or directive, the Owner's Project Coordinator's decision or directive shall control.

5.26 APPROVAL OF OWNER'S REPRESENTATIVES

Nothing in the Contract requires the Owner's Representatives to provide Contractor with direction or advice on how to do the Work. Although an Owner's Representative may advise Contractor of any faulty work or materials, or infringements of the terms of the Contract Documents, failure of any Owner's Representative to do so shall not constitute acceptance or approval. If an Owner's Representative approves or recommends any method or manner for doing the Work or producing materials, the approval or recommendation shall not:

- A. Constitute a representation that following the method or manner employed by Contractor will result in compliance with the Contract,
- B. Relieve Contractor or its Surety of any risks or obligations under the Contract, or
- C. Create any liability for Owner.

5.27 ORAL AGREEMENTS

No oral agreement or conversation with any officer, agent, or employee of Owner, either before or after execution of the Contract, shall affect or modify any of the terms or obligations

contained in any of the documents comprising the Contract. Such oral agreement or conversation shall be considered as unofficial information and in no way binding upon Owner or Contractor unless subsequently put in writing.

PART 6 - PAYMENTS AND COMPLETION

6.01 CONTRACT SUM

Owner shall pay Contractor the Contract Sum for performance of the Work, in accordance with the Contract Documents. The Contract Sum shall include all taxes imposed by law and properly chargeable to the Project, including sales tax.

6.02 SCHEDULE OF VALUES

Within 7 days of Notice of Award the Contractor shall submit to Owner for approval a detailed breakdown allocating the total Contract Sum to each principle category of work, in such detail as requested by Owner ("Schedule of Values"). The approved Schedule of Values shall include appropriate amounts for demobilization, punchlists, record drawings, Operating & Maintenance manuals, warranties, as-built drawings and any other requirements for Project closeout in the Contract Documents. This shall be used by Owner as the sole basis for progress payments. The Contractor shall prorate its overhead and profit over the construction period of the contract. Payment for Work shall be made only for and in accordance with those items included in the approved Schedule of Values.

6.03 APPLICATION FOR PAYMENT

A. At monthly intervals, unless determined otherwise by Owner, Contractor shall submit to Owner an itemized Application for Payment for Work completed in accordance with the Contract Documents and the approved Schedule of Values. Each application shall be supported by such substantiating data as Owner may require.

- B. By submitting an Application for Payment, Contractor is certifying that all Subcontractors have been paid, less earned retainage in accordance with RCW 60.28.011, as their interests appeared in the last preceding certificate of payment. By submitting an Application for Payment, Contractor is recertifying that the representations set forth in section 1.03 are true and correct, to the best of Contractor's knowledge, as of the date of the Application for Payment.
- C. At the time Contractor submits an Application for Payment, Contractor shall analyze and reconcile, to the satisfaction of Owner, the actual progress of the Work on the Progress Schedule.
- D. If authorized by Owner, the Application for Payment may include a request for payment for material delivered to the Project site and suitably stored. Contractor is at all times fully responsible for any materials stored on site and not yet installed. Payment may similarly be requested for material stored off the Project site, provided Contractor complies with or furnishes satisfactory evidence of the following:
1. The material will be placed in a warehouse that is structurally sound, dry, lighted and suitable for the materials to be stored;
 2. The warehouse is located within a 10-mile radius of the Project. Other locations may be utilized, if approved in writing, by Owner;
 3. Only materials for the Project are stored within the warehouse (or a secure portion of a warehouse set aside for the Project);
 4. Contractor furnishes Owner a certificate of insurance extending Contractor's insurance coverage for

damage, fire, and theft to cover the full value of all materials stored, or in transit;

5. The warehouse (or secure portion thereof) is continuously under lock and key, and only Contractor's authorized personnel shall have access;
6. Owner shall at all times have the right of access in company of Contractor;
7. Contractor and its surety assume total responsibility for the stored materials; and
8. Contractor furnishes to Owner certified lists of materials stored, bills of lading, invoices, and other information as may be required, and shall also furnish notice to Owner when materials are moved from storage to the Project site.

6.04 PROGRESS PAYMENTS

- A. Owner shall make progress payments, in such amounts as Owner and any funding/lending agents determine are properly due, within 30 Days from date of Owner approval of a properly executed Application for Payment. Owner shall notify Contractor in accordance with RCW 39.76 if the Application for Payment does not comply with the requirements of the Contract Documents.
- B. Owner shall retain 5% of the amount of each progress payment until no less than 45 days after Final Acceptance and receipt of all documents required by law or the Contract Documents including, at Owner's request, consent of surety to release the retainage. In accordance with RCW 60.28, Contractor may request that monies reserved be retained in a fund by Owner, deposited by Owner in a bank or savings and loan, or placed in escrow with a bank or trust company to be converted into bonds and securities to be held in

escrow with interest to be paid to Contractor. Owner may permit Contractor to provide an appropriate bond in lieu of the retained funds.

- C. Title to all Work and materials covered by a progress payment shall pass to Owner at the time of such payment free and clear of all liens, claims, security interests, and encumbrances. Passage of title shall not, however, relieve Contractor from any of its duties and responsibilities for the Work or materials, or waive any rights of Owner to insist on full compliance by Contractor with the Contract Documents.
- D. Payments due and unpaid in accordance with the Contract Documents shall bear interest as specified in RCW 39.76 to the same extent as if the Work was a "public work" as defined in that statute.
- E. Method of Payment: Unless the Owner has granted a waiver, for contracts of one million or more, the Contractor's payments will be made electronically through a credit card issued by the Owner's banking services provider as part of its e-payables program. The application for payment and Owner's review of the Contractor's progress payments shall remain unchanged by this method of payment. For all other contracts, SHA strongly encourages enrollment in the program.

6.05 PAYMENTS WITHHELD

- A. Owner may withhold or, on account of subsequently discovered evidence, nullify the whole or part of any payment to such extent as may be necessary to protect Owner from loss or damage for reasons including but not limited to:
 1. Work not in accordance with the Contract Documents;
 2. Reasonable evidence that the Work required by the Contract Documents

cannot be completed for the unpaid balance of the Contract Sum;

3. Work by Owner to correct defective Work or complete the Work in accordance with section 5.16;
4. Failure to perform in accordance with the Contract Documents; or
5. Cost or liability that may occur to Owner as the result of Contractor's fault or negligent acts or omissions.

- B. In any case where part or all of a payment is going to be withheld for unsatisfactory performance, Owner shall notify Contractor in accordance with RCW 39.76.

6.06 RETAINAGE AND BOND CLAIM RIGHTS

RCW chapters 39.08 and 60.28, concerning the rights and responsibilities of Contractor and Owner with regard to the performance and payment bonds and retainage, are made a part of the Contract Documents by reference as though fully set forth herein, and to the same extent as if the work was a "public work" and/or "public improvement" as defined in those statutes.

6.07 SUBSTANTIAL COMPLETION

Substantial Completion is the stage in the progress of the Work (or portion thereof designated and approved by Owner) when the construction is sufficiently complete, in accordance with the Contract Documents, so Owner can fully occupy the Work (or the designated portion thereof) for the use for which it is intended. All Work other than incidental corrective or punch list work shall have been completed. Before requesting Substantial Completion, the Contractor shall furnish the Owner, a comprehensive punchlist of items of work remaining to be performed or intended to be corrected by the Contractor on the portion of work the Contractor intends to

turnover to the Owner and the dates the remaining items on the list are to be completed. Substantial Completion shall not be achieved if any system(s) and part(s) are not fully commissioned, fully tested or fully functional at the time of acceptance by Owner; if utilities, appliances are not connected; or documentation has been provided to the Owner and proven to conform per the Contract Documents and operating normally as intended or; if all required occupancy permits have not been issued; or if the Work is not accessible by normal vehicular and pedestrian traffic routes. The date Substantial Completion is achieved shall be established in writing by Owner after a written request is submitted by Contractor.

6.08 PRIOR OCCUPANCY

- A. Owner may, upon Notice to Contractor, take possession of or use any completed or partially completed portion of the Work ("Prior Occupancy") at any time prior to Substantial Completion. Unless otherwise agreed in writing, Prior Occupancy shall not: be deemed an acceptance or constitute Substantial Completion of any portion of the Work; accelerate the time for any payment to Contractor; prejudice any rights of Owner provided by any insurance, bond, guaranty, or the Contract Documents; relieve Contractor of the risk of loss or any of the obligations established by the Contract Documents; establish a date for termination or partial termination of the assessment of liquidated damages; or constitute a waiver of claims.
- B. Notwithstanding anything in the preceding paragraph, Owner shall be responsible for loss of or damage to the Work resulting from its Prior Occupancy. Contractor's one year duty to repair and any system warranties shall begin on building systems activated and used by Owner as agreed in writing by Owner and Contractor.
- C. Before taking Prior Occupancy possession of or using any work, the

Owner shall furnish the Contractor a list of items of work remaining to be performed or corrected on those portions of the work that Owner intends to take possession of or use. However, failure of the Owner to list any item of work shall not relieve the Contractor of responsibility for complying with the terms of the contract.

6.09 FINAL COMPLETION, ACCEPTANCE, AND PAYMENT

- A. Final Completion shall be achieved when the Work is fully and finally complete in accordance with the Contract Documents. The date Final Completion is achieved shall be established by Owner in writing.
- B. Contractor shall request Final Acceptance from Owner. Final Acceptance is the formal action of Owner acknowledging Final Completion of the Work. Acceptance shall be final and conclusive except for latent defects, fraud, gross mistakes amounting to fraud, or the Owner's rights under any warranty or guarantee. Prior to Final Acceptance, Contractor shall, in addition to all other requirements in the Contract Documents, submit to Owner a Notice of any outstanding disputes or claims between Contractor and any of its Subcontractors, including the amounts and other details thereof. Neither Final Acceptance, nor final payment, shall release Contractor or its sureties from any obligations of these Contract Documents or the Public Works Bond, or constitute a waiver of any claims by Owner arising from Contractor's failure to perform the Work in accordance with the Contract Documents.
- C. Acceptance of final payment by Contractor, or any Subcontractor, shall constitute a waiver and release to Owner of all claims by Contractor, or any such Subcontractor, for an increase in the Contract Sum or the Contract Time, and for every act or omission of Owner relating to or arising out of the Work, except for

those Claims made in accordance with the procedures, including the time limits, set forth in part 8.

PART 7 - CHANGES

7.01 CHANGES IN THE WORK

- A. Owner may, at any time and without notice to Contractor's surety, order additions, deletions, revisions, or other changes in the Work. These changes in the Work shall be incorporated into the Contract Documents through the execution of Change Orders. If any change in the Work ordered by Owner causes an increase or decrease in the Contract Sum or the Contract Time, an equitable adjustment shall be made as provided in section 7.02 or 7.03, respectively, and such adjustment(s) shall be incorporated into a Change Order.
- B. If Owner desires to order a change in the Work, the Owner may request a written Change Order Proposal (COP) from Contractor. Contractor shall submit a Change Order Proposal within 14 Days of the request from Owner, or within such other period as mutually agreed. Contractor's Change Order Proposal shall be full compensation for implementing the proposed change in the Work, including any adjustment in the Contract Sum or Contract Time, and including compensation for all delays in connection with such change in the Work and for any expense or inconvenience, disruption of schedule, or loss of efficiency or productivity that may result from the change in the Work.
- C. Upon receipt of the Change Order Proposal, or a request for equitable adjustment in the Contract Sum or Contract Time, or both, as provided in sections 7.02 and 7.03, Owner may accept or reject the proposal, request further documentation, or negotiate acceptable terms with Contractor.

Pending agreement on the terms of the Change Order Proposal, Owner may direct Contractor to proceed immediately with the Change Order Proposal Work. Contractor shall proceed with any change in the Work only after it has obtained Owner's approval. All Work done pursuant to any Owner-directed change in the Work shall be executed in accordance with the Contract Documents.

- D. If Owner and Contractor reach agreement on the terms of any change in the Work, including any adjustment in the Contract Sum or Contract Time, such agreement shall be incorporated in a Change Order. The Change Order shall constitute full payment and final settlement of all claims for time and for direct, indirect, and consequential costs, including costs of delays, inconvenience, disruption of schedule, or loss of efficiency or productivity, related to any Work either covered or affected by the Change Order, or related to the events giving rise to the request for equitable adjustment.
- E. If Owner and Contractor are unable to reach agreement on the terms of any change in the Work, including any adjustment in the Contract Sum or Contract Time, Contractor may in writing, request a final offer from Owner. Owner shall provide Contractor with its written response within 14 Days of Contractor's request. Owner may also provide Contractor with a final offer at any time. If Contractor rejects Owner's final offer, or the parties are otherwise unable to reach agreement, Contractor's only remedy shall be to file a Claim as provided in part 8.

7.02 CHANGES IN THE CONTRACT SUM

A. General Application

- 1. The Contract Sum shall only be changed by a Change Order. Contractor shall include any request

for a change in the Contract Sum in its Change Order Proposal.

- 2. If the cost of Contractor's performance is changed due to the fault or negligence of Owner, or anyone for whose acts Owner is responsible, Contractor shall be entitled to make a request for an equitable adjustment in the Contract Sum in accordance with the following procedure. No change in the Contract Sum shall be allowed to the extent: Contractor's changed cost of performance is due to the fault or negligence of Contractor, or anyone for whose acts Contractor is responsible; the change is concurrently caused by Contractor and Owner; or the change is caused by an act of Force Majeure as defined in Section 3.05.
 - a. A request for an equitable adjustment in the Contract Sum shall be based on a written Notice delivered to Owner within 7 Days of the occurrence of the event giving rise to the request. For purposes of this part, "occurrence" means when Contractor knew, or in its diligent prosecution of the Work should have known, of the event giving rise to the request. If Contractor believes it is entitled to an adjustment in the Contract Sum, Contractor shall immediately notify Owner in writing and begin to keep and maintain complete, accurate, and specific daily records including photographs, daily logs, accounting of labor, materials and equipment associated with the occurrence. Contractor shall give Owner access to any such records and, if requested shall promptly furnish copies of such records to Owner.
 - b. Contractor shall not be entitled to any adjustment in the Contract

Sum for any occurrence of events or costs that occurred more than 7 Days before Contractor's written Notice to Owner. The Notice shall provide, at a minimum: a description of the event giving rise to the request for an equitable adjustment in the Contract Sum; the nature of the impacts to Contractor and its Subcontractors of any tier, and to the extent possible the full amount of the adjustment in Contract Sum requested. Failure to provide a timely written notice with this information shall, to the extent Owner's interests are prejudiced, constitute a waiver of Contractor's right to an equitable adjustment. Owner's interests are prejudiced, for example, if Owner receives knowledge of facts after Owner incurs costs that could have been avoided or reduced if the notice had been timely. In this case, Contractor shall receive an equitable adjustment if otherwise entitled to it, less the costs incurred. A separate Notice must accompany each request for equitable adjustment. If Owner approval of equitable adjustment has been granted, the correspondence containing such approval shall accompany the request for equitable adjustment. Owner must approve all requests for equitable adjustments before any Change Order is executed.

- c. Within 30 Days of the occurrence of the event giving rise to the request, Owner may allow an additional period of time to ascertain more accurate data unless Owner agrees to the initial Change Order Proposal in writing,. Contractor shall supplement Notice provided in accordance with subparagraph a. above with

additional supporting data. Such additional data shall include, at a minimum: the amount of compensation requested, itemized in accordance with the procedure set forth herein; specific facts, circumstances, and analysis that confirms not only that Contractor suffered the damages claimed, but that the damages claimed were actually a result of the act, event, or condition complained of and that the Contract Documents provide entitlement to an equitable adjustment to Contractor for such act, event, or condition; and documentation sufficiently detailed to permit an informed analysis of the request by Owner. When the request for compensation relates to a delay, or other change in Contract Time, Contractor shall demonstrate the impact on the critical path schedule, in accordance with section 7.03C. Failure to provide such additional information and documentation within the time allowed or within the format required shall, to the extent Owner's interests are prejudiced, constitute a waiver of Contractor's right to an equitable adjustment. Owner's interests are prejudiced, for example,

- (1) If Owner is deprived of full knowledge of all material facts needed to verify the request or make an informed decision on Contractor's request; or
- (2) If Owner receives knowledge of facts after Owner incurs costs that could have been avoided if the notice had been timely. In this case, Contractor shall receive an equitable adjustment only if otherwise entitled to it, less the costs incurred.

d. Pending final resolution of any request made in accordance with this paragraph, unless otherwise agreed in writing, Contractor shall proceed diligently with performance of the Work.

e. Any requests by Contractor for an equitable adjustment in the Contract Sum and in the Contract Time that arise out of the same event(s) shall be submitted together. Failure to do so constitutes a waiver of Contractor's right to an equitable adjustment.

3. The value of any Work covered by a Change Order Proposal, or of any request for an equitable adjustment in the Contract Sum, shall be determined by one of the following methods:

a. On the basis of a fixed price as determined in paragraph 7.02B.

b. By application of unit prices to the quantities of the items involved as determined in paragraph 7.02C.

4. When Owner has requested Contractor to submit a Change Order Proposal, Owner may direct Contractor as to which method in subparagraph 3. above to use when submitting its proposal. Otherwise, Contractor shall determine the value of the Work, or of a request for an equitable adjustment, on the basis of the fixed price method.

B. Change Order Pricing -- Fixed Price

When the fixed price method is used to determine the value of any Work covered by a Change Order, or of a request for an equitable adjustment in the Contract Sum, the following procedures shall apply:

1. Contractor's Change Order Proposal, or request for adjustment in the

Contract Sum, shall be accompanied by a complete itemization of the costs, including labor, material, subcontractor costs, and overhead and profit. The costs shall be itemized in the manner set forth below, and shall be submitted on breakdown sheets in a form approved by Owner.

2. All costs shall be calculated based upon appropriate industry standard methods of calculating current Contractor labor rates for the Project and local material prices and local equipment costs.

3. If any of Contractor's pricing assumptions are contingent upon anticipated actions of Owner, Contractor shall clearly state them in the proposal or request for an equitable adjustment.

4. The cost of any additive or deductive changes in the Work shall be calculated as set forth below, except that overhead and profit shall not be included on deductive changes in the Work. Where a change in the Work involves additive and deductive work by the same Contractor or Subcontractor, small tools, overhead, profit, bond and insurance markups will apply to the net difference.

5. If the total cost of the change in the Work or request for equitable adjustment does not exceed \$2,500, Contractor may submit a breakdown in the following level of detail if the description of the change in the Work or if the request for equitable adjustment is sufficiently definitive to permit the Owner to determine fair value:

a. lump sum labor;

b. lump sum material;

- c. lump sum equipment usage;
 - d. overhead and profit as set forth below; and
 - e. insurance and bond costs as set forth below.
6. Any request for adjustment of Contract Sum based upon the fixed price method shall include only the following items:
- a. Craft labor costs: These are the labor costs determined by multiplying the estimated or actual additional number of craft hours needed to perform the change in the Work by the hourly labor costs. Craft hours should cover direct labor, as well as indirect labor due to trade inefficiencies. The hourly costs shall be based on the following:
 - (1) Basic wages and benefits: Hourly rates and benefits according to applicable prevailing wages. Direct supervision shall be a reasonable percentage not to exceed 15% of the cost of direct labor. No supervision markup shall be allowed for a working supervisor's hours.
 - (2) Worker's insurance: Direct contributions to the state of Washington for industrial insurance; medical aid; and supplemental pension, by the class and rates established by the State Department of Labor and Industries.
 - (3) Federal insurance: Direct contributions required by the Federal Insurance Compensation Act; Federal Unemployment Tax Act; and
 - b. Material costs: This is an itemization of the quantity and cost of materials needed to perform the change in the Work. Material costs shall be developed first from actual known costs, second from supplier quotations or if these are not available, from standard industry pricing guides for the local area. Material costs shall consider all available discounts. Freight costs, express charges, or special delivery charges, shall be itemized.
 - c. Equipment costs: This is an itemization of the type of equipment and the estimated or actual length of time the construction equipment appropriate for the Work is or will be used on the change in the Work. Costs will be allowed for construction equipment only if used entirely and exclusively for the changed Work, or for additional rental costs actually incurred by the Contractor. Equipment charges shall be computed on the basis of actual invoice costs or if owned, from the current edition of one of the following sources in the order in which they are listed:
 - (1) Associated General Contractors - Washington State Department of Transportation Equipment Rental Agreement; latest edition;
- the State Unemployment Compensation Act.
- (4) Safety: Cost incurred due to the Washington Industrial Safety and Health Act, which shall be a reasonable percentage not to exceed 2% of the sum of the amounts calculated in (1), (2), and (3) above.

- (2) The state of Washington Utilities and Transportation Commission for trucks used on highways.
- (3) The National Electrical Contractors Association for equipment used on electrical work.
- (4) The Mechanical Contractors Association of America for equipment used on mechanical work.

The most recent edition of the Data Quest Rental Rate (Blue Book) shall be used as a basis for establishing rental rates of equipment not listed in the above sources. The maximum rate for standby equipment shall not exceed that shown in the AGC WSDOT Equipment Rental Agreement, latest edition.

- d. Allowance for small tools, expendables & consumable supplies: Small tools consist of tools which cost \$250 or less and are normally furnished by the performing contractor. The maximum rate for small tools shall not exceed the following:

- (1) For Contractor, 3% of direct labor costs.
- (2) For Subcontractors, 5% of direct labor costs.

Expendables and consumable supplies directly associated with the change in Work must be itemized.

- e. Subcontractor costs: This is defined as payments Contractor makes to Subcontractors for changed Work performed by

Subcontractors of any tier. The Subcontractors' cost of Work shall be calculated and itemized in the same manner as prescribed herein for Contractor.

- f. Allowance for overhead: This is defined as costs of any kind attributable to direct and indirect delay, acceleration, or impact, added to the total cost to Owner of any change in the Contract Sum but not to the cost of any change in the Contract Time for which contractor has been, or could have been (had contractor filed a sufficient, timely claim), compensated pursuant to the conditions set forth in Section 7.03. This allowance shall compensate Contractor for all noncraft labor, temporary construction facilities, field engineering, schedule updating, as-built drawings, home office cost, B&O taxes, office engineering, estimating costs, additional overhead because of extended time, and any other cost incidental to the change in the Work. It shall be strictly limited in all cases to a reasonable amount, mutually acceptable, or if none can be agreed upon to an amount not to exceed the rates below:

- (1) For Contractor, for any Work actually performed by Contractor's own forces, 10% of the cost.
- (2) For each Subcontractor (including lower tier subcontractors), for any Work actually performed by its own forces, 10% of the cost.
- (3) For Contractor, for any Work performed by its Subcontractor(s), no additional percentage allowance.

- (4) For each Subcontractor, for any Work performed by its Subcontractor(s) of any lower tier, no additional percentage allowance.
- (5) The cost to which overhead is to be applied shall be determined in accordance with subparagraphs a.-e. above.
- g. Allowance for profit: This is an amount to be added to the cost of any change in contract sum, but not to the cost of change in Contract Time for which contractor has been, or could have been (had contractor filed a sufficient, timely claim), compensated pursuant to the conditions set forth in section 7.03. It shall be limited to a reasonable amount, mutually acceptable, or if none can be agreed upon, to an amount not to exceed the rates below:
- (1) For Contractor or Subcontractor of any tier for work performed by their forces, 5% of the cost developed in accordance with 7.02B.6a.- e. above.
- (2) For Contractor for work performed by its Subcontractor(s), 10% of the Subcontractor cost developed in accordance with 7.02B.6a. – e, less the Subcontractor(s)' profit.
- (3) For Subcontractors of any tier for work performed by a subcontractor of a lower tier, no additional percentage allowance.
- h. Cost of change in insurance or bond premium: This is defined as:
- (1) Contractor's liability insurance: The cost of any changes in Contractor's liability insurance arising directly from execution of the changed Work;
- (2) Public works bond(s): The cost of the additional premium for Contractor's bond arising directly from the changed Work.
- The costs of any change in insurance or bond premium shall be added after overhead and profit are calculated in accordance with subparagraphs f. and g. above.
- C. Change Order Pricing -- Unit Prices
1. If Owner authorizes Contractor to perform Work on a unit-price basis, Owner's authorization shall clearly state:
- a. Scope of work to be performed;
- b. Type of reimbursement including pre-agreed rates for material quantities; and
- c. Cost limit of reimbursement.
2. Contractor shall:
- a. Cooperate with Owner and assist in monitoring the Work being performed. As requested by Owner, Contractor shall identify workers assigned to the Change Order Work and areas in which they are working;
- b. Leave access as appropriate for quantity measurement; and
- c. Not exceed any cost limit(s) without Owner's prior written approval.
3. Contractor shall submit costs in accordance with paragraph 7.02B. and satisfy the following requirements:
- a. Unit prices shall include reimbursement for all direct and

indirect costs of the Work, including but not limited to: overhead and profit, general conditions, supervision, safety, small tools and bond and insurance costs; and

- b. Quantities must be supported by field measurement statements signed by Owner.

7.03 CHANGES IN THE CONTRACT TIME

- A. The Contract Time shall only be changed by a Change Order. Contractor shall include any request for a change in the Contract Time in its Change Order Proposal.
- B. If the time of Contractor's performance is changed due to an act of Force Majeure, or due to the fault or negligence of Owner or anyone for whose acts Owner is responsible, Contractor shall be entitled to make a request for an equitable adjustment in the Contract Time in accordance with the following procedure. No adjustment in the Contract Time shall be allowed to the extent Contractor's changed time of performance is due to the fault or negligence of Contractor, or anyone for whose acts Contractor is responsible.
 - 1. A Contractor's request for an equitable adjustment in the Contract Time shall be based on Notice delivered to Owner within 7 Days of the occurrence of the event giving rise to the request. If Contractor believes it is entitled to adjustment of Contract Time, Contractor shall immediately begin to keep and maintain complete, accurate, and specific daily records including photographs, and track daily loss of productivity specific to the established critical path schedule in sufficient detail as to fully document the claim. Contractor shall give Owner access to any such record and, if requested,

shall promptly furnish copies of such record to Owner.

- 2. Contractor shall not be entitled to an adjustment in the Contract Time for any events that occurred more than 7 Days before Contractor's Notice to Owner. The Notice shall provide, at a minimum: a description of the event giving rise to the request for an equitable adjustment in the Contract Time; the nature of the impacts to Contractor and its Subcontractors of any tier, if any; and to the extent possible the amount of the adjustment in Contract Time requested. Failure to provide this information in the Notice shall, to the extent Owner's interests are prejudiced, constitute a waiver of Contractor's right to an equitable adjustment. Owner's interests are prejudiced, for example, if Owner receives knowledge of facts after the Work incurs delay that could have been avoided if the notice had been timely. In this case, Contractor shall receive an equitable adjustment if otherwise entitled to it, less the delay incurred.
- 3. Within 30 Days of the occurrence of the event giving rise to the request, unless Owner agrees in writing to allow an additional period of time to ascertain more accurate data, Contractor shall supplement the Notice provided in accordance with subparagraph 7.03B.2 with additional supporting data. Such additional data shall include, at a minimum: the amount of delay claimed, itemized in accordance with the procedure set forth herein; specific facts, circumstances, and analysis that confirms not only that Contractor suffered the delay claimed, but that the delay claimed was actually a result of the act, event, or condition complained of, and that the Contract Documents provide entitlement to an equitable

adjustment in Contract Time for such act, event, or condition; and supporting documentation sufficiently detailed to permit an informed analysis of the request by Owner. Failure to provide such additional information and documentation within the time allowed or within the format required shall, to the extent Owner's interests are prejudiced, constitute a waiver of Contractor's right to an equitable adjustment. Owner's interests are prejudiced, for example,

- a. If Owner is deprived of full knowledge of all material facts needed to make an informed decision on Contractor's request; or
- b. If Owner receives knowledge of facts after the Work incurs delay that could have been avoided if the notice had been timely. In this case, Contractor shall receive an equitable adjustment if otherwise entitled to it, less the delay incurred.

4. Pending final resolution of any request in accordance with this paragraph, unless otherwise agreed in writing, Contractor shall proceed diligently with performance of the Work.

C. Any change in the Contract Time covered by a Change Order, or based on a request for an equitable adjustment in the Contract Time, shall be limited to the change in the critical path of Contractor's schedule attributable to the change of Work or event(s) giving rise to the request for equitable adjustment. Any Change Order proposal or request for an adjustment in the Contract Time shall demonstrate the impact on the critical path of the schedule. Contractor shall be responsible for showing clearly on the Progress Schedule that the change or event: had a specific impact on the critical path, and except in

case of concurrent delay, was the sole cause of such impact; and could not have been avoided by resequencing of the Work or other reasonable alternatives.

D. Contractor may request compensation for the cost of a change in Contract Time in accordance with this paragraph 7.03D, subject to the following conditions:

1. The change in Contract Time shall solely be substantiated as caused by the fault or negligence of Owner or anyone for whose acts Owner is responsible;
2. Compensation under this paragraph is limited to changes in Contract Time for which Contractor is not entitled to be compensated under section 7.02;
3. Contractor shall follow the procedure set forth in paragraph 7.03B;
4. Contractor shall establish the extent of the change in Contract Time in accordance with paragraph 7.03C; and
5. The daily cost of any change in Contract Time shall be limited to the items below, less funds that may, or could (had contractor filed a sufficient, timely claim), have been paid pursuant to a change in the Contract Sum that contributed to this change in Contract Time:
 - a. cost of nonproductive field supervision or labor extended because of the delay;
 - b. cost of weekly meetings or similar indirect activities extended because of the delay;
 - c. cost of temporary facilities or equipment rental extended because of the delay;

- d. cost of insurance extended because of the delay;
 - e. general and administrative overhead in an amount to be agreed upon, but not to exceed 3% of Contract Sum divided by the Contract Time for each Day of the delay.
- 2. The date on which facts arose which gave rise to the Claim;
 - 3. The name of each employee of Owner or A/E knowledgeable about the Claim;
 - 4. The specific provisions of the Contract Documents which support the Claim;
 - 5. The identification of any documents and the substance of any written communications that support the Claim;
 - 6. Copies of any identified documents, other than the Contract Documents, that support the Claim;
 - 7. If an adjustment in the Contract Time is sought: the specific Days and dates for which it is sought; the specific reasons Contractor believes an extension in the Contract Time should be granted; and Contractor's analysis of its Progress Schedule to demonstrate the reason for the extension in Contract Time;
 - 8. If an adjustment in the Contract Sum is sought, the exact amount sought and a breakdown of that amount into the categories set forth in, and in the detail required by, section 7.02; and
 - 9. A statement certifying, under penalty of perjury, that the Claim is made in good faith, that the supporting cost and pricing data are true and accurate to the best of Contractor's knowledge and belief, that the Claim is fully supported by the accompanying data, and that the amount requested accurately reflects the adjustment in the Contract Sum or Contract Time for which Contractor believes Owner is liable.

PART 8 - CLAIMS AND DISPUTE RESOLUTION

8.01 CLAIMS PROCEDURE

- A. Except as otherwise provided in paragraph 5.04C or paragraph 11.12H, whichever is applicable, if the parties fail to reach agreement regarding any dispute arising from the Contract Documents, including a failure to reach agreement on the terms of any Change Order for Owner-directed Work as provided in section 7.01, or on the resolution of any request for an equitable adjustment in the Contract Sum as provided in section 7.02 or the Contract Time as provided in section 7.03, Contractor's only remedy shall be to file a Claim with Owner as provided in this section.
- B. Contractor shall file its Claim within the earlier of 120 Days from Owner's final offer in accordance with paragraph 7.01E; or the date of Final Acceptance.
- C. The Claim shall be deemed to cover all changes in cost and time (including direct, indirect, impact, and consequential) to which Contractor may be entitled. It shall be fully substantiated and documented. At a minimum, the Claim shall contain the following information:
 - 1. A detailed factual statement of the Claim for additional compensation and time, if any, providing all necessary dates, locations, and items of Work affected by the Claim;
- D. After Contractor has submitted a fully-documented Claim that complies with all applicable provisions of parts 7 and 8,

Owner shall respond, in writing, to Contractor with a decision within 60 Days from the date the Claim is received, or with notice to Contractor of the date by which it will render its decision.

- E. To assist in the review of Contractor's Claim, Owner may visit the Project site, or request additional information, in order to fully evaluate the issues raised by the Claim. Contractor shall proceed with performance of the Work pending final resolution of any Claim. Owner's written decision as set forth above shall be final and conclusive as to all matters set forth in the Claim, unless Contractor follows the procedure set forth in section 8.02.
- F. Any Claim of the Contractor against the Owner for damages, additional compensation, or additional time, shall be conclusively deemed to have been waived by the Contractor unless timely made in accordance with the requirements of this section.

8.02 DISPUTE RESOLUTION

- A. All Claims arising out of the Work shall be attempted to be resolved by both parties in good faith. If Contractor disagrees with Owner's decision rendered in accordance with paragraph 8.01D Contractor shall provide Owner with a written request for Dispute Resolution. No request for Dispute Resolution of any such Claim shall be made later than 30 Days after the receipt date of Owner's decision on such Claim; failure to request Dispute Resolution within said 30 Day period shall result in Owner's decision being final and binding upon Contractor and its Subcontractors. All other rights to equitable adjustment from this point are deemed waived.
- B. Notice of the request for Dispute Resolution shall contain all claims Contractor has against Owner and state the Contractor's specific disagreement with the Owner's decision. Within ten business

days of receipt of Contractor's Notice of Request for Dispute Resolution, Owner shall advise Contractor whether the dispute will be resolved by mediation, arbitration or litigation. If the dispute is to be mediated, the parties shall mediate under the then current Construction Industry Mediation Rules of the AAA. If the parties do not agree to another location, the mediation shall take place in Seattle, Washington.

- C. Claims between Owner and Contractor, Contractor and its Subcontractors, Contractor and A/E, and Owner and A/E shall be submitted in the same mediation.
- D. If the parties resolve the Claim(s) prior to a mediation decision, the terms of their agreement shall be incorporated in a Change Order. The Change Order shall constitute full payment and final settlement of the Claim(s), including all claims for time and for direct, indirect, or consequential costs, including costs of delays, inconvenience, disruption of schedule, or loss of efficiency or productivity.
- E. If any Claim is not resolved through mediation, Owner may elect to have the disputed claim(s) resolved through arbitration or litigation. Owner shall within ten working days of conclusion of the mediation, inform Contractor of its election to proceed with arbitration or litigation.

8.03 ARBITRATION

If Owner elects to have the dispute resolved through arbitration, Contractor shall file a notice, of Demand for Arbitration with the American Arbitration Association (AAA), with a copy provided to Owner, in accordance with the Construction Industry Arbitration Rules of AAA as follows:

1. Claims involving \$75,000 or less, exclusive of claimed interest, attorney's fees, arbitration fees and

costs shall be conducted in accordance with the AAA Fast Track Procedures

2. Disputes over \$75,000 shall be conducted in accordance with the AAA Procedures for Large Complex Construction Disputes unless the parties agree to use the expedited rules.

3. For disputes conducted according to this section, notwithstanding any contrary provision of the referenced rules,

a. the arbitrator shall determine the rights and obligations of the parties according to the substantive and procedural laws of Washington;

b. The obligations of Contractor under section 8.05 shall continue and shall not be affected;

c. the arbitrator shall be an attorney with at least 10 years experience in construction law;

d. the arbitrator shall issue a written decision setting out: a) each of the findings of facts; b) the evidence supporting each finding of fact; c) a statement of the applicable law; and d) an explanation of how the arbitrator applied the law to those facts;

e. if the parties do not agree to another location, the arbitration proceedings shall be conducted in Seattle, Washington.

C. The judgment upon the arbitration award may be entered, or review of the award may occur, in the court having jurisdiction thereof. No independent legal action relating to or arising from the Work shall be maintained.

D. Claims between Owner and Contractor, Contractor and its Subcontractors, Contractor and A/E, and Owner and A/E shall be submitted in the same arbitration.

E. If the parties resolve the Claim prior to an arbitration award, the terms of the party's agreement shall be incorporated in a Change Order. The Change Order shall constitute full payment and final settlement of the Claim, including all claims for time and for direct, indirect, or consequential costs, including costs of delays, inconvenience, disruption of schedule, or loss of efficiency or productivity.

8.04 LITIGATION

If Owner elects to resolve the dispute through litigation, Contractor shall file suit in a court of competent jurisdiction in the City of Seattle.

8.05 CLAIMS AUDITS

A. All Claims filed against Owner shall be subject to audit at any time following the filing of the Claim. Failure of Contractor, or Subcontractors of any tier, to maintain and retain sufficient records to allow Owner to verify all or a portion of the Claim or to permit Owner access to the books and records of Contractor, or Subcontractors of any tier, shall constitute a waiver of the Claim and shall bar any recovery.

B. In support of Owner audit of any Claim, Contractor shall, upon request, promptly make available to Owner the following documents:

1. Daily time sheets and supervisor's daily reports;

2. Collective bargaining agreements;

3. Insurance, welfare, and benefits records;

4. Payroll registers; maintained by the company involved, its accountant, or others;
 5. Earnings records;
 6. Payroll tax forms;
 7. Material invoices, requisitions, and delivery confirmations;
 8. Material cost distribution worksheet;
 9. Equipment records (list of company equipment, rates, etc.);
 10. Vendors', rental agencies', Subcontractors', and agents' invoices;
 11. Contracts between Contractor and each of its Subcontractors, and all lower-tier Subcontractor contracts and supplier contracts;
 12. Subcontractors' and agents' payment certificates;
 13. Cancelled checks (payroll and vendors);
 14. Job cost report, including monthly totals;
 15. Job payroll ledger;
 16. Planned resource loading schedules and summaries;
 17. General ledger;
 18. Cash disbursements journal;
 19. Financial statements for all years reflecting the operations on the Work. In addition, the Owner may require, if it deems it appropriate, additional financial statements for 3 years preceding execution of the Work;
 20. Depreciation records on all company equipment whether these records are
 21. If a source other than depreciation records is used to develop costs for Contractor's internal purposes in establishing the actual cost of owning and operating equipment, all such other source documents;
 22. All nonprivileged documents which relate to each and every Claim together with all documents which support the amount of any adjustment in Contract Sum or Contract Time sought by each Claim;
 23. Work sheets or software used to prepare the Claim establishing the cost components for items of the Claim including but not limited to labor, benefits and insurance, materials, equipment, Subcontractors, all documents which establish the time periods, individuals involved, the hours for the individuals, and the rates for the individuals; and
 24. Work sheets, software, and all other documents used by Contractor to prepare its bid.
- B. The audit may be performed by employees of Owner or a representative of Owner. Contractor, and its Subcontractors, shall provide adequate facilities acceptable to Owner, for the audit during normal business hours. Contractor, and all Subcontractors, shall make a good faith effort to cooperate with Owner's auditors.

PART 9 - TERMINATION OF THE WORK

9.01 TERMINATION BY OWNER FOR CAUSE

- A. Owner may, upon 7 Days Notice to Contractor and to its surety, terminate (without prejudice to any right or remedy

of Owner) the Work, or any part of it, for cause upon the occurrence of any one or more of the following events:

1. Contractor fails to prosecute the Work or any portion thereof with sufficient diligence to ensure Substantial Completion of the Work within the Contract Time;
2. Contractor is adjudged bankrupt, makes a general assignment for the benefit of its creditors or a receiver is appointed on account of its insolvency;
3. Contractor fails in a material way to replace or correct Work not in conformance with the Contract Documents;
4. Contractor fails to supply adequately skilled workers, an adequate number of skilled workers to do the Work, proper materials or equipment verified by actual progress made against the approved schedule.
5. Contractor fails to make prompt payment due to Subcontractors, suppliers, or for labor;
6. Contractor materially disregards or fails to comply with recognized and established safety measures, laws, ordinances, rules, regulations, or orders of any public authority having jurisdiction; or
7. Contractor is otherwise in material breach of any provision of the Contract Documents.

B. Upon termination, Owner may at its option:

1. Take possession of the Project site and take possession of or use all materials, equipment, tools, and construction equipment and machinery thereon owned by

Contractor to maintain the orderly progress of, and to finish, the Work;

2. Accept assignment of subcontracts pursuant to section 5.20; and
3. Finish the Work by whatever other reasonable method it deems expedient.

C. Owner's rights and duties upon termination are subject to the prior rights and duties of the surety, if any, obligated under any bond provided in accordance with the Contract Documents.

D. When Owner terminates the Work in accordance with this section, Contractor shall take the actions set forth in paragraph 9.02B, and shall not be entitled to receive further payment until the Work is accepted.

E. If the unpaid balance of the Contract Sum exceeds the cost of finishing the Work, including compensation for A/E's services and expenses made necessary thereby and any other extra costs or damages incurred by Owner in completing the Work, or as a result of Contractor's actions, such excess shall be paid to Contractor. If such costs exceed the unpaid balance, Contractor shall pay the difference to Owner. Contractor shall also be liable for liquidated damages until such reasonable time as may be required for Substantial Completion. These obligations for payment shall survive termination.

F. Termination of the Work in accordance with this section shall not relieve Contractor or its surety of any responsibilities for Work performed.

G. If Owner terminates Contractor for cause, and it is later determined that none of the circumstances set forth in paragraph 9.01A exist, then such termination shall be

deemed a termination for convenience pursuant to section 9.02.

9.02 TERMINATION BY OWNER FOR CONVENIENCE

- A. Owner may, upon Notice, terminate (without prejudice to any right or remedy of Owner) the Work, or any part of it, for the convenience of Owner.
- B. Unless Owner directs otherwise, after receipt of a Notice of termination for either cause or convenience, Contractor shall promptly:
1. Stop performing Work on the date as specified in the notice of termination;
 2. Place no further orders or subcontracts for materials, equipment, services or facilities, except as may be necessary for completion of such portion of the Work which is not terminated;
 3. Cancel all orders and subcontracts, upon terms acceptable to Owner, to the extent that they relate to the performance of Work terminated;
 4. Assign to Owner all of the rights, titles, and interests of Contractor in all orders and subcontracts;
 5. Take such action as may be necessary or as directed by Owner to preserve and protect the Work, Project site, and any other property related to this Project in the possession of Contractor in which Owner has an interest; and
 6. Continue performance only to the extent not terminated.
- C. If Owner terminates the Work or any portion thereof for convenience, Contractor shall be entitled to make a request for an equitable adjustment for its reasonable direct costs incurred prior to the effective date of the termination, plus

a reasonable allowance for overhead and profit on Work performed prior to termination, plus the reasonable administrative costs of the termination, but shall not be entitled to any other costs or damages, whatsoever, provided however, the total sum payable upon termination shall not exceed the Contract Sum reduced by prior payments. Contractor shall be required to make its request in accordance with the provisions of part 7.

- D. If Owner terminates the Work or any portion thereof for convenience, the Contract Time shall be adjusted as determined by Owner.

PART 10 - MISCELLANEOUS PROVISIONS

10.01 GOVERNING LAW

The Contract Documents and the rights of the parties herein shall be governed by the laws of the state of Washington. Venue shall be in the county in which Owner's principal place of business is located, unless otherwise specified.

10.02 SUCCESSORS AND ASSIGNS

Owner and Contractor respectively bind themselves, their partners, successors, assigns, and legal representatives to the other party hereto and to partners, successors, assigns, and legal representatives of such other party in respect to covenants, agreements, and obligations contained in the Contract Documents. Neither party shall assign the Work without written consent of the other, except that Contractor may assign the Work for security purposes, to a bank or lending institution authorized to do business in the state of Washington. If either party attempts to make such an assignment without such consent, that party shall nevertheless remain legally responsible for all obligations set forth in the Contract Documents.

10.03 MEANING OF WORDS

Unless otherwise stated in the Contract Documents, words which have well-known technical or construction industry meanings are used in the Contract Documents in accordance with such recognized meanings. Reference to standard specifications, manuals, or codes of any technical society, organization, or association, or to the code of any governmental authority, whether such reference be specific or by implication, shall be to the latest standard specification, manual, or code in effect on the date for submission of bids, except as may be otherwise specifically stated. Wherever in these Drawings and Specifications an article, device, or piece of equipment is referred to in the singular manner, such reference shall apply to as many such articles as are shown on the Drawings, or required to complete the installation.

10.04 RIGHTS AND REMEDIES

No action or failure to act by Owner or A/E shall constitute a waiver of a right or duty afforded them under the Contract Documents, nor shall such action or failure to act constitute approval of an acquiescence in a breach therein, except as may be specifically agreed in writing.

10.05 CONTRACTOR REGISTRATION

Contractor shall be registered or licensed as required by the laws of the State of Washington, including but not limited to RCW 18.27.

10.06 TIME COMPUTATIONS

When computing any period of time, the Day of the event from which the period of time begins shall not be counted. The last Day is counted unless it falls on a weekend or legal holiday, in which event the period runs until the end of the next Day that is not a weekend or holiday. When the period of time allowed is less than 7 Days, intermediate Saturdays, Sundays, and Owner-observed holidays are excluded from the computation. "Owner-observed holidays" are New Year's Day; Martin Luther King, Jr. Day; Presidents' Day; Memorial Day; Fourth of

July; Labor Day; Thanksgiving, the day after Thanksgiving; and Christmas. If New Year's Day, the Fourth of July, or Christmas fall on a Saturday, they shall be observed on the preceding Friday; if on a Sunday, they shall be observed on the following Monday.

10.07 RECORDS RETENTION

The wage, payroll, and cost records of Contractor, and its Subcontractors, and all records subject to audit in accordance with section 8.03, shall be retained for a period of not less than 6 years after the date of Final Acceptance.

10.08 THIRD-PARTY AGREEMENTS

The Contract Documents shall not be construed to create a contractual relationship of any kind between A/E and Contractor; Owner and any Subcontractor; or any persons other than Owner and Contractor.

10.09 ANTITRUST ASSIGNMENT

Owner and Contractor recognize that in actual economic practice, overcharges resulting from antitrust violations are in fact usually borne by the purchaser. Therefore, Contractor hereby assigns to Owner any and all claims for such overcharges as to goods, materials, and equipment purchased in connection with the Work performed in accordance with the Contract Documents, except as to overcharges which result from antitrust violations commencing after the Contract Sum is established and which are not passed on to Owner under a Change Order. Contractor shall put a similar clause in its Subcontracts, and require a similar clause in its sub-Subcontracts, such that all claims for such overcharges on the Work are passed to Owner by Contractor.

10.10 NOTICES

A. Method of Serving Notices. Any and all notices required under this Contract (each, a "Notice") shall be in writing and shall be deemed delivered:

1. Three (3) Business Days after being posted by certified or registered mail to the other party's contact person at the address specified below;
2. One (1) Business Day after being sent by recognized national overnight courier service to the other party's contact person at the address specified below;
3. On the same Day when sent by facsimile to the contact person at the designated facsimile number of the party with confirmed receipt, provided the facsimile is sent on a Business Day and prior to 3:00 pm on that Business Day, and otherwise, the Notice shall be deemed delivered one (1) Business Day after being sent by facsimile with confirmed receipt; or
4. On the same Day when delivered in person to an Authorized Representative of the other Party on the Development Site.
5. On the same Day when delivered via email to the Project Coordinator by 3:00 pm.

B. Owner's Address. The Owner's address for all Notices, other than those certain submittals described in the next paragraph, shall be:

Seattle Housing Authority
190 Queen Anne Avenue North
P.O. Box 19028
Seattle, Washington 98109-1028
Contact Person:

Email: _____@seattlehousing.org

Submittals of Performance and Payment Bond and Proof of Insurance, and submittal of Prevailing Wage, EEO, Apprentice Utilization, Section 3 Resident Utilization, WMBE, and Section 3 Benchmarks for Creating Economic Opportunities for Low- and Very Low-Income Persons and Eligible

Businesses information and reports will be addressed to:

Seattle Housing Authority
190 Queen Anne Avenue North
P.O. Box 19028
Seattle, Washington 98109-1028
Contact Person: _____, Sr.
Contract Administrator
Email: _____@seattlehousing.org

C. Contractor's Address. The address of the Contractor for all Notice shall be:

Contact Person:

Email:

Fax:

D. Change in Notice Address.

Either party may change its address and contact person for Notice by delivering a Notice of such change to the other party in accordance with this Article 10.

E. Importance of Contractor Compliance with Notice Requirements. The Contract Documents contain many important provisions regarding delivery of notices, particularly with regards to delays, adjustments in Contract Sum or Contract Time, and other claims. Contractor's failure to comply with the applicable notice requirements in the Contract Documents, whether in terms of timely delivery or delivery in required form and substance, can and will result in the absolute forfeiture, waiver, bar and release of rights, remedies and claims that Contractor might otherwise have against Owner.

10.11 LABOR AND INDUSTRIES REQUIRED DOCUMENTS FOR HUD FUNDED PROJECTS:

Contractors must comply with the Prevailing Wage Policy Memorandum dated April 20, 2011 from the State of Washington's L&I regarding HUD Housing Projects –Federal Preemption, The Housing Act of 1937 and 24 CFR 965.101, accessible on Labor and Industries website at <http://www.lni.wa.gov/TradesLicensing/PrevWage/files/Policies/HUDHousingProjects-HousingActOf1937.pdf>. Pursuant to this Directive from the State of Washington, effective May 15, 2011, regardless of the federal wage preemption, contractors are required to file the Statement of Intent to Pay Prevailing Wages & the Affidavit of Wages Paid forms on HUD Housing Projects. This requirement is now in addition to the observance of the required federal labor standards requirements specified in the Contract Documents.

PART 11 - FEDERAL PROVISIONS

These provisions supplement other provisions in this Contract.

11.01 PROHIBITION AGAINST USE OF LEAD-BASED PAINT

The Contractor shall comply with the prohibition against the use of lead-based paint contained in the Lead-Based Paint Poisoning Prevention Act (42 U.S.C. 4821-4846) as implemented by 24 CFR Part 35.

11.02 FEDERAL HEALTH, SAFETY, AND ACCIDENT PREVENTION

A. In performing this contract, the Contractor will ensure that no laborer or mechanic will be required to work in surroundings or in or under any working conditions which are unsanitary, hazardous, or dangerous to his/her health and/or safety as determined under construction safety and health

standards promulgated by the Secretary of Labor by regulation.

B. For these purposes, the Contractor will comply with section 5.07 and with regulations and standards issued by the Secretary of Labor at 29 CFR Parts 1904 and 1926. Failure to comply may result in imposition of sanctions pursuant to the Contract Work Hours and Safety Standards Act (40 U.S.C 3701-3708)

11.03 CLEAN AIR AND WATER APPLICABLE TO CONTRACTS IN EXCESS OF \$150,000

A. Definition. "Facility" means any building, plant, installation, structure, mine, vessel or other floating craft, location, or site of operations, owned, leased, or supervised by the Contractor or any subcontractor, used in the performance of the contract or any subcontract. When a location or site of operations includes more than one building, plant, installation, or structure, the entire location or site shall be deemed a facility except when the Administrator, or a designee, of the Environmental Protection Agency (EPA) determines that independent facilities are collocated in one geographical area.

B. In compliance with regulations issued by the United States Environmental Protection Agency (EPA), 40 CFR Part 15, pursuant to the Clean Air Act, as amended ("Air Act"), 42 U.S.C. 7401-7671q, et seq., the Federal Water Pollution Control Act, as amended ("Water Act"), 33 U.S.C. 1251-1387, et seq., and Executive Order 11738, the Contractor agrees to

1. Not utilize any facility in the performance of this contract or any subcontract which is listed on the EPA List of Violating Facilities pursuant to Part 15 of the regulations for the duration of time that the facility remains on the list;

2. Promptly notify the Owner if a facility the Contractor intends to use in the performance of this contract is on the EPA List of Violating Facilities or the Contractor knows that it has been recommended to be placed on the List;
 3. Comply with all requirements of the Air Act and the Water Act, including the requirements of Section 114 of the Air Act and Section 308 of the Water Act, and all applicable clean air and clean water standards; and,
 4. Include or cause to be included the provisions of this clause in every subcontract, and take such action as HUD may direct as a means of enforcing such provisions.
- C. Dividing total requirements, when economically feasible, into smaller tasks or quantities to permit maximum participation by qualified small and minority businesses and women's business enterprises;
 - D. Establishing delivery schedules, where the requirements of the contract permit, which encourage participation by qualified small and minority businesses and women's business enterprises; and
 - E. Using the services and assistance of the U.S. Small Business Administration, the Minority Business Development Agency of the U.S. Department of Commerce, and State and local governmental small business agencies.

11.04 ENERGY EFFICIENCY

The Contractor shall comply with all standards and policies relating to energy efficiency which are contained in the energy conservation plan issued in compliance with the Energy Policy and Conservation Act (42 U.S.C. 6201) for the State in which the work under the contract is performed.

11.05 SUBCONTRACTING WITH SMALL AND MINORITY FIRMS, WOMEN'S BUSINESS ENTERPRISE, AND LABOR SURPLUS AREA FIRMS

The Contractor shall take the following steps to ensure that, whenever possible, subcontracts are awarded to qualified small business firms, minority firms, women's business enterprises, and labor surplus area firms:

- A. Placing qualified small and minority businesses and women's business enterprises on solicitation lists;
- B. Ensuring that qualified small and minority businesses and women's business enterprises are solicited whenever they are potential sources;

11.06 EQUAL EMPLOYMENT OPPORTUNITY

- A. Contractor shall comply with Executive Order 11246, as amended, and the rules, regulations, and orders of the Secretary of Labor.
- B. The Contractor shall furnish all information and reports required by Executive Order 11246, as amended, Section 503 of the Rehabilitation Act of 1973 as amended, and by rules, regulations, and orders of the Secretary of Labor, or pursuant thereto. The Contractor shall permit access to its books, records, and accounts by the Owner, or the Secretary of Labor for purposes of investigation to ascertain compliance with this section of the Contract, and/or such rules, regulations, and orders.
- C. In the event of a determination that the Contractor is not in compliance with this clause or any rule, regulation, or order of the Secretary of Labor, this contract may be canceled, terminated, or suspended in whole or in part, and the Contractor may be declared ineligible for further Government contracts, or Federally assisted construction contracts under the

procedures authorized in Executive Order 11246, as amended. In addition, sanctions may be imposed and remedies invoked against the Contractor as provided in Executive Order 11246, as amended, the rules, regulations, and orders of the Secretary of Labor, or as otherwise provided by law.

- D. Contractor shall include the terms and conditions of this clause in every subcontract or purchase order so that these terms and conditions will be binding upon each subcontractor or vendor. The Contractor shall take such action with respect to any subcontract or purchase order as the Secretary of Housing and Urban Development or the Secretary of Labor may direct as a means of enforcing such provisions, including sanctions for noncompliance; provided that if the Contractor becomes involved in, or is threatened with, litigation with a subcontractor or vendor as a result of such direction, the Contractor may request the United States to enter into the litigation to protect the interests of the United States.

11.07 CREATING ECONOMIC OPPORTUNITIES FOR LOW- AND VERY LOW-INCOME PERSONS AND ELIGIBLE BUSINESSES, SECTION 3

Contractor will comply with Section 3 and with this Section 11.07.

- A. The work to be performed under this contract is subject to the requirements of Section 3.
- B. Contractor will require its subcontractors to comply with Section 3. As evidenced by its execution of this Contract, Contractor certifies that it is under no contractual or other impediment that would prevent it from complying with Section 3.

- C. Contractor will include this Section 3 clause in every subcontract will take all necessary steps to ensure compliance with Section 3 by its subcontractors. Upon a finding that a subcontractor is in violation of Section 3, Contractor will take appropriate action, as provided in an applicable provision of the subcontract or in this Section 3 clause. Contractor will not subcontract with any subcontractor where the Contractor has notice or knowledge that the subcontractor has been found in violation of Section 3.

- D. Contractor will provide certifications in form and substance required by Owner, at such times as Owner may request, certifying (i) Contractor's compliance with Section 3, and (ii) as to such facts and circumstances pertaining to Section 3 as Owner may require or request, including certification with respect to total number of labor hours worked under this Contract, labor hours worked by Section 3 Workers (as defined in Section 3), and labor hours worked by Targeted Section 3 Workers (as defined in Section 3).

- E. Contractor's noncompliance with Section 3 may result in sanctions, termination of this Contract for default, and debarment or suspension from future HUD assisted contracts.

- F. Contractor agrees to perform any further acts and execute and deliver any further documents that may be reasonably necessary to carry out the provisions and intent of this Section 11.07 or otherwise to ensure compliance with Section 3.

11.08 INTEREST OF MEMBERS OF CONGRESS

No member of or delegate to the Congress of the United States of America shall be admitted to any share or part of this contract or to any benefit that may arise therefrom.

11.09 INTEREST OF MEMBERS, OFFICERS, OR EMPLOYEES AND FORMER MEMBERS, OFFICERS, OR EMPLOYEES

During his or her tenure or for one year thereafter, none of the following classes of people may have an interest, direct or indirect, in this contract or the proceeds thereof:

- A. Any present or former Commissioner of Owner's Board of Commissioners, or any member of the Commissioner's immediate family. This prohibition does not apply to any present or former resident commissioner who does not serve on the governing body of a resident corporation, and who otherwise does not occupy a policymaking position with the resident corporation, Owner, or a business entity.
- B. Any employee of Owner who formulates policy or who influences decisions with respect to the Project, or any member of the employee's immediate family, or the employee's partner.
- C. Any public official, member of the local governing body, or State or local legislator, or any member of such individuals' immediate family, who exercises functions or responsibilities with respect to the Project or Owner.

11.10 LIMITATIONS ON PAYMENTS MADE TO INFLUENCE CERTAIN FEDERAL FINANCIAL TRANSACTIONS

- A. The Contractor agrees to comply with Section 1352 of title 31, United States Code which prohibits the use of Federal appropriated funds to pay any person for influencing or attempting to influence an officer or employee of any agency, a Member of Congress, and officer or employee of Congress, or an employee of a Member of Congress in connection with any of the following covered Federal actions: the awarding of any Federal contract; the making of any Federal grant; the making of any Federal loan; the

entering into of any cooperative agreement; or the modification of any Federal contract, grant, loan, or cooperative agreement.

- B. The Contractor further agrees to comply with the requirement of the Act to furnish a disclosure (OMB Standard Form LLL, Disclosure of Lobbying Activities) if any funds other than Federal appropriated funds (including profit or fee received under a covered Federal transaction) have been paid, or will be paid, to any person for influencing or attempting to influence an officer or employee of any agency, a Member of Congress, an officer or employee of Congress, or an employee of a Member of Congress in connection with a Federal contract, grant, loan, or cooperative agreement.

11.11 EXAMINATION AND RETENTION OF CONTRACTOR'S RECORDS

- A. Owner, HUD, or Comptroller General of the United States, or any of their duly authorized representatives shall, until 3 years after final payment under this contract, have access to and the right to examine any of the Contractor's, Sub-Contractor's and Supplier's directly pertinent books, documents, papers, or other records involving transactions related to this contract for the purpose of making audit, examination, excerpts, and transcriptions.
- B. The Contractor agrees to include in first-tier subcontracts under this contract a clause substantially the same as paragraph 11.02A. "Subcontract," as used in this clause, excludes purchase orders not exceeding \$10,000.
- C. The periods of access and examination in paragraphs (a) and (b) above for records relating to (1) appeals under the Disputes clause of this contract, (2) litigation or settlement of claims arising from the performance of this contract, or (3) costs

and expenses of this contract to which Owner, HUD, or Comptroller General or any of their duly authorized representatives has taken exception shall continue until disposition of such appeals, litigation, claims, or exceptions.

11.12 LABOR STANDARDS - DAVIS-BACON AND RELATED ACTS

If the total amount of this contract exceeds \$2,000, the Federal labor standards set forth in the clause below shall apply to the construction work to be performed under the contract, except if the construction work has been determined to be "Nonroutine Maintenance" subject to the terms of that clause of this contract.

A. Minimum Wages.

1. All laborers and mechanics employed under this contract in the development or construction of the project(s) involved will be paid unconditionally and not less often than once a week, and without subsequent deduction or rebate on any account (except such payroll deductions as are permitted by regulations issued by the Secretary of Labor under the Copeland Act (29 CFR Part 3)), the full amount of wages and bona fide fringe benefits (or cash equivalents thereof) due at time of payment computed at rates not less than those contained in the wage determination of the Secretary of Labor which is attached hereto and made a part hereof, regardless of any contractual relationship which may be alleged to exist between the Contractor and such laborers and mechanics. Contributions made or costs reasonably anticipated for bona fide fringe benefits under Section 1(b)(2) of the Davis-Bacon Act on behalf of laborers or mechanics are considered wages paid to such laborers or mechanics, subject to the provisions of 29 CFR 5.5(a)(1)(iv); also, regular contributions made or costs incurred for more than a weekly period

(but not less often than quarterly) under plans, funds, or programs which cover the regular weekly period, are deemed to be constructively made or incurred during such weekly period. Such laborers and mechanics shall be paid the appropriate wage rate and fringe benefits in the wage determination for the classification of work actually performed, without regard to skill, except as provided in 29 CFR 5.5(a)(4). Laborers or mechanics performing work in more than one classification may be compensated at the rate specified for each classification for the time actually worked therein; provided, that the employer's payroll records accurately set forth the time spent in each classification in which work is performed. The wage determination (including any additional classification and wage rates conformed under 29 CFR 5.5(a)(1)(ii) and the Davis-Bacon poster (WH-1321) shall be posted at all times by the Contractor and its subcontractors at the site of the work in a prominent and accessible place where it can be easily seen by the workers.

2. a. Any class of laborers or mechanics, including helpers, which is not listed in the wage determination and which is to be employed under the contract shall be classified in conformance with the wage determination. HUD shall approve an additional classification and wage rate and fringe benefits therefor only when all the following criteria have been met:

i. The work to be performed by the classification requested is not performed by a

- classification in the wage determination; and
- ii. The classification is utilized in the area by the construction industry; and
 - iii. The proposed wage rate, including any bona fide fringe benefits, bears a reasonable relationship to the wage rates contained in the wage determination.
- b. If the Contractor and the laborers and mechanics to be employed in the classification (if known), or their representatives, and HUD or its designee agree on the classification and wage rate (including the amount designated for fringe benefits where appropriate), a report of the action taken shall be sent by HUD or its designee to the Administrator of the Wage and Hour Division, Employee Standards Administration, U.S. Department of Labor, Washington, DC 20210. The Administrator, or an authorized representative, will approve, modify, or disapprove every additional classification action within 30 days of receipt and so advise HUD or its designee or will notify HUD or its designee within the 30-day period that additional time is necessary.
- c. In the event the Contractor, the laborers or mechanics to be employed in the classification or their representatives, and HUD or its designee do not agree on the proposed classification and wage rate (including the amount designated for fringe benefits, where appropriate), HUD or its designee shall refer the questions, including the views of all interested parties and the recommendation of HUD or its designee, to the Administrator of the Wage and Hour Division for determination. The Administrator, or an authorized representative, will issue a determination within 30 days of receipt and so advise HUD or its designee or will notify HUD or its designee within the 30-day period that additional time is necessary.
- d. The wage rate (including fringe benefits where appropriate) determined pursuant to subparagraphs (2)(a)(ii) or (iii) of this clause shall be paid to all workers performing work in the classification under this contract from the first day on which work is performed in classification.
3. Whenever the minimum wage rate prescribed in the contract for a class of laborers or mechanics includes a fringe benefit which is not expressed as an hourly rate, the Contractor shall either pay the benefit as stated in the wage determination or shall pay another bona fide fringe benefit or an hourly cash equivalent thereof.
4. If the Contractor does not make payments to a trustee or other third person, the Contractor may consider as part of the wages of any laborer or mechanic the amount of any costs reasonably anticipated in providing bona fide fringe benefits under a plan or program; provided, that the Secretary of Labor has found, upon the written request of the Contractor, that the applicable standards of the Davis-Bacon Act have been met. The Secretary of Labor may require the Contractor to set aside in a separate account assets for the meeting of obligations under the plan or program.

B. Withholding of funds. HUD or its designee shall, upon its own action or upon written request of an authorized representative of the Department of Labor, withhold or cause to be withheld from the Contractor under this contract or any other Federal contract with the same prime Contractor, or any other Federally-assisted contract subject to Davis-Bacon prevailing wage requirements, which is held by the same prime Contractor, so much of the accrued payments or advances as may be considered necessary to pay laborers and mechanics, including apprentices, trainees, and helpers, employed by the Contractor or any subcontractor the full amount of wages required by the contract. In the event of failure to pay any laborer or mechanic, including any apprentice, trainee, or helper, employed or working in the construction or development of the project, all or part of the wages required by the contract, HUD or its designee may, after written notice to the Contractor, take such action as may be necessary to cause the suspension of any further payment, advance, or guarantee of funds until such violations have ceased. HUD or its designee may, after written notice to the Contractor, disburse such amounts withheld for and on account of the Contractor or subcontractor to the respective employees to whom they are due.

C. Payrolls and basic records.

1. Payrolls and basic records relating thereto shall be maintained by the Contractor during the course of the work and preserved for a period of three years thereafter for all laborers and mechanics working in the construction or development of the project. Such records shall contain the name, address, and social security number of each such worker, his or her correct classification, hourly rates of wages paid (including rates of contributions or costs anticipated for bona fide fringe benefits

or cash equivalents thereof of the types described in section 1(b)(2)(B) of the Davis-Bacon Act), daily and weekly number of hours worked, deductions made, and actual wages paid. Whenever the Secretary of Labor has found, under 29 CFR 5.5(a)(1)(iv), that the wages of any laborer or mechanic include the amount of costs reasonably anticipated in providing benefits under a plan or program described in section 1(b)(2)(B) of the Davis-Bacon Act, the Contractor shall maintain records which show that the commitment to provide such benefits is enforceable, that the plan or program is financially responsible, and that the plan or program has been communicated in writing to the laborers or mechanics affected, and records which show the costs anticipated or the actual cost incurred in providing such benefits. Contractors employing apprentices or trainees under approved programs shall maintain written evidence of the registration of apprenticeship programs and certification of trainee programs, the registration of the apprentices and trainees, and the ratios and wage rates prescribed in the applicable programs.

2. a. The Contractor shall submit weekly for each week in which any contract work is performed a copy of all payrolls to the Contracting Officer for transmission to HUD or its designee. The payrolls submitted shall set out accurately and completely all of the information required to be maintained under subparagraph (C)(1) of this clause. This information may be submitted in any form desired. Optional Form WH-347 (Federal Stock Number 029-005-00014-1) is available for this purpose and may be purchased from the Superintendent of Documents, U.S. Government Printing Office, Washington, D.C. 20402. The Contractor is responsible for the submission of copies of payrolls by all

subcontractors. (Approved by the Office of Management and Budget under OMB Control Number 1214-0149.)

b. Each payroll submitted shall be accompanied by a "Statement of Compliance," signed by the Contractor or subcontractor or his or her agent who pays or supervises the payment of the persons employed under the contract and shall certify the following:

i. That the payroll for the payroll period contains the information required to be maintained under paragraph (C)(1) of this clause and that such information is correct and complete;

ii. That each laborer or mechanic (including each helper, apprentice, and trainee) employed on the contract during the payroll period has been paid the full weekly wages earned, without rebate, either directly or indirectly, and that no deductions have been made either directly or indirectly from the full wages earned, other than permissible deductions as set forth in 29 CFR Part 3; and

iii. That each laborer or mechanic has been paid not less than the applicable wage rates and fringe benefits or cash equivalents for the classification of work performed, as specified in the applicable wage determination incorporated into the contract.

c. The weekly submission of a properly executed certification set forth on the reverse side of Optional Form WH-347 shall satisfy the requirements for submission of the "Statement of

Compliance" required by subparagraph (2)(b)(ii) of this clause.

d. The falsification of any of the above certifications may subject the Contractor or subcontractor to civil or criminal prosecution under Section 1001 of Title 18 and Section 3729 of Title 31 of the United States Code.

3. The Contractor or subcontractor shall make the records required under subparagraph (C)(1) available for inspection, copying, or transcription by authorized representatives of HUD or its designee, the Contracting Officer, or the Department of Labor and shall permit such representatives to interview employees during working hours on the job. If the Contractor or subcontractor fails to submit the required records or to make them available, HUD or its designee may, after written notice to the Contractor, take such action as may be necessary to cause the suspension of any further payment, advance, or guarantee of funds. Furthermore, failure to submit the required records upon request or to make such records available may be grounds for debarment action pursuant to 29 CFR 5.12.

D. 1. Apprentices. Apprentices will be permitted to work at less than the predetermined rate for the work they performed when they are employed pursuant to and individually registered in a bona fide apprenticeship program registered with the U.S. Department of Labor, Employment and Training Administration, Office of Apprenticeship and Training, Employer and Labor Services (OATELS), or with a State Apprenticeship Agency recognized by OATELS, or if a person is employed in his or her first 90 days of probationary employment as an apprentice in such an apprenticeship program, who is not individually registered in the program, but who has been certified by OATELS

or a State Apprenticeship Agency (where appropriate) to be eligible for probationary employment as an apprentice. The allowable ratio of apprentices to journeymen on the job site in any craft classification shall not be greater than the ratio permitted to the Contractor as to the entire work force under the registered program. Any worker listed on a payroll at an apprentice wage rate, who is not registered or otherwise employed as stated in this paragraph, shall be paid not less than the applicable wage rate on the wage determination for the classification of work actually performed. In addition, any apprentice performing work on the job site in excess of the ratio permitted under the registered program shall be paid not less than the applicable wage rate on the wage determination for the work actually performed. Where a contractor is performing construction on a project in a locality other than that in which its program is registered, the ratios and wage rates (expressed in percentages of the journeyman's hourly rate) specified in the Contractor's or subcontractor's registered program shall be observed. Every apprentice must be paid at not less than the rate specified in the registered program for the apprentice's level of progress, expressed as a percentage of the journeyman hourly rate specified in the applicable wage determination. Apprentices shall be paid fringe benefits in accordance with the provisions of the apprenticeship program. If the apprenticeship program does not specify fringe benefits, apprentices must be paid the full amount of fringe benefits listed on the wage determination for the applicable classification. If the Administrator of the Wage and Hour Division determines that a different practice prevails for the applicable apprentice classification, fringes shall be paid in accordance with that determination. In the event OATELS, or

a State Apprenticeship Agency recognized by OATELS, withdraws approval of an apprenticeship program, the Contractor will no longer be permitted to utilize apprentices at less than the applicable predetermined rate for the work performed until an acceptable program is approved.

2. Trainees. Except as provided in 29 CFR 5.16, trainees will not be permitted to work at less than the predetermined rate for the work performed unless they are employed pursuant to and individually registered in a program which has received prior approval, evidenced by formal certification by the U.S. Department of Labor, Employment and Training Administration. The ratio of trainees to journeymen on the job site shall not be greater than permitted under the plan approved by the Employment and Training Administration. Every trainee must be paid at not less than the rate specified in the approved program for the trainee's level of progress, expressed as a percentage of the journeyman hourly rate specified in the applicable wage determination. Trainees shall be paid fringe benefits in accordance with the provisions of the trainee program. If the trainee program does not mention fringe benefits, trainees shall be paid the full amount of fringe benefits listed in the wage determination unless the Administrator of the Wage and Hour Division determines that there is an apprenticeship program associated with the corresponding journeyman wage rate in the wage determination which provides for less than full fringe benefits for apprentices. Any employee listed on the payroll at a trainee rate who is not registered and participating in a training plan approved by the Employment and Training Administration shall be paid not less than the applicable wage rate in the wage determination for the classification of work actually performed. In addition,

any trainee performing work on the job site in excess of the ratio permitted under the registered program shall be paid not less than the applicable wage rate in the wage determination for the work actually performed. In the event the Employment and Training Administration withdraws approval of a training program, the Contractor will no longer be permitted to utilize trainees at less than the applicable predetermined rate for the work performed until an acceptable program is approved.

3. Equal employment opportunity. The utilization of apprentices, trainees, and journeymen under this clause shall be in conformity with the equal employment opportunity requirements of Executive Order 11246, as amended, and 29 CFR Part 30.

E. Compliance with Copeland Act requirements. The Contractor shall comply with the requirements of 29 CFR Part 3, which are hereby incorporated by reference in this contract.

F. Contract termination; debarment. A breach of this contract clause may be grounds for termination of the contract and for debarment as a Contractor and a subcontractor as provided in 29 CFR 5.12.

G. Compliance with Davis-Bacon and related Act requirements. All rulings and interpretations of the Davis-Bacon and related Acts contained in 29 CFR Parts 1, 3, and 5 are herein incorporated by reference in this contract.

H. Disputes concerning labor standards. Disputes arising out of the labor standards provisions of this clause shall not be subject to the general disputes clause of this contract. Such disputes shall be resolved in accordance with the procedures of the Department of Labor set forth in 29 CFR Parts 5, 6, and 7. Disputes within the meaning of this clause include

disputes between the Contractor (or any of its subcontractors) and the PHA, HUD, the U.S. Department of Labor, or the employees or their representatives.

I. Certification of eligibility.

1. By entering into this contract, the Contractor certifies that neither it (nor he or she) nor any person or firm who has an interest in the Contractor's firm is a person or firm ineligible to be awarded contracts by the United States Government by virtue of section 3(a) of the Davis-Bacon Act or 29 CFR 5.12(a)(1).

2. No part of this contract shall be subcontracted to any person or firm ineligible for award of a United States Government contract by virtue of section 3(a) of the Davis-Bacon Act or 29 CFR 5.12(a)(1).

3. The penalty for making false statements is prescribed in the U. S. Criminal Code, 18 U.S.C. 1001.

J. Contract Work Hours and Safety Standards Act. As used in this paragraph, the terms "laborers" and "mechanics" include watchmen and guards.

1. Overtime requirements. No contractor or subcontractor contracting for any part of the contract work which may require or involve the employment of laborers or mechanics, including watchmen and guards, shall require or permit any such laborer or mechanic in any workweek in which the individual is employed on such work to work in excess of 40 hours in such workweek unless such laborer or mechanic receives compensation at a rate not less than one and one-half times the basic rate of pay for all hours worked in excess of 40 hours in such workweek.

2. Violation; liability for unpaid wages; liquidated damages. In the event of any violation of the provisions set forth in subparagraph (J)(1) of this clause, the Contractor and any subcontractor responsible therefor shall be liable for the unpaid wages. In addition, such Contractor and subcontractor shall be liable to the United States (in the case of work done under contract for the District of Columbia or a territory, to such District or to such territory), for liquidated damages. Such liquidated damages shall be computed with respect to each individual laborer or mechanic (including watchmen and guards) employed in violation of the provisions set forth in subparagraph (J)(1) of this clause, in the sum of \$10 for each calendar day on which such individual was required or permitted to work in excess of the standard workweek of 40 hours without payment of the overtime wages required by provisions set forth in subparagraph (J)(1) of this clause.

3. Withholding for unpaid wages and liquidated damages. HUD or its designee shall upon its own action or upon written request of an authorized representative of the Department of Labor withhold or cause to be withheld, from any moneys payable on account of work performed by the Contractor or subcontractor under any such contract or any Federal contract with the same prime Contractor, or any other Federally-assisted contract subject to the Contract Work Hours and Safety Standards Act, which is held by the same prime Contractor, such sums as may be determined to be necessary to satisfy any liabilities of such Contractor or subcontractor for unpaid wages and liquidated damages as provided in the provisions set forth in subparagraph (J)(2) of this clause.

K. Subcontracts. The Contractor or subcontractor shall insert in any subcontracts

all the provisions contained in this clause, and such other clauses as HUD or its designee may by appropriate instructions require, and also a clause requiring the subcontractors to include these provisions in any lower tier subcontracts. The prime Contractor shall be responsible for the compliance by any subcontractor or lower tier subcontractor with all these provisions.

11.13 LABOR STANDARDS – HUD-DETERMINED NON-ROUTINE MAINTENANCE

If Prevailing Wage for this Contract is HUD Non-Routine Maintenance, the following section applies:

For contracts exceeding \$2,000, HUD has determined that the construction covered by this contract consists of non-routine maintenance (as defined in 24 CFR 968.203) necessary for the operation of the Public Housing project; and the labor standards set forth below and the provisions of Section 12 of the United States Housing Act of 1937 which pertain to such work shall apply. Section 11.12 does not apply to this Contract.

A. Minimum Wages.

1. All laborers and mechanics employed or working upon the site of the work will be paid unconditionally and without subsequent deduction or rebate on any account (except such payroll deductions as are permitted by regulations issued by the Secretary of Labor under the Copeland Act (29 CFR Part 3), the full amount of wages due at time of payment computed at rates not less than those contained in the wage determination of the Secretary of Housing and Urban Development which is attached hereto and made a part hereof. These payments must be made no later than one pay period following the end of the regular pay period in which the wages were earned or accrued. A pay period may not be of any duration longer than semi-monthly. Such laborers and mechanics shall be paid the appropriate wage rate on the wage determination for the classification of work actually performed, without regard to skill. Laborers or mechanics performing work in more than one classification may be

compensated at the rate specified for each classification for the time actually worked therein; provided, that the employer's payroll records accurately set forth the time spent in each classification in which work is performed. The wage determination shall be posted at all times by the Contractor and its subcontractors at the site of the work in a prominent and accessible place where it can be easily seen by the workers.

2. (a) Any class of laborers or mechanics which is not listed in the wage determination and which is to be employed under the contract shall be classified in conformance with the wage determination. HUD shall approve an additional classification and wage rate only when the following criteria have been met:

- (i) The work to be performed by the classification required is not performed by a classification in the wage determination;
- (ii) The classification is utilized in the area by the industry; and
- (iii) The proposed wage rate bears a reasonable relationship to the wage rates contained in the wage determination.

(b) The wage rate determined pursuant to this paragraph shall be paid to all workers performing work in the classification under this contract from the first day on which work is performed in the classification.

B. Withholding of funds. The Owner, upon its own action or upon request of HUD shall withhold or cause to be withheld from the Contractor under this contract or any other contract subject to HUD-determined wage rates, with the same Contractor, so much of the accrued payments or advances as may be considered necessary to pay laborers and mechanics employed by the Contractor or any subcontractor the full amount of wages required by this clause. In the event of failure to pay any laborer or mechanic employed or working on the site of the work all or part of the wages required by the contract, the Contracting Officer or HUD may, after written notice to the

Contractor, take such action as may be necessary to cause the suspension of any further payment, or advance, until such violations have ceased. The Owner or HUD may, after written notice to the Contractor, disburse such amounts withheld for and on account of the Contractor or subcontractor to the respective employees to whom they are due.

C. Payrolls and basic records.

1. Payrolls and basic records relating thereto shall be maintained by the Contractor during the course of the work and preserved for a period of three years thereafter for all laborers and mechanics working at the site of the work. Such records shall contain the name, address, and social security number of each such worker, his or her correct classification, hourly rates of wages paid, daily and weekly number of hours worked, deductions made, and actual wages paid.

2. The Contractor or subcontractor shall make the records required under subparagraph (C)(1) available for inspection, copying, or transcription by authorized representatives of HUD or the Owner and shall permit such representatives to interview employees during working hours on the job. If the Contractor or subcontractor fails to make them available, HUD or its designee may, after written notice to the Contractor, take such action as may be necessary to cause the suspension of any further payment, advance, or guarantee of funds. Furthermore, failure to make such records available may be grounds for debarment or denial of participation in HUD's programs pursuant to 24 CFR Part 24.

D. Compliance with Copeland Act requirements. The Contractor shall comply with the requirements of 29 CFR Part 3 which are incorporated by reference in this contract.

E. Contract termination; debarment. A breach of this contract clause may be grounds for termination of the contract and for debarment as a Contractor and a subcontractor as provided in 24 CFR Part 24.

F. Disputes concerning labor standards.

1. Disputes arising out of the labor standards provisions of paragraphs (A), (B), (C), and (E) of this clause shall be subject to the general disputes clause of this contract.

2. Disputes arising out of the labor standards provisions of paragraphs (D), and (G) of this clause shall not be subject to the general disputes clause of this contract. Such disputes shall be resolved in accordance with the procedures of the Department of Labor set forth in 29 CFR Parts 5, 6, and 7. Disputes within the meaning of this paragraph (F) (2) include disputes between the Contractor (or any of its subcontractors) and the Owner, HUD, the U.S. Department of Labor, or the employees or their representatives.

G. Contract Work Hours and Safety Standards Act. As used in this paragraph, the terms "laborers" and "mechanics" include watchmen and guards.

1. Overtime requirements. No contractor or subcontractor contracting for any part of the contract work which may require or involve the employment of laborers or mechanics shall require or permit any such laborer or mechanic in any workweek in which the individual is employed on such work to work in excess of 40 hours in such workweek unless such laborer or mechanic receives compensation at a rate not less than one and one-half times the basic rate of pay for all hours worked in excess of 40 hours in such workweek.

2. Violation; liability for unpaid wages; liquidated damages. In the event of any violation of the provisions set forth in subparagraph (G) (1) of this clause, the Contractor and any subcontractor responsible therefor shall be liable for the unpaid wages. In addition, such Contractor and subcontractor shall be liable to the United States, for liquidated damages. Such liquidated damages shall be computed with respect to each individual laborer or

mechanic, including watchmen and guards, employed in violation of the provisions set forth in subparagraph (G) (1) of this clause, in the sum of \$10 for each calendar day on which such individual was required or permitted to work in excess of the standard workweek of 40 hours without payment of the overtime wages required by provisions set forth in subparagraph (G) (1) of this clause.

3. Withholding for unpaid wages and liquidated damages. HUD or its designee shall upon its own action or upon written request of an authorized representative of the Department of Labor withhold or cause to be withheld, from any moneys payable on account of work performed by the Contractor or subcontractor under any such contract or any federal contract with the same Contractor, or any other federally-assisted contract subject to the Contract Work Hours and Safety Standards Act, which is held by the same Contractor such sums as may be determined to be necessary to satisfy any liabilities of such Contractor or subcontractor for unpaid wages and liquidated damages as provided in the provisions set forth in subparagraph (G)(2) of this clause.

H. Subcontracts. The Contractor or subcontractor shall insert in any subcontracts all the provisions contained in this clause and also a clause requiring the subcontractors to include these provisions in any lower tier subcontracts. The Contractor shall be responsible for the compliance by any subcontractor or lower tier subcontractor with all the provisions contained in this clause.

11.14 NON-FEDERAL PREVAILING WAGE RATES

Any prevailing wage rate (including basic hourly rate and any fringe benefits), determined under State law to be prevailing, with respect to any employee in any trade or position employed under the contract, is inapplicable to the contract and shall not be enforced against the Contractor or any subcontractor, with respect to employees engaged under the

contract whenever either of the following occurs:

- A. Such non-Federal prevailing wage rate exceeds: (1) the applicable wage rate determined by the Secretary of Labor pursuant to the Davis-Bacon Act (40 U.S.C. 276a et seq.) to be prevailing in the locality with respect to such trade; (2) an applicable apprentice wage rate based thereon specified in an apprenticeship program registered with the U.S. Department of Labor or a DOL-recognized State Apprenticeship Agency; or (3) an applicable trainee wage rate based thereon specified in a DOL-certified trainee program; or
- B. Such non-Federal prevailing wage rate, exclusive of any fringe benefits, exceeds the applicable wage rate determined by the Secretary of HUD to be prevailing in the locality with respect to such trade or position.

11.15 PROCUREMENT OF RECOVERED MATERIALS

- A. In accordance with Section 6002 of the Solid Waste Disposal Act, as amended by the Resource Conservation and Recovery Act, the Contractor shall procure items designated in guidelines of the Environmental Protection Agency (EPA) at 40 CFR Part 247 that contain the highest percentage of recovered materials practicable, consistent with maintaining a satisfactory level of competition. The Contractor shall procure items designated in the EPA guidelines that contain the highest percentage of recovered materials practicable unless the Contractor determines that such items: (1) are not reasonably available in a reasonable period of time; (2) fail to meet reasonable performance standards, which shall be determined on the basis of the guidelines of the National Institute of Standards and Technology, if

applicable to the item; or (3) are only available at an unreasonable price.

- B. Paragraph (A) of this clause shall apply to items purchased under this contract where: (1) the Contractor purchases in excess of \$10,000 of the item under this contract; or (2) during the preceding Federal fiscal year, the Contractor: (i) purchased any amount of the items for use under a contract that was funded with Federal appropriations and was with a Federal agency or a State agency or agency of a political subdivision of a State; and (ii) purchased a total of in excess of \$10,000 of the item both under and outside that contract.

PART 12 - SOCIAL EQUITY REQUIREMENTS

12.01 EMPLOYMENT AND TRAINING GOALS AND REQUIREMENTS

A. Section 3 Employment Goal and Requirements

1. Definitions

New Hire: A New Hire is defined as an employee of Contractor or any of its subcontractors who is hired specifically for the Project as a full-time employee for permanent, temporary, or seasonal employment, and who has not been a regular employee of Contractor or any of its subcontractors during the preceding twelve-month period.

1. **General:** The Owner is committed to, and has a strong policy of, maximizing the employment and training opportunities provided to Section 3 Eligible Persons on the Project. This commitment includes a commitment to ensuring both formal and on-the-job training and working experiences for Section 3 Eligible Persons.
2. **New Hire Utilization Goal:** In order to promote the use of Section 3 Eligible Persons on the Project, Owner has established a goal that 30% of all New

Hires for the Project (including both the Contractor and all subcontractors) will be Section 3 Eligible Persons. Unless otherwise specified in the Bid Documents, as part of the Community Participation Plan to be submitted with the Bid or Proposal, the Bidder will provide an estimated total project work force breakdown (including prime and subcontractors) for this Project. In submitting its Bid for this Project, the Bidder agrees to aspire to meet this goal consistent with the following:

- a. Contractor and subcontractors will hire non-Section 3 Eligible Persons for a New Hire position only if no Section 3 Eligible Person is qualified and available for the position. Contractor will provide an explanation to the Owner if a Section 3 Eligible Person is available but is not hired.
- b. Contractor will report monthly to the Owner on an Owner-provided form, the status of hiring Section 3 Eligible Persons on the Project, including but not limited to the following information: documenting all New Hires hired by the Contractor or any subcontractor during the previous month, and the results of all reviews, interviews, and hiring of Section 3 Eligible Persons from the Owner's list of Section 3 Eligible Persons, and the cumulative percentage of new hires of the total workforce on the job.
- c. The Contractor shall ensure that the Section 3 requirements of its contract with the Owner are included in all of its subcontracts for the Project.
- d. Failure of the Contractor to meet the Section 3 goal described above shall be considered a material breach of the contract, and the

Owner may terminate the contract, withhold funds due to the Contractor, or take other actions as may be permitted by contract or otherwise.

- B. Apprenticeship Utilization Goals: (Applicable for contracts estimated to cost one million dollars or more)

The Contractor shall ensure that apprentices, registered with the Washington State Apprenticeship and Training Council ("SAC"), perform at least fifteen percent (15%) of the total Contract labor hours on this project.

1. Total Contract labor hours include the hours worked by supervisors, foremen, and superintendents if it is determined that they are subject to prevailing wage requirements pursuant to WAC 296-127-015 or federal labor standards and all hours worked as a result of change orders.
2. Total Contract labor hours do not include hours worked by foremen, superintendents, supervisors, owners, and workers who are not subject to prevailing wage requirements.
3. The Contractor shall include the apprentice utilization requirements in all subcontracts executed under this Contract and ensure that all subcontractors are notified of the apprentice utilization requirements.
4. The Contractor shall use good faith efforts to meet the 15% apprentice utilization requirements of the Contract, including overall compliance on all Contract labor hours worked by subcontractors.

5. The Contractor shall comply with the apprenticeship training standards for each trade/craft classification used on the Project, as set forth by the Washington

State Department of Labor and Industries.

C. Apprentice Utilization Monitoring and Enforcement

1. The Owner's Representative will verify the registration of each apprentice used on the Project with the Washington State Apprenticeship and Training Council.
2. The Owner's Representative will monitor the apprentice utilization data provided by the Contractor. If the Contractor is deficient in its use of apprentices, the Owner's Representative will meet with the Contractor to discuss the reasons for the deficiency and help the Contractor develop a written Plan for rectifying the deficiency.
3. The Owner's Representative will make routine visits to the Site for the purpose of confirming the use of apprentices. The Contractor will provide access to the site to the person designated by Owner to make visits to the Site for the purpose of confirming the use of apprentices. The person designated will be required to abide by any applicable work rules and safety Plan.

D. Workforce Goals: The Owner has established employment goals for the workforce of the Project of not less than 21 percent minorities and 20 percent women, with an employment subgoal of 4.5 percent for minority women.

12.02 WOMEN AND MINORITY BUSINESS AND SECTION 3 BUSINESS UTILIZATION GOALS AND REQUIREMENTS

A. Women and Minority Business Enterprise (WMBE) Subcontractor Utilization Goal and Plan:

The Owner's aspirational goal for WMBE utilization is 14%. As part of the

Community Participation Plan to be submitted with the Bid or as otherwise specified, the Bidder shall document its plans for how it intends to solicit the participation of, and encourage the utilization of Small, Minority and Women Business Enterprises (hereinafter "WMBEs") on the Project. Consistent with the requirements of federal regulation HUD 2 CFR 200, the Bidder's plan must demonstrate the Bidder's commitment to take all necessary affirmative steps to provide contracting opportunities for WMBEs to the greatest extent possible. Such efforts shall include, but will not be limited to:

1. Identifying WMBE firms by a variety of methods, including but not limited to working with community based organizations, such as the Contractor's Resource Center (CRC) to identify a diverse group of Subcontractors.
2. Using a variety of recruitment methods, including but not limited to:
 - a. Participating in community job fairs, conferences, and trade shows
 - b. Advertising in local community publications
 - c. Placing Project information signs in strategic locations on the jobsite
 - d. Distributing bid notifications to targeted mailers/faxes
 - e. Hosting "Information Nights" for WMBE subcontractors at local area gathering places such as community centers and churches
3. Placing identified firms on formal and informal solicitation/bid lists.
4. Encouraging identified firms' participation through direct solicitation of bids or proposals whenever they are potential sources.
5. Encouraging the establishment of joint ventures among subcontractors between non-WMBE and WMBE subcontractors

and/or between two WMBE subcontractors in order to increase opportunities for as many Subcontractors as possible.

6. Advertising in minority and women's publications and/or submitting copies of competitive solicitations to minority and women's plan centers.
7. Establishing delivery schedules, where the requirement permits, which encourage participation by such firms.
8. Dividing total requirements, when economically feasible, into smaller tasks or quantities to permit maximum participation by such firms.
9. Encouraging subcontractors to subcontract with qualified WMBEs.
10. Using the services and assistance of the U. S. Small Business Administration (SBA), the State of Washington Office of Minority and Women's Business Enterprises (OMWBE), the Northwest Minority Business Council (NWMBC), and Minority Business Development Agency of the Department of Commerce.

B. Section 3 Benchmarks:

1. Section 3 Business Benchmarks: As specified in Section 3, the benchmarks for Section 3 on a PHA construction contract are:
 - a. For Section 3 Workers - 25 percent or more of the total number of labor hours worked by all workers employed with public housing financial assistance for SHA's fiscal year.
 - b. For Targeted Section 3 Workers - 5 percent or more of the total number of labor hours worked by all workers employed with public housing financial assistance for SHA's fiscal year.

2. Contractor will document in Part 3, the Community Participation Plan to be submitted with the bid, or as otherwise specified, use its best efforts to meet the benchmarks above with respect to the work to be performed under this Contract, and will prioritize its efforts in the manner required by Section 3. Contractor's efforts may include working closely with the Owner's job assistance offices to help identify potential Section 3 Workers and taking other actions or implementing procedures as Owner may reasonably request from time to time in order to maximize the number of labor hours performed by Section 3 Workers.

12.03 REPORTING REQUIREMENTS

- A. Contractor, for itself and all subcontractors, will submit to the Owner's Representative a monthly report in form and substance acceptable to Owner. Each monthly report is due no later than the time specified for the Contractor's Monthly Pay Application. If the reports are not submitted in a timely manner, the Contractor's progress payment for that month will not be processed.
- B. Contractor will report workforce and apprentice utilization data required by Owner beginning on the first day of work for each person. Contractor's first submittals are due at the end of the first month after the Contract start date specified in the Notice to Proceed, and at monthly intervals thereafter as specified above. Subcontractor submittals are due at the end of the month after they commenced work and monthly thereafter as specified above.
- C. Contractor will report the following information, or such additional information as required by Section 3 or by Owner, on each apprentice:
 1. Apprentice's Name
 2. Home Zip Code
 3. Employment Status: New Hire or Existing Staff
 4. Section 3 status

5. Trade/Craft
6. State Apprentice Registration I.D. Number
7. Program Sponsor and/or Hiring Source
8. Apprentice Progression Period or Percentage
9. Ethnicity/Gender
10. Labor hours for Reporting Period by Ethnicity/Gender

D. Contractor will report the following information, or such additional information as required by Section 3 or by Owner, on all apprentices:

1. Total labor hours and number of apprentice employees for reporting period by ethnicity and gender
2. Total apprentice labor hours and number of employees to-date
3. Total Section 3 apprentice labor hours and number of Section 3 employees for reporting period by ethnicity and gender
4. Total Section 3 apprentice labor hours and number of Section 3 employees to date
5. Other information as noted on the form

E. Contractor will report the following information, or such additional information as required by Section 3 or by Owner, on journey level employees:

1. Labor hours for reporting period by ethnicity and gender, for each trade/craft
2. Labor hours for reporting period for Section 3 employees
3. Total labor hours for Section 3 employees
4. Total journey level labor hours by ethnicity and gender, for each trade/craft
5. Total labor hours and number of journey level employees for reporting period by ethnicity and gender.
6. Total journey level labor hours and number of employees to-date
7. Summary information as noted on the reporting form

E. WMBE and Section 3 Business Reporting Requirements

1. On a weekly basis and in a form acceptable to Owner, Contractor shall submit to Owner's Representative a Subcontractors on Site Report which shall be completed by the Contractor for all Subcontractors performing work on the Contract for the previous week.

2. On a monthly basis, on a form acceptable to Owner, Contractor will document the Contractor's progress in meeting its Section 3 benchmarks and WMBE goal commitments.

F. Contractor will submit such other information as may be requested by Owner to verify compliance with the requirements of the Contract. Owner reserves the right to add, delete, or change as necessary, the information required.

G. Monthly Community Participation Plan Meetings: Contractor may be required to attend the Owner's monthly Section 3 Advisory Committee meetings to discuss implementation of the Community Participation Plan throughout the duration of the Project. At Owner's request, Contractor will ensure that specified subcontractor(s) attend the meeting.

12.04 VIOLATIONS

Any material violation of the mandatory requirements of the Contract will be considered a breach of the Contract and the Owner may withhold payment, stop the work for cause, or terminate the Contract for cause pursuant to the terms of the Contract.

State of Washington
Department of Labor & Industries
Prevailing Wage Section - Telephone 360-902-5335
PO Box 44540, Olympia, WA 98504-4540

Washington State Prevailing Wage

The PREVAILING WAGES listed here include both the hourly wage rate and the hourly rate of fringe benefits. On public works projects, worker's wage and benefit rates must add to not less than this total. A brief description of overtime calculation requirements are provided on the Benefit Code Key.

Journey Level Prevailing Wage Rates for the Effective Date: 02/20/2024

<u>County</u>	<u>Trade</u>	<u>Job Classification</u>	<u>Wage</u>	<u>Holiday</u>	<u>Overtime</u>	<u>Note</u>	<u>*Risk Class</u>
King	Asbestos Abatement Workers	Journey Level	\$59.07	<u>5D</u>	<u>1H</u>		View
King	Boilermakers	Journey Level	\$74.29	<u>5N</u>	<u>1C</u>		View
King	Brick Mason	Journey Level	\$69.07	<u>7E</u>	<u>1N</u>		View
King	Brick Mason	Pointer-Caulker-Cleaner	\$69.07	<u>7E</u>	<u>1N</u>		View
King	Building Service Employees	Janitor	\$29.33	<u>5S</u>	<u>2F</u>		View
King	Building Service Employees	Traveling Waxer/Shampooer	\$29.78	<u>5S</u>	<u>2F</u>		View
King	Building Service Employees	Window Cleaner (Non-Scaffold)	\$32.93	<u>5S</u>	<u>2F</u>		View
King	Building Service Employees	Window Cleaner (Scaffold)	\$33.93	<u>5S</u>	<u>2F</u>		View
King	Cabinet Makers (In Shop)	Journey Level	\$22.74		<u>1</u>		View
King	Carpenters	Acoustical Worker	\$74.96	<u>15J</u>	<u>4C</u>		View
King	Carpenters	Bridge, Dock And Wharf Carpenters	\$74.96	<u>15J</u>	<u>4C</u>		View
King	Carpenters	Floor Layer & Floor Finisher	\$74.96	<u>15J</u>	<u>4C</u>		View
King	Carpenters	Journey Level	\$74.96	<u>15J</u>	<u>4C</u>		View
King	Carpenters	Scaffold Erector	\$74.96	<u>15J</u>	<u>4C</u>		View
King	Cement Masons	Application of all Composition Mastic	\$72.87	<u>15J</u>	<u>4U</u>		View
King	Cement Masons	Application of all Epoxy Material	\$72.37	<u>15J</u>	<u>4U</u>		View
King	Cement Masons	Application of all Plastic Material	\$72.87	<u>15J</u>	<u>4U</u>		View
King	Cement Masons	Application of Sealing Compound	\$72.37	<u>15J</u>	<u>4U</u>		View
King	Cement Masons	Application of Underlayment	\$72.87	<u>15J</u>	<u>4U</u>		View
King	Cement Masons	Building General	\$72.37	<u>15J</u>	<u>4U</u>		View
King	Cement Masons	Composition or Kalman Floors	\$72.87	<u>15J</u>	<u>4U</u>		View
King	Cement Masons	Concrete Paving	\$72.37	<u>15J</u>	<u>4U</u>		View
King	Cement Masons	Curb & Gutter Machine	\$72.87	<u>15J</u>	<u>4U</u>		View
King	Cement Masons	Curb & Gutter, Sidewalks	\$72.37	<u>15J</u>	<u>4U</u>		View
King	Cement Masons	Curing Concrete	\$72.37	<u>15J</u>	<u>4U</u>		View
King	Cement Masons	Finish Colored Concrete	\$72.87	<u>15J</u>	<u>4U</u>		View

King	Cement Masons	Floor Grinding	\$72.87	15J	4U		View
King	Cement Masons	Floor Grinding/Polisher	\$72.37	15J	4U		View
King	Cement Masons	Green Concrete Saw, self-powered	\$72.87	15J	4U		View
King	Cement Masons	Grouting of all Plates	\$72.37	15J	4U		View
King	Cement Masons	Grouting of all Tilt-up Panels	\$72.37	15J	4U		View
King	Cement Masons	Guniting Nozzleman	\$72.87	15J	4U		View
King	Cement Masons	Hand Powered Grinder	\$72.87	15J	4U		View
King	Cement Masons	Journey Level	\$72.37	15J	4U		View
King	Cement Masons	Patching Concrete	\$72.37	15J	4U		View
King	Cement Masons	Pneumatic Power Tools	\$72.87	15J	4U		View
King	Cement Masons	Power Chipping & Brushing	\$72.87	15J	4U		View
King	Cement Masons	Sand Blasting Architectural Finish	\$72.87	15J	4U		View
King	Cement Masons	Screed & Rodding Machine	\$72.87	15J	4U		View
King	Cement Masons	Spackling or Skim Coat Concrete	\$72.37	15J	4U		View
King	Cement Masons	Troweling Machine Operator	\$72.87	15J	4U		View
King	Cement Masons	Troweling Machine Operator on Colored Slabs	\$72.87	15J	4U		View
King	Cement Masons	Tunnel Workers	\$72.87	15J	4U		View
King	Divers & Tenders	Bell/Vehicle or Submersible Operator (Not Under Pressure)	\$129.71	15J	4C		View
King	Divers & Tenders	Dive Supervisor/Master	\$93.94	15J	4C		View
King	Divers & Tenders	Diver	\$129.71	15J	4C	8V	View
King	Divers & Tenders	Diver On Standby	\$88.94	15J	4C		View
King	Divers & Tenders	Diver Tender	\$80.82	15J	4C		View
King	Divers & Tenders	Hyperbaric Worker - Compressed Air Worker 0-30.00 PSI	\$93.26	15J	4C		View
King	Divers & Tenders	Hyperbaric Worker - Compressed Air Worker 30.01 - 44.00 PSI	\$98.26	15J	4C		View
King	Divers & Tenders	Hyperbaric Worker - Compressed Air Worker 44.01 - 54.00 PSI	\$102.26	15J	4C		View
King	Divers & Tenders	Hyperbaric Worker - Compressed Air Worker 54.01 - 60.00 PSI	\$107.26	15J	4C		View
King	Divers & Tenders	Hyperbaric Worker - Compressed Air Worker 60.01 - 64.00 PSI	\$109.76	15J	4C		View
King	Divers & Tenders	Hyperbaric Worker - Compressed Air Worker 64.01 - 68.00 PSI	\$114.76	15J	4C		View
King	Divers & Tenders	Hyperbaric Worker - Compressed Air Worker 68.01 - 70.00 PSI	\$116.76	15J	4C		View
King	Divers & Tenders	Hyperbaric Worker - Compressed Air Worker 70.01 - 72.00 PSI	\$118.76	15J	4C		View

King	Divers & Tenders	Hyperbaric Worker - Compressed Air Worker 72.01 - 74.00 PSI	\$120.76	15J	4C		View
King	Divers & Tenders	Manifold Operator	\$80.82	15J	4C		View
King	Divers & Tenders	Manifold Operator Mixed Gas	\$85.82	15J	4C		View
King	Divers & Tenders	Remote Operated Vehicle Operator/Technician	\$80.82	15J	4C		View
King	Divers & Tenders	Remote Operated Vehicle Tender	\$75.41	15J	4C		View
King	Dredge Workers	Assistant Engineer	\$79.62	5D	3F		View
King	Dredge Workers	Assistant Mate (Deckhand)	\$79.01	5D	3F		View
King	Dredge Workers	Boatmen	\$79.62	5D	3F		View
King	Dredge Workers	Engineer Welder	\$81.15	5D	3F		View
King	Dredge Workers	Leverman, Hydraulic	\$82.77	5D	3F		View
King	Dredge Workers	Mates	\$79.62	5D	3F		View
King	Dredge Workers	Oiler	\$79.01	5D	3F		View
King	Drywall Applicator	Journey Level	\$74.96	15J	4C		View
King	Drywall Tapers	Journey Level	\$74.50	5P	1E		View
King	Electrical Fixture Maintenance Workers	Journey Level	\$37.19	5L	1E		View
King	Electricians - Inside	Cable Splicer	\$105.59	7C	4E		View
King	Electricians - Inside	Cable Splicer (tunnel)	\$113.52	7C	4E		View
King	Electricians - Inside	Certified Welder	\$101.98	7C	4E		View
King	Electricians - Inside	Certified Welder (tunnel)	\$109.56	7C	4E		View
King	Electricians - Inside	Construction Stock Person	\$49.28	7C	4E		View
King	Electricians - Inside	Journey Level	\$98.38	7C	4E		View
King	Electricians - Inside	Journey Level (tunnel)	\$105.59	7C	4E		View
King	Electricians - Motor Shop	Journey Level	\$48.68	5A	1B		View
King	Electricians - Powerline Construction	Cable Splicer	\$93.00	5A	4D		View
King	Electricians - Powerline Construction	Certified Line Welder	\$85.42	5A	4D		View
King	Electricians - Powerline Construction	Groundperson	\$55.27	5A	4D		View
King	Electricians - Powerline Construction	Heavy Line Equipment Operator	\$85.42	5A	4D		View
King	Electricians - Powerline Construction	Journey Level Lineperson	\$85.42	5A	4D		View
King	Electricians - Powerline Construction	Line Equipment Operator	\$73.35	5A	4D		View
King	Electricians - Powerline Construction	Meter Installer	\$55.27	5A	4D	8W	View
King	Electricians - Powerline Construction	Pole Sprayer	\$85.42	5A	4D		View
King	Electricians - Powerline Construction	Powderperson	\$63.50	5A	4D		View
King	Electronic Technicians	Journey Level	\$63.38	7E	1E		View
King	Elevator Constructors	Mechanic	\$107.49	7D	4A		View
King	Elevator Constructors	Mechanic In Charge	\$116.13	7D	4A		View

King	Fabricated Precast Concrete Products	All Classifications - In-Factory Work Only	\$21.34	5B	1R		View
King	Fence Erectors	Fence Erector	\$50.07	15J	11P	8Y	View
King	Fence Erectors	Fence Laborer	\$50.07	15J	11P	8Y	View
King	Flaggers	Journey Level	\$50.07	15J	11P	8Y	View
King	Glaziers	Journey Level	\$79.16	7L	1Y		View
King	Heat & Frost Insulators And Asbestos Workers	Journey Level	\$87.15	15H	11C		View
King	Heating Equipment Mechanics	Journey Level	\$96.42	7F	1E		View
King	Hod Carriers & Mason Tenders	Journey Level	\$62.49	15J	11P	8Y	View
King	Industrial Power Vacuum Cleaner	Journey Level	\$16.28		1		View
King	Inland Boatmen	Boat Operator	\$61.41	5B	1K		View
King	Inland Boatmen	Cook	\$56.48	5B	1K		View
King	Inland Boatmen	Deckhand	\$57.48	5B	1K		View
King	Inland Boatmen	Deckhand Engineer	\$58.81	5B	1K		View
King	Inland Boatmen	Launch Operator	\$58.89	5B	1K		View
King	Inland Boatmen	Mate	\$57.31	5B	1K		View
King	Inspection/Cleaning/Sealing Of Sewer & Water Systems By Remote Control	Cleaner Operator	\$49.48	15M	11O		View
King	Inspection/Cleaning/Sealing Of Sewer & Water Systems By Remote Control	Foamer Operator	\$49.48	15M	11O		View
King	Inspection/Cleaning/Sealing Of Sewer & Water Systems By Remote Control	Grout Truck Operator	\$49.48	15M	11O		View
King	Inspection/Cleaning/Sealing Of Sewer & Water Systems By Remote Control	Head Operator	\$47.41	15M	11O		View
King	Inspection/Cleaning/Sealing Of Sewer & Water Systems By Remote Control	Technician	\$41.20	15M	11O		View
King	Inspection/Cleaning/Sealing Of Sewer & Water Systems By Remote Control	TV Truck Operator	\$44.31	15M	11O		View
King	Insulation Applicators	Journey Level	\$74.96	15J	4C		View
King	Ironworkers	Journeyman	\$85.80	15K	11N		View
King	Laborers	Air, Gas Or Electric Vibrating Screed	\$59.07	15J	11P	8Y	View
King	Laborers	Airtrac Drill Operator	\$60.90	15J	11P	8Y	View
King	Laborers	Ballast Regular Machine	\$59.07	15J	11P	8Y	View
King	Laborers	Batch Weighman	\$50.07	15J	11P	8Y	View
King	Laborers	Brick Pavers	\$59.07	15J	11P	8Y	View
King	Laborers	Brush Cutter	\$59.07	15J	11P	8Y	View
King	Laborers	Brush Hog Feeder	\$59.07	15J	11P	8Y	View
King	Laborers	Burner	\$59.07	15J	11P	8Y	View
King	Laborers	Caisson Worker	\$60.90	15J	11P	8Y	View
King	Laborers	Carpenter Tender	\$59.07	15J	11P	8Y	View
King	Laborers	Cement Dumper-paving	\$60.15	15J	11P	8Y	View

King	Laborers	Cement Finisher Tender	\$59.07	15J	11P	8Y	View
King	Laborers	Change House Or Dry Shack	\$59.07	15J	11P	8Y	View
King	Laborers	Chipping Gun (30 Lbs. And Over)	\$60.15	15J	11P	8Y	View
King	Laborers	Chipping Gun (Under 30 Lbs.)	\$59.07	15J	11P	8Y	View
King	Laborers	Choker Setter	\$59.07	15J	11P	8Y	View
King	Laborers	Chuck Tender	\$59.07	15J	11P	8Y	View
King	Laborers	Clary Power Spreader	\$60.15	15J	11P	8Y	View
King	Laborers	Clean-up Laborer	\$59.07	15J	11P	8Y	View
King	Laborers	Concrete Dumper/Chute Operator	\$60.15	15J	11P	8Y	View
King	Laborers	Concrete Form Stripper	\$59.07	15J	11P	8Y	View
King	Laborers	Concrete Placement Crew	\$60.15	15J	11P	8Y	View
King	Laborers	Concrete Saw Operator/Core Driller	\$60.15	15J	11P	8Y	View
King	Laborers	Crusher Feeder	\$50.07	15J	11P	8Y	View
King	Laborers	Curing Laborer	\$59.07	15J	11P	8Y	View
King	Laborers	Demolition: Wrecking & Moving (Incl. Charred Material)	\$59.07	15J	11P	8Y	View
King	Laborers	Ditch Digger	\$59.07	15J	11P	8Y	View
King	Laborers	Diver	\$60.90	15J	11P	8Y	View
King	Laborers	Drill Operator (Hydraulic, Diamond)	\$60.15	15J	11P	8Y	View
King	Laborers	Dry Stack Walls	\$59.07	15J	11P	8Y	View
King	Laborers	Dump Person	\$59.07	15J	11P	8Y	View
King	Laborers	Epoxy Technician	\$59.07	15J	11P	8Y	View
King	Laborers	Erosion Control Worker	\$59.07	15J	11P	8Y	View
King	Laborers	Faller & Bucker Chain Saw	\$60.15	15J	11P	8Y	View
King	Laborers	Fine Graders	\$59.07	15J	11P	8Y	View
King	Laborers	Firewatch	\$50.07	15J	11P	8Y	View
King	Laborers	Form Setter	\$60.15	15J	11P	8Y	View
King	Laborers	Gabian Basket Builders	\$59.07	15J	11P	8Y	View
King	Laborers	General Laborer	\$59.07	15J	11P	8Y	View
King	Laborers	Grade Checker & Transit Person	\$62.49	15J	11P	8Y	View
King	Laborers	Grinders	\$59.07	15J	11P	8Y	View
King	Laborers	Grout Machine Tender	\$59.07	15J	11P	8Y	View
King	Laborers	Groutmen (Pressure) Including Post Tension Beams	\$60.15	15J	11P	8Y	View
King	Laborers	Guardrail Erector	\$59.07	15J	11P	8Y	View
King	Laborers	Hazardous Waste Worker (Level A)	\$60.90	15J	11P	8Y	View
King	Laborers	Hazardous Waste Worker (Level B)	\$60.15	15J	11P	8Y	View
King	Laborers	Hazardous Waste Worker (Level C)	\$59.07	15J	11P	8Y	View
King	Laborers	High Scaler	\$60.90	15J	11P	8Y	View
King	Laborers	Jackhammer	\$60.15	15J	11P	8Y	View
King	Laborers	Laserbeam Operator	\$60.15	15J	11P	8Y	View

King	Laborers	Maintenance Person	\$59.07	15J	11P	8Y	View
King	Laborers	Manhole Builder-Mudman	\$60.15	15J	11P	8Y	View
King	Laborers	Material Yard Person	\$59.07	15J	11P	8Y	View
King	Laborers	Mold Abatement Worker	\$59.07	15J	11P	8Y	View
King	Laborers	Motorman-Dinky Locomotive	\$62.59	15J	11P	8Y	View
King	Laborers	nozzleman (concrete pump, green cutter when using combination of high pressure air & water on concrete & rock, sandblast, gunite, shotcrete, water blaster, vacuum blaster)	\$62.49	15J	11P	8Y	View
King	Laborers	Pavement Breaker	\$60.15	15J	11P	8Y	View
King	Laborers	Pilot Car	\$50.07	15J	11P	8Y	View
King	Laborers	Pipe Layer (Lead)	\$62.49	15J	11P	8Y	View
King	Laborers	Pipe Layer/Tailor	\$60.15	15J	11P	8Y	View
King	Laborers	Pipe Pot Tender	\$60.15	15J	11P	8Y	View
King	Laborers	Pipe Reliner	\$60.15	15J	11P	8Y	View
King	Laborers	Pipe Wrapper	\$60.15	15J	11P	8Y	View
King	Laborers	Pot Tender	\$59.07	15J	11P	8Y	View
King	Laborers	Powderman	\$60.90	15J	11P	8Y	View
King	Laborers	Powderman's Helper	\$59.07	15J	11P	8Y	View
King	Laborers	Power Jacks	\$60.15	15J	11P	8Y	View
King	Laborers	Railroad Spike Puller - Power	\$60.15	15J	11P	8Y	View
King	Laborers	Raker - Asphalt	\$62.49	15J	11P	8Y	View
King	Laborers	Re-timberman	\$60.90	15J	11P	8Y	View
King	Laborers	Remote Equipment Operator	\$60.15	15J	11P	8Y	View
King	Laborers	Rigger/Signal Person	\$60.15	15J	11P	8Y	View
King	Laborers	Rip Rap Person	\$59.07	15J	11P	8Y	View
King	Laborers	Rivet Buster	\$60.15	15J	11P	8Y	View
King	Laborers	Rodder	\$60.15	15J	11P	8Y	View
King	Laborers	Scaffold Erector	\$59.07	15J	11P	8Y	View
King	Laborers	Scale Person	\$59.07	15J	11P	8Y	View
King	Laborers	Sloper (Over 20")	\$60.15	15J	11P	8Y	View
King	Laborers	Sloper Sprayer	\$59.07	15J	11P	8Y	View
King	Laborers	Spreader (Concrete)	\$60.15	15J	11P	8Y	View
King	Laborers	Stake Hopper	\$59.07	15J	11P	8Y	View
King	Laborers	Stock Piler	\$59.07	15J	11P	8Y	View
King	Laborers	Swinging Stage/Boatswain Chair	\$50.07	15J	11P	8Y	View
King	Laborers	Tamper & Similar Electric, Air & Gas Operated Tools	\$60.15	15J	11P	8Y	View
King	Laborers	Tamper (Multiple & Self-propelled)	\$60.15	15J	11P	8Y	View
King	Laborers	Timber Person - Sewer (Lagger, Shorer & Cribber)	\$60.15	15J	11P	8Y	View
King	Laborers	Toolroom Person (at Jobsite)	\$59.07	15J	11P	8Y	View
King	Laborers	Topper	\$59.07	15J	11P	8Y	View
King	Laborers	Track Laborer	\$59.07	15J	11P	8Y	View

King	Laborers	Track Liner (Power)	\$60.15	15J	11P	8Y	View
King	Laborers	Traffic Control Laborer	\$53.54	15J	11P	9C	View
King	Laborers	Traffic Control Supervisor	\$56.73	15J	11P	9C	View
King	Laborers	Truck Spotter	\$59.07	15J	11P	8Y	View
King	Laborers	Tugger Operator	\$60.15	15J	11P	8Y	View
King	Laborers	Tunnel Work-Compressed Air Worker 0-30 psi	\$175.79	15J	11P	9B	View
King	Laborers	Tunnel Work-Compressed Air Worker 30.01-44.00 psi	\$180.82	15J	11P	9B	View
King	Laborers	Tunnel Work-Compressed Air Worker 44.01-54.00 psi	\$184.50	15J	11P	9B	View
King	Laborers	Tunnel Work-Compressed Air Worker 54.01-60.00 psi	\$190.20	15J	11P	9B	View
King	Laborers	Tunnel Work-Compressed Air Worker 60.01-64.00 psi	\$192.32	15J	11P	9B	View
King	Laborers	Tunnel Work-Compressed Air Worker 64.01-68.00 psi	\$197.42	15J	11P	9B	View
King	Laborers	Tunnel Work-Compressed Air Worker 68.01-70.00 psi	\$199.32	15J	11P	9B	View
King	Laborers	Tunnel Work-Compressed Air Worker 70.01-72.00 psi	\$201.32	15J	11P	9B	View
King	Laborers	Tunnel Work-Compressed Air Worker 72.01-74.00 psi	\$203.32	15J	11P	9B	View
King	Laborers	Tunnel Work-Guage and Lock Tender	\$62.59	15J	11P	8Y	View
King	Laborers	Tunnel Work-Miner	\$62.59	15J	11P	8Y	View
King	Laborers	Vibrator	\$60.15	15J	11P	8Y	View
King	Laborers	Vinyl Seamer	\$59.07	15J	11P	8Y	View
King	Laborers	Watchman	\$45.51	15J	11P	8Y	View
King	Laborers	Welder	\$60.15	15J	11P	8Y	View
King	Laborers	Well Point Laborer	\$60.15	15J	11P	8Y	View
King	Laborers	Window Washer/Cleaner	\$45.51	15J	11P	8Y	View
King	Laborers - Underground Sewer & Water	General Laborer & Topman	\$59.07	15J	11P	8Y	View
King	Laborers - Underground Sewer & Water	Pipe Layer	\$60.15	15J	11P	8Y	View
King	Landscape Construction	Landscape Construction/Landscaping Or Planting Laborers	\$45.51	15J	11P	8Y	View
King	Landscape Construction	Landscape Operator	\$82.25	15J	11G	8X	View
King	Landscape Maintenance	Groundskeeper	\$17.87		1		View
King	Lathers	Journey Level	\$74.96	15J	4C		View
King	Marble Setters	Journey Level	\$69.07	7E	1N		View
King	Metal Fabrication (In Shop)	Fitter/Certified Welder	\$42.17	15I	11E		View
King	Metal Fabrication (In Shop)	General Laborer	\$30.07	15I	11E		View
King	Metal Fabrication (In Shop)	Mechanic	\$43.63	15I	11E		View
King	Metal Fabrication (In Shop)	Welder/Burner	\$39.28	15I	11E		View
King	Millwright	Journey Level	\$76.51	15J	4C		View
King	Modular Buildings	Cabinet Assembly	\$16.28		1		View
King	Modular Buildings	Electrician	\$16.28		1		View

King	Modular Buildings	Equipment Maintenance	\$16.28		<u>1</u>		View
King	Modular Buildings	Plumber	\$16.28		<u>1</u>		View
King	Modular Buildings	Production Worker	\$16.28		<u>1</u>		View
King	Modular Buildings	Tool Maintenance	\$16.28		<u>1</u>		View
King	Modular Buildings	Utility Person	\$16.28		<u>1</u>		View
King	Modular Buildings	Welder	\$16.28		<u>1</u>		View
King	Painters	Journey Level	\$51.71	<u>6Z</u>	<u>11J</u>		View
King	Pile Driver	Crew Tender	\$80.82	<u>15J</u>	<u>4C</u>		View
King	Pile Driver	Journey Level	\$75.41	<u>15J</u>	<u>4C</u>		View
King	Plasterers	Journey Level	\$70.91	<u>7Q</u>	<u>1R</u>		View
King	Plasterers	Nozzleman	\$74.91	<u>7Q</u>	<u>1R</u>		View
King	Playground & Park Equipment Installers	Journey Level	\$16.28		<u>1</u>		View
King	Plumbers & Pipefitters	Journey Level	\$100.69	<u>6Z</u>	<u>1G</u>		View
King	Power Equipment Operators	Asphalt Plant Operators	\$83.62	<u>15J</u>	<u>11G</u>	<u>8X</u>	View
King	Power Equipment Operators	Assistant Engineer	\$78.65	<u>15J</u>	<u>11G</u>	<u>8X</u>	View
King	Power Equipment Operators	Barrier Machine (zipper)	\$82.88	<u>15J</u>	<u>11G</u>	<u>8X</u>	View
King	Power Equipment Operators	Batch Plant Operator: concrete	\$82.88	<u>15J</u>	<u>11G</u>	<u>8X</u>	View
King	Power Equipment Operators	Boat Operator	\$83.95	<u>7A</u>	<u>11H</u>	<u>8X</u>	View
King	Power Equipment Operators	Bobcat	\$78.65	<u>15J</u>	<u>11G</u>	<u>8X</u>	View
King	Power Equipment Operators	Brokk - Remote Demolition Equipment	\$78.65	<u>15J</u>	<u>11G</u>	<u>8X</u>	View
King	Power Equipment Operators	Brooms	\$78.65	<u>15J</u>	<u>11G</u>	<u>8X</u>	View
King	Power Equipment Operators	Bump Cutter	\$82.88	<u>15J</u>	<u>11G</u>	<u>8X</u>	View
King	Power Equipment Operators	Cableways	\$83.62	<u>15J</u>	<u>11G</u>	<u>8X</u>	View
King	Power Equipment Operators	Chipper	\$82.88	<u>15J</u>	<u>11G</u>	<u>8X</u>	View
King	Power Equipment Operators	Compressor	\$78.65	<u>15J</u>	<u>11G</u>	<u>8X</u>	View
King	Power Equipment Operators	Concrete Finish Machine - Laser Screed	\$78.65	<u>15J</u>	<u>11G</u>	<u>8X</u>	View
King	Power Equipment Operators	Concrete Pump - Mounted Or Trailer High Pressure Line Pump, Pump High Pressure	\$82.25	<u>15J</u>	<u>11G</u>	<u>8X</u>	View
King	Power Equipment Operators	Concrete Pump: Truck Mount With Boom Attachment Over 42 M	\$83.62	<u>15J</u>	<u>11G</u>	<u>8X</u>	View
King	Power Equipment Operators	Concrete Pump: Truck Mount With Boom Attachment Up To 42m	\$82.88	<u>15J</u>	<u>11G</u>	<u>8X</u>	View
King	Power Equipment Operators	Conveyors	\$82.25	<u>15J</u>	<u>11G</u>	<u>8X</u>	View
King	Power Equipment Operators	Cranes Friction: 200 tons and over	\$86.48	<u>7A</u>	<u>11H</u>	<u>8X</u>	View
King	Power Equipment Operators	Cranes, A-frame: 10 tons and under	\$78.95	<u>7A</u>	<u>11H</u>	<u>8X</u>	View
King	Power Equipment Operators	Cranes: 100 tons through 199 tons, or 150' of boom (including jib with attachments)	\$84.77	<u>7A</u>	<u>11H</u>	<u>8X</u>	View
King	Power Equipment Operators	Cranes: 20 tons through 44 tons with attachments	\$83.20	<u>7A</u>	<u>11H</u>	<u>8X</u>	View

King	Power Equipment Operators	Cranes: 200 tons- 299 tons, or 250' of boom including jib with attachments	\$85.66	7A	11H	8X	View
King	Power Equipment Operators	Cranes: 300 tons and over or 300' of boom including jib with attachments	\$86.48	7A	11H	8X	View
King	Power Equipment Operators	Cranes: 45 tons through 99 tons, under 150' of boom(including jib with attachments)	\$83.95	7A	11H	8X	View
King	Power Equipment Operators	Cranes: Friction cranes through 199 tons	\$85.66	7A	11H	8X	View
King	Power Equipment Operators	Cranes: through 19 tons with attachments, a-frame over 10 tons	\$82.56	7A	11H	8X	View
King	Power Equipment Operators	Crusher	\$82.88	15J	11G	8X	View
King	Power Equipment Operators	Deck Engineer/Deck Winches (power)	\$82.88	15J	11G	8X	View
King	Power Equipment Operators	Derricks, On Building Work	\$83.62	15J	11G	8X	View
King	Power Equipment Operators	Dozers D-9 & Under	\$82.25	15J	11G	8X	View
King	Power Equipment Operators	Drill Oilers: Auger Type, Truck Or Crane Mount	\$82.25	15J	11G	8X	View
King	Power Equipment Operators	Drilling Machine	\$84.46	15J	11G	8X	View
King	Power Equipment Operators	Elevator and man-lift: permanent and shaft type	\$78.65	15J	11G	8X	View
King	Power Equipment Operators	Finishing Machine, Bidwell And Gamaco & Similar Equipment	\$82.88	15J	11G	8X	View
King	Power Equipment Operators	Forklift: 3000 lbs and over with attachments	\$82.25	15J	11G	8X	View
King	Power Equipment Operators	Forklifts: under 3000 lbs. with attachments	\$78.65	15J	11G	8X	View
King	Power Equipment Operators	Grade Engineer: Using Blue Prints, Cut Sheets, Etc	\$82.88	15J	11G	8X	View
King	Power Equipment Operators	Gradechecker/Stakeman	\$78.65	15J	11G	8X	View
King	Power Equipment Operators	Guardrail Punch	\$82.88	15J	11G	8X	View
King	Power Equipment Operators	Hard Tail End Dump Articulating Off- Road Equipment 45 Yards. & Over	\$83.62	15J	11G	8X	View
King	Power Equipment Operators	Hard Tail End Dump Articulating Off-road Equipment Under 45 Yards	\$82.88	15J	11G	8X	View
King	Power Equipment Operators	Horizontal/Directional Drill Locator	\$82.25	15J	11G	8X	View
King	Power Equipment Operators	Horizontal/Directional Drill Operator	\$82.88	15J	11G	8X	View
King	Power Equipment Operators	Hydralifts/Boom Trucks Over 10 Tons	\$82.56	7A	11H	8X	View
King	Power Equipment Operators	Hydralifts/boom trucks: 10 tons and under	\$78.95	7A	11H	8X	View
King	Power Equipment Operators	Leverman	\$85.33	15J	11G	8X	View
King	Power Equipment Operators	Loader, Overhead, 6 Yards. But Not Including 8 Yards	\$83.62	15J	11G	8X	View

King	Power Equipment Operators	Loaders, Overhead Under 6 Yards	\$82.88	15J	11G	8X	View
King	Power Equipment Operators	Loaders, Plant Feed	\$82.88	15J	11G	8X	View
King	Power Equipment Operators	Loaders: Elevating Type Belt	\$82.25	15J	11G	8X	View
King	Power Equipment Operators	Locomotives, All	\$82.88	15J	11G	8X	View
King	Power Equipment Operators	Material Transfer Device	\$82.88	15J	11G	8X	View
King	Power Equipment Operators	Mechanics: All (Leadmen - \$0.50 per hour over mechanic)	\$84.46	15J	11G	8X	View
King	Power Equipment Operators	Motor Patrol Graders	\$83.62	15J	11G	8X	View
King	Power Equipment Operators	Mucking Machine, Mole, Tunnel Drill, Boring, Road Header And/or Shield	\$83.62	15J	11G	8X	View
King	Power Equipment Operators	Oil Distributors, Blower Distribution & Mulch Seeding Operator	\$78.65	15J	11G	8X	View
King	Power Equipment Operators	Outside Hoists (Elevators and Manlifts), Air Tuggers, Strato	\$82.25	15J	11G	8X	View
King	Power Equipment Operators	Overhead, bridge type Crane: 20 tons through 44 tons	\$83.20	7A	11H	8X	View
King	Power Equipment Operators	Overhead, bridge type: 100 tons and over	\$84.77	7A	11H	8X	View
King	Power Equipment Operators	Overhead, bridge type: 45 tons through 99 tons	\$83.95	7A	11H	8X	View
King	Power Equipment Operators	Pavement Breaker	\$78.65	15J	11G	8X	View
King	Power Equipment Operators	Pile Driver (other Than Crane Mount)	\$82.88	15J	11G	8X	View
King	Power Equipment Operators	Plant Oiler - Asphalt, Crusher	\$82.25	15J	11G	8X	View
King	Power Equipment Operators	Posthole Digger, Mechanical	\$78.65	15J	11G	8X	View
King	Power Equipment Operators	Power Plant	\$78.65	15J	11G	8X	View
King	Power Equipment Operators	Pumps - Water	\$78.65	15J	11G	8X	View
King	Power Equipment Operators	Quad 9, Hd 41, D10 And Over	\$83.62	15J	11G	8X	View
King	Power Equipment Operators	Quick Tower: no cab, under 100 feet in height base to boom	\$82.88	15J	11G	8X	View
King	Power Equipment Operators	Remote Control Operator On Rubber Tired Earth Moving Equipment	\$83.62	15J	11G	8X	View
King	Power Equipment Operators	Rigger and Bellman	\$78.95	7A	11H	8X	View
King	Power Equipment Operators	Rigger/Signal Person, Bellman(Certified)	\$82.56	7A	11H	8X	View
King	Power Equipment Operators	Rollagon	\$83.62	15J	11G	8X	View
King	Power Equipment Operators	Roller, Other Than Plant Mix	\$78.65	15J	11G	8X	View
King	Power Equipment Operators	Roller, Plant Mix Or Multi-lift Materials	\$82.25	15J	11G	8X	View
King	Power Equipment Operators	Roto-mill, Roto-grinder	\$82.88	15J	11G	8X	View
King	Power Equipment Operators	Saws - Concrete	\$82.25	15J	11G	8X	View
King	Power Equipment Operators	Scraper, Self Propelled Under 45 Yards	\$82.88	15J	11G	8X	View
King	Power Equipment Operators	Scrapers - Concrete & Carry All	\$82.25	15J	11G	8X	View
King	Power Equipment Operators	Scrapers, Self-propelled: 45 Yards And Over	\$83.62	15J	11G	8X	View

King	Power Equipment Operators	Service Engineers: Equipment	\$82.25	15J	11G	8X	View
King	Power Equipment Operators	Shotcrete/Gunite Equipment	\$78.65	15J	11G	8X	View
King	Power Equipment Operators	Shovel, Excavator, Backhoe, Tractors Under 15 Metric Tons	\$82.25	15J	11G	8X	View
King	Power Equipment Operators	Shovel, Excavator, Backhoe: Over 30 Metric Tons To 50 Metric Tons	\$83.62	15J	11G	8X	View
King	Power Equipment Operators	Shovel, Excavator, Backhoes, Tractors: 15 To 30 Metric Tons	\$82.88	15J	11G	8X	View
King	Power Equipment Operators	Shovel, Excavator, Backhoes: Over 50 Metric Tons To 90 Metric Tons	\$84.46	15J	11G	8X	View
King	Power Equipment Operators	Shovel, Excavator, Backhoes: Over 90 Metric Tons	\$85.33	15J	11G	8X	View
King	Power Equipment Operators	Slipform Pavers	\$83.62	15J	11G	8X	View
King	Power Equipment Operators	Spreader, Topsider & Screedman	\$83.62	15J	11G	8X	View
King	Power Equipment Operators	Subgrader Trimmer	\$82.88	15J	11G	8X	View
King	Power Equipment Operators	Tower Bucket Elevators	\$82.25	15J	11G	8X	View
King	Power Equipment Operators	Tower Crane: over 175' through 250' in height, base to boom	\$85.66	7A	11H	8X	View
King	Power Equipment Operators	Tower crane: up to 175' in height base to boom	\$84.77	7A	11H	8X	View
King	Power Equipment Operators	Tower Cranes: over 250' in height from base to boom	\$86.48	7A	11H	8X	View
King	Power Equipment Operators	Transporters, All Track Or Truck Type	\$83.62	15J	11G	8X	View
King	Power Equipment Operators	Trenching Machines	\$82.25	15J	11G	8X	View
King	Power Equipment Operators	Truck Crane Oiler/Driver: 100 tons and over	\$83.20	7A	11H	8X	View
King	Power Equipment Operators	Truck crane oiler/driver: under 100 tons	\$82.56	7A	11H	8X	View
King	Power Equipment Operators	Truck Mount Portable Conveyor	\$82.88	15J	11G	8X	View
King	Power Equipment Operators	Vac Truck (Vactor Guzzler, Hydro Excavator)	\$82.88	15J	11G	8X	View
King	Power Equipment Operators	Welder	\$83.62	15J	11G	8X	View
King	Power Equipment Operators	Wheel Tractors, Farmall Type	\$78.65	15J	11G	8X	View
King	Power Equipment Operators	Yo Yo Pay Dozer	\$82.88	15J	11G	8X	View
King	Power Equipment Operators-Underground Sewer & Water	Asphalt Plant Operators	\$83.62	15J	11G	8X	View
King	Power Equipment Operators-Underground Sewer & Water	Assistant Engineer	\$78.65	15J	11G	8X	View
King	Power Equipment Operators-Underground Sewer & Water	Barrier Machine (zipper)	\$82.88	15J	11G	8X	View
King	Power Equipment Operators-Underground Sewer & Water	Batch Plant Operator, Concrete	\$82.88	15J	11G	8X	View
King	Power Equipment Operators-Underground Sewer & Water	Boat Operator	\$83.95	7A	11H	8X	View
King	Power Equipment Operators-Underground Sewer & Water	Bobcat	\$78.65	15J	11G	8X	View
King	Power Equipment Operators-	Brokk - Remote Demolition	\$78.65	15J	11G	8X	View

	Underground Sewer & Water	Equipment					
King	Power Equipment Operators-Underground Sewer & Water	Brooms	\$78.65	15J	11G	8X	View
King	Power Equipment Operators-Underground Sewer & Water	Bump Cutter	\$82.88	15J	11G	8X	View
King	Power Equipment Operators-Underground Sewer & Water	Cableways	\$83.62	15J	11G	8X	View
King	Power Equipment Operators-Underground Sewer & Water	Chipper	\$82.88	15J	11G	8X	View
King	Power Equipment Operators-Underground Sewer & Water	Compressor	\$78.65	15J	11G	8X	View
King	Power Equipment Operators-Underground Sewer & Water	Concrete Finish Machine - Laser Screed	\$78.65	15J	11G	8X	View
King	Power Equipment Operators-Underground Sewer & Water	Concrete Pump - Mounted Or Trailer High Pressure Line Pump, Pump High Pressure	\$82.25	15J	11G	8X	View
King	Power Equipment Operators-Underground Sewer & Water	Concrete Pump: Truck Mount With Boom Attachment Over 42 M	\$83.62	15J	11G	8X	View
King	Power Equipment Operators-Underground Sewer & Water	Concrete Pump: Truck Mount With Boom Attachment Up To 42m	\$82.88	15J	11G	8X	View
King	Power Equipment Operators-Underground Sewer & Water	Conveyors	\$82.25	15J	11G	8X	View
King	Power Equipment Operators-Underground Sewer & Water	Cranes Friction: 200 tons and over	\$86.48	7A	11H	8X	View
King	Power Equipment Operators-Underground Sewer & Water	Cranes, A-frame: 10 tons and under	\$78.95	7A	11H	8X	View
King	Power Equipment Operators-Underground Sewer & Water	Cranes: 100 tons through 199 tons, or 150' of boom (including jib with attachments)	\$84.77	7A	11H	8X	View
King	Power Equipment Operators-Underground Sewer & Water	Cranes: 20 tons through 44 tons with attachments	\$83.20	7A	11H	8X	View
King	Power Equipment Operators-Underground Sewer & Water	Cranes: 200 tons- 299 tons, or 250' of boom including jib with attachments	\$85.66	7A	11H	8X	View
King	Power Equipment Operators-Underground Sewer & Water	Cranes: 300 tons and over or 300' of boom including jib with attachments	\$86.48	7A	11H	8X	View
King	Power Equipment Operators-Underground Sewer & Water	Cranes: 45 tons through 99 tons, under 150' of boom(including jib with attachments)	\$83.95	7A	11H	8X	View
King	Power Equipment Operators-Underground Sewer & Water	Cranes: Friction cranes through 199 tons	\$85.66	7A	11H	8X	View
King	Power Equipment Operators-Underground Sewer & Water	Cranes: through 19 tons with attachments, a-frame over 10 tons	\$82.56	7A	11H	8X	View
King	Power Equipment Operators-Underground Sewer & Water	Crusher	\$82.88	15J	11G	8X	View
King	Power Equipment Operators-Underground Sewer & Water	Deck Engineer/Deck Winches (power)	\$82.88	15J	11G	8X	View

King	Power Equipment Operators-Underground Sewer & Water	Derricks, On Building Work	\$83.62	15J	11G	8X	View
King	Power Equipment Operators-Underground Sewer & Water	Dozers D-9 & Under	\$82.25	15J	11G	8X	View
King	Power Equipment Operators-Underground Sewer & Water	Drill Oilers: Auger Type, Truck Or Crane Mount	\$82.25	15J	11G	8X	View
King	Power Equipment Operators-Underground Sewer & Water	Drilling Machine	\$84.46	15J	11G	8X	View
King	Power Equipment Operators-Underground Sewer & Water	Elevator and man-lift: permanent and shaft type	\$78.65	15J	11G	8X	View
King	Power Equipment Operators-Underground Sewer & Water	Finishing Machine, Bidwell And Gamaco & Similar Equipment	\$82.88	15J	11G	8X	View
King	Power Equipment Operators-Underground Sewer & Water	Forklift: 3000 lbs and over with attachments	\$82.25	15J	11G	8X	View
King	Power Equipment Operators-Underground Sewer & Water	Forklifts: under 3000 lbs. with attachments	\$78.65	15J	11G	8X	View
King	Power Equipment Operators-Underground Sewer & Water	Grade Engineer: Using Blue Prints, Cut Sheets, Etc	\$82.88	15J	11G	8X	View
King	Power Equipment Operators-Underground Sewer & Water	Gradechecker/Stakeman	\$78.65	15J	11G	8X	View
King	Power Equipment Operators-Underground Sewer & Water	Guardrail Punch	\$82.88	15J	11G	8X	View
King	Power Equipment Operators-Underground Sewer & Water	Hard Tail End Dump Articulating Off- Road Equipment 45 Yards. & Over	\$83.62	15J	11G	8X	View
King	Power Equipment Operators-Underground Sewer & Water	Hard Tail End Dump Articulating Off-road Equipment Under 45 Yards	\$82.88	15J	11G	8X	View
King	Power Equipment Operators-Underground Sewer & Water	Horizontal/Directional Drill Locator	\$82.25	15J	11G	8X	View
King	Power Equipment Operators-Underground Sewer & Water	Horizontal/Directional Drill Operator	\$82.88	15J	11G	8X	View
King	Power Equipment Operators-Underground Sewer & Water	Hydralifts/boom trucks: 10 tons and under	\$78.95	7A	11H	8X	View
King	Power Equipment Operators-Underground Sewer & Water	Hydralifts/boom trucks: over 10 tons	\$82.56	7A	11H	8X	View
King	Power Equipment Operators-Underground Sewer & Water	Leverman	\$85.33	15J	11G	8X	View
King	Power Equipment Operators-Underground Sewer & Water	Loader, Overhead, 6 Yards. But Not Including 8 Yards	\$83.62	15J	11G	8X	View
King	Power Equipment Operators-Underground Sewer & Water	Loaders, Overhead Under 6 Yards	\$82.88	15J	11G	8X	View
King	Power Equipment Operators-Underground Sewer & Water	Loaders, Plant Feed	\$82.88	15J	11G	8X	View
King	Power Equipment Operators-Underground Sewer & Water	Loaders: Elevating Type Belt	\$82.25	15J	11G	8X	View
King	Power Equipment Operators-Underground Sewer & Water	Locomotives, All	\$82.88	15J	11G	8X	View
King	Power Equipment Operators-Underground Sewer & Water	Material Transfer Device	\$82.88	15J	11G	8X	View
King	Power Equipment Operators-Underground Sewer & Water	Mechanics: All (Leadmen - \$0.50 per hour over mechanic)	\$84.46	15J	11G	8X	View

King	Power Equipment Operators-Underground Sewer & Water	Motor Patrol Graders	\$83.62	15J	11G	8X	View
King	Power Equipment Operators-Underground Sewer & Water	Mucking Machine, Mole, Tunnel Drill, Boring, Road Header And/or Shield	\$83.62	15J	11G	8X	View
King	Power Equipment Operators-Underground Sewer & Water	Oil Distributors, Blower Distribution & Mulch Seeding Operator	\$78.65	15J	11G	8X	View
King	Power Equipment Operators-Underground Sewer & Water	Outside Hoists (Elevators and Manlifts), Air Tuggers, Strato	\$82.25	15J	11G	8X	View
King	Power Equipment Operators-Underground Sewer & Water	Overhead, bridge type Crane: 20 tons through 44 tons	\$83.20	7A	11H	8X	View
King	Power Equipment Operators-Underground Sewer & Water	Overhead, bridge type: 100 tons and over	\$84.77	7A	11H	8X	View
King	Power Equipment Operators-Underground Sewer & Water	Overhead, bridge type: 45 tons through 99 tons	\$83.95	7A	11H	8X	View
King	Power Equipment Operators-Underground Sewer & Water	Pavement Breaker	\$78.65	15J	11G	8X	View
King	Power Equipment Operators-Underground Sewer & Water	Pile Driver (other Than Crane Mount)	\$82.88	15J	11G	8X	View
King	Power Equipment Operators-Underground Sewer & Water	Plant Oiler - Asphalt, Crusher	\$82.25	15J	11G	8X	View
King	Power Equipment Operators-Underground Sewer & Water	Posthole Digger, Mechanical	\$78.65	15J	11G	8X	View
King	Power Equipment Operators-Underground Sewer & Water	Power Plant	\$78.65	15J	11G	8X	View
King	Power Equipment Operators-Underground Sewer & Water	Pumps - Water	\$78.65	15J	11G	8X	View
King	Power Equipment Operators-Underground Sewer & Water	Quad 9, Hd 41, D10 And Over	\$83.62	15J	11G	8X	View
King	Power Equipment Operators-Underground Sewer & Water	Quick Tower: no cab, under 100 feet in height base to boom	\$82.88	15J	11G	8X	View
King	Power Equipment Operators-Underground Sewer & Water	Remote Control Operator On Rubber Tired Earth Moving Equipment	\$83.62	15J	11G	8X	View
King	Power Equipment Operators-Underground Sewer & Water	Rigger and Bellman	\$78.95	7A	11H	8X	View
King	Power Equipment Operators-Underground Sewer & Water	Rigger/Signal Person, Bellman(Certified)	\$82.56	7A	11H	8X	View
King	Power Equipment Operators-Underground Sewer & Water	Rollagon	\$83.62	15J	11G	8X	View
King	Power Equipment Operators-Underground Sewer & Water	Roller, Other Than Plant Mix	\$78.65	15J	11G	8X	View
King	Power Equipment Operators-Underground Sewer & Water	Roller, Plant Mix Or Multi-lift Materials	\$82.25	15J	11G	8X	View
King	Power Equipment Operators-Underground Sewer & Water	Roto-mill, Roto-grinder	\$82.88	15J	11G	8X	View
King	Power Equipment Operators-Underground Sewer & Water	Saws - Concrete	\$82.25	15J	11G	8X	View
King	Power Equipment Operators-Underground Sewer & Water	Scraper, Self Propelled Under 45 Yards	\$82.88	15J	11G	8X	View

King	Power Equipment Operators-Underground Sewer & Water	Scrapers - Concrete & Carry All	\$82.25	15J	11G	8X	View
King	Power Equipment Operators-Underground Sewer & Water	Scrapers, Self-propelled: 45 Yards And Over	\$83.62	15J	11G	8X	View
King	Power Equipment Operators-Underground Sewer & Water	Shotcrete/Gunite Equipment	\$78.65	15J	11G	8X	View
King	Power Equipment Operators-Underground Sewer & Water	Shovel, Excavator, Backhoe, Tractors Under 15 Metric Tons	\$82.25	15J	11G	8X	View
King	Power Equipment Operators-Underground Sewer & Water	Shovel, Excavator, Backhoe: Over 30 Metric Tons To 50 Metric Tons	\$83.62	15J	11G	8X	View
King	Power Equipment Operators-Underground Sewer & Water	Shovel, Excavator, Backhoes, Tractors: 15 To 30 Metric Tons	\$82.88	15J	11G	8X	View
King	Power Equipment Operators-Underground Sewer & Water	Shovel, Excavator, Backhoes: Over 50 Metric Tons To 90 Metric Tons	\$84.46	15J	11G	8X	View
King	Power Equipment Operators-Underground Sewer & Water	Shovel, Excavator, Backhoes: Over 90 Metric Tons	\$85.33	15J	11G	8X	View
King	Power Equipment Operators-Underground Sewer & Water	Slipform Pavers	\$83.62	15J	11G	8X	View
King	Power Equipment Operators-Underground Sewer & Water	Spreader, Topsider & Screedman	\$83.62	15J	11G	8X	View
King	Power Equipment Operators-Underground Sewer & Water	Subgrader Trimmer	\$82.88	15J	11G	8X	View
King	Power Equipment Operators-Underground Sewer & Water	Tower Bucket Elevators	\$82.25	15J	11G	8X	View
King	Power Equipment Operators-Underground Sewer & Water	Tower Crane: over 175' through 250' in height, base to boom	\$85.66	7A	11H	8X	View
King	Power Equipment Operators-Underground Sewer & Water	Tower crane: up to 175' in height base to boom	\$84.77	7A	11H	8X	View
King	Power Equipment Operators-Underground Sewer & Water	Tower Cranes: over 250' in height from base to boom	\$86.48	7A	11H	8X	View
King	Power Equipment Operators-Underground Sewer & Water	Transporters, All Track Or Truck Type	\$83.62	15J	11G	8X	View
King	Power Equipment Operators-Underground Sewer & Water	Trenching Machines	\$82.25	15J	11G	8X	View
King	Power Equipment Operators-Underground Sewer & Water	Truck Crane Oiler/Driver: 100 tons and over	\$83.20	7A	11H	8X	View
King	Power Equipment Operators-Underground Sewer & Water	Truck crane oiler/driver: under 100 tons	\$82.56	7A	11H	8X	View
King	Power Equipment Operators-Underground Sewer & Water	Truck Mount Portable Conveyor	\$82.88	15J	11G	8X	View
King	Power Equipment Operators-Underground Sewer & Water	Vac Truck (Vactor Guzzler, Hydro Excavator)	\$82.88	15J	11G	8X	View
King	Power Equipment Operators-Underground Sewer & Water	Welder	\$83.62	15J	11G	8X	View
King	Power Equipment Operators-Underground Sewer & Water	Wheel Tractors, Farmall Type	\$78.65	15J	11G	8X	View
King	Power Equipment Operators-Underground Sewer & Water	Yo Yo Pay Dozer	\$82.88	15J	11G	8X	View
King	Power Line Clearance Tree Trimmers	Journey Level In Charge	\$57.22	5A	4A		View

King	Power Line Clearance Tree Trimmers	Spray Person	\$54.32	5A	4A	View
King	Power Line Clearance Tree Trimmers	Tree Equipment Operator	\$57.22	5A	4A	View
King	Power Line Clearance Tree Trimmers	Tree Trimmer	\$51.18	5A	4A	View
King	Power Line Clearance Tree Trimmers	Tree Trimmer Groundperson	\$38.99	5A	4A	View
King	Refrigeration & Air Conditioning Mechanics	Journey Level	\$93.51	6Z	1G	View
King	Residential Brick Mason	Journey Level	\$69.07	7E	1N	View
King	Residential Carpenters	Journey Level	\$36.44		1	View
King	Residential Cement Masons	Journey Level	\$46.64		1	View
King	Residential Drywall Applicators	Journey Level	\$74.96	15J	4C	View
King	Residential Drywall Tapers	Journey Level	\$36.36		1	View
King	Residential Electricians	Journey Level	\$48.80		1	View
King	Residential Glaziers	Journey Level	\$28.93		1	View
King	Residential Insulation Applicators	Journey Level	\$28.18		1	View
King	Residential Laborers	Journey Level	\$29.73		1	View
King	Residential Marble Setters	Journey Level	\$27.38		1	View
King	Residential Painters	Journey Level	\$23.47		1	View
King	Residential Plumbers & Pipefitters	Journey Level	\$100.69	6Z	1G	View
King	Residential Refrigeration & Air Conditioning Mechanics	Journey Level	\$93.51	6Z	1G	View
King	Residential Sheet Metal Workers	Journey Level	\$96.42	7F	1E	View
King	Residential Soft Floor Layers	Journey Level	\$57.11	5A	3J	View
King	Residential Sprinkler Fitters (Fire Protection)	Journey Level	\$58.26	5C	2R	View
King	Residential Stone Masons	Journey Level	\$69.07	7E	1N	View
King	Residential Terrazzo Workers	Journey Level	\$62.36	7E	1N	View
King	Residential Terrazzo/Tile Finishers	Journey Level	\$24.39		1	View
King	Residential Tile Setters	Journey Level	\$21.04		1	View
King	Roofers	Journey Level	\$61.95	5A	3H	View
King	Roofers	Using Irritable Bituminous Materials	\$64.95	5A	3H	View
King	Sheet Metal Workers	Journey Level (Field or Shop)	\$96.42	7F	1E	View
King	Shipbuilding & Ship Repair	New Construction Boilermaker	\$51.85	7X	4J	View
King	Shipbuilding & Ship Repair	New Construction Carpenter	\$51.85	7X	4J	View
King	Shipbuilding & Ship Repair	New Construction Crane Operator	\$41.83	7V	1	View
King	Shipbuilding & Ship Repair	New Construction Electrician	\$51.85	7X	4J	View
King	Shipbuilding & Ship Repair	New Construction Heat & Frost Insulator	\$87.15	15H	11C	View
King	Shipbuilding & Ship Repair	New Construction Laborer	\$51.85	7X	4J	View
King	Shipbuilding & Ship Repair	New Construction Machinist	\$51.85	7X	4J	View

King	Shipbuilding & Ship Repair	New Construction Operating Engineer	\$41.83	<u>7V</u>	<u>1</u>		View
King	Shipbuilding & Ship Repair	New Construction Painter	\$51.95	<u>7X</u>	<u>4J</u>		View
King	Shipbuilding & Ship Repair	New Construction Pipefitter	\$51.85	<u>7X</u>	<u>4J</u>		View
King	Shipbuilding & Ship Repair	New Construction Rigger	\$51.85	<u>7X</u>	<u>4J</u>		View
King	Shipbuilding & Ship Repair	New Construction Sheet Metal	\$51.85	<u>7X</u>	<u>4J</u>		View
King	Shipbuilding & Ship Repair	New Construction Shipwright	\$51.85	<u>7X</u>	<u>4J</u>		View
King	Shipbuilding & Ship Repair	New Construction Warehouse/Teamster	\$41.83	<u>7V</u>	<u>1</u>		View
King	Shipbuilding & Ship Repair	New Construction Welder / Burner	\$51.85	<u>7X</u>	<u>4J</u>		View
King	Shipbuilding & Ship Repair	Ship Repair Boilermaker	\$51.85	<u>7X</u>	<u>4J</u>		View
King	Shipbuilding & Ship Repair	Ship Repair Carpenter	\$51.85	<u>7X</u>	<u>4J</u>		View
King	Shipbuilding & Ship Repair	Ship Repair Crane Operator	\$45.06	<u>7Y</u>	<u>4K</u>		View
King	Shipbuilding & Ship Repair	Ship Repair Electrician	\$51.85	<u>7X</u>	<u>4J</u>		View
King	Shipbuilding & Ship Repair	Ship Repair Heat & Frost Insulator	\$87.15	<u>15H</u>	<u>11C</u>		View
King	Shipbuilding & Ship Repair	Ship Repair Laborer	\$51.85	<u>7X</u>	<u>4J</u>		View
King	Shipbuilding & Ship Repair	Ship Repair Machinist	\$51.85	<u>7X</u>	<u>4J</u>		View
King	Shipbuilding & Ship Repair	Ship Repair Operating Engineer	\$45.06	<u>7Y</u>	<u>4K</u>		View
King	Shipbuilding & Ship Repair	Ship Repair Painter	\$51.95	<u>7X</u>	<u>4J</u>		View
King	Shipbuilding & Ship Repair	Ship Repair Pipefitter	\$51.85	<u>7X</u>	<u>4J</u>		View
King	Shipbuilding & Ship Repair	Ship Repair Rigger	\$51.85	<u>7X</u>	<u>4J</u>		View
King	Shipbuilding & Ship Repair	Ship Repair Sheet Metal	\$51.85	<u>7X</u>	<u>4J</u>		View
King	Shipbuilding & Ship Repair	Ship Repair Shipwright	\$51.85	<u>7X</u>	<u>4J</u>		View
King	Shipbuilding & Ship Repair	Ship Repair Warehouse / Teamster	\$45.06	<u>7Y</u>	<u>4K</u>		View
King	Sign Makers & Installers (Electrical)	Journey Level	\$58.04	<u>0</u>	<u>1</u>		View
King	Sign Makers & Installers (Non-Electrical)	Journey Level	\$37.08	<u>0</u>	<u>1</u>		View
King	Soft Floor Layers	Journey Level	\$66.32	<u>15J</u>	<u>4C</u>		View
King	Solar Controls For Windows	Journey Level	\$16.28		<u>1</u>		View
King	Sprinkler Fitters (Fire Protection)	Journey Level	\$93.99	<u>5C</u>	<u>1X</u>		View
King	Stage Rigging Mechanics (Non Structural)	Journey Level	\$16.28		<u>1</u>		View
King	Stone Masons	Journey Level	\$69.07	<u>7E</u>	<u>1N</u>		View
King	Street And Parking Lot Sweeper Workers	Journey Level	\$19.09		<u>1</u>		View
King	Surveyors	Assistant Construction Site Surveyor	\$82.56	<u>7A</u>	<u>11H</u>	<u>8X</u>	View
King	Surveyors	Chainman	\$78.95	<u>7A</u>	<u>11H</u>	<u>8X</u>	View
King	Surveyors	Construction Site Surveyor	\$83.95	<u>7A</u>	<u>11H</u>	<u>8X</u>	View
King	Surveyors	Drone Operator (when used in conjunction with survey work only)	\$78.95	<u>7A</u>	<u>11H</u>	<u>8X</u>	View
King	Surveyors	Ground Penetrating Radar Operator	\$78.95	<u>7A</u>	<u>11H</u>	<u>8X</u>	View
King	Telecommunication Technicians	Journey Level	\$63.38	<u>7E</u>	<u>1E</u>		View

King	Telephone Line Construction - Outside	Cable Splicer	\$40.11	<u>5A</u>	<u>2B</u>		View
King	Telephone Line Construction - Outside	Hole Digger/Ground Person	\$26.67	<u>5A</u>	<u>2B</u>		View
King	Telephone Line Construction - Outside	Telephone Equipment Operator (Light)	\$33.49	<u>5A</u>	<u>2B</u>		View
King	Telephone Line Construction - Outside	Telephone Lineperson	\$37.90	<u>5A</u>	<u>2B</u>		View
King	Terrazzo Workers	Journey Level	\$62.36	<u>7E</u>	<u>1N</u>		View
King	Tile Setters	Journey Level	\$62.36	<u>7E</u>	<u>1N</u>		View
King	Tile, Marble & Terrazzo Finishers	Finisher	\$53.19	<u>7E</u>	<u>1N</u>		View
King	Traffic Control Stripers	Journey Level	\$89.54	<u>15L</u>	<u>1K</u>		View
King	Truck Drivers	Asphalt Mix Over 16 Yards	\$74.95	<u>15J</u>	<u>11M</u>	<u>8L</u>	View
King	Truck Drivers	Asphalt Mix To 16 Yards	\$74.02	<u>15J</u>	<u>11M</u>	<u>8L</u>	View
King	Truck Drivers	Dump Truck	\$74.02	<u>15J</u>	<u>11M</u>	<u>8L</u>	View
King	Truck Drivers	Dump Truck & Trailer	\$74.95	<u>15J</u>	<u>11M</u>	<u>8L</u>	View
King	Truck Drivers	Other Trucks	\$74.95	<u>15J</u>	<u>11M</u>	<u>8L</u>	View
King	Truck Drivers - Ready Mix	Transit Mix	\$74.95	<u>15J</u>	<u>11M</u>	<u>8L</u>	View
King	Well Drillers & Irrigation Pump Installers	Irrigation Pump Installer	\$17.71		<u>1</u>		View
King	Well Drillers & Irrigation Pump Installers	Oiler	\$16.28		<u>1</u>		View
King	Well Drillers & Irrigation Pump Installers	Well Driller	\$18.00		<u>1</u>		View

Benefit Code Key – Effective 8/31/2023 thru 3/1/2024

Overtime Codes

Overtime calculations are based on the hourly rate actually paid to the worker. On public works projects, the hourly rate must be not less than the prevailing rate of wage minus the hourly rate of the cost of fringe benefits actually provided for the worker.

1. ALL HOURS WORKED IN EXCESS OF EIGHT (8) HOURS PER DAY OR FORTY (40) HOURS PER WEEK SHALL BE PAID AT ONE AND ONE-HALF TIMES THE HOURLY RATE OF WAGE.
 - B. All hours worked on Saturdays shall be paid at one and one-half times the hourly rate of wage. All hours worked on Sundays and holidays shall be paid at double the hourly rate of wage.
 - C. The first two (2) hours after eight (8) regular hours Monday through Friday and the first ten (10) hours on Saturday shall be paid at one and one-half times the hourly rate of wage. All other overtime hours and all hours worked on Sundays and holidays shall be paid at double the hourly rate of wage.
 - D. The first two (2) hours before or after a five-eight (8) hour workweek day or a four-ten (10) hour workweek day and the first eight (8) hours worked the next day after either workweek shall be paid at one and one-half times the hourly rate of wage. All additional hours worked and all worked on Sundays and holidays shall be paid at double the hourly rate of wage.
 - E. The first two (2) hours after eight (8) regular hours Monday through Friday and the first eight (8) hours on Saturday shall be paid at one and one-half times the hourly rate of wage. All other hours worked Monday through Saturday, and all hours worked on Sundays and holidays shall be paid at double the hourly rate of wage.
 - F. The first two (2) hours after eight (8) regular hours Monday through Friday and the first ten (10) hours on Saturday shall be paid at one and one-half times the hourly rate of wage. All other overtime hours worked, except Labor Day, shall be paid at double the hourly rate of wage. All hours worked on Labor Day shall be paid at three times the hourly rate of wage.
 - G. The first ten (10) hours worked on Saturdays and the first ten (10) hours worked on a fifth calendar weekday in a four-ten hour schedule, shall be paid at one and one-half times the hourly rate of wage. All hours worked in excess of ten (10) hours per day Monday through Saturday and all hours worked on Sundays and holidays shall be paid at double the hourly rate of wage.
 - H. All hours worked on Saturdays (except makeup days if work is lost due to inclement weather conditions or equipment breakdown) shall be paid at one and one-half times the hourly rate of wage. All hours worked Monday through Saturday over twelve (12) hours and all hours worked on Sundays and holidays shall be paid at double the hourly rate of wage.
 - I. All hours worked on Sundays and holidays shall also be paid at double the hourly rate of wage.
 - J. The first two (2) hours after eight (8) regular hours Monday through Friday and the first ten (10) hours on Saturday shall be paid at one and one-half times the hourly rate of wage. All hours worked over ten (10) hours Monday through Saturday, Sundays and holidays shall be paid at double the hourly rate of wage.
 - K. All hours worked on Saturdays and Sundays shall be paid at one and one-half times the hourly rate of wage. All hours worked on holidays shall be paid at double the hourly rate of wage.
 - M. All hours worked on Saturdays (except makeup days if work is lost due to inclement weather conditions) shall be paid at one and one-half times the hourly rate of wage. All hours worked on Sundays and holidays shall be paid at double the hourly rate of wage.
 - N. All hours worked on Saturdays (except makeup days) shall be paid at one and one-half times the hourly rate of wage. All hours worked on Sundays and holidays shall be paid at double the hourly rate of wage.

Overtime Codes Continued

1. O. The first ten (10) hours worked on Saturday shall be paid at one and one-half times the hourly rate of wage. All hours worked on Sundays, holidays and after twelve (12) hours, Monday through Friday and after ten (10) hours on Saturday shall be paid at double the hourly rate of wage.
- P. All hours worked on Saturdays (except makeup days if circumstances warrant) and Sundays shall be paid at one and one-half times the hourly rate of wage. All hours worked on holidays shall be paid at double the hourly rate of wage.
- Q. The first two (2) hours after eight (8) regular hours Monday through Friday and up to ten (10) hours worked on Saturdays shall be paid at one and one-half times the hourly rate of wage. All hours worked in excess of ten (10) hours per day Monday through Saturday and all hours worked on Sundays and holidays (except Christmas day) shall be paid at double the hourly rate of wage. All hours worked on Christmas day shall be paid at two and one-half times the hourly rate of wage.
- R. All hours worked on Sundays and holidays shall be paid at two times the hourly rate of wage.
- U. All hours worked on Saturdays shall be paid at one and one-half times the hourly rate of wage. All hours worked on Sundays and holidays (except Labor Day) shall be paid at two times the hourly rate of wage. All hours worked on Labor Day shall be paid at three times the hourly rate of wage.
- V. All hours worked on Sundays and holidays (except Thanksgiving Day and Christmas day) shall be paid at one and one-half times the hourly rate of wage. All hours worked on Thanksgiving Day and Christmas day shall be paid at double the hourly rate of wage.
- W. All hours worked on Saturdays and Sundays (except make-up days due to conditions beyond the control of the employer) shall be paid at one and one-half times the hourly rate of wage. All hours worked on holidays shall be paid at double the hourly rate of wage.
- X. The first four (4) hours after eight (8) regular hours Monday through Friday and the first twelve (12) hours on Saturday shall be paid at one and one-half times the hourly rate of wage. All hours worked over twelve (12) hours Monday through Saturday, Sundays and holidays shall be paid at double the hourly rate of wage. When holiday falls on Saturday or Sunday, the day before Saturday, Friday, and the day after Sunday, Monday, shall be considered the holiday and all work performed shall be paid at double the hourly rate of wage.
- Y. All hours worked outside the hours of 5:00 am and 5:00 pm (or such other hours as may be agreed upon by any employer and the employee) and all hours worked in excess of eight (8) hours per day (10 hours per day for a 4 x 10 workweek) and on Saturdays and holidays (except labor day) shall be paid at one and one-half times the hourly rate of wage. (except for employees who are absent from work without prior approval on a scheduled workday during the workweek shall be paid at the straight-time rate until they have worked 8 hours in a day (10 in a 4 x 10 workweek) or 40 hours during that workweek.) All hours worked Monday through Saturday over twelve (12) hours and all hours worked on Sundays and Labor Day shall be paid at double the hourly rate of wage.
- Z. All hours worked on Saturdays and Sundays shall be paid at one and one-half times the hourly rate of wage. All hours worked on holidays shall be paid the straight time rate of pay in addition to holiday pay.

Overtime Codes Continued

2. ALL HOURS WORKED IN EXCESS OF EIGHT (8) HOURS PER DAY OR FORTY (40) HOURS PER WEEK SHALL BE PAID AT ONE AND ONE-HALF TIMES THE HOURLY RATE OF WAGE.
- B. All hours worked on holidays shall be paid at one and one-half times the hourly rate of wage.
 - F. The first eight (8) hours worked on holidays shall be paid at the straight hourly rate of wage in addition to the holiday pay. All hours worked in excess of eight (8) hours on holidays shall be paid at double the hourly rate of wage.
 - M. This code appears to be missing. All hours worked on Saturdays, Sundays and holidays shall be paid at double the hourly rate of wage.
 - R. All hours worked on Sundays and holidays and all hours worked over sixty (60) in one week shall be paid at double the hourly rate of wage.
 - U. All hours worked on Saturdays shall be paid at one and one-half times the hourly rate of wage. All hours worked over 12 hours in a day or on Sundays and holidays shall be paid at double the hourly rate of wage.
3. ALL HOURS WORKED IN EXCESS OF EIGHT (8) HOURS PER DAY OR FORTY (40) HOURS PER WEEK SHALL BE PAID AT ONE AND ONE-HALF TIMES THE HOURLY RATE OF WAGE.
- F. All hours worked on Saturday shall be paid at one and one-half times the hourly rate of wage. All hours worked on Sunday shall be paid at two times the hourly rate of wage. All hours worked on paid holidays shall be paid at two and one-half times the hourly rate of wage including holiday pay.
 - H. All work performed on Sundays between March 16th and October 14th and all Holidays shall be compensated for at two (2) times the regular rate of pay. Work performed on Sundays between October 15th and March 15th shall be compensated at one and one half (1-1/2) times the regular rate of pay.
 - J. All hours worked between the hours of 10:00 pm and 5:00 am, Monday through Friday, and all hours worked on Saturdays shall be paid at a one and one-half times the hourly rate of wage. All hours worked on Sundays and holidays shall be paid at double the hourly rate of wage.
 - K. Work performed in excess of eight (8) hours of straight time per day, or ten (10) hours of straight time per day when four ten (10) hour shifts are established, or forty (40) hours of straight time per week, Monday through Friday, or outside the normal 5 am to 6pm shift, and all work on Saturdays shall be paid at one and one-half times the hourly rate of wage. All work performed after 6:00 pm Saturday to 5:00 am Monday and Holidays, and all hours worked in excess of twelve (12) hours in a single shift shall be paid at double the hourly rate of wage.

After an employee has worked eight (8) hours at an applicable overtime rate, all additional hours shall be at the applicable overtime rate until such time as the employee has had a break of eight (8) hours or more. When an employee returns to work without at least eight (8) hours time off since their previous shift, all such time shall be a continuation of shift and paid at the applicable overtime rate until he/she shall have the eight (8) hours rest period.

Overtime Codes Continued

4. ALL HOURS WORKED IN EXCESS OF EIGHT (8) HOURS PER DAY OR FORTY (40) HOURS PER WEEK SHALL BE PAID AT ONE AND ONE-HALF TIMES THE HOURLY RATE OF WAGE.

- A. All hours worked in excess of eight (8) hours per day or forty (40) hours per week shall be paid at double the hourly rate of wage. All hours worked on Saturdays, Sundays and holidays shall be paid at double the hourly rate of wage
- C. On Monday through Friday, the first four (4) hours of overtime after eight (8) hours of straight time work shall be paid at one and one half (1-1/2) times the straight time rate of pay, unless a four (4) day ten (10) hour workweek has been established. On a four (4) day ten (10) hour workweek scheduled Monday through Thursday, or Tuesday through Friday, the first two (2) hours of overtime after ten (10) hours of straight time work shall be paid at one and one half (1-1/2) times the straight time rate of pay. On Saturday, the first twelve (12) hours of work shall be paid at one and one half (1-1/2) times the straight time rate of pay, except that if the job is down on Monday through Friday due to weather conditions or other conditions outside the control of the employer, the first ten (10) hours on Saturday may be worked at the straight time rate of pay. All hours worked over twelve (12) hours in a day and all hours worked on Sunday and Holidays shall be paid at two (2) times the straight time rate of pay.
- D. All hours worked in excess of eight (8) hours per day or forty (40) hours per week shall be paid at double the hourly rate of wage. All hours worked on Saturday, Sundays and holidays shall be paid at double the hourly rate of pay. Rates include all members of the assigned crew.

EXCEPTION:

On all multipole structures and steel transmission lines, switching stations, regulating, capacitor stations, generating plants, industrial plants, associated installations and substations, except those substations whose primary function is to feed a distribution system, will be paid overtime under the following rates:

The first two (2) hours after eight (8) regular hours Monday through Friday of overtime on a regular workday, shall be paid at one and one-half times the hourly rate of wage. All hours in excess of ten (10) hours will be at two (2) times the hourly rate of wage. The first eight (8) hours worked on Saturday will be paid at one and one-half (1-1/2) times the hourly rate of wage. All hours worked in excess of eight (8) hours on Saturday, and all hours worked on Sundays and holidays will be at the double the hourly rate of wage.

All overtime eligible hours performed on the above described work that is energized, shall be paid at the double the hourly rate of wage.

- E. The first two (2) hours after eight (8) regular hours Monday through Friday and the first eight (8) hours on Saturday shall be paid at one and one-half times the hourly rate of wage. All other hours worked Monday through Saturday, and all hours worked on Sundays and holidays shall be paid at double the hourly rate of wage.

On a four-day, ten-hour weekly schedule, either Monday thru Thursday or Tuesday thru Friday schedule, all hours worked after ten shall be paid at double the hourly rate of wage. The Monday or Friday not utilized in the normal four-day, ten hour work week, and Saturday shall be paid at one and one half (1½) times the regular shift rate for the first eight (8) hours. All other hours worked Monday through Saturday, and all hours worked on Sundays and holidays shall be paid at double the hourly rate of wage.
- G. All hours worked on Saturdays shall be paid at one and one-half times the hourly rate of wage. All hours worked Monday through Saturday over twelve (12) hours and all hours worked on Sundays and holidays shall be paid at double the hourly rate of wage.
- I. The First eight (8) hours worked on Saturdays shall be paid at one and one-half times the hourly rate of wage. All hours worked in excess of eight (8) per day on Saturdays shall be paid at double the hourly rate of wage. All hours worked on Sundays and holidays shall be paid at double the hourly rate of wage.

Overtime Codes Continued

4. J. The first eight (8) hours worked on a Saturday shall be paid at one and one-half times the hourly rate of wage. All hours worked in excess of eight (8) hours on a Saturday shall be paid at double the hourly rate of wage. All hours worked over twelve (12) in a day, and all hours worked on Sundays and Holidays shall be paid at double the hourly rate of wage.
- K. All hours worked on a Saturday shall be paid at one and one-half times the hourly rate of wage, so long as Saturday is the sixth consecutive day worked. All hours worked over twelve (12) in a day Monday through Saturday, and all hours worked on Sundays and Holidays shall be paid at double the hourly rate of wage.
- L. The first twelve (12) hours worked on a Saturday shall be paid at one and one-half times the hourly rate of wage. All hours worked on a Saturday in excess of twelve (12) hours shall be paid at double the hourly rate of pay. All hours worked over twelve (12) in a day Monday through Friday, and all hours worked on Sundays shall be paid at double the hourly rate of wage. All hours worked on a holiday shall be paid at one and one-half times the hourly rate of wage, except that all hours worked on Labor Day shall be paid at double the hourly rate of pay.
- S. On a four (4) day ten (10) hour workweek scheduled Monday through Thursday, or Tuesday through Friday, work performed in excess of (10) hours shall be paid at one and one half (1-1/2) times the hourly rate of pay. On Monday through Friday, work performed outside the normal work hours of 6:00 a.m. and 6:00 p.m. shall be paid at one and one-half (1-1/2) times the straight time rate, (except for special shifts or multiple shift operations).
- All hours worked on Saturdays shall be paid at one and one-half times the hourly rate of wage. All work performed on Sundays and holidays shall be paid at double the hourly rate of wage. When an employee returns to work without at least eight (8) hours time off since their previous shift, all such time shall be a continuation of shift and paid at the applicable overtime rate until such time as the employee has had a break of eight (8) hours.
- Multiple Shift Operations: When the first shift of a multiple shift (a two or three shift) operation is started at the basic straight time rate or at a specific overtime rate, all shifts of that day's operation shall be completed at that rate. Special Shifts: The Special Shift Premium is the basic hourly rate of pay plus \$2.00 an hour. When due to conditions beyond the control of the employer or when an owner (not acting as the contractor), a government agency or the contract specifications require more than four (4) hours of a special shift can only be performed outside the normal 6am to 6pm shift then the special shift premium will be applied to the basic straight time for the entire shift. When an employee works on a special shift, they shall be paid the special shift premium for each hour worked unless they are in overtime or double-time status. (For example, the special shift premium does not waive the overtime requirements for work performed on Saturday or Sunday).
- U. The first four (4) hours after eight (8) regular hours Monday through Friday and the first twelve (12) hours on Saturday shall be paid at one and one-half times the hourly rate of wage. (Except on makeup days if work is lost due to inclement weather, then the first eight (8) hours on Saturday may be paid the regular rate.) All hours worked over twelve (12) hours Monday through Saturday, and all hours worked on Sundays and holidays shall be paid at double the hourly rate of wage.

Overtime Codes Continued

4. V. Work performed in excess of ten (10) hours of straight time per day when four ten (10) hour shifts are established or outside the normal shift (5 am to 6pm), and all work on Saturdays, except for make-up days shall be paid at time and one-half (1 ½) the straight time rate.

In the event the job is down due to weather conditions, then Saturday may, be worked as a voluntary make-up day at the straight time rate. However, Saturday shall not be utilized as a make-up day when a holiday falls on Friday. All work performed on Sundays and holidays and work in excess of twelve (12) hours per day shall be paid at double (2x) the straight time rate of pay.

After an employee has worked eight (8) hours at an applicable overtime rate, all additional hours shall be at the applicable overtime rate until such time as the employee has had a break of eight (8) hours.

When an employee returns to work without a break of eight (8) hours since their previous shift, all such time shall be a continuation of shift and paid at the applicable overtime rate until such time as the employee has had a break of eight (8) hours.

- X. All hours worked on Saturdays shall be paid at one and one-half times the hourly rate of wage. All hours worked on Sundays and holidays shall be paid at double the hourly rate of wage. Work performed outside the normal shift of 6 am to 6pm shall be paid at one and one-half the straight time rate, (except for special shifts or three shift operations). All work performed on Sundays and holidays shall be paid at double the hourly rate of wage. Shifts may be established when considered necessary by the Employer.

The Employer may establish shifts consisting of eight (8) or ten (10) hours of work (subject to WAC 296-127-022), that shall constitute a normal forty (40) hour work week. The Employer can change from a 5-eight to a 4-ten hour schedule or back to the other. All hours of work on these shifts shall be paid for at the straight time hourly rate. Work performed in excess of eight hours (or ten hours per day (subject to WAC 296-127-022) shall be paid at one and one-half the straight time rate.

When due to conditions beyond the control of the Employer, or when contract specifications require that work can only be performed outside the regular day shift, then by mutual agreement a special shift may be worked at the straight time rate, eight (8) hours work for eight (8) hours pay. The starting time shall be arranged to fit such conditions of work.

When an employee returns to work without at a break of eight (8) hours since their previous shift, all such time shall be a continuation of shift and paid at the applicable overtime rate until such time as the employee has had a break of eight (8) hours.

11. ALL HOURS WORKED IN EXCESS OF EIGHT (8) HOURS PER DAY OR FORTY (40) HOURS PER WEEK SHALL BE PAID AT ONE AND ONE-HALF TIMES THE HOURLY RATE OF WAGE.

- B After an employee has worked eight (8) hours, all additional hours worked shall be paid at the applicable overtime rate until such time as the employee has had a break of eight (8) hours or more.

- C The first two (2) hours after eight (8) regular hours Monday through Friday and the first eight (8) hours on Saturday shall be paid at one and one-half times the hourly rate of wage. All other overtime hours worked, except Labor Day, and all hours on Sunday shall be paid at double the hourly rate of wage. All hours worked on Labor Day shall be paid at three times the hourly rate of wage. All non-overtime and non-holiday hours worked between 4:00 pm and 5:00 am, Monday through Friday, shall be paid at a premium rate of 15% over the hourly rate of wage.

Overtime Codes Continued

11. D. All hours worked on Saturdays and holidays shall be paid at one and one-half times the hourly rate of wage. All hours worked on Sundays shall be paid at double the hourly rate of wage.
- After an employee has worked eight (8) hours, all additional hours worked shall be paid at the applicable overtime rate until such time as the employee has had a break of eight (8) hours or more.
- E. The first two (2) hours after eight (8) regular hours Monday through Friday, the first ten (10) hours on Saturday, and the first ten (10) hours worked on Holidays shall be paid at one and one-half times the hourly rate of wage. All hours worked over ten (10) hours Monday through Saturday, and Sundays shall be paid at double the hourly rate of wage.
- After an employee has worked eight (8) hours, all additional hours worked shall be paid at the applicable overtime rate until such time as the employee has had a break of eight (8) hours or more.
- F. The first two (2) hours after eight (8) regular hours Monday through Friday and the first eight (8) hours on Saturday shall be paid at one and one-half times the hourly rate of wage. All other hours worked Monday through Saturday, and all hours worked on Sundays and holidays shall be paid at double the hourly rate of wage.
- On a four-day, ten-hour weekly schedule, either Monday thru Thursday or Tuesday thru Friday schedule, all hours worked after ten shall be paid at double the hourly rate of wage. The Monday or Friday not utilized in the normal four-day, ten hour work week, and Saturday shall be paid at one-half times the hourly rate of wage for the first eight (8) hours. All other hours worked Monday through Saturday, and all hours worked on Sundays and holidays shall be paid at double the hourly rate of wage.
- G. Work performed in excess of eight (8) hours of straight time per day, or ten (10) hours of straight time per day when four ten (10) hour shifts are established, or forty (40) hours of straight time per week, Monday through Friday, or outside the normal 5 am to 6pm shift, and all work on Saturdays shall be paid at one and one-half times the hourly rate of wage.
- All work performed after 6:00 pm Saturday to 5:00 am Monday and Holidays, and all hours worked in excess of twelve (12) hours in a single shift shall be paid at double the hourly rate of wage.
- After an employee has worked eight (8) hours at an applicable overtime rate, all additional hours shall be at the applicable overtime rate until such time as the employee has had a break of nine (9) hours or more. When an employee returns to work without at least nine (9) hours time off since their previous shift, all such time shall be a continuation of shift and paid at the applicable overtime rate until he/she shall have the nine (9) hours rest period.
- H. Work performed in excess of eight (8) hours of straight time per day, or ten (10) hours of straight time per day when four ten (10) hour shifts are established, or forty (40) hours of straight time per week, Monday through Friday, or outside the normal 5 am to 6pm shift, and all work on Saturdays shall be paid at one and one-half times the hourly rate of wage.
- All work performed after 6:00 pm Saturday to 5:00 am Monday and Holidays, and all hours worked in excess of twelve (12) hours in a single shift shall be paid at double the hourly rate of wage.
- After an employee has worked eight (8) hours at an applicable overtime rate, all additional hours shall be at the applicable overtime rate until such time as the employee has had a break of ten (10) hours or more. When an employee returns to work without at least ten (10) hours time off since their previous shift, all such time shall be a continuation of shift and paid at the applicable overtime rate until he/she shall have the ten (10) hours rest period.

Overtime Codes Continued

11. J. All hours worked on holidays shall be paid at double the hourly rate of wage.
- K. On Monday through Friday hours worked outside 4:00 am and 5:00 pm, and the first two (2) hours after eight (8) hours worked shall be paid at one and one-half times the hourly rate. All hours worked over 10 hours per day Monday through Friday, and all hours worked on Saturdays, Sundays, and Holidays worked shall be paid at double the hourly rate of wage.
- L. An employee working outside 5:00 am and 5:00 pm shall receive an additional two dollar (\$2.00) per hour for all hours worked that shift. All hours worked on holidays shall be paid at one and one-half times the hourly rate of wage. All hours worked on holidays shall be paid at one and one-half times the hourly rate of wage.
- M. On Monday through Friday, the first four (4) hours of overtime after eight (8) hours of straight time work shall be paid at one and one half (1-1/2) times the straight time rate of pay, unless a four (4) day ten (10) hour workweek has been established. On a four (4) day ten (10) hour workweek scheduled Monday through Thursday, or Tuesday through Friday, the first two (2) hours of overtime after ten (10) hours of straight time work shall be paid at one and one half (1-1/2) times the straight time rate of pay.
- Work performed outside the normal work hours of 5:00 a.m. and 6:00 p.m. shall be paid at one and one-half (1-1/2) times the straight time rate, (except for special shifts or multiple shift operations). When the first shift of a multiple shift (a two or three shift) operation is started at the basic straight time rate or at a specific overtime rate, all shifts of that day's operation shall be completed at that rate. When due to conditions beyond the control of the Employer or when contract specifications require that work can only be performed outside the regular day shift of 5:00 am to 6:00 pm, then a special shift may be worked at the straight time rate, plus the shift pay premium when applicable. The starting time of work will be arranged to fit such conditions of work. Such shift shall consist of eight (8) hours work for eight (8) hours pay or ten (10) hours work for ten (10) hours pay for four ten shifts.
- On Saturday, the first twelve (12) hours of work shall be paid at one and one half (1-1/2) times the straight time rate of pay. All work performed after 6:00 pm Saturday to 5:00 am Monday, all work performed over twelve (12) hours, and all work performed on holidays shall be paid at double the straight time rate of pay.
- Shift Pay Premium: In an addition to any overtime already required, all hours worked between the hours of 6:00 pm and 5:00 am shall receive an additional two dollars (\$2.00) per hour.
- N. All work performed over twelve hours in a shift and all work performed on Sundays and Holidays shall be paid at double the straight time rate.
- Any time worked over eight (8) hours on Saturday shall be paid double the straight time rate, except employees assigned to work six 10-hour shifts per week shall be paid double the straight time rate for any time worked on Saturday over 10 hours.
- O. All work performed on Saturdays, Sundays, and Holidays shall be paid at one and one half (1-1/2) times the straight time rate of pay.

Benefit Code Key – Effective 8/31/2023 thru 3/1/2024

Holiday Codes

- 5. A. Holidays: New Year's Day, Memorial Day, Independence Day, Labor Day, Thanksgiving Day, Friday after Thanksgiving Day, and Christmas Day (7).
- B. Holidays: New Year's Day, Memorial Day, Independence Day, Labor Day, Thanksgiving Day, Friday after Thanksgiving Day, the day before Christmas, and Christmas Day (8).
- C. Holidays: New Year's Day, Presidents' Day, Memorial Day, Independence Day, Labor Day, Thanksgiving Day, the Friday after Thanksgiving Day, And Christmas Day (8).
- D. Holidays: New Year's Day, Memorial Day, Independence Day, Labor Day, Thanksgiving Day, the Friday and Saturday after Thanksgiving Day, And Christmas Day (8).
- H. Holidays: New Year's Day, Memorial Day, Independence Day, Thanksgiving Day, the Day after Thanksgiving Day, And Christmas (6).
- I. Holidays: New Year's Day, Memorial Day, Independence Day, Labor Day, Thanksgiving Day, and Christmas Day (6).
- K. Holidays: New Year's Day, Presidents' Day, Memorial Day, Independence Day, Labor Day, Thanksgiving Day, Friday After Thanksgiving Day, The Day Before Christmas, And Christmas Day (9).
- L. Holidays: New Year's Day, Martin Luther King Jr. Day, Memorial Day, Independence Day, Labor Day, Thanksgiving Day, Friday after Thanksgiving Day, And Christmas Day (8).
- N. Holidays: New Year's Day, Presidents' Day, Memorial Day, Independence Day, Labor Day, Veterans' Day, Thanksgiving Day, The Friday After Thanksgiving Day, And Christmas Day (9).
- P. Holidays: New Year's Day, Memorial Day, Independence Day, Labor Day, Thanksgiving Day, Friday And Saturday After Thanksgiving Day, The Day Before Christmas, And Christmas Day (9). If A Holiday Falls On Sunday, The Following Monday Shall Be Considered As A Holiday.
- Q. Paid Holidays: New Year's Day, Memorial Day, Independence Day, Labor Day, Thanksgiving Day, and Christmas Day (6).
- R. Paid Holidays: New Year's Day, Memorial Day, Independence Day, Labor Day, Thanksgiving Day, Day After Thanksgiving Day, One-Half Day Before Christmas Day, And Christmas Day. (7 1/2).
- S. Paid Holidays: New Year's Day, Presidents' Day, Memorial Day, Independence Day, Labor Day, Thanksgiving Day, And Christmas Day (7).
- Z. Holidays: New Year's Day, Memorial Day, Independence Day, Labor Day, Veterans Day, Thanksgiving Day, the Friday after Thanksgiving Day, And Christmas Day (8).
- 6. G. Paid Holidays: New Year's Day, Martin Luther King Jr. Day, Presidents' Day, Memorial Day, Independence Day, Labor Day, Veterans' Day, Thanksgiving Day, the Friday after Thanksgiving Day, Christmas Day, and Christmas Eve Day (11).
- H. Paid Holidays: New Year's Day, New Year's Eve Day, Memorial Day, Independence Day, Labor Day, Thanksgiving Day, Friday After Thanksgiving Day, Christmas Day, The Day After Christmas, And A Floating Holiday (10).

Benefit Code Key – Effective 8/31/2023 thru 3/1/2024

Holiday Codes Continued

6. T. Paid Holidays: New Year's Day, Presidents' Day, Memorial Day, Independence Day, Labor Day, Thanksgiving Day, The Friday After Thanksgiving Day, The Last Working Day Before Christmas Day, And Christmas Day (9).
- Z. Holidays: New Year's Day, Memorial Day, Independence Day, Labor Day, Thanksgiving Day, Friday after Thanksgiving Day, And Christmas Day (7). If a holiday falls on Saturday, the preceding Friday shall be considered as the holiday. If a holiday falls on Sunday, the following Monday shall be considered as the holiday.
7. A. Holidays: New Year's Day, Memorial Day, Independence Day, Labor Day, Thanksgiving Day, the Friday and Saturday after Thanksgiving Day, And Christmas Day (8). Any Holiday Which Falls On A Sunday Shall Be Observed As A Holiday On The Following Monday. If any of the listed holidays falls on a Saturday, the preceding Friday shall be a regular work day.
- B. Holidays: New Year's Day, Memorial Day, Independence Day, Labor Day, Thanksgiving Day, the Friday and Saturday after Thanksgiving Day, And Christmas Day (8). Any holiday which falls on a Sunday shall be observed as a holiday on the following Monday. Any holiday which falls on a Saturday shall be observed as a holiday on the preceding Friday.
- C. Holidays: New Year's Day, Martin Luther King Jr. Day, Memorial Day, Independence Day, Labor Day, Thanksgiving Day, the Friday after Thanksgiving Day, And Christmas Day (8). Any holiday which falls on a Sunday shall be observed as a holiday on the following Monday. Any holiday which falls on a Saturday shall be observed as a holiday on the preceding Friday.
- D. Paid Holidays: New Year's Day, Memorial Day, Independence Day, Labor Day, Veteran's Day, Thanksgiving Day, the Friday after Thanksgiving Day, And Christmas Day (8). Unpaid Holidays: President's Day. Any paid holiday which falls on a Sunday shall be observed as a holiday on the following Monday. Any paid holiday which falls on a Saturday shall be observed as a holiday on the preceding Friday.
- E. Holidays: New Year's Day, Memorial Day, Independence Day, Labor Day, Thanksgiving Day, the Friday after Thanksgiving Day, And Christmas Day (7). Any holiday which falls on a Sunday shall be observed as a holiday on the following Monday. Any holiday which falls on a Saturday shall be observed as a holiday on the preceding Friday.
- F. Holidays: New Year's Day, Memorial Day, Independence Day, Labor Day, Thanksgiving Day, the Friday after Thanksgiving Day, the last working day before Christmas day and Christmas day (8). Any holiday which falls on a Sunday shall be observed as a holiday on the following Monday. Any holiday which falls on a Saturday shall be observed as a holiday on the preceding Friday.
- G. Holidays: New Year's Day, Memorial Day, Independence Day, Labor Day, Thanksgiving Day, and Christmas Day (6). Any holiday which falls on a Sunday shall be observed as a holiday on the following Monday.
- H. Holidays: New Year's Day, Martin Luther King Jr. Day, Independence Day, Memorial Day, Labor Day, Thanksgiving Day, the Friday after Thanksgiving Day, the Last Working Day before Christmas Day and Christmas Day (9). Any holiday which falls on a Sunday shall be observed as a holiday on the following Monday. Any holiday which falls on a Saturday shall be observed as a holiday on the preceding Friday.
- I. Holidays: New Year's Day, President's Day, Independence Day, Memorial Day, Labor Day, Thanksgiving Day, The Friday After Thanksgiving Day, The Day Before Christmas Day And Christmas Day (9). Any holiday which falls on a Sunday shall be observed as a holiday on the following Monday. Any holiday which falls on a Saturday shall be observed as a holiday on the preceding Friday.

Holiday Codes Continued

7. J. Holidays: New Year's Day, Independence Day, Memorial Day, Labor Day, Thanksgiving Day and Christmas Day (6). Any holiday which falls on a Sunday shall be observed as a holiday on the following Monday. Any holiday which falls on a Saturday shall be observed as a holiday on the preceding Friday.
- K. Holidays: New Year's Day, Memorial Day, Independence Day, Thanksgiving Day, the Friday and Saturday after Thanksgiving Day, And Christmas Day (8). Any holiday which falls on a Sunday shall be observed as a holiday on the following Monday. Any holiday which falls on a Saturday shall be observed as a holiday on the preceding Friday.
- L. Holidays: New Year's Day, Memorial Day, Labor Day, Independence Day, Thanksgiving Day, the Last Work Day before Christmas Day, And Christmas Day (7). Any holiday which falls on a Sunday shall be observed as a holiday on the following Monday. Any holiday which falls on a Saturday shall be observed as a holiday on the preceding Friday.
- N. Holidays: New Year's Day, Memorial Day, Independence Day, Labor Day, Thanksgiving Day, the Friday after Thanksgiving Day, And Christmas Day (7). Any holiday which falls on a Sunday shall be observed as a holiday on the following Monday. When Christmas falls on a Saturday, the preceding Friday shall be observed as a holiday.
- P. Holidays: New Year's Day, Memorial Day, Independence Day, Labor Day, Thanksgiving Day, Friday after Thanksgiving Day, And Christmas Day (7). Any holiday which falls on a Sunday shall be observed as a holiday on the following Monday.
- Q. Holidays: New Year's Day, Memorial Day, Independence Day, Labor Day, Thanksgiving Day, the Friday after Thanksgiving Day, the Last Working Day before Christmas Day and Christmas Day (8). Any holiday which falls on a Sunday shall be observed as a holiday on the following Monday. If any of the listed holidays falls on a Saturday, the preceding Friday shall be a regular work day.
- S. Paid Holidays: New Year's Day, Memorial Day, Independence Day, Labor Day, Thanksgiving Day, Friday after Thanksgiving Day, Christmas Day, the Day after Christmas, and A Floating Holiday (9). If any of the listed holidays falls on a Sunday, the day observed by the Nation shall be considered a holiday and compensated accordingly.
- V. Holidays: New Year's Day, President's Birthday, Memorial Day, Independence Day, Labor Day, Thanksgiving Day, the Friday after Thanksgiving Day, Christmas Day, the day before or after Christmas, and the day before or after New Year's Day. If any of the above listed holidays falls on a Sunday, the day observed by the Nation shall be considered a holiday and compensated accordingly.
- W. Holidays: New Year's Day, Day After New Year's, Memorial Day, Independence Day, Labor Day, Thanksgiving Day, the Friday after Thanksgiving Day, Christmas Eve Day, Christmas Day, the day after Christmas, the day before New Year's Day, and a Floating Holiday.
- X. Holidays: New Year's Day, Day before or after New Year's Day, Presidents' Day, Memorial Day, Independence Day, Labor Day, Thanksgiving Day, the Friday after Thanksgiving Day, Christmas Day, and the day before or after Christmas day. If a holiday falls on a Saturday or on a Friday that is the normal day off, then the holiday will be taken on the last normal workday. If the holiday falls on a Monday that is the normal day off or on a Sunday, then the holiday will be taken on the next normal workday.
- Y. Holidays: New Year's Day, Presidents' Day, Memorial Day, Independence Day, Labor Day, Thanksgiving Day, the Friday after Thanksgiving Day, and Christmas Day. (8) If the holiday falls on a Sunday, then the day observed by the federal government shall be considered a holiday and compensated accordingly.
- Z. Holidays: New Year's Day, Memorial Day, Independence Day, Labor Day, Thanksgiving Day, the Friday and Saturday after Thanksgiving Day, Christmas Eve, and Christmas Day (9). Any holiday which falls on a Saturday shall be observed as a holiday on the preceding Friday. Any holiday which falls on a Sunday shall be observed as a holiday on the following Monday.

Holiday Codes Continued

15. G. New Year's Day, Washington's Birthday, Memorial Day, Independence Day, Labor Day, Thanksgiving Day, The Friday After Thanksgiving Day, the last scheduled workday before Christmas, and Christmas Day (9). If any of the listed holidays falls on a Sunday, the day observed by the Nation shall be considered a holiday and compensated accordingly.
- H. Holidays: New Year's Day, Martin Luther King Jr. Day, Independence Day, Memorial Day, Labor Day, Thanksgiving Day, the Friday after Thanksgiving Day, the Last Working Day before Christmas Day and Christmas Day (9). Any holiday which falls on a Sunday shall be observed as a holiday on the following Monday. Any holiday which falls on a Saturday shall be observed as a holiday on the preceding Friday.
- I. Holidays: New Year's Day, President's Day, Independence Day, Memorial Day, Labor Day, Thanksgiving Day, The Friday After Thanksgiving Day, The Day Before Christmas Day And Christmas Day (9). Any holiday which falls on a Sunday shall be observed as a holiday on the following Monday. Any holiday which falls on a Saturday shall be observed as a holiday on the preceding Friday.
- J. Holidays: New Year's Day, Martin Luther King Jr. Day, Memorial Day, Independence Day, Labor Day, Thanksgiving Day, the Friday and Saturday after Thanksgiving Day, and Christmas Day (9). Any holiday which falls on a Sunday shall be observed as a holiday on the following Monday. If any of the listed holidays falls on a Saturday, the preceding Friday shall be a regular work day.
- K. Holidays: New Year's Day, Memorial Day, Independence Day, Thanksgiving Day, the Friday and Saturday after Thanksgiving Day, And Christmas Day (8). Any holiday which falls on a Sunday shall be observed as a holiday on the following Monday. Any holiday which falls on a Saturday shall be observed as a holiday on the preceding Friday.
- L. Holidays: New Year's Day, Memorial Day, Independence Day, Labor Day, Veteran's Day, Thanksgiving Day, the Friday after Thanksgiving Day, and Christmas Day (8). Any holiday which falls on a Sunday shall be observed as a holiday on the following Monday. If any of the listed holidays falls on a Saturday, the preceding Friday shall be a regular work day.
- M. Holidays: New Year's Day, Martin Luther King Jr. Day, Independence Day, Memorial Day, Labor Day, Thanksgiving Day, the Friday after Thanksgiving Day, Christmas Eve Day and Christmas Day (9). Any holiday which falls on a Sunday shall be observed as a holiday on the following Monday. If any of the listed holidays falls on a Saturday, the preceding Friday shall be a regular work day.
- N. Holidays: New Year's Day, Memorial Day, Independence Day, Labor Day, Veteran's Day, Thanksgiving Day, the Friday after Thanksgiving Day, and Christmas Day (8). Any holiday which falls on a Sunday shall be observed as a holiday on the following Monday.

Note Codes

8. D. Workers working with supplied air on hazmat projects receive an additional \$1.00 per hour.
- L. Workers on hazmat projects receive additional hourly premiums as follows -Level A: \$0.75, Level B: \$0.50, And Level C: \$0.25.
- M. Workers on hazmat projects receive additional hourly premiums as follows: Levels A & B: \$1.00, Levels C & D: \$0.50.
- N. Workers on hazmat projects receive additional hourly premiums as follows -Level A: \$1.00, Level B: \$0.75, Level C: \$0.50, And Level D: \$0.25.

Note Codes Continued

8. S. Effective August 31, 2012 – A Traffic Control Supervisor shall be present on the project whenever flagging or spotting or other traffic control labor is being utilized. Flaggers and Spotters shall be posted where shown on approved Traffic Control Plans or where directed by the Engineer. All flaggers and spotters shall possess a current flagging card issued by the State of Washington, Oregon, Montana, or Idaho. This classification is only effective on or after August 31, 2012.
- T. Effective August 31, 2012 – A Traffic Control Laborer performs the setup, maintenance and removal of all temporary traffic control devices and construction signs necessary to control vehicular, bicycle, and pedestrian traffic during construction operations. Flaggers and Spotters shall be posted where shown on approved Traffic Control Plans or where directed by the Engineer. All flaggers and spotters shall possess a current flagging card issued by the State of Washington, Oregon, Montana, or Idaho. This classification is only effective on or after August 31, 2012.
- U. Workers on hazmat projects receive additional hourly premiums as follows – Class A Suit: \$2.00, Class B Suit: \$1.50, And Class C Suit: \$1.00. Workers performing underground work receive an additional \$0.40 per hour for any and all work performed underground, including operating, servicing and repairing of equipment. The premium for underground work shall be paid for the entire shift worked. Workers who work suspended by a rope or cable receive an additional \$0.50 per hour. The premium for work suspended shall be paid for the entire shift worked. Workers who do “pioneer” work (break open a cut, build road, etc.) more than one hundred fifty (150) feet above grade elevation receive an additional \$0.50 per hour.
- V. In addition to the hourly wage and fringe benefits, the following depth and enclosure premiums shall be paid. The premiums are to be calculated for the maximum depth and distance into an enclosure that a diver reaches in a day. The premiums are to be paid one time for the day and are not used in calculating overtime pay.
- Depth premiums apply to depths of fifty feet or more. Over 50' to 100' - \$2.00 per foot for each foot over 50 feet. Over 101' to 150' - \$3.00 per foot for each foot over 101 feet. Over 151' to 220' - \$4.00 per foot for each foot over 220 feet. Over 221' - \$5.00 per foot for each foot over 221 feet.
- Enclosure premiums apply when divers enter enclosures (such as pipes or tunnels) where there is no vertical ascent and is measured by the distance travelled from the entrance. 25' to 300' - \$1.00 per foot from entrance. 300' to 600' - \$1.50 per foot beginning at 300'. Over 600' - \$2.00 per foot beginning at 600'.
- W. Meter Installers work on single phase 120/240V self-contained residential meters. The Lineman/Groundmen rates would apply to meters not fitting this description.
- X. Workers on hazmat projects receive additional hourly premiums as follows - Class A Suit: \$2.00, Class B Suit: \$1.50, Class C Suit: \$1.00, and Class D Suit: \$0.50. Special Shift Premium: Basic hourly rate plus \$2.00 per hour.
- When due to conditions beyond the control of the Employer or when an owner (not acting as the contractor), a government agency or the contract specifications requires that work can only be performed outside the normal 5 am to 6pm shift, then the special shift premium will be applied to the basic hourly rate. When an employee works on a special shift, they shall be paid a special shift premium for each hour worked unless they are in OT or Double-time status. (For example, the special shift premium does not waive the overtime requirements for work performed on Saturday or Sunday.)
- Y. Tide Work: When employees are called out between the hours of 6:00 p.m. and 6:00 a.m. to work on tide work (work located in the tide plane) all time worked shall be at one and one-half times the hourly rate of pay.
- Swinging Stage/Boatswains Chair: Employees working on a swinging state or boatswains chair or under conditions that require them to be tied off to allow their hands to be free shall receive seventy-five cents (\$0.75) per hour above the classification rate.

Note Codes Continued

8. Z. Workers working with supplied air on hazmat projects receive an additional \$1.00 per hour.

Special Shift Premium: Basic hourly rate plus \$2.00 per hour. When due to conditions beyond the control of the Employer or when an owner (not acting as a contractor), a government agency or the contract specifications require that more than (4) hours of a special shift can only be performed outside the normal 6 am to 6pm shift, then the special shift premium will be applied to the basic straight time for the entire shift. When an employee works on a special shift, they will be paid a special shift premium for each hour worked unless they are in overtime or double-time status. (For example, the special shift premium does not waive the overtime requirements for work performed on Saturday or Sunday.)

9. A. Workers working with supplied air on hazmat projects receive an additional \$1.00 per hour.

Special Shift Premium: Basic hourly rate plus \$2.00 per hour. When due to conditions beyond the control of the Employer or when an owner (not acting as the contractor), a government agency or the contract specifications require that more than four (4) hours of a special shift can only be performed outside the normal 6 am to 6pm shift, then the special shift premium will be applied to the basic straight time for the entire shift. When an employee works on a special shift, they shall be paid a special shift premium for each hour worked unless they are in overtime or double-time status. (For example, the special shift premium does not waive the overtime requirements for work performed on Saturday or Sunday.)

Certified Crane Operator Premium: Crane operators requiring certifications shall be paid \$0.50 per hour above their classification rate.

Boom Pay Premium: All cranes including tower shall be paid as follows based on boom length:

(A) – 130' to 199' – \$0.50 per hour over their classification rate.

(B) – 200' to 299' – \$0.80 per hour over their classification rate.

(C) – 300' and over – \$1.00 per hour over their classification rate.

- B. The highest pressure registered on the gauge for an accumulated time of more than fifteen (15) minutes during the shift shall be used in determining the scale paid.

Tide Work: When employees are called out between the hours of 6:00 p.m. and 6:00 a.m. to work on tide work (work located in the tide plane) all time worked shall be at one and one-half times the hourly rate of pay. Swinging Stage/Boatswains Chair: Employees working on a swinging stage or boatswains chair or under conditions that require them to be tied off to allow their hands to be free shall receive seventy-five cents (\$0.75) per hour above the classification rate.

- C. Tide Work: When employees are called out between the hours of 6:00 p.m. and 6:00 a.m. to work on tide work (work located in the tide plane) all time worked shall be at one and one-half times the hourly rate of pay. Swinging Stage/Boatswains Chair: Employees working on a swinging stage or boatswains chair or under conditions that require them to be tied off to allow their hands to be free shall receive seventy-five cents (\$0.75) per hour above the classification rate.

Effective August 31, 2012 – A Traffic Control Supervisor shall be present on the project whenever flagging or spotting or other traffic control labor is being utilized. A Traffic Control Laborer performs the setup, maintenance and removal of all temporary traffic control devices and construction signs necessary to control vehicular, bicycle, and pedestrian traffic during construction operations. Flaggers and Spotters shall be posted where shown on approved Traffic Control Plans or where directed by the Engineer. All flaggers and spotters shall possess a current flagging card issued by the State of Washington, Oregon, Montana, or Idaho. These classifications are only effective on or after August 31, 2012.

- D. Industrial Painter wages are required for painting within industrial facilities such as treatment plants, pipelines, towers, dams, bridges, power generation facilities and manufacturing facilities such as chemical plants, etc., or anywhere abrasive blasting is necessary to prepare surfaces, or hazardous materials encapsulation is required.

Note Codes Continued

- 9. E. Heavy Construction includes construction, repair, alteration or additions to the production, fabrication or manufacturing portions of industrial or manufacturing plants, hydroelectric or nuclear power plants and atomic reactor construction. Workers on hazmat projects receive additional hourly premiums as follows -Level A: \$1.00, Level B: \$0.75, Level C: \$0.50, And Level D: \$0.25.
- F. Industrial Painter wages are required for painting within industrial facilities such as treatment plants, pipelines, towers, dams, power generation facilities and manufacturing facilities such as chemical plants, etc., or anywhere abrasive blasting is necessary to prepare surfaces, or hazardous materials encapsulation is required.
- H. One (1) person crew shall consist of a Party Chief. (Total Station or similar one (1) person survey system). Two (2) person survey party shall consist of a least a Party Chief and a Chain Person. Three (3) person survey party shall consist of at least a Party Chief, an Instrument Person, and a Chain Person.

Contract No.XXXX
CONSTRUCTION AND MAINTENANCE SERVICES

for

This Contract is made and entered into as of the last signature date below between the Seattle Housing Authority, a public body corporate and politic, hereinafter referred to as "Owner," and _____, hereinafter referred to as the "Contractor." The Contractor and the Owner agree as follows:

SECTION 1: This Contract incorporates by reference and is subject to the following as though fully included herein, whether attached or not attached:

- The Contractor's response to the Request for Bids (by E-M ail) (attached)
- Attachment A, version 1 (attached)
- Technical scope of work included as part of the Request for Bids (by E-M ail)
- Owner's General Conditions
- Prevailing wage rates as established in Select One dated _____ (attached)
- Federal Labor Standards Provisions (attached)

SECTION 2: The Contractor shall perform or cause to be performed all work and shall furnish or cause to be furnished all labor, materials, tools, and equipment necessary to complete the above-referenced project in strict accordance with the Contract Documents and documents described in Section 1 above for the following Contract Sum:

Base Bid	\$
Additive No.(s)	\$
Deductive No.(s)	\$
Subtotal	\$
Sales Tax	\$
Contract Sum	\$

SECTION 3: The Contractor shall begin the work of the Contract immediately after receipt of a written Notice to Proceed issued by the Owner, and to perform the work regularly and without interruption thereafter (unless the Owner shall otherwise, in writing, specifically direct) with such forces as necessary to complete said work in a manner acceptable to the owner within _____ consecutive calendar days from the date of the Notice to Proceed.

The parties have executed this Contract by having their authorized representatives sign below.

Seattle Housing Authority
190 Queen Anne Avenue North
P.O. Box 19028
Seattle, WA 98109-1028

By: _____
Date

By: _____
Miki Naganuma Date
Deputy Director of Contracts and Procurement

Seattle Housing Authority

Work Order

Work Order No.: 001	Work Order Name:
Contract No.: 5858	Contract Name: Various Hope VI Shower Upgrades
Business Name:	Contract Execution Date:
SHA Project Manager: Cindy Sribhibhadh (Seattle Housing Authority)	

THIS WORK ORDER is made and entered into between the Housing Authority of the City of Seattle, a public body corporate and politic, hereinafter referred to as "SHA" and/or "Owner" and , hereinafter referred to as the "Consultant" and/or "Service Provider."

WHEREAS, this Work Order incorporates by reference and is subject to the terms and conditions (unless otherwise amended herein) of the Contract No. shown above as though fully included herein:

SECTION 1: SCOPE OF WORK: The Consultant shall perform such services as required by SHA to complete the work as defined in ATTACHMENT A – SCOPE OF WORK AND/OR ENGAGEMENT LETTER, and shall provide all labor, materials, equipment, and services necessary to perform and complete in an acceptable manner the tasks contemplated or otherwise required herein. The Scope of Work shall serve as the progress schedule and be used to measure work performed. Consultant shall perform its duties under this Work Order with the care, skill, prudence and diligence that a reasonable, careful, skillful, prudent and diligent person would exercise in similar circumstances.

Section 2 – TIME FOR BEGINNING AND COMPLETION: The Consultant shall not begin any work under the terms of this Work Order until authorized to do so in writing by SHA. All work under this Work Order shall be completed between the date authorized to begin work and the completion date, both specified in ATTACHMENT B – TERMS AND CONDITIONS, attached and made a part of this Work Order. The established completion time for the tasks and the entire Work Order period shall not be extended because of any delays attributable to the Consultant, but may be extended by SHA in the event of a delay attributable to SHA, or because of unavoidable delay caused by an act of God or governmental actions or other conditions beyond the control of the Consultant. Any extension agreed upon by the parties must be in writing, signed by both parties, and incorporated as a Change Order to this Work Order.

Section 3 – PAYMENTS: The Consultant agrees to perform all of the work set forth herein and further described in ATTACHMENT A – SCOPE OF WORK AND/OR ENGAGEMENT LETTER, attached hereto for an amount shown in ATTACHMENT B – TERMS AND CONDITIONS, herein referred to as the "Work Order Amount" without further authorization by Change Order. Such payment shall be full compensation for work performed and/or services rendered and for all supervision, labor, supplies, materials, equipment or use thereof, and for all other expenses and incidentals necessary to complete all the work. Invoices and applicable attachments shall be emailed to the attention of SHA's Project Manager.

SECTION 4 – INSURANCE: The insurance requirements for the Contract No. shown above shall be the same for this Work Order and such policy(ies) shall apply to the work included in this Work Order unless changed herein.

IN WITNESS WHEREOF, the parties hereto have executed this Work Order by having their representatives affix their signatures below.

Housing Authority of the City of Seattle
101 Elliott Ave W, Suite 100
P.O. Box 79015
Seattle, WA 98119

By: _____
Date

By: _____
Date

SAMPLE

Attachments:

- A SCOPE OF WORK AND/OR ENGAGEMENT LETTER**
- B TERMS AND CONDITIONS**

SAMPLE

ATTACHMENT A – SCOPE OF WORK AND/OR ENGAGEMENT LETTER
(Work Order No. 001 to Contract No. 5858)

SAMPLE

ATTACHMENT B – TERMS AND CONDITIONS

(Work Order No. 001 to Contract No. 5858)

Project Completion Date (Section 2 of the Work Order): Authorization to Begin Work on: Completion Date:	Work Order Amount (Section 3 of Work Order): \$0.00
Basis of Payment (hourly rate, lump sum, etc.) (Section 3 of Work Order):	
Subcontractors or Sub-consultants Authorized	
Name of Consultant's Key Personnel Essential to the Work	
SHA's Project Manager Name Cindy Sribhibhadh (Seattle Housing Authority)	
Consultant's Name and Address for Delivery of Notices	SHA's Name and Address for Delivery of Notices (Section 11 of the Contract) Housing Authority of the City of Seattle Attn: Cindy Sribhibhadh (Seattle Housing Authority) 101 Elliott Ave W, Suite 100 P.O. Box 79015 Seattle, Washington 98119

SAMPLE

Project Identification: **Various Hope VI Shower Upgrades - LP Non-Federal Funding**

Pursuant to, and in compliance with the Request for Bids and other documents relating thereto, and subject to all conditions thereof, the undersigned hereby proposes and agrees to furnish all labor, materials, equipment and testing necessary to perform and furnish the Work as indicated in the Contract Documents, and in accordance with the terms and conditions of the Contract Documents.

In submitting this Bid, the Bidder represents that:

- A. This Bid will remain subject to acceptance for 60 days after the day of opening.
- B. The Owner has a right to reject this Bid.
- C. Bidder will sign and submit the Agreement with Bonds, Insurance, and other documents required by the bid documents within 7 calendar days after the date of Owner's Notice of Award.
 - 1. The bond requirement can be waived for contracts up to \$100K. If this option is exercised, SHA will hold 10% retainage in lieu of bonds.
- D. Bidder has examined all bidding documents and has visited the site and become familiar with the general, local and site conditions.
- E. Bidder will ensure equal opportunity for employment and to engage in Affirmative Efforts in the solicitation of women and minorities, Section 3 residents, WMBE and Section 3 firms for participation on this Contract.
- F. Bidder accepts the provisions of and represents that Bid is in accordance with the Contract Documents.

Bidder will complete the Work in accordance with the Contract Documents for the following price.

It's mandatory to provide pricing for all items listed on the form.

Item #	Description	Quantity	Unit Bid Price	Extended Price
1	Complete Tub and Tub Surround installation as described in attachment B - Scope of Work for a total of 5 units.	5*	\$	\$
Any required repairs revealed during inspection and Tub and Tub Surround installation will be based on an hourly rate provided for a Not To Exceed amount of \$1,000.00 per repair to include any reimbursable materials needed for such repair. The hourly quantities shown below are an estimate only and SHA does not guarantee that the work actually performed will be equal to the estimated quantity given below.				

Item #	Description	Quantity	Unit Bid Price	Extended Price
2	Complete Walk in Shower installation as described in attachment B - Scope of Work for a total of 3 units.	3*	\$	\$
Any required repairs revealed during inspection and Tub and Tub Surround installation will be based on an hourly rate provided for a Not To Exceed amount of \$1,000.00 per repair to include any reimbursable materials needed for such repair. The hourly quantities shown below are an estimate only and SHA does not guarantee that the work actually performed will be equal to the estimated quantity given below.				

Item #	Description	Quantity	Unit Bid Price	Extended Price
3	Complete Tub or Walk in Shower Conversion to ADA Accessible Shower installation as described in attachment B - Scope of Work for a total of 2 units.	2*	\$	\$

Any required repairs revealed during inspection and Tub and Tub Surround installation will be based on an hourly rate provided for a Not To Exceed amount of \$1,000.00 per repair to include any reimbursable materials needed for such repair. The hourly quantities shown below are an estimate only and SHA does not guarantee that the work actually performed will be equal to the estimated quantity given below.

Item #	Description	Quantity	Unit Bid Price	Extended Price
4	Hourly billing rate for unforeseen or additional repairs. This may include but is not limited to: replacing damaged or missing drywall, mold remediation, and/or repairing water damage.	100 Hours*	\$	\$

Any required repairs revealed during inspection and Tub and Tub Surround installation will be based on an hourly rate provided for a Not To Exceed amount of \$1,000.00 per repair to include any reimbursable materials needed for such repair. The hourly quantities shown below are an estimate only and SHA does not guarantee that the work actually performed will be equal to the estimated quantity given below.

BASE BID PRICE - Item #1 + Item #2 + Item #3 + Item #4 (WITHOUT WA STATE SALES TAX):	\$
WA STATE SALES TAX (ON MATERIALS AND LABOR):	\$
TOTAL BID PRICE INCLUDING WA STATE SALES TAX:	\$

*The estimated number of installations is being given only as the basis for the comparison of bids. SHA does not warrant, expressly or by implication that the actual amount of work will correspond therewith. SHA reserves the right to add or subtract installations during the contract term if determined to be in the best interest of SHA.

END OF BID PRICE FORM



VENDOR FACT SHEET

Return this Form TO: Seattle Housing Authority, Purchasing Division,
ATTN: Veronica Sharp, Design and Construction Contract Administrator
101 Elliott Ave W, Suite 100, PO Box 79015, Seattle, WA 98119

General Business Information:		For SHA Use Only:	
Name of Business, Organization, or Name of Person (if payment is to an individual):		JDE Vendor No.	Purchasing contracts <input type="checkbox"/>
Mailing Address for Payments:			
City:	State:	Zip Code:	E-Mail Address:
Telephone No.:	Fax No.:	DUNS No.:	
Washington UBI No.:	City of Seattle Business License No.:	Washington Contractor's License No.:	
Employee Tax ID No. (TIN) or Social Security No. (if Individual):			
President/General Manager:	Principal products and/or services offered:		

Type of Organization (check one):

Individual <input type="checkbox"/>	Sole Proprietor <input type="checkbox"/>	Partnership <input type="checkbox"/>	Corporation <input type="checkbox"/>	Governmental Agency <input type="checkbox"/>	Other _____ <input type="checkbox"/>
--	---	---	---	---	---

Substitute IRS Form W-9 Certification:

Under penalties of perjury, I hereby certify that the number shown on this form is my correct taxpayer identification number, and that I am not subject to backup withholding because: (a) I am exempt from backup withholding, or (b) I have not been notified by the Internal Revenue Service (IRS) that I am subject to backup withholding as a result of a failure to report all interest or dividends, or (c) the IRS has notified me that I am no longer subject to backup withholding, and I am a U.S. person (including a U.S. resident alien). Note: The Internal Revenue Service does not require your consent to any provision of this document other than the certifications required to avoid backup withholding.

SIGN HERE →	Signature of U.S. Person	Date
--------------------	---------------------------------	-------------

Ownership Status (check all that apply):	Racial/Ethnic Status (check one):
<input type="checkbox"/> MBE (Minority-Owned Business Enterprise) <input type="checkbox"/> WBE (Women-Owned Business Enterprise) <input type="checkbox"/> MWBE (Minority / Women-Owned Business Enterprise) <input type="checkbox"/> CBE (Combination Business Enterprise) <input type="checkbox"/> Small Business <input type="checkbox"/> HUD Section 3 Business <input type="checkbox"/> Certified by OMWBE (Washington State Office of Minority and Women's Business Enterprises) <input type="checkbox"/> Self-Identified (SHA may request a signed statement re: self-certification)	<input type="checkbox"/> Caucasian (1) <input type="checkbox"/> African American (2) <input type="checkbox"/> Native American (3) <input type="checkbox"/> Hispanic American (4) <input type="checkbox"/> Asian/Pacific American (5) <input type="checkbox"/> Hasidic Jews (6)

Method of Contract Payments: As outlined on the reverse side of this form, for contracts over one million dollars, SHA's method of contract payments is through an electronic virtual credit card issued by SHA's e-payables vendor, Bank of America. Unless SHA grants a waiver, Vendors will receive an enrollment form from SHA following issuance of a contract.

SIGN BELOW:

Signature of Authorized Representative of Vendor:	Date:
---	-------

By signing immediately above, the Vendor hereby represents the following:

- The Vendor certifies that to the best of its knowledge and belief, neither it, nor any person/principal or firm which has an interest in the Vendor's firm, is ineligible to participate in a SHA contract, purchase order, direct pay or other transaction, pursuant to the Certification of Eligibility provision specified in the Vendor Fact Sheet Instructions, or;
- The Vendor will comply with SHA's General Terms and Conditions applicable to Purchase Orders, if the Vendor will be supplying goods and/or services through an SHA Purchase Order.

To obtain a copy of the General Terms and Conditions, call (206) 615-3379 or visit our Web site at https://www.seattlehousing.org/sites/default/files/Purchase_Orders_Terms_Conditions.pdf

Vendor Fact Sheet Instructions

Thank you for your interest in doing business with the Seattle Housing Authority (SHA). We look forward to doing business with you. If you have any questions about completion of the Vendor Fact Sheet, please call us at (206) 615-3379.

In order for SHA to make payments to you or to procure goods or services from you, we need the information requested on the Vendor Fact Sheet, which also serves as a substitute IRS W-9 Form. The information about you will be entered into our computerized payment system and will allow us to make required reports to the Federal government about our business and payment transactions.

Substitute IRS Form W-9 Certification: In completing the Vendor Fact Sheet, you must sign the "Substitute IRS Form W-9 Certification" or backup withholding will apply. If you are subject to backup withholding and you are merely providing your correct taxpayer identification number to SHA, you must cross out the portion of the certification after the word "and" in line two, through the end of line five, before signing the form. Detailed instructions about IRS Form W-9 are included on the form, which may be obtained by calling our office at (206) 615-3379 or visiting the IRS web site at www.irs.gov.

Certification of Eligibility: In order to do business with SHA, the Vendor must be eligible to:

- 1) Be awarded contracts by any agency of the U.S. Government, HUD, or the State in which this Contract work is to be performed; or,
- 2) Participate in HUD programs pursuant to 24 CFR Part 24.

Use the websites of the [General Services Administration](#) and the [U.S. Department of Housing and Urban Development](#) to verify eligibility of the firm and its principals. By signing the Vendor Fact Sheet, the Vendor understands that the certification of eligibility is a material representation of fact upon which reliance was placed when SHA agreed to enter into the transaction with the Vendor. SHA may require the Vendor to submit such certification on an annual basis depending on the terms of its contract or the frequency of its business transactions with SHA. If the Vendor subcontracts any portion of the work, the Vendor will be required to submit a similar certification of eligibility to SHA for any Vendor subcontracts. Any written contract executed between SHA and the Vendor shall include these provisions, which may also be referred to as Suspension/Debarment provisions.

Contract Payments: Unless SHA grants a waiver, its method of contract payment for contracts of one million or more is through its Bank of America e-payables program. Payments will be made electronically through a virtual Visa credit card. Benefits for using this method include reduced labor costs associated with the processing of checks and enhancing cash flow by eliminating float time associated with the mailing of checks. To learn more about the program, please click here or copy and paste the following URL into your browser: www.bankofamerica.com/epayablesvendors. For new vendors, SHA will automatically send an enrollment form upon contract award. If you have questions about the program, please contact Tran Wong, SHA's Accounts Payable Manager, at 206-615-3483 or twong@seattlehousing.org.

Small Businesses: The Vendor Fact Sheet also requests information about whether your business is owned and controlled by women or minorities, and/or is a small business. The following are definitions of these terms for your use. This information provides valuable information to SHA in its efforts to ensure its contracting program meets its diversity objectives and requirements.

- **WMBE:** Minority and women-owned business enterprises must either be self-identified or certified by the Washington State Office of Women's and Minority Business Enterprises (OMWBE) to be at least fifty-one percent owned by women and/or minority group members. For self-identification as WMBE, refer to [Minority/Women Owned Business Enterprise Self-Identification Form for Work Performed on Seattle Housing Authority Projects](#)
- **Small Business:** A small business means a business concern, including its affiliates, that is independently owned and operated, not an affiliate or subsidiary of a business dominant in its field of operation, and qualified as a small business under the criteria and size standards in 13 CFR 121. Furthermore, a business is considered small according to the Small Business Administration's established guidelines provided to such businesses.
- **HUD Section 3 Business:** A business that meets at least one of the following criteria, documented within the last six-month period: (1) at least 51% owned and controlled by low- or very low-income persons; (2) over 75% of the labor hours performed for the business over the prior three-month period are performed by Section 3 workers; or (3) a business at least 51% owned and controlled by current public housing residents or residents who currently live in Section 8-assisted housing. More detailed information available at the website of [the U.S. Department of Housing and Urban Development](#).

SEATTLE HOUSING AUTHORITY

SUSPENSION AND DEBARMENT COMPLIANCE CERTIFICATE

By signing below, the Participant Certifies that to the best of its knowledge and belief neither its firm nor any of its principals as named below are presently debarred, suspended, or have been declared ineligible or are excluded from participation in this transaction by any federal, state or local government.

Participant's Firm Name: _____

Address: _____

City, State, Zip: _____

	PRINCIPAL(S) Name(s)	Title(s)
1		
2		
3		
4		
5		

Participant's Signature	Printed Name	Title	Date

NOTE: This requirement applies to the Participant's firm as well as its principals. Principal is defined in the regulation (2 CFR 180.995) as follows:

- 1) An officer, director, owner, partner, principal investigator, or other person within a participant with management or supervisory responsibilities related to a covered transaction; or
- 2) A participant or other person, whether or not employed by the participant or paid with Federal funds, who-
 - a) Is in a position to handle Federal funds;
 - b) Is in a position to influence or control the use of those funds; or,
 - c) Occupies a technical or professional position capable of substantially influencing the development or outcome of an activity require to perform the covered transaction.

The federal websites to verify eligibility include: <https://sam.gov/content/exclusions> and http://portal.hud.gov/hudportal/HUD?src=/topics/limited_denials_of_participation.

SEATTLE HOUSING AUTHORITY

**SUSPENSION AND DEBARMENT COMPLIANCE CERTIFICATE
FOR
SUB-CONTRACTOR/SUB-CONSULTANT**

The Prime Participant (the “Prime”) may use this form if the Prime can verify that its Sub-Contractor and/or Sub-Consultant (the “Lower Tier Participant”) named below, nor any of their principals are debarred, suspended or ineligible from involvement by Federal, State or Local Government. If the Prime is unable to verify this information, the Prime must send the previous SUSPENSION AND DEBARMENT COMPLIANCE CERTIFICATE form to each Lower Tier Participant to be completed and returned.

Prime Participant’s Name: _____
certifies that neither any of the Lower Tier Participant named below, nor any of its principals are debarred, suspended or ineligible from involvement by Federal, State or Local Government. I understand that the Seattle Housing Authority (SHA) relies on this certification and I understand that I am obligated to submit the following to SHA:

- A certification for any new Lower Tier Participant hired after submission of this certification.
- A renewal certification for every Lower Tier Participant on the anniversary of the Contract execution date if the Contract Time extends beyond one year.

(Note: In lieu of this certification, the Prime may elect to submit a separate certification signed by each Lower Tier Participant to SHA as evidence of Lower Tier Participant's eligibility. It is the Prime’s responsibility to initiate, obtain, and provide all such individual Lower Tier Participant certifications to SHA.)

Prime Participant’s Signature	Printed Name	Title	Date

Lower Tier Participant Listing: (If Lower Tier Participant is not involved in the project, please enter NONE.)

If additional pages are necessary, copy this form to ensure signed statement precedes any listing of Lower Tier Participant.

Please contact Veronica Sharp, Design and Construction Contract Administrator by e-mail at veronica.sharp@seattlehousing.org or at 206-239-1553 if you have any questions regarding compliance with this requirement.



Address 190 Queen Anne Ave N
PO Box 19028
Seattle, WA 98109

Telephone 206-615-3300

TTY 1-800-833-6388

Website www.seattlehousing.org

Certification of Compliance with Wage Payment Statutes

The undersigned hereby certifies that the bidder is now, and in the three-year period immediately preceding the date of this bid solicitation February 29, 2024, has been, in compliance with the responsible bidder criteria requirement of RCW 39.04.350(1)(g) and has not been found to have willfully violated any provision of RCW Chapters 49.46, 49.48, or 49.52 in a final determination by the Department of Labor and Industries or any court of limited or general jurisdiction.

I certify under penalty of perjury under the laws of the State of Washington that the foregoing is true and correct.

Bidder's Business Name

Signature of Authorized Official*

Printed Name

Title

Date

City

State

Check One:

Sole Proprietorship Partnership Joint Venture Corporation

State of Incorporation, or if not a corporation, State where business entity was formed:

If a co-partnership, give firm name under which business is transacted:

If a corporation, proposal must be executed in the corporate name by the president or vice-president (or any other corporate officer accompanied by evidence of authority to sign). If a co-partnership, proposal must be executed by a partner.

NON-COLLUSIVE AFFIDAVIT

State of Washington)ss
County of King)

_____ who is a _____
of the firm of _____,

being first
duly sworn, on their oath, says that the bid herewith submitted is a genuine and
not a sham or collusive bid, or made in the interest or on behalf of any person not
therein named; and further states that the said bidder has or was not directly or
indirectly induced or solicited by any bidder on the above work or supplies to put
in a sham bid, or any person or corporation to refrain from bidding; and that said
bidder has not in any manner sought by collusion to secure themselves an
advantage over any other bidder or bidders, or to secure any advantage against
the Seattle Housing Authority or any person interested in the proposed contract;
and that all statements in said proposal or bid are true.

BIDDER
(if individual)

PARTNER
(if partnership)

OFFICER
(if corporation)

Subscribed and sworn to before me

this _____ day of _____, 20_____.

Notary Public in and for the State of Washington,
residing at _____.

My commission expires _____, 20_____.