

ICIL

INTEGRAL CABLE AND INTERCONNECT LLP

BS SERIES SWAPPABLE COMBO CONNECTOR FOR ELECTRICAL VEHICLE

- Heavy duty, robust and strong
- Polarization provided by insulator to avoid wrong mating.
- High mating cycles
- Integrated combo design 2 power+8
- Solder type terminal make easier onsite installation
- Customized options available as per customer requirement for
- Current rating up to 40 amp for power and 3 amp for data signal.
- Proper locking provided to sustain vibration conditions.
- Metal guide to Male connector for blind mating.

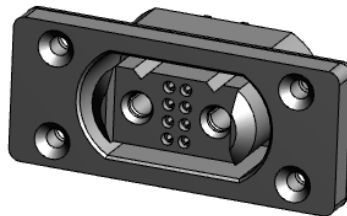

Female connector 2 power + 8 signal Battery pack Blind Mating

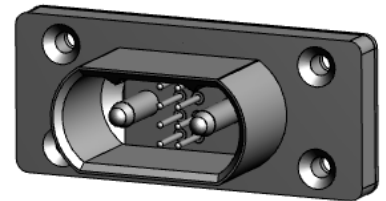

Male 2 power + 8 signal Male connector without Guide

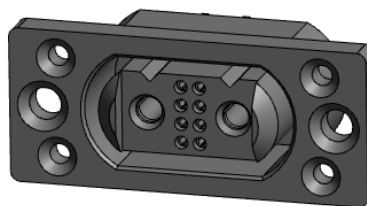

Female connector 2 power + 8 signal Battery pack Blind Mating

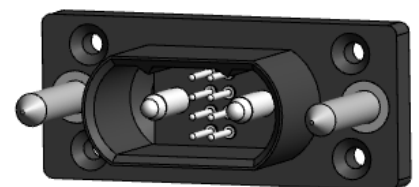

Male 2 power + 8 signal Male connector **with Guide**

Highest Quality Standard connector With Innovative Contact Design For Highest mating cycles Performance at Affordable Price.

Manufacturer of IP68, Circular, Rectangular, power, signal & combo connectors.

BS Series Technical Details**❖ Materials and Finishes**

Insulator: Nylon, Glass filled, UL 94 V0 Black

Contacts: Precision Machined Copper alloy with silver plating and Gold plating

Rubber Parts: Silicon

❖ Mechanical Characteristics

1] Polarization provided by Insulator.

2] Mating cycles: 2000 cycles

3] Contact style: fixed solder type

❖ Electrical Characteristics

Contact Current Ratings : Signal contact-3 amp with silver plating

Power contact – with 4 sq.mm : 30 amp, with 6 sq.mm- 40 amp,

10 sqmm - 60amp with Gold plating

Contact Resistance – 10 m Ω ;

Insulation Resistance : >500 M Ohm

Working Voltage : Signal contact = 250 V r.m.s, Power contacts: 500V r.m.s ; AC/DC

Dielectric withstand Voltage: 1000 V r.m.s

❖ Climatic Characteristic

Working temperature: -45°C to +105 °C ,

IP protection – Individual Female and Male connector IP 67 with Rubber Gasket in mounting condition per IS/IEC 60529:2001

Note: **No** IP protection in mating with Male connector in mating portion.



BS series Female combo connector 2 power + 8 data signal

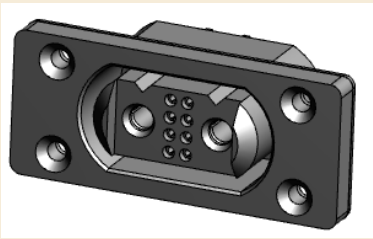

BS8W2SG0S

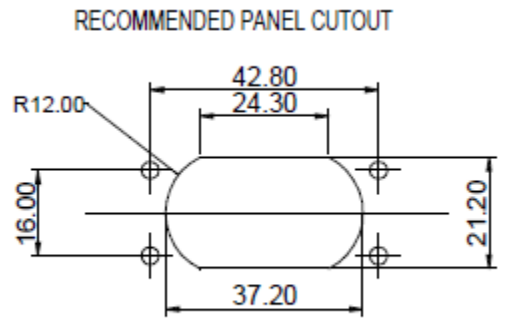
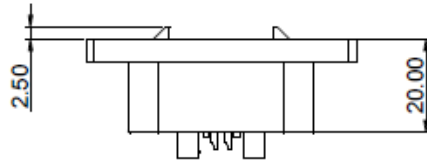
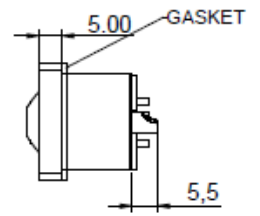
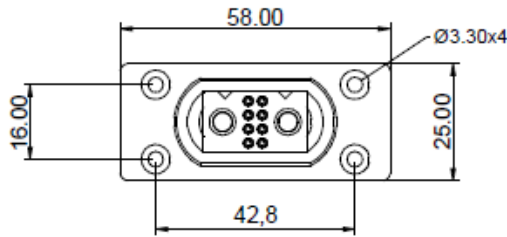

Customized pin configuration available : for example only 2 power, 2 power + 1 to 8 any signal configuration.

only basic dimensions are shown here. Full dimensional detail is available in the respective product drawings.

BS series Male combo connector 2 power + 8 data signal without Guide

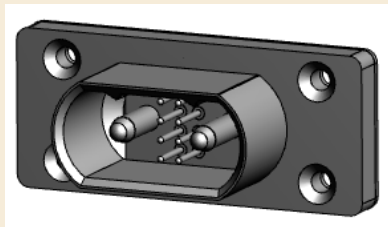

Part No. : BS8W2P00S

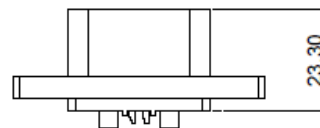
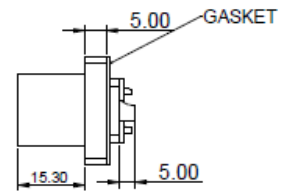
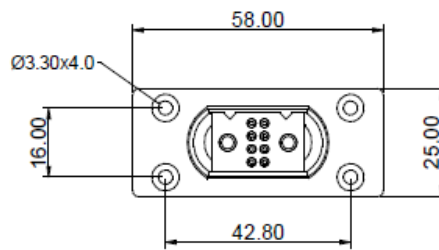

RECOMMENDED PANEL CUTOUT

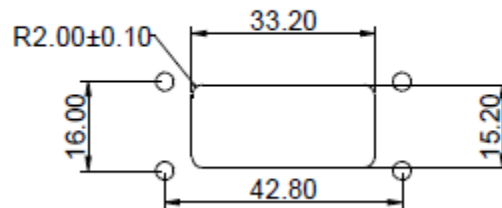

Customized pin and cable configuration available : for example only 2 power, 2 power + 1 to 8 any signal configuration.

BS series Female combo connector 2 power + 8 data

ICIL

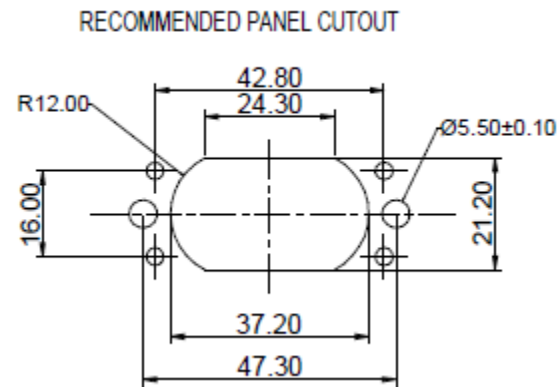
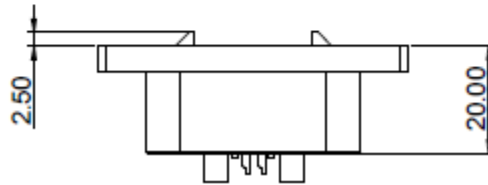
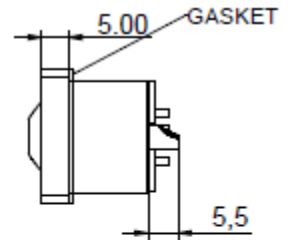
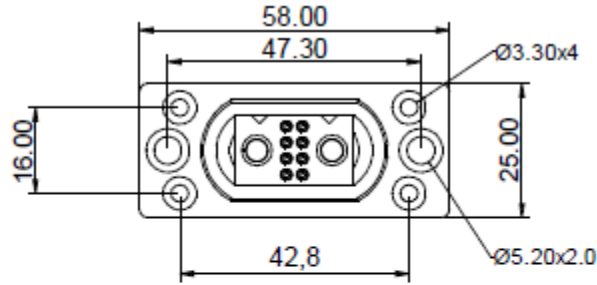
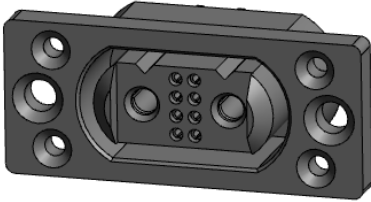

BS8W2SG0S

Customized pin configuration available : for example only 2 power, 2 power + 1 to 8 any signal configuration.

BS series Male combo connector 2 power + 8 data signal with guide

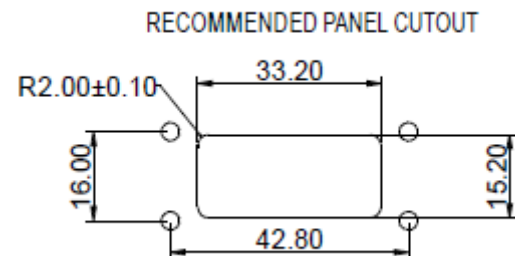
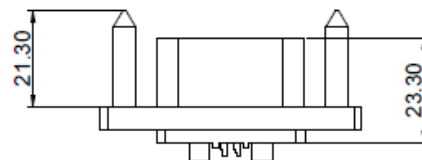
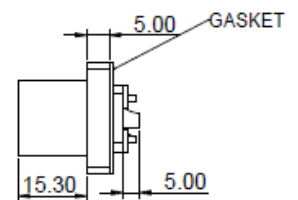
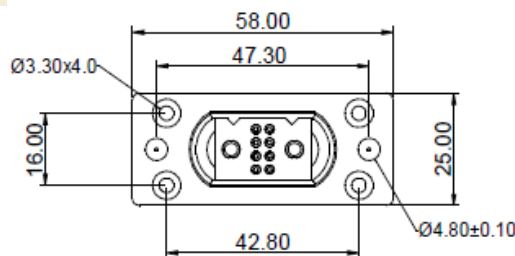
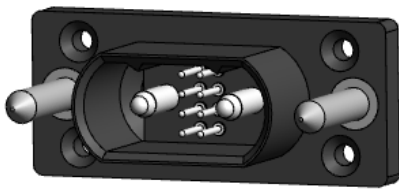

BS8W2PG0S

Customized pin configuration available : for example only 2 power, 2 power + 1 to 8 any signal configuration.



BS Series connector Ordering Part selection Chart
Specify complete connector Part no.by following step 1 through step 6.

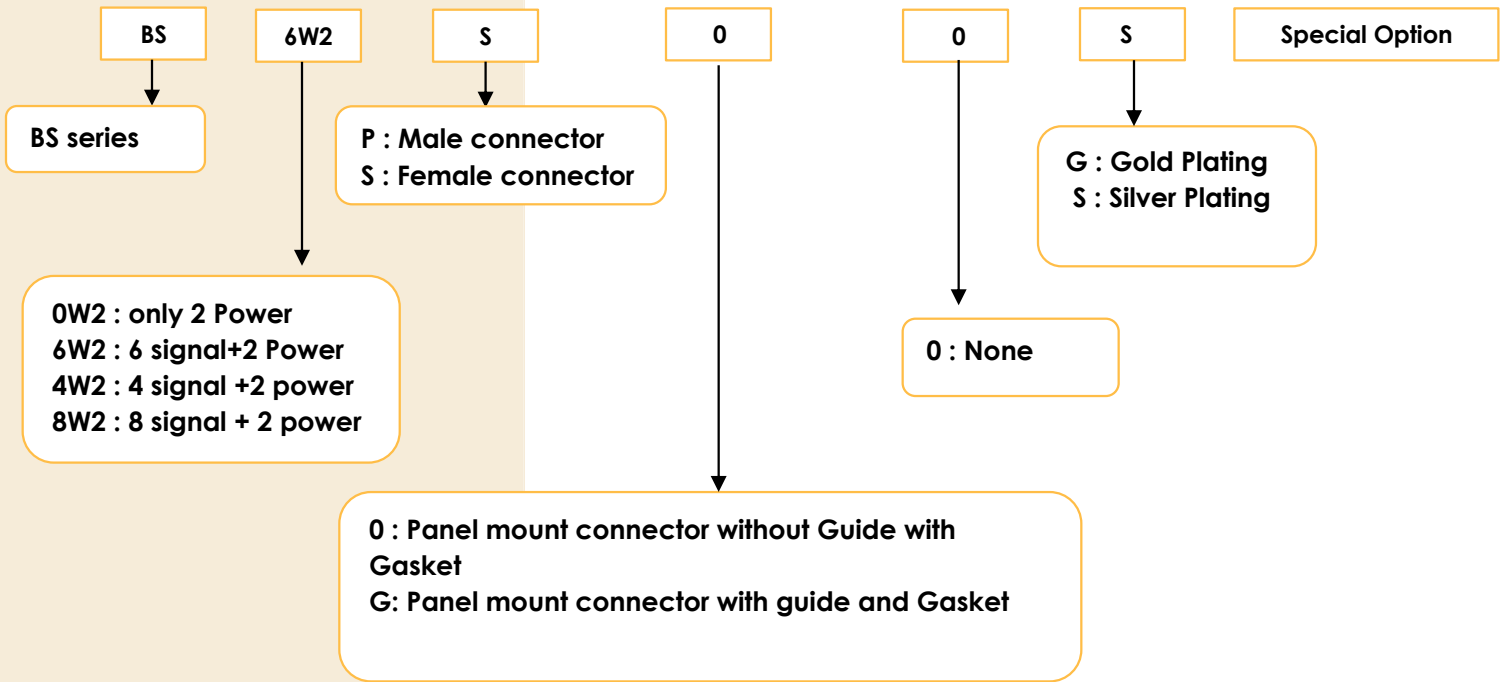

Contact US : Integral cable and Interconnect LLP.

Factory Address : Sr. No. 13/2 B -606 orchid Plaza near JSPM college, Narhe, Pune 411041,India
Contact Person: Roshan Ballamwar Contact Person: Ajit Kshirsagar
Contact No. : +91 9030038247 Contact No. +91 9822495243, +91 8793007075
Email ID: roshan@integralconnect.in Email ID: ajit@integralconnect.in
Sales Office : Pune ,Hyderabad Distributor location: Pune, Mumbai, Bangalore, Delhi

www.integralconnect.in