

ICIL

INTEGRAL CABLE AND INTERCONNECT LLP

PS SERIES COMBO CONNECTOR FOR ELECTRICAL VEHICLE

- ✦ Heavy duty ,robust and strong
- ✦ Polarization provided by insulator to avoid wrong mating.
- ✦ High mating cycles
- ✦ Integrated combo design 2 power+6 data signal and 2 power+4 data signal
- ✦ Solder type terminal make easier onsite installation
- ✦ Customized options available as per customer requirement.
- ✦ Current rating up to 40 amp for power and 3 amp for data signal.
- ✦ Proper locking provided to sustain vibration conditions.
- ✦ Stylish look over molded male connector with easy un mate lever.
- ✦ Separate cable for data signals to avoid power interference.

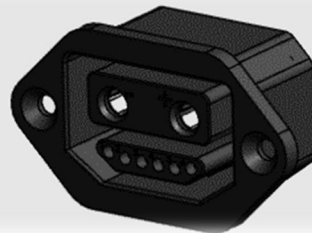

Female connector 2 power + 6 signal Battery pack



Male 2 power + 4 & 6 signal Cable over molded connector

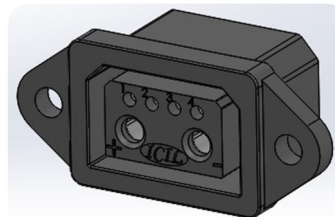

Female connector 2 power + 4 signal Battery pack

Highest Quality Standard connector With Innovative Contact Design For Highest mating cycles Performance at Affordable Price.

Manufacturer of IP68, Circular, Rectangular, power, signal & combo connectors.

❖ Materials and Finishes

Insulator: Nylon, Glass filled, UL 94 V0 Black Contacts: Precision Machined Copper alloy with nickel plating.
Rubber Parts: Hi Nitrile.

❖ Mechanical Characteristics

1] Polarization provided by Insulator. 2] Mating cycles: 500 cycles
 3] Contact style: fixed solder type

❖ Electrical Characteristics

Contact Current Ratings : Signal contact-3 amp, Power contact – with 4 sq.mm : 30 amp, with 6 sq.mm- 40 amp
Contact Resistance – 10 mΩ ; Insulation Resistance : 2 G Ohm

Working Voltage : Signal contact = 250 V r.m.s, Power contacts: 500V r.m.s ;

Dielectric withstand Voltage: 1000 V r.m.s

❖ Climatic Characteristic

Working temperature: -45°C to +85 °C ,

IP protection – Female connector IP 67 with Rubber Gasket in mounting condition per IS/IEC 60529:2001

Female combo connector 2 power + 6 data signal

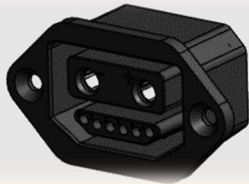

PS6W2S00N

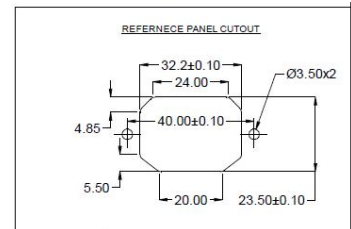
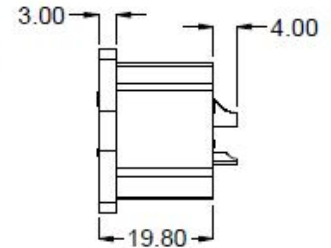
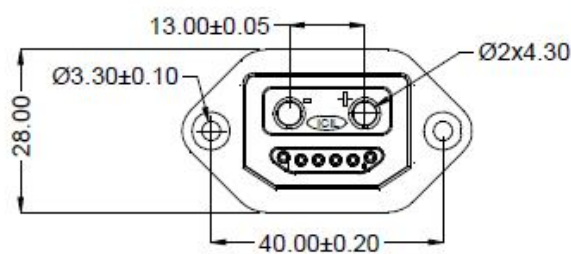

Customized pin configuration available : for example only 2 power, 2 power + 1 to 6 any signal configuration.

only basic dimensions are shown here. Full dimensional detail is available in the respective product drawings.

Male combo cable connector 2 power + 6 data signal

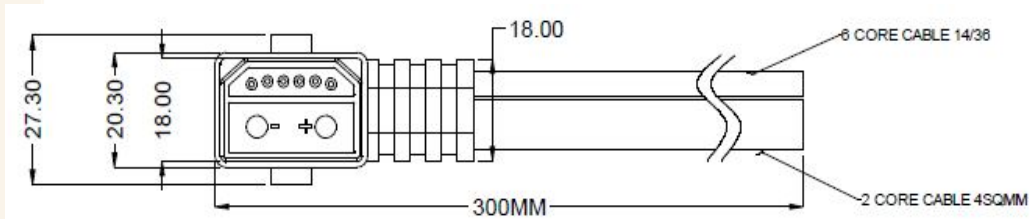

Part No. : PS6W2PC1AN-L0.30

Customized pin configuration available : for example only 2 power, 2 power + 1 - 4 any signal configuration, power cable customized option available as per customer requirement for cable Gauge-1 sq.mm to 6sq.mm and cable length standard 300mm,can be provide customized length.



Female combo connector 2 power + 4 data signal

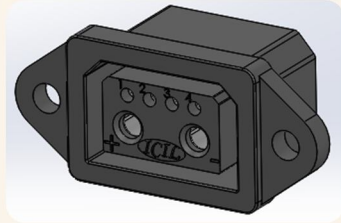

PS4W2S00N

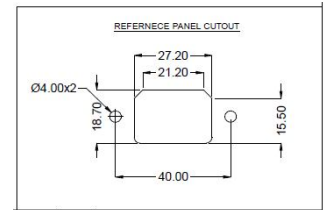
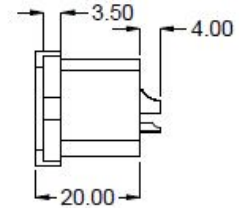
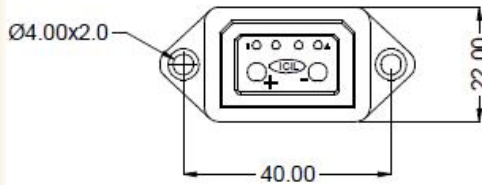

Customized pin configuration available : for example only 2 power, 2 power + 1 to 4 any signal configuration.

PS Series connector Ordering Part selection Chart
Specify complete connector Part no. by following step 1 through step 6.

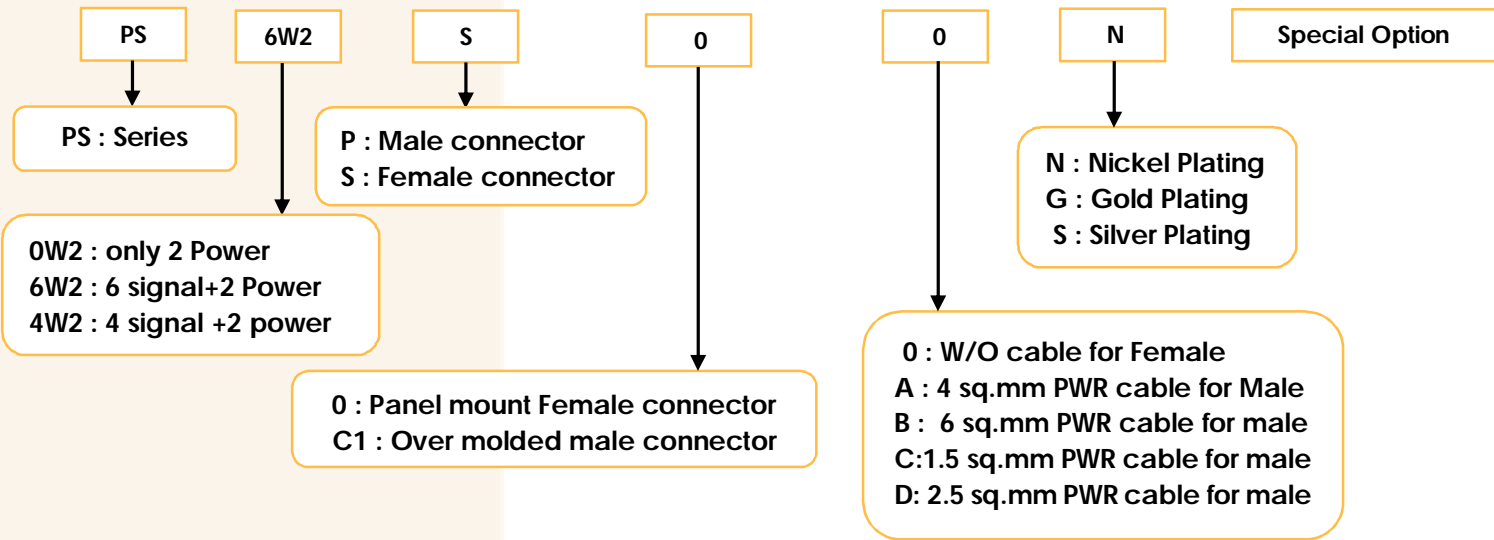

Contact US : Integral cable and Interconnect LLP.
 Factory Address : Sr. No. 13/2 B -606 orchid Plaza near JSPM college, Narhe, Pune 411041,India
 Contact Person: Roshan Ballamwar Contact Person: Ajit Kshirsagar
 Contact No. : +91 9030038247 Contact No. +91 9822495243, +91 8793007075
 Email ID: roshan@integralconnect.in Email ID: ajit@integralconnect.in