

# — SURGICAL MANUAL

***GRAND MORSE***

*THE GRAND MORSE  
IMPLANT SYSTEM*

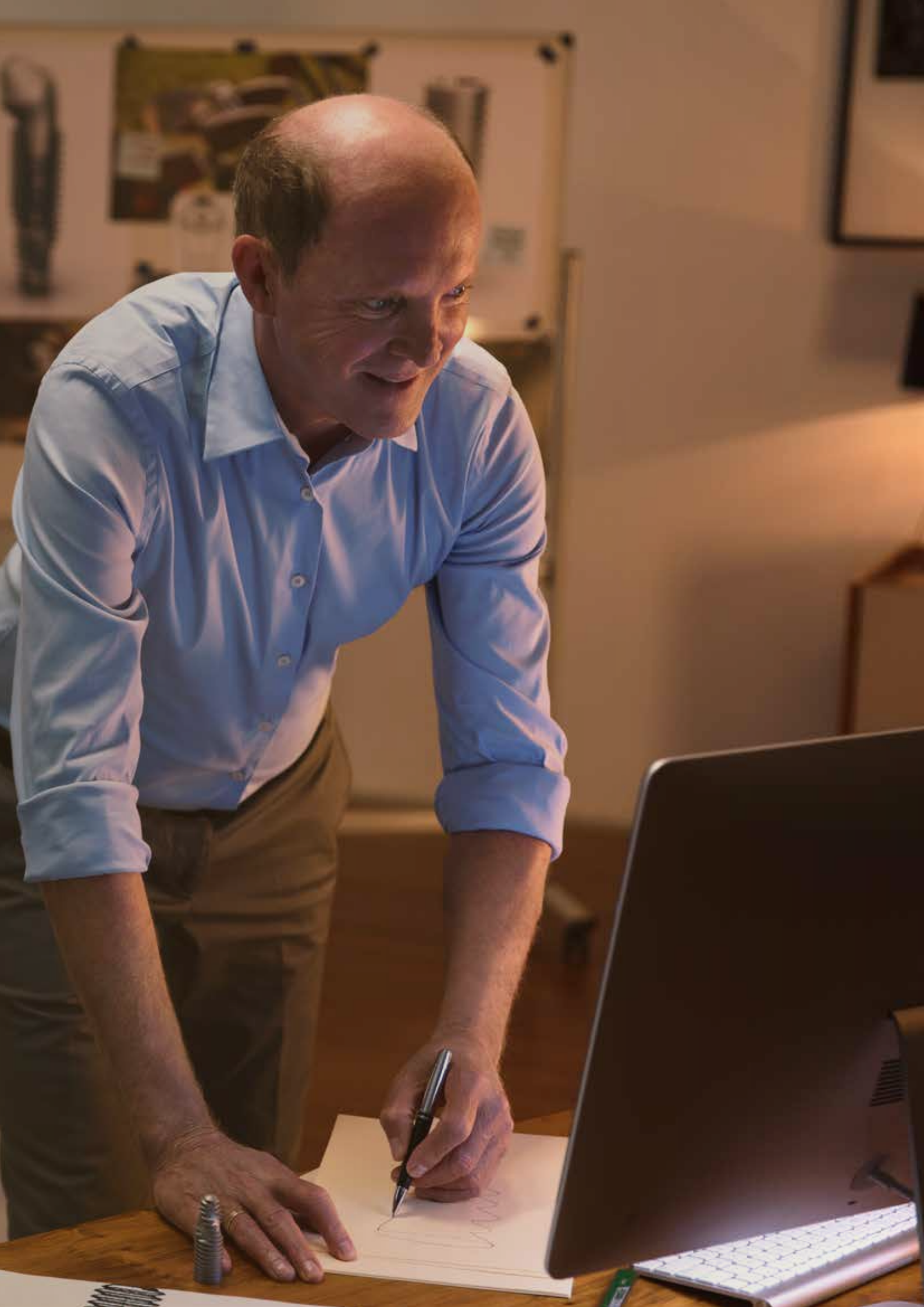





# CONTENTS

<b>1.0 BASIC INFORMATION ON SURGICAL PROCEDURES</b>	<b>8</b>
<b>2.0 NEODENT IMPLANT SYSTEM</b>	<b>8</b>
<b>2.1 Overview</b>	<b>8</b>
<b>3.0 IMPLANT DESIGNS</b>	<b>11</b>
<b>3.1 Surface</b>	<b>12</b>
3.1.1 <i>NeoPoros</i>	12
3.1.2 <i>Acqua</i>	13
<b>3.2 Implant Options</b>	<b>14</b>
3.2.1 <i>Helix GM</i>	14
3.2.2 <i>Drive GM</i>	14
3.2.3 <i>Titamax GM</i>	15
<b>3.3 Options for Screw Threads and Overview of the Format According to Implant Design</b>	<b>16</b>
<b>4.0 INDICATIONS AND CONTRAINDICATIONS</b>	<b>18</b>
<b>5.0 PREOPERATIVE PLANNING</b>	<b>19</b>
<b>5.1 Implant positioning and peri-implant tissue</b>	<b>19</b>
3.1.1 <i>Mesiodistal positioning of the implant</i>	20
3.1.1.1 <i>Examples of single tooth gaps</i>	21
3.1.1.2 <i>Examples of multiple tooth gaps</i>	22
3.1.2 <i>Vestibulolingual implant position</i>	24
3.1.3 <i>Cervicoapical position of the implant</i>	24
<b>5.2 Planning Aids</b>	<b>25</b>
3.2.1 <i>Space Planning Instrument for assisting in the diagnosis and positioning of implants</i>	25

5.2.2	<i>Direction indicators for diagnosing the adjacent bone</i>	26
5.2.3	<i>Surgical drill guide</i>	28
<b>6.0</b>	<b>SURGICAL PROCEDURES</b>	<b>29</b>
<b>6.1</b>	<b>Implant bed preparation</b>	<b>29</b>
6.1.1	<i>Basic implant bed preparation</i>	29
6.1.1.1	<i>Implant bed preparation for GM Helix conical implants</i>	31
6.1.1.2	<i>Implant bed preparation for GM Drive conical implants</i>	34
6.1.1.3	<i>Implant bed preparation for GM Titamax cylindrical implants</i>	35
6.1.2	<i>Details on special implant bed preparation</i>	37
6.1.2.1	<i>Tapered Contour Drill</i>	37
6.1.2.1	<i>Pilot Drill</i>	38
6.1.2.3	<i>Example of special implant bed preparation</i>	38
6.1.2.4	<i>Options for drills</i>	40
<b>6.2</b>	<b>Neodent Implant Packaging</b>	<b>40</b>
<b>6.3</b>	<b>Placing of the Grand Morse Implant</b>	<b>42</b>
6.3.1	<i>Placing of the implant with the contra-angle handpiece</i>	42
6.3.2	<i>Manual placement of the implant</i>	44
6.3.3	<i>Completing the positioning of the implant with the Torque Wrench</i>	44
6.3.4	<i>Torque Wrench</i>	45
<b>6.4</b>	<b>Handling soft tissue</b>	<b>45</b>
6.4.1	<i>Two-step/submucosal healing</i>	45
6.4.2	<i>Transmucosal healing: one-step or immediate loading</i>	49
6.4.2.1	<i>Transmucosal healing: one-step</i>	50

<b>6.5 Overview of the healing abutments</b>	<b>51</b>
6.5.1 Overview of Grand Morse abutments and corresponding healing abutments	52
6.5.1 Grand Morse Customizable Healing Abutments	53
<b>7.0 HEALING PHASE</b>	<b>54</b>
<b>8.0 GENERAL PROSTHETIC GUIDELINES</b>	<b>54</b>
<b>9.0 NEODENT KITS</b>	<b>55</b>
9.1 Cleaning and Care of the Cassette and Instruments	55
9.2 Sterilization of the Cassette and Instruments	55
9.3 Cleaning and Care of the Drills	56
9.4 Drill Sterilization	57
<b>BIBLIOGRAPHY</b>	<b>59</b>

## 1.0 BASIC INFORMATION ON SURGICAL PROCEDURES

The modern era of implant dentistry, based on the clinical results of osseointegration, was originally published in English journals in 1977<sup>1</sup>. Since then, dentistry has undergone significant changes. The current treatment plan for patients usually offers implant-retained and/or implant-supported prostheses as an accessible and reliable solution. The number of dental implants has increased rapidly in recent years,<sup>2,3</sup> and this form of treatment requires specific knowledge and skills, such as the surgeon's learning curve, which are relevant to the results.<sup>4</sup> Based on these facts, the objective of these guidelines is to provide dental surgeons and specialists with basic information and guidelines on planning, surgical procedures and treatment options.

These guidelines do not substitute each product's instructions for use (IFU). These can be found at our website: [www.ifu.neodent.com.br](http://www.ifu.neodent.com.br). It is the surgeon's sole responsibility to analyze the patients' general health, the viability of the surgical procedure and the most appropriate products for each clinical situation.

## 2.0 NEODENT IMPLANT SYSTEM

### 2.1 Overview

Neodent's Grand Morse (GM) Implant System offers various design options for implants, screw threads, and apex, as well as two types of surface treatment. Neodent's philosophy is to offer an implant solution suited to each specific indication, including bone density and quantity and surgical technique. All implants can be placed with the Grand Morse Surgical Kit. The procedures are standardized and have sequential steps.



Helix GM	Drive GM	Titamax GM
		
Bone type I, II, III and IV	Bone type III and IV	Bone type I and II
NeoPoros	NeoPoros	NeoPoros
acqua	acqua	acqua

FIGURE 1 – Options for Neodent implants according to their indication.



All Grand Morse implants (Helix GM, Drive GM and Titamax GM) have the same size prosthetic connection, regardless of the implant's diameter (Figure 2), with an internal angle of 16°. The implant's thicker inner walls give it greater mechanical resistance and superior results when compared with various internal connections<sup>5,6</sup> and have been strategically designed for the Grand Morse portfolio.

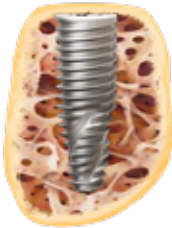
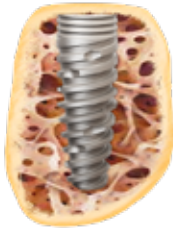
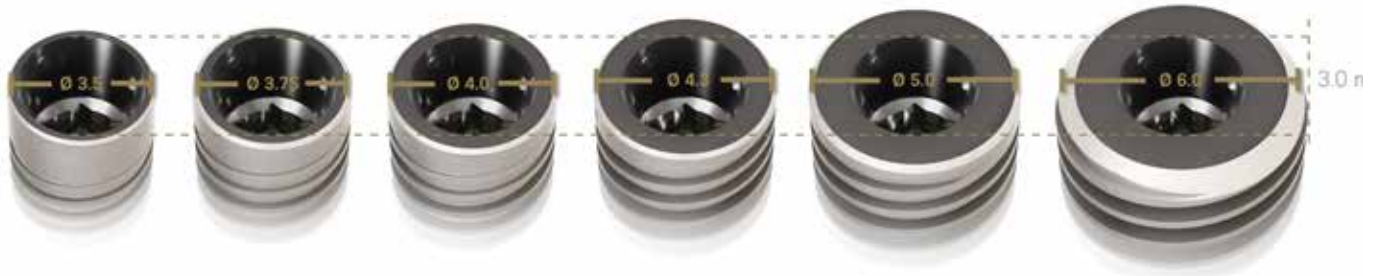

FIGURE 2. The connection of the Neodent Grand Morse implant has the same width, regardless of the implant's diameter.



FIGURE 3. Neodent's Grand Morse implant features a deep connection in its interior, designed to increase the contact area between the implant and the prosthetic abutment.

The Grand Morse conical connection features an internal hexagon index in the lower portion called the GM Exact. GM Exact is used to surgically position the implant and reposition prosthetic abutments when working at implant level.



FIGURE 4. Internal hexagon index, created to surgically guide the implant and mold the implant during the prosthetic phase.

The system has a complete portfolio, adapted to the patient's bone density and quality.

Implant	Diameter (mm)					
	3.5	3.75	4.0	4.3	5.0	6.0
Helix GM	✓	✓	✓	✓	✓	✓
Drive GM	✓			✓	✓	
Titamax GM	✓	✓	✓		✓	

TABLE 1. Available diameters according to implant design.

Implant	Length												
	7	8	9	10	11	11.5	12	13	14	15	16	17	18
Helix GM		✓		✓		✓		✓			✓*		✓*
Drive GM		✓		✓		✓		✓			✓		✓
Titamax GM	✓	✓	✓		✓			✓		✓		✓	

TABLE 2. Available lengths according to implant design.  
 \*Helix Ø 6.0 mm is not available in lengths 16 or 18 mm.

### 3.0 IMPLANT DESIGNS

Neodent's Grand Morse implants are classified according to their macrostructure, screw thread characteristics, apex and microroughness.

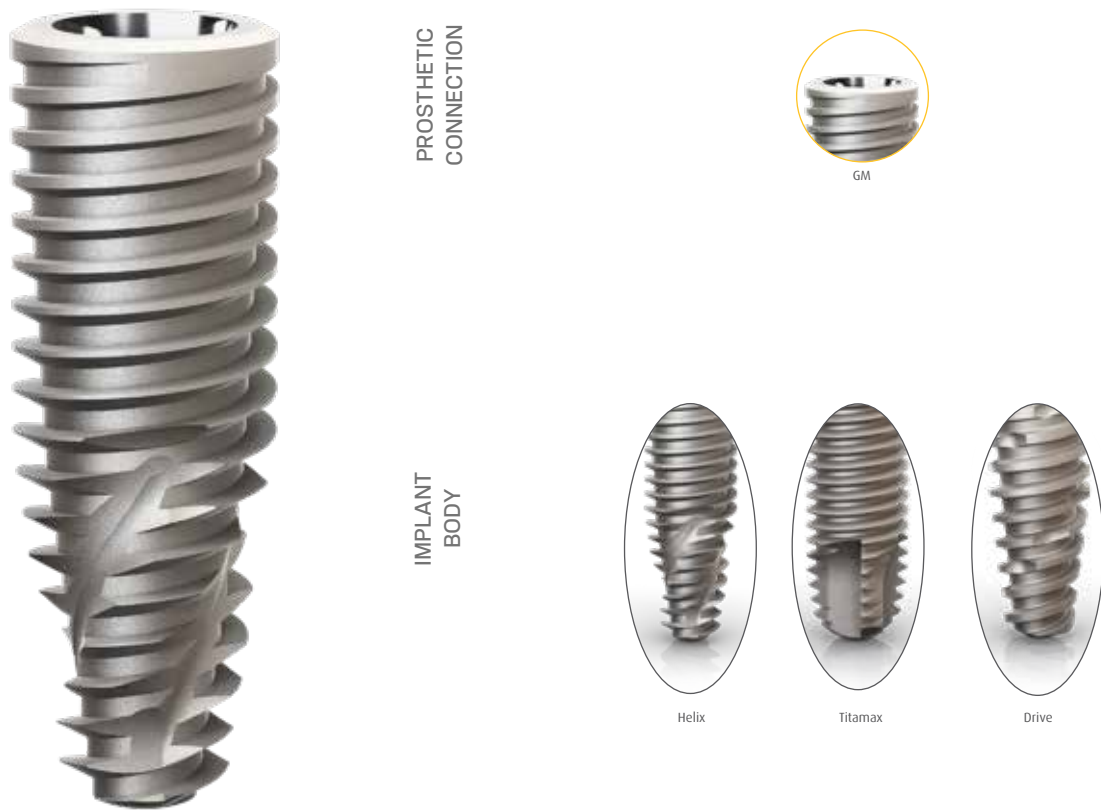

FIGURE 7. General features of Neodent Grand Morse implants.

### 3.1 Surface

Neodent implants are available in two types of surface treatment, as shown below. The decision regarding each surface should be guided by the clinical indication.

#### 3.1.1 NeoPoros

NeoPoros is a process specially created for the surface of Neodent implants. First, roughness is obtained by means of sandblasting, in which the particle size and pressure are adjusted to the implant design. After sandblasting, the implant undergoes an acid etching process under specific conditions. Figure 8 shows this procedure.

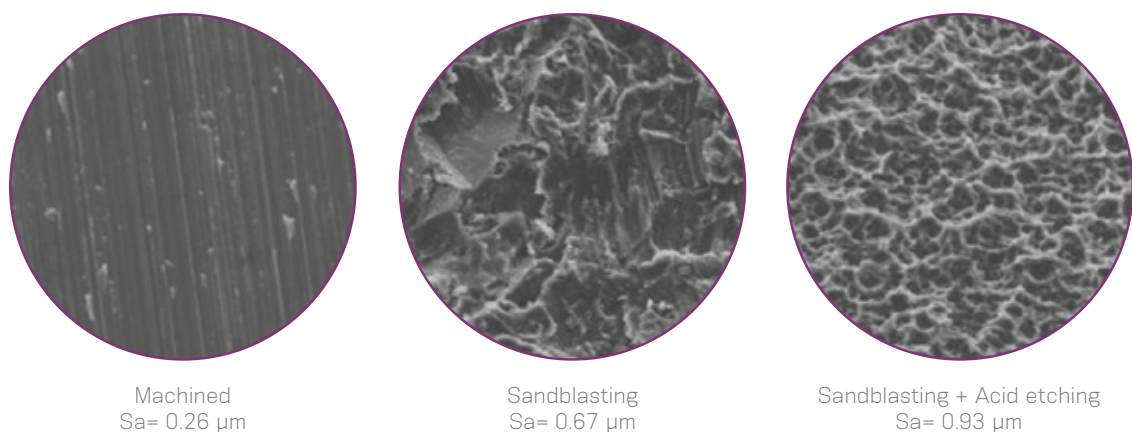

FIGURE 8. Physical manufacturing process for the Neodent surface treatment.

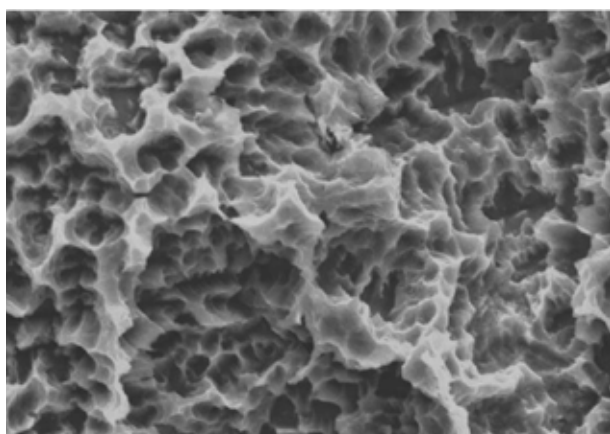

FIGURE 9. Micro ( $0.3 - 1.3 \mu\text{m}$ ) and macro ( $15 - 30 \mu\text{m}$ ) roughness for Acqua and NeoPoros.

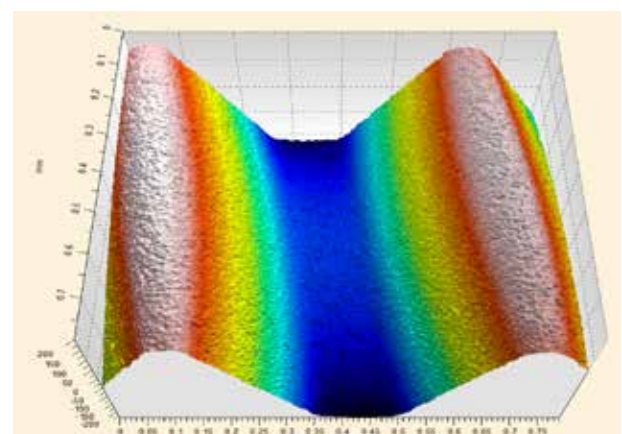

FIGURE 10. Confocal laser scanning microscopy in the screw thread region.<sup>15</sup>

### 3.1.2 Acqua

Acqua is a hydrophilic implant with surface-modified titanium. The physical process of the NeoPoros surface is performed on the Acqua implants; however, the Acqua surface is obtained in a special area of the production center where all the implants are packaged and stocked in liquid thus preventing contact with the atmosphere. This isolation results in wettability (presenting a contact angle  $<5^\circ$ ) and a polarised surface with positive ions<sup>15</sup>.

The hydrophilic surface (Figure 9) presents a smaller contact angle when in contact with organic fluids. This provides them greater accessibility of blood to the implant surface<sup>15</sup>. Implants with the Acqua surface are indicated for implantation in grafted areas, in combination with bone graft procedures, post-extraction placement and sites with low bone density.<sup>17,18</sup>

#### Comparison between Surfaces

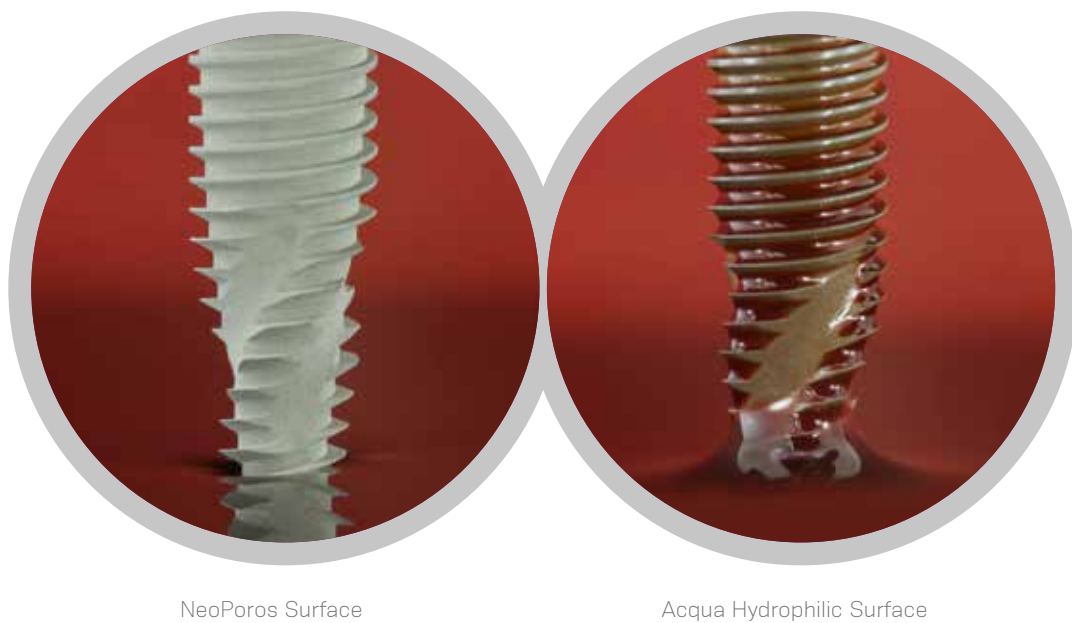

FIGURE 11. Comparison between NeoPoros surface and the Acqua hydrophilic surface.

Note: Chemical composition analysis of the Acqua and NeoPoros surfaces using the XPS method

	NeoPoros (Atom %)	Acqua (Atom %)
Oxygen O	55.9 ± 0.9	59.3 ± 0.2
Titanium Ti	21.1 ± 0.7	22.7 ± 0.3
Nitrogen N	0.4 ± 0.6	0.6 ± 0.4
Carbon C	22.7 ± 2.0	15.3 ± 1.0

## 3.2 Implant Options

### 3.2.1 Helix GM



(1) Available in the Acqua or NeoPoros surface; (2) Fully tapered implant; (3) Compacting trapezoidal screw threads with a thread pitch from 1.2 to 1.5 mm (depending on the implant diameter); (4) Implant with dual screw threads for minimal trauma and faster placement<sup>19</sup>; (5) Conical apex with low-activity chambers and helical chambers designed to optimize secondary stability; (6) Indicated for all bone density types and post-extraction placement; (7) Tapered contour drill is required if used in bone types I and II; (8) Same prosthetic connection for all implant diameters; (9) Final pilot drills highly recommended for bone types I and II; (10) The implant should be positioned 1-2 mm below bone level for best results<sup>19</sup>; (11) Drilling speed: 800-1200 rpm for bone types I and II; (12) Drilling speed: 500-800 rpm for bone types III and IV; (13) Insertion speed: 30 rpm; (14) Maximum insertion torque: 60 N.cm.



### 3.2.2 Drive GM



(1) Available in Acqua or NeoPoros surface; (2) Fully tapered implant; (3) Main screw threads have a square format with a thread pitch of 2.2 mm; (4) Implant with dual thread for minimal trauma and faster placement<sup>19,20</sup>; (5) Counterclockwise cutting chambers distributed throughout the implant body; (6) Lower portion of the screw thread with cutting edge; (7) Round apex; (8) Indicated for bone types III and IV and immediate placement of a postextraction implant; (9) Same prosthetic connection for all implant diameters; (10) The implant should be positioned 1-2 mm below bone level for best results; (11) Drilling speed: 500 - 800 rpm; (12) Insertion speed: 30 rpm; (13) Maximum insertion torque: 60 N.cm.



### 3.2.3 Titamax GM

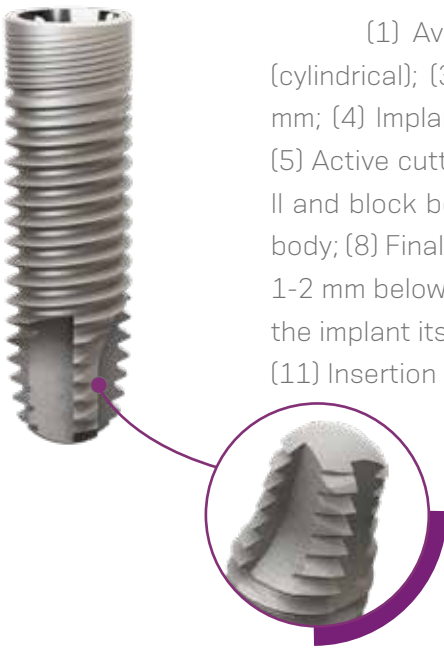

(1) Available in Acqua or NeoPoros surface; (2) Implant with parallel walls (cylindrical); (3) Triangular (or pyramidal) screw threads with a thread pitch of 1.2 mm; (4) Implant with dual screw thread for minimal trauma and faster placement<sup>19</sup>; (5) Active cutting apex with self-tapping chambers; (6) Indicated for bone types I and II and block bone graft areas; (7) The implant's cervical diameter is the same as the body; (8) Final pilot drills are highly recommended as the implant should be positioned 1-2 mm below bone level for best results<sup>19</sup>; (9) The use of tap drill is not necessary as the implant itself cuts the bone during placement; (10) Drilling speed: 800 - 1200 rpm; (11) Insertion speed: 30 rpm; (12) Maximum insertion torque: 60 Ncm.

Implant	Bone Density			
	Bone type I	Bone type II	Bone type III	Bone type IV
Helix GM Acqua	✓*	✓*	✓	✓
Helix GM	✓*	✓*	✓	✓
Drive GM Acqua	-	-	✓	✓
Drive GM	-	-	✓	✓
Titamax GM Acqua	✓	✓	-	-
Titamax GM	✓	✓	-	-

TABLE 3. Summary of the implant indication according to bone type (Lekholm and Zarb, 1985).

\*Conical contour drill is required

### 3.3 Options for Screw Threads and Overview of the Format According to Implant Design

\*There are variations due to the length and diameter options for the implant.

Helix GM:

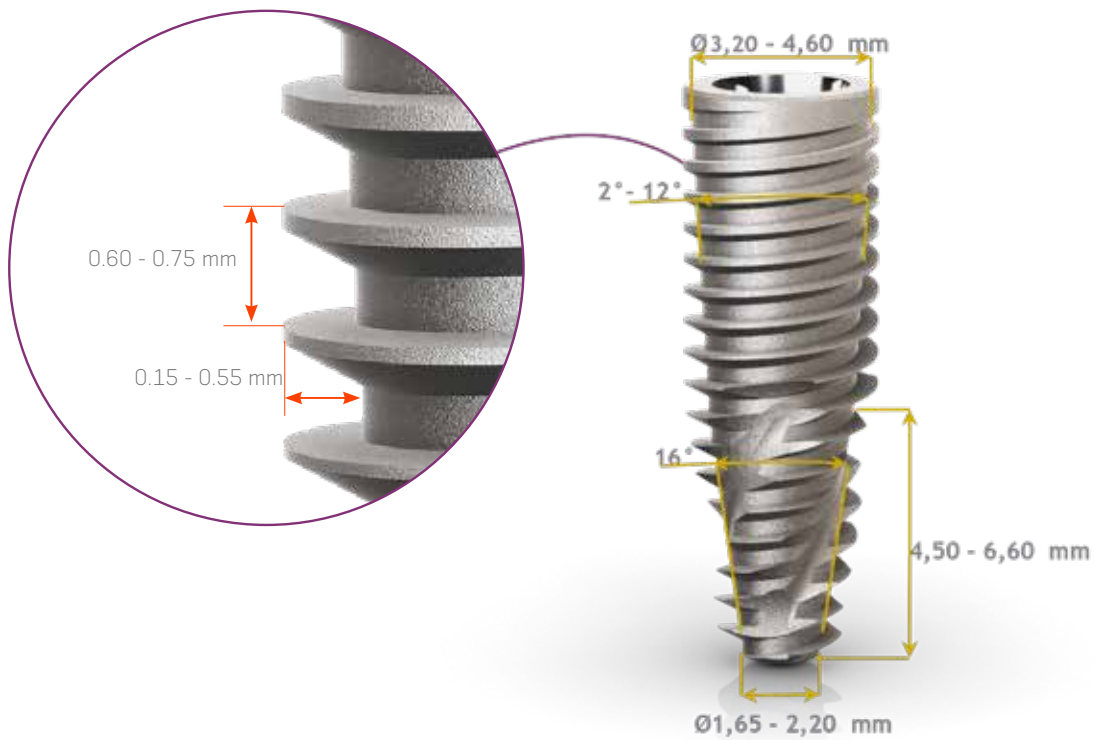



Drive GM:

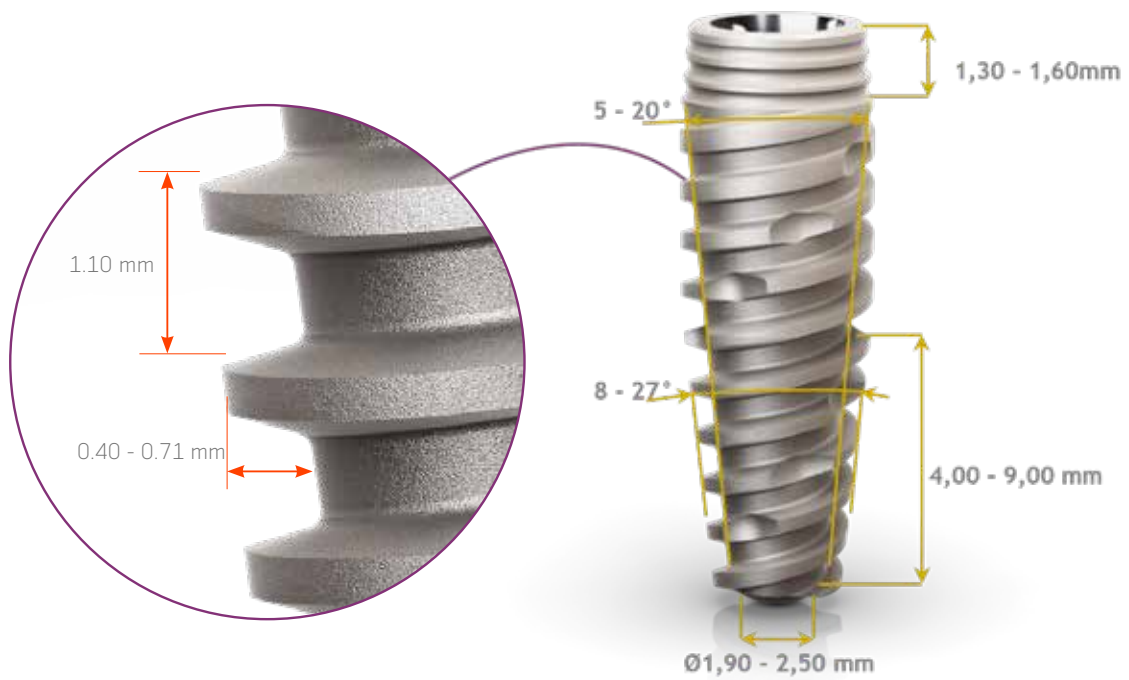

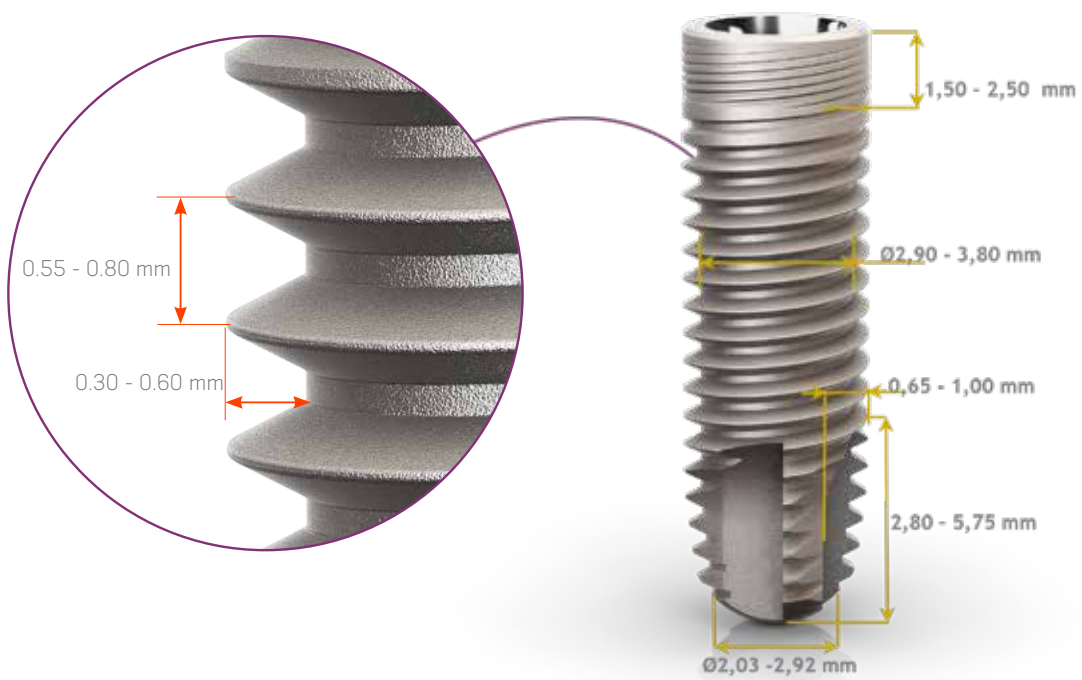

Titamax GM:



## 4.0 INDICATIONS AND CONTRAINDICATIONS

Neodent implants are manufactured with cold-worked grade 4 titanium to increase the product's mechanical resistance. All posts and abutments are made of titanium alloy (TAV). The following table lists the specific measurements for these items.

Implant	General indication	Minimum width of alveolar ridge*	Minimum width of the gap**	Available lengths
 Helix GM	All clinical cases and different bone densities. Placement in bone types III and IV (with the possibility of subinstruments), I and II with use of a tapered contour drill.	5.5 mm	5.5 mm	8/10/11.5/13/16***/18*** mm
 Drive GM	Bone tissue with density III or IV, postextraction placement and in regions grafted with biomaterial.	5.5 mm	5.5 mm	8/10/11.5/13/16/18 mm
 Titamax GM	Bone tissue with density type I or II, placement in block graft area.	5.5 mm	5.5 mm	7/8/9/11/13/15/17 mm

\*Minimum width of the alveolar ridge: minimum vestibulolingual width of the alveolar ridge, rounded to 0.5 mm.

\*\*Minimum width of the gap: minimum mesiodistal width of a single tooth gap restoration, between adjacent teeth, rounded to 0.5 mm.

\*\*\*Helix Ø 6.0 mm is not available in lengths 16 or 18 mm.

For more information on indications and contraindications for each implant, consult the corresponding instructions for use. The instructions can also be found at [ifu.neodent.com.br](http://ifu.neodent.com.br).

## 5.0 PREOPERATIVE PLANNING

### 5.1 Implant positioning and peri-implant tissue

Positioning the implant is the key for obtaining the correct positioning of the prosthetic restoration and is the basis for the surgical plan. Proper communication between the patient, surgeon, prosthetist and dental prosthesis technician is essential for achieving the desired prosthetic results.

To establish the correct plan, with proper spatial positioning and design choice (diameter and length) and the correct number and distribution of implants, the following steps are recommended:

- Perform the wax-up in the patient's study model.
- Define the edentulous gap to be restored.
- Define the type of superstructure.
- Perform computed tomography and radiography.

The wax-up can be used to make the radiographic and/or surgical guide and as the provisional restoration. Physiological occlusion is essential for the short- and long-term success of the implant. Immediate loading procedures should not be performed on patients with occlusion problems.

Notes: Prosthetic abutments should always receive axial loads, and the implant's long axis should be aligned with the cusps of the opposing teeth. The extreme anatomy of the cusps should be avoided, because it can lead to pathological overload.

The diameter, type, position and number of implants should be decided on an individual basis for each patient, taking into consideration the anatomy and prosthetic gap. Poorly positioned or angled teeth should be considered and analyzed. The recommendations in these guidelines should be considered a basic guide for proper biological healing, adequate restorations and for the patient to have efficient hygiene in that area. The design of the restoration has a strong effect on occlusion and hygiene and should be considered.

The final response of soft and hard tissue is highly influenced by the position of the abutment; therefore, three-dimensional positioning of the implant needs to be studied and consists of the following:

- Mesiodistal
- Vestibulolingual
- Cervicoapical

### 5.1.1 Mesiodistal positioning of the implant

The mesiodistally available bone is an important factor in choosing the diameter and number of implants. Mesiodistal gap is the distance between the implant and the teeth or between implants, when multiple implants are necessary. The point of reference is the measurement of the largest mesiodistal width of the implant, usually in the cervical regions. Implants generally require a minimum of adjacent bone surrounding them of 1.5 mm. The distances listed here are rounded to a minimum of 0.5 mm of bone. However, in preclinical studies, Cone Morse implants placed below bone level present bone and soft tissue maintenance up to an interimplant distance of 2.0 mm.<sup>9</sup>

The basic rules are as follows:

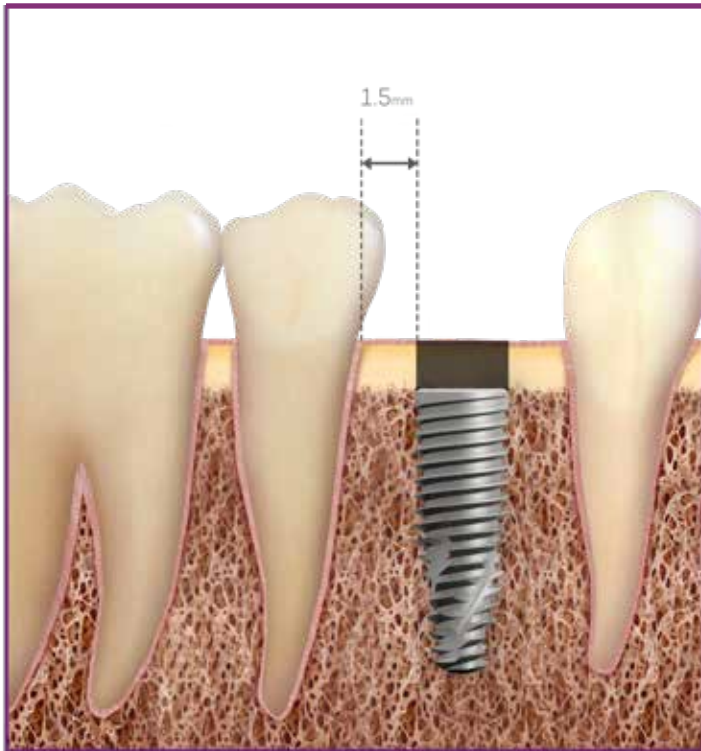

#### Rule 1

Ideally, the distance from the implant to the adjacent teeth should be at least 1.5 mm between the largest portion of the implant and the teeth, in both the mesial and distal aspects.

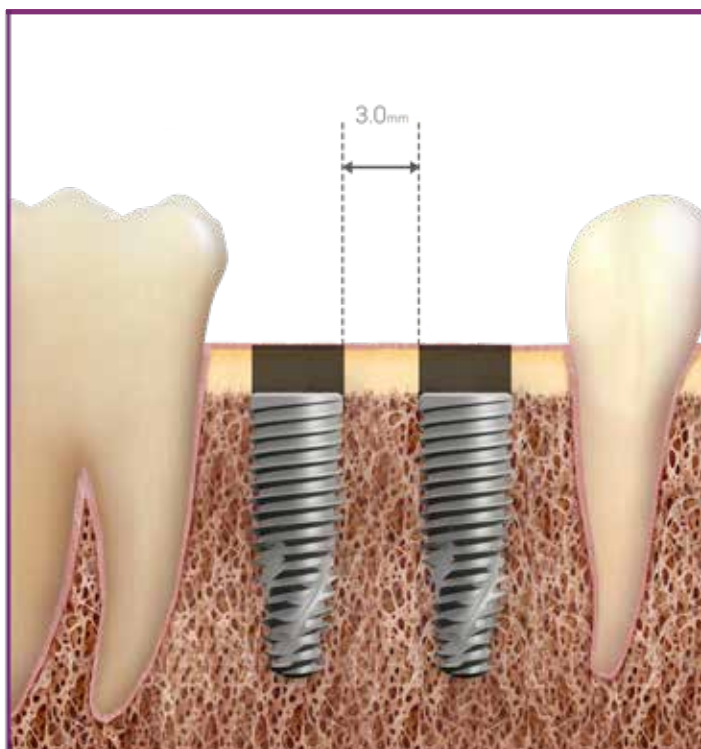

#### Rule 2

Given that the implants require a minimum adjacent bone of 1.5 mm, the minimum distance to other implants is 3.0 mm.

### 5.1.1.1 Examples of single tooth gaps

For single tooth restorations, the implant should be placed in the center of the gap. The following example shows how to follow Rule 1.

For all Neodent Grand Morse implants, the gap size needs to be considered when selecting the implant diameter. To position an implant within the gap according to Rule 1, the following aspects may be used as an approximation:

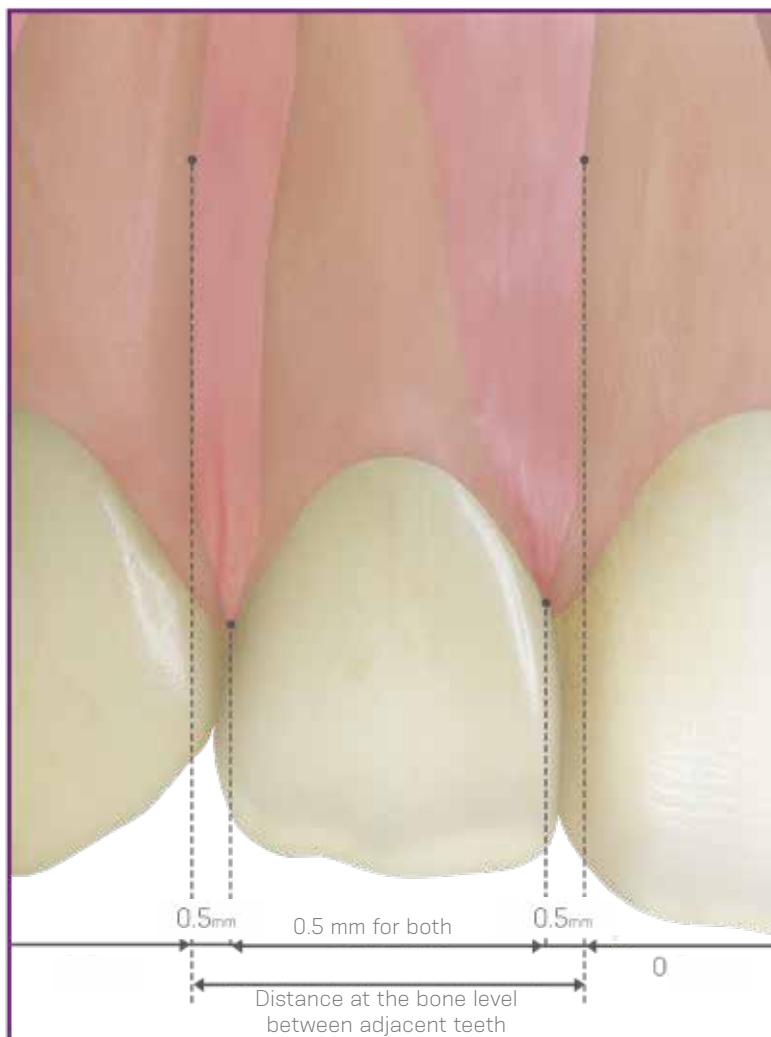
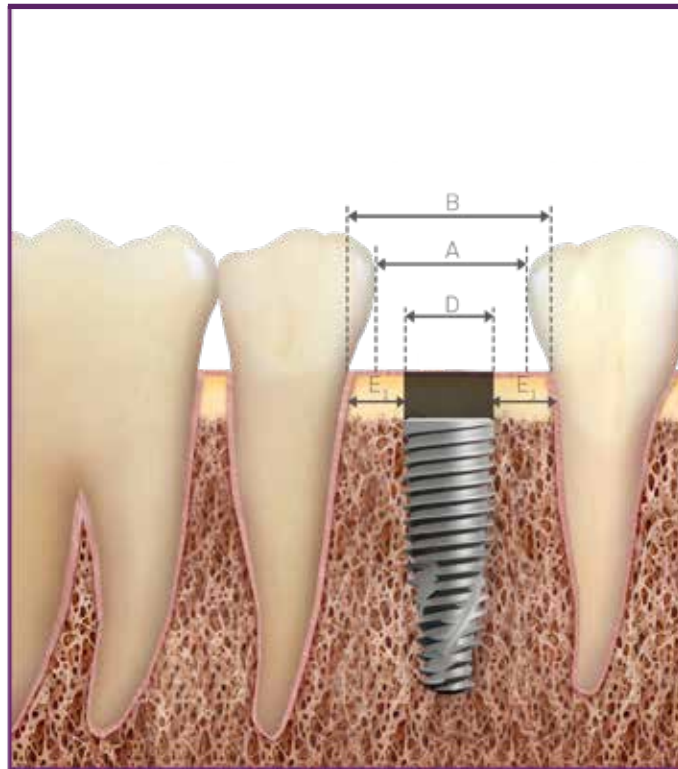

FIGURE 12. The distance between adjacent teeth is approximately 1.0 mm greater at the bone level due to the dental anatomy and the interproximal contact point, when compared with the actual bone width of the gap (2 x 0.5 mm). Therefore, applying Rule 1, the gap must be 2.0 mm wider than the width of the implant.



D - Diameter of the Implant (mm)	A - Width of the Gap (mm)	B - Distance between the adjacent teeth at the bone level (mm)	E <sub>1</sub> - Tooth-implant distance (mm)
3.5	5.5	6.5	1.5
3.75	5.75	6.75	
4.0	6.0	7.0	
4.3	6.3	7.3	
5.0	7.0	8.0	
6.0	8.0	9.0	
Rule	D + 2 mm	D + 3 mm*	

\*Rule 1 applied on both sides of the implant.

### 5.1.1.2 Examples of multiple tooth gaps

The examples below show how Rules 1 and 2 are applied to multiple tooth gaps. The measurements are performed in the bone crest of the tooth adjacent to the center of the implant and between the centers of the implants. The center of the implant should be considered due to the initial drilling during the osteotomy. The minimum distance of 3 mm should be followed between the cervical regions of the implants (Rule 2), which is important for flap closure, to avoid proximity of the abutments and provide adequate space for maintenance, emergency restoration profile and oral hygiene.

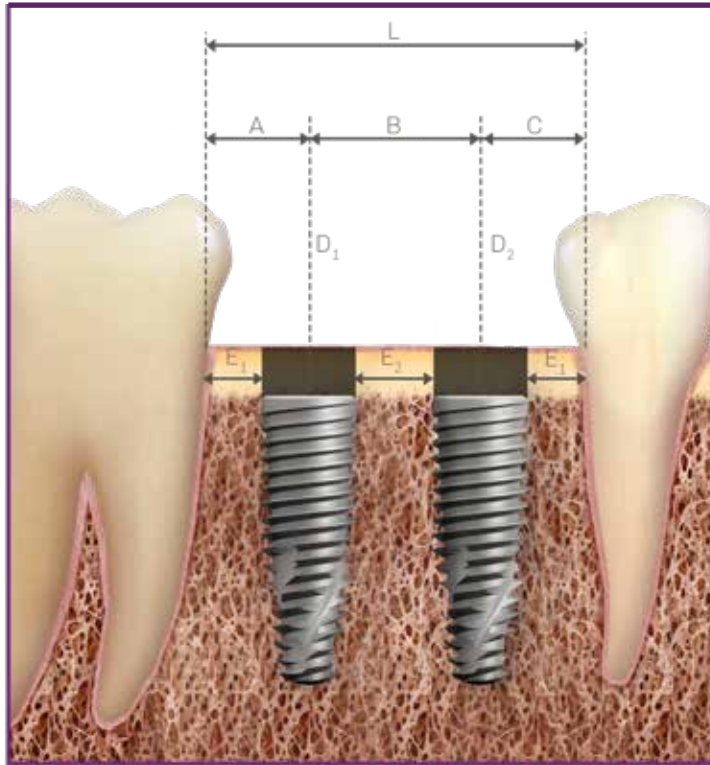

$D_1$ - Diameter of the Implant (mm)	$D_2$ - Diameter of the Implant (mm)	A	B	C	L	$E_1$ - Tooth-implant distance (mm)	$E_2$ - Implant-implant Distance (mm)
3.5	3.5	3.3	6.5	3.3	13	1.5	3.0
3.75	3.75	3.4	6.8	3.4	13.5		
4.0	4.0	3.5	7.0	3.5	14		
4.3	4.3	3.7	7.3	3.7	14.6		
5.0	5.0	4.0	8.0	4.0	16		
6.0	6.0	4.5	9.0	4.5	18		

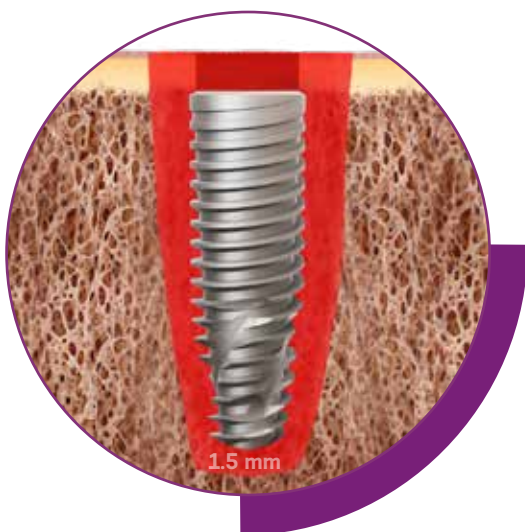

Normally, clinical cases have different gaps and consequently  $D_1/D_2$  can be different. The implants should therefore be adapted for each situation. In search of a simpler rule, the dentist should consider that each implant requires a minimum of 1.5 mm of adjacent bone, regardless of the implant's diameter. Therefore, during planning, we need to remember that regardless of the implant diameter, it is important to have a minimum of 1.5 mm of mesial and distal peri-implantation bone.

### 5.1.2 Vestibulolingual implant position

The buccal and palatal bone plate should be at least 1 mm thick to ensure the stability of the bone tissue and the condition of the soft tissue. The minimum vestibulolingual width for each implant diameter is listed in Table 4. Within this limitation, the vestibulolingual position and the long axis of the implant should be chosen to provide the best possible restorative results. The surgeon also needs to know whether the plan is to place a screw-retained or cement-retained prosthesis.

*Warning: Bone graft techniques are highly advisable in the alveolar ridges in which the buccal bone plate is 1 mm thick or less or when bone is lacking on one of the sides. These procedures should be conducted only by surgeons with advanced experience in bone regeneration with grafts.*

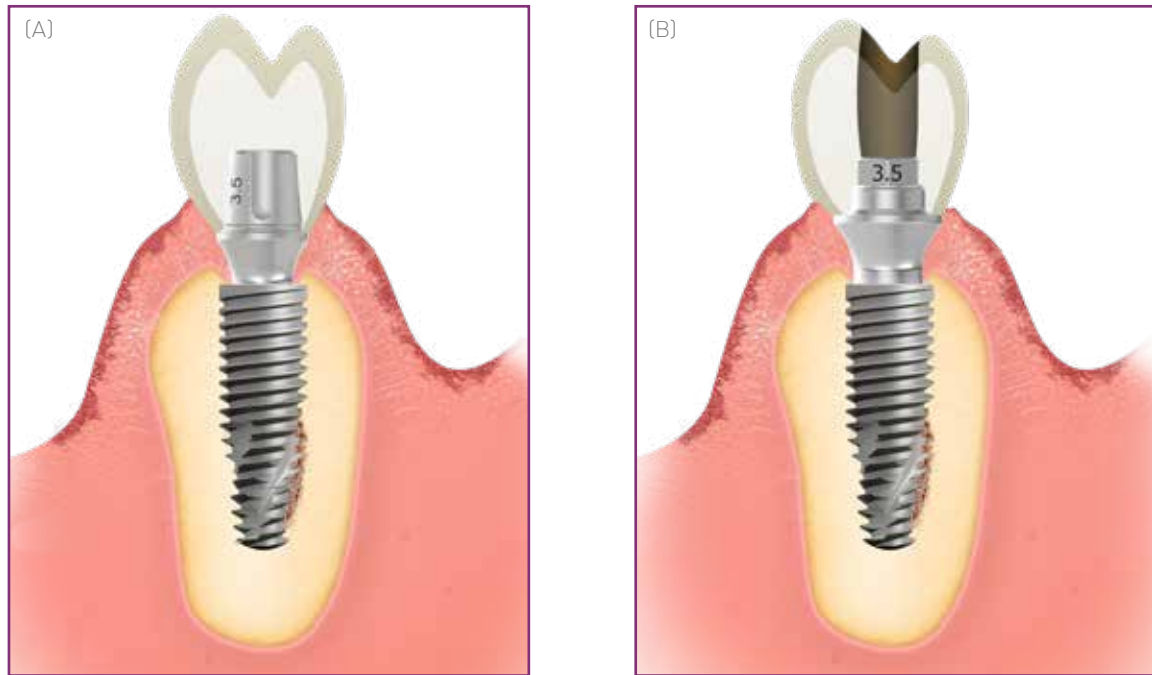
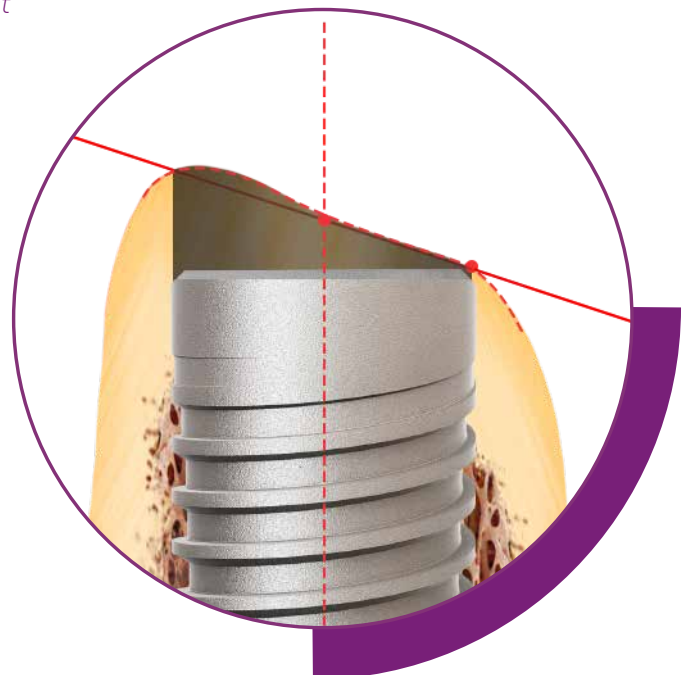

FIGURE 13. Example of implant positioned for cement-retained prosthesis (A) and screw-retained prosthesis (B), where there is access to the retaining screw.

### 5.1.3 Cervicoapical position of the implant

Neodent Grand Morse implants were developed for 2-mm positioning below bone level to optimize the stability of hard and soft tissue and for better esthetic results of the restorations, especially in the anterior regions.<sup>6,7,8,9,10,12</sup>

For situations with uneven ridges, position the implant at the bone level corresponding to the most apical bone wall. Depending on the clinical case, some osteotomy might be required, given that the abutments have limitations in the transmucosal height. The implant should be completely covered with bone or graft with biomaterials to prevent titanium dehiscence.





## 5.2 Planning Aids

### 5.2.1 Space Planning Instrument for assisting in the diagnosis and positioning of implants

When using the 7/9 mm Space Planning Instrument in the patient's mouth or in the study model, an initial analysis of the spatial relationships can be performed, in order to select the implant diameter and the prosthetic reconstruction. The Space Planning Instrument has two ends measuring 7 and 9 mm in diameter, with a mark exactly in the middle of each end (3.5 and 4.5 mm); this acts as a reference for the surgeon to position the implant, respecting the rule of a 1.5-mm minimum adjacent peri-implant bone thickness.

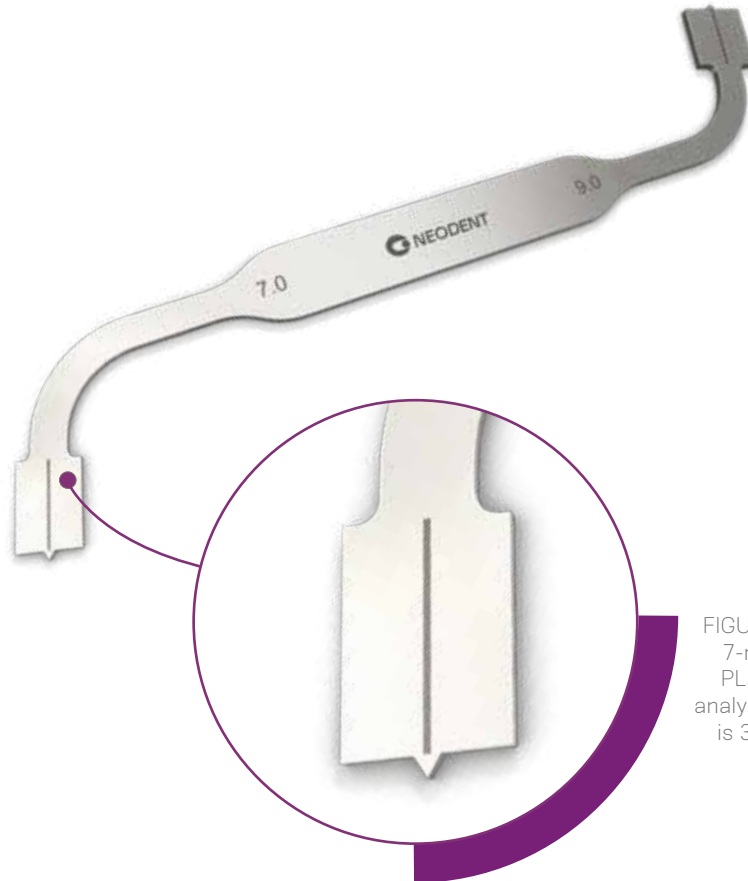

FIGURE 14. Diagnostic Space Planning Instrument for gaps and positioning of implants.

FIGURE 15. Close-up of the 7-mm end of the Space Planning Instrument for analyzing the gaps. The mark is 3.5 mm from the edge.

The 1.5-mm rule is important for placing the implant based on the position of the teeth, implants and anatomical structures, such as nerves. The Space Planning Instrument can help with the positioning of an implant close to a foramen.

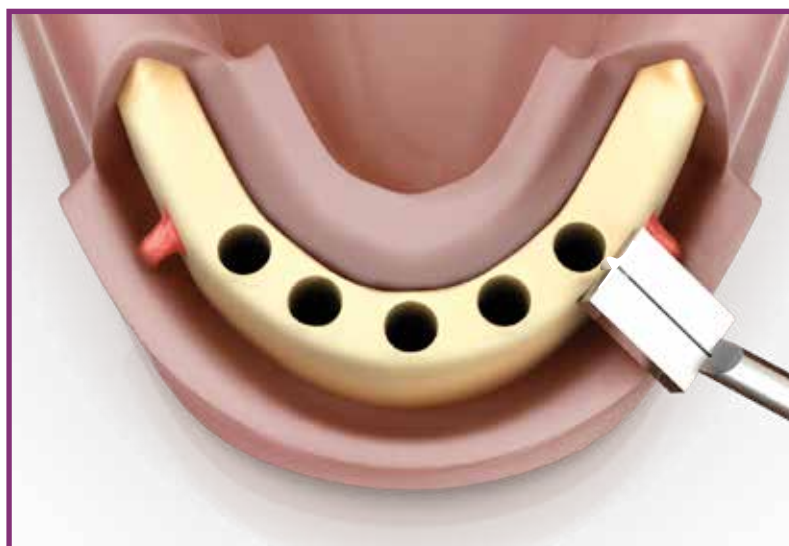

FIGURE 16. Using the Space Planning Instrument for the positioning of the osteotomy for implant placement.

### 5.2.2 Direction indicators for diagnosing the adjacent bone

All Neodent Direction Indicators have different designs for analyzing the amount of bone surrounding the osteotomy. All indicators have the following parts: (1) lower, (2) middle and (3) upper.

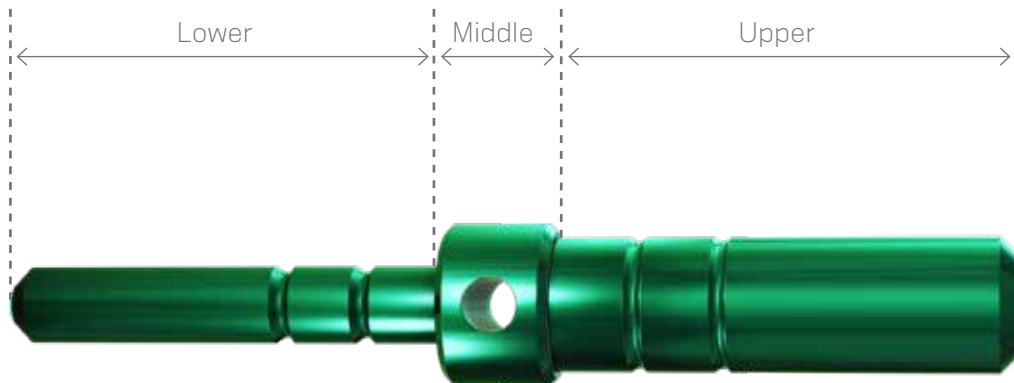

FIGURE 17. The lower (2 mm), middle (diameter of the implant) and upper (diameter of the last drill used in the basic osteotomy) parts of the Direction Indicator.

The lower part of all Direction Indicators is 2.0 mm in diameter, to be adjusted after the initial osteotomy. The middle part of the Direction Indicator has the diameter of the respective implant. All diameters are color coded and are listed in Table 4.

Direction Indicators	Diameter	
	Middle	Upper
	3.5	2.8
	3.75	3.0
	4.0	3.3
	4.3	3.6
	5.0	4.3

TABLE 4. Options for Colored Direction Indicators. The center part of the direction indicator has the same width as the implants, based on the measurements marked on the upper part.

The upper part of each direction indicator has the same diameter as the last drill used before the placement of the implant, according to the Neodent osteotomy protocols. The positioned Direction Indicator allows the surgeon to check the adjacent bone, as illustrated below.

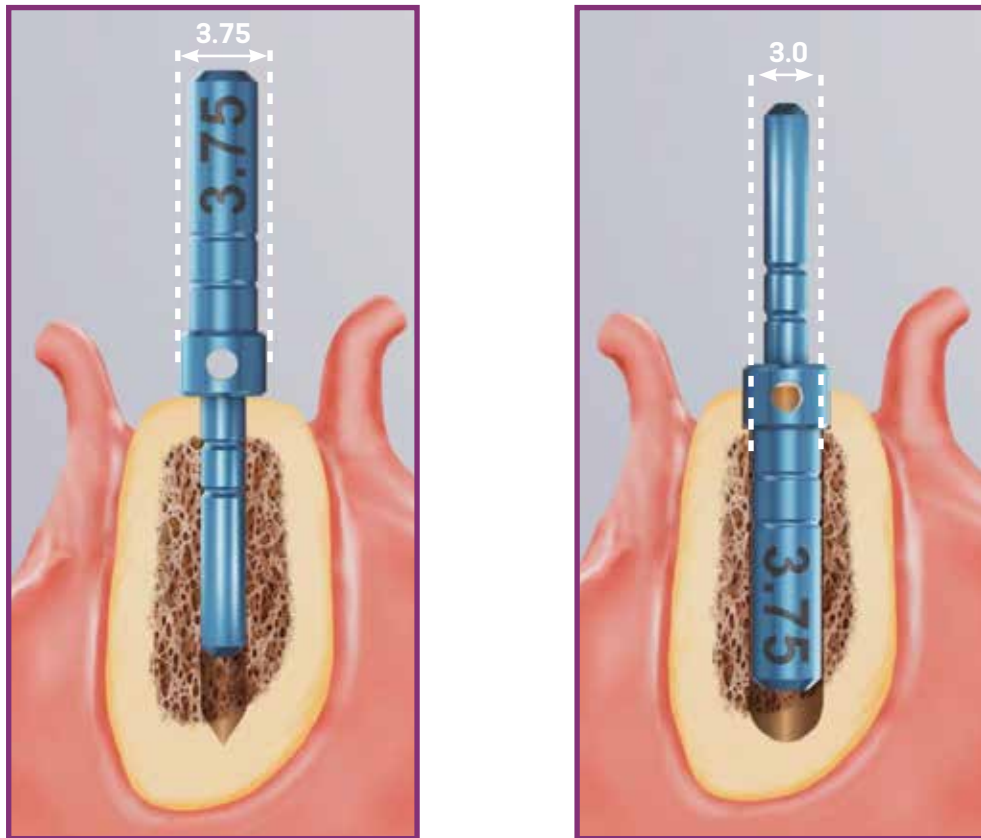

FIGURE 18. Direction Indicator inserted after the initial drilling and fitted inside the osteotomy according to the drill protocol. The indicator helps analyze the remaining adjacent bone when positioned.

There are also Angle Measurement guides that help the surgeon assess the angulation of abutments before the implant placement. These measurement guides are available in two angles ( $17^\circ$  and  $30^\circ$ ) and are inserted in the 2.0-mm osteotomy.



FIGURE 19. Angle measurement guides for selecting abutments.

Notes: The Titanium Tweezers have a ruler at the apex.



FIGURE 20. Titanium tweezers calibrated in millimeters.

### 5.2.3 Surgical drill guide

A customized surgical guide produced by the prosthesis laboratory facilitates the preparation of the implant bed, enabling the precise use of cutting instruments. The basis for the manufacture of this guide should be the desired prosthetic results.

The study models can be drilled with 2.0-mm drills in the position of the implant, and guides for the 2.0-mm diameter pins are fitted on the perforations. Guides manufactured with wax or vacuum-formed are built with the pins positioned in their interior. Once the surgical guide has been made aseptic, it can be used during surgery, and its guides will direct the initial drilling of the surgical procedure.



FIGURE 21. 2.0-mm diameter guides and pins to be fitted in the patient's study model.

## 6.0 SURGICAL PROCEDURES

### 6.1 Implant bed preparation

The diameter, position and number of implants should be selected based on the anatomy and spatial circumstances. The measurements should be performed according to the basic guidelines.

The basic preparation of the implant bed involves preparing the ridge and perforating with a twist drill under irrigation, for which the diameter and design (if cylindrical or conical) of the selected implant will determine the instruments to be used.

The refined implant bed preparation involves the instruments that conform to the emergence profile and the bone. For this, the implant type and bone density determine the instruments to be used.

Steps	Instruments
1. Basic implant bed preparation	
Preparation of the ridge	Initial Drill
Twist drilling	2.0-mm twist drill; Direction Indicator; Depth Gauge with millimeter markings
2. Refined implant bed preparation	
Conical or cylindrical drills and bone profile drills	Drill format is defined according to the implant design, and the sequence and diameter defined by its width
Tapered Contour Drill	For Helix GM in bone types I and II

Note: The Titamax GM, Helix GM and Drive GM implants can be placed using the same surgical kit, given that Helix GM and Drive GM have conical drills for implant bed preparation and that Titamax GM also features specific drills.

#### 6.1.1. Basic implant bed preparation

After opening the flap and exposing the bone tissue, the preparation of the alveolar ridge begins. Once the implant's position has been established and with the aid of surgical guides, the cervical cortical layer is drilled with the Initial Drill (step 1), and the spatial positioning of the implant is checked visually. The indicated number of rotations per minute (rpm) for drilling is based essentially on bone density, whereby 800-1200 rpm will be applied in bone types I and II, and 500-800 rpm in bone types III and IV. Subsequently, the 2.0-mm twist drill is used to establish the desired height for the selected implant, always keeping in mind that the placement of the Grand Morse implant is 1-2 mm below bone level. Consequently, a subsequent drill is employed to prepare the osteotomy, following the sequence based on the implant type and diameter, as chosen in the preoperative plan. All drills are fitted to the contra-angle handpiece according to ISO 1797-1 – Dentistry – Shanks for rotary instruments.



### Step 1 – Preparing the site of the implant and initial drilling with the Initial Drill

Carefully reduce and regularize the bone surface before marking the position of the implant with the initial needle drill. Insert the needle drill to approximately 5-7 mm with a drill speed consistent with the bone density.

Note: Bone reduction/preparation should be considered in the preoperative plan, because it affects the choice of implant diameter and length.



### Step 2 – Checking the long axis of the implant

After using the initial drill, check the long axis of the implant using the direction indicator. The implant diameters and measurements of adjacent bone can be checked as described in 3.2.2.



### Step 3 – Twist Drill 2.0

Use the 2.0-mm twist drill to reach the planned drilling length. Use of the depth gauge is recommended for controlling the depth.

Note: 1 – Periapical radiography is recommended at this point to check for available vertical bone or to verify the long axis of the drilling in relation to the adjacent roots, for example. The Direction Indicator should be completely inserted into the instrumented area, allowing for visualization of the entry of the drilling in relation to the anatomical structures.

2 – The 2.0-mm Neodent twist drill has an active apex that can be used as an initial drill. For flat bony ridges, this drill can replace the initial drill.



### 6.1.1.1 Implant bed preparation for Helix GM conical implants



	Initial 103.170	Ø 2.0 103.425	Ø 3.5 103.399	Ø 3.5+ 103.419	Ø 2.8/3.5 103.414	Ø 3.75 103.402	Ø 3.75+ 103.420	Ø 3.0/3.75 103.415	Ø 4.0 103.405	Ø 4.0+ 103.421	Ø 3.3/4.0 103.416	Ø 4.3 103.408	Ø 4.3+ 103.422	Ø 3.6/4.3 103.417	Ø 5.0 103.411	Ø 5.0+ 103.423	Ø 4.3/5.0 103.418	Ø 6.0 103.427
Ø 3.5	Optional	✓		✓	✓													
Ø 3.75	Optional	✓	✓				✓	✓										
Ø 4.0	Optional	✓	✓			✓				✓	✓							
Ø 4.3	Optional	✓	✓			✓			✓				✓	✓				
Ø 5.0	Optional	✓	✓			✓			Optional				✓				✓	✓

Bone types I and II 



























Ø 3.5	Optional	✓	Optional															
Ø 3.75	Optional	✓	✓			Optional												
Ø 4.0	Optional	✓	✓			✓			Optional									
Ø 4.3	Optional	✓	✓			✓						Optional						
Ø 5.0	Optional	✓	✓									✓			Optional			
Ø 6.0	Optional	✓	✓									✓			✓			Optional

For bone types III and IV 



Note: Periapical radiography is recommended after the use of conical drills to check for available bone or to verify the long axis of the drilling in relation to the adjacent roots. A radiographic positioner should be inserted in the instrumented area.



























Helix GM - For bone types I and II

Instruments for basic bone implant preparation					Diameters (mm)				
Step	Code	Product	Max. RPM	Image	Ø 3.5	Ø 3.75	Ø 4.0	Ø 4.3	Ø 5.0
1 – Prepare the implant bed and initial drilling	103.170	Initial Drill	1200		Optional	Optional	Optional	Optional	Optional
2 – Check the long axis of the implant	128.019	Direction indicator 2.8/3.5	-						
3-Taperd Drill 2.0*	103.425	Tapered Drill 2.0	1200						
4-Tapered 3.5	103.419	Tapered Contour Drill 3.5	1200			-	-	-	-
	103.399	Tapered Drill 3.5	1200						
	128.019	Direction indicator 2.8/3.5	-						
	129.009	Tapered X-Ray Positioner 3.5	-					Optional	Optional
5-Pilot Drill 2.8/3.5	103.414	Pilot Drill 2.8/3.5	1200						
6-Tapered 3.75	103.420	Tapered Contour Drill 3.75	1200						
	103.402	Tapered Drill 3.75	1200						
	128.020	Direction indicator 3.0/3.75	-						
7-Pilot Drill 3.0/3.75	103.415	Pilot Drill 3.0/3.75	1200						
8-Tapered 4.0	103.421	Tapered Contour Drill 4.0	1200						
	103.405	Tapered Drill 4.0	1200						Optional
	128.021	Direction indicator 3.3/4.0	-						Optional
9-Pilot Drill 3.3/4.0	103.416	Pilot Drill 3.3/4.0	1200						
10-Tapered 4.3	103.422	Tapered Contour Drill 4.3	1200						
	103.408	Tapered Drill 4.3	1200						
	128.022	Direction indicator 3.6/4.3	-						
	129.013	Tapered X-Ray Positioner 4.3	-						Optional
11-Pilot Drill 3.6/4.3	103.417	Pilot Drill 3.6/4.3	1200						
12-Tapered 5.0	103.423	Tapered Contour Drill 5.0	1200						
	103.411	Tapered Drill 5.0	1200						
	128.023	Direction indicator 4.3/5.0	-						
	129.014	Tapered X-Ray Positioner 5.0	-						
13-Pilot Drill 4.3/5.0	103.418	Pilot Drill 4.3/5.0	1200						

\*The sequence can be started directly with the 2.0 drill if the bone bed is flat.



Helix GM - For bone types III and IV

Instruments for basic bone implant preparation					Diameters (mm)					
Step	Code	Product	Max. RPM	Image	Ø 3.5	Ø 3.75	Ø 4.0	Ø 4.3	Ø 5.0	Ø 6.0
1-Prepare the implant bed and initial drilling*	103.170	Initial Drill	800		Optional	Optional	Optional	Optional	Optional	Optional
2-Check the long axis of the implant	128.019	Direction indicator 2.8/3.5	-							
3-Tapered Drill 2.0*	103.425	Tapered Drill 2.0	800							
4-Tapered 3.5	103.419	Tapered Contour Drill 3.5	800		-	-	-	-	-	-
	103.399	Tapered Drill 3.5	800		Optional					
	128.019	Direction indicator 2.8/3.5	-							
	129.009	Tapered X-Ray Positioner 3.5	-					Optional	Optional	Optional
5-Pilot Drill 2.8/3.5	103.414	Pilot Drill 2.8/3.5	800							
6-Tapered 3.75	103.420	Tapered Contour Drill 3.75	800							
	103.402	Tapered Drill 3.75	800		Optional					
	128.020	Direction indicator 3.0/3.75	-							
7-Pilot Drill 3.0/3.75	103.415	Pilot Drill 3.0/3.75	800							
8-Tapered 4.0	103.421	Tapered Contour Drill 4.0	800							
	103.405	Tapered Drill 4.0	800			Optional				
	128.021	Direction indicator 3.3/4.0	-							
9-Pilot Drill 3.3/4.0	103.416	Pilot Drill 3.3/4.0	800							
10-Tapered 4.3	103.422	Tapered Contour Drill 4.3	800							
	103.408	Tapered Drill 4.3	800							
	128.022	Direction indicator 3.6/4.3	-							
	129.013	Tapered X-Ray Positioner 4.3	-					Optional		
11-Pilot Drill 3.6/4.3	108.417	Drill Pilot 3.6/4.3	800							
12-Tapered 5.0	103.423	Tapered Contour Drill 5.0	800							
	103.411	Tapered Drill 5.0	800						Optional	
	128.023	Direction indicator 4.3/5.0	-							
	129.014	Tapered X-Ray Positioner 5.0	-							
13-Pilot Drill 4.3/5.0	103.418	Pilot Drill 4.3/5.0	800							
14-Tapered 6.0	103.427	Tapered Drill 6.0	800						Optional	

\*The sequence can be started directly with the 2.0 drill if the bone bed is flat.

### 6.1.1.2 Implant bed preparation for Drive GM conical implants

	Initial	Ø 2.0	Ø 3.5	Ø 2.8/3.5	Ø 4.3	Ø 3.6/4.3	Ø 5.0	Ø 4.3/5.0
	103.170	103.425	103.399	103.414	103.408	103.417	103.411	103.418
Ø 3.5 mm	✓	✓	✓	Optional				
Ø 4.3 mm	✓	✓	✓		✓	Optional		
Ø 5.0 mm	✓	✓	✓		✓		✓	Optional

For bone types III and IV

### Drive GM

Instruments for basic bone implant preparation					Diameters (mm)		
Step	Code	Product	Max. RPM	Image	Ø 3.5	Ø 4.3	Ø 5.0
1-Prepare the implant bed and initial drilling*	103.170	Initial Drill	800		○	○	○
2-Check the long axis of the implant	128.019	Direction indicator 2.8/3.5	-		↓	↓	↓
3-Tapered Drill 2.0*	103.425	Tapered Drill 2.0	800		↓	↓	↓
4-Tapered Drill 3.5	103.399	Tapered Drill 3.5	800		↓	↓	↓
	128.019	Direction indicator 2.8/3.5	-		↓	↓	↓
	129.009	Tapered X-Ray Positioner 3.5	-		↓	↓	↓
5-Pilot Drill 2.8/3.5	103.414	Pilot Drill 2.8/3.5	800		Optional	-	-
6-Tapered Drill 4.3	103.408	Tapered Drill 4.3	800		↓	↓	↓
	128.022	Direction indicator 3.6/4.3	-		↓	↓	↓
	129.013	Tapered X-Ray Positioner 4.3	-		↓	↓	↓
7-Pilot Drill 3.6/4.3	103.417	Pilot Drill 3.6/4.3	800		Optional	-	-
8-Tapered Drill 5.0	103.411	Tapered Drill 5.0	800		↓	↓	↓
	128.023	Direction indicator 4.3/5.0	-		↓	↓	↓
	129.014	Tapered X-Ray Positioner 5.0	-		↓	↓	↓
9-Pilot Drill 4.3/5.0	103.418	Pilot Drill 4.3/5.0	800		Optional	-	Optional

\*The sequence can be started directly with the 2.0 drill if the bone bed is flat.

















### 6.1.1.3 Implant bed preparation for Titamax GM cylindrical implants



	Initial	Ø 2.0	Ø 2/3	Ø 2.8	Ø 3.0	Ø 2.8/3.5	Ø 3.3	Ø 3.0/3.75	Ø 3.3/4.0	Ø 3.8	Ø 4.3	Ø 4.3/5.0
	103.170	103.162	103.213	103.163	103.164	103.414	103.166	103.415	103.416	103.167	103.168	103.418
Ø 3.5 mm	✓	✓		✓		✓						
Ø 3.75 mm	✓	✓	✓		✓			✓				
Ø 4.0 mm	✓	✓	✓		✓		✓		✓			
Ø 5.0 mm	✓	✓	✓		✓			✓		✓	✓	✓

For bone types I and II 

### Titamax GM

Instruments for basic bone implant preparation					Diameters (mm)			
Step	Code	Product	Max. RPM	Image	Ø 3.5	Ø 3.75	Ø 4.0	Ø 5.0
1-Prepare the implant bed and initial drilling*	103.170	Initial Drill	1200		○	○	○	○
2-Check the long axis of the implant	128.019	Direction indicator 2.8/3.5	-		↓			
3-Twist Drill 2.0*	103.162	Twist Drill 2.0	1200		↓			
4-Twist Drill 2.8	103.163	Twist Drill 2.8	1200			-	-	-
	128.019	Direction indicator 2.8/3.5	-		↓			
	103.414	Pilot Drill 3.5	-					
5-Pilot Drill 2/3	103.213	Pilot Drill 2/3	1200					
6-Twist Drill 3.0	103.164	Twist Drill 3.0	1200					
	128.020	Direction indicator 3.0/3.75	-		↓			
	103.415	Pilot Drill 3.0/3.75	1200					
7-Twist Drill 3.3	103.106	Twist Drill 3.3	1200					
	128.021	Direction indicator 3.3/4.0	-					
8-Pilot Drill 3.3/4.0	103.416	Pilot Drill 3.3/4.0	300					
9-Twist Drill 3.8	103.167	Twist Drill 3.8	1200					
10-Twist Drill 4.3	103.168	Twist Drill 4.3	1200					
	128.023	Direction indicator 4.3/5.0	-					
11-Pilot Drill 4.3/5.0	103.418	Pilot Drill 4.3/5.0	300					↓

\*The sequence can be started directly with the 2.0 drill if the bone bed is flat.

NOTE: Length comparison between drills and implants.



- 1: All twist drills have similar marks related to each length of GM Titamax implants, regardless of diameter.
- 2: The implant in the image is 13 mm long.



- 1: All conical drills have similar marks related to each implant length, regardless of diameter.
- 2: All drills are available in the short version, and some are available in the long version.
- 3: Due to their function, tapered drills are at most 0.5 mm longer than the implant. This additional length should be considered before the surgical procedure.
- 4: The implants in the image are 13 mm long.

### 6.1.2 Details on special implant bed preparation

The special implant bed preparation considers the use (1) of the pilot drill and (2) the tapered contour drill when necessary. The instruments depend on the implant type and diameter and bone type. Osteotomies in bone types I and II need final pilot drills for the final positioning of the implant. Tapered contour drills are required only for the use of the GM Helix implant in regions of high bone density.

#### 6.1.2.1 Tapered Contour Drill

Tapered Contour Drills are especially indicated as supplementary instruments for osteotomy when implanting GM Helix implants in bone types I and II. There are different tapered contour drills selected according to the implant diameter. The drills are used only on bone types I and II, connected to the contra-angle handpiece, with a rotation speed of approximately 800-1200 rpm. This step is intended to keep the insertion torque at a desirable level in bone types I and II.



Note: The Tapered Contour Drills have the "+" symbol to indicate that they are supplementary instruments.

### 6.1.2.2 Pilot Drill

Pilot drills are employed to prepare the implant bed to widen the diameter of one twist drill to another, in the basic instrumentation procedure. For the special bone preparation, pilot drills help position the platform of the Grand Morse implants according to the bone bed, if there is a denser cortical bone bed of 1, 2 or 3 mm below bone level. Pilot drills are generally used in this manner in bone types I and II and are indicated as optional in bone types III and IV. For GM Drive implants, the use of this drill is optional. The maximum rotation speed used for these drills is 800 rpm for bone types III and IV and 1200 rpm for bone types I and II.

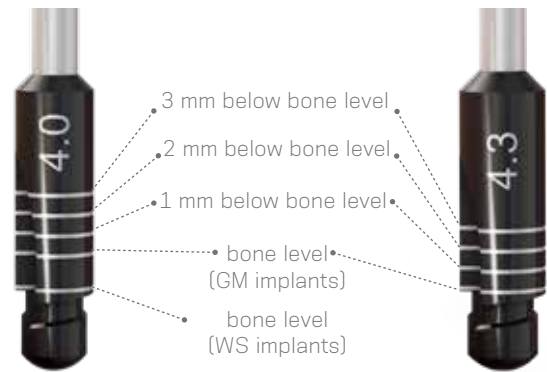

FIGURE 22: Pilot drill for the refined implant bed preparation for the implant. The drill helps in the cervical positioning of the implant in areas of greater bone density: if at bone level, 1, 2 or 3 mm below bone level. Pilot drills are optional for GM Drive implants.

### 6.1.2.3 Example of special implant bed preparation

The following is an example of the special preparation of the implant bed for a GM Helix implant (Ø 4.3 mm and 13 mm long) in bone type I or II, making the use of contour and pilot drills necessary. The steps described follow the basic preparation of the implant bed (6.1.1.1).













#### Step 1 - Drilling in dense bone

Use the tapered contour drill across the entire length of the planned implant.

#### Step 2- GM Pilot Drill

Perform the osteotomy with the conical drills. Depending on the level of the final positioning of the implant (bone level, 1 or 2 mm below bone level), use the pilot drill for the final positioning of the implant.

The following table summarizes the use of Pilot and Tapered Contour drills for the special preparation of the implant bed.

Instruments for the special bone implant preparation				Implants		
Code	Product	Max. RPM	Image	Titamax GM	Helix GM	Drive GM
103.414	Pilot Drill 2.8/3.5	1200		Ø 3.5	Ø 3.5**	Ø 3.5*
103.415	Pilot Drill 3.0/3.75	1200		Ø 3.75	Ø 3.75**	-
103.416	Pilot Drill 3.3/4.0	1200		Ø 4.0	Ø 4.0**	-
103.417	Pilot Drill 3.6/4.3	1200		Ø 4.3	Ø 4.3**	Ø 4.3*
103.418	Pilot Drill 4.3/5.0	1200		Ø 5.0	Ø 5.0**	Ø 5.0*
103.419	Tapered Contour Drill 3.5	1200		-	Ø 3.5**	-
103.420	Tapered Contour Drill 3.75	1200		-	Ø 3.75**	-
103.421	Tapered Contour Drill 4.0	1200		-	Ø 4.0**	-
103.422	Tapered Contour Drill 4.3	1200		-	Ø 4.3**	-
103.423	Tapered Contour Drill 5.0	1200		-	Ø 5.0**	-

\*Optional.

\*\* Only for bone types I and II.

Note: Surgical drills have a life cycle of up to 30 perforations for bone quality I, II, III and IV, provided the conditions of use recommended by Neodent are respected. Regardless of the number of times the instruments are used, the practitioner should always assess the condition of the instruments after each use.

Note: Bone quality classification according to Lekholm and Zarb (1985).

#### 6.1.2.4 Options for drills

Neodent drills are available in short (31 mm), standard (35 mm) or long (43 mm) formats to cater for limitations in mouth opening or for use between two teeth. In case of necessity a Drill Extension can also be used.



FIGURE 23. Length options for Grand Morse drills (31 mm, 35 mm and 43 mm).



FIGURE 24. Drills fit inside the Neodent Drill Extension.

## 6.2 Neodent Implant Packaging

Neodent packaging has been specially updated for easy handling and safe surgical procedures, providing practicality from implant stocking to the capture and transport and implant bed. The implant's features, such as type, diameter and length, are readily identifiable on the outside of the packaging.

Three self-adhesive labels are provided for recording in the patient's medical records and for reporting to the prosthesis team. They also allows traceability for all articles.





## Instructions for opening the implant packaging

### Step 1

Open the blister and place the vial on a sterile surface.

### Step 2

After breaking the blister's sterile seal, hold the primary packaging (vial) in one hand and open the lid.

Note: For Acqua implants, hold the bottle in the vertical position to avoid spilling the liquid.



### Step 3

Remove the holder containing the implant from the vial along with the lid.

Note: For Acqua implants, hold the bottle in position.



### Step 4

Keep the support pressed and remove the lid.



### Step 5

With the support pressed, capture the implant with the contra-angle driver, moving the support until the perfect fit is found between the driver and the implant. Check that the driver is completely fitted to the implant.



### Step 6

Carry the implant to the implant bed.



## 6.3 Placing of the Grand Morse Implant

Neodent Grand Morse implants were developed to begin placement with the contra-angle handpiece or manually, and completed with the Torque-indicating Wrench. The maximum recommended rotation speed for the surgical motors is 30 rpm, with a torque of 35 N.cm.

### 6.3.1 Placing of the implant with the contra-angle handpiece

The following instructions show the steps for handling the Neodent Grand Morse implant for placement with the contra-angle handpiece.

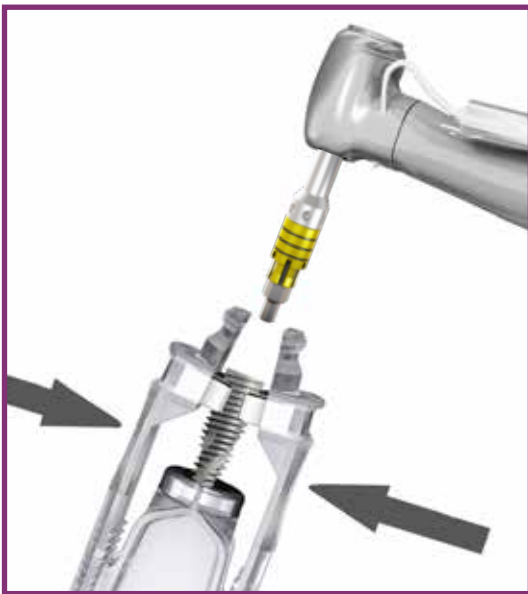

#### Step 1 - Adapt contra-angle implant driver

Hold the implant through the blister, and attach the contra-angle implant driver to the Grand Morse implant. All drivers for the contra-angle handpiece have metal tweezers in the active apex to keep the implant stable during transport. The torque wrench drivers do not have tweezers to keep the implants in position for transport.

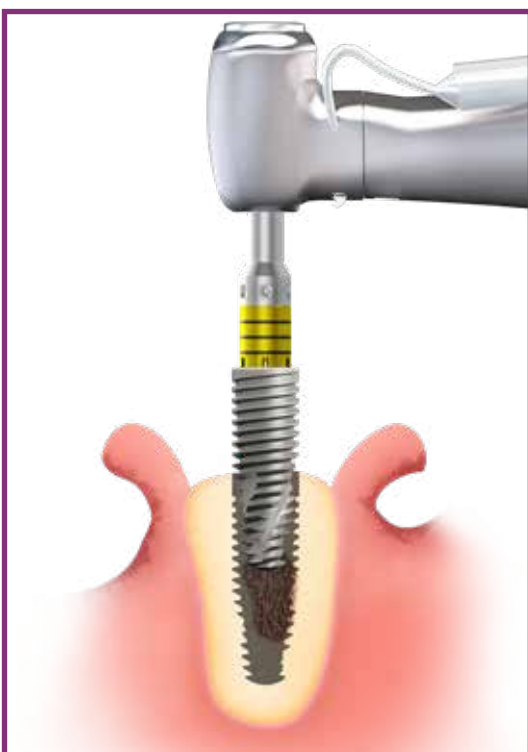

#### Step 2 - Place the implant with the contra-angle handpiece in the implant bed

Place the implant to its final position with a maximum torque of 35 N.cm and speed of 30 rpm, clockwise.

*Warning: Corrections in the vertical position by means of reverse rotations during surgery can lead to reduced primary or mechanical stability.*

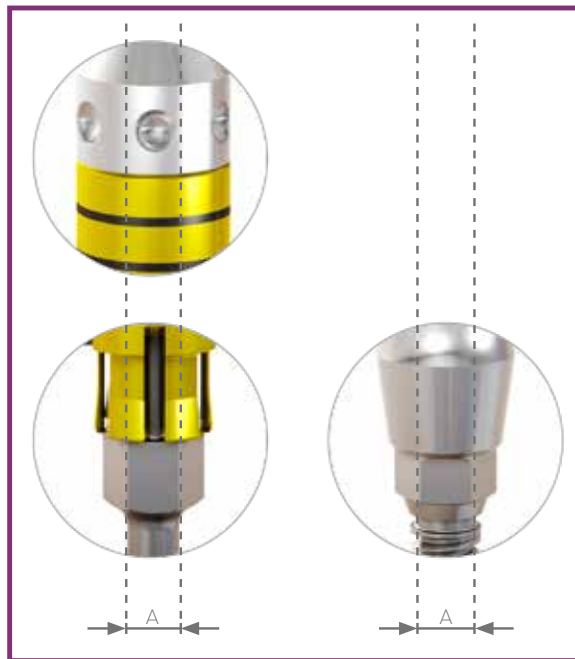

### Step 3 – Final positioning of the implant

Neodent Grand Morse implants have an internal hexagon index known as Exact. Ensure that the final position of the implant shows one of the prosthetic orientation marks facing the oral cavity.

The implant drivers have six marks that line up with the six sides of the GM Exact. Position one of the driver marks towards the oral cavity to ensure the optimal positioning of the indexed abutments with GM Exact.

GM Driver for Contra-Angle Handpiece

GM Driver for Torque Wrench Long Short



Note 1: There are 3 similar markings at 1-mm intervals in the Drivers for the Contra-angle handpiece and Torque Wrench. These markings guide the depth of the final positioning of the implant in the following way: first stripe for 1 mm below bone level, second for 2 mm and third for 3 mm. Each full turn of the implant results in: (a) 2.2 mm for the Drive implants; (b) 1.4 mm on average for the Helix implants; and (c) 1.2 mm for the Titamax implants.

Note 2: An important difference between the contra-angle driver and the torque wrench driver is that the contra-angle handpiece driver features metal tweezers in the apex to keep the implant in position. Torque Wrench drivers are therefore not indicated for transporting the implant from the blister to the patient's mouth.

### 6.3.2 Manual placement of the implant

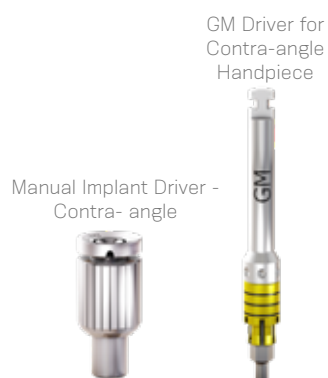

FIGURE 25. All instruments for contra-angle handpieces can be fitted to the Manual Implant Driver - Contra-angle.

The entire sequence described above can be repeated manually, using the Manual Implant Driver - Contra-angle instead of the contra-angle handpiece.

### 6.3.3 Completing the positioning of the implant with the Torque Wrench



Remove the Grand Morse contra-angle handpiece driver from the implant, and fit the torque wrench driver for the final positioning of the implant and torque measurement. There are two torque wrench driver options: short and long. First, use the fingers to fit the driver to the interior of the implants and then hitch the torque wrench onto the driver. The torque wrench drivers should not be used to transport the implant from one place to another because the product can fall out. Apply torque until the implant reaches its final position. All torque wrenches show torque levels a value above 60 N.cm is contraindicated.

*Warning: Corrections in the vertical position by means of reverse rotations during surgery can lead to reduced primary or mechanical stability.*

### 6.3.4 Torque Wrench

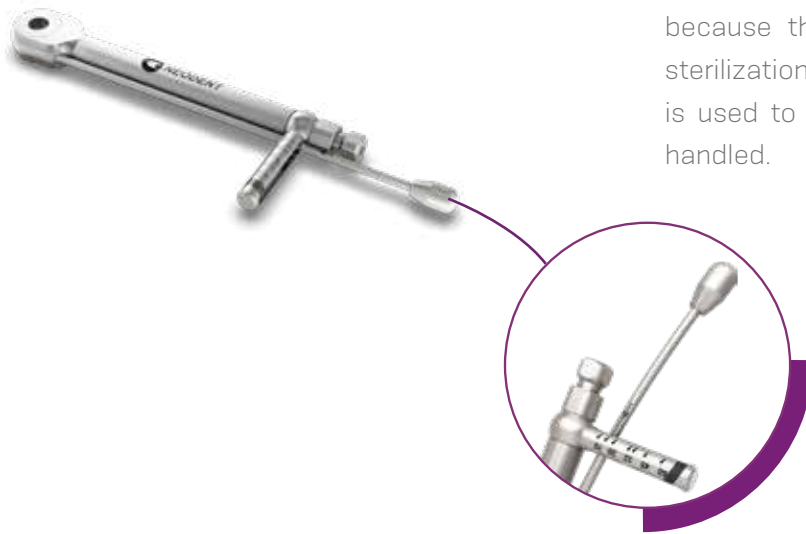

Neodent Torque Wrenches are demountable because they need to be cleaned internally before the sterilization process in the autoclave. The thinnest rod is used to measure and indicates the torque value when handled.



*Note: Implants can be placed with these drivers fitted to a GM Torque Wrench Driver. However, this does not allow the surgeon to apply the final torque for the implant and thus is only indicated for the initial positioning of the implant with the Handle Implant Driver.*

## 6.4 Handling soft tissue

After the placement, the implant is covered with a cover screw or healing abutment to protect it. The surgeon may choose between submucosal or transmucosal healing and has all available options for handling soft tissue by means of a secondary healing component kit.

### 6.4.1 Two-step/submucosal healing



For submucosal healing (under a closed mucoperiosteal flap), the use of the GM Cover Screw is indicated. A second surgical procedure is necessary to reveal the implant and insert the desired abutment.

The Neodent system has two cover screws, which are sold separately and sterile packed, at the implant level and 2 mm (above the implant shoulder) for positioning below bone level.

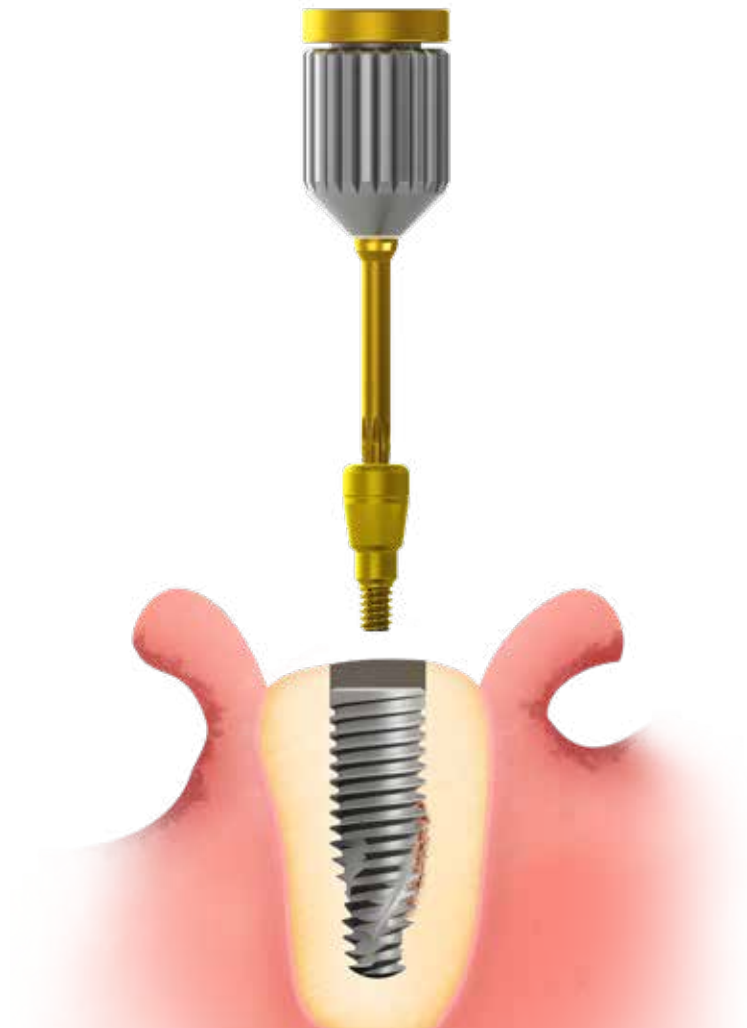

**Step 1 – Inserting the cover screw**

Ensure that the internal configuration is clean and free of blood residue. Capture the GM Cover Screw with the Neo Manual Screwdriver. A perfect fit ensures the transport for the implant, and manually tighten the screw.

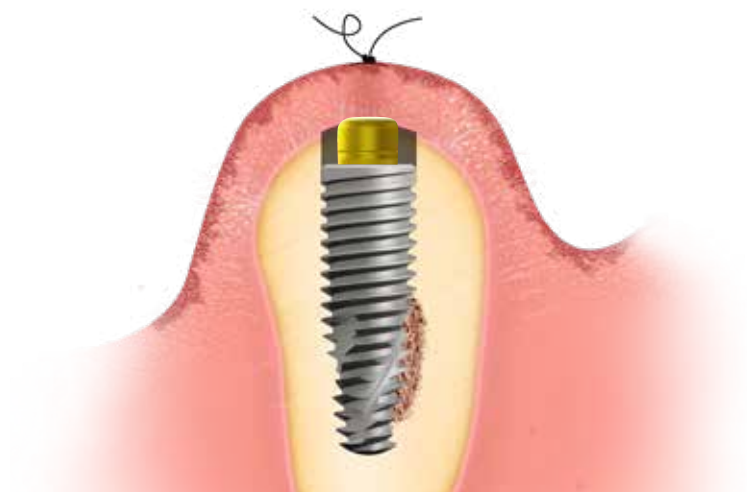

**Step 2 – Close the incision**

Adjust the edges of the flap and suture with tension-free stitches.

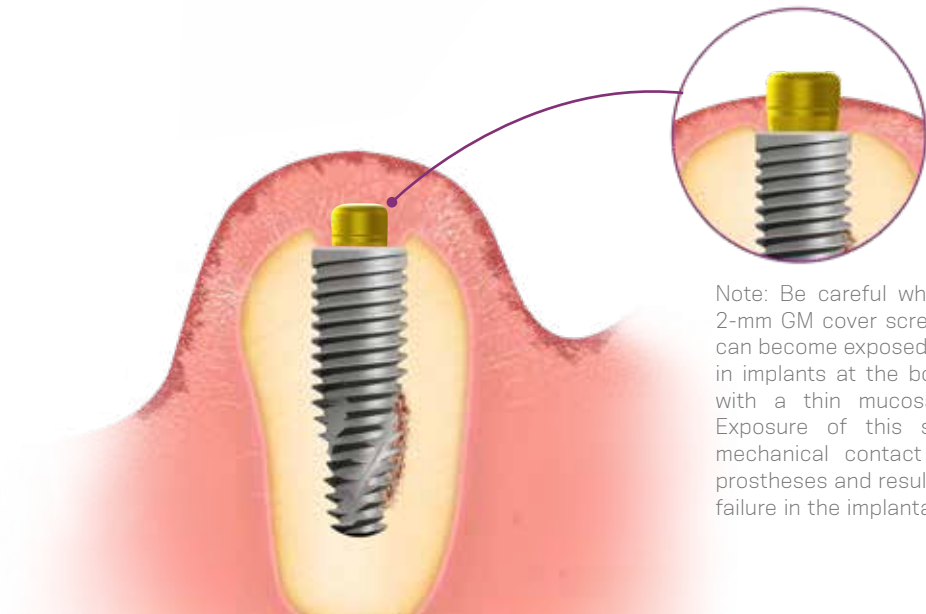

Note: Be careful when using the 2-mm GM cover screw because it can become exposed when placed in implants at the bone level and with a thin mucosal thickness. Exposure of this screw allows mechanical contact with mobile prostheses and results in failure in the implantation.

**Step 3 – Regeneration period**

Remove the suture after approximately 7 days or once it has lost its function and wait for the bone regeneration phase.

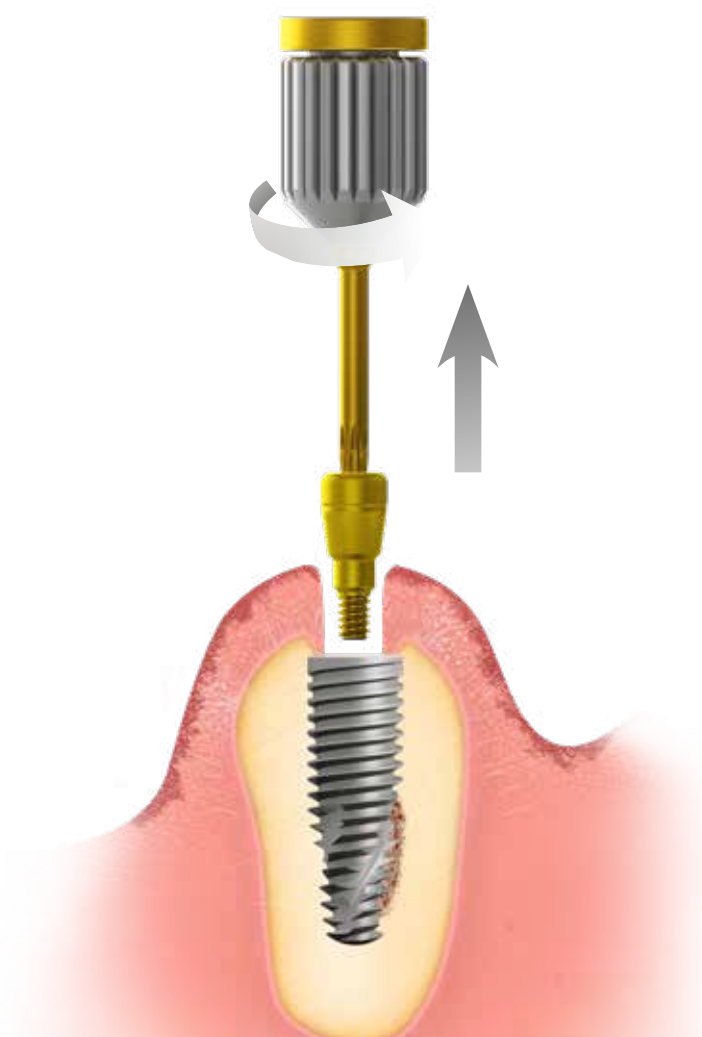

**Step 4 – Reopening and removal of the GM Cover Screw**

Second surgery – After the bone regeneration period for each type of implant and bone, locate the implant with the help of the surgical guide, X-rays or measurements, and, with the desired technique, make an incision to reach the implant, and remove the GM Cover Screw with the Neo Manual Screwdriver.

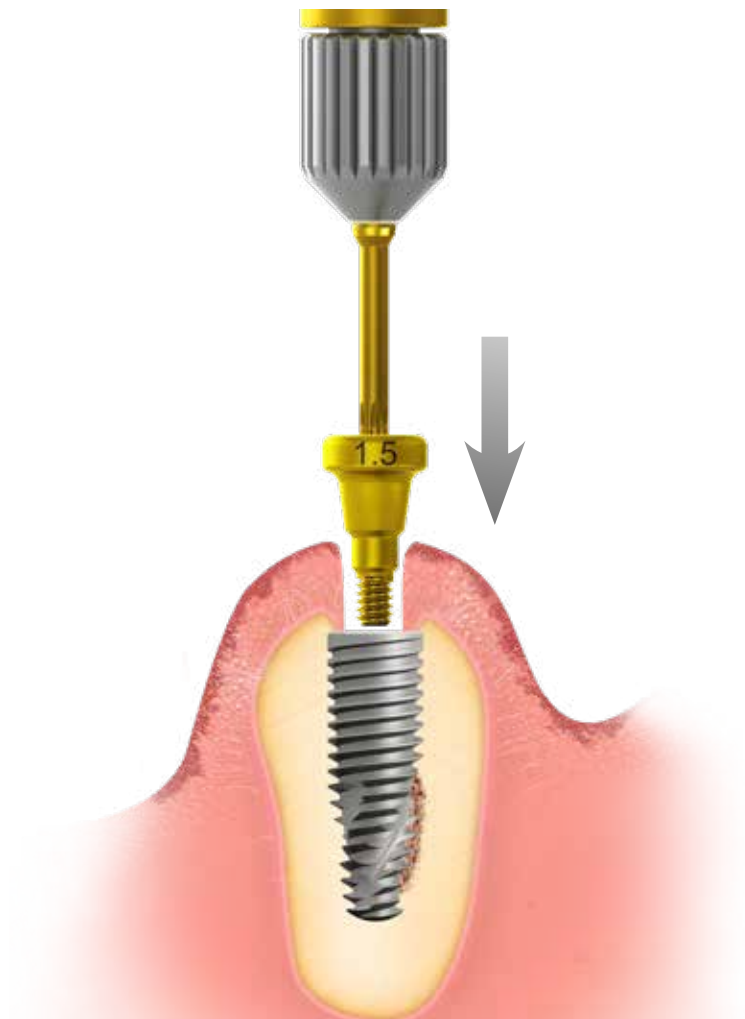

**Step 5 – Insertion of healing abutment**

Irrigate the implant's exposed internal connection with sterile saline solution, insert the healing abutment (or an abutment, if applicable). Adjust the soft tissue and suture around the healing abutment. Most information on healing abutments can be found in 6.5 (page 51).



**Step 6 – Close the wound**

Adjust the soft tissue and suture around the healing abutment.



### 6.4.2 Transmucosal healing: one-step or immediate loading

A variety of healing abutments and abutments are available for the Neodent Grand Morse system, shaping the soft tissue during the transmucosal healing after placing the implant. The abutments can be used provisionally (to be replaced in the final restoration phase), or a definitive abutment can be used along with a provisional restoration. This phase can be defined as a one-step operation (if the healing abutment is chosen after the surgical procedure) or immediate loading (if a definitive abutment is selected).

The implant's final placement torque determines the protocol. Correct and physiological occlusion is also a determinant in the definition. Patients deprived of a balanced occlusion are not good candidates for the immediate loading protocol. Table 5 lists the criteria to be observed for the use of the immediate loading protocol.

Torque (Ncm)	Healing protocol	General characteristics
≥ 32 to ≤ 60 Ncm	Immediate loading or selection of abutment	<ul style="list-style-type: none"> <li>- Lateral mechanical load on provisional crowns is contraindicated.</li> <li>- Patients should present a balanced or physiological occlusion.</li> <li>- Periodontally compromised patients should have their condition controlled prior to treatment, especially when a component is exposed to the oral environment.</li> </ul>

TABLE 5: Immediate loading protocol according to torque level.

### 6.4.2.1 Transmucosal healing: one-step

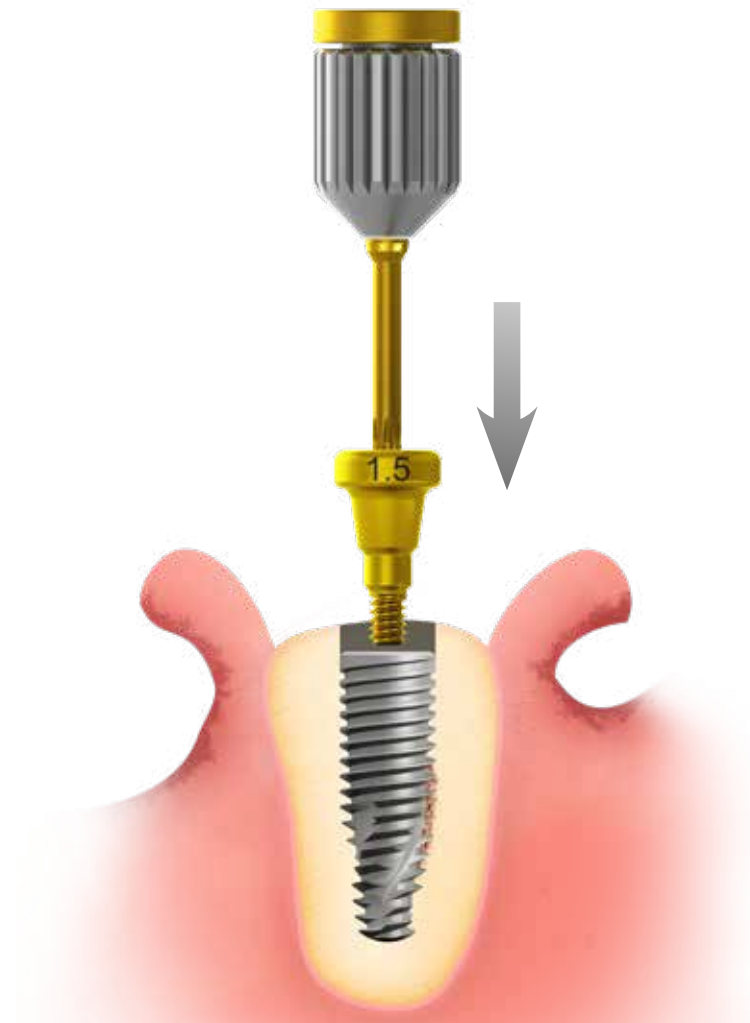

#### **Step 1 – Insertion of healing abutment after implant**

Ensure that the internal configuration is clean and free of blood. Insert the healing abutment manually with the Neo Manual Screwdriver.



#### **Step 2 – Close the wound**

Adjust the soft tissue to the component, and suture with tension-free sutures.

## 6.5 Overview of the healing abutments

The Neodent system has a variety of healing abutments, with various diameters and transmucosal heights to correspond to the definitive abutment. Choosing the correct healing abutment is therefore extremely important to ensure proper healing of soft tissue, with controlled pressure and respect for biological distances.

Basically, there are various formats of Grand Morse healing abutments to be adapted to the surgeon's needs:



	Ø 3.3	Ø 4.5
Transmucosal height	0.8 mm	0.8 mm
	1.5 mm	1.5 mm
	2.5 mm	2.5 mm
	3.5 mm	3.5 mm
	4.5 mm	4.5 mm
	5.5 mm	5.5 mm

To select the correct prosthetic abutment and check the thickness of the remaining mucosa, there is the Grand Morse Height Measurer, which can be fitted to the implants and serves as a reference for selecting the most suitable abutment.

GM Height Measurer



The height of the abutments varies from 0.8 to 5.5 mm and should be chosen based on the gingival height. Given that the healing abutment's internal design is identical to that of the definitive abutment, if the height of the chosen healing abutment is very high, the soft tissue will heal this way as well. If the height of the chosen definitive abutment is not compatible (lower, for example), it will exert great pressure on the soft tissue, and the patient will complain of compression pain. It is therefore advisable to choose an abutment with the same transmucosal width and height as the healing abutment. If the definitive abutment needs to be replaced, the patient should be anesthetized, and the tissue should be given time to readapt.

All Neodent healing abutments have been strategically designed to create a proper emergence profile, adjusted to the margin of all abutments in such a way that they remain 0.9 mm under the mucosa.



6.5.1 Overview of Grand Morse abutments and corresponding healing abutments

Grand Morse Screw-retained Options

Type		GM Mini Conical Abutment	GM Angled Mini Conical Abutment	GM Micro Abutment	GM Abutment
Abutment	Ø Available	4.8 mm	4.8 mm	3.5 mm	4.8 mm
	Transmucosal height	0.8 mm		0.8 mm	0.8 mm
		1.5 mm		1.5 mm	1.5 mm
		2.5 mm		2.5 mm	2.5 mm
		3.5 mm		3.5 mm	3.5 mm
		4.5 mm		4.5 mm	4.5 mm
5.5 mm		5.5 mm	5.5 mm		
Corresponding healing abutment	Ø Available	4.5 mm	4.5 mm	3.3 mm	4.5 mm
	Transmucosal height	0.8 mm		0.8 mm	0.8 mm
		1.5 mm		1.5 mm	1.5 mm
		2.5 mm		2.5 mm	2.5 mm
		3.5 mm		3.5 mm	3.5 mm
		4.5 mm		4.5 mm	4.5 mm
5.5 mm		5.5 mm	5.5 mm		

Grand Morse Cement-retained Options

Type		GM Universal Abutment (straight)	GM Universal Abutmen (straight)
Abutment	∅ Available	3.3 mm	4.5 mm
	Transmucosal height	0.8 mm	0.8 mm
		1.5 mm	1.5 mm
		2.5 mm	2.5 mm
		3.5 mm	3.5 mm
		4.5 mm	4.5 mm
5.5 mm	5.5 mm		
Corresponding healing abutment	∅ Available	3.3 mm	4.5 mm
	Transmucosal height	0.8 mm	0.8 mm
		1.5 mm	1.5 mm
		2.5 mm	2.5 mm
		3.5 mm	3.5 mm
		4.5 mm	4.5 mm
5.5 mm	5.5 mm		

Note: GM angled Universal abutments are only available with transmucosal heights of 1.5, 2.5 and 3.5 mm.

### 6.5.2 Grand Morse Customizable Healing Abutments

The Grand Morse line also features customizable healing abutments. They are produced in titanium, with a customizable portion made of Peek. The available diameters and transmucosal heights are presented below. It is also important to notice the height of the parallel portion, which is of 1.5 mm for all options, with the exception of the 7.0X5.5 mm (with a 2.5 mm high parallel portion) and the 7.0X6.5 mm (with a 3.5 mm high parallel portion). In all cases, there is the possibility of customizing the upper and lateral portions of the product. A minimum thickness of 0.5 mm is recommended to be maintained between the screw and the lateral and upper portions.



Customizable Healing Abutments

	∅ 5.5	∅ 7.0
Transmucosal height	1.5 mm	2.5 mm
	2.5 mm	3.5 mm
	3.5 mm	4.5 mm
	4.5 mm	5.5 mm*
	5.5 mm	6.5 mm**

\*parallel portion of 2.5 mm

\*\*parallel portion of 3.5 mm

## 7.0 HEALING PHASE

The healing protocol depends on:

(1) The implant's final placement torque or primary stability, as measured with the Torque-indicating Ratchet Wrench.

(2) The bone type.

More time is needed when low torque values are reached. Immediate loading procedures may also be applied in cases of minimum placement torque of 32 Ncm.

## 8.0 GENERAL PROSTHETIC GUIDELINES

Once this stage has been reached, the definitive prosthetic abutment should be chosen for the final restoration. This step can be conducted in the healed mucosa (submucosal healing, conventional protocol) or during surgery for protocols such as one-step/transmucosal healing or immediate loading.

To help with the selection of abutments, Neodent offers the GM Height Measurer, which can also be sterilized and visualized in X-rays.

The following features should be considered:

- a. Single tooth or multiple tooth restoration
- b. Screw-retained or cement-retained restoration
- c. Interocclusal gap, height and width
- d. Gingival height (transmucosal height)
- e. Biological distance (distance from abutment to bone crest)
- f. Whether the implant angulation needs to be corrected for the abutment or whether adjacent abutments are parallel.



The GM Height Measurer helps determine the gingival height.

The positioning below bone level of implants results in a certain amount of bone over their cervical region. This tissue can collide with abutments fitted on the implant. For these situations, Neodent provides a GM Bone Profile Drill.

## 9.0 NEODENT KITS

Neodent Kits are available in cassettes to help keep the instruments organized and sterile. The cassette is manufactured with a heat-resistant polymer and is indicated for frequent sterilization in an autoclave.

The New Grand Morse Surgical Kit is intuitive and functional and features exclusive instruments for placing the new Helix GM, Drive GM and Titamax GM implants.

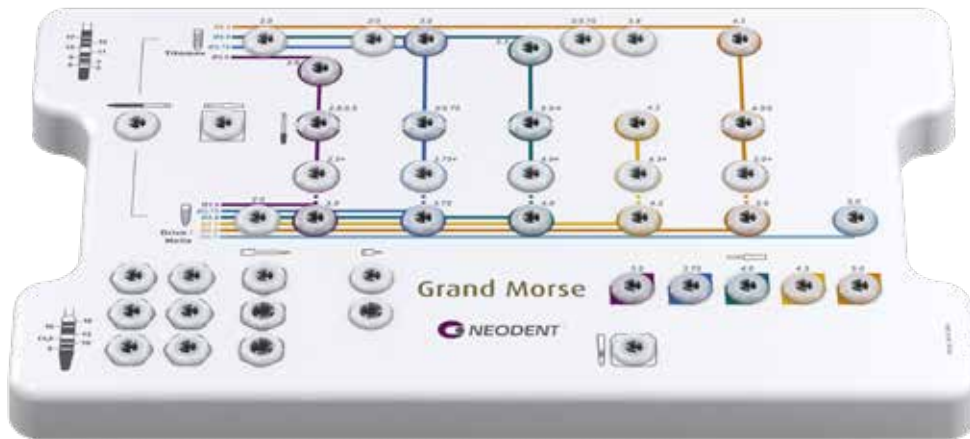

Grand Morse Surgical Kit

### 9.1 Cleaning and Care of the Cassette and Instruments

Neodent kits and instruments must be completely cleaned after each procedure. Do not leave the instruments in a damp environment for an extended period, because they might oxidize.

Step 1 – Separate and disassemble the instruments (if applicable).

Step 2 – Completely submerge the instruments in an enzyme detergent solution (10%-15%).

Step 3 – Perform a wash cycle in an ultrasonic cleaner for 10 minutes.

Step 4 – With the help of brushes, completely remove any residue by rinsing in distilled water.

Step 5 – Dry thoroughly with paper towels and/or compressed air.

Step 6 – Inspect the instruments to ensure that the cleaning process was effective.

Step 7 – Select the appropriate packaging for the sterilization process.

Important: To prevent oxidation, do not leave or store instruments if they are not completely dry. Do not use descaling solutions (nonenzymatic), because they may darken and oxidize the instruments.

The use of enzyme solutions above 10% and the inadequate removal of the solution during rinsing can also promote oxidation.

### 9.2 Sterilization of the Cassette and Instruments

Neodent Kits should be sterilized the day before or on the day of the procedure. The recommendation is to follow the autoclave sterilization parameters according to regulation BS EN ISO 17665-1: "Sterilization of health care products. Moist heat. Requirements for the development, validation and routine control of a sterilization process for medical devices".

Do not sterilize in dry heat, because this can damage the cassette.

Sterilization validity: 7 to 15 days, if kept in a clean and dry environment, protected from sunlight.

## 9.3 Cleaning and Care of the Drills

Neodent drills should be properly sanitized after each use. Proceed as follows:

### Manual cleaning and disinfection

#### Cleaning

1. Disassemble the instruments, if possible (check the disassembly instructions for each instrument, when applicable).
2. Soak the disassembled instruments for at least 1 minute in the cleaning solution (CIDEZYME<sup>®</sup>, 1.6% v/v) so that the instruments are fully covered. Ensure that there is no contact between the instruments. Carefully use a soft brush to help the cleaning process. Shake the moving parts several times during the cleaning. If applicable, wash all internal surfaces at least 5 times, using a single-use syringe (minimum volume of 10 ml).
3. Soak the disassembled instruments for 15 minutes in the cleaning solution (CIDEZYME<sup>®</sup>, 1.6% v/v) using ultrasonic treatment, so that the instruments are fully covered. Ensure that there is no contact between the instruments.
4. Remove the instruments from the cleaning solution, and wash them thoroughly at least 3 times (for at least 1 minute) in running water. If applicable, wash all internal surfaces at least 5 times, at the beginning of the immersion, using a single-use syringe (minimum volume of 10 ml).

#### Disinfection

1. Soak the disassembled instruments for 12 minutes in the disinfectant solution (CIDEX<sup>®</sup> OPA Solution, undiluted) so that the instruments are fully covered. Ensure that there is no contact between the instruments. If applicable, wash all internal surfaces at least 5 times, at the beginning of the immersion, using a single-use syringe (minimum volume of 10 ml).
2. Remove the instruments from the disinfectant solution, and wash them according to the manufacturer's instructions for the CIDEX<sup>®</sup> OPA Solution:

#### Washing instructions

- After removing the instruments from the CIDEX<sup>®</sup> OPA Solution, wash the medical device thoroughly by completely immersing it in a large volume of water. Use sterile water, unless the potable water is acceptable (maximum of 10 germs/ml, maximum of 0.25 endotoxins/ml).
- Keep the device completely immersed for at least 1 minute.
- Manually clean all orifices with large volumes (over 100 ml) of washing water.
- Remove the device and discard the washing water. Always use new volumes of water for each wash. Do not reuse the water for rinsing or any other purpose.
- Repeat the procedure twice more, for a TOTAL OF 3 WASHES, with large volumes of clean water to remove residues of the CIDEX<sup>®</sup> OPA Solution. The residues can cause severe adverse effects.

3. Check and package the instruments immediately after removal.

#### Automatic cleaning and disinfection (Washer Disinfector (WD)).

Use the neodisher<sup>®</sup> MediZym detergent.

1. Disassemble the instruments, if possible (check the disassembly instructions for each instrument, when applicable).
2. Transfer the disassembled instruments to the WD (ensure that the instruments do not touch each other).
3. Start the program.
4. Remove the instruments from the WD after the program has finished.
5. Check and package the instruments immediately after removal.



## NOTES:

1. Pay attention to the following points during the selection of the washer-disinfector:

- Approved WD efficacy (e.g., EC marking in accordance with EN ISO 15883 or DGHM or FDA approval/clearance/registration).
- Option for an approved heat disinfection program (A0 value > 3000 or, for older devices, at least 5 minutes at 90 °C / 194 °F, in case of hazardous chemical disinfection of remaining disinfectant on instruments).
- Use the appropriate program for instruments, as well as the information on sufficient washing in the program.
- Post-wash only with sterile water or water with low contaminants (e.g., maximum of 10 germs/ml, maximum of 0.25 endotoxins/ml).
- Use filtered air only (oil-free, low contamination from microorganisms and particles) for drying.
- Regular maintenance and verification/calibration of the WD.

2. Do not clean any instruments using metal brushes or steel wool.

3. Check all instruments after cleaning and after disinfection for corrosion, damaged surfaces and impurities.

Do not use the devices if they are damaged. Instruments that are still contaminated must be cleaned and disinfected once again.

4. Packaging: Insert the clean and disinfected instruments into the sterilization trays, in single-use sterilization packages (single or dual packaging) and/or sterilization containers that meet the following requirements:

- EN ISO/ANSI AAMI ISO 11607 (for USA: FDA clearance).

- appropriate for steam sterilization
- sufficient protection for instruments, as well as the maintenance of sterilization packaging for mechanical damage.

5. After the instruments have been used, the coarse impurities should be removed by performing a Pretreatment, prior to cleaning and disinfection (for a maximum of 2 hours). Pretreatment should be conducted in the two cases of Cleaning and Disinfection (Automatic and Manual).

a. Disassemble the instruments, if possible.

b. Wash the instruments for at least 1 minute in running water (temperature <35 °C).

c. If applicable: Wash the instruments' orifices 5 times per application, with the help of a single-use syringe (minimum volume of 10 ml). Shake the moving parts several times during the pretreatment.

d. Manually remove all visible impurities using a clean and soft brush (or a clean, soft, lint-free cloth). In no case should a metal brush or steel wool be used.

e. Rinse once again for at least 1 minute in running water.

6. If the abovementioned cleaning/disinfection products cannot be found, ensure that similar products are employed. Any substitution is the user's sole responsibility.

7. Drying the parts is extremely important before storing and sterilization because the accumulation of humidity in the products is damaging and can cause oxidation.

NOTE: During sanitization, prevent contact between the cutting instruments and other instruments so as not to jeopardize their cutting power.

## 9.4 Drill Sterilization

Neodent Drills are reusable and provided unsterile in individual packaging. The drills must be properly sanitized and sterilized before each use. Sterilize the products the day before or on the day of the procedure.

WARNING: Autoclaving these products in their original packaging is not recommended. For sterilization, use only the steam sterilization method according to the following parameters:

	Fractional vacuum/Dynamic airremoval <sup>1</sup>	Gravitational <sup>2</sup>
Sterilization time	4 minutes	15 minutes
Sterilization time <sup>3</sup>	132 °C/270 °F	132 °C/270 °F
Drying time	At least 20 minutes <sup>4</sup>	At least 20 minutes <sup>4</sup>

<sup>1</sup> At least three stages of vacuum.

<sup>2</sup> The least effective gravitational sterilization procedure should not be used if the fractional vacuum procedure is available.

<sup>3</sup> Maximum sterilization temperature 134 °C (273 °F).

<sup>4</sup> The required efficacy in the drying time depends directly on parameters for which the user is responsible (loading configuration and density, sterilization conditions), and these must be determined by the user. However, the applied drying time should be no less than 20 minutes.

NOTES:

1. After sterilization, package the instruments in a dry, dust-free setting.
2. The immediate-use/flash sterilization procedure should not be used.
3. Do not use dry-heat sterilization, radiation sterilization, sterilization with formaldehyde and ethylene oxide or plasma sterilization.

## BIBLIOGRAPHY

1. Brånemark PI, Hansson BO, Adell R, Breine U, Lindström J, Hallén O et al Osseointegrated implants in the treatment of the edentulous jaw. Experience from a 10-year period. *Scand J Plast Reconstr Surg Suppl.* 1977;16:1-132.
2. Gaviria L, Salcido JP, Guda T, Ong JL. Current trends in dental implants. *J Korean Assoc Oral Maxillofac Surg.* 2014 Apr;40(2):50-60.;
3. Gupta A, Dhanraj M, Sivagami G. Status of surface treatment in endosseous implant: a literary overview. *Indian J Dent Res.* 2010 Jul-Sep;21(3):433-8.
4. Lambert PM, Morris HF, Ochi S. Positive effect of surgical experience with implants on second-stage implant survival. *J Oral Maxillofac Surg.* 1997 Dec;55(12 Suppl 5):12-8.
5. Bernardes SR, da Gloria Chiarello de Mattos M, Hobkirk J, Ribeiro RF. Loss of preload in screwed implant joints as a function of time and tightening/untightening sequences. *Int J Oral Maxillofac Implants.* 2014 Jan-Feb;29(1):89-96.
6. Coppedê AR et al. Fracture resistance of the implant-abutment connection in implants with internal hex and internal conical connections under oblique compressive loading: an in vitro study. *Int J Prosthodont.* 2009 May-Jun;22(3):283-6.
7. Lazzara RJ & Porter SS. Platform switching: A new concept in implant dentistry for controlling abutment restorative crestal bone levels. *Int J Periodontics Restorative Dent* 2006;26:9-17.
8. Martin C, Thomé G, Melo AC, Fontão FN. Peri-implant bone response following immediate implants placed in the esthetic zone and with immediate provisionalization-a case series study. *Oral Maxillofac Surg* 2015 Jun;19(2):157-63.
9. Barros RR, Novaes AB Jr, Muglia VA, Lezzi G, Piattelli A. Influence of interimplant distances and placement depth on peri-implant bone remodeling of adjacent and immediately loaded Morse cone connection implants: a histomorphometric study in dogs *Clin Oral Implants Res.* 2010;21(4):371-8.
10. Castro DS, Araujo MA, Benfatti CA, Araujo Cdos R, Piattelli A, Perrotti V, et al. Comparative histological and histomorphometrical evaluation of marginal bone resorption around external hexagon and Morse cone implants: an experimental study in dogs. *Implant Dent* 2014;23(3):270-6.
11. Novaes AB Jr, Barros RR, Muglia VA, Borges GJ. Influence of interimplant distances and placement depth on papilla formation and crestal resorption: a clinical and radiographic study in dogs. *J Oral Implantol* 2009;35(1):18-27.
12. de Siqueira RA, Fontão FN, Sartori IA, Santos PG, Bernardes SR, Tiozzi R. Effect of different implant placement depths on crestal bone levels and soft tissue behavior: a randomized clinical trial. *Clin Oral Implants Res.* 2016 doi: 10.1111/clr.12946. [Epub ahead of print]
13. Sotto-Maior BS, Lima Cde A, Senna PM, Camargos Gde V, Del Bel Cury AA. Biomechanical evaluation of subcrestal dental implants with different bone anchorages. *Braz Oral Res* 2014;28.
14. dos Anjos GM, Harari ND, Reis RSA, Vidigal Junior GM. Análise in vitro da infiltração bacteriana na interface de pilares protéticos e implantes cone-morse / In vitro analysis of bacterial leakage at the interface between Morse taper implant platform and prosthetic abutments. *ImplantNews*;8(2):239-243, 2011.

15. Sartoretto SC, Alves AT, Resende RF, Calasans-Maia J, Granjeiro JM, Calasans-Maia MD. Early osseointegration driven by the surface chemistry and wettability of dental implants. *J Appl Oral Sci.* 2015 May-Jun;23(3):279-87.
16. Rupp F, Scheideler L, Eichler M, Geis-Gerstorfer J. Wetting behavior of dental implants. *Int J Oral Maxillofac Implants.* 2011 Nov-Dec; 26(6):1256-66.
17. da Silveira BM. Análises tomográfica, microtomográfica e histológica entre enxertos em bloco autógeno e xenógeno nas reconstruções ósseas de maxila. [master's dissertation on internet]. [Curitiba(Brazil)]: ILAPEO; 2013. [cited 15 jun 2014] 133p. Available from: <http://www.ilapeo.com.br/biblioteca-detalle/tomographic-microtomographic-and-histological-analysis-between-grafts-in-autogenous-and-xenogeneic>
18. Mendonça G, Mendonça BD, Oliveira SL, Araujo AC. Efeitos da diferenciação de células-tronco mesenquimais humanas sobre superfícies de implantes hidrofílicas. *ImplantNews* 2013 Nov-Dez 10(6a):111-116.
19. Glauser R, Portmann M, Ruhstaller P. Initial implant stability using different implant designs and surgical techniques. *Appl Osseointeg Res.* 2001;2(1):6-8.
20. da Cunha HA, Francischone CE, Filho HN, de Oliveira RC. A comparison between cutting torque and resonance frequency in the assessment of primary stability and final torque capacity of standard and TiUnite single-tooth implants under immediate loading. *Int J Oral Maxillofac Implants.* 2004 Jul-Aug;19(4):578-85.







