



Neodent®
Helix Short

Surgical and Prosthetic Manual

SUMMARY

3 EXPLORE NEW LEVELS

9 PLANNING AND IMPLANT POSITIONING

12 APPLICATIONS

15 SURGICAL PROCEDURES

23 IMPLANT PACKAGING AND PLACEMENT

26 SOFT TISSUE MANAGEMENT

27 PROSTHETIC PROCEDURES

42 REFERENCES

NEODENT® HELIX SHORT - EXPLORE NEW LEVELS

Modern implant dentistry drives us to develop solutions that provide less morbidity and faster treatment times for patients. At the same time, challenging indications such as vertical bone atrophy require advanced implant technology and design, efficient surgical techniques, and comprehensive prosthetic options.

The emerging concern of peri-implant management, as an important factor for long-term success, supports the demand for reliable features related to the surrounding implant soft tissues. In addition, the search for reliable surgical drilling protocols, especially in conditions of poor vertical bone availability, is a key point for more predictable results in patients' rehabilitations.

The Neodent® Helix Short system was designed to deliver efficiency in challenging clinical situations of vertical bone atrophies, as an alternative for bone regenerative procedures.^{1,2} Meet your patients' expectations and increase the acceptance rate of your treatments with straightforward protocols and versatile prosthetic options of Neodent® Helix Short.



Explore new levels with helix short.

Scan the QR and watch the concept!



A remarkable solution for vertical bone atrophy.

Potential to treat more cases with less morbidity and shorter treatment times.^{1,2}



A design for optimized soft tissue management seeking long-term success.^{3,7}

The Tissue Level concept enabling potentially better biological outcomes.³



Versatile prosthetic resolution and anatomical compatibility.

Meet the expectations for challenging cases: from single-unit to full arch restorations.*

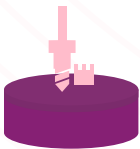

More predictability for challenging surgical procedures.

Build confidence with intuitive control of drilling depth.



Helix Short is the result of concepts already established in the Neodent philosophy and taken to the next level. A remarkable solution for cases of low vertical bone availability.

DR. GENINHO THOMÉ



*Implants with a length of 4 and 5.5 mm are contraindicated for single and overdenture rehabilitations, and they are contraindicated for total and multiple restorations when not associated with implants with lengths greater than or equal to 7 mm.

A remarkable solution for vertical bone atrophy.

Helix Short was designed to meet patient expectations, delivering the Neodent established concepts of immediacy and straightforward protocols, even for more demanding indications, such as low vertical bone availability: An alternative to bone graft procedures such as guided bone regeneration and sinus lift augmentation.^{1,2}



Every millimeter matters: an implant design for a wide variety of clinical situations.

The proven versatility of the Helix implant design as a short implant, the Helix Short offers solutions for different bone types. Features built into its design include:

- Body design for progressive stability;
- Single trapezoidal threads;
- Apically tapered: apex for increased mechanical stability;
- Because every millimeter matters, a wide range of lengths:



The Helix Short connection: a stable foundation for challenging rehabilitations.

Built upon a new prosthetic platform, the Helix Short connection was designed in conjunction with a transmucosal collar to allow a deep internal connection as a stable foundation for the system - even when using a short implant. Its connection, regardless of the implant diameter, provides:

- Wide cone on top for optimized occlusal forces distribution.
- Internal indexation for easy handling and precise abutment positioning.



Acqua hydrophilic surfaces and treatment predictability.⁸⁻¹¹

The Neodent® Acqua hydrophilic surface is the next level of the highly successful S.L.A. surface. It was developed to reach expected result outcomes even in the most challenging patient cases, such as soft bone or immediate protocols.⁸⁻¹¹



Same connection for all implant diameters. Only one transmucosal collar height for all implant lengths.

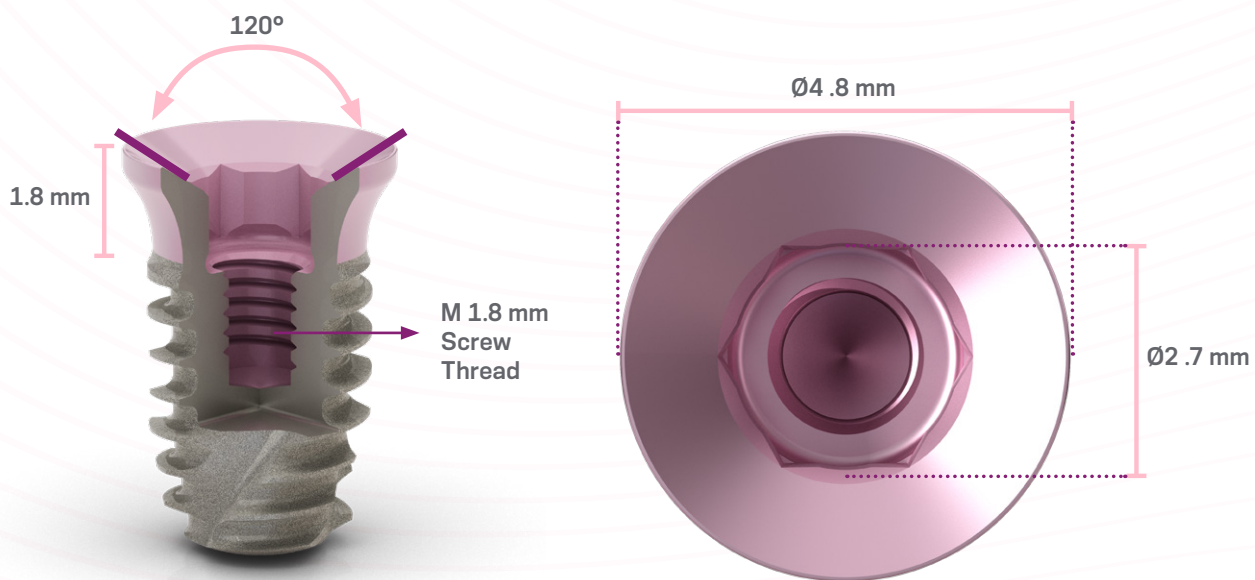

A design for optimized soft tissue management seeking long-term success.^{3,7}

Helix Short implant combines reduced lengths with a transmucosal collar. The smooth surface of this tissue level portion addresses the emerging concerns of modern implant dentistry related to peri-implant diseases, is designed to enable favorable long-term outcomes for treatments.³

The helix short transmucosal collar: a concept designed for tissue level and peri-implant management.

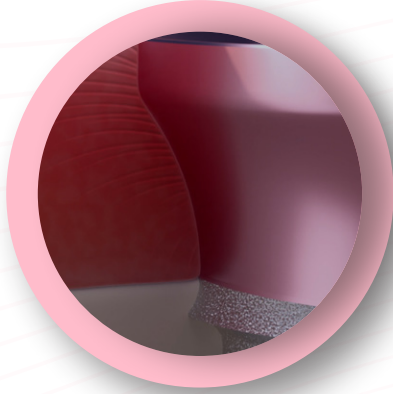

Transmucosal collar: smooth surface optimized for lower bacterial adhesion.⁷

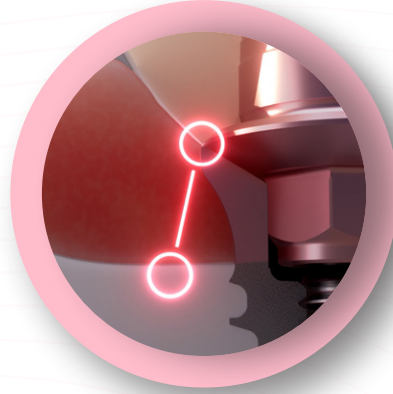

Implant-abutment interface: position far from the crestal bone and optimized space for biological distance.³

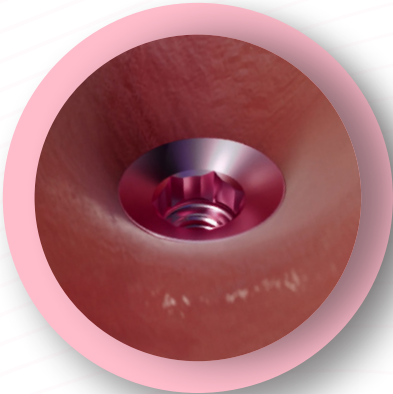

Featuring soft tissue management for esthetic outcomes.

Anodized transmucosal collar: Mimics the natural color of soft tissues for positive outcomes even in aesthetic demanding cases.⁶



A standard transmucosal collar, optimized for lower bacterial adhesion.

Scan the QR code and check out!

Versatile prosthetic resolutions and anatomical compatibility.

The Helix Short provides a versatile, prosthetic solution for cases of low vertical bone availability. From single units to full arch restorations*, the system provides clinicians tools and a comprehensive prosthetic portfolio designed to treat prevalent and challenging clinical situations.



*Implants with a length of 4 and 5.5 mm are contraindicated for single and overdenture rehabilitations, and they are contraindicated for total and multiple restorations when not associated with implants with lengths greater than or equal to 7 mm.

Featuring soft tissue management and better esthetic outcomes.

The Helix Short provides predictability for different types of prosthetic resolutions, from single-unit to full arch restorations*:



Temporary Abutments



Titanium Base for Crown



Titanium Base for Bridge



Straight Mini Conical Abutment



Angled Mini Conical Abutment

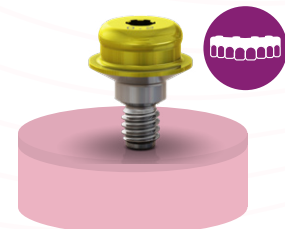

Attachment TiN



Single-unit screw-retained prosthesis



Single-unit cement-retained prosthesis



Temporary



Multiple-unit screw-retained prosthesis



Overdenture

From conventional to digital: a wide range of materials and workflows.

Meet and exceed patient expectations with access to a variety of restorative material options for a wide range of abutments:

- Milling, printing, or conventional manufacturing that features simplicity in all workflows;
- Prosthetic libraries available for the main CAD/CAM systems.



*Implants with a length of 4 and 5.5 mm are contraindicated for single and overdenture rehabilitations, and they are contraindicated for total and multiple restorations when not associated with implants with lengths greater than or equal to 7 mm.

More predictability for challenging surgical procedures.

The Neodent® Helix Short system's deep drilling control system featuring drill stops which enable control of drilling depth that help clinicians build confidence to overcome the challenges of performing procedures in patients with low vertical bone availability.



See the drilling system in practice

Scan the QR code!



Build confidence during drilling by gaining more predictable depth control.

Helps to avoid anatomical structures, such as the inferior alveolar neurovascular bundle, maxillar sinus, or adjacent roots with better physical control of drilling depths and predictable stops.

Improve accuracy even in challenging clinical situations, such as limited visibility caused by adjacent teeth, tongue, blood, or saliva.



An intuitive color-coded protocol: the next step in efficient surgical procedures.

By offering a color-coded system, the Helix Short Surgical Kit facilitates the drilling sequence during the surgical procedure and enables a more user-friendly experience.



PLANNING AND IMPLANT POSITIONING

Implant positioning is the key to obtaining the correct prosthetic restoration and is the basis for surgical planning. Communication among the patient, the dentist, the surgeon, and the lab technician are essential for reaching the desired prosthetic result. To establish the correct planning, with the correct spatial position, choosing the ideal implant design (diameter and length), number, and distribution of implants, it is recommended to:

- Perform a wax-up on the patient's study cast;
- Define the edentulous space to be restored;
- Define the type of coping or bar structure;
- Complete a CT scan and radiographic exams.

The wax-up can then be used to fabricate the radiographic and/or surgical template and be used as a temporary restoration. Physiological occlusion is determinant of implant success in the short and long term. Immediate loading procedures should not be performed in patients with problems in occlusion.

Note that the implant abutments should always be loaded axially, and the long axis of the implant aligned with the cusps of the opposing teeth. Extreme cusp formation should be avoided, since it may lead to overloading.

The position and number of implants are determined according to the anatomy and the prosthetic space available for each patient case. The recommendations presented here should be considered basic guidelines for correct biological healing, adequate restorations, and patient oral hygiene. The restoration design has a strong impact on occlusion and hygiene, and it must be taken into consideration.

The final response of the hard and soft tissues is highly influenced by the position of the abutment; therefore the tri-dimensional positioning of the implant needs to be studied for the following::

- Mesiodistal;
- Buccolingual;
- Apical coronal.

Mesiodistal implant positioning

The available mesiodistal bone is an important factor when choosing the implant diameter and quantity. It is the distance between implant to teeth and implant to the implant when multiple implants are required. The reference point is to measure the larger mesiodistal width of the implant, usually in the cervical area. Generally, implants require a minimum of adjacent bone of 1.5 mm around it.

Rule 1

Ideally, the distance of Helix Short implants to adjacent teeth is at least 1.5 mm between the implant's widest portion and the cervical of the teeth, both on the mesial and distal aspects.

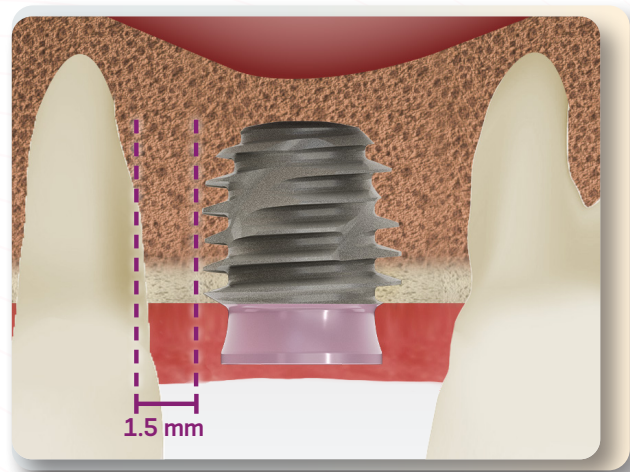
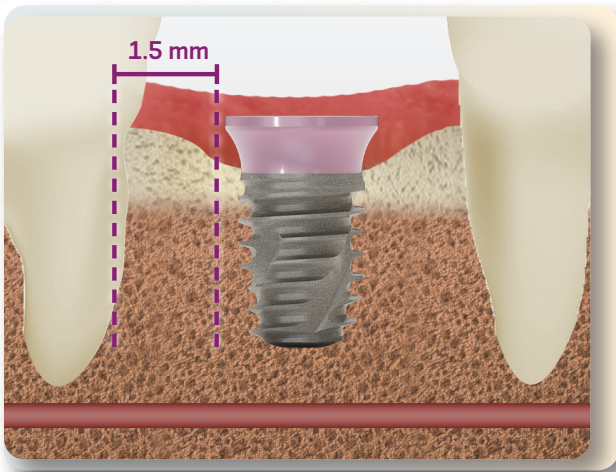

Rule 2

As implants require at least 1.5 mm of adjacent bone, the distance to other implants is a minimum 3 mm.

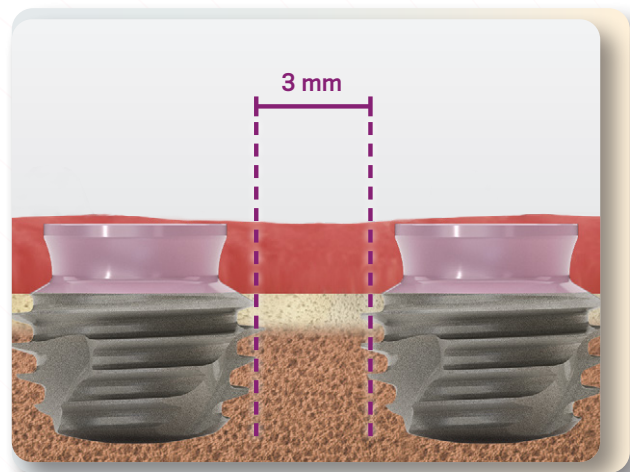
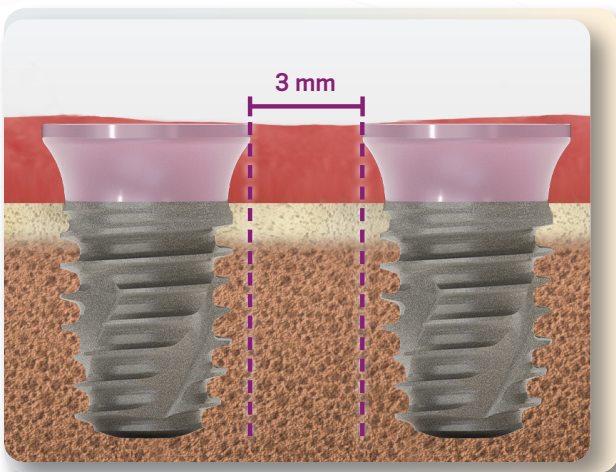

Buccal-lingual implant positioning

The buccal and lingual bone layer must be at least 1 mm in thickness to contribute to a stable hard and soft tissue condition, as well as a well-fitted prosthetic restoration. Also, the clinician will need to know if the plan is to do a screw or cement-retained prosthesis.

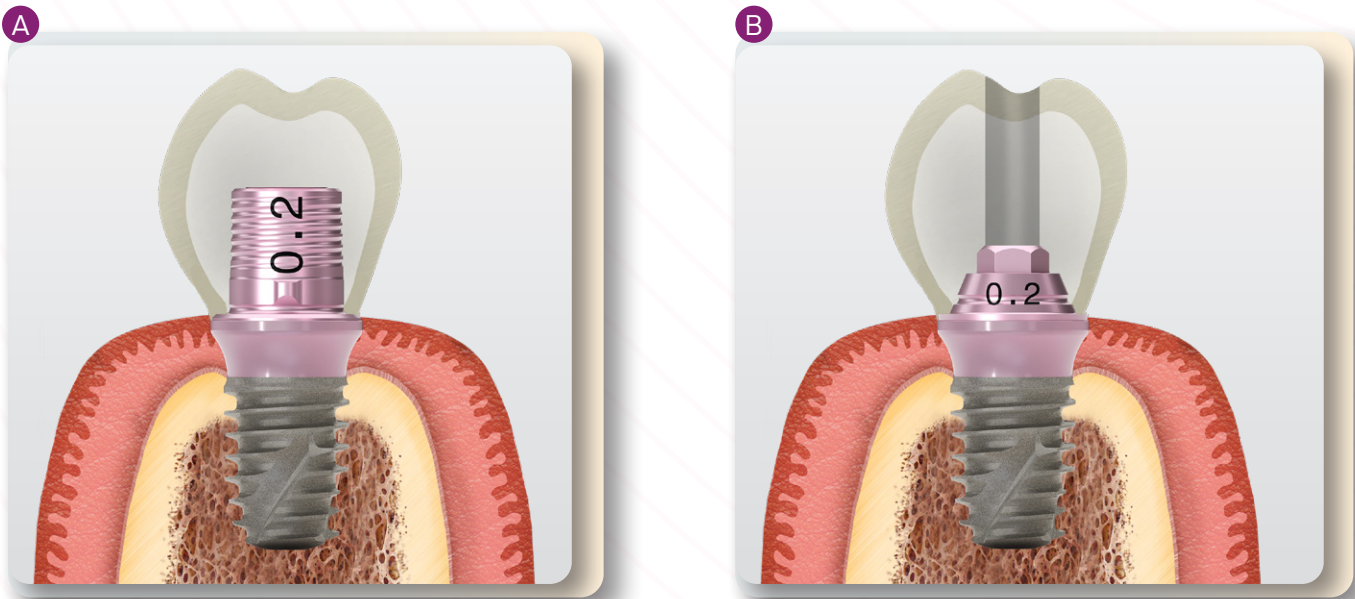

Example of implant positioned for cement-retained prosthesis (A) and screw-retained prosthesis (B), where there is access to the screw.

Apical coronal

Neodent Helix Short is a Tissue-Level implant and must be installed within the bone up to the polished neck portion.

During the planning is needed to pay attention to the important anatomical structures such as nerves, sinus, blood vessels, etc.

Note: If the bone crest is irregular and it's not clinically recommended to regularize it, ensure all the treated portion is inside the bone.

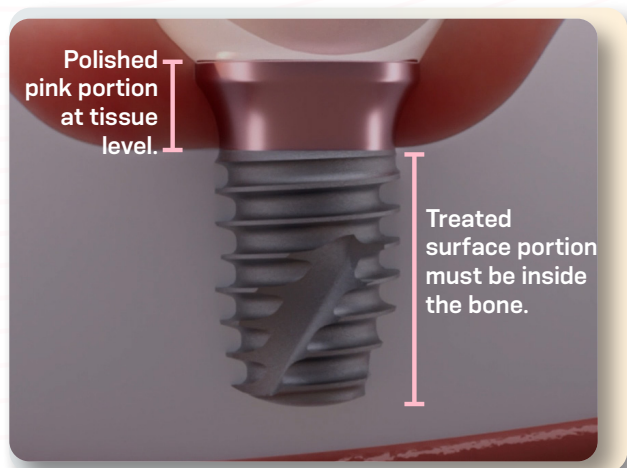
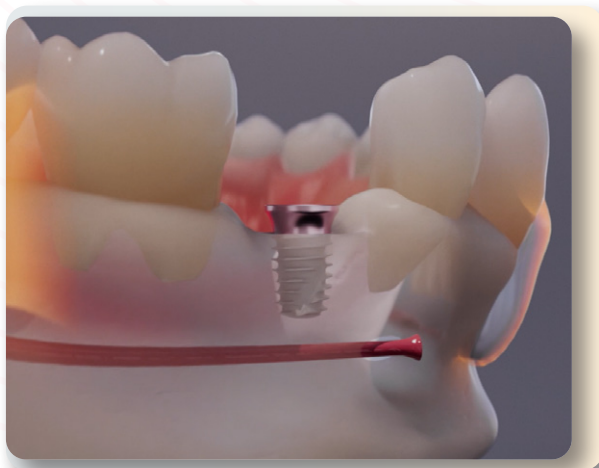

APPLICATIONS

The Helix Short Implant is indicated for surgical intraoral installation in bones with density I/II or and III/IV, according to the Lekholm and Zarb bone classification (1985). in the maxilla or mandible.

It may be used as a support for single or multiple prosthesis, in immediate or delayed loading protocols. It may be used in one- or two-stage procedures, single or multiple restorations, and immediate loading when there is good primary stability and adequate occlusal load. Note: For immediate load application, the primary stability must be at least 35 Ncm and the patient must present physiological occlusion. It is recommended for the following rehabilitations:

- Rehabilitation of totally edentulous patients: The Helix Short implant can be installed in the posterior region of the mandible to reduce the cantilever of the prostheses, avoiding fractures.

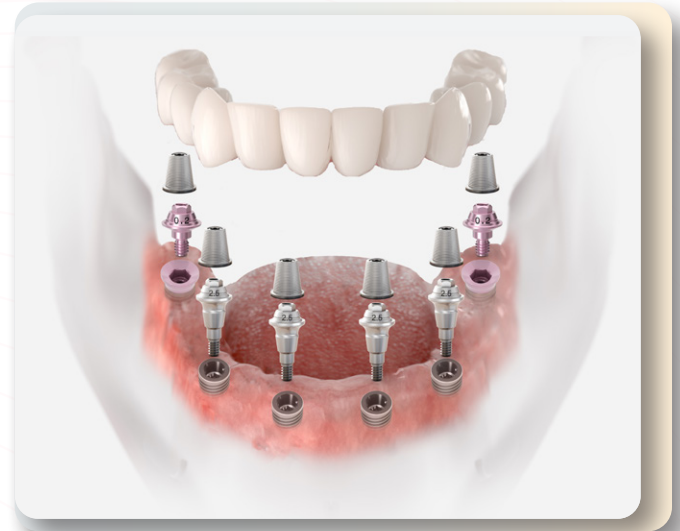

- Rehabilitation of maxilla with severe atrophy: The Helix Short implant, as it requires less bone height, can be installed in cases in which the bone is extremely resorbed, eventually reducing the number of Zygomatic implants to be installed.

*Implants with a length of 4 and 5.5 mm are contraindicated for single and overdenture rehabilitations, and they are contraindicated for total and multiple restorations when not associated with implants with lengths greater than or equal to 7 mm.

- Rehabilitation of maxilla with moderate atrophy: In cases in which bone density may not be sufficient for conventional implants, Helix Short implants can be installed, avoiding the need to apply maxillary sinus lift/bone grafting techniques.

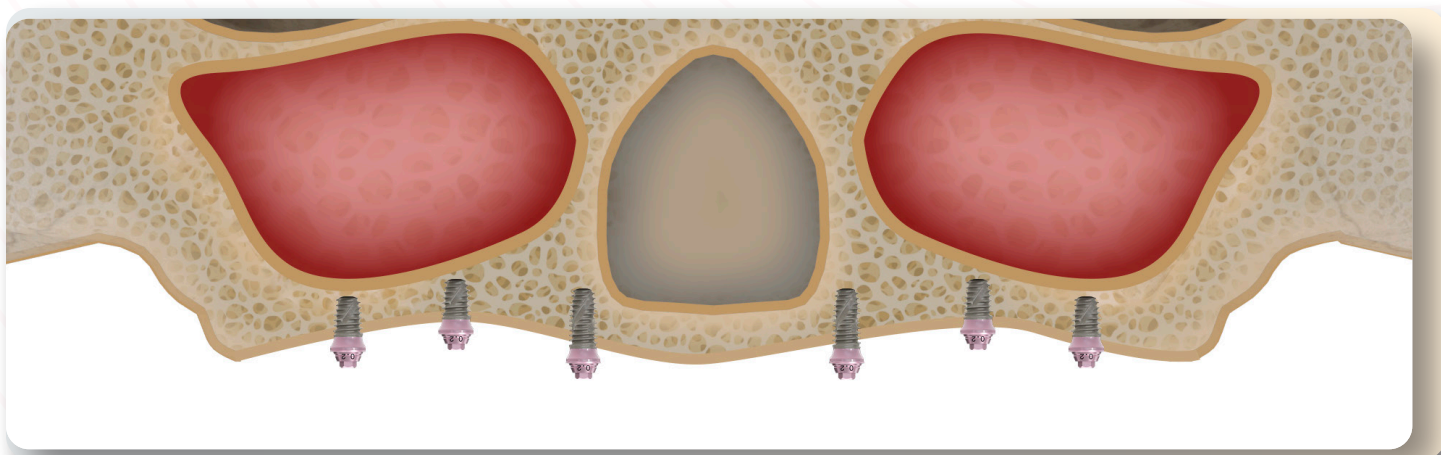
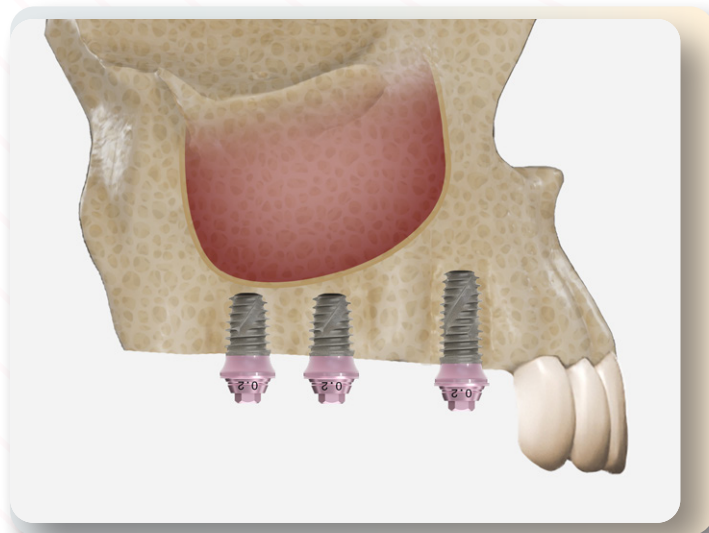

- Implants with a length of 4 and 5.5 mm are contraindicated for single and overdenture rehabilitations, and they are contraindicated for total and multiple restorations when not associated with implants with lengths greater than or equal to 7 mm.



Contraindications*

Implants with a length of 4 and 5.5 mm are contraindicated for single and overdenture rehabilitations, and they are contraindicated for total and multiple restorations when not associated with implants with lengths greater than or equal to 7 mm.

Although there is no consensus or absolute contraindications, it is known that there are higher implant failure rates in cases of patients with periodontal diseases, severe consumption of alcohol/tobacco, bruxism, high use of bisphosphonates or proton pump inhibitors (PPI), radiotherapy, diabetes, and autoimmune diseases. However, controlled systemic diseases should not be considered a defining risk factor in the failure of the implant. Dental implants are not recommended in patients with incomplete bone growth due to problems related to the growth of the maxilla and mandible. Moreover, precautions must be taken when placing dental implants in patients with hemorrhage disorders, HIV, and osteoporosis because these conditions increase the likelihood of complications. There is no clinical data that supports the use of implants in pregnant women. This product is contraindicated for patients who show signs of allergy or hypersensitivity to the chemical components of titanium.

Precautions

- 6.0 and 7.0 mm diameter implants are indicated for type IV bones.
- 6 and 7 mm diameter, with 7 and 8.5 mm length implants in type I/II bones are indicated for post-extraction only.

* for all contraindications please refer to IFU page ifu.neodent.com.br/en

SURGICAL PROCEDURES

The diameter, position, and number of implants should be selected considering anatomy and spatial circumstances. Basic implant bed preparation involves ridge preparation and tapered drill with water cooling, for which the selected implant's diameter and design determine the instruments to be used.

The drill is used to prepare the osteotomy following a sequence according to the implant length and bone type, as the preoperative planning chooses. All drills are adapted to contra-angle according to the ISO 1797-1 – Dental rotary instruments - Shank.

Surgical Instruments

Stop drills

The surgical procedure for short implant placement can be challenging, especially when performed in the posterior regions with limited visibility, or in proximity to anatomical structures such as nerve canals.

The Neodent® Control System brings confidence and efficiency building trust during the surgical procedure.

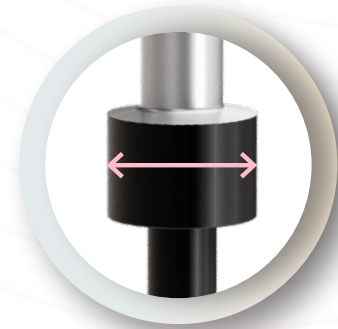

Coupling diameter



Attached to the Stop Drills, Neodent® Control Drill Stops allow easy depth control during the osteotomy. They come in different diameters and lengths, to be selected according to the implant to be placed and the related drilling sequence.

Neodent® Control Drill Stops are reusable and made of titanium.



The kit is used for storage and sterilization procedure for Neodent® Helix Short Control Drill Stops. During surgery, it allows easy engagement and disengagement of the stops on the stop drills. The holders can be purchased separately, in case they need to be replaced.



To capture the stop in the Helix Short Kit, follow the steps below:

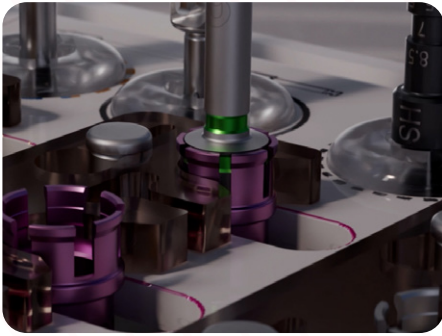

- 1 Initially position the Tapered Control Stop Drill inside the Stop.

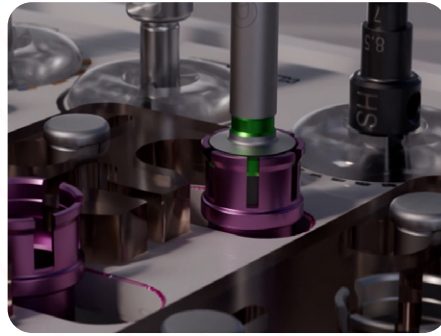

- 2 Slide it to the right.



- 3 Remove the set Tapered Control Stop Drill and Stop from the case.

To remove the stop in the Control Drill Stop Kit, follow the steps below:

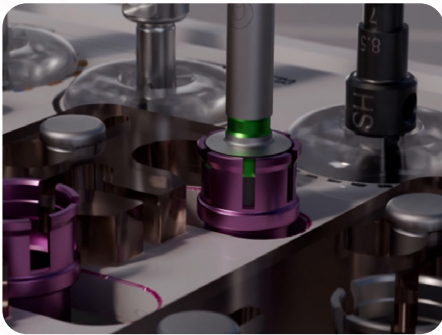

- 1 Initially position the set Tapered Control Stop Drill and Stop on the right.

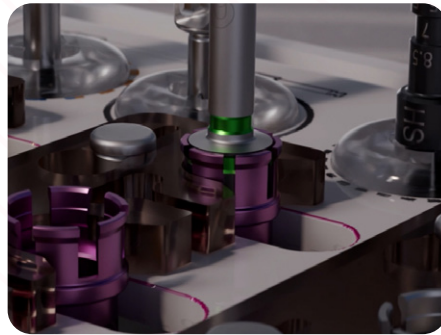

- 2 Slide to the left.



- 3 Pull the Drill so that it can be removed from the Stop.

X-ray Positioner / Direction Indicator

The HS Direction Indicator/X-Ray Positioner is made of titanium alloy Ti6Al4V-ELI according to standard ASTM F136.

The instrument has two sides. One for use after the $\varnothing 2.7$ mm drill and the other to use after the $\varnothing 3.75$ mm drill. In its middle portion, it has a diameter equivalent to the diameter of the $\varnothing 3.75$ mm implant body.

It contains steps at the same heights as the Helix Short implants (4.0, 5.5, 7.0, and 8.5 mm), helping to determine the insertion depth. In addition, there is a hole for the safety wire to pass through in the middle region.

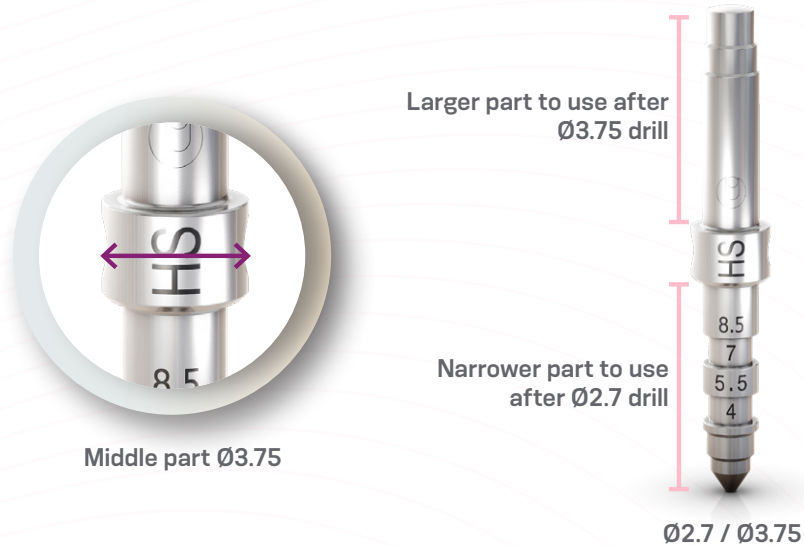

It combines the functions of an X-Ray Positioner and Direction Indicator into a single instrument so that the product will have two functions during the surgical procedure: determining the position of the perforations about the opposite arch and assessing the depth of the osteotomy using periapical X-rays.

Before using the product, tying a safety wire to the orifice is recommended to avoid migration and the risk of the patient swallowing or aspirating the product.

For the Direction Indication function:

After drilling with the Ø2.7 mm drill, the narrower tip of the Direction Indicator is inserted into the surgical bed to determine the drilling angle. After drilling with the Ø3.75mm drill, insert the large tip of the Direction Indicator into the surgical bed alveolus to recheck the drilling angle.

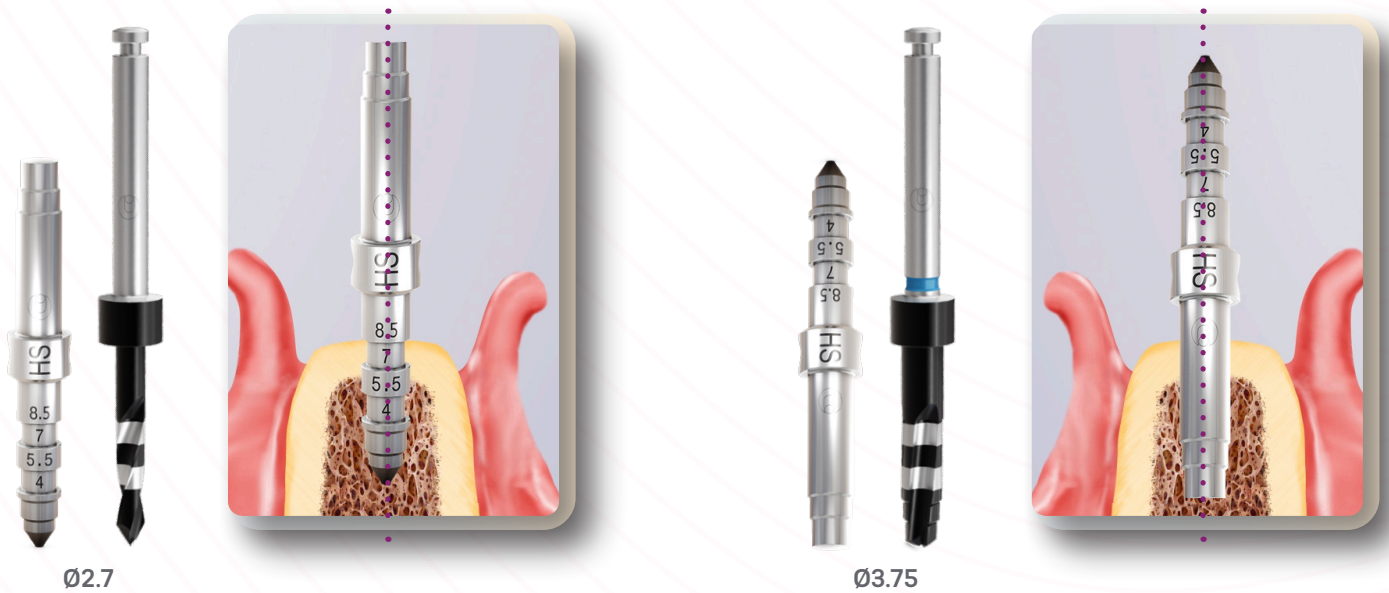

For the X-Ray Positioner function:

After performing the planned implant osteotomy, insert the X-Ray Positioner into the drilled cavity to perform the X-ray for evaluation according to the parallelism technique.

The implant selection must be based on the steps that indicate the depth reached (implant length) evidenced on the X-ray.

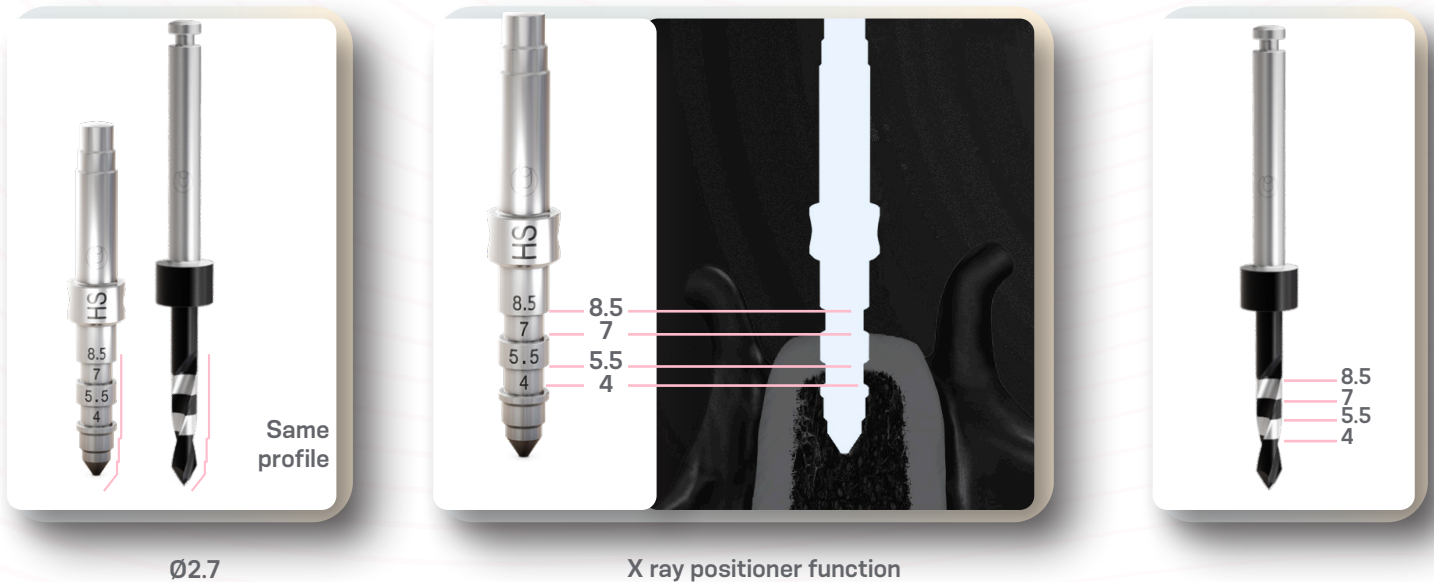

Measurer

The HS Height Measurer and HS Angle Measurer are made of titanium alloy Ti6Al4V-ELI according to standard ASTM F136. The ring of the Height and Angle Measurers are made of stainless steel.

The HS Height Measurer has a cylindrical shape designed with grooves on the upper portion for secure handling of the instrument during the procedure. The instrument's body has a hole for the safety wire to pass through it. On the lower portion, there is a rotational interface for fitting the Helix Short implant. The height measurer has steps that help view the gingival heights of the system. The heights for measurement are as follows: 1.5, 2.5, 3.5, 4.5, and 5.5 mm.

The HS Angle Measurer has a 17° angle designed with grooves on the upper portion for secure handling of the instrument during the procedure. The body has a hole for the safety wire to pass through it. The lower portion has an anti-rotational interface with the hexagonal face aligned with the angulation of the rod.

Both instruments have an upper end for handling and a lower end with a geometry for fitting the Helix Short implants and a ring that allows fixing the measurer to the implant.

The HS Height Measurer is indicated to select the gingival height of the abutments. The 17G HS angle Measurer is indicated to check the angulation of the implant in relation to the abutments.

Before using the product, tying a safety wire to the orifice is recommended to avoid migration and the risk of the patient swallowing or aspirating the product.

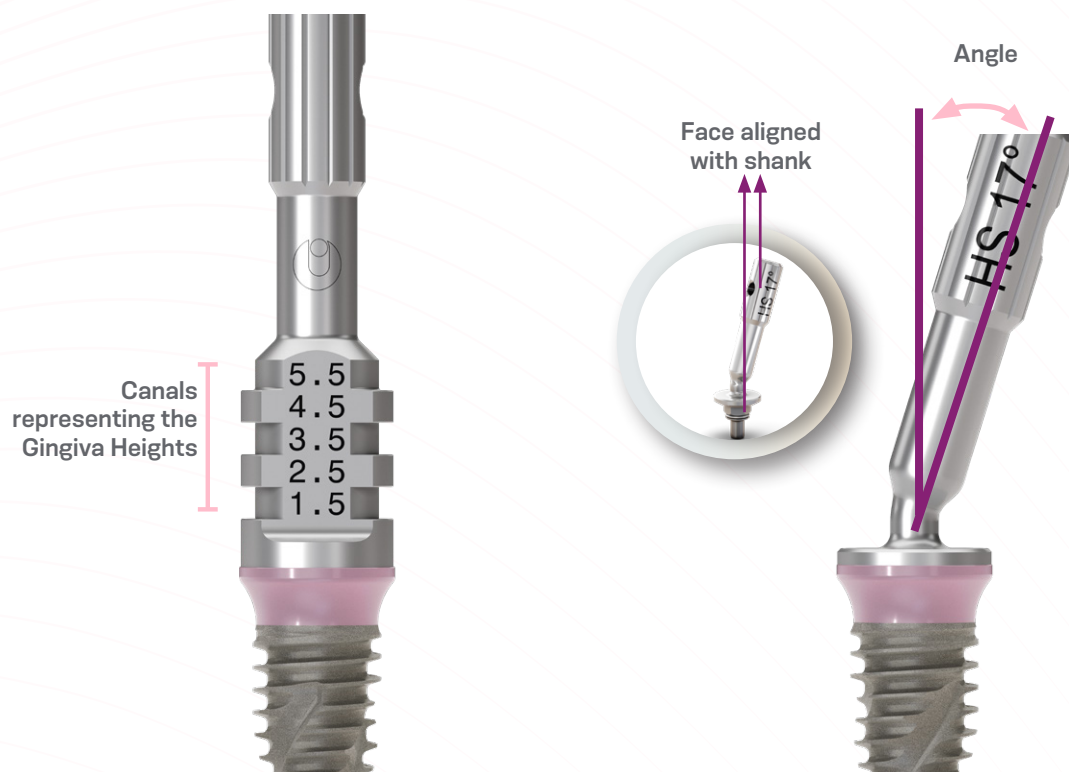

Bone Profile Drill

In cases where the implant body diameter is lower than the prosthetic platform and the bone crest is irregular, the use of a bone profile drill could be needed to remove the interference of the bone and the transmucosal collar of the implant.

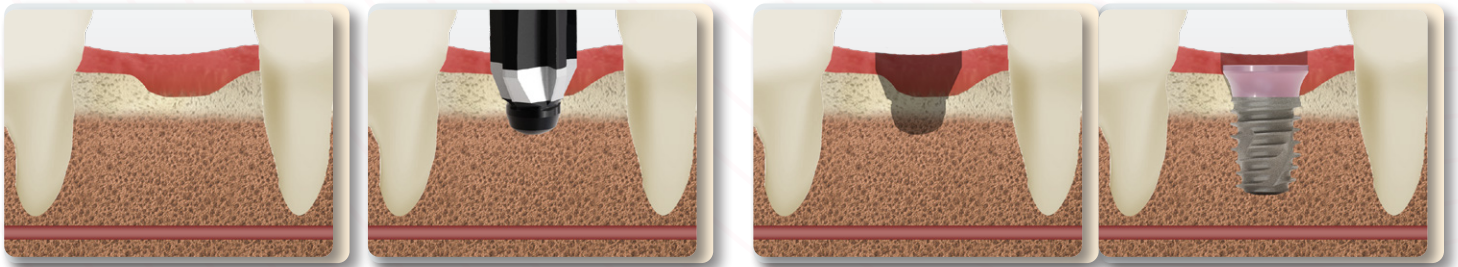
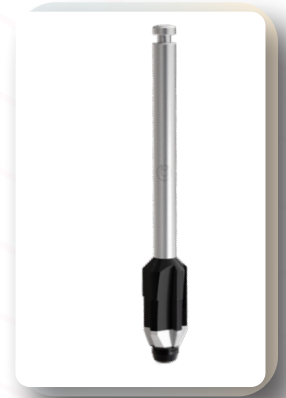

Surgical Kit













Helix Short Surgical Kit has an intuitive and efficient protocol: a higher level in short implant placement procedures.



Drilling protocol

Use drills in good cutting condition and with abundant irrigation at a rotation between 500 and 800 rpm to prepare the implant bed for bones type III/IV and a rotation between 800 and 1200 rpm for bones type I/II. Choose the drill sequence according with the implant. The insertion depth must be in accordance with the planning for the final position of the implant.

Do not interrupt the rotation of the motor while the drill is inside the surgical cavity, as this may impede its removal or cause it to break.

Implant Bone Type	Ø 3.75		Ø 4.0		Ø 5.0		Ø 6.0		Ø 7.0		
	I/II	III/IV	I/II	III/IV	I/II	III/IV	I/II	III/IV	I/II	III/IV	
 103.621 Ø 2.0 Twist Drill	Optional	Optional	Optional	Optional	Optional	Optional	Optional	Optional	Optional	Optional	Optional
 103.597 Ø 2.7 Cylindrical Drill	✓	✓	✓	✓	✓	✓	✓	✓	✓	✓	✓
 103.607 Ø 3.75 Conical Drill	✓	✓	Optional	Optional	Optional	Optional	Optional	Optional	Optional	Optional	Optional
 103.608 Ø 3.75+ Conical Drill Overcontouring	✓										
 103.598 Ø 4.0 Conical Drill			✓	✓	✓	✓	✓	✓	✓	✓	✓
 103.599 Ø 4.0+ Conical Drill Overcontouring			✓								
 103.600 Ø 5.0 Conical Drill					✓	✓	✓	✓	✓	✓	✓
 103.601 Ø 5.0+ Conical Drill Overcontouring					✓						
 103.602 Ø 6.0 Conical Drill							✓	✓	✓	✓	✓
 103.603 Ø 6.0+ Conical Drill Overcontouring							✓				
 103.604 Ø 7.0 Conical Drill									✓	✓	
 103.605 Ø 7.0+ Conical Drill Overcontouring									✓		
 103.606 Bone Profile Drill	Optional		Optional		Optional						

✓ Recommended sequence

IMPLANT PACKAGING AND PLACEMENT

Implant Packaging

Neodent® packaging has been specially updated for easy handling providing practicality from implant stocking to the capture and transport and implant bed. The implant's features, such as type, diameter and length, are readily identifiable on the outside of the packaging.

Three self-adhesive labels are provided for recording in the patient's medical records and for reporting to the prosthesis team. They also allow traceability for all articles.



Instructions on opening the implant package



1 The cardboard and blister packagings must be opened, manually, without the use of sterile gloves. Break the seal of the cardboard packaging and remove the blister. Open the blister pack. Deposit the sterile flask over the surgical field.

Note: the clear tube and implant must be handled with a sterile surgical glove, in a surgical environment. Hold the bottle using the non-dominant hand and take the lid off.



2 Hold the bottle using the non-dominant hand and take the lid off. The internal support containing the implant should come out attached to the lid. To do so, remove the lid and the clear tube's internal support in the axial direction making no lateral movements.

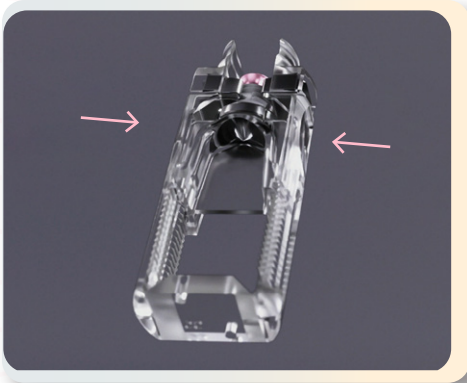

3 Using the non-dominant hand, press the sides of the internal support promoting a “pincer effect” and immobilizing the implant. Keep the support pressed and remove the lid.

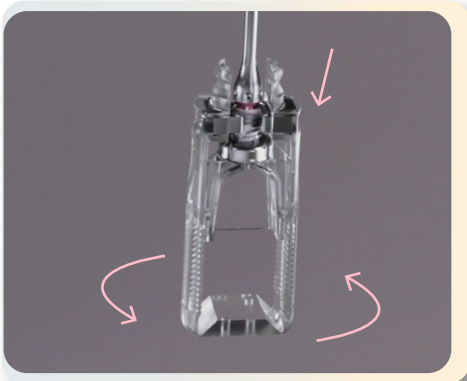

4 For installation, hold the implant with the driver for contra angle, keeping the connection stable and slightly rotating the internal support, searching for the perfect fit between the connection and the implant.



5 Take the implant to the surgical cavity.



6 Place the implant with a maximum torque of 35 Ncm and speed of 30 rpm, clockwise.

Final positioning of the implant

Neodent® Helix Short implants have an internal hexagon index known as Exact. Ensure that the final position of the implant shows one of the prosthetic orientation marks facing the buccal aspect.

The implant drivers have six marks that line up with the six sides of the HS Exact. Position one of the driver marks towards the buccal aspect to ensure the optimal positioning of the indexed abutments with HS Exact.

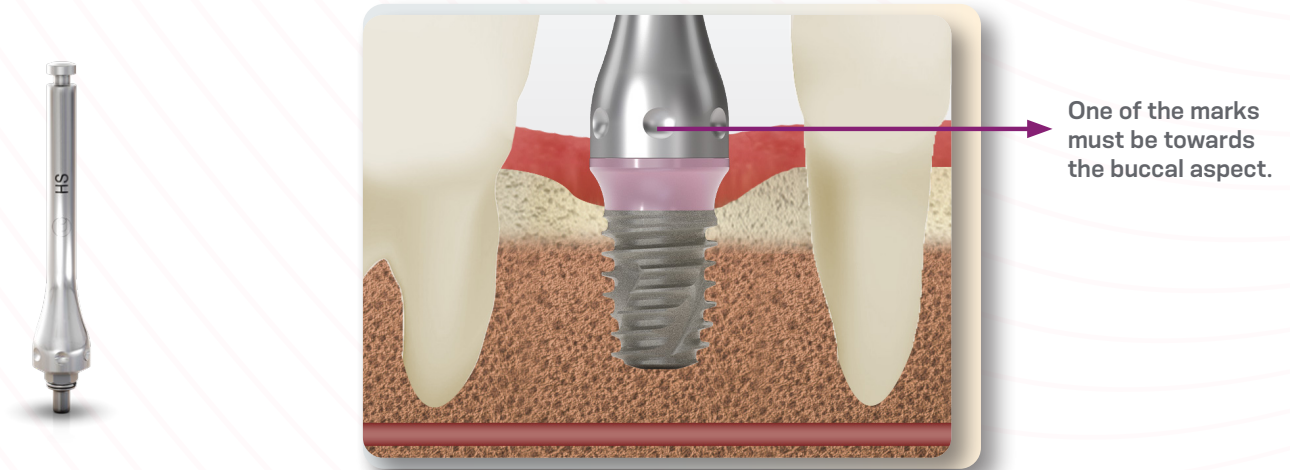

Completing the positioning of the implant with the Torque Wrench

Remove the contra-angle handpiece driver from the implant, and fit the torque wrench driver for the final positioning of the implant and torque measurement. First, use the fingers to fit the driver to the interior of the implants and then hitch the torque wrench onto the driver. The torque wrench drivers should not be used to transport the implant from one place to another because the product can fall out. Apply torque until the implant reaches its final position. All torque wrenches show torque levels. A value above 60 Ncm is contraindicated.

To ensure that the torque during installation of the implant does not exceed the maximum recommended torque of 60 Ncm, it may be necessary to apply reverse torque during insertion of the implant into the bone. To apply reverse torque, invert the direction of the torque wrench to the counterclockwise direction and apply the torque in that direction.

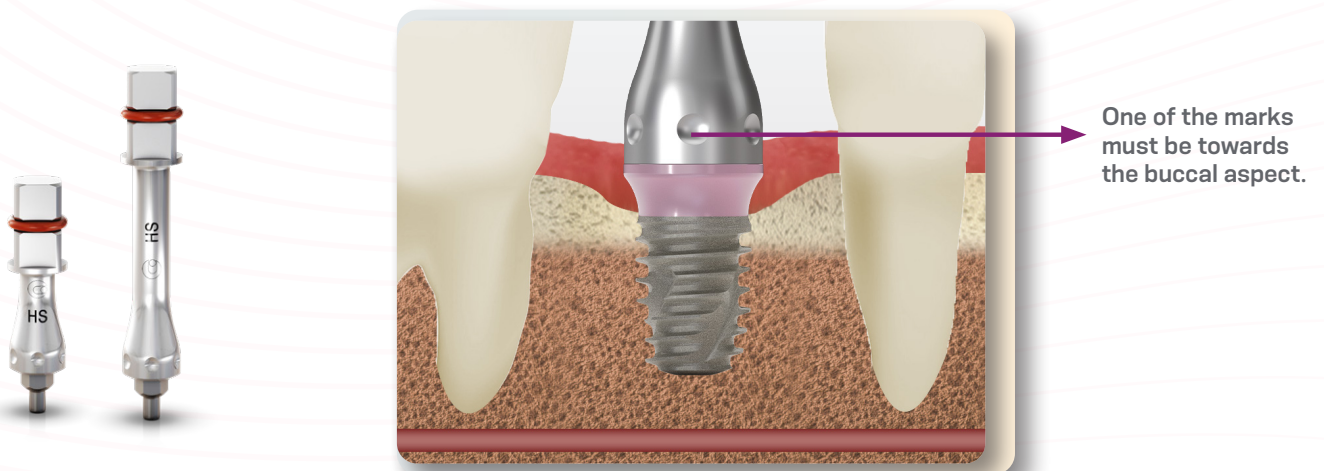

SOFT TISSUE MANAGEMENT

HS Cover Screw

Conventional loading – Cover Screw

After implant placement with conventional loading, in order to protect the implant platform, a cover screw or a healing abutment can be used.

Two stage/ submucosal healing

For under mucosal healing the use of a cover screw is indicated. A second surgical procedure is required to uncover the implant and insert the desired prosthetic abutment. Use the Neo Screwdriver to place the cover screw on the implant. Maximum torque: 10 Ncm.

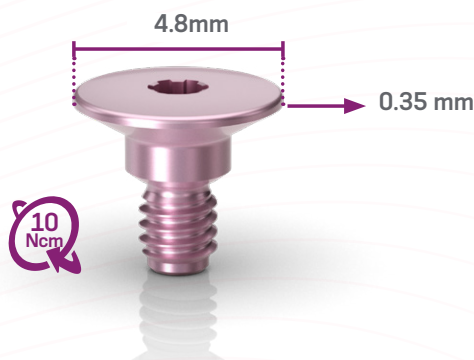

Neo Manual Medium Screwdriver

HS Healing abutment

Conventional loading – Healing Abutment

Neodent® Helix Short healing abutments are available in different gingival heights. This solution is designed to create a suitable gingival emergence profile, which adapts to the final abutments. The correct choice of this healing abutment establishes the adequate soft tissue healing process, maintaining the indicated biological distance. Use the Neo Screwdriver to place the healing abutment on the implant. Maximum torque: 10 Ncm.

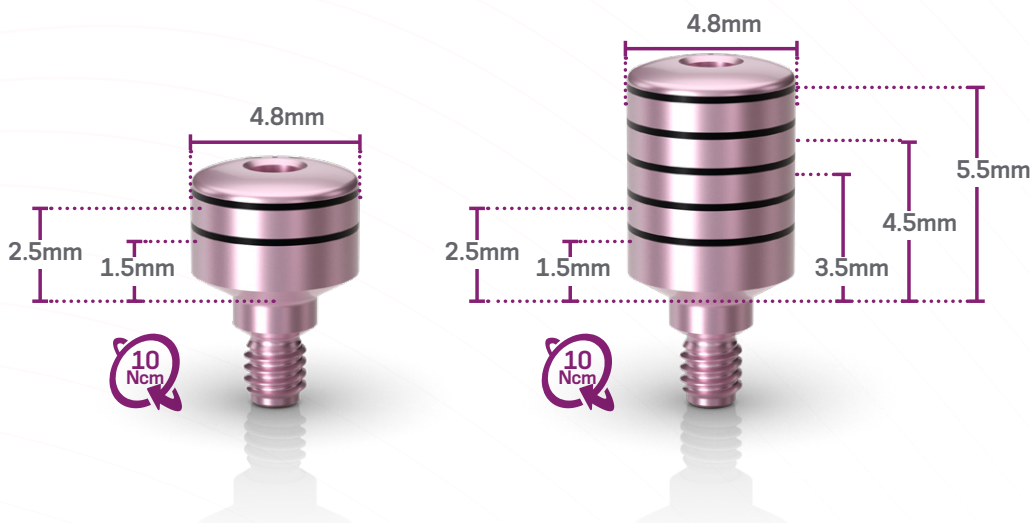

Neo Manual Medium Screwdriver

PROSTHETIC PROCEDURES

Immediate Loading

The implant's final placement torque determines the protocol. Correct and physiological occlusion is also determinant in the definition. The following criteria need to be observed when using an immediate loading protocol:

- Torque: 35 to \leq 60 Ncm;
- Healing Protocol: Immediate loading or selection of abutment;
- General characteristics:
 - > Lateral mechanical load on provisional crowns is contraindicated;
 - > Patients should present a balanced or physiological occlusion;
 - > Periodontally compromised patients should have their condition controlled prior to treatment, especially when a component is exposed to the oral environment.

Working model production

Intraoral scanning

The scanbody is used in implant or abutment level in order to transfer their positions following the scanning to use in CAD/CAM procedure.



Scanbody



Hybrid Repositionable Analog



Neo Manual Medium Screwdriver

To perform the intraoral scanning the dental surgeon should use the correct scanbody. Select correctly the indication, and material and specify which is the element implant related. Follow the step by step indicated by the scanner manufacturer. The digitalization of a scanbody has to copy as most details as possible and finalize the scan process following the software instructions.

The final scanning files should be sent to the CAD software (Chairside or send to a dental laboratory by CAD/CAM system) or e-mail. The laboratory will receive the final scanning files and will design [CAD software] the future prosthesis.

After that, the design will be transferred to the milling machine (CAM). Once the prosthesis is milled, the fit should be tried on the abutment.

Notes:

- The flat surface of the scanbody should be positioned towards the buccal aspect;
- Make sure that the scanbody is properly seated;
- Scanbodies with damaged implant platform may lead to digitalization problems
- After digitalization, design the prosthesis in the CAD software.

*Libraries are available for the following softwares: CARES Visual, Dental Wings Inc and 3Shape A/S at www.straumann.com/connectivity.html#download. Make sure that your CAD library is updated.



Extraoral scanning

Once the plaster model is made it can be scanned. This technique requires a plaster model scanner or a bench scanner. Neodent® Digital Solutions recommends the following scanners: Straumann Virtuo vivo and Dental Wings 7Series.



Scanbody



Hybrid Repositionable Analog



Neo Manual Medium Screwdriver

The steps set out by the scanner's manufacturer must be followed, the important thing is to scan the plaster model with and without the removable gum (usually carried out at different steps) and, to scan the scanbody of the implant or abutment in the right position.

The laboratory will receive the final scanning files and will design (CAD software) the future prosthesis. After that, the design will be transferred to the milling machine (CAM). Once the prosthesis is milled, the fit should be tried on onto the abutment.



Impression taking

The Impression Coping allows transferring, by means of impression, the tridimensional position of the Neodent® implants or abutments. The solution is for impression techniques with closed and open tray.



Neo Screwdriver



Helix Short Implant Impression Copings

Helix Short Analog



Helix Short Implant

Within the closed tray technique, a negative impression of the post is made using impression material. The impression coping is then removed from the oral cavity and adapted to the impression material in the tray.

- Place the Impression Coping on the implant or abutment with the Neo Screwdriver (maximum torque: 10 Ncm);
- Perform the impression;
- Place the Impression Coping and Hybrid Repositionable Analog on the mold.

Within the open tray technique, the body of the Impression Coping should be fit into the implant or abutment selected and rotate the screw manually or with the aid of the Torque Connection.

The transfers should be screwed out and removed from the patient's mouth with the impression material in the tray. Ensure that you do not move the Impression Coping while fitting of the analog.

- Place the Impression Coping on the implant or abutment;
- Perform the impression;
- Place the Hybrid Repositionable Analog on the mold.

After performing the impression:

- Ensure that the impression coping is correctly adjusted and positioned.
- Place the analog in the right position.
- Continue with placing the artificial gingiva and pouring the plaster mixture. Check if there are no bubbles and if all the details have been completely copied.
- Neodent® has developed a new generation of analogs, which can be used either in the conventional (plaster model) or the digital workflows (printed model), for prototyped models. They are called Hybrid Repositionable Analogs and are available for the Neodent® Helix Short portfolio.

HS Temporary Abutment for crown or for bridge

The Temporary Abutment is used for rehabilitation with single (anti-rotational) and multiple (rotational) provisional screw-retained prostheses.



Neo Screwdriver Torque Connection and Torque Wrench

This product can be used in two ways:

Follow these steps for outside patient's mouth workflow:

- After implant installation in the mouth, place the compatible impression coping and make an impression;
- The technician select the correspondent Helix Short Implant Analog and produce the plaster model in the laboratory;
- Screw the HS Temporary Abutment over the correspondent analog and customize it in accordance with the available interocclusal space;
- Prepare the temporary prosthesis(es);
- Test the passivity and the adaptation of the prosthesis(es);
- Before placing into the patient's mouth, it should be cleaned and sterilized. Follow this steps for cleaning and sterilization:
 - Immerse the piece completely in enzymatic detergent (diluted according to the manufacturer);
 - Wash in an ultrasound washer for approximately 10 to 15 minutes;
 - Rinse with plenty of distilled water, until the solution residues are completely removed. It is recommended to use nylon brushes.
 - Dry with a clean, dry cloth or with compressed air.
 - Conduct visual inspection, observing if there are any failures in the cleaning process. If there are still residues, the piece must be immersed in detergent again – first step- and, if necessary, the cleaning should be done with the aid of a nylon brush. Repeat the sequence of rinsing and drying.
 - After cleaning, the following sterilization methods are recommended: moist heat (steam) autoclave, gravity-displacement or dynamic-air-removal (fractionated vacuum) cycle, unwrapped, 3 minute exposure at 132 °C (270 °F). The product must be unwrapped on an appropriate tray. Use the sterilized restoration immediately after sterilization, do not store;
- Screw the prosthesis(es) in the mouth using the Neo Screw Driver Torque wrench with a torque of 20Ncm.
- Ensure that it fits perfectly on the abutment and that the prosthesis is not pressing on the periimplant tissue.

Follow these steps for inside patient's mouth workflow:

- After implant installation in the mouth, the HS Temporary Abutment can be screwed directly in the mouth, over the implant, as indicated, using the Neo Screw Driver Torque wrench with a torque of 20Ncm.
- Customize the abutment under abundant irrigation, in accordance with the interocclusal height;
- Prepare the temporary prosthesis(es) directly over it. Passivity and adaptation tests of the prosthesis(es) structure must be performed. During the preparation in mouth, it must be ensured that the material for temporary crown preparation does not leak into the adjacent tissues or implant.

Protect the access for the screw (with teflon and resin compound). Also check for a possible excess of cement/ resin.

Precaution: The Temporary Abutment can remain in mouth for a maximum of 180 days.

HS Exact Ti Base (for crown)

The Helix Short Implant Titanium Base is a prosthetic abutment that is placed over Neodent Helix Short implants to provide support for customized prosthetic restorations, such as copings and crowns. It is indicated for single-cemented or screw-retained applications in implants installed in the maxilla or mandible, it is provided straight/without angulation and must be used in this manner.

Titanium Bases have a conical seating and an internal thread to allow passage of the screw, making it easier to transfer into the mouth. It must be used with a Neo Screwdriver to apply an installation torque of 20 Ncm.

The Titanium Base Exact have three locks with anti-rotational function to restrict crown rotation, micro helical grooves to increase retention and optimize cementation, and a guide groove for cutting to reduce the cementation height from 6.0 to 4.0 mm. Customization must be performed with a cutting disc in a laboratory. Cut along the groove on the upper end of the base. Remove the entire groove area and everything above it.



Warning, implants associated to Titanium Bases on angled prosthesis structures are recommended as per the following table:

Implant Ø (mm)	3.75	3.75	4.0	5.0	6.0	7.0
Mouth region for installation	1-5	6-8	1-8	1-8	1-8	1-8
Maximum angulation of the prosthetic structure	30°	30°	30°	30°	30°	30°
IPS e.max CAD HT	✓		✓	✓	✓	✓
IPS e.max CAD LT	✓		✓	✓	✓	✓
IPS e.max CAD MO	✓		✓	✓	✓	✓
³ M ESPE Lava Plus Zirconia	✓		✓	✓	✓	✓
Zirconia Zerion LT	✓		✓	✓	✓	✓
Zirconia Zerion GI	✓		✓	✓	✓	✓
Zirconia Zerion UTML	✓		✓	✓	✓	✓
Zirconia Zerion ML	✓		✓	✓	✓	✓
Polycon ae ¹	✓	✓	✓	✓	✓	✓
Coron (CoCr)	✓	✓	✓	✓	✓	✓
Ticon	•	•	•	•	•	•

¹ Polycon ae material is only recommended for temporary/provisional prosthetic restorations.

please refer to the IFU at ifu.neodent.com.br/en

Coping/crown manufacture by CAD/CAM technology

Make the Coping/Crown using CAD software in accordance with the dimensions of the chosen Titanium Base and the software manufacturer's instructions. Always finalize the Coping/Crown before cementing on the Titanium Base. During digital workflow, use the "Neodent Implant — Titanium Base" library with a compatible software platform to make the interface design between the Titanium Base and the Coping/Crown more precise. This library consists of a set of 3D files that contain the milling matrix needed for the Coping/Crown geometry.

Note:

The minimum wall thickness varies according to the material, as shown in the table below. The conicity of the structure must not exceed 8°. In case of angled structures, the maximum total height of the cemented restoration over the Titanium Base must not exceed 10 mm.

The minimum wall thickness varies according to the material, as described in the table below:

Prosthetic interface	Material	Format	Minimum thickness (mm)
Helix Short	Cobalt-Chromium (Coron)	Rotational / Anti-rotational	0.3
	Titanium (Ticon)	Rotational	0.4
	IPS e.max CAD	Anti-rotational	0.9
	Zerion LT	Rotational / Anti-rotational	0.5
	Polycon ae ¹	Rotational / Anti-rotational	1.0

¹ Polycon ae material is only recommended for temporary/provisional prosthetic restorations.

ifu.neodent.com.br/en

Conventional Workflow

The burn-out coping must be used for the conventional workflow. After installing the implant in the mouth, transfer its position through molding with the aid of the corresponding impression coping, according to appropriate techniques. Fit the Coping on the Base and execute the wax-up. The model obtained must be immersed in a coating compatible with the alloy which will be used in the casting process. The structure thereby obtained will be the basis for the acrylization or porcelain application. Adaptation tests of the prosthesis structure must be executed.

Cementation

The Base must be used in laboratory procedures in accordance with the following instructions: Place the abutment over the plaster model and gently tighten the clamping screw over it using the Digital Driver.

Protect the screw access during the cementation process. Follow the cement manufacturer's instructions for use when handling the cement. Apply the cement to the external part of the Titanium Base for Helix Short implants and press the restoration by fitting it according to the three indexing guides.

Press the restoration over the Titanium Base and immediately remove the excess cement that seeps out of the orifice. After the cement has set, unscrew the Analog infrastructure and remove the remaining excess cement at the edge of the Base.

After these procedures, place the set in the mouth using the implant driver/connection and torque recommended.

Intraoral



HS Implant Scanbody



HS Hybrid Analog



Model Scanning



HS Implant Exact Impression Coping Closed and Open Tray



HS Implant Scanbody



HS Exact Titanium Base for Crown



1



Neo Screwdriver Torque Connection



Torque Wrench

2



Neo Screwdriver Torque Connection



Manual Screwdriver Torque

Conventional



HS Implant Exact Impression Coping Closed and Open Tray



HS Hybrid Analog



HS Exact Titanium Base for Crown



Titanium Base Burn-out Coping



HS Ti Base for Bridge (Rotational)

The HS Titanium Base for Bridge is intended for use in multiple (rotational) screw-retained prosthetic structures compatible with Helix Short implants. It provides support for customized prosthetic structures in the digital workflow. All Titanium Bases have a conical seating and an internal thread to allow passage of the screw, making it easier to transfer into the mouth. It must be used with a Neo Screwdriver to apply an installation torque of 20 Ncm.

Rotational Bases have a conical upper portion and helical micro grooves to increase mechanical retention and optimize cementation. The cementation area height is 4.5 mm and the angulation is 16°.

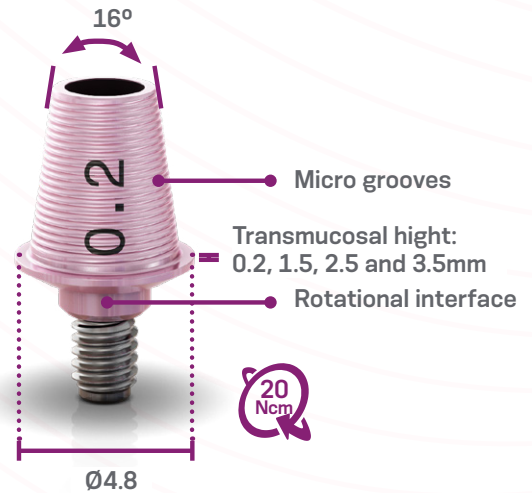

Multiple structure manufacture by CAD/CAM technology

Make the Multiple Structure using CAD software in accordance with the dimensions of the chosen Titanium Base and the software manufacturer's instructions. Always finalize the Multiple Structure before cementing on the Titanium Base. During digital workflow, use the "Neodent Implant — Titanium Base" library with a compatible software platform to make the interface design between the Titanium Base and the Multiple Structure more precise. This library consists of a set of 3D files that contain the milling matrix needed for the Multiple Structure geometry.

Note:

The minimum wall thickness varies according to the material, as shown in the table below. The conicity of the structure must not exceed 8°. In case of angled structures, the maximum total height of the cemented restoration over the Titanium Base must not exceed 10 mm.

The minimum wall thickness varies according to the material, as described in the table below:

Prosthetic interface	Material	Format	Minimum thickness (mm)
Helix Short	Cobalt-Chromium (Coron)	Rotational / Anti-rotational	0.3
	Titanium (Ticon)	Rotational	0.4
	IPS e.max CAD	Anti-rotational	0.9
	Zerion LT	Rotational / Anti-rotational	0.5
	Polycon ae ¹	Rotational / Anti-rotational	1.0

¹ Polycon ae material is only recommended for temporary/provisional prosthetic restorations.

Cementation

The Base must be used in laboratory procedures in accordance with the following instructions: Place the abutment over the plaster model and gently tighten the clamping screw over it using the Digital Driver.

Protect the screw access during the cementation process. Follow the manufacturer's instructions for use when handling the cement. Apply the cement to the external part of the Titanium Base for Helix Short implants and press the restoration by fitting it according to the three indexing guides.

Press the restoration over the Titanium Base and immediately remove the excess cement that seeps out of the orifice. After the cement has set, unscrew the Analog infrastructure and remove the remaining excess cement at the edge of the Base.

After these procedures, place the set in the mouth using the implant driver/connection and torque recommended.

Intraoral

Model Scanning



HS Exact Titanium Base for Bridge



- 1 Neo Screwdriver Torque Connection + Torque Wrench
- 2 Neo Screwdriver Torque Connection + Manual Screwdriver Torque

HS Mini Conical Abutment and HS Mini Conical Abutment 17°

They must be installed between the implant and the prosthesis (bridge), and are intended for use in multiple prosthetic structures with screw-retained abutments. They come in different gingival heights and are suited for gingival thickness variations.

The Straight Mini Abutments consist of a single body with a rotational interface that is compatible with the interface of Helix Short Implants.

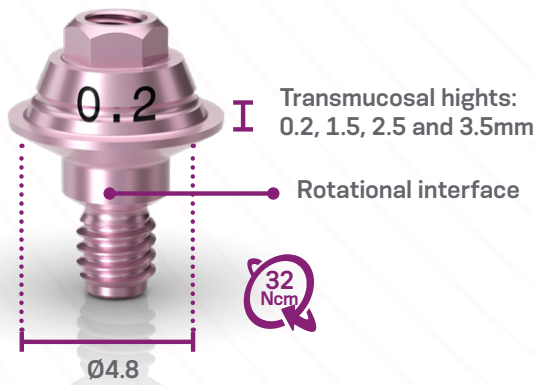

Hexagonal Prosthetic Driver and Torque Wrench

The Mini Angled Abutments consist of two parts, an abutment with a 17° angulation and a removable screw. Their anti-rotational interface is compatible with the interface of Helix Short Implants.

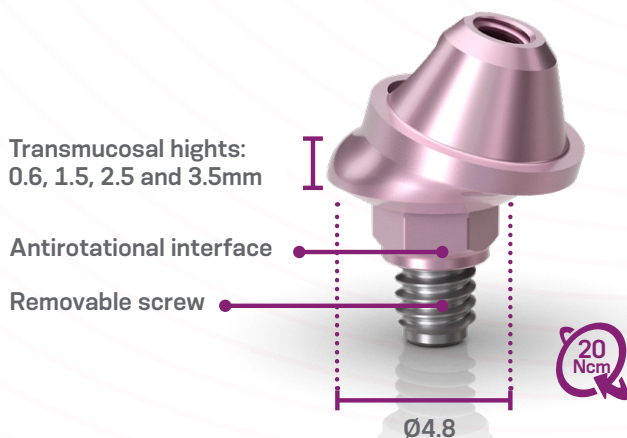

Neo Screwdriver Torque Connection and Torque Wrench

The geometrical structure in the upper portion allows for the fitting of the transfer for molding, the provisional abutment coping for provisional prosthesis, the protection cylinder, and the final prosthesis.

Select the prosthetic abutment according to the plan and install it over the implant using the recommended torque and connection (see the table below). Make sure it fits properly and install the appropriate Protection Cylinder.

For the molding procedure, attach the corresponding Transfer onto the abutment. Make sure that they fit correctly and perform the molding using the appropriate materials. Prepare the plaster model. Make the prosthesis using the Cylinders following the appropriate laboratory techniques. Passivity and prosthesis structure adaptation tests and exams must be performed.

To install the prosthesis, remove the Protection Cylinder and install with the indicated torque over the prosthetic abutment. Protect the screw access (with Teflon and resin compound). The screw torque is 10 Ncm.



1
32 Ncm
HS Mini Conical Abutment



2
20 Ncm
HS Mini Conical Abutment 17°

Intraoral



Model Scanning



Conventional



1



Hexagonal Prosthetic Driver

+



Torque Wrench

2



Neo Screwdriver Torque Connection

+



Torque Wrench

3



Neo Screwdriver Torque Connection

+



Manual Screwdriver Torque

HS TIN Attachment

The Attachment TIN abutments are recommended for removable prostheses retained by attachments, known as overdentures. The Neodent® system of overdenture over-attachment is contraindicated in cases in which the angulation between the implants or abutments exceeds 40°.



Neo Screwdriver Torque Connection and Torque Wrench

Follow these steps to use the HS TIN abutments with overdenture:

- Ensure that the implant is not covered by hard or soft tissue and define the appropriate abutment based on the height markings on the HS Height Measurer.
- Place the TiN Attachment HS implant using the Neo Screwdriver Torque Connection with 20 Ncm;
- Place the Forming/Fixing Matrix on the TiN Attachment;
- Use the mucodynamic technique for impression taking (vinyl polysiloxane or polyether rubber).

Send the impression to the dental lab;

- Insert the Novaloc Model Analogs into the Forming/Fixing Matrix and Pour the plaster on the mold according to appropriate techniques;
- After the plaster setting phase, separate the impression and place white Mounting Collars on the Analogs;
- Place the Matrix Housing including preassembled Mounting Insert onto the Novaloc Abutments.

Note: for a chairside polymerization of the matrix housing use the processing spacer to create the space needed;

- Process the overdenture according to standard procedures;
- The dental lab will return the finalized overdenture to the dental office including the mounting inserts in place;
- Remove all mounting inserts from the matrix housing using the blue demounting tool for mounting inserts;
- Select the appropriate retention insert. Insert the retention inserts to the matrix housing using the mounting and brown demounting tool for retention inserts;
- Seat the finished overdenture and check the occlusion.



HS TIN Attachment



Forming/Fixing Matrix



Attachment Analog



Mounting Collar



Matrix Housing



Mounting Collar



Titanium



PEEK



Retention Insert

-  Red (approx. 300 g)
-  Green (approx. 1650 g)
-  White (approx. 750 g)
-  Blue (approx. 2100 g)
-  Yellow (approx. 1200 g)
-  Black (approx. 2550 g)



Final restoration



— Accessories —



Equipment Box



Processing Spacer



Mounting Insert



Matrix Housing Extractor



Mounting and Demounting Tool for Retention Inserts



Demounting Tool for Mounting Inserts for Analogs

REFERENCES

- [1] Block MS, Haggerty CJ, Fisher GR. Nongrafting implant options for restoration of the edentulous maxilla. *J OralMaxillofac Surg* 2009;67:872–881.”
- [2] Esposito M, Cannizarro G, Soardi E, Pellegrino G, Pistilli R, Felice P. A 3-year [1]post-loading report of a randomized controlled trial on the rehabilitation of posterior atrophic mandibles: Short implants or longer implants in vertically augmented bone? *Eur J Oral Implantol*. 2011;4:301–11.
- [3] Derks J, Schaller D, Hakansson J, Wennstrom JL, Tomasi C, Berglundh T. Effectiveness of Implant Therapy Analyzed in a Swedish Population: Prevalence of Peri-implantitis. *J Dent Res* 2016;95:43-49.
- [4] Internal Survey for customers conducted by Neodent Marketing Team
- [5] Delphi Study – Horizon 2030 – Identifying and Predicting Future Trends in Implant Dentistry in Europe
- [6] Gil MS, Ishikawa-Nagai S, Elani HW, Da Silva JD, Kim DM, Tarnow D, Schulze-Späte U, Bittner N. A prospective clinical trial to assess the optical efficacy of pink neck implants and pink abutments on soft tissue esthetics. *J Esthet Restor Dent*. 2017 Nov 12;29(6):409-415.
- [7] Yeo IS, Kim HY, Lim KS, Han JS. Implant surface factors and bacterial adhesion: a review of the literature. *Int J Artif Organs*. 2012 Oct;35(10):762-72.
- [8] Novellino MM, Sesma N, Zanardi PR, Laganá DC. Resonance frequency analysis of dental implants placed at the posterior maxilla varying the surface treatment only: A randomized clinical trial. *Clin Implant Dent Relat Res*. 2017 Jun 20. doi: 10.1111/cid.12510. [Epub ahead of print]
- [9] Sartoretto SC, Alves AT, Resende RF, et al. Early osseointegration driven by the surface chemistry and wettability of dental implants. *J Appl Oral Sci*. 2015 May-Jun;23(3):279-87.
- [10] Sartoretto SC, Alves AT, Zarranz L, et al. Hydrophilic surface of Ti6Al4V-ELI alloy improves the early bone apposition of sheep tibia. *Clin Oral Implants Res*. 2016 Jun 17. doi: 10.1111/clr.12894. [Epub ahead of print]
- [11] Val JE, Gómez-Moreno G, Ruiz-Linares M, et al. Effects of Surface Treatment Modification and Implant Design in Implants Placed Crestal and Subcrestally Applying Delayed Loading Protocol. *J Craniofac Surg*. 2017 Mar;28(2):552-558.

© 2023 - JJGC Indústria e Comércio de Materiais Dentários S.A. All rights reserved. Reproduction without prior permission is forbidden.

Some products may not be available for purchasing yet. For more informations, please contact your local distributor.

Neodent, Acqua, are trademarks or registred trademarks of JJGC Indústria e Comércio de Materiais Dentários S.A.

NUOVI SORRISI OGNI GIORNO

CHAQUE JOUR DE NOUVEAUX SOURIRES

новые улыбки каждый день

JEDEN TAG EIN NEUES LÄCHELN

NUEVAS SONRISAS TODOS LOS DIAS

NYA LEENDEN VARJE DAG

 **straumann**® *NEW SMILES EVERY DAY*

Straumann North American Headquarters

Straumann USA, LLC

60 Minuteman Road

Andover, MA 01810

Phone 800/448 8168 (US) • 800/363 4024 (CA)

Fax 978/747 2490

www.straumann.us • www.straumann.ca

NOVOS SORRISOS TODOS OS DIAS

CHAQUE JOUR DE NOUVEAUX SOURIRES

USLIT.2194 11/23 V1 PMR

© Neodent® 2023. All rights reserved.

Neodent® and/or other trademarks and logos from Neodent® that are mentioned herein are the trademarks or registered trademarks of Straumann Holding AG and/or its affiliates.

All rights reserved.

ifu.neodent.com.br/en

www.neodent.us • www.neodent.ca

 **NEODENT**®
A Straumann Group Brand