

Order #:		Date:	
Name:	Phone #:	Email:	
Bill to:			
Account #:		Company name:	
Street:		Street 2:	
City:	Province:	Postal:	
Ship to:			
Account #:		Company name:	
Street:		Street 2:	
City:	Province:	Postal:	
Name:	Phone #:	Email:	
Notes:			

STANDARD EQUIPMENT (Circle size and choose options below)









- Frame with castors and brakes
 - Footrest with feet stabilizing belts
 - Seat
 - Seat cushion
 - Abduction block
 - Backrest
 - Backrest cushion
 - Independently adjustable chest and pelvic supports
 - 4 points safety vest ("hold & pull" system)
 - Breathable upholstery ATMO™
- SIZE 1 GRASS,
SIZE 2 SEA,
SIZE 3 LATE.









Size 1: \$1,743

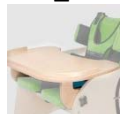

Size 2: \$1,843

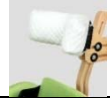
Size 3: \$1,941

ACCESSORIES

CATEGORY	SYMBOL	EQUIPMENT	PIECES	QTY	
SAFETY	SLK_002 	Belt for moving patients AM-P - Robust and ergonomic design as well as high durability facilitates daily care of the patient.	1	\$312	
	SLK_003 	Soft cover for tray - Soft cover protects the user from being hit by the tray. Indicated for patients with impaired limbs coordination.	1	\$327	
		Tango wheels are noise-free, maintenance-free, non-marking and do not corrode.			
	SLK_015	TANGO Wheel with brake (75 mm) (I)		1	\$126
		TANGO Wheel with brake (75 mm) (A)			\$186
	SLK_016	TANGO Wheel with brake (125 mm) (I)		1	\$178
		TANGO Wheel with brake (125 mm) (A)			\$219
	SLK_020	TANGO Wheel with brake (100 mm) (I)		1	\$152
TANGO Wheel with brake (100 mm) (A)		\$201			
POSITIONING	SLK_101 	Thigh abduction belts - Can easily be attached to the chair by use of Velcro straps. Helps position legs in abduction and prevents the patient from sliding.	1	\$256	
	SLK_102 	Head supporting belt - Attachable to the headrest by use of Velcro straps. Indicated for people with muscle weakness to prevent falling of the head.	1	\$163	
	SLK_104 	HexagonPro Headrest™ - Individual “ladyfingers” on the Hexagon Pro™ are adjusted to cushion and support any head position. It has been designed to create the most comfort for user by supporting and protecting their head. Available in many sizes and colours. It is a new version of Hexagon™ headrest equipped with hardware that allows precise adjustment of the headrest.	1	\$446	
	The H Harness provides trunk stability. HOLD&PULL© system makes it easier to adjust the vest to the patient body. You can quickly detach the vest if necessary.				
	SLK_114	H Harness ('hold & pull' system) (I)		1	\$238
		H Harness ('hold & pull' system) (A)			\$137
	SLK_123 	Adjustable extended headrest (I)		1	\$238

	6 points safety vest provides a highly adjustable trunk stabilizer. HOLD&PULL© system makes it easy to adjust the vest to the patient's body.			
		6 points safety vest – S/M/L/XL (I)	1	\$283
		6 points safety vest – S/M/L/XL (A)		\$377
	New version of Hexagon Pro™ BodyMap headrest with Hexagon Pro™ and BodyMap cushion. Such a combination provides a perfect stable fit of the patient's head.			
BODYMAP POSITIONING		HexagonPro™ BodyMap® Headrest DZ – Sz 1	1	\$1,196
		HexagonPro™ BodyMap® Headrest DZ – Sz 2		\$1,286
		HexagonPro™ BodyMap® Headrest DZ – Sz 3		\$1,406
COMFORT		Tray for manual therapy (1) - Allows for active exercises assisting upper limbs with a particular focus on palm function.	1	\$826
		Tray - Tray made of ecological wood. Great for therapy, daily activities and meals.	1	\$396
		Tray for nonverbal communication (1) - Set consists of 38 cards that may be put in random order into 24 places of the tray. It is covered with transparent and aesthetic plate made of Plexiglas®. Parents and child can create their own symbols they believe are significant for their communication.	1	\$1,247
		Headrest cotton cover - Helps keep the headrest clean. Easy to assemble/disassemble. Can be washed.	1	\$30
			2	\$52
		Elastico seat cushion - Precisely adapts to the patient's body. Made of memory foam covered with breathable and spatial fabric. It is indicated in anti-bedsore prophylaxis.	1	\$256
		Elastico backrest cushion - Perfectly adapts to the patient's body. Made of dense shape memory foam covered with breathable and spatial fabric. It is indicated in anti-bedsore prophylaxis.	1	\$282
		Shaped seat cushion (pommel shape)	1	\$327
	Shaped seat cushion (thigh shape)	1	\$212	

	<p>SLK_429</p> 	<p>Soft footrest cover</p> <p>- Comfortable pad that protects the feet from direct contact with the footplate</p>	1	\$230
STORAGE	<p>SLK_507</p> 	<p>Oxygen tank holder</p> <p>- Oxygen tank case can be attached to the stroller by use of Velcro straps with adjustable length. Made to measure to perfectly fit the patient's oxygen tank.</p>	1	Price depends on tank size
SPARE PARTS	<p>- Waterproof upholstery Hydro™ is made of soft and comfortable material resistant to water and moisture. This upholstery is very durable and easy to clean and disinfect. This makes it perfect for indoor use when eating and drinking fluids, and outdoors during unfavorable weather conditions such as rain or snow. Hydro™ is made of environmental friendly ecological materials.</p> <p>- Medical upholstery Medicus™ is made of a waterproof material that ensures moisture circulation (vapor permeability). Medicus™ is hypoallergenic (safe for allergy sufferers), prevents angers and bedsores. Upholstery is very durable and easy to clean and disinfect. This makes it perfect for using at home during daily activities such as eating and drinking. Medicus™ meets the requirements for medical devices so it is recommended to use in health care centers.</p> <p>- Extreme-Med™ is high advanced medical upholstery. It is vinyl fabric with a lot of certificated, e.g. flammability test CRIB7 and Moist-Heat Resistant Tropical Test. Furthermore, Extreme-Med™ is also abrasion resistant, what is confirmed by Martindale test (500k cycles). The fabric is very durably, flame retardant and can be used in every kind of weather. Upholster is safe for patient: does not contain phthalates, is hypoallergenic, protects against the moulds, bacetrias and dermatophytosis. The fabric is very easy to clean and maintain. Using the special PCV layer, material does not absorb liquids and other stains. Extreme-Med™ meets the requirements for medical devices so it is recommended to use in health care centers.</p>			
	SLK_700	Waterproof upholstery HYDRO™(I)	1	\$223
	SLK_720	Breathable upholstery ATMO™ - GRASS, SEA, LATTE (I)	1	\$0
		Breathable upholstery ATMO™ - RED(I)	1	\$242
	SLK_725	Medical upholstery MEDICUS™ (I)	1	\$279
	<p>SLK_728</p> 	<p>4 points safety vest</p> <p>- Acts as a torso stabilizer. It has a large adjustment range, which facilitates its adjustment. Equipped with the CHUCK AND COMBINE® system.</p>	1	\$245
	SLK_739	Medical upholstery EXTREME MED™(I)	1	\$297

COLOURS

More about our upholsteries you can find [here](#)

BREATHABLE UPHOLSTERY ATMO™



BREATHABLE



ANTIALLERGIC



EASY TO CLEAN



REDUCED ENVIRONMENT
IMPACT

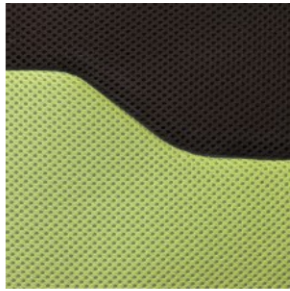

Grass
Size 1

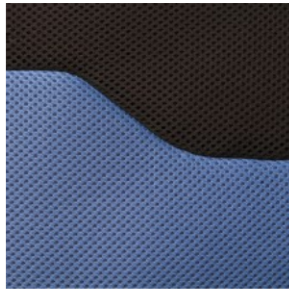

Sea
Size 2

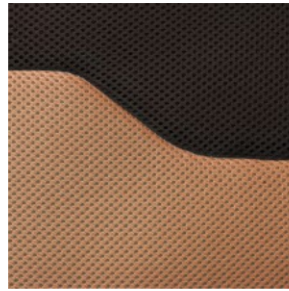

Latte
Size 3



Red
*Optional

WATERPROOF UPHOLSTERY HYDRO™



EASY TO CLEAN



WATER RESISTANT



REDUCED ENVIRONMENT
IMPACT



HIGH DURABILITY



Green Grass
*Optional



Blue Sea
*Optional



Brown Sugar
*Optional



Hot Red
*Optional

MEDICAL UPHOLSTERY – EXTREME MED™



PHTHALATE FREE



ANTIMICROBIAL &
ANTIFUNGAL



CR17



STAIN RESISTANT



ABRASION



REDUCED ENVIRONMENT
IMPACT



TROPICAL TEST



Citrus Green
*Optional



Candy
*Optional

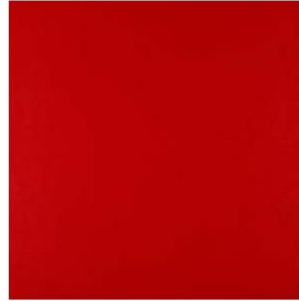

Pillarbox
*Optional

MEDICAL UPHOLSTERY – MEDICUS™



WATER RESISTANT



STEAM PERMEABLE



FIRE RETARDANT



REDUCED ENVIRONMENT
IMPACT



Med Sea
*Optional



Med Skin
*Optional



Med Blue
*Optional

*Optional colors available for special request. Production time ca. 14 days.

Real upholstery colors may differ from the presented images.

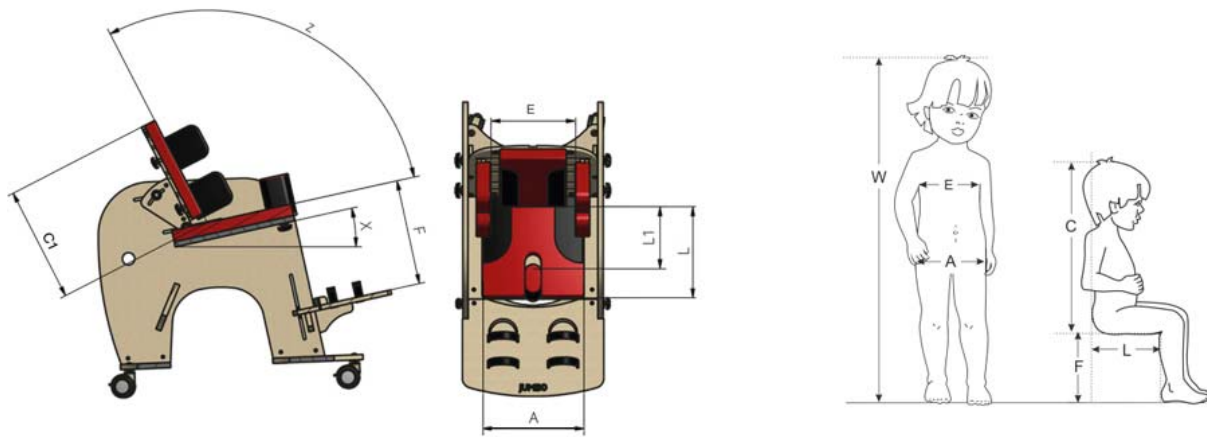

Symbol	Measurement	Unit	Size 1	Size 2	Size 3
W	Indicative user height*	[cm]	70 – 130	100 – 150	110 – 180
A	Seat width	[cm]	35	39	46
L	Seat depth	[cm]	13 – 31	19 – 38	29 – 54
C	headrest height (optional)	[cm]	54	58	75
C1	Backrest height	[cm]	34	38	55
E	Backrest width	[cm]	17 – 27	22 – 32	22 – 35
F	Foot length adjustment	[cm]	18 – 35	24 – 45	28 – 45
L1	Seat depth to the abduction block	[cm]	0 – 24	3 – 29	8 – 45
	Footer length	[cm]	19	25	26
X	Seat tilt angle	[°]	10	10	10
Z	Backrest tilt angle	[°]	90 – 110	90 – 110	90 – 110
	Max. user weight	[kg]	30	45	75

Note: Measurement tolerance range is +/- 1 cm / ½ in.

*The value cannot be main factor for selection of product size