



JUMBO™

POSITIONING CHAIR



USER MANUAL

Our passion - your independence!

AKCESMED[®]



CAUTION! Manufacturer takes responsibility for proper usage of the device only when the product was purchased from qualified Akces-Med employee or at specialized medical store!

CAUTION! AKCES-MED Ltd. reserve the right to introduce technical and trading changes in the content of the instruction without warning.

Medical product first class according to the Regulation 93/42/EWG of European Parliament and Council regarding medical products. For this product the producer issued relevant declaration of conformity.

Akces-Med. Sp. z o.o. Company introduced quality management system ISO 13485 regarding production, sales and service. The system is certified by Det Norske Veritas.





CONTENTS

- 1. The purpose of user manual.....5
- 2. Indications for use.....5
- 3. General characteristics of chair.....6
 - 3.1 Standard equipment.....6
 - 3.2 Additional equipment.....7
- 4. Size table.....9
- 5. Detailed description how to use chair.....10
- 6. Additional equipment.....12
 - 6.1 Head stabilizing belt.....12
 - 6.2 H harness.....12
 - 6.3 Cover for headrest.....12
 - 6.4 Tray.....13
 - 6.5 Soft cover for tray.....13
 - 6.6 Tray for manual therapy.....14
 - 6.7 6 points harness.....14
 - 6.8 Adjustable headrest.....15
- 7. The use of chair.....16
 - 7.1 Preparation of the patient.....16
 - 7.2 How to use chair.....17
 - 7.3 Sitting position.....18
- 8. Safety rules.....20
- 9. Maintenance and cleaning23
- 10. Labelling.....25



INTRODUCTION

Taking sitting position by disable child from early stage of life is the significant part of the rehabilitation process. It has very important, positive influence on child's development and improvement of motor skills. Independent, safe sitting of a child that has lost the ability of independent locomotion as a result of illness or accident, has positive influence of patient' as well as care people psyche.

JUMBO™ is a device designed to be used in the process of daily rehabilitation of patients with illness which makes independent sitting or standing impossible. Usage of wood, colorful upholstery, bright colors and figure of elephant make the chair more a toy for children than a rehabilitation device.

It is a universal device; flaccid children as well as children with muscle tone and spastic children can be sited in it. The device improves comfort of life of the child and child's family

Remember to read this user manual carefully. You will find not only useful information but also guidelines regarding safe and effective use of the product.

If you have any questions or remarks, do not hesitate to contact our medical consultant (ph. 508 382 509) or directly AKCES-MED Sp. Z o.o. (ph. 17 864 04 70).



CAUTION! Before using the product, user is obliged to familiarize himself/herself with user manual. Remember that complying with guidelines is highly important. It assures safety and extends durability as well as aesthetics of the device.





1 THE PURPOSE OF USER

The present user manual contains basic information which is essential for proper usage, preparation, maintenance, cleaning and guarantee conditions regarding **JUMBO™** positioning chair.

User manual should be kept in easily accessible place. It is designed for people who look after disabled children, and for both doctors as well as physiotherapists who operate the device.



CAUTION! Before using the product, user is obliged to familiarize himself/herself with user manual.

Remember that complying with guidelines is highly important. It assures safety and extends durability as well as aesthetics of the device.

2 INDICATIONS FOR USE

The device is recommended for people in the following cases:

- Cerebral palsy – various types and forms.
- Brain and spinal cord injuries with lower limbs paralysis and weakness, balance and motor coordination disorders with different etiology.
- Demyelinating disease (e.g. multiple sclerosis - SM).
- Meningocele.
- Muscles diseases with weakness and paralysis (dystrophy, myasthenia gravis, myositis).
- Genetic disorders.
- Degeneration and neurological diseases.
- Other condition connected with muscles weakness, paralysis and musculoskeletal disorders.
- After head and spinal cord injuries and spine trauma with paralysis and paresis.





3 GENERAL CHARACTERISTICS OF CHAIR

3.1. Standard equipment

1. Frame with castors and brakes
2. Seat cushion
3. Backrest cushion
4. Independently adjustable chest supports
5. Independently adjustable pelvic supports
6. Hold&Pull vest
7. Abduction block
8. Foot rest with feet stabilizing belts





3.2. Additional equipment

 <p>Safety</p> <p>SLK_002 Belt for moving the patients AM-P</p>	 <p>SLK_003 Soft cover for tray</p>	 <p>Stabilization</p> <p>SLK_101 Abduction-adduction thigh belts</p>
 <p>SLK_102 Head supporting belt</p>	 <p>SLK_104 Adjustable headrest</p>	 <p>SLK_114 H Harness</p>
 <p>SLK_123 Extended headrest</p>	 <p>SLK_125 6 points safety vest</p>	 <p>Comfort</p> <p>SLK_401 Tray for manual therapy</p>
 <p>SLK_403 Tray</p>	 <p>SLK_407 Tray for nonverbal communication</p>	 <p>SLK_410 Headrest cotton cover</p>
 <p>SLK_412 Elastico cushion seat</p>	 <p>SLK_413 Elastico cushion backrest</p>	 <p>SLK_419 Seat cushion (pommel shape)</p>



SLK_421 Seat cushion (thighs shape)



SLK_427 Tango Wheel

 Storage



SLK_507 Oxygen tank holder





4 SIZE TABLE

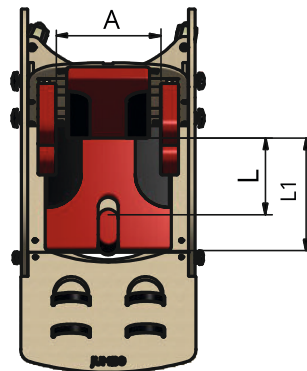
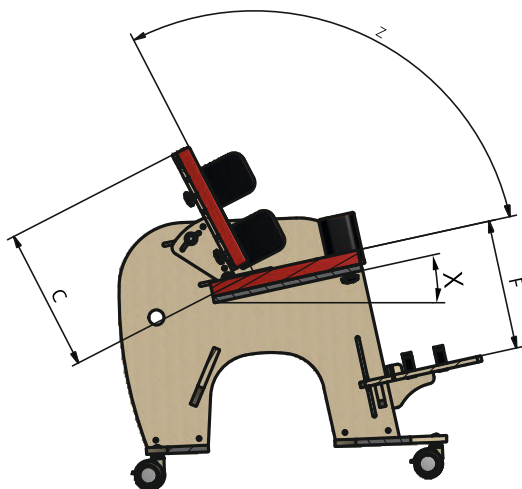

Symbol	Measurement	Unit	Size 1	Size 2	Size 3
A	Seat width	[cm]	35	39	46
L	Seat depth	[cm]	13-31	19-38	29-54
L1	Distance from pommel to back rest	[cm]	0-24	3-29	8-45
C	Backrest height	[cm]	34	38	55
E	Backrest width	[cm]	17-27	22-32	22-35
F	Footrests length	[cm]	18-35	24-45	28-45
	Footplate length	[cm]	19	25	26
X	Seat tilt angle	[°]	10	10	10
Y	Backrest tilt angle	[°]	100-125	100-125	100-125
	Maximum user weight	[kg]	30	45	75

Weight and dimensions of the device		Size 1	Size 2	Size 3
Width	[cm]	50	56	60
Length	[cm]	82	100	120
Height	[cm]	76	95	105
Weight	[kg]	14	20	24,5

Note: Dimensional tolerance in the table is +1/-1 cm.





5 DESCRIPTION HOW TO USE CHAIR

A. The adjustment of headrest - additional equipment. It is possible to have top-bottom adjustment and, moreover, headrest can be adjusted at any tilt angle.

B. The adjustment of backrest tilt angle - backrest tilt angle depends on the type on dysfunction

C. The adjustment of seat depth - loosen knob in order to adjust the depth of seat. The possibility of front-back adjustment

D. The adjustment of table - additional equipment. The possibility of front-back adjustment. It is possible to adjust table at any tilt angle.

E. The adjustment of footrest height - The possibility of top-bottom adjustment. It is necessary to adjust the height of footrest so as that thighs rest on the seat.

F. The adjustment of abduction block - The possibility of front-back adjustment. Abduction block prevents from falling out from the chair.





G. The adjustment of chest pelottes -

The possibility of side adjustment. It is also possible to adjust pelottes at any tilt angle. The adjustment of pelottes should be done according to the measurements of patient's chest.

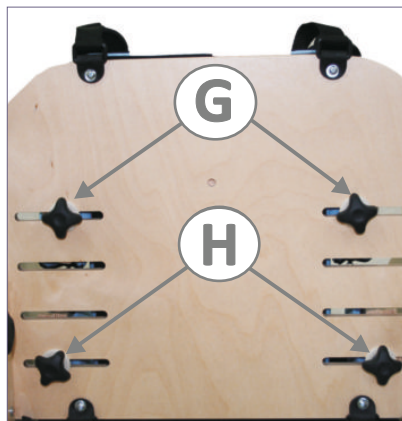

H. The adjustment of pelvic pelottes -

The possibility of side adjustment. It is also possible to adjust pelottes at any tilt angle. The adjustment of pelottes should be done according to the measurements of patient's hips.

I. Vest

Connect clamps from vest with clamps from adjustable belts that are fastened both at the bottom and top of backrest (4 pcs.). Next, adjust vest to patient's body with the aid of belts.



It is highly important to adjust properly vest due to the fact that it protects the patient from falling out of the chair and, moreover, patient can move without freely.

Vest is equipped with "hold&pull" system thanks to which all elements are precisely adjusted to patient. This system is helpful because the product is stable and child feels comfortable while sitting in this device.





6 ADDITIONAL EQUIPMENT

6.1. **REF SLK_102** Head stabilizing belt

Please follow these steps so as to mount head stabilizing belt:

- fasten belt to lateral parts of headrest with the aid of Velcro tape,
- adjust the length of belts to patient,
- pull belts so as to check if they are correctly mounted.



6.2. **REF SLK_114** H Harness

Please look at point I so as to find out how to assembly vest (@page 10). Initially, patient should not adjust vest tightly. Once vest is put on, it should be fastened with the aid of belts with plastic straps. Vest can be quickly unfastened.



6.3. **REF SLK_410** Cover for headrest

Cover is made of cotton and it should be put on headrest. Regarding material, it has some bands thanks to which material does not slip down.





6.4. **REF SLK_403** Tray

Please follow these steps so as to mount tray:

- loosen knob D which adjusts tray (**look page 10, adjustment D**);
- insert tray in a way that its grips are situated between chair's side and cup;
- tighten firmly knobs.



6.5. **REF SLK_003** Soft cover for tray

Please follow these steps so as to mount soft cover for tray:

- Adhere 5 adhesive Velcro tapes;
- Put soft cover in a way that its edges cover tray edges.





6.6 REF SLK_401 Tray for manual therapy

Tray for manual therapy is mounted instead of standard tray. If you want to mount it, please follow instructions - page 11.



6.7 REF SLK_125 6 points harness

In order to mount 6 points vest it is necessary to:

- points vest should be put on and then it is important to fasten zipper and buckle at the front of vest;

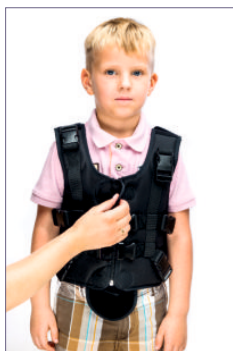

- Adjust vest with the aid of Velcro tapes situated at the back of vest.
- 6 points vest should be fastened in a place that is created for standard vest (®look page 10). So as to fasten it, use not only buckles but also fastening belt that should be threaded behind chair's backrest and fastened at the front of vest.





6.8 REF SLK_104 Adjustable headrest

6.8.1. Disassembly of the plug

To remove the plug you must:

- unscrew two screws (J) with the allen key, and next:
- remove the cap and install the headrest.



6.8.2. Assembly of headrest:

It is necessary to mount headrest to backrest with the aid of two screws together with cups. Screws should be tightened with the aid of Allen wrench.

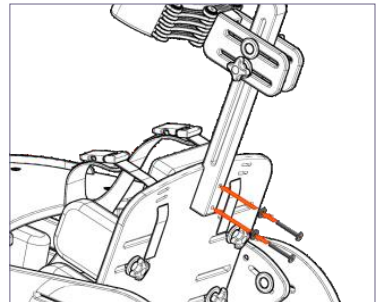
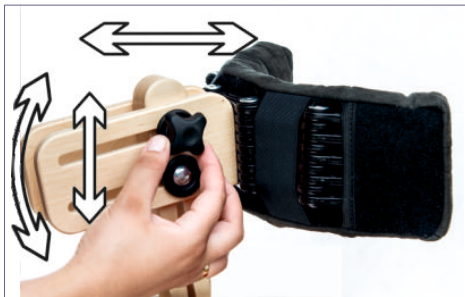

6.8.3. The adjustment of headrest

Please follow these steps so as to adjust headrest:

- loosen fastening knobs situated at both sides of headrest,
- adjust headrest,
- tighten firmly fastening knobs.

Next, it is important to:

- loosen screws from headrest's ribbing with the aid of Allen key,
- adjust the shape of headrest at your discretion,
- tighten firmly screws.





7 THE USE OF CHAIR



CAUTION! JUMBO™ chair has to be used with compliance to guidelines included in this user manual. Remember to use the product only with someone who is trained and knowledgeable. Do not forget to prepare both product as well as patient before using JUMBO™ chair

7.1. Preparation of the patient

Before using the product, it is essential to make sure that:

- patient's outfit is light and comfortable sporty clothes are advisable;
- shoes should be comfortable and, moreover, they should stabilize ankle;
- due to hygienic reason and to avoid abrasion it is advisable for the patient to always wear clothes when using the device, skin must not be naked especially in places of regular contact with upholstery;
- drains, bags, catheters etc. if applied, have to be secured to function properly and not to disturb during using the product;
- if it is necessary for a patient to wear orthopedic supply (collar, corset, orthosis, shoes) if it is recommended by doctor.



CAUTION! Outfit should protect patient's skin from direct contact with upholstery as well as other parts of equipment.

CAUTION! Only doctor can make a decision concerning using any kind of orthopedic supply!





7.2. How to use chair

1. Before use it is necessary to:
 - Unfold the device;
 - Place the device on even ground;
 - Make sure that all parts are serviceable, correctly mounted and stable;
 - Block brakes;
 - Adjust the device to patient's measurements;
 - Undo vest, trunk belts etc so as to place easily the patient in the device;
 - Place patient in the device;
 - Fasten all elements which stabilize patient e.g. vest, trunk belts, feet stabilizing belts etc.;
 - Mount additional equipment e.g. tray.
2. In case of patients who have problem with bladder, it is necessary to put special cloth on seat. This cloth can be purchased in pharmacy or medical shops.



CAUTION! Before the product is used, it is highly necessary to make sure that all belts as well as safety equipment are correctly fastened as well as adjusted. What is more, check if they do not become undone due to the pressure and, moreover, make sure that clampings from adjustable elements are firmly tightened!

Equipment works correctly only when the device is adjusted according to patient's height as well as weight. Remember to take all these measurements into account while purchasing the product. Correct adjustment is the most important due to the fact that only then the product is safe. It is forbidden to force child to keep specific position because he/she will feel uncomfortable and it may lead to wrong posture.





7.3. Sitting position

Clinical research shows that it is really beneficial for children to adopt sitting position so as to stimulate psychomotor development. Moreover, adopting sitting as well as standing position is advantageous for disabled due to the fact that it has a positive influence on organs and systems. Furthermore, it often acts as the stage of upright position and learning to walk:

- the most significant cause of using chair is the stimulation of psychomotor system;
- it has an influence on patient's state of mind;
- it has an influence on the development of muscles, joints and musculoskeletal system;
- it prevents from contractures or makes it easier to cure them; it improves joint mobility;
- it prevents from muscle atrophy (especially postural); it makes it easier to take exercises for upper limbs while sitting position
- it improves cardiovascular system;
- it improves lung ventilation and prevents from pneumonia; it improves intestinal peristalsis;
- it prevents from urinary problems or makes it easier to cure it;
- it prevents from bedsores or makes it easier to cure them;
- passive sitting is usually only the stage of rehabilitation process

Taking the sitting position for the first time by the little patient usually happens in the rehabilitation, neurology, neurosurgery or orthopaedic ward. Upright standing is supervised by the doctor and physiotherapist due to the possibility of occurrence such medical problems like: loss of consciousness, drop of blood pressure etc. It is very important to adjust all parts of the device to the condition of the child, taking into consideration contractures and deformations.

Taking the sitting position at home is supervised by qualified staff (physiotherapists, nurse, trained members of the family).





CAUTION! Incorrect adjustment of the device can lead to side effects such as: fainting, body deformities, overloading joints. It is highly advisable to adjust the device before every use of a standing frame. This adjustment has to be done only by a trained person or therapist. If any of these side effects appear, it is highly important to stop the upright position process, take out the patient from the device and lie him/her down. If these undesirable side-effects still occur it is necessary to contact doctor. If these side effects disappeared, remember to inform doctor so as to make decision concerning further upright position process.

CAUTION! Only doctor can make decision concerning the use of rehabilitation chair!



8 SAFETY RULES



CAUTION! JUMBO™ chair has to be used in compliance with guidelines in this user manual.

It is highly important to consult either doctor or physiotherapist in order to make right decision concerning the choice of chair and its size. It is also essential to familiarize with the guidelines described in user manual before using the device.

1. Before use it is necessary to:

- make sure that there are no damages or different faults which could endanger patient's life; check if all parts are working and are correctly mounted and, moreover, check if they are not broken;
- check if all screws, knobs and all glued, sewed or tapped parts are tightened;
- check if brakes are operating correctly;
- check if buckles are operating correctly;
- always use safety belts, Velcro tapes should overlap min. 8cm;
- adjust the device according to patient's measurements and needs e.g. the adjustment of pelottes, footplate etc.;
- make sure that all movable parts and knobs for adjustments are stable and locked;
- secure patient with the aid of elements such as vest, foot stabilizing belts, pelottes, abduction block, headrest. It is highly important to secure patient because it safeguards him/her from falling out. If abduction contracture occurs, it is recommended to use abduction block in order to prevent ulcers between knees;



2. It is forbidden to use chair for different purposes that it is intended to.
3. It is forbidden to use chair when it is damaged or any part is missing.
4. It is forbidden to leave the patient unattended.
5. Chair should be used only when there is someone who is trained and knowledgeable.
6. It is forbidden to leave chair and the patient on unstable ground unattended, even if the brake is engaged.
7. It is forbidden to either go up or down the stairs; it doesn't matter if the patient is placed in the device or not.
8. It's important to make sure that patient doesn't stand on footer during either getting into or getting out the chair.
9. It is important to engage brake during getting into and getting out the chair.
10. Make sure that all limbs are not close to spokes or other adjustable elements.
11. Although the device and the upholstery are made of fire-resistant materials, please pay your attention when approaching to sources of fire or sources of high temperature during using the device. Moreover, chair shouldn't be stored in rooms with high humidity.
12. Secure chair during transportation in order to avoid any possible damages. Manufacturer doesn't take responsibility for damages which appeared due to improper preparation of the device during transportation.



CAUTION! Taking the sitting position for the first time by the little patient usually happens in the rehabilitation, neurology, neurosurgery or orthopaedic ward. Upright standing is supervised by the doctor and physiotherapist due to the possibility of occurrence such medical problems like: loss of consciousness, drop of blood pressure etc. It is very important to adjust all parts of the device to the condition of the child, taking into consideration contractures and deformations.



CAUTION! The product contains small parts which children may swallow.

CAUTION! It is forbidden to make any changes concerning stroller's structure due to the fact that it is dangerous and it results in losing warranty.



CAUTION! The weight of user should not be bigger than maximal weight described on page 9 where you will find information regarding this issue.

CAUTION! This device can be only used inside the buildings.

- 1) AKCES-MED Sp. z. o. o sells products free from manufacturing defects or faults.
- 2) Manufacturer gives the purchaser 24-month guarantee from the date of purchase. All defects revealed during warranty period will be repaired free of charge.
- 3) All defects which appear after warranty period can be repaired only when the user will pay for it. This rule doesn't apply to refunded products - user can ask National Health Refund for refund.
- 4) Manufacturer claims that the product can be used for 36 months. User can use this product after this period only when he/she will send the device to manufacturer so as to service it. Next, manufacturer determines again how long the product can be used and, moreover, the date of the next service will be determined.
- 5) If product is damaged, please contact our dealer or AKCES-MED customer service (ph. 17/864 04 70)





9 MAINTENANCE AND CLEANING

Chair should be kept clean and used in compliance with the manufacturer's recommendations. The device should be kept in clean, dry and ventilated room. Maintenance as well as cleaning have to be performed at least once a month. Regular cleaning and maintenance of chair are indispensable to maintain its correct functionality as well as safety.

It is highly advisable to remember about proper maintenance in order to extend product's aesthetics. So as to do that, it is essential to comply with these guidelines:

1. It is recommended to clean upholstery with the aid of cleaning product, soft sponge and warm water. If you use sponge which is too wet, stain may get bigger, upholstery may be destroyed. It is necessary to remember that the excess of dampness should be removed from fabric before next cleaning. Please rinse upholstery with warm water and clean white cloth once stain is removed.
2. It is forbidden to soak upholstery!
3. It is forbidden to clean upholstery with the aid of hard brushes.
4. It is forbidden to clean upholstery with strong chemical agents such as solvent or caustic chemicals.



CAUTION! Akces-MED Sp z o. o takes no responsibility for damages caused by use of wrong clearing agent.

5. It is forbidden to soak upholstery during cleaning. Remember that upholstery has to be always dry before using.
6. It is forbidden to clean, make any changes and maintain stroller during using it.
7. All metal as well as plastic elements should be cleaned by hand with the aid of general cleaning products. Remember to familiarize yourself with cleaning product's leaflet.





CAUTION! Remember that upholstery has to be always dry before using!

Before using it is necessary to:

- clean wheels;
- check if base as well as wheels are correctly mounted; check if brake stops turning wheel;
- make sure that all wooden parts e.g. tray don't have splinters;
- check if stroller construction is free of breaks or any kinds of deformities;
- check if all movable parts are working and all screws, nuts, knobs etc. are correctly tightened;
- check if belts, vests, trunk belts, feet stabilizing belts etc are not frayed; check if buckles and clamps work correctly.



CAUTION! Manufacturer takes responsibility only for hidden faults or damages which appeared despite the fact that user complied with the guidelines.

CAUTION! In case of any damages, it is essential to contact the person who sold you the product.





10 LABELLING

10.1. Symbols

	Declaration that the product meets the essential requirements		Protect from sunlight
	Catalog number		Storage temperature limitation
	Serial number		Relative humidity storage
	Please read the manual instructions before use		Dry vertically
	Attention!		Do not chlorinate
	Producer		Do not iron
	Production date		Do not dry in a drum dryer
	The product does not contain		Do not bleach
	Store in a dry place		Careful! delicate content
	Prohibition of use without fastened safety belts		Prohibition to leave the patient without care during use of the product
			It is forbidden to either go up or down the stairs; it doesn't matter if the patient is placed in the device or not.

10.2. Example of identification plate

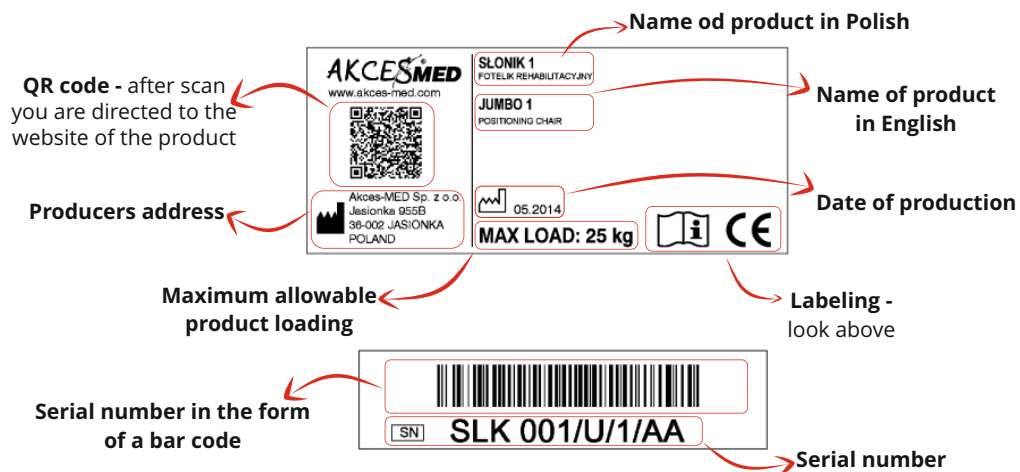



ORTHOPAEDIC DEVICES MANUFACTURER



Akces-MED Sp. z o.o.
Jasionka 955B
36-002 Jasionka
tel. (17) 864 04 77

www.akces-med.com

e-mail: export@akces-med.com

Authorised Dealer



Date of issue: **01.04.2009**

The last update: **30.05.2017**

Our passion - your independence!