

Mackworth CP440 Portable Track Hoist

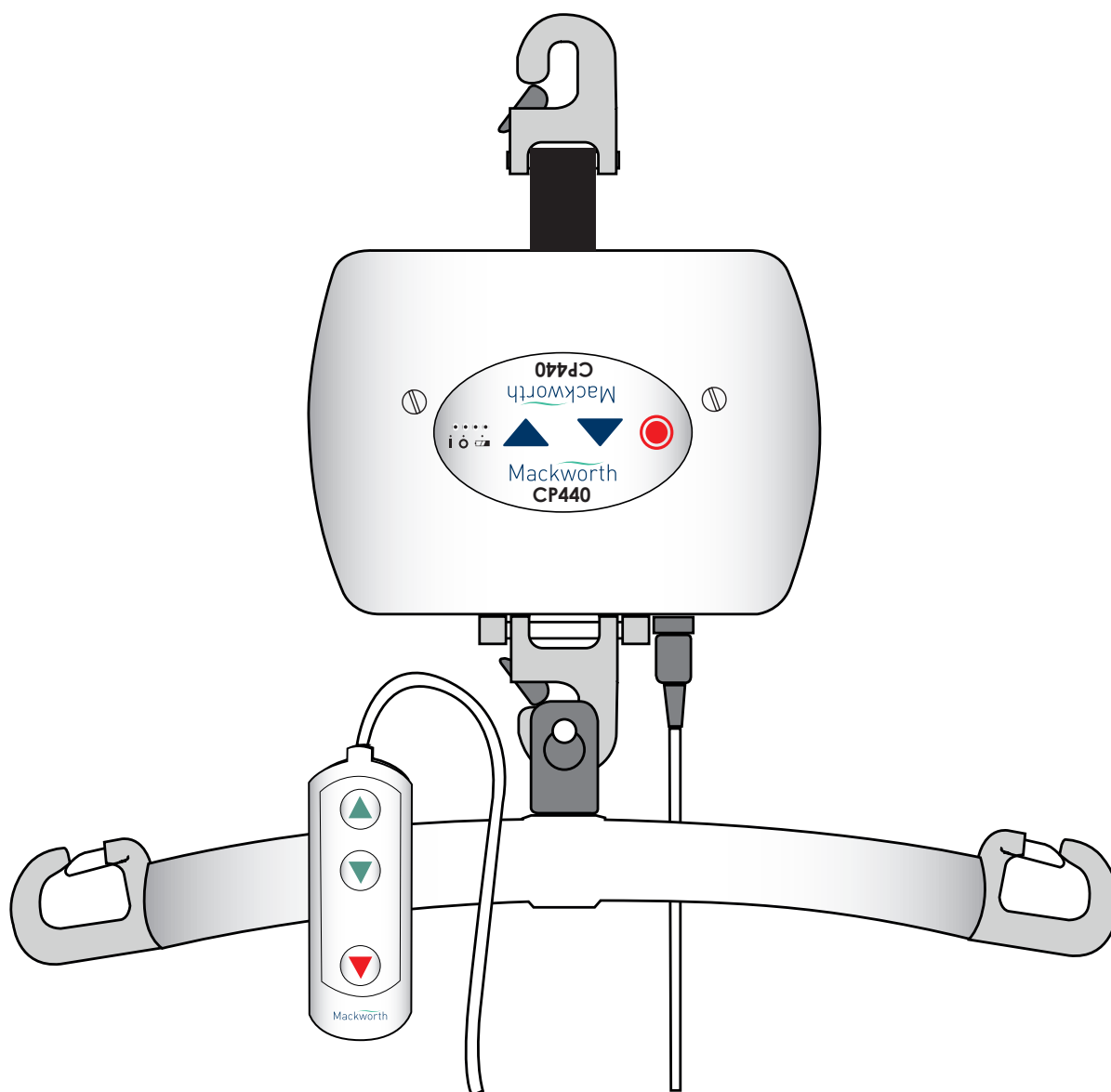









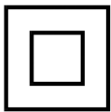

User Manual

Mackworth

Contents

Symbols used	Page 3
1. Introduction	Page 4
2. Contraindications	Page 5
3. Overview of the CP440	Page 6
4. Component list	Page 7-9
5. Hoist Dimensions and Lifting Range.	Page 10
6. Safety precautions	Page 11-12
7. Attaching the Hand Controller to the Hoist	Page 13-14
8. Operation	Page 15-17
9. Charging the hoist	Page 18
10. Emergency stopping / lowering	Page 19
11. Fault finding	Page 20-22
12. Specification	Page 23-24
13. General Inspection and Maintenance	Page 25-26
14. Recommended Cleaning Instructions.	Page 27-29
15. Standards Applied	Page 30
16. Disposal	Page 30
17. Installation	Page 31
Test Certificate	Page 32
18. Warranty	Page 33
19. Service Record History	Page 34-37
User notes	Page 38-39

Symbols used

	Caution – see instructions for use
	Class II Equipment - electrical equipment in which protection against electric shock does not rely on basic insulation only
	Manufacturer
	Please observe local laws on recycling
	Consult instructions for use
	Date of manufacture
	Serial number
	Packaging indicator – This way up
	Packaging indicator – Keep dry
	Type B applied part
	Temperature range
	Humidity range

CAUTION: DO NOT ATTEMPT TO USE THIS EQUIPMENT WITHOUT FIRST UNDERSTANDING THE CONTENTS OF THIS MANUAL

1. Introduction

The hoist can easily be operated by one person.

Before using this equipment, and to ensure the safe operation of your CP440 Ceiling Track Hoist, carefully read this entire manual, especially the section on “Cautions”.

The CP440 ceiling track hoist is designed to be used in conjunction with Mackworth accessories and slings. Please refer to any user guides supplied with these components and refer to them while reviewing this manual.

Should any questions arise from reviewing this manual contact your local authorized Mackworth Representative.

Failure to comply with warnings in this manual may result in injury to either the operator, or the individual being lifted/transferred. Damage to the hoist and/or related components may also occur. Be sure that the contents of this manual are completely understood prior to using this ceiling track hoist.

- Store this manual in a safe accessible location along with the documents included with the hoist and sling(s) where it can easily be referenced.

2. Contraindications

There are no known “contraindications” associated with the usage of the CP440 hoist and its accessories, provided they are used a per manufacturer’s recommendations and guidelines.

However, it is recommended that a client specific assessment is completed by a trained and knowledgeable health care professional to determine the method of transfer.

Mackworth does not recommend a required number of caregivers for the use of our products. This information and recommendation can only be provided after a thorough personalized, case specific assessment, as there are many factors that can influence these decisions.

It is however, “obligatory” that a client that is assessed as being an independent user of our ceiling hoist technology have the ability to receive assistance, during the transfer, in the event of a hoist malfunction or personal concern.

This assistance can be provided in the form of; a nearby qualified caregiver, a phone, a communication device etc.

3. Intended Use - Overview of the CP440 Portable Hoist

The CP440 hoist is a lifting aid used by health care professionals to transfer clients. The hoist makes it possible to move mobility impaired individuals with minimal strain or risk to the caregiver, while providing complete safety, dignity and comfort for the client.

The CP440 hoist is one of three components that make up this technology. The other components, the sling and the track system are the further two components that make up the complete system. The sling is a specially designed fabric accessory that attaches to the hoist by means of a carry bar and strap system, and holds an individual while the lift, or transfer takes place.

The sling is supplied separately from the hoist at the initial time of purchase. Please refer to any user guides supplied with the sling and reference them while reviewing this manual.

The track is the means to operate the hoist in a defined route. The track affords the carer / user a means to “travel” in a designated safe route enabling the patient different uses around the “travel” of the hoist.

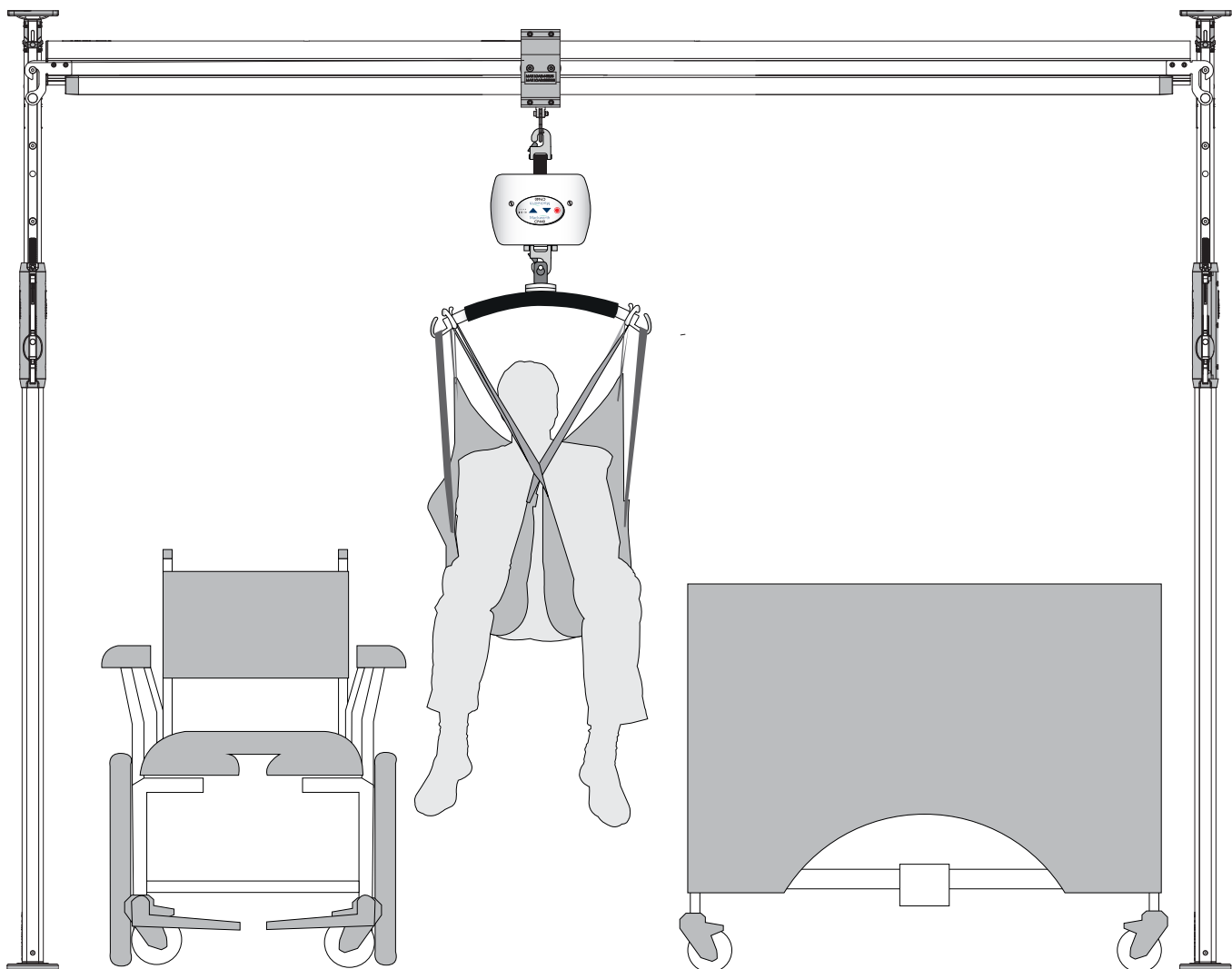

4. Component List

The following components are included with your new CP440 hoist system:

- CP440 Hoist
- QRS Carry bar
- Hand controller and case
- Hoist mains charger/ wall dock system
- Owner's manual
- QRS reacher
- Hoists mains charger/ wall dock include Starwell AC/ adapter- model no-SK01G-2400133Z

Please see below to familiarise yourself with the components of the CP440 hoist. The images below shows the contents of the hoist package.

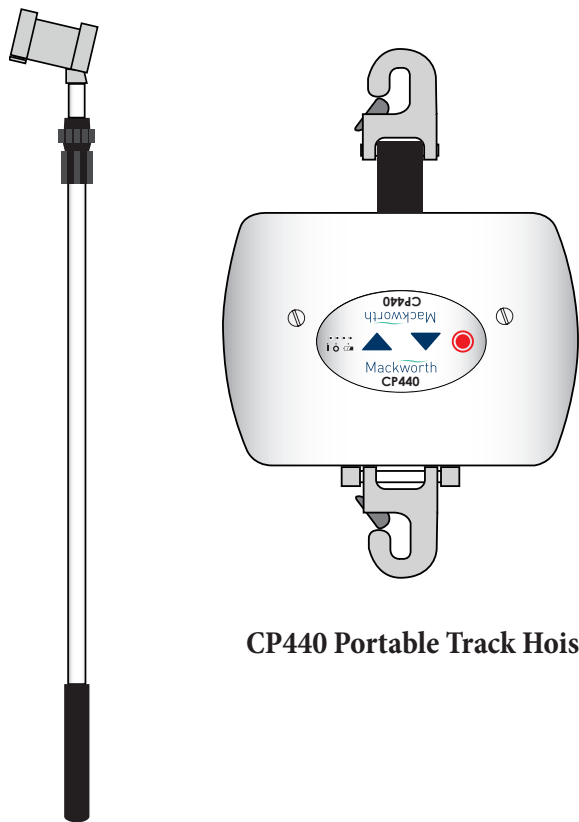

CP440 Portable Track Hoist

QRS Reacher Bar

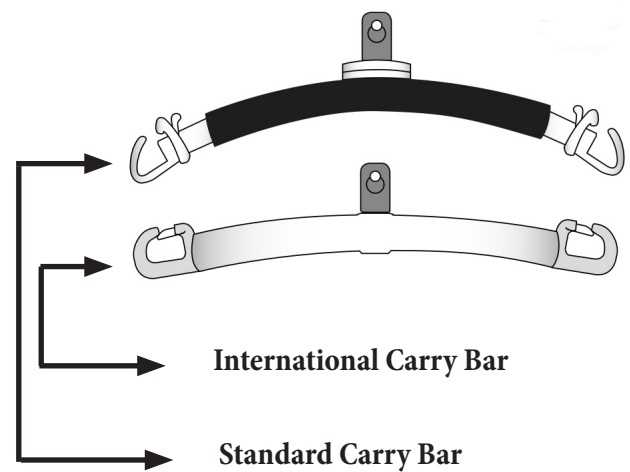

International Carry Bar

Standard Carry Bar

Contents of the hoist package continued

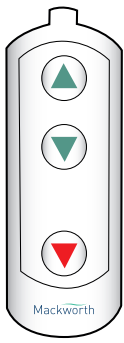

Handset

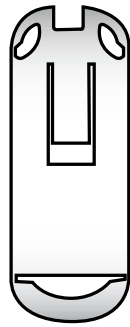

Carry Bar Clip

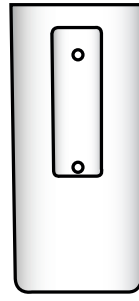

Wall Mounted Dock

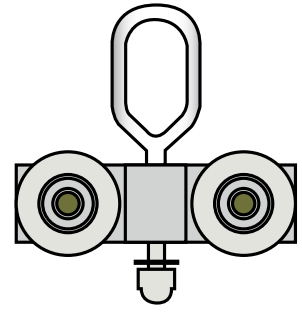

Trolley Set

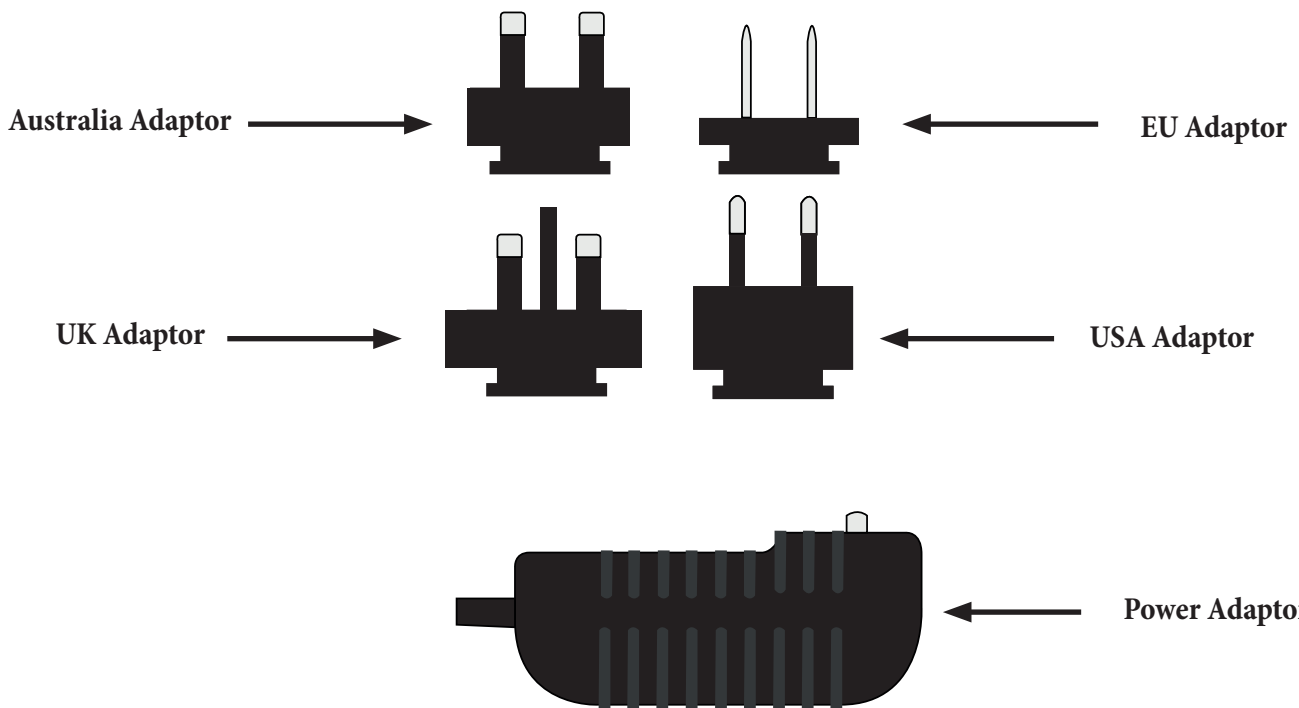

Slings: If a sling has been supplied with the hoist, refer to the instructions included with the sling. Hoist is designed to be used with any Mackworth manufactured sling. Relevant risk assessment must be carried out before using any other manufactured slings.

Accessories: If additional accessories such as a gantry system has been supplied with the hoist, refer to the instructions included with those items.



Before initial use, the hoist unit must be charged for approx. 6 hours. Refer to section titled “charging the hoist”. The hand control must also be connected to the hoist. If it is not connected, refer to the section titled “attaching the hand controller to the hoist”

Carry Bars

Although Mackworth supplies carry bars specifically to be used with the associated devices it manufactures, there is no reason that other manufactured carry bar systems cannot be used BUT they must be done so after a full risk analysis has been carried out for its use on the Mackworth hoist system to ensure safe use can be established.

Carry Bar connection points

The carry bars manufactured by Mackworth, associated for use with this device, incorporates two fixing points which is not new technology and the fixing can be derived by user by means of a simple connection made by the sling to the carry bar itself. This connection system is used throughout the industry in various designs but all act as the means to hold the sling and user in place through operation of the device whilst in use.

5. Hoist Dimensions and Lifting Range

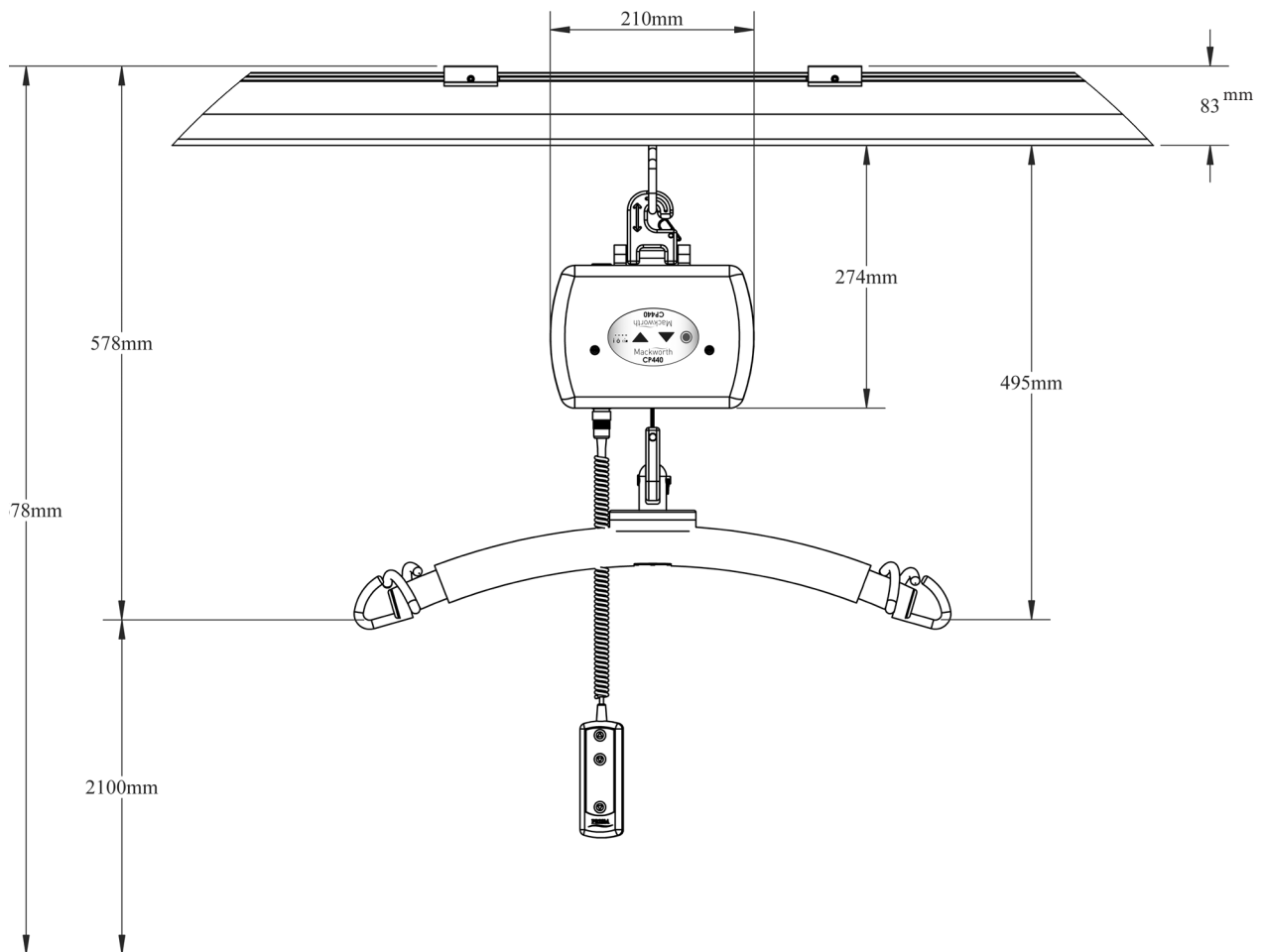

The diagram above shows the relevant lifting ranges and dimensional sizes of the hoist (all dimensions are shown in millimetres)

The direction of travel can only be made within the boundaries of where the hoist is installed in the track system.



There are no necessary modifications required for the device to perform its intended use.

However, should the device or the installed system require modification, please consult your local service agent to arrange a date and time to assess the required changes to the system.

DO NOT attempt any system modification without the consultation of an installation agent who should be present at the time of modification in order to verify the outputs are safe for use.

6. Safety precautions



The CP440 hoist must be installed prior to use. Initial installation training will be supplied by a Mackworth engineer to the responsible user of the system. The CP440 must be installed only by persons authorised by Mackworth who have had the training to do so.

- Under no circumstance should the CP440 hoist, gantry/track and sling or entire system be put in control of a person who has not been properly trained in the use and care of this equipment. Failure to adhere to this warning may result in serious injury to the operator, and / or the individual being hoisted/ transferred.
- The CP440 hoist, and associated gantry/track and sling are not toys. Do not use it for unsafe practices. Do not allow children to play with the hoist or any of its components.
- Your guarantee is void if persons unauthorised by Mackworth perform work on the hoist systems.
- There are no user serviceable parts inside the cover of the hoist, likewise for any components of the associated parts. Do not remove cover screws, or open the hoist unit, as this will VOID THE GUARANTEE/WARRANTY.
- In facilities where more than one operator will be responsible for using the CP440 hoist and associated systems and sling(s) it is imperative that all such members be trained in its proper use. A training program should be established by the facility to acquaint new operators with this equipment.
- Never expose the CP440 hoist directly to water. Your guarantee does not cover any misuse or abuse of the hoist system.
- To maintain optimum function, the CP440 should be inspected and maintained on a regular basis. See the section titled General Inspection and Maintenance within this user manual.
- Any accessories used with the CP440 including track/gantry and sling(s), should be checked to ensure that they are in good working order. Check for signs of wear to each component prior to use. Report any unusual wear, or damage immediately to your local authorised dealer.
- The CP440 hoist and associated accessories, track/gantry and sling(s) are intended only for hoisting and transferring of a person. Mackworth will not be responsible for any damage caused by the misuse, neglect or purposeful destruction of the hoist, and/or it's associated components.
- Do not in any circumstance exceed the maximum allowable load of this hoist. Refer to the Specifications section of this manual, and /or the labels on the side of the hoist.
- The installation of the hoist and its associated parts are certified to a maximum load. Do not exceed the maximum rated load of any of the components
- There is a risk of explosion if the hoist is used in the presence of flammable anaesthetics.
- Ensure that a clear space is maintained around the hoist and track/gantry. Move all curtain material and other obstacles out of the way before performing a transfer.
- Your hoist is for patient lifting. Do not use it, or allow it to be used, for any other purpose.

- In areas where children are prone to be present, when the hoist system is not in use and to reduce the risk of unintended use, please remove the sling from the hoist system to prevent any issues of entrapment or strangulation should the device be “played with”.
- The hoist batteries are not a user serviceable part – please consult the service manual for the method for replacement.
- When a hoist is to be used by a disabled person living on their own, then some form of communication device shall be installed in the area of use of the hoist so that in the event of an emergency the disabled person is able to summon assistance.
- The operator shall not touch the connector of the remote control or AC adapter and the patient at the same time.



PLEASE ENSURE – during installation or operational awareness of the device that no object is placed against or in effect, obscuring the hoist power charger or that the hoist installation itself does not allow for suitable clearance to remove the hoist from the mains power supply. The mains supply adapter should remain clear from obstruction at all times.

6.1 EMC Statement

The following statement has been made against the assumption that the user of the system utilises the provided components supplied by the manufacturer of the device to operate the device as intended. DO NOT use any other form of power charge with the system as the manufacturers’ adapter has been assessed and complies with the EMC requirements.

This product, manufactured by Mackworth, has been designed, manufactured and tested in accordance with the legal requirements for the environment in which the device will be used within.

Pacemakers, defibrillators and other medical devices should be manufactured in such a manner that they can withstand Electromagnetic Interferences (EMI) in accordance with their associated mandatory European directives and regulations. Please consult the user alert card which would have been issued to the user regarding the use of electrical items for those individuals fitted with these or any other devices.

If users of this equipment are unsure of its compliance to EMC you can request the confirmation from Mackworth that the product is manufactured to the appropriate Electromagnetic Compatibility standard.

The use of the device within the correct area where the intended use is given will have no detrimental effect on other devices that have been tested to their intended respective requirements

7. Attaching the Hand Controller to Hoist



A sturdy ladder or steps may be required in order to access the underside of the hoist to re-attach the hand controller. Caution should be used when this is required.

Should the cord that connects the hoist to the hand controller become disengaged from the underside of the hoist it must be re-connected in order for the hoist to work properly.

The hand controller may become disconnected for the following reasons:

- The hoist is pulled along the track by the hand controller.
- The hand controller cord accidentally gets wrapped around an object while a hoist or transfer is being performed.
- It is accidentally pulled out by the carer or the individual being hoisted.

The hand controller will be connected to the hoist (dependant on the orientation in which the hoist is being operated under – there is a hand controller socket on both the upper and lower hoist case)

A connection plug, located at the end of the hand controller wire will make the connection to the hoist via mating together of the male and female sockets from the hand controller to the hoist itself.

This connection can only be made when both the hand controller plug and the hoist socket are in the correct orientation. Insert the plug into the socket in the hoist and slowly rotate until you feel the plug locating into the socket.

Once fitment is made and both connections are aligned, press the socket home until a click is heard which will indicate the connection has been made securely.

Perform a brief test to ensure proper connectivity. Turn the hoist ON and OFF and also use the hand controller to raise and lower the carry bar. If these functions all work correctly, then the hand controller is correctly installed to the hoist.

If the hoist does not work as expected after connection of the hand controller to the device, then please check firstly that the unit has power to operate. This will be indicated by the LED indicator status on the unit – (fig 2.) below

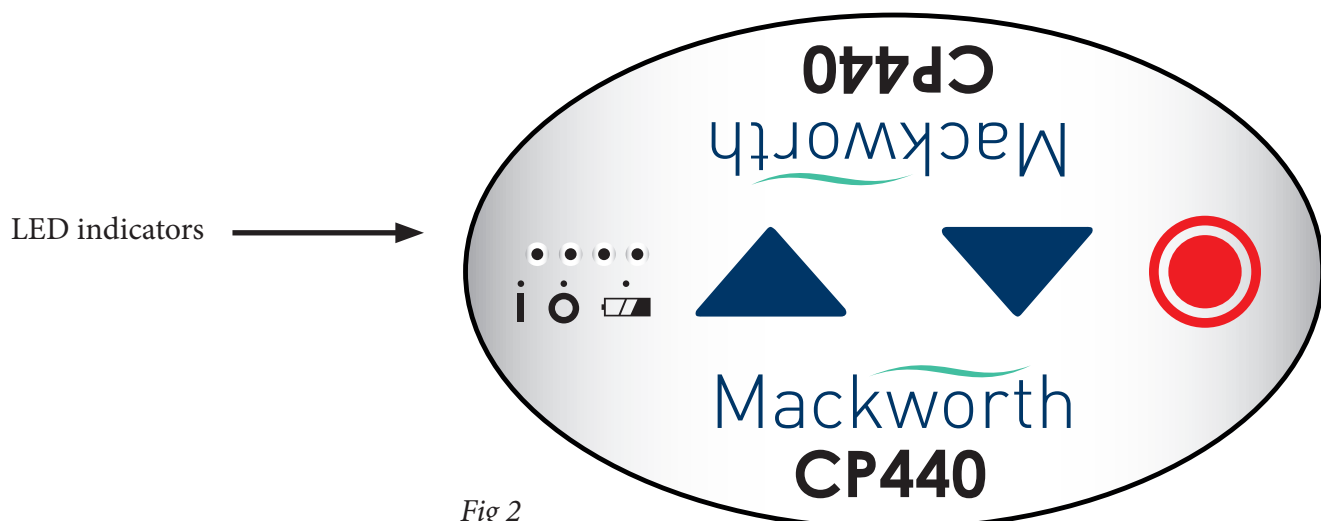

Fig 2

If no LED indicators are visible and the hoist is in the “ON” position, then the hoist will need to be re-charged. If after/during the charging process there is no indication of a charge present from the LED’s, then contact your local authorised dealer for service.

The image below shows the hand controller plug connector – this connection is made to the hoist (fig 3.)

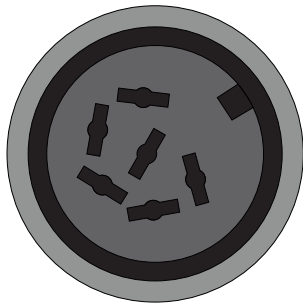
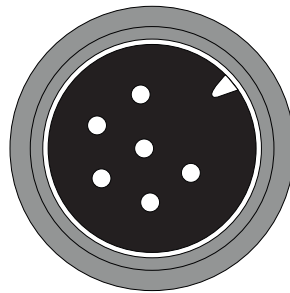

Fig 3



Note the orientation of the socket pins – this will only fit into the hoist socket in one position – once aligned press the connection home

Hand controller plug connector

Hoist connector

The image opposite (fig 4.) is of the connection of the hand controller to the hoist in its installed position – this is reflective of the connection to the hoist in either orientation.

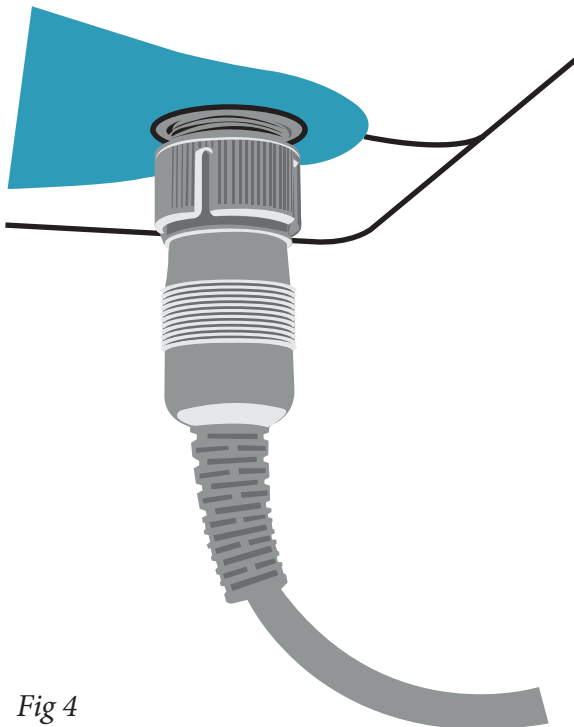
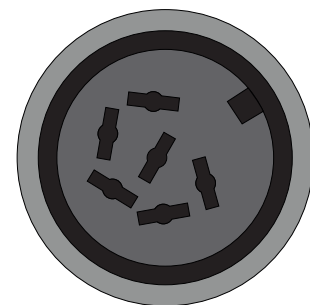

Fig 4



The connection is made into the hoist socket shown opposite which is located in two positions on the hoist itself

8. Operation



Always, before using the CP440 hoist system, the hoist, track/gantry and sling must be visually checked for any unusual wear, or damage. Refer to the user manuals with each piece of supplied equipment to determine what should be checked. Should anything look unusual, contact your local Mackworth dealer prior to use.

8.1 Start- up- Turning the hoist on/ Off

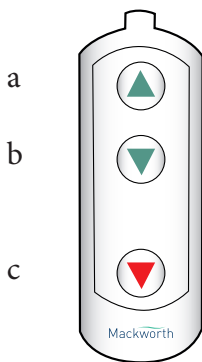

Shown in the image opposite are the 3 functions of the hand controller for the hoist.

- a. “UP” when depressed
- b. “DOWN” when depressed
- c. “EMERGENCY LOWER” when depressed



To operate the hoist, it must first be turned ON via the “ON” switch on the hoist itself (see (fig 5.) opposite). The indicator LED’s located on the hoist will turn GREEN to indicate power is available. The hand controller will “wake up” once any functionality button is depressed.

Fig 5

If the hoist fails to turn ON at any time, ensure that both the hand controller and the hoist itself have the required charge to operate both effectively.



PLEASE NOTE: The hoist is NOT operational whilst in the charging state.

To conserve battery power, the hoist will automatically shut off after approximately 2 minutes of non-use (this is not a fault with the unit).

If the batteries of the hoist are low and require charging, the indicator light located on the hoist will turn RED and flash (see LED status indications further in the user manual) depending upon the level of discharge and an audible buzzing alarm will sound when the level gets critical until charging takes place.

Operation

8.2 Raising and lowering the carry bar / hoist

By pressing the UP or the DOWN arrow button, the carry bar/hoist can be lowered or raised to the correct height for attaching the sling or positioning an individual. See (fig 6a) below

It is recommended that the carer (operator) hold the carry bar with one hand while this is being done so that it will not accidentally sway and/ or come into contact with an individual or close object.

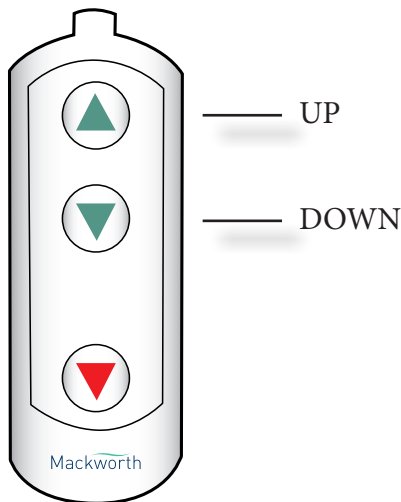

fig 6a

The lifting / lowering functions of the hand control buttons in relation to the travel of the hoist – as shown in the images.

Fixed Mode

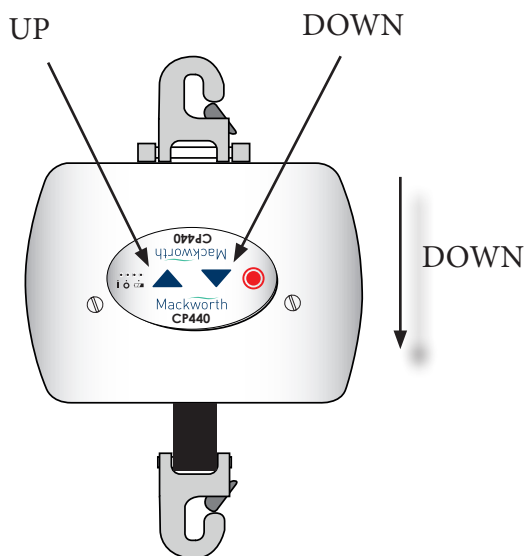

fig 6b

Portable Mode

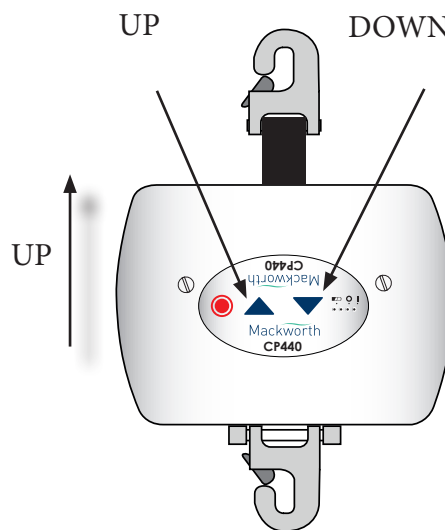



fig 6c

The hoist can also be inverted at the operator's discretion where the hoist itself lowers. The hoist is fixed in the position shown in (fig 6b) and the lift tape will lower, whereas in (fig 6c.) the hoist lowers. This can aid in the attachment of the carry bar and the sling. The functional operation is exactly the same but the hoist moves as opposed to the lifting tape

The hoist can also be operated by use of the buttons on the hoist itself, functions available are as per handset- lifting, lowering and emergency lowering.

8.3 Moving the hoist along the track / gantry system

The hoist will be located, after or before use, at the end of the track system where it can easily be re-charged. It can be moved along the track to a position directly above the person to be hoisted in the following manner: Lower the carry bar to a comfortable height so that it can easily be grabbed by your hand. Move the hoist along the track gently pushing the carry bar to the required position where the person can be safely loaded into the sling.

	NEVER pull the hoist along the track using the handset
	Always use extreme care when moving the hoist along the track. Watch out for and avoid any obstructions that may cause injury to the individual in the sling and/ or damage to the hoist

8.4 Return the hoist to the recharging position

The hoist at some point, will require its internal batteries recharging, along with the hand controller to continue its use on the track system. The hoist can be charged whilst at any point on the track but it should be undertaken at a point which is close to a mains socket and out of the way of moving traffic to prevent any injury to users in the area

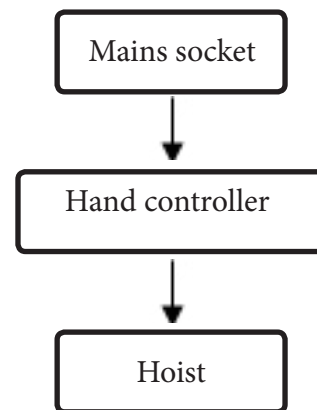

8.5 Hand control storage

The hand controller should be held in a safe location when not in use to prevent any untoward use and to prevent damage to the hand controller itself.

8.6 Shut down process

To power off the unit, press the red switch on the main hoist body to off (O). This will shut down the hoist with immediate effect.

The CP440 also offers a sleep mode, after 30 seconds the unit will power down with the led status off.

Upon pressing a control button, the unit will reactivate and function.

9. Charging the Hoist

The charger for the hoist can be connected to any mains supply in a suitable location to the area which it is being used within.

To prolong the life of the batteries utilized by the hoist, the hoist should be charged on a regular basis. It is recommended that the hoist be left on charge when not in operation, and at the end of each day. This will maximise the life cycle of the batteries and also provide greater opportunity to use the hoist if it is always left in a charged state for immediate use.

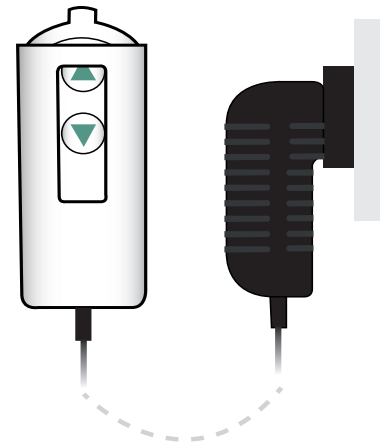

The hoist may remain connected to the charger indefinitely since the hoist has a built-in regulator, eliminating the danger of overcharging.

Refer to previously outlined sections on how to move the hoist along the track. As a general rule it is recommended that the carry bar be raised to a height so that it will not interfere / hit anything or anyone.



Do not move the hoist with excess speed or force when locating it in the area to re-charge the batteries. No excessive force is required to move the hoist and remember to have the carry bar adjusted to a safe height when doing so to avoid coming into contact with other objects in its path



Use only the charger that was supplied with the hoist. Use of any other charger will void all warranties and may cause damage to the hoist

9.1 Isolation from the mains supply

The equipment can be isolated from the mains supply by the disconnection of the power adapter when charging from the mains outlet or disconnection of the adapter connector from the hand controller whilst charging.

The device is reliant on battery power for use – the device should not be used whilst in the charging state.

10. Emergency lowering

The hoist is not electrically driven along the track system in use. Movement of the hoist along this system will be controlled by the operator of the device – In effect, the operator has full control of the movement while the user is installed into the hoist system.

The hoist does however have an emergency lower feature to be utilised in the situations that arise where this may be a requirement.

The feature can be used by pressing and holding button “C” in the image below.



Should this feature be used on a continual basis in relation to the functionality of the hoist being suspect, contact your local authorised dealer immediately. The hoist unit must be inspected prior to restoring to use

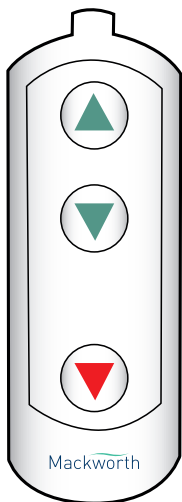

The image of the controller opposite shows 3 functionality buttons. Two of these are for the operation (UP / DOWN) of the device, while the third one (indicated as “c” in the image is the emergency lower button



The operation of the button indicated above on the hand controller correlates to the same output from the operation of the round button shown in the image opposite from the operating panel of the hoist unit itself.

Emergency lower button should only be used/ if lower button does not operate. E lower bypasses the main PCB so in case of failure patient can be lowered safely.

11. Fault finding

The table below gives an indication as to the status of the device through reference to the LED's shown on the hoist unit

LED (1)	LED (2)	LED (3)	LED (4)	BUZZER	FUNCTION	NOTES	ACTION
Green Steady	Green Steady	Green Steady	Green Steady	No	100% battery capacity	Actual 100% to 75%	–
Green Steady	Green Steady	Green Steady		No	75% battery capacity	Actual 75% to 50%	–
Green Steady	Green Steady			No	50% battery capacity	Actual 50% to 25%	–
Green Steady				No	25% battery capacity	Actual 25% to 10%	–
Red Steady				Yes	10% battery capacity	–	–
Green Flash				No	Charging-less than 25% battery capacity	–	–
Green Steady	Green Flash			No	Charging-between 25%-50% battery capacity		–
Green Steady	Green Steady	Green Flash		No	Charging-between 50%-75% battery capacity		–
Green Steady	Green Steady	Green Steady	Green Flash	No	Charging-between 75%-100% battery capacity		–
Red Steady	Red Steady	Red Steady	Red Steady	No	All lights OFF when sleep	Sleep after 30 seconds of no use	–
Green Flash	Green Flash	Green Flash	Green Flash	Yes	Emergency lower button activated	–	–
Red Steady	Green Flash	Green Flash	Green Flash	Yes	Over current during lift	Prevent lifting/ Lower only	Check patient weight is under 200kg

LED (1)	LED (2)	LED (3)	LED (4)	BUZZER	FUNCTION	NOTES	ACTION
Red Steady	Green Flash	Green Flash		Yes	Motor over temperature	Prevent lifting/Lower only	Allow to cool, (duty cycle ignored)
Red Steady		Green Flash	Green Flash	Yes	Battery over temperature	Prevent lifting/Lower only	Allow to cool (battery charging 75% then duty cycle ignored)
Red Flash	Green Flash	Green Flash	Green Flash	Yes	Motor current different between motors	One motor may not be plugged in or faulty	Call engineer – motor replacement
Red Flash			Green Flash	Yes	Motor temperature sensor fault	Prevent lifting/Lower only	Call engineer – motor replacement
Red Flash	Green Flash			Yes	Battery temperature sensor fault	Prevent lifting/Lower only	Call engineer – Battery replacement
Red Flash				Yes	Faulty charger	Over voltage, Under voltage, cant supply enough current	Call engineer – charger replacement
Red Flash	Green Flash	Green Steady	Green Steady	No	Battery voltage different between battery packs	Battery voltages differ by 4v	Call engineer – battery replacement
Red Flash	Green Flash	Green Flash	Green Steady	Yes	Limit switch	Switch fault/unplugged	Call engineer – limit switch loom replacement
Red Flash	Green Flash	Green Steady	Green Flash	Yes	Slack tape switch	Switch fault unplugged	Call engineer – limit switch loom replacement
Green Flash 1	Green Flash 2	Green Flash 3	Green Flash 4	No	Upper limit	Prevent lifting/Lower only	–
Green Flash 4	Green Flash 3	Green Flash 2	Green Flash 1	No	Lower limit	Prevent lowering/Lifting only	–

11.2 - Fault Finding

Should problems arise with the use of the hoist review the following chart. Find the fault and complete the recommended solution. If the fault is not found and/ or the solution does not correct the problem, contact your local Mackworth authorized dealer for service immediately.

Fault	Recommended Solution
Hoist does not lift / lower	<ul style="list-style-type: none"> • Hand controller not connected - connect controller and retry the operation once more • Power off/on button in the "off" position – turn on • Batteries have no charge – re-charge and try the operation again • Device being used outside of the SWL limits – read the user manual for the applicable SWL.
Emergency lower not working	<ul style="list-style-type: none"> • Handset not plugged in – plug the controller in or check the connection is secure • Damaged handset – visual inspection of the handset for damage
Hoist not charging	<ul style="list-style-type: none"> • Check the hand controller connection

Also provided is an LED status table (see previous page) this can be used for fault diagnosis. If in doubt, always contact the supplier to resolve issues with the hoist device.

11.3 - Lift tape caution



The image opposite indicates a badly worn lift tape due to a culmination of events that the hoist has operated under.

Whilst a tape in this condition provides no immediate danger, the use of the device should be suspended at this point, or prior to this point should the user become aware of the tape degrading, through due diligence by the operator until a service agent can replace the damaged tape.

This is severe wear. Any damage leading up to this point should prompt the operator of the device to cease use and seek a replacement.

12. Specification

- Hoist Motor: 24 VDC
- Charger Input: 100- 240V, 1.0 A
- Charger Output: 24V dc 1.33 A
- Rated Frequency 50/60Hz
- Batteries: 24 V dc (2 x 12V) 3.3Ah Nimh
- Fuse rating: Thermal fuses only (Automatic reset)
 - 1). F1 PPTC Ressetable fuse RUEF800- 8A, 30 VDC
 - Trip time- 18.8 s
 - Break capacity- 100 A
 - 2). F2 and PPTC Ressetable fuse RUEF185 1.85A, 30VDC
 - Trip time- 8.7 s
 - Break capacity- 100 A
- Hoist Case: Non-flammable ABS plastic
- Hand Control: Electric (3 button)
- Hoisting Range: Up to 2100mm
- Hoist Weight: 4.5kg
- Maximum Load: 200kg
- Duty Cycle: 15% use, 85% rest. 1 cycle is defined as a lift from ground to the top limit and lower to the ground
- IP rating: Hoist unit – IP20 / Hand controller IPX4
- Rated Performance: 50-60 hoists at 200kg, 15% duty cycle, each operation being 500mm at the middle of the hoisting range (from 800mm strap out to 1300mm strap out) per full battery



Please note: the hoist has a break in period; break-in of the hoist will need to be done before these numbers will be achieved. The breaking in period will vary from hoist to hoist and is dependent on the frequency of use and the types of load being applied, the higher the load and a greater frequency of use will break in the hoist faster



Type B applied part-applies to slings only



No modification of this equipment is allowed

12.1 Environmental - storage and operating conditions

The hoist is intended for use within normal environmental conditions

- -25 °C to + 30°C
- + 5 °C to + 30°C at a relative humidity between 0% to 90 %, non-condensing;
- >35 °C to 30°C at a water vapour pressure up to 50 hPa
- Max altitude- 2000m

13. General Inspection and Maintenance

a. Each Use - To be completed by User

Prior to each use the CP440 hoist and associated track systems, accessories and sling(s), must be visually inspected. Refer to the accessory and sling user guides for specific details regarding their inspection.

Should any of these items fail the inspection do not use the hoist Contact your local authorised dealer for service.

Visually check for the following:

- The hoist hoisting tape shows NO signs of fraying or breaking along its entire length.
- The stitching on the hoist hoisting tape where it connects to the carry bar shows NO signs of fraying, or breaking.
- The sling (s) that will be used shows NO signs of unusual wear and tear. The straps of the sling that connect to the carry bar of the hoist show NO signs of fraying or breaking. Refer to specific sling instructions.
- All the functions on the hand control work correctly (e.g. UP/ DOWN/ EMERGENCY LOWER)
- The bracketing systems in place to ensure the track systems are secure in providing safe use do not move or appear loose.
- There are no cuts, dents or sharp edges on the carry bar that may damage the straps of the sling.
- The hoist has no unusual sounds when the carry bar is moved UP/ DOWN or the hoist is moved LEFT/ RIGHT.
- Ensure that there are end stops installed at each end of the track systems where applicable.

b. Monthly - To be completed by User

Should any of these items fail the inspection do not use the hoist.
Contact your local authorised dealer for service.

Complete the visual inspection as noted in the 'Each Use' section above.

With no one in the sling nor attached to the hoist check the following:

- The hoist moves freely along the entire length of the track.

c. Bi-Annual or Yearly - To be completed by a hoist technician

This section to be only completed by a qualified service technician as authorised by Mackworth.

- Complete the visual inspection as noted in the 'Monthly' section above.
- Complete the preventative maintenance procedure as outlined in technical manuals for the CP440 hoist system.

13.1 User serviceable parts

Do not remove the covers of the hoist – there are no user serviceable parts within the device – should the device require a service, please contact your local service agent to arrange a suitable service time and date.

Service agent – (information is available upon request)

- Please contact the manufacturer or the distribution agent for information to assist service requirements on the device to ascertain the necessary information for replacement parts and components
- No maintenance to be carried out on this hoist while in use with a patient.

13.2 Reacher Operation

Included with the hoist there is a “reacher” pole. This provides the function to safely attach and detach the hoist when in the adjustable hoist position – adhere to the following instruction for its safe operation. This can be used should cleaning (or inspection) be necessary.

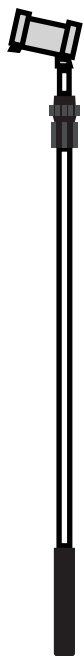

1. Apply the reacher below the hook
2. Push the reacher up onto the hook and this will release the safety pin allowing safe disconnection

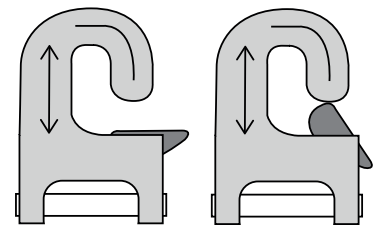

	This operation should only be carried out when the hoist is fully extended to its lowest position.
--	--

The two images opposite show the safety pin being opened to the position where it can be removed from the system.

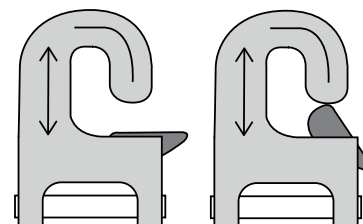

14. Recommended Cleaning Instructions

General cleaning

The exterior of the CP440 can be cleaned using a damp soapy cloth for general cleaning duties. Please ensure the cloth is damp and not wet. Ensure the exterior of the device is dry after cleaning, dry using a clean dry cloth.

- Handset- dry cloth wipe only
- Power adaptor- dry cloth wipe only

Care should always be taken when cleaning around electrical components

Disinfecting (if necessary)

Should the CP440 require a more thorough clean, the use of the Actichlor disinfectant product, which is widely available in tablet form and used throughout the healthcare industry, is recommended for use to ensure a thorough clean.



- Please follow the manufacturer's safety instructions for the use of the cleaning product before use to ensure safe use for the operator and the patient.
- Ensure the cloth is damp before the cleaning process. DO NOT use a wet cloth over electrical systems.

Application is through a clean soaked (but damp) cloth applied to wipe the device down.

Used in the following dilutions to ensure an effective clean:

- Actichlor dissolvable chlorine tablets provide a concentration of 1000 ppm of available chlorine (0.1%) per 1 tablet
- 1 tablet (1.7g formed tablet (x1)) will create a virucidal solution, diluted in 1 litre of water to provide effective means to clean a "Dirty" device. This is also ideal for use after an outbreak of the Norovirus / winter vomiting and can be used as a precaution against C.Diff. It is effective against viruses, bacteria, spores, yeasts and moulds.
- The contact time against the outer components of the device should be for 5 minutes to prevent any virucidal infections without a degradation to the functionality of the device. 5 minutes is a recommended contact time. The device can withstand a longer contact period but the 5 minute recommendation as a minimum must be followed to provide an effective cleaning regime.
- Blood spills should be dealt with by an increased concentration of the solution – please refer to the instructions on the manufacturers product labelling.

(Recommended cleaning instruction...continued)

Dilution chart					
Product used as:	Device condition	Concentration (ppm)	Dilution qty *	Tablets per litre	Contact time
Bactericidal	Clean	200	5 litre	1	1 minute
	Dirty	1000	1 litre	1	5 minutes
Yeasticidal	Clean	200	5 litre	1	1 minute
	Dirty	1000	1 litre	1	5 minutes
Fungicidal	Clean	2000	1 litre	2	15 minutes
	Dirty	5000	1 litre	5	15 minutes
Mycrobactericidal	Clean	1000	1 litre	1	15 minutes
	Dirty	5000	1 litre	5	15 minutes
Virucidal	Clean	500	2 litre	1	5 minutes
	Dirty	1000	1 litre	1	5 minutes
Sporcidal (C.Diff)	Clean	1000	1 litre	1	10 minutes
	-	-	-		
Sporcidal	Clean	5000	1 litre	5	10 minutes
	-	-	-		
<p>* Dilution is made within water</p> <ul style="list-style-type: none"> • When diluted in water, one tablet gives 1000 ppm of available chlorine DO NOT dilute within any other medium • The concentration of the solution depends upon whether the device being cleaned is noticeably dirty or not (indicated in the table by "Device Condition") 					

Safety precautions when using this cleaning agent

Handling and Storage:

Advice on Safe Handling



Avoid contact with skin and eyes. Do not breathe dust / fumes / gas / mist / vapours / spray. Use only with adequate ventilation.
Wash hands thoroughly after handling. Mixing this product with acid or ammonia releases chlorine gas

Hygiene Measures

Handle in accordance with good industrial hygiene and safety practice. Remove and wash contaminated clothing before re-use. Wash face, hands and any exposed skin thoroughly after handling.



Conditions for safe storage, including and incompatibilities

- Keep out of reach of children
- Keep container tightly closed
- Store in suitable labelled containers
- Storage temperature: -25°C to +30°C
- Storage humidity +5°C to +30°C 0 to non-condensing

Individual protective measures:

- Hand protection: Gloves

Dissolve

Dissolve in cold water – With no agitation, 1 tablet will take approx. 10 minutes to fully dissolve in the water used.



THE LIFT TAPE can be cleaned in the same manner as shown above using the concentrations shown within the table.

Please ensure the cloth used for this is damp and not wet as per the instruction above

The information above has been extracted from the Actichlor MSDS (Manufacturers Safety Data Sheet). For a full review of the data please follow the link below:
<http://www.nhsggc.org.uk/media/236215/msds-actichlor-plus.pdf>

15. Standards Applied

The standards that have been applied to the device are as follows:

- EN 60601-1-2 : 2015

Medical electrical equipment. General requirements for basic safety and essential performance. Collateral Standard. Electromagnetic disturbances. Requirements and tests

- EN 60601-1-1 :2006 +A12 : 2014

Medical electrical equipment. General requirements for basic safety and essential performance

- EN 10535; 2006

Hoists for the transfer of disabled persons. Requirement and test methods

16. Disposal

Please observe the local laws on recycling



Please respect the current laws for disposal within the community the device is being used within.

The relevant components utilised in the manufacture of the device that can be recycled at the end of the device life are:

Fully recyclables:

- Outer plastic cowling cover
- Inner metal aluminium frame
- Inner metal components such as the lift gear
- Initial packaging of the device (Cardboard)
- Plastic Mouldings – Wheels, Handset Dock etc.
- Metallic Fixing – screws etc.

Consideration should be made as to the best means of disposing:

- Battery
- PCB
- Handset
- Power Supply
- Wiring Looms, Electronic Switches & Connectors

Components that are not recyclable:

- Lift tape

17. Installation

Slings- (Type B applied part) All appropriate Mackworth slings can be used with this hoist

Carry bars- 300024- QRS- Mackworth Carry Bar
300101- QRS- Export Carry Bar

Trolley- 108060- Mackworth Track Trolley Set

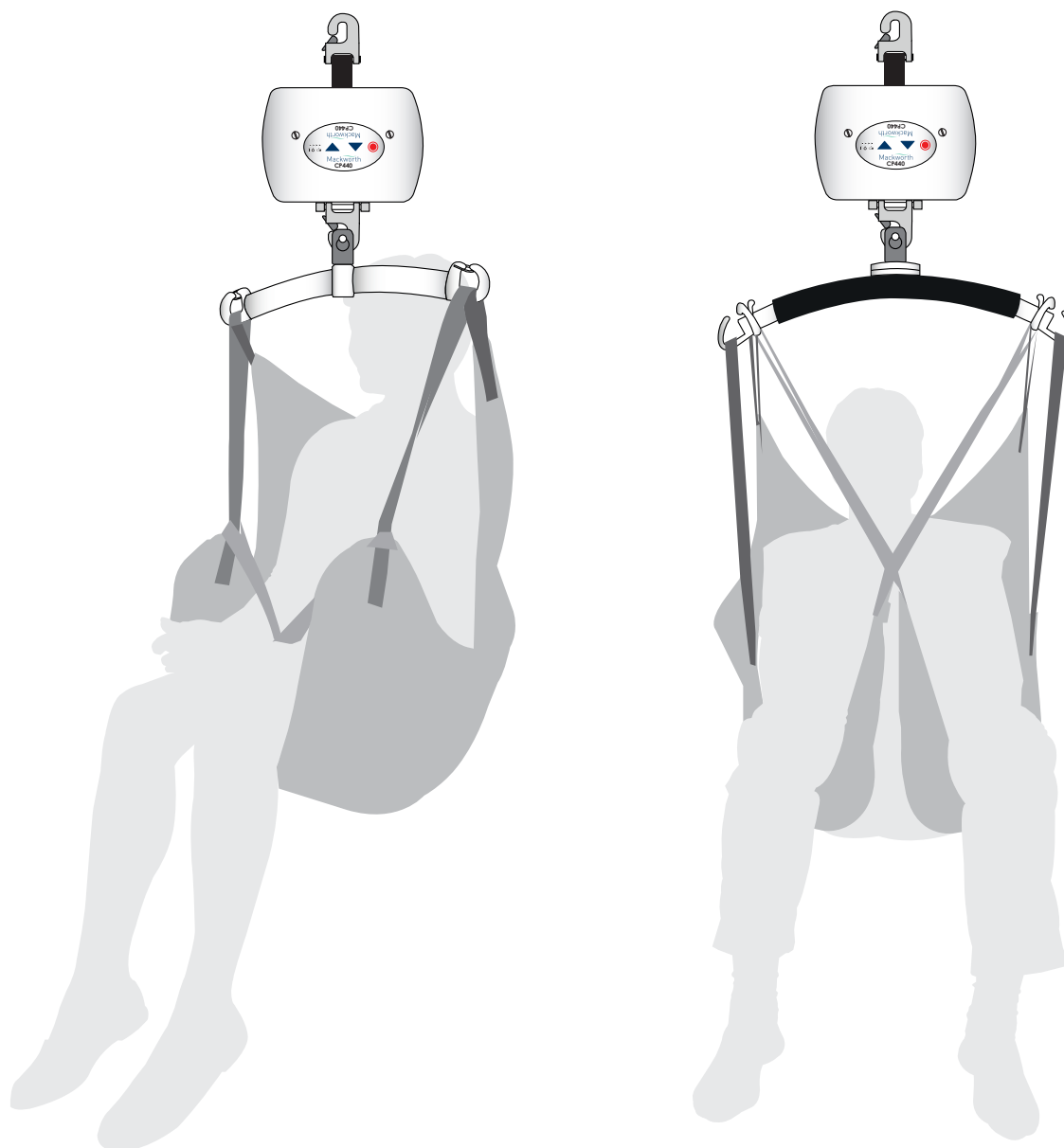

The way the sling is attached to the carry bar needs to be assessed on individual basis and documented in the patient's care plan. Furthermore the carer should reference the user manual for the specific sling in use as attachment points vary depending on the application and type.

Mackworth recommends the use of its manufactured sling range to be utilised with this device. However, it is at the users discretion to use alternative supplied product. In utilising another manufacturers sling, checks must first be made to ensure the sling is safe to use and meets the requirements of BS EN ISO 10535 before it's use.

CP440 Hoist

TEST CERTIFICATE

Safe Working Load: 200Kgs

Serial No:

Date of Test:

This Test Certificate confirms that the above numbered hoist has been full tested in accordance with the tests specified in:

- BS EN 10535 and has conformed fully therewith.

Signature of Tester

18. Warranty

This guarantee does not affect or in any way limit your Statutory Rights

1. Mackworth guarantees the CP440, supplied as new, against failure within the period of twelve months from the date of purchase by virtue of defects in material or workmanship.
2. The liability of Mackworth under terms of this guarantee shall be limited to the replacement or the defective part(s) to the sales distributor, dealer, agent, person or entity which purchased the equipment from Mackworth. In no event shall Mackworth incur liability for any consequential or unforeseeable losses.
3. This equipment guarantee shall be void if the equipment is not serviced by Mackworth or its authorised agents, in accordance with manufacturer's recommendations, or if any unauthorised persons carry out work on the equipment.
4. This guarantee does not apply to failure attributable to normal wear and tear, damage by natural forces, user neglect or misuse or to deliberate destruction.
5. Exemptions: Batteries will be guaranteed for a period of 90-days after original purchase.

19. Service Record History

19.1 Initial Information

- Complete the following section on Purchase and Service Information as soon as this equipment is supplied.
- Use the service record history to record to any completed service and repairs.
- Ensure that the service record is signed and dated each time it is used.
- Be sure to have this piece of equipment serviced on a regular basis (6 monthly where LOLER applies).

Purchase Information

Product name: CP440 hoist Model:

Date of purchase: Serial No.:

Purchased from:

Address:

City: Postal code:

Telephone number:

Comments:

Contact the following company for service

Company:

Address:

City: Postal code:

Telephone number:

Comments:

19.2 Service Record History

Complete this section after each service, repair inspection and/or maintenance.

* Photocopy additional pages as required*

Date:	Time:
Service Type: Periodic inspection <input type="checkbox"/> Monthly inspection <input type="checkbox"/> 6 inspection <input type="checkbox"/> Repair <input type="checkbox"/> Yearly inspection <input type="checkbox"/> Other	
Completed by: (printed name)..... (signature)	
Company:	
Remarks & Action Taken:	
Device left in a safe usable condition: YES <input type="checkbox"/> NO <input type="checkbox"/> if 'NO' explain in remarks the action) taken	

Date:	Time:
Service Type: Periodic inspection <input type="checkbox"/> Monthly inspection <input type="checkbox"/> 6 inspection <input type="checkbox"/> Repair <input type="checkbox"/> Yearly inspection <input type="checkbox"/> Other	
Completed by: (printed name)..... (signature)	
Company:	
Remarks & Action Taken:	
Device left in a safe usable condition: YES <input type="checkbox"/> NO <input type="checkbox"/> if 'NO' explain in remarks the action) taken	

Date:	Time:
Service Type: Periodic inspection <input type="checkbox"/> Monthly inspection <input type="checkbox"/> 6 inspection <input type="checkbox"/> Repair <input type="checkbox"/> Yearly inspection <input type="checkbox"/> Other	
Completed by: (printed name)..... (signature)	
Company:	
Remarks & Action Taken:	
Device left in a safe usable condition: YES <input type="checkbox"/> NO <input type="checkbox"/> if 'NO' explain in remarks the action) taken	

Date:		Time:	
Service Type: <input type="checkbox"/> Periodic inspection <input type="checkbox"/> Monthly inspection <input type="checkbox"/> 6 inspection <input type="checkbox"/> Repair <input type="checkbox"/> Yearly inspection <input type="checkbox"/> Other			
Completed by:		(printed name) (signature)	
Company:			
Remarks & Action Taken:			
Device left in a safe usable condition: YES <input type="checkbox"/> NO <input type="checkbox"/> if 'NO' explain in remarks the action) taken			

Date:		Time:	
Service Type: <input type="checkbox"/> Periodic inspection <input type="checkbox"/> Monthly inspection <input type="checkbox"/> 6 inspection <input type="checkbox"/> Repair <input type="checkbox"/> Yearly inspection <input type="checkbox"/> Other			
Completed by:		(printed name) (signature)	
Company:			
Remarks & Action Taken:			
Device left in a safe usable condition: YES <input type="checkbox"/> NO <input type="checkbox"/> if 'NO' explain in remarks the action) taken			

Date:		Time:	
Service Type: <input type="checkbox"/> Periodic inspection <input type="checkbox"/> Monthly inspection <input type="checkbox"/> 6 inspection <input type="checkbox"/> Repair <input type="checkbox"/> Yearly inspection <input type="checkbox"/> Other			
Completed by::		(printed name) (signature)	
Company:			
Remarks & Action Taken:			
Device left in a safe usable condition: YES <input type="checkbox"/> NO <input type="checkbox"/> if 'NO' explain in remarks the action) taken			

Date:		Time:	
Service Type: <input type="checkbox"/> Periodic inspection <input type="checkbox"/> Monthly inspection <input type="checkbox"/> 6 inspection <input type="checkbox"/> Repair <input type="checkbox"/> Yearly inspection <input type="checkbox"/> Other			
Completed by:		(printed name) (signature)	
Company:			
Remarks & Action Taken:			
Device left in a safe usable condition: YES <input type="checkbox"/> NO <input type="checkbox"/> if 'NO' explain in remarks the action) taken			

Date:		Time:	
Service Type: <input type="checkbox"/> Periodic inspection <input type="checkbox"/> Monthly inspection <input type="checkbox"/> 6 inspection <input type="checkbox"/> Repair <input type="checkbox"/> Yearly inspection <input type="checkbox"/> Other			
Completed by:		(printed name) (signature)	
Company:			
Remarks & Action Taken:			
Device left in a safe usable condition: YES <input type="checkbox"/> NO <input type="checkbox"/> if 'NO' explain in remarks the action) taken			

Date:		Time:	
Service Type: <input type="checkbox"/> Periodic inspection <input type="checkbox"/> Monthly inspection <input type="checkbox"/> 6 inspection <input type="checkbox"/> Repair <input type="checkbox"/> Yearly inspection <input type="checkbox"/> Other			
Completed by:		(printed name) (signature)	
Company:			
Remarks & Action Taken:			
Device left in a safe usable condition: YES <input type="checkbox"/> NO <input type="checkbox"/> if 'NO' explain in remarks the action) taken			

User notes

User notes

Mackworth



Mackworth
Millers Ave,
Brynmenyn,
Bridgend
CF32 9SZ

Tel: +44 (0)1656 721 818

For service please contact:
+44 (0) 844 980 2296

Disclaimer

While every effort has been made to ensure the accuracy of information contained in this user manual, no liability can be accepted by Mackworth for any errors or omissions. Mackworth operates a policy of continuous improvement. Specifications and other data are subject to change without notice.

