

Mackworth

M-Series Mobile Floor lift (M330, M350, M385 & M400)



User Manual

<u>User Manual Index</u>	<u>Page</u>
Symbols used	3
1. Introduction	4
2. Contraindications	5
3. Intended use / Overview of the M-Series Floor lift	5 to 6
4. Unpacking	7
5. Floor lift assembly instruction	8 to 9
6. Floor lift safety advice	10
7. Operating the floor lift	11
8. Folding for transportation / storage	12
9. Linak® Operating systems	
9a Jumbo care system	13
9b Homecare system	13
10. How to charge the floor lift battery	14
11. Daily maintenance checks	15
12. Maintenance and servicing	16 to 18
13. Recommended cleaning instruction	19 to 21
13. Generic spare parts listing	22
13. Technical spec	23 to 24
15. Slings	25
16. Carry bars	26
17. Fault finding / maintenance	26
18. Standards applied	27
19. Test certificate and Guarantee	28
19.1 Guarantee	29
20. Service record history	
20.1 Initial information	30
20.2 Service record history	31 to 34
21. User notes	35
22. Contact details	36

Symbols in use Index



Warning – Consult instructions for use



Caution – pinch point



Manufacturer



Please observe local laws on recycling



Two-person lift may be required



Refer to user manual



Date of manufacture



Serial number



CAUTION: DO NOT ATTEMPT TO USE THIS EQUIPMENT WITHOUT FIRST UNDERSTANDING THE CONTENTS OF THIS MANUAL.

1. Introduction

The floor lift can easily be operated by one person.

Before using this equipment, and to ensure the safe operation of your Mobile Floor lift, carefully read this entire manual, especially the section on “Cautions”.

The floor lift is designed to be used in conjunction with slings and accessories. Please refer to any user guides supplied with these components and refer to them while reviewing this manual.

Should any questions arise from reviewing this manual contact your local authorized representative.

Failure to comply with warnings in this manual may result in injury to either the operator, or the individual being lifted/transferred. Damage to the mobile floor lift and/or related components may also occur.

Be sure that the contents of this manual are completely understood prior to using this mobile floor lift. Store this manual with the documents included with the mobile floor lift and sling(s).

Contents of this manual are subject to change without prior written notice.

Ensure you are aware of the floor lift manufacturer's fitting instructions. Please identify if the floor lift requires a loop or clip fitting. If a clip fit sling is required, please refer to the enclosed clip instructions for use.



Do NOT use a clip fit sling on a loop designed spreader bar.

Do NOT use a loop designed sling on a stud/clip designed spreader bar.

2. Contraindications

There are no known “contraindications” associated with the usage of the mobile floor lift and its accessories, provided they are used as per manufacturer’s recommendations and guidelines.

However, it is recommended that a client specific assessment is completed by a trained and knowledgeable health care professional to determine the method of transfer.

The manufacturer does not recommend a required number of caregivers for the use of our products. This information and recommendation can only be provided after a thorough personalized, case specific assessment, as there are many factors that can influence these decisions.

It is however, “obligatory” that a client that is assessed as being an independent user of our ceiling floor lift technology have the ability to receive assistance, during the transfer, in the event of a floor lift malfunction or personal concern.

This assistance can be provided in the form of; a nearby qualified caregiver, a phone, a communication device etc.

3. Intended use / Overview of the M-Series Mobile Floor Lift

The mobile floor lift is a lifting aid used by health care professionals to transfer/lift clients.

The mobile floor lift makes it possible to move mobility impaired individuals with minimal strain or risk to the caregiver, while providing complete safety, dignity and comfort for the client.

The mobile floor lift is one of two components that make up this technology. The other component, the sling, is a specially designed fabric accessory that attaches to the mobile floor lift by means of a carry bar and straps, and holds an individual while the floor lift, or transfer takes place.

The sling is generally supplied with the mobile floor lift at the initial time of purchase.

Please refer to any user guides supplied with the sling and reference them while reviewing this manual.

The mobile floor lift has the ability to floor lift an individual up from one location such as bed, then move the individual to another location and finally lower the individual into a chair for example.

The functions of lifting up or down, or opening and closing the legs on the floor lift, are accomplished by pressing buttons on the hand control. The hand control is attached to the mobile floor lift.

Due to the design of the mobile floor lift system, it takes very little effort to press a button to perform the desired motion. Please familiarise yourself with the components of the mobile floor lift by referring to the diagram below.

Model table for the M-Series of Mobile Floor lifts	
Product code	Product description
M330 *	M330 Mobile floor lift (330lbs SWL)
M350 *	M350 Mobile floor lift (350lbs SWL)
M385 *	M385 Mobile floor lift (385lbs SWL)
M400 *	M400 Mobile floor lift (400lbs SWL)

* The numerical number in the product code relates to the SWL limits.

Illustration of key components

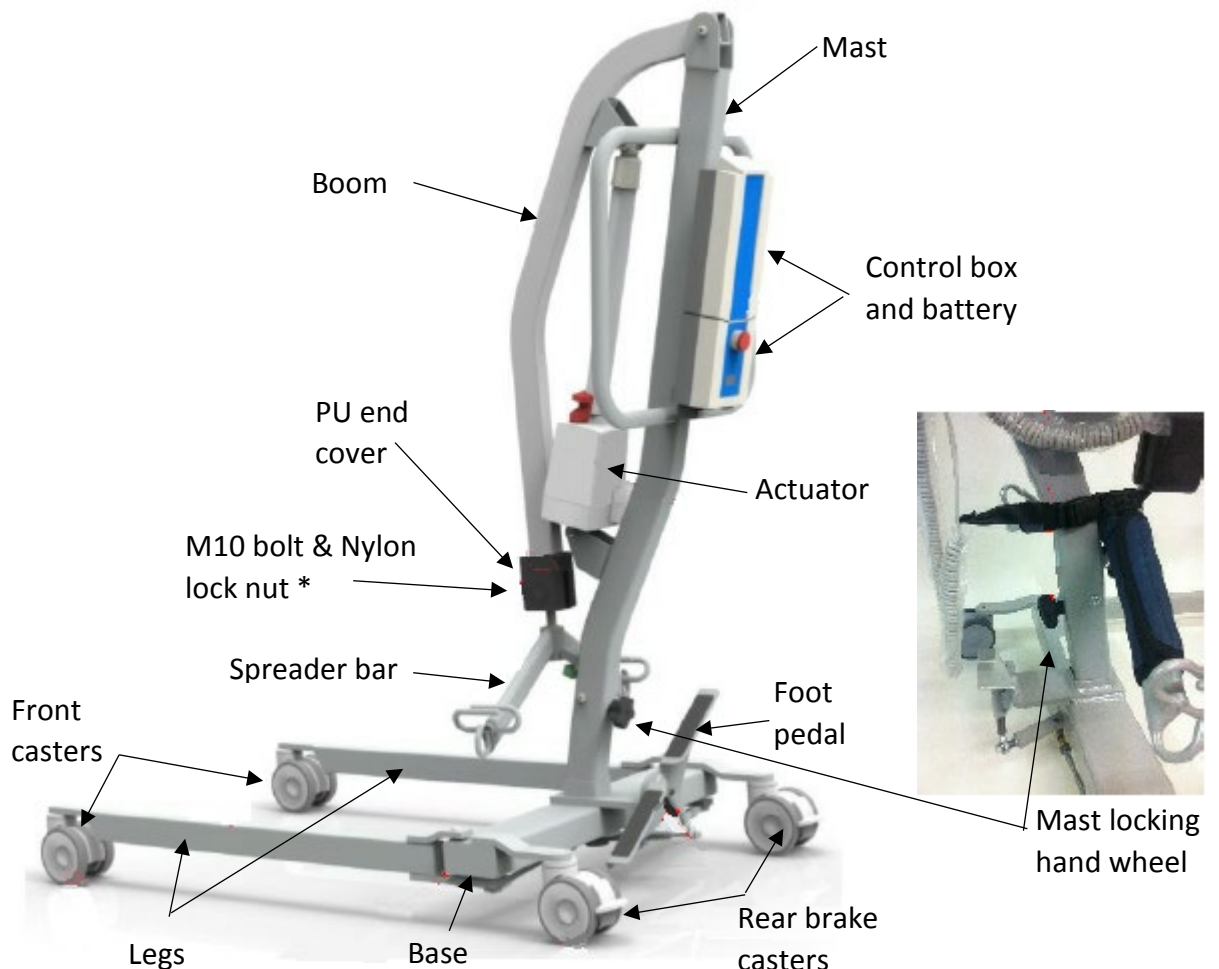

4. Unpacking



SAFETY NOTE: Some of the parts are heavy and will need to be lifted with care. Heavier items may need two people to lift. (Please refer to technical spec on page 20 to 21)

The floor lift will arrive to you in a robust box and is folded in position, please be careful when removing the floor lift from the box. This is a two man lifting operation or you can carefully remove the front of the box and wheel the floor lift out.

Please read the user guide in full before operating.

The floor lift is fully assembled and load tested before it leaves our premises and is supplied with a certificate of testing on page 25.

This handbook should be kept safe for future reference.

The Test Certificate is important and is valid for 6 months only, when the certificate has expired it **must** be renewed.

5. Floor lift assembly instruction

The Assembled Floor lift Carton Contains:

- Base fitted with 2 brake casters rear and 2 non-brake casters front
- Mast and boom assembly
- 2 Point spreader bar complete with cover, and new M10 Bolt and Nylon Lock Nut
- Mast locking hand wheel
- Hand set
- Battery Pack
- Control box
- Actuator
- Battery charging cable.



- a. Carefully open the box (**SAFETY NOTICE** - Do not use a sharp knife / edge) remove all loose parts / excess packaging from the carton.



- b. Carefully lift the floor lift out of the carton (**SAFETY NOTICE** - 2-person lift recommended or remove the end of the carton and wheel the floor lift out). Place the floor lift on a flat surface and ensure the rear braked casters are locked.



- c. Remove the black mast locking hand wheel from the top of the assembly, then carefully lift the mast upright ensuring the mast drops into position. (**SAFETY NOTICE** - Please ensure both hands are on the handles when lifting the mast into position, possible risk of finger trap).

- d. Ensure all cables are routed correctly and are clear of the base / mast when lifting into position.



- e. When the mast is fully engaged with the base, fit and fully tighten the mast locking hand wheel. (**SAFETY NOTICE** - Ensure this is tight and locked into position before using the floor lift). Remove the strap and buckle retaining the spreader bar, the strap should be kept safe and should be used if the floor lift is folded for transport.

Floor lift assembly instruction (continued...)

- i. Ensure the mast is fully seated in position before securing the mast locking hand wheel
- ii. Mast locking hand wheel must be secure before use

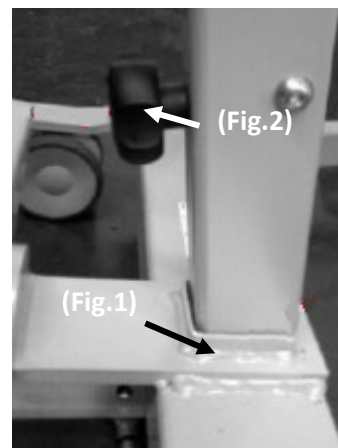

- f. The foot pedal will open and close the legs simply by activating one side with your foot.
- g. Ensure the emergency stop button (RED) on the control box is in the out position.

Emergency stop button



- h. Confirm all cables are located and secure, before operation the floor lift ensure the strap & buckle is removed. Press the up button on the handset and confirm the boom rises. Your floor lift is now ready to use.

Strap and buckle



6. Floor lift safety advice



Please ensure you read the following safety advice. This will ensure lifting operations are made easy and trouble free.

- Always carry out the risk assessment and plan your lifting operations before commencing and moving & handling practice.
- Always carry out the daily check list before using the floor lift.
- Always read the user manual and ensure you are familiar with the operating controls and safety features of the lift before lifting a patient.
- Always check the safe working load (SWL) of the floor lift is suitable for the weight of the patient.
- Always carry out lifting in accordance with the instructions in the user manual.
- Never disconnect or bypass a control or safety feature on the floor lift.
- Never force an operating or safety control, excess force could damage the feature.
- Always maneuver the floor lift using the handles provided, these are designed to aid ease of transport.
- Do not push a load at excess speed.
- Do not push the floor lift over rough or uneven ground.
- Do not push the floor lift down steps.
- Do not attempt to lift a patient on a slope.
- Always apply the brakes when parking the floor lift.
- Never use electric floor lifts in a shower.
- Never charge the floor lift in a damp environment, e.g. bathroom or shower room.
- Your lift is for patient lifting. Do not use it for any other purpose.
- Ensure you follow a regular battery charging routine to prolong the life of the battery.

7. Operating the floor lift

- 7.1 Casters & Braking - The floor lift has two braked casters at the rear of the base. The brakes should only be applied when the lift is parked. The brakes should always be released when a lifting operation is taking place.
- 7.2 Leg Opening & Closing - The floor lift legs can be opened for access into and around riser recliner chairs, wheelchairs etc. The legs should be closed when transferring and negotiating narrow doorways and confined spaces. You can operate the leg opening device by pressing down onto the pedal, this will activate the opening or closing mechanism.
- 7.3 Emergency Stop Button - The big red emergency stop button located on the front of the control box is activated by pressing the button in.
Note: This will cut all power to the floor lift. It can easily be reset by twisting the button clockwise to release.
- 7.4 Raising & Lowering The Boom - The boom can be raised and lowered by the powerful 1800lbf (8,000N) and 2250lbf (10,000N) motor (M350 and M400 respectively), this is activated by a hand set that has directional arrows indicating up and down movement. The hand set is plugged into the base of the control box. The actuator will stop at the end of each full stroke.
- 7.5 Battery - The battery is protected from full discharge by a low voltage alarm & illuminated LED (this can vary pending the model of control box used). This will sound or illuminate when the battery needs recharging. Complete the lift and place on charge. Do not ignore this warning! See charging a battery on page 14

User Note:

The control boxes utilized within the devices use internal relay switches for actuator operation.

Pressing a hand controller button energizes this control box relay with a small magnetic field, causing it to close. Releasing the hand controller button de-energizes the control box relay, causing it to open.

Immediately “re-pressing” the relevant control button before the relay’s magnetic field has had time to reset will result in no additional activation.

This is not a fault of the system and no damage is caused by this process. If this situation occurs, please release the control button for two seconds and then press again. By this time the magnetic field will have dissipated and the operation of the button will re-energize the switch enabling further use.

8. Folding for transportation / storage (folding mast type only)

- 8.1 Lower the boom with the hand set until the spreader bar sits on the steel bracket. Attach the strap & buckle around the mast and spreader bar, this ensures the mast is secure and clear from the floor when folded.
- 8.2 Apply the rear brakes.
- 8.3 Unscrew / remove the mast locking hand wheel.
- 8.4 Carefully lift the mast slightly and push / fold it forward towards the base
- 8.5 Replace / tighten the mast locking hand wheel.



(fig.3) above: Lower the boom with the handset

(fig.4) above: Place spreader bar onto the bracket and secure with the strap and buckle

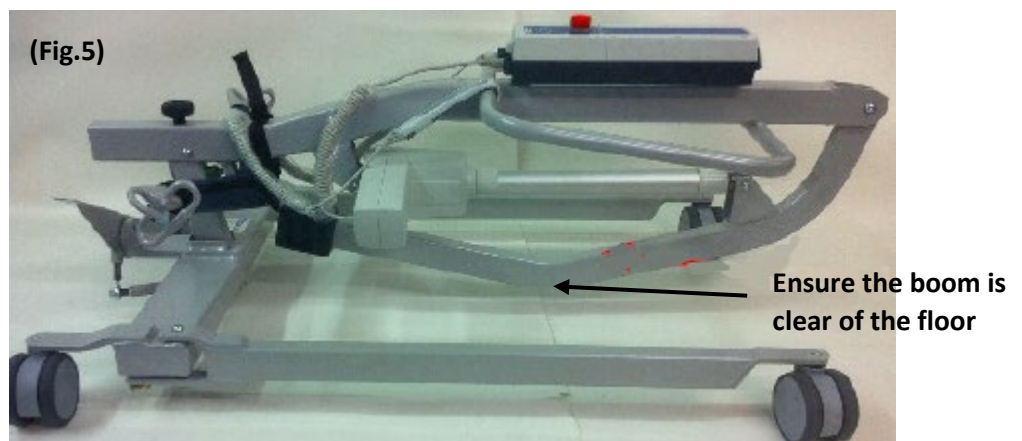

(fig.5) above: secure the rear brakes. Fold the mast and replace the hand wheel. Take care not to overtighten the hand wheel.

9. Linak® Operating System

a. Jumbo care system – Typical Illustration



1. Linak® battery pack
2. Linak® control box
3. Linak® actuator
4. Linak® handset

b. Homecare system – Typical illustration

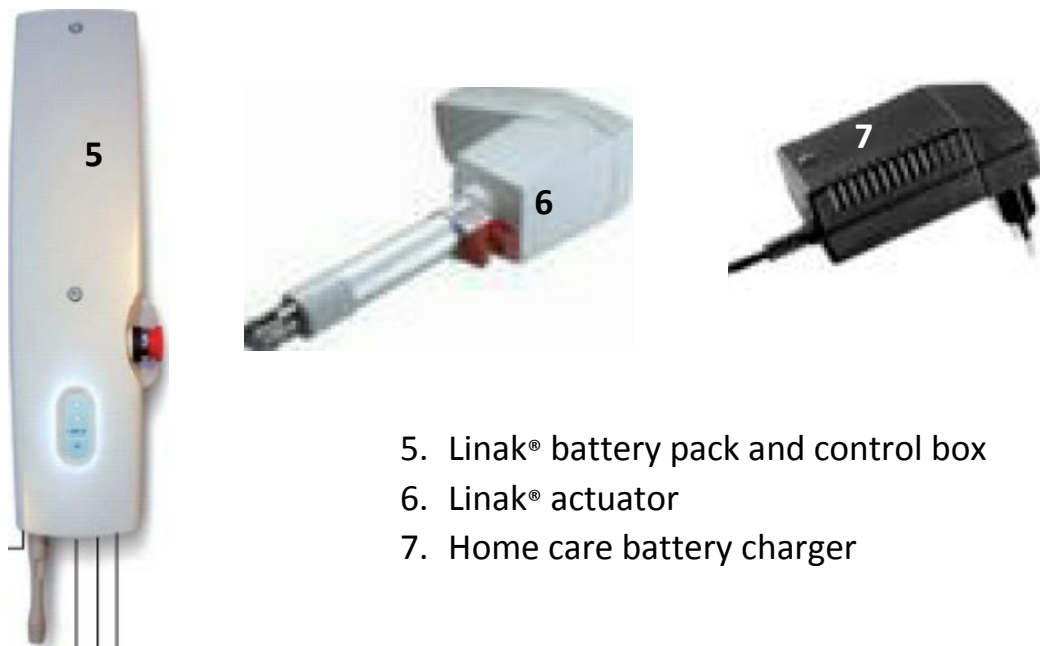

5. Linak® battery pack and control box
6. Linak® actuator
7. Home care battery charger

8

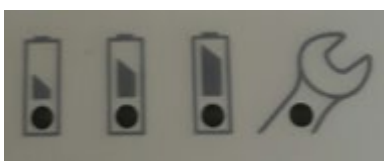

8.

10. How to charge the floor lift battery

There are a number of batteries located in the power pack / battery housing. They are charged through a shaver type socket in the base of the control unit. When charging is required the 3 pin mains lead is plugged into a wall socket and the shaver type socket goes into the base of the control box.

- a. Fit the mains power lead shaver type socket in the base of the control box.
- b. Plug the charger mains plug into a suitable mains outlet and switch the mains supply on. (The RED Emergency Stop button has to be out for the battery pack to charge)
- c. Charging the battery is automatic and will normally take eight to twelve hours to fully charge. (You cannot overcharge the batteries if left for long periods of time).
- d. To return the floor lift to use, switch off the mains supply. Remove the shaver type plug from the socket at the base of the control box. The floor lift is now ready for use.

Please pay attention to the following points to avoid any problems with discharging batteries:

- Keep the batteries fully charged.
- The batteries should never be allowed to run completely dead.
- The power pack should never be stored for long periods of time without a regular charge.
- Do not leave the power pack plugged into the charger with the main power off.
- Regularly check the battery charger indicator, this will be on the control box or handset.

11. Daily maintenance checks

11.1 Visual check list

These are recommended to be carried out before the floor lift is used for any moving & handling practice.

- a. CHECK that the legs open and close correctly.
- b. CHECK that the floor lift moves freely on its casters.
- c. CHECK that the spreader bar is free to rotate and swing.
- d. CHECK the spreader bar fixing/M10 bolt & nylon lock nut is secure.
- e. CHECK that the sling hooks on the spreader bar are free from excessive wear.
- f. CHECK the hand control lowers and raises the boom satisfactorily.
- g. CHECK the operation of the emergency stop button.
- h. CHECK that the floor lift is charged to a satisfactory level of use.
- i. CHECK that the locking Mast Hand Wheel is tightened and secured fully.

If in doubt DO NOT USE

12. Maintenance & Servicing

This maintenance must be carried out by a competent person and is a US regulation. The inspection must take place every 6 months. Please see page 17 to 18 for illustrations to help with Key Safety Checks.

- a. **Certification:** An authorized/competent service company or person will issue a test certificate.
- b. **Batteries:** The batteries are located in the Battery Pack and should not require maintenance other than the regular charging as detailed in the charging instructions.
- c. **Emergency down:** Check the emergency down functionality. **(see illustrated image below (fig.6))**
- d. **Actuator:** The actuator should require no maintenance other than checking for correct operation, listening for unusual noise and checking for any damage. **(see illustrated image below (fig.6))**
- e. **Castors:** Check the rear brake on the caster. Check all caster fixing points. Check that the caster runs free and rotates easily. Remove any build-up of hair, fluff, dust etc. Lubricate if necessary with a very light mineral based grease.
- f. **Leg pivot points / under carriage:** Operate the foot pedal and ensure a smooth opening and closing of the legs. Check the steel leg linkages are secure. Adjust the steel linkages if necessary to align the legs. Check all the screws in the under-carriage are secure, if loose secure with Loctite®. **(see illustrated image below (fig.7))**
- g. **Battery pack:** Check the functionality of the emergency stop button. Inspect all male and female sockets for correct fitting. Inspect the hand control functionality.
- h. **Mast:** Ensure the mast fully engages into the base housing. Check the operation of the mast locking hand wheel. Check the actuator mounting brackets for excessive wear.
- i. **Boom:** Check the attachment of the boom to the mast, ensure all fixing points are secure and free from wear. Check the boom can rotate freely and there is no excess movement of the boom in both directions.

Maintenance & servicing (continued...)

- j. **Spreader bar:** Check the spreader bar rotates and swings freely. Check the central pivot M10 bolt and nylon lock nut for excessive

wear. Check the fixing point for excessive wear and inspect the sling hooks for any damage, sharp edges and excessive wear. **(see illustrated image below (fig.8))**

Illustrations for key check points as indicated above in points 1. To 11.



Emergency
lowering
down

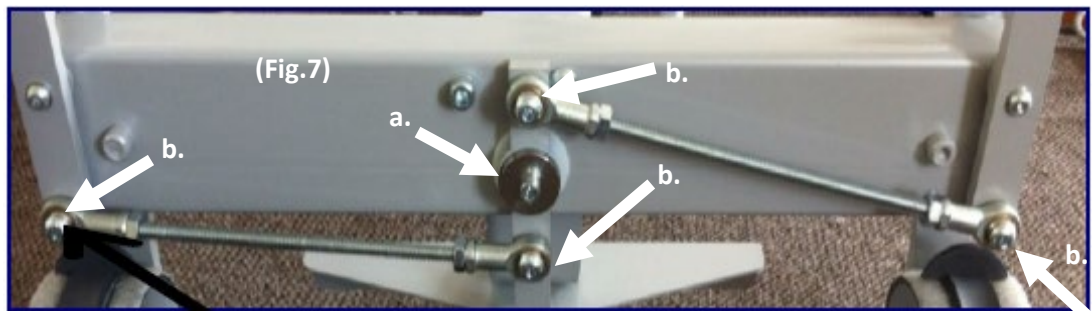

- a. Centre pivot point screw secure with thread lock x 1.
- b. Track rods screws secure with thread lock and tighten nuts x 4 positions



(fig.8) Ensure hooks are not damaged

(fig.8) Ensure the M10 bolt, nylon lock nut and 2 washers are in position and secure

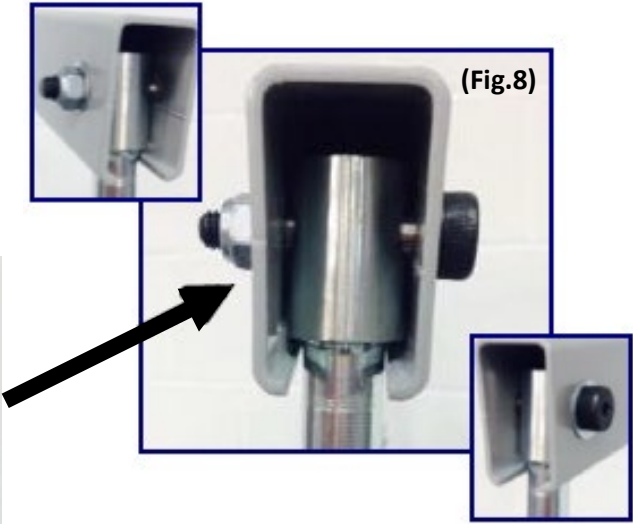

13. Recommended Cleaning Instruction

General cleaning



The exterior of the Floor lift can be cleaned using a damp soapy cloth for general cleaning duties. **Please ensure the cloth is damp and not wet.** Ensure the exterior of the device is dry after cleaning, dry using a clean dry cloth. **Care should always be taken when cleaning around electrical components**

Disinfecting (if necessary)

Should the Floor lift require a more thorough clean, the use of the Actichlor disinfectant product, which is widely available in tablet form and used throughout the healthcare industry, is recommended for use to ensure a thorough clean.



- Please follow the manufacturer's safety instruction for the use of the cleaning product before use to ensure safe use for the operator and the patient.
- Ensure the cloth is **damp** before the cleaning process. **DO NOT** use a wet cloth over electrical systems.
- Be careful not to let water ingress into the device as although the device is IP rated, it is not water tight.

Application is through a clean soaked (but damp) cloth applied to wipe the device down

Used in the following dilutions to ensure an effective clean:

- Actichlor dissolvable chlorine tablets provide a concentration of 1000 ppm of available chlorine (0.1%) per 1 tablet
- 1 tablet (1.7g formed tablet (x1)) will create a virucidal solution, diluted in 1 litre of water to provide effective means to clean a "Dirty" device. This is also ideal for use after an outbreak of the Norovirus / winter vomiting and can be used as a precaution against C.Diff. It is effective against viruses, bacteria, spores, yeasts and moulds.
- The contact time against the outer components of the device should be for 5 minutes to prevent any virucidal infections without a degradation to the functionality of the device. 5 minutes is a recommended contact time. The device can withstand a longer contact period but the 5 minute recommendation as a minimum must be followed to provide an effective cleaning regime.
- Blood spills should be dealt with by an increased concentration of the solution – please refer to the instructions on the manufacturers product labelling.

(recommended cleaning instruction...continued)

Concentration limits for differing cleans will be shown on the manufacturers Ahtochlor tablet container, however, this is reflected in the table below:

Dilution chart					
Product used as:	Device condition	Concentration (ppm)	Dilution qty *	Tablets per 0.26gal (1l)	Contact time
Bactericidal	Clean	200	1.32gal (5l)	1	1 minute
	Dirty	1000	0.26gal (1l)	1	5 minutes
Yeasticidal	Clean	200	1.32gal (5l)	1	1 minute
	Dirty	1000	0.26gal (1l)	1	5 minutes
Fungicidal	Clean	2000	0.26gal (1l)	2	15 minutes
	Dirty	5000	0.26gal (1l)	5	15 minutes
Mycobactericidal	Clean	1000	0.26gal (1l)	1	15 minutes
	Dirty	5000	0.26gal (1l)	5	15 minutes
Virucidal	Clean	500	0.53gal (2l)	1	5 minutes
	Dirty	1000	0.26gal (1l)	1	5 minutes
Sporcidal (C.Diff)	Clean	1000	0.26gal (1l)	1	10 minutes
Sporicidal	Clean	5000	0.26gal (1l)	5	10 minutes

* Dilution is made within water

- When diluted in water, one tablet gives 1000 ppm of available chlorine **DO NOT** dilute within any other medium
- The concentration of the solution depends upon whether the device being cleaned is noticeably dirty or not (indicated in the table by "Device Condition")

Safety precautions when using this cleaning agent

Handling and Storage:

Advice on Safe Handling



Avoid contact with skin and eyes. Do not breathe dust / fumes / gas / mist / vapors / spray. Use only with adequate ventilation
Wash hands thoroughly after handling. Mixing this product with acid or ammonia releases chlorine gas

Hygiene Measures

Handle in accordance with good industrial hygiene and safety practice. Remove and wash contaminated clothing before re-use. Wash face, hands and any exposed skin thoroughly after handling.

(recommended cleaning instruction...continued)

Conditions for safe storage, including and incompatibilities



- Keep out of reach of children
- Keep container tightly closed
- Store in suitable labelled containers
- Storage temperature: 0°C to 25°C

Individual protective measures:

- Hand protection: Gloves

Dissolve

Dissolve in cold water – With no agitation, 1 tablet will take approx. 10 minutes to fully dissolve in the water used.

The information above has been extracted from the Actichlor MSDS (Manufacturers Safety Data Sheet). For a full review of the data please follow the link below:

<http://www.nhsggc.org.uk/media/236215/msds-actichlor-plus.pdf>

14. Generic spare parts listing

Details of the spares available upon request

Order code	Description
H1 – Battery	Linak® battery pack for floor lift
H1 – Battery fixing bracket	Linak® bracket for battery & control box
H1 – Caster front	Front caster low height
H1 – Caster braked rear	Rear braked caster low height
H1 – Control box	Linak® control box
H1 – Base frame	Base frame for floor lift c/w foot pedal
H1 – Leg (Left or Right)	Leg for floor lift
H1 – Handset	Linak® handset
H1 – Mains cable US	Linak® mains cable US
H1 – Mast retaining strap	Mast retaining strap and buckle
H1 – Mast hand wheel	M8 hand wheel for securing the mast
H1 – Boom	Boom only for floor lift
H1 – Mast	Mast upright with handle – only for floor lift
H1 – Actuator	Linak® actuator LA34
H1 – PU end cap	PU end cap for floor lift
H1 – Spreader bar cover	PU cover for spreader bar
H1 – Spreader bar	Powder coated spreader bar
H1 – Spreader bar M10 bolt & nylon lock nut	M10 bolt & nylon lock nut for spreader bar

15. Technical Specifications

(all shown dimensions are in centimetres)

15.1 – Dimensional

Total weight: 39kgs

Actuator thrust: M350 - 8,000N | M400 - 10,000N

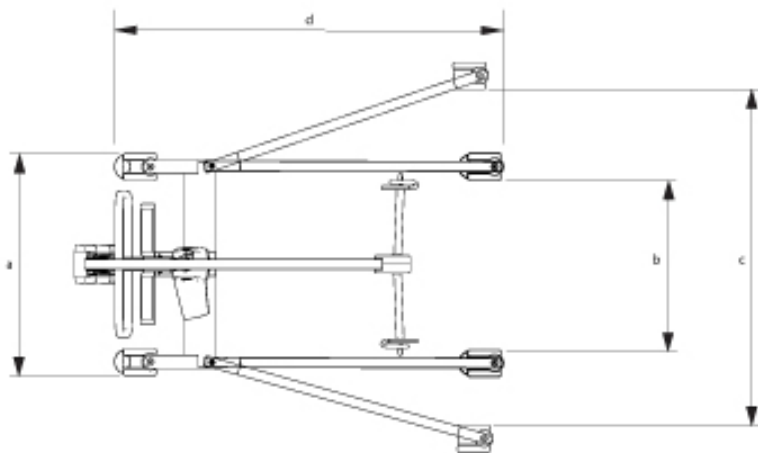

Model	M350	M400
a	25.8"	26.8"
b	20.3"	20.1"
c	39.0"	37.2"
d	46.9"	47.4"

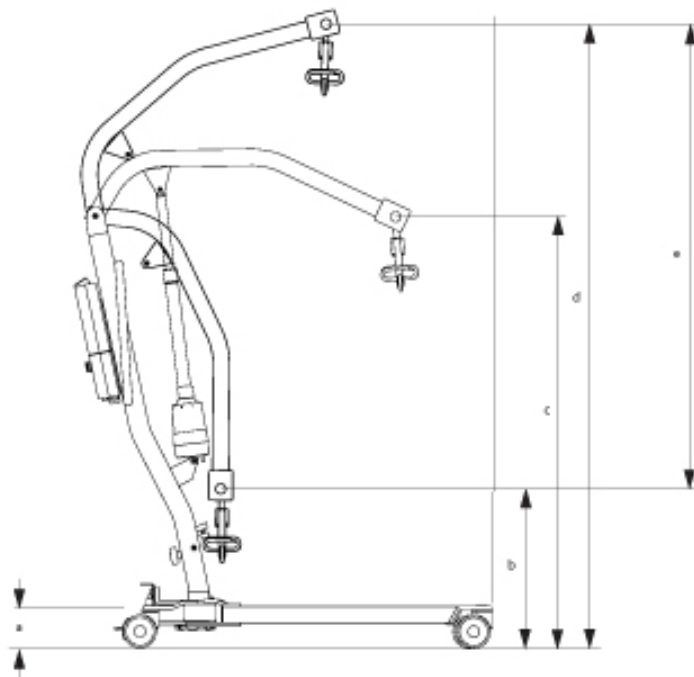

Model	M350	M400
a	4.5"	4.4"
b	18.1"	17.8"
c	5.1"	5.1"
d	70.1"	75.2"
e	52.0"	57.4"

Technical specifications (continued...)

15.2 Electrical specifications:

- Batteries 2 x 12-volt rechargeable sealed lead acid.
- Battery Capacity 2.9 Ampere / hours
- Charger Rated Input 230Vac 50/60Hz
- Charger Rated Output 27.4 / 29.0 VDC @ 0.8A

15.3 Electric Shock Protection:

- Charger - Class II *Lift - Internal Power Source
- Degree of Shock Protection - Type B *Lift - Internal Power Source
- Duty Cycle 10% (6 minutes per hour)
- IP rating, control box – IPX4
- IP rating, handset – IPX4

15.4 Sound Levels:

- Loaded Up 41.7dBA / Down 40.9dBA
- Unloaded Up 38.5 dBA / Down 38.5dBA

15.5 Expected Product Lifetime:

- 10 yrs pending usage and compliance to maintenance, servicing and LOLER inspections.

Shipping/Storage Conditions:

- Temperature: -40°F to 158°F (-40 to +70°C)
- Relative Humidity: 10 to 100% RH
- Atmospheric Pressure: 500 to 1060 hPa

Normal Operating Conditions:

- Temperature: 50°F to 158°F (+10 to +70°C)
- Relative Humidity: 30 to 75% RH
- Atmospheric Pressure: 700 to 1060 hPa



Type B applied part

16. Slings

Sling types (this is not an exhaustive list) check supplier for available slings

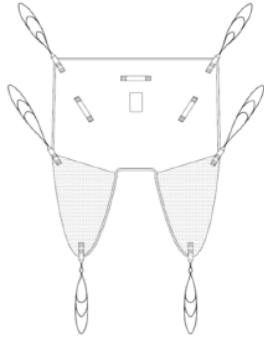

Universal sling

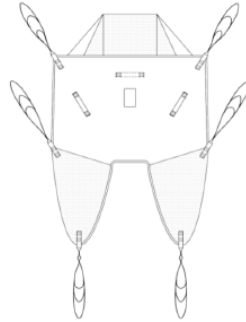

Universal C/W
Head support

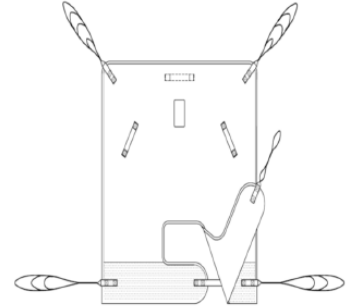

Hammock sling

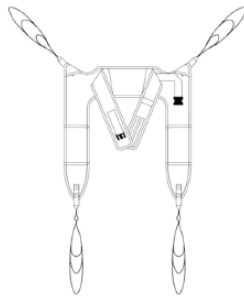

Dual access sling

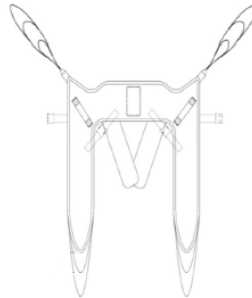

Dual access SRS sling

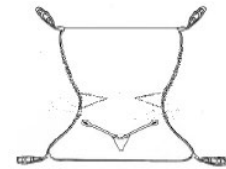

Comfort recline

The range of slings are the result of many years of experience in assessment and clinical expertise, combined with input from professional workers and users of slings. As a result, the range is a collection of subtly unique designs, combined with the use of modern materials and technology which produces comfort, security, support and dignity for the user, and aids correct application of the sling by the caregiver.

The range of slings are equally suitable for Mobile and Ceiling track floor lifts. All our slings are produced here in the UK and carry the CE mark. They are manufactured to the highest standard under a rigorous quality management system. Contact Your Local Representative for more information

17. Carry bars

Carry Bars

Although the manufacturer supplies carry bars specifically to be used with the associated devices it manufactures, there is no reason that other manufactured carry bar systems cannot be used **BUT** they must be

done so after a full risk analysis has been carried out for its use on the Mackworth floor lift system to ensure safe use can be established.

Carry Bar connection points

The carry bars associated for use with this device, incorporates two attaching points which is not new technology and the attachment can be derived by user by means of a simple connection made by the sling to the carry bar itself. This connection system is used throughout the industry in various designs but all act as the means to hold the sling and user in place through operation of the device while in use.

18. Fault Finding / Maintenance

17.1 Fault Finding

If the floor lift will not operate:

- Ensure that the emergency stop is in the OUT position.
- Make sure the charging lead is disconnected from the mains power supply
- Check the handset lead has not been pulled from the control box socket or the wires damaged.

If the above checks prove unsuccessful, contact the service department of your nearest Mackworth approved agent.

19. Standards Applied

The standards that have been applied to the device are as follows:

- BS EN 60601-1-2
Medical electrical equipment. General requirements for basic safety and essential performance. Collateral Standard. Electromagnetic disturbances. Requirements and tests

- BS EN 60601-1
Medical electrical equipment. General requirements for basic safety and essential performance
- BS EN ISO 10535
Floor lifts for the transfer of disabled persons. Requirements and test methods

19.1 - EMC – Electromagnetic emissions statement

The device complies with the requirements of BS EN ISO 60601-1-2 – (Medical electrical equipment. General requirements for basic safety and essential performance. Collateral Standard. Electromagnetic disturbances. Requirements and tests)

Should the device come into contact with a similar device having the requirements to meet EMC performance, the reciprocal interference would be eliminated.

20. Test certificate and Guarantee

M Series Mobile Floor lifts

TEST CERTIFICATE

Model: M330 M350 M385 M400

Safe Working Load: 330lbs 350lbs 385lbs 400lbs

Serial No:

Date of Test:

This Test Certificate confirms that the above numbered floor lift has been fully tested in accordance with the tests specified in:

- BS EN 10535 and has conformed fully therewith.

Signature of Tester

20.1 Guarantee

Mackworth Healthcare warrants this product against any defects in manufacturing and assembly of mechanical and electronic components.

This warranty is for devices used only in accordance with our terms of use. This warranty, whose terms of use are defined below, is valid for the following:

- Steel Frame - 36 months
- Actuator - 60 months.
- All other components - 12 months

The warranty entitles free replacement for defective parts only, exclusive of labor. Mackworth Healthcare will bear all return costs if the warranty claim is valid after a full investigation.

Additional information may be required to support such a claim.

Out of warranty items - The return costs will be paid by the customer and the repair will be priced and a purchase order will be required prior to the work commencing.

The warranty does not apply if the claims are consecutive to:

- Accident, misuse or neglect of the unit by the end user/customer.
- Shipping performed without suitable packaging / protection.
- Alteration or transformation of the original design.
- The impact of external elements (Natural Disasters, Fire, Humidity, Floods Etc)
- Lack of routine maintenance / care in line with our daily checks / the information within this user guide.

Exemptions: Batteries will be guaranteed for a period of 90-days after original purchase.

21. Service Record History

21.1 Initial Information

Complete the following section on Purchase and Service Information as soon as this equipment is purchased.

- Use the service record history to record to any completed service and repairs.
- Ensure that the service record is signed and dated each time it is used.
- Be sure to have this piece of equipment serviced on a regular basis as described in the General Inspection and Maintenance Section.
- Be sure to have this piece of equipment serviced on a regular basis (6 monthly where LOLER applies).

Purchase Information

Product name: M Series Mobile Floor lift

Model: M330 M350

M385 M400

Date of purchase: **Serial No.:**

Purchased from:

Address:

City: **Postal code:**

Telephone number:

Comments:

Contact the following company for service

Company:

Address:

City: **Postal code:**

Telephone number:

Comments:

21.2 Service Record History

Complete this section after each service, repair inspection and/or maintenance.

* Photocopy additional pages as required*

Date: _____		Time: _____	
Service Type: <input type="checkbox"/> Periodic inspection <input type="checkbox"/> Monthly inspection <input type="checkbox"/> 6-month inspection <input type="checkbox"/> Repair <input type="checkbox"/> Yearly inspection <input type="checkbox"/> Other			
Completed by: (printed name).	 (signature)	
Company:			
Remarks & Action Taken:			
Device left in a safe usable condition: YES. <input type="checkbox"/> NO <input type="checkbox"/> (if "NO" explain in remarks the action taken)			

Date: _____		Time: _____	
Service Type: <input type="checkbox"/> Periodic inspection <input type="checkbox"/> Monthly inspection <input type="checkbox"/> 6-month inspection <input type="checkbox"/> Repair <input type="checkbox"/> Yearly inspection <input type="checkbox"/> Other			
Completed by: (printed name).	 (signature)	
Company:			
Remarks & Action Taken:			
Device left in a safe usable condition: YES. <input type="checkbox"/> NO <input type="checkbox"/> (if "NO" explain in remarks the action taken)			

Date: _____		Time: _____	
Service Type: <input type="checkbox"/> Periodic inspection <input type="checkbox"/> Monthly inspection <input type="checkbox"/> 6-month inspection <input type="checkbox"/> Repair <input type="checkbox"/> Yearly inspection <input type="checkbox"/> Other			
Completed by: (printed name).	 (signature)	
Company:			
Remarks & Action Taken:			
Device left in a safe usable condition: YES. <input type="checkbox"/> NO <input type="checkbox"/> (if "NO" explain in remarks the action taken)			

Date: _____		Time: _____	
Service Type: <input type="checkbox"/> Periodic inspection <input type="checkbox"/> Monthly inspection <input type="checkbox"/> 6-month inspection <input type="checkbox"/> Repair <input type="checkbox"/> Yearly inspection <input type="checkbox"/> Other			
Completed by: (printed name).	 (signature)	
Company:			
Remarks & Action Taken:			
Device left in a safe usable condition: YES. <input type="checkbox"/> NO <input type="checkbox"/> (if "NO" explain in remarks the action taken)			

Date: _____		Time: _____	
Service Type: <input type="checkbox"/> Periodic inspection <input type="checkbox"/> Monthly inspection <input type="checkbox"/> 6-month inspection <input type="checkbox"/> Repair <input type="checkbox"/> Yearly inspection <input type="checkbox"/> Other			
Completed by: (printed name).	 (signature)	
Company:			
Remarks & Action Taken:			
Device left in a safe usable condition: YES. <input type="checkbox"/> NO <input type="checkbox"/> (if "NO" explain in remarks the action taken)			

Date: _____		Time: _____	
Service Type: <input type="checkbox"/> Periodic inspection <input type="checkbox"/> Monthly inspection <input type="checkbox"/> 6-month inspection <input type="checkbox"/> Repair <input type="checkbox"/> Yearly inspection <input type="checkbox"/> Other			
Completed by: (printed name).	 (signature)	
Company:			
Remarks & Action Taken:			
Device left in a safe usable condition: YES. <input type="checkbox"/> NO <input type="checkbox"/> (if "NO" explain in remarks the action taken)			

Date: _____		Time: _____	
Service Type: <input type="checkbox"/> Periodic inspection <input type="checkbox"/> Monthly inspection <input type="checkbox"/> 6-month inspection <input type="checkbox"/> Repair <input type="checkbox"/> Yearly inspection <input type="checkbox"/> Other			
Completed by: (printed name).	 (signature)	
Company:			
Remarks & Action Taken:			
Device left in a safe usable condition: YES. <input type="checkbox"/> NO <input type="checkbox"/> (if "NO" explain in remarks the action taken)			

Date: _____		Time: _____	
Service Type: <input type="checkbox"/> Periodic inspection <input type="checkbox"/> Monthly inspection <input type="checkbox"/> 6-month inspection <input type="checkbox"/> Repair <input type="checkbox"/> Yearly inspection <input type="checkbox"/> Other			
Completed by:		(printed name). (signature)	
Company:			
Remarks & Action Taken:			
Device left in a safe usable condition: YES. <input type="checkbox"/> NO <input type="checkbox"/> (if "NO" explain in remarks the action taken)			

Date: _____		Time: _____	
Service Type: <input type="checkbox"/> Periodic inspection <input type="checkbox"/> Monthly inspection <input type="checkbox"/> 6-month inspection <input type="checkbox"/> Repair <input type="checkbox"/> Yearly inspection <input type="checkbox"/> Other			
Completed by:		(printed name). (signature)	
Company:			
Remarks & Action Taken:			
Device left in a safe usable condition: YES. <input type="checkbox"/> NO <input type="checkbox"/> (if "NO" explain in remarks the action taken)			

Date: _____		Time: _____	
Service Type: <input type="checkbox"/> Periodic inspection <input type="checkbox"/> Monthly inspection <input type="checkbox"/> 6-month inspection <input type="checkbox"/> Repair <input type="checkbox"/> Yearly inspection <input type="checkbox"/> Other			
Completed by:		(printed name). (signature)	
Company:			
Remarks & Action Taken:			
Device left in a safe usable condition: YES. <input type="checkbox"/> NO <input type="checkbox"/> (if "NO" explain in remarks the action taken)			

Date: _____		Time: _____	
Service Type: <input type="checkbox"/> Periodic inspection <input type="checkbox"/> Monthly inspection <input type="checkbox"/> 6-month inspection <input type="checkbox"/> Repair <input type="checkbox"/> Yearly inspection <input type="checkbox"/> Other			
Completed by:		(printed name). (signature)	
Company:			
Remarks & Action Taken:			
Device left in a safe usable condition: YES. <input type="checkbox"/> NO <input type="checkbox"/> (if "NO" explain in remarks the action taken)			

Date: _____		Time: _____	
Service Type: <input type="checkbox"/> Periodic inspection <input type="checkbox"/> Monthly inspection <input type="checkbox"/> 6-month inspection <input type="checkbox"/> Repair <input type="checkbox"/> Yearly inspection <input type="checkbox"/> Other			
Completed by:		(printed name). (signature)	
Company:			
Remarks & Action Taken:			
Device left in a safe usable condition: YES. <input type="checkbox"/> NO <input type="checkbox"/> (if "NO" explain in remarks the action taken)			

Date: _____		Time: _____	
Service Type: <input type="checkbox"/> Periodic inspection <input type="checkbox"/> Monthly inspection <input type="checkbox"/> 6-month inspection <input type="checkbox"/> Repair <input type="checkbox"/> Yearly inspection <input type="checkbox"/> Other			
Completed by:		(printed name). (signature)	
Company:			
Remarks & Action Taken:			
Device left in a safe usable condition: YES. <input type="checkbox"/> NO <input type="checkbox"/> (if "NO" explain in remarks the action taken)			

Date: _____		Time: _____	
Service Type: <input type="checkbox"/> Periodic inspection <input type="checkbox"/> Monthly inspection <input type="checkbox"/> 6-month inspection <input type="checkbox"/> Repair <input type="checkbox"/> Yearly inspection <input type="checkbox"/> Other			
Completed by:		(printed name). (signature)	
Company:			
Remarks & Action Taken:			
Device left in a safe usable condition: YES. <input type="checkbox"/> NO <input type="checkbox"/> (if "NO" explain in remarks the action taken)			

Date: _____		Time: _____	
Service Type: <input type="checkbox"/> Periodic inspection <input type="checkbox"/> Monthly inspection <input type="checkbox"/> 6-month inspection <input type="checkbox"/> Repair <input type="checkbox"/> Yearly inspection <input type="checkbox"/> Other			
Completed by:		(printed name). (signature)	
Company:			
Remarks & Action Taken:			
Device left in a safe usable condition: YES. <input type="checkbox"/> NO <input type="checkbox"/> (if "NO" explain in remarks the action taken)			

User notes:

Mackworth

Disclaimer

While every effort has been made to ensure the accuracy of information contained in this user manual, no liability can be accepted by Mackworth for any errors or omissions. Mackworth operates a policy of continuous improvement. Specifications and other data are subject to change without notice.

HighStar Healthcare Inc.

1060 Stacey Court,
Unit 1,
Mississauga
ON
L4W 2X8



Part Number: 9995xx / **Rev:** Draft / **Date:** Aug