

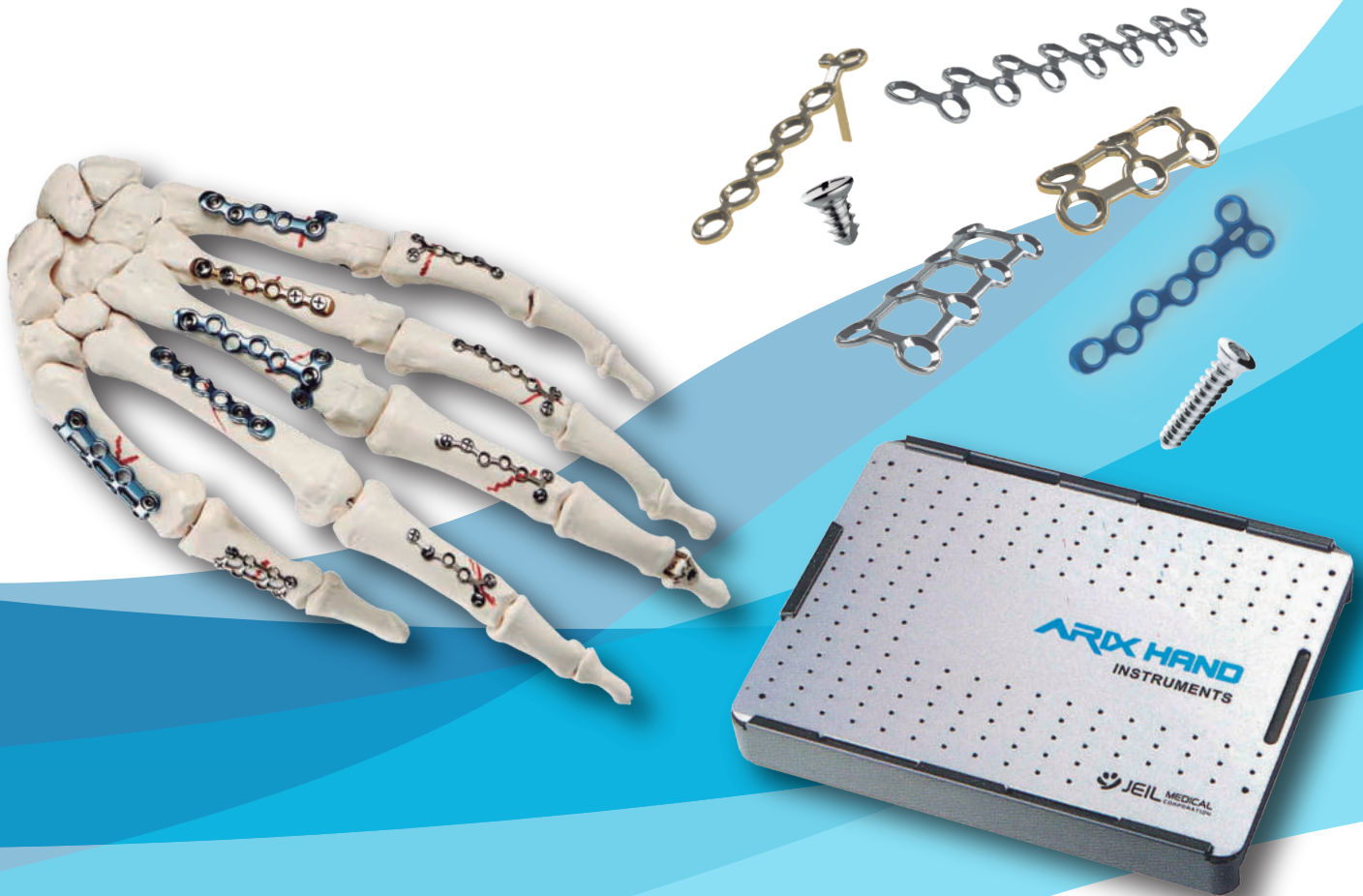

SN Proveedora

# Implantes de Titanio para Cirugía de Mano



**ARIX HAND**  
System

- **Tamaños de tornillo 1.2mm , 1.5mm , 2.0mm y 2.3mm.**
- **Espesores de placa 0,6 mm , 1,0 mm y 1,3 mm.**
- **Placas y tornillos integrales para el tratamiento de toda la gama de fracturas de la mano.**
- **Materiales de Titanio Biocompatibles.**
- **Implantes e Instrumental codificados por colores para una rápida identificación.**

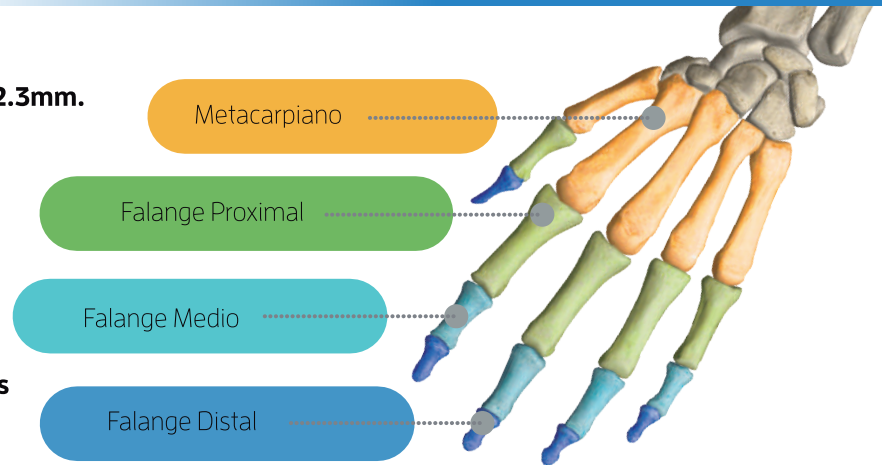

Tecnología de bloqueo de ángulo variable

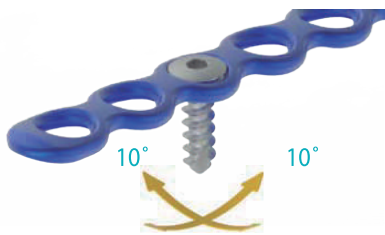

Los orificios permiten hasta 10° fuera del eje de angulación del tornillo, en todas las direcciones.

Sistema <b>ARIX Hand</b>	Tornillo				
	Diámetro Exterior	Falange Distal	Falange Medio	Falange Proximal	Metacarpianos
<b>Sistema H1</b>	1.2mm	•	•		
	1.5mm		•	•	
<b>Sistema H2</b>	2.0mm			•	•
	2.3mm				•

## Opciones de tornillo para Bloqueo y Cortical

Compatibilidad con la gama de Tornillos **ARIX HAND System**

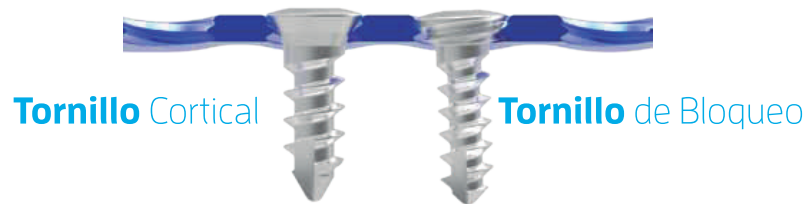

Tornillo Cortical

Tornillo de Bloqueo

Sistema <b>ARIX Hand</b>	Placa			Tornillo						
	Espesor	Color	Material	Diámetro Exterior	Longitud	Emergencia	Tipo	Destornillador para Interfaz	Color	Material
<b>Sistema H1</b>	0.6	Plata	Titanio Puro	Ø1.2	4 ~ 20	Ø1.8 Longitud - 6,10	Sin Bloqueo	Ranura Cruciforme	Plata	Aleación de Titanio
				Ø1.5	4 ~ 22					
<b>Sistema H2</b>	1.0	Dorada		Ø2.0	4 ~ 24	Ø2.5 Longitud - 6,10				
	1.3	Plata		Ø2.3	5 ~ 34					
<b>Locking System H2</b>	1.0	Azul		Ø2.0	6 ~ 20	Ø2.3 Longitud - 6,10	Bloqueo	Ranura Hexagonal		
					6 ~ 30		Sin Bloqueo			

[Unit : mm]

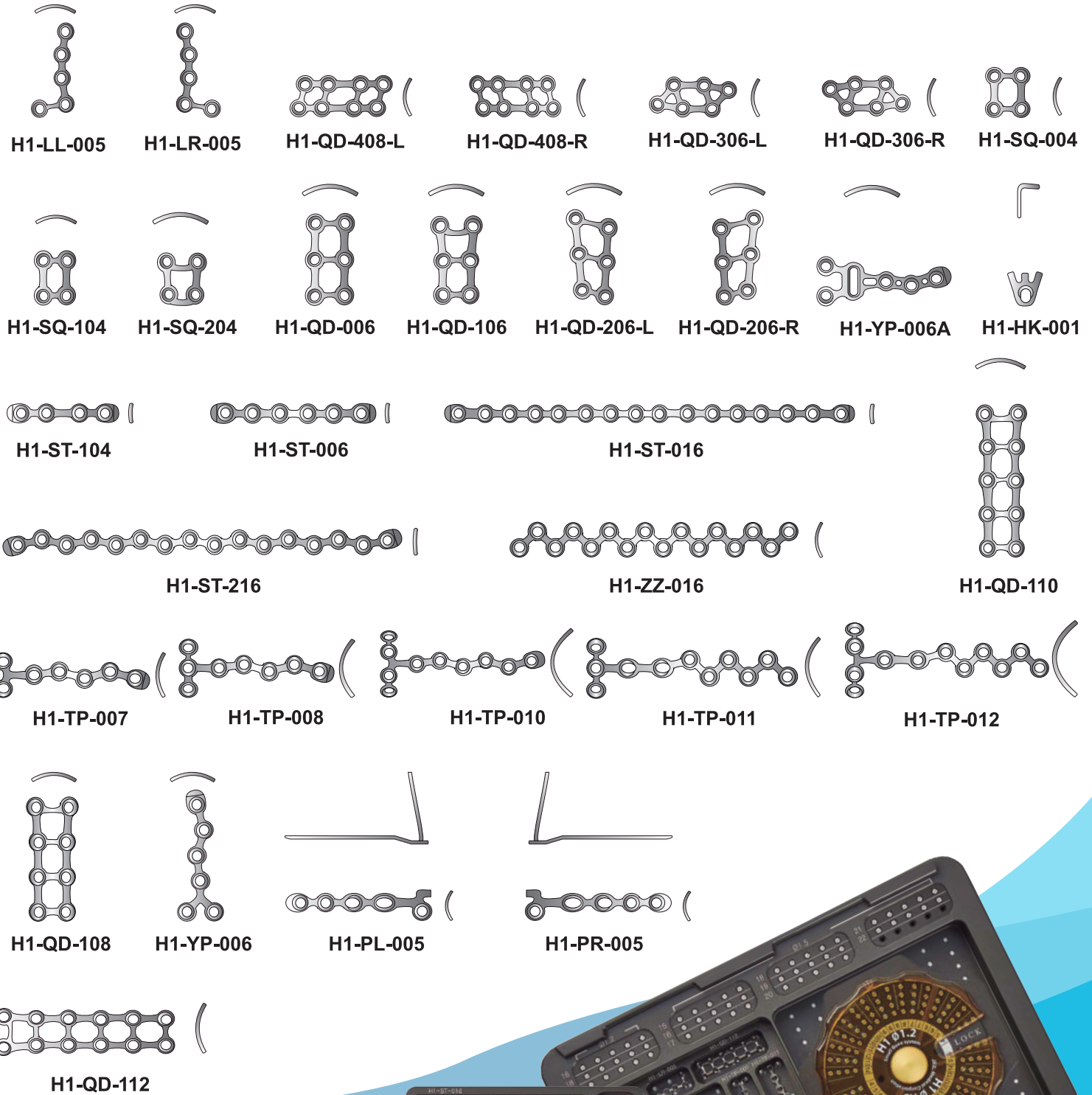

**112-050\_H1**  
**Organizador de Implantes**



H2-ST-104

H2-ST-006

H2-ST-016

H2-ST-216



H2-ZZ-016



H2-PL-006



H2-PR-006

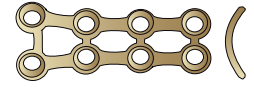

H2-QD-108



H2-LL-006



H2-LR-006



H2-QD-306-L



H2-QD-306-R



H2-TP-006



H2-TP-007

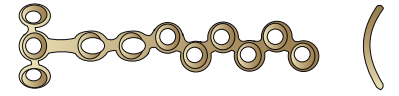

H2-TP-011

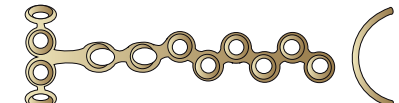

H2-TP-012

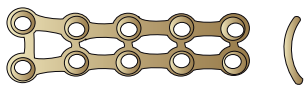

H2-QD-110



H2-YP-007



H2-SQ-104



H2-SQ-204



H2-SQ-304-L



H2-SQ-304-R



H2-QD-006



H2-QD-206-L



H2-QD-206-R



H2-QD-106

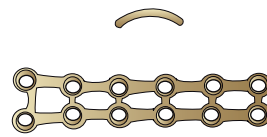

H2-QD-112

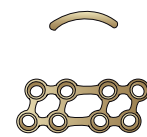

H2-QD-408-L

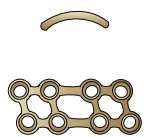

H2-QD-408-R



H2-ST-104-CP



H2-ST-105-CP



H2-ST-106-CP



H2-ST-208-CP



H2-TP-010-CP



H2-TP-006-CP



H2-LL-006-CP



H2-LR-006-CP



H2-LL-010-CP



H2-LR-010-CP

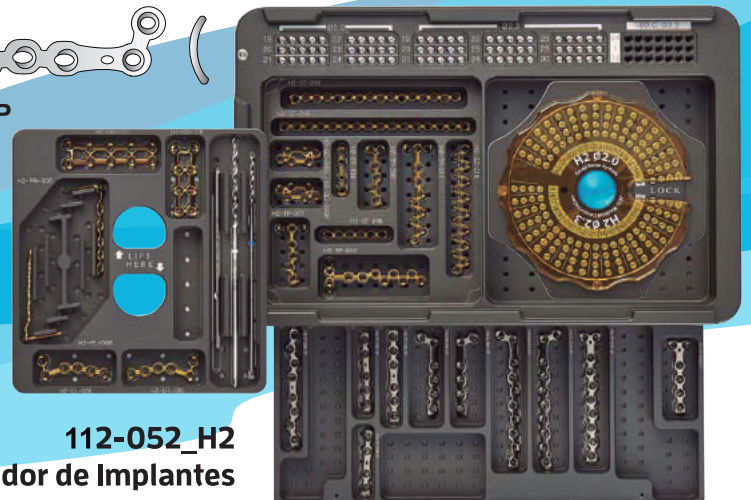
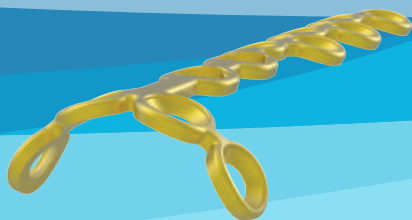

**112-052\_H2**  
Organizador de Implantes



H2L-ST-004



H2L-ST-006



H2L-YP-006



H2L-YP-007

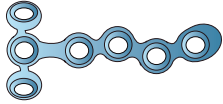

H2L-TP-007

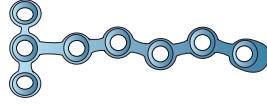

H2L-TP-008



H2L-LL-006



H2L-LR-006

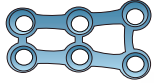

H2L-QD-006

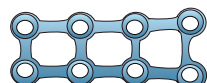

H2L-QD-008



112-053  
Organizador de Implantes de Bloqueo

### Tornillo Cortical Autorroscante Ranura Hexagonal

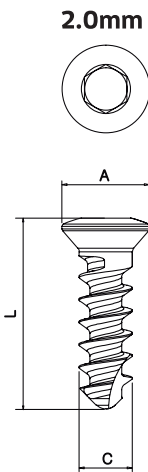

Código	Diámetro de Cabeza (A)	Diámetro de Rosca (C)	Longitud (L)
20-HF-006	Ø3.3	Ø2.0	6
20-HF-007			7
20-HF-008			8
20-HF-009			9
20-HF-010			10
20-HF-011			11
20-HF-012			12
20-HF-013			13
20-HF-014			14
20-HF-016			16
20-HF-018			18
20-HF-020			20
20-HF-021			21
20-HF-022			22
20-HF-023			23
20-HF-024			24
20-HF-026			26
20-HF-028			28
20-HF-030			30

[Unit: mm]

### Tornillo de Bloqueo Autorroscante Ranura Hexagonal

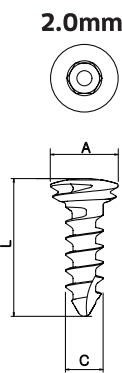

Código	Diámetro de Cabeza (A)	Diámetro de Rosca (C)	Longitud (L)
20L-HF-006	Ø3.6	Ø2.0	6
20L-HF-007			7
20L-HF-008			8
20L-HF-009			9
20L-HF-010			10
20L-HF-011			11
20L-HF-012			12
20L-HF-013			13
20L-HF-014			14
20L-HF-016			16
20L-HF-018			18
20L-HF-020			20

[Unit: mm]

### Tornillo de Emergencia Autorroscante Ranura Hexagonal

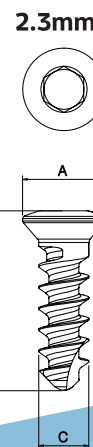

Código	Diámetro de Cabeza (A)	Diámetro de Rosca (C)	Longitud (L)
23-FC-006	Ø3.3	Ø2.3	6
23-FC-010			10

[Unit: mm]



112-053-1  
Organizador de Tornillo de Bloqueo  
Ø2.0/ Ø2.0

## Tornillo Cortical 1.2mm Autorroscante

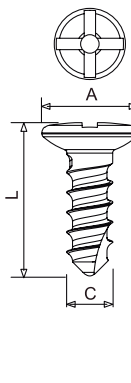

Código	Diámetro de Cabeza (A)	Diámetro de Rosca (C)	Longitud (L)
12-HC-004	Ø2.5	Ø1.2	4
12-HC-005			5
12-HC-006			6
12-HC-007			7
12-HC-008			8
12-HC-009			9
12-HC-010			10
12-HC-011			11
12-HC-012			12
12-HC-013			13
12-HC-014			14
12-HC-016			16
12-HC-018			18
12-HC-020			20

[Unit: mm]

## Tornillo Cortical 1.5mm Autorroscante

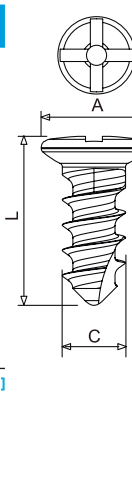

Código	Diámetro de Cabeza (A)	Diámetro de Rosca (C)	Longitud (L)
15-HC-004	Ø2.5	Ø1.5	4
15-HC-005			5
15-HC-006			6
15-HC-007			7
15-HC-008			8
15-HC-009			9
15-HC-010			10
15-HC-011			11
15-HC-012			12
15-HC-013			13
15-HC-014			14
15-HC-015			15
15-HC-016			16
15-HC-017			17
15-HC-018			18
15-HC-019			19
15-HC-020			20
15-HC-021			21
15-HC-022			22

[Unit: mm]

## Tornillo de Emergencia 1.8mm Autorroscante

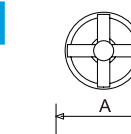

Código	Diámetro de Cabeza (A)	Diámetro de Rosca (C)	Longitud (L)
18-HC-006	Ø2.5	Ø1.8	6
18-HC-010			10

[Unit: mm]

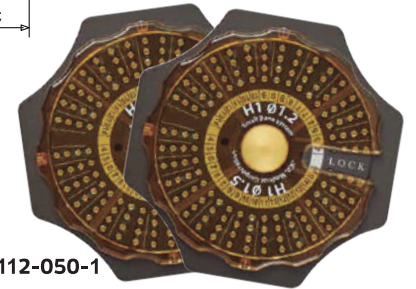
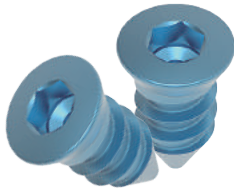

112-050-1  
Organizador de Tornillos Ø1.2/ Ø1.5 (H1)

# Tornillo Cortical Sistema H2

## Tornillo Cortical 2.0mm Autorroscante

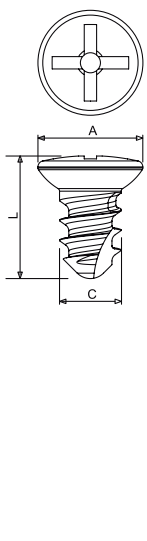

Código	Diámetro de Cabeza (A)	Diámetro de Rosca (C)	Longitud (L)
20-HC-004	Ø3.4	Ø2.0	4
20-HC-005			5
20-HC-006			6
20-HC-007			7
20-HC-008			8
20-HC-009			9
20-HC-010			10
20-HC-011			11
20-HC-012			12
20-HC-013			13
20-HC-014			14
20-HC-015			15
20-HC-016			16
20-HC-017			17
20-HC-018			18
20-HC-019			19
20-HC-020			20
20-HC-021			21
20-HC-022			22
20-HC-023			23
20-HC-024			24

[Unit: mm]

## Tornillo Cortical 2.3mm Autorroscante

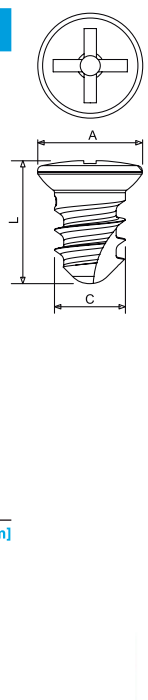

Código	Diámetro de Cabeza (A)	Diámetro de Rosca (C)	Longitud (L)
23-HC-005	Ø3.4	Ø2.3	5
23-HC-006			6
23-HC-007			7
23-HC-008			8
23-HC-009			9
23-HC-010			10
23-HC-011			11
23-HC-012			12
23-HC-013			13
23-HC-014			14
23-HC-015			15
23-HC-016			16
23-HC-017			17
23-HC-018			18
23-HC-019			19
23-HC-020			20
23-HC-021			21
23-HC-022			22
23-HC-023			23
23-HC-024			24
23-HC-025			25
23-HC-026			26
23-HC-027			27
23-HC-028			28
23-HC-029			29
23-HC-030			30
23-HC-032			32
23-HC-034			34

[Unit: mm]

## Tornillo de Emergencia 2.5mm Autorroscante

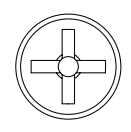

Código	Diámetro de Cabeza (A)	Diámetro de Rosca (C)	Longitud (L)
25-HC-006	Ø3.4	Ø2.5	6
25-HC-010			10

[Unit: mm]



112-051-1  
Organizador de Tornillos Ø2.0 / Ø2.3 (H2)



### SN Proveedora

SN Proveedora  
Sarahí Elena Nájera Salinas  
NASS831127754  
Bogotá 236 Col. Valle del Nogalar C.P.66480  
San Nicolás de los Garza N,L, Tel:(81)13577200  
www.snproveedora.com.mx

ISSA OGBE JEILMOTY

EL DISTRIBUIDOR EN SU ÁREA

MATERIAL PARA USO EXCLUSIVO DEL PERSONAL MÉDICO