

Limited Warranty

J & J Global, LLC (Seller) warrants to the original Buyer only, that each product will be free from defects in material and workmanship for a period of one (1) year from date of purchase. SELLER'S SOLE OBLIGATION AND BUYER'S EXCLUSIVE REMEDY UNDER THIS LIMITED WARRANTY SHALL BE THE REPAIR OR REPLACEMENT OF PARTS, WITHOUT CHARGE, WHICH ARE DEFECTIVE IN MATERIAL OR WORKMANSHIP. ANY PARTS AS DETERMINED BY THE SELLER WHICH HAVE BEEN MISUSED; ABUSED OR DAMAGED EITHER DIRECTLY OR INDIRECTLY FROM REPAIRS OR ALTERATIONS ATTEMPTED BY UNAUTHORIZED PERSON; IMPROPER MAINTENANCE, NEGLIGENCE OR ACCIDENT ARE NOT COVERED BY THIS LIMITED WARRANTY. This warranty does not apply to damage, heat-induced coloration changes, scratching or alteration due to normal use or weathering. To make a claim under this Limited Warranty, email contact@ezreplacement.com or visit www.ezreplacement.com for warranty questions and claims.

Additional Limitations

THIS LIMITED WARRANTY DOES NOT APPLY TO ACCESSORY OR CONSUMABLE ITEMS RELATED TO THIS PRODUCT. ALL IMPLIED WARRANTIES SHALL BE LIMITED IN DURATION TO ONE (1) YEAR FROM DATE OF PURCHASE. IN NO EVENT SHALL SELLER BE LIABLE FOR ANY INCIDENTAL OR CONSEQUENTIAL DAMAGES, INCLUDING BUT NOT LIMITED TO LIABILITY FOR LOSS OF PROFITS, ARISING FROM THE SALE OR USE OF THIS PRODUCT.

If any provision of this Limited Warranty is for any reason held to be invalid or unenforceable, such provision shall not affect any other provision herein, this Limited Warranty shall be construed as if such invalid and/or unenforceable provision had never been contained herein.

This warranty gives you special legal rights, and you may also have other rights which vary from state to state.

This warranty contains the entire agreement between Seller and Buyer and supercedes any and all prior agreements, arrangements, or understandings between the parties relating to product warranty.

Due to ongoing product development the actual product or products may vary from the illustrations or photos shown within this manual.

For Manuals, Replacement Parts or Customer Service visit:
www.ezreplacement.com

This product is intended for residential, non-commercial use.

⚠ WARNING

This product can expose you to lead, a chemical known to the state of California to cause cancer, birth defects and/or other reproductive harm. For more information go to www.p65warnings.ca.gov/product

MADE IN CHINA
©2020 J & J Global, LLC
Distributed By:
J & J Global, LLC
Irving, TX 75038

EZ
Replacement

www.EZreplacement.com

Customer Service Made EZ!

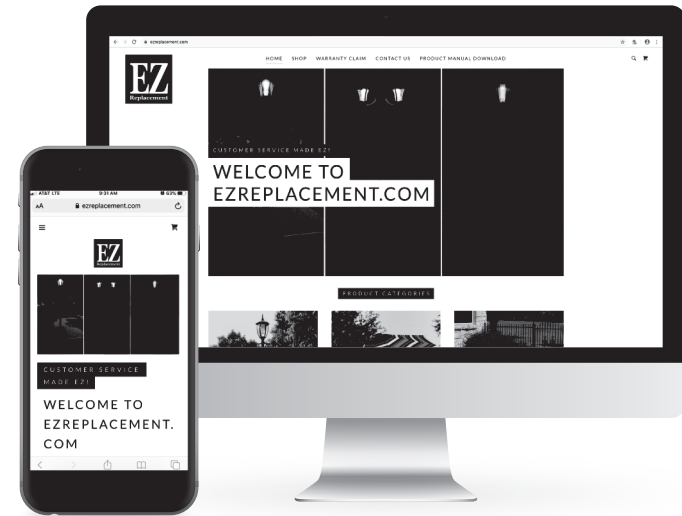

- User Friendly Interface
- Download Product Manuals
- Email your questions or concerns
- File Warranty Claim
- Follow-up within 24 Hrs
- Parts Ship within 48 Hrs.



Parts distribution made from our Carrollton, TX warehouse facility

ATTENTION!

Please do not return this product to the retailer.
If you are missing or have damaged parts please email
contact@ezreplacement.com Or Call 877-477-2264



Floor Standing Patio Heater w/ Remote Control

Sku: 101012



Read the instructions and precautions before use of this product

Please keep this instruction manual for future reference

For warranty information, please refer to the back page of this instruction manual.

Important Instructions Continued

33. Surface temperatures become very hot when operating heater. Children and adults should stay away to avoid burns or clothing ignition.
34. Young children should be carefully supervised when they are in the area of the heater.
35. Extreme caution is necessary when any heater is used by or near children or invalids and whenever the heater is left operating and unattended.
36. Always unplug heater when not in use.
37. Do not operate any heater with a damaged cord or plug or after the heater malfunctions, has been dropped or damaged in any manner. Discard heater, or return to authorized service facility for examination and/or repair.
38. Connect to properly grounded outlets only.
39. Do not insert or allow foreign objects to enter any ventilation or exhaust opening as this may cause an electric shock or fire, or damage the heater.
40. To prevent a possible fire, do not block air intakes or exhaust in any manner. Do not use on soft surfaces, like a bed, where openings may become blocked.
41. A heater has hot and arcing or sparking parts inside. Do not use it in areas where gasoline, paint, or flammable liquids are used or stored.
42. This heater may include an audible (a visual) alarm to warn that parts of the heater are getting excessively hot. If the alarm sounds (flashes), immediately turn the heater off and inspect for any objects on or adjacent to the heater that may cause high temperatures. **DO NOT OPERATE THE HEATER WITH THE ALARM SOUNDING (FLASHING).** (Omitted if an alarm is not required per Alarms, Section 30.)

CAUTION: EXTEND OR UNFOLD LEGS BEFORE OPERATING

Grounding Instructions:

This heater is for use on 120 volts. The cord has a plug as shown at A in figure below. An adapter as shown at C is available for connecting three-blade grounding-type plugs to two-slot receptacles. The green grounding lug extending from the adapter must be connected to a permanent ground such as a properly grounded outlet box. The adapter should not be used if a three-slot grounded receptacle is available

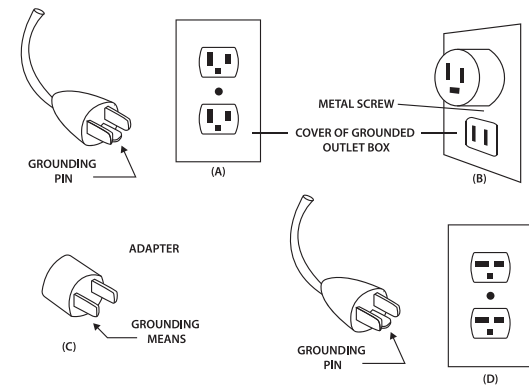

Cleaning:











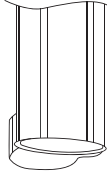
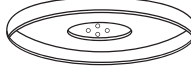

Unplug the unit before cleaning. It should be wiped with wet cloth. Don't use too much water. Any other servicing should be performed by an authorized service representative.

Important Instructions

When using electrical appliances, basic precautions should always be followed to reduce the risk of fire, electric shock, and injury to persons, including the following:

1. Read all instructions before using this heater.
2. The unit must be placed with the clearance of 100cm to the wall and 30cm to the ceiling.
3. This heater is hot when in use. To avoid burns, do not let bare skin touch hot surfaces. If provided, use handles when moving this heater. High temperature, keep combustible material such as furniture, papers, clothes, curtains at least 3 feet (0.9m) from the front of the heater and away from the side and rear.
4. The unit must be securely placed on a horizontal and flat surface.
5. The unit is at high temperature during operation. It keeps hot for a period after shut down. Potential danger would occur when touching it during this period.
6. Don't place the unit close to curtain and/or other flammable objects. Otherwise there will be a danger of catching fire.
7. Don't cover the unit with anything during operation or a short time after it's shut down.
8. Don't wrap the power supply cord on the unit.
9. The unit must be handled with care, and avoid of vibration or hitting.
10. The unit must be securely grounded during operation.
11. When damaged, the unit must be repaired by professional repairing team.
12. If the supply cord is damaged, it must be replaced by the manufacturer, its service agent or similarly qualified persons in order to avoid a hazard.
13. The heater must not be located immediately below a socket-outlet.
14. When assembling, keep clear from any board or flammable material.
15. Do not use this heater with a programmer, timer or any other device that switches the heater on automatically, since a fire risk exists if the heater is covered or positioned incorrectly.
16. This appliance is not intended for use by persons (including children) with reduced physical, sensory or mental capabilities, or lack of experience and knowledge, unless they have been given supervision or instruction concerning use of the appliance by a person responsible for their safety.
17. Children should be supervised to ensure that they do not play with the appliance.
18. The unit is for household use only. It's not allowed to use in building site, greenhouses, barn or stable where there's flammable dust.
19. The head of the unit is at high temperature during operation. Unplug the unit and wait till it's cool before cleaning.
20. This heater is not intended for use in bathrooms, laundry areas and similar indoor locations. Never locate heater where it may fall into a bathtub or other water container.
21. Don't use this unit in place where causticity or volatile air exists, i.e. dust, steam, gas, etc.
22. Don't use this unit as a cloth drier or towel drier.
23. Don't use this unit as a sauna heater.
24. Don't use this unit as a room heater or heat storing.
25. Don't use this unit in place of animal propagating and raising.
26. Don't use this unit in heating system of hot air centre.
27. Don't immerse this unit into water for cleaning.
28. The unit should be plugged in a socket, which is easily visible and reachable.
29. To avoid potential fire hazards, do not run your heater or its electrical cord under carpeting. Do not cover cord with throw rugs, runners, or similar coverings. Do not route cord under furniture or appliances. Arrange the electrical cord away from traffic areas and where it will not be tripped over.
30. To disconnect heater, turn controls to off, then remove plug from outlet.
31. Use this heater only as described in this manual. Any other use not recommended by the manufacturer may cause fire, electric shock, or injury to persons.
32. Always plug heaters directly into a wall outlet/receptacle. Never use with an extension cord or relocatable power tap (outlet/power strip) because the extension cord may overheat and cause a risk of fire.

Package Contents

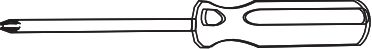
A x1	Main Body 	B x1	Connection Board 	C x2	M6*8 Screw 	D x1	Clamping Board 
E x2	M6*27 Screw 	F x1	Base Cover 	G x1	Base 	H x1	Clamping Board 
I x2	M6*28 Screw 	J x2	Washer 	K x2	M6*35 Screw 	L x1	Remote Control 
M x1	Allen Key 	Tools Required: 					

Read this instruction manual carefully before assembly and use. Keep this instruction manual in a proper and safe place for future use in case needed. Unpack the carton. Take out the accessories pack from the carton of the heater body. Make sure the accessories listed in the above Accessories Check List are included. If anything missing, ask the retailer immediately to provide it to you.

1

Assembly

1. Take out the Main Body(A), Base(G), Base Cover(F), and accessories bag from the cartons.
2. Put the main body up-side-down (See Figure Below). Fix the Connection Board(B) with Screw(C) on the main body(A) . Then fix the Clamping Board(D) with Screw(E) on the Connection Board(B) . Put the plug and power supply cord through the holes on the center of Base Cover (F) and Base (G). Then slide Base Cover (F) , Base (G) and Washer (J) with Screw(K) onto main body respectively.
3. Put the power cord into the sink of the base. Then fix it with Camping Board(E) and M4*35 Screw (K).

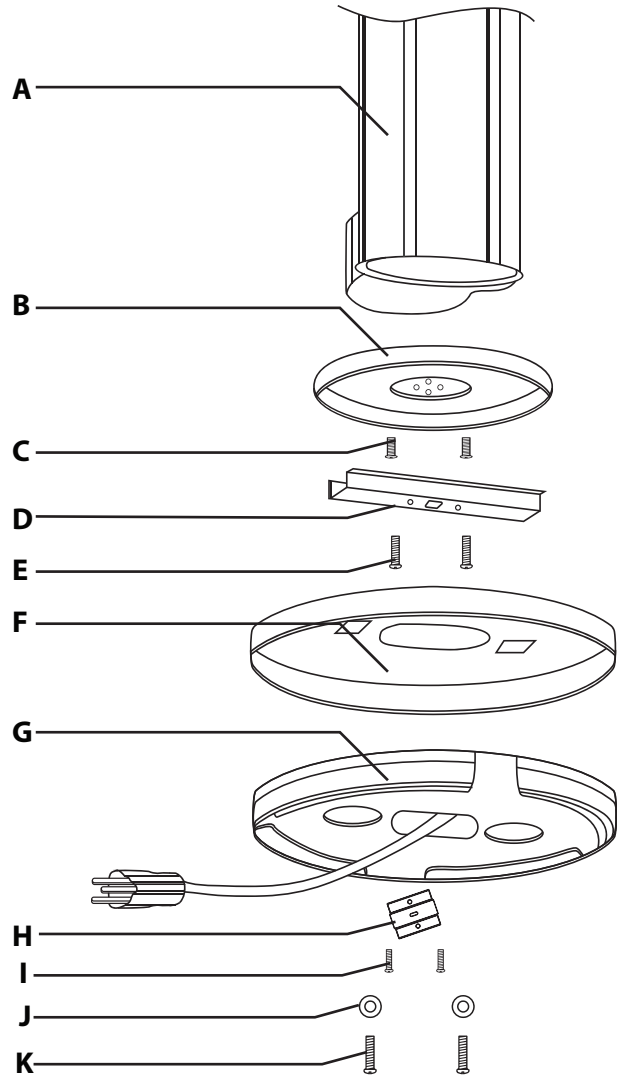

1

Operation

1. Plug the unit into a socket. Make sure the power supply is same as rated.
2. LED indicator light stars flashing showing the heater is on standby. Press Mode button on control panel to switch on the heater. The heater will start on the low setting, each press of the Mode button will cycle the heater onto the medium setting, high setting and then back to the low setting.
3. Press Swing Button on the control panel or remote controller to operate the Oscillation.
4. Press TIMER button on control panel or remote control to choose the timer between 0-9 hours. "0" means the timer is off. Each press of the Timer button will cycle the timer from "0"- "9".
5. When the heater is no longer required, switch off, using the off button on the remote control or the control panel and unplug the unit.

