

Limited Warranty

J & J Global, LLC (Seller) warrants to the original Buyer only, that each product will be free from defects in material and workmanship for a period of one (1) year from date of purchase. SELLER'S SOLE OBLIGATION AND BUYER'S EXCLUSIVE REMEDY UNDER THIS LIMITED WARRANTY SHALL BE THE REPAIR OR REPLACEMENT OF PARTS, WITHOUT CHARGE, WHICH ARE DEFECTIVE IN MATERIAL OR WORKMANSHIP. ANY PARTS AS DETERMINED BY THE SELLER WHICH HAVE BEEN MISUSED; ABUSED OR DAMAGED EITHER DIRECTLY OR INDIRECTLY FROM REPAIRS OR ALTERATIONS ATTEMPTED BY UNAUTHORIZED PERSON; IMPROPER MAINTENANCE, NEGLIGENCE OR ACCIDENT ARE NOT COVERED BY THIS LIMITED WARRANTY. This warranty does not apply to damage, heat-induced coloration changes, scratching or alteration due to normal use or weathering. To make a claim under this Limited Warranty, email contact@ezreplacement.com or visit www.ezreplacement.com for warranty questions and claims.

Additional Limitations

THIS LIMITED WARRANTY DOES NOT APPLY TO ACCESSORY OR CONSUMABLE ITEMS RELATED TO THIS PRODUCT. ALL IMPLIED WARRANTIES SHALL BE LIMITED IN DURATION TO ONE (1) YEAR FROM DATE OF PURCHASE. IN NO EVENT SHALL SELLER BE LIABLE FOR ANY INCIDENTAL OR CONSEQUENTIAL DAMAGES, INCLUDING BUT NOT LIMITED TO LIABILITY FOR LOSS OF PROFITS, ARISING FROM THE SALE OR USE OF THIS PRODUCT.

If any provision of this Limited Warranty is for any reason held to be invalid or unenforceable, such provision shall not affect any other provision herein, this Limited Warranty shall be construed as if such invalid and/or unenforceable provision had never been contained herein.

This warranty gives you special legal rights, and you may also have other rights which vary from state to state.

This warranty contains the entire agreement between Seller and Buyer and supercedes any and all prior agreements, arrangements, or understandings between the parties relating to product warranty.

Due to ongoing product development the actual product or products may vary from the illustrations or photos shown within this manual.

For Manuals, Replacement Parts or Customer Service visit:
www.ezreplacement.com

This product is intended for residential, non-commercial use.

⚠ WARNING

This product can expose you to lead, a chemical known to the state of California to cause cancer, birth defects and/or other reproductive harm. For more information go to www.p65warnings.ca.gov/product

MADE IN CHINA
©2019 J & J Global, LLC
Distributed By:
J & J Global, LLC
Carrollton, TX 75006

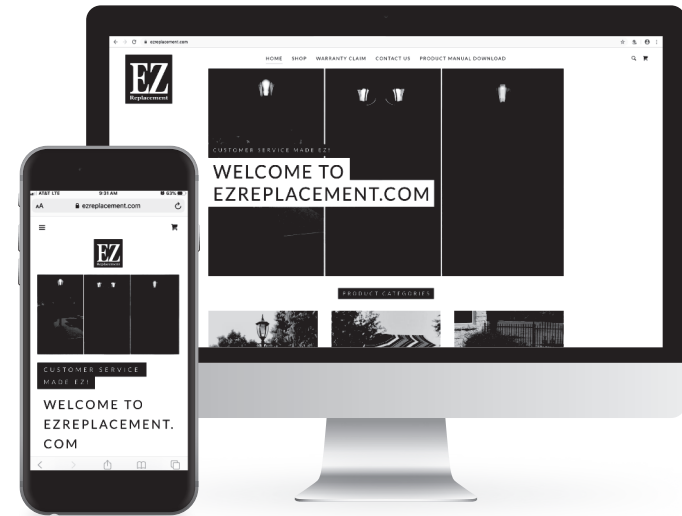

- User Friendly Interface
- Download Product Manuals
- Email your questions or concerns
- File Warranty Claim
- Follow-up within 24 Hrs
- Parts Ship within 48 Hrs.



Parts distribution made from our Carrollton, TX warehouse facility

ATTENTION!

Please do not return this product to the retailer.
If you are missing or have damaged parts please email
contact@ezreplacement.com Or Call 877-477-2264



Avalon Solar Lamp Post & Planter

SKU: 302016, 312016, 342016



Read the instructions and precautions before use of this product

Please keep this instruction manual for future reference

For warranty information, please refer to the back page of this instruction manual.

Care Instructions

Clean any dirt and debris from the solar panels, the panels can not recharge if the light is obstructed. Use a soft cloth to clean the panels. Do not use abrasives or chemicals that might scratch or damage the UV coating.

In a region where snow and ice are likely, and the light assembly is covered with snow for an extended period of time the batteries will require recharge for at least 8 hours.

Do Not mix old batteries with new batteries.

Do not mix alkaline standard (Carbon-Zinc) or rechargeable (Nickel-Cadmium) batteries

Recycling

Please dispose of batteries properly. Consult your local telephone listing for a battery recycling center in your area.



Ambient temperature maximum 40°C (105°F)



Do not throw batteries into water!



Do not dispose of batteries in household waste



Protect batteries against heat and fire risk of explosion



Recycling

7

NOTE: The batteries in your solar lantern come preinstalled from the factory.

Remove the screws from the top of the lantern head (A). Battery compartment is located under the top of the lantern head.

Carefully lift the lantern top off the housing. Remove the three screws on the bottom of the lantern top. Separate the battery compartment from the top of the lantern head.

Remove old batteries.





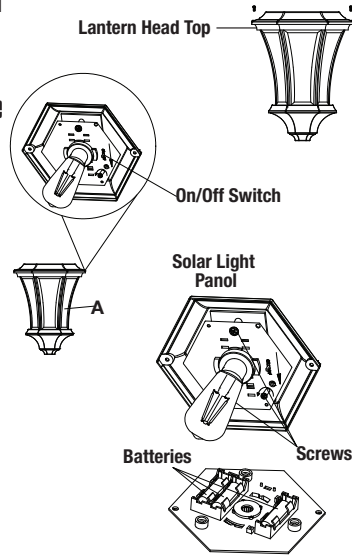

Replace old batteries with new ones of the same rating. Reference polarity direction inside battery compartment.

Replace the solar panel on the housing and secure with screws retained from step 2.

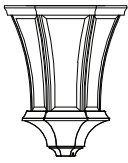
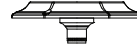
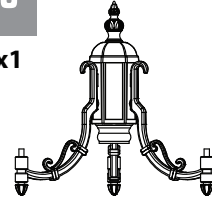



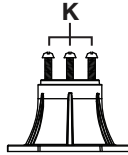

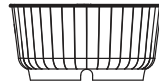
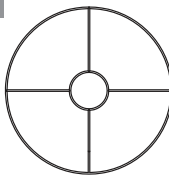

Allow lantern to charge for at least 8 hours in full sunlight with the ON/OFF switch in the OFF position. The ON/OFF switch is located under the solar panel. Once the batteries are fully charged, set the ON/OFF switch to ON. If the lantern doesn't turn on after initial charging, ensure batteries are making contact with the terminals.



Package Contents

A x3	Lantern Body 	B x3	Lantern Top 	C x1	Lantern Bracket 	D x2	Upper Post 
E x1	Middle Post 	F x1	Lower Post 	G x1	Lamp Post Base & Base Screws 	H x1	Top Planter 
I x1	Bottom Planter 	J x1	Support Ring 				

Hardware Contents

K x3	Base Screws 	L x6	Small Screw 	M x3	Flat Washer 	N x6	Hex Nut 
O x3	Acorn Nut 	P x3	Hex Bolt 	Q x3	J-Bolt 	R x1	Mounting Plate 
S x3	Bulb 						

1

Where To Place the Solar Light

Place the solar light in an area where it will receive direct sunlight for at least 8 hours per day. The number of hours the light is illuminated is directly proportional to the number of hours of sunlight it receives. If the light is placed in a shaded area, it will not be able to fully charge and its burn time will be limited. Do not place the light near other outdoor lighting like porch or streetlights. These may fool the sensor and keep the light from coming on, or cause it to turn off automatically.

2

Screw the bulb (S) into the lantern top (B).

Repeat with the other lantern body (A).

Place lantern top (B) onto lantern body (A) secure with two small screws (L).

Repeat with the other lantern body (A).

Thread lantern body (A) onto lantern bracket (C) and turn clockwise to tighten.

Repeat with the other lantern body (A).

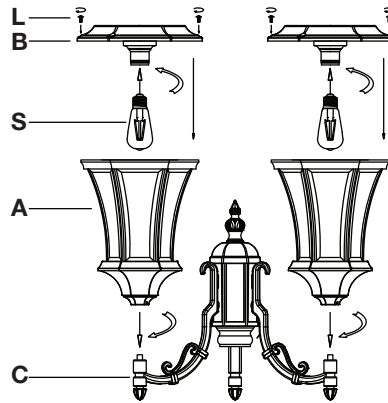

3

Attach lamp post base (G) to bottom planter (I) using hex bolts (P), mounting plate (R), flat washer (M), and hex nut (N). Make sure the mounting plate, flat washer and hex nut are secured to the hex bolt on the underside of the bottom planter base (I).

Attach the top planter (H) to the bottom planter base (I) by lining up the 4 tabs and pulling the top planter base up until tabs snap into place. Turn the upper planter clockwise to lock the tabs into place.

Note: It may be necessary to put pressure on the bottom planter base when pulling the top planter base up and turning.

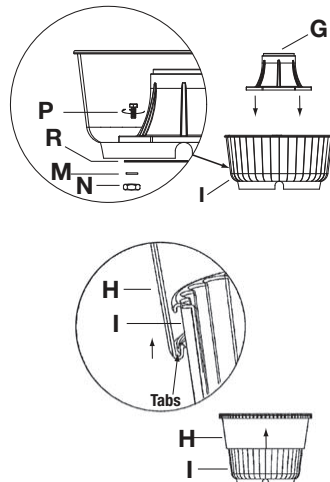

4

Attach lower post (F) to lamp post base (G) using screws (K) in 3 places. Lower the support ring (J) down the post until it rests on the top of the upper planter (H).



CAUTION: To prevent product damage or personal injury from tip-over, lamp post planter base must be placed on a flat, level surface and be filled with 4 in (minimum of 40 lbs.) of gravel or stone.

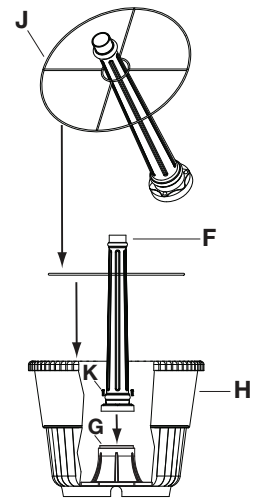

5

Attach lower post (F) to lamp post base (G) using 3 screws (K) if you have not already done so.

Attach the middle post (E) to the lower post (F) turning clockwise.

Attach the upper post (D) to the middle post (E), turning clockwise. Attach second upper post (D) to first upper post (D).

Place the completed lantern assembly on the upper lamp post (D) and twist clockwise to secure.

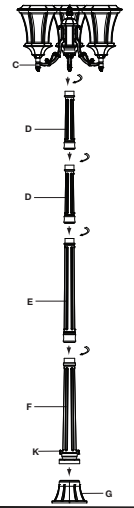

6

Thread hex nut (N) onto the j-bolt (Q). Make sure the hex nut is threaded down the j-bolt far enough for the top of the j-bolt to fit through the mounting plate (R) and the lamp post base (G) with enough threads to secure the base to the j-bolts with acorn nuts (O). Repeat steps for other j-bolts.

Using mounting plate (R) as a guide insert the j-bolts with hex nuts into a wet concrete pad until the hex nuts are below pad level.

Place the mounting plate (R) onto j-bolts forming a mounting bracket.

Align the lamp post base (G) holes with the j-bolts and secure with the acorn nuts (O).

