

### Limited Warranty

J & J Global, LLC (Seller) warrants to the original Buyer only, that each product will be free from defects in material and workmanship for a period of one (1) year from date of purchase. SELLER'S SOLE OBLIGATION AND BUYER'S EXCLUSIVE REMEDY UNDER THIS LIMITED WARRANTY SHALL BE THE REPAIR OR REPLACEMENT OF PARTS, WITHOUT CHARGE, WHICH ARE DEFECTIVE IN MATERIAL OR WORKMANSHIP. ANY PARTS AS DETERMINED BY THE SELLER WHICH HAVE BEEN MISUSED; ABUSED OR DAMAGED EITHER DIRECTLY OR INDIRECTLY FROM REPAIRS OR ALTERATIONS ATTEMPTED BY UNAUTHORIZED PERSON; IMPROPER MAINTENANCE, NEGLIGENCE OR ACCIDENT ARE NOT COVERED BY THIS LIMITED WARRANTY. This warranty does not apply to damage, heat-induced coloration changes, scratching or alteration due to normal use or weathering. To make a claim under this Limited Warranty, email [contact@ezreplacement.com](mailto:contact@ezreplacement.com) or visit [www.ezreplacement.com](http://www.ezreplacement.com) for warranty questions and claims.

#### Additional Limitations

THIS LIMITED WARRANTY DOES NOT APPLY TO ACCESSORY OR CONSUMABLE ITEMS RELATED TO THIS PRODUCT. ALL IMPLIED WARRANTIES SHALL BE LIMITED IN DURATION TO ONE (1) YEAR FROM DATE OF PURCHASE. IN NO EVENT SHALL SELLER BE LIABLE FOR ANY INCIDENTAL OR CONSEQUENTIAL DAMAGES, INCLUDING BUT NOT LIMITED TO LIABILITY FOR LOSS OF PROFITS, ARISING FROM THE SALE OR USE OF THIS PRODUCT.

If any provision of this Limited Warranty is for any reason held to be invalid or unenforceable, such provision shall not affect any other provision herein, this Limited Warranty shall be construed as if such invalid and/or unenforceable provision had never been contained herein.

This warranty gives you special legal rights, and you may also have other rights which vary from state to state.

This warranty contains the entire agreement between Seller and Buyer and supercedes any and all prior agreements, arrangements, or understandings between the parties relating to product warranty.

Due to ongoing product development the actual product or products may vary from the illustrations or photos shown within this manual.

**For Manuals, Replacement Parts or Customer Service visit:  
[www.ezreplacement.com](http://www.ezreplacement.com)**

This product is intended for residential, non-commercial use.

#### WARNING

This product can expose you to lead, a chemical known to the state of California to cause cancer, birth defects and/or other reproductive harm. For more information go to [www.p65warnings.ca.gov/product](http://www.p65warnings.ca.gov/product)

**MADE IN CHINA**  
©2019 J & J Global, LLC  
Distributed By:  
J & J Global, LLC  
Carrollton, TX 75006

**EZ**  
Replacement

[www.EZreplacement.com](http://www.EZreplacement.com)

# Customer Service Made EZ!

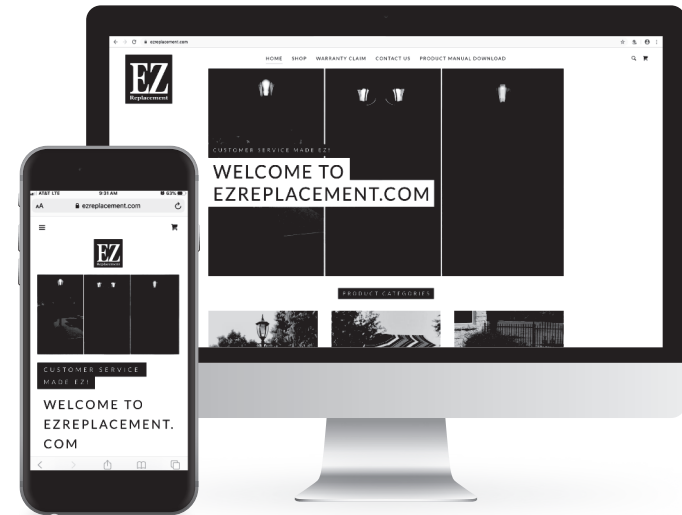

- User Friendly Interface
- Download Product Manuals
- Email your questions or concerns
- File Warranty Claim
- Follow-up within 24 Hrs
- Parts Ship within 48 Hrs.



Parts distribution made from our Carrollton, TX warehouse facility

## ATTENTION!

**Please do not return this product to the retailer.  
If you are missing or have damaged parts please email  
[contact@ezreplacement.com](mailto:contact@ezreplacement.com) Or Call 877-477-2264**



# Crestmont Solar Lamp Post & Planter

SKU: 302066, 312066, 342066



Read the instructions and precautions before use of this product

Please keep this instruction manual for future reference

For warranty information, please refer to the back page of this instruction manual.

## Care Instructions

Clean any dirt and debris from the solar panels, the panels cannot recharge if the light is obstructed. Use a soft cloth to clean the panels. Do not use abrasives or chemicals that might scratch or damage the UV coating.

In a region where snow and ice are likely, and the light assembly is covered with snow for an extended period of time the batteries will require recharge for at least 8 hours.

Do not mix old batteries with new batteries.

Do not mix alkaline standard (Carbon-Zinc) or rechargeable (Nickel-Cadmium) batteries

### Recycling

Please dispose of batteries properly. Consult your local telephone listing for a battery recycling center in your area.



Ambient temperature  
maximal 40°C (105°F)



Do not throw  
batteries into water!



Do not dispose of  
batteries in  
household waste



Protect batteries  
against heat and fire  
risk of explosion



Recycling

# 7

Remove the screws from the top of the lantern head (A). Battery compartment is located under the top of the lantern head.

Carefully lift the lantern top off the housing. Remove the battery covers.

Remove old batteries.

Replace old batteries with new ones of the same rating. Reference polarity direction inside battery compartment.

Replace the solar panel on the housing and secure with screws retained from step 1.

The rechargeable batteries need to be fully charged before operating light assembly.



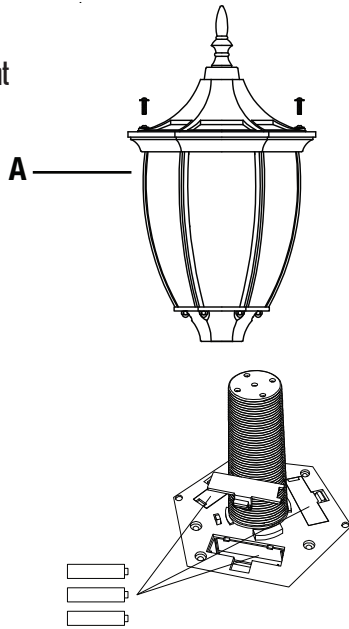



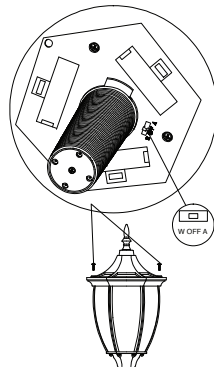

Allow lantern to charge for at least 8 hours in full sunlight with the ON/OFF switch in the OFF position. The ON/OFF switch is located under the solar panel. Once the batteries are fully charged, set the ON/OFF switch to ON. If the lantern doesn't turn on after initial charging, ensure batteries are making contact with the terminals.





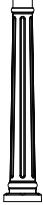
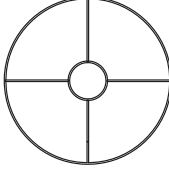

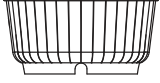

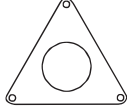

Position	Function	Comments
"W"	Manually Select White LED	Auto Dusk to Dawn Operation 3 White Super Bright LED's per head.
"A"	Manually Select Amber LED	Auto Dusk to Dawn Operation 1 Amber LED's per head.
"OFF"	On/Off Switch	Turns all lights off



## Package Contents

<b>A</b> x1	Lantern Body 	<b>B</b> x1	Plant Hanger 	<b>C</b> x1	Upper Post 	<b>D</b> x1	Middle Post 
<b>E</b> x1	Lower Post 	<b>F</b> x1	Support Ring 	<b>G</b> x1	Top Planter 	<b>H</b> x1	Bottom Planter 
<b>I</b> x1	Lamp Post Base 	<b>J</b> x1	Mounting Plate 				

## Hardware Contents

<b>K</b> x3	J-Bolts 	<b>L</b> x3	Hex Nut 	<b>M</b> x3	Accorn Nut 	<b>N</b> x3	Base Screws 
<b>O</b> x3	Hex Bolt 	<b>P</b> x3	Flat Washer 	<b>Q</b>	Hexagon Spanner 	<b>R</b>	Small Screw 

# 1

## Where To Place the Solar Light

Place the solar light in an area where it will receive direct sunlight for at least 8 hours per day. The number of hours the light is illuminated is directly proportional to the number of hours of sunlight it receives. If the light is placed in a shaded area, it will not be able to fully charge and its burn time will be limited. Do not place the light near other outdoor lighting like porch or streetlights. These may fool the sensor and keep the light from coming on, or cause it to turn off automatically.

# 2

Attach lamp post base (I) to bottom planter (H) using hex bolts (O), mounting plate (J), flat washer (P), and hex nut (L). Make sure the mounting plate, flat washer and hex nut are secured to the hex bolt on the underside of the bottom planter base (H).

Attach the upper planter (G) to the bottom planter base (H) by lining up the 4 tabs and pulling the top planter base up until tabs snap into place. Turn the upper planter clockwise to lock the tabs into place.

**Note:** It may be necessary to put pressure on the bottom planter base when pulling the top planter base up and turning.

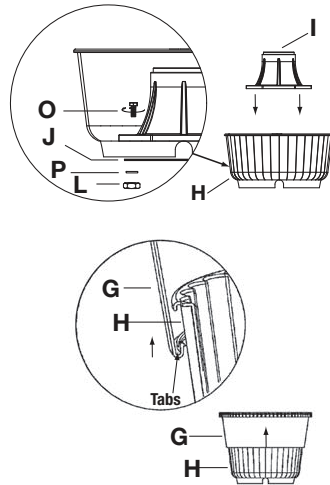

# 3

Attach lower post (E) to post base (I) using screws (N) in 3 places. Lower the support ring (F) down the post until it rests on the top of the upper planter (G).



**CAUTION:** To prevent product damage or personal injury from tip-over, lamp post planter base must be placed on a flat, level surface and be filled with 4 in. (minimum of 40 lbs.) of gravel or stone.

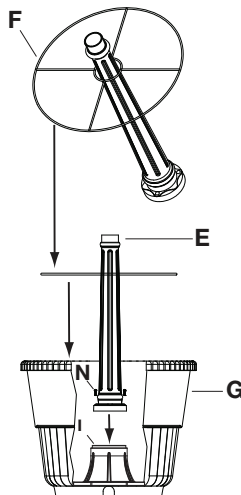

# 4

Attach lower post (E) to lamp post base (I) using 3 screw (N) if you have not already done so.

Attach the middle post (D) to the lower post (E) turning clockwise.

Attach the upper post (D) to the middle post (E), turning clockwise.

Place the plant hanger (B) on the upper post (C).

Attach the lantern body (A) to the upper post (C), turning clockwise.

**CAUTION:** Balance weight on the plant hanger by adding weight to both ends. Suggested maximum weight on the hanger is approximately 15 total pounds.

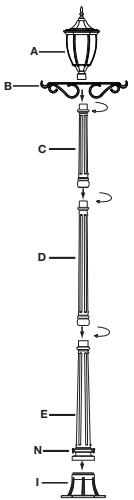

# 5

After completing steps one through four secure the lantern body with small screw (R) using the Hexagon Spanner (Q)

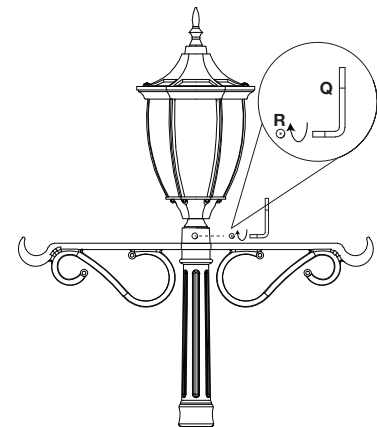

# 6

Thread hex nut (L) onto the j-bolt (K). Make sure the hex nut is threaded down the j-bolt far enough for the top of the j-bolt to fit through the mounting plate (J) and the lamp post base (I) with enough threads to secure the base to the j-bolts with acorn nuts (M). Repeat steps for other j-bolts.

Using mounting plate (J) as a guide insert the j-bolts with hex nuts into a wet concrete pad until the hex nuts are below pad level.

Place the mounting plate (J) onto j-bolts forming a mounting bracket.

Align the lamp post base (I) holes with the j-bolts and secure with the acorn nuts (M).

