

Limited Warranty

J & J Global, LLC (Seller) warrants to the original Buyer only, that each product will be free from defects in material and workmanship for a period of one (1) year from date of purchase. SELLER'S SOLE OBLIGATION AND BUYER'S EXCLUSIVE REMEDY UNDER THIS LIMITED WARRANTY SHALL BE THE REPAIR OR REPLACEMENT OF PARTS, WITHOUT CHARGE, WHICH ARE DEFECTIVE IN MATERIAL OR WORKMANSHIP. ANY PARTS AS DETERMINED BY THE SELLER WHICH HAVE BEEN MISUSED; ABUSED OR DAMAGED EITHER DIRECTLY OR INDIRECTLY FROM REPAIRS OR ALTERATIONS ATTEMPTED BY UNAUTHORIZED PERSON; IMPROPER MAINTENANCE, NEGLIGENCE OR ACCIDENT ARE NOT COVERED BY THIS LIMITED WARRANTY. This warranty does not apply to damage, heat-induced coloration changes, scratching or alteration due to normal use or weathering. To make a claim under this Limited Warranty, email contact@ezreplacement.com or visit www.ezreplacement.com for warranty questions and claims.

Additional Limitations

THIS LIMITED WARRANTY DOES NOT APPLY TO ACCESSORY OR CONSUMABLE ITEMS RELATED TO THIS PRODUCT. ALL IMPLIED WARRANTIES SHALL BE LIMITED IN DURATION TO ONE (1) YEAR FROM DATE OF PURCHASE. IN NO EVENT SHALL SELLER BE LIABLE FOR ANY INCIDENTAL OR CONSEQUENTIAL DAMAGES, INCLUDING BUT NOT LIMITED TO LIABILITY FOR LOSS OF PROFITS, ARISING FROM THE SALE OR USE OF THIS PRODUCT.

If any provision of this Limited Warranty is for any reason held to be invalid or unenforceable, such provision shall not affect any other provision herein, this Limited Warranty shall be construed as if such invalid and/or unenforceable provision had never been contained herein.

This warranty gives you special legal rights, and you may also have other rights which vary from state to state.

This warranty contains the entire agreement between Seller and Buyer and supercedes any and all prior agreements, arrangements, or understandings between the parties relating to product warranty.

Due to ongoing product development the actual product or products may vary from the illustrations or photos shown within this manual.

**For Manuals, Replacement Parts or Customer Service visit:
www.ezreplacement.com**

This product is intended for residential, non-commercial use.

⚠ WARNING

This product can expose you to lead, a chemical known to the state of California to cause cancer, birth defects and/or other reproductive harm. For more information go to www.p65warnings.ca.gov/product

MADE IN CHINA
©2019 J & J Global, LLC
Distributed By:
J & J Global, LLC
Carrollton, TX 75006



Customer Service Made EZ!

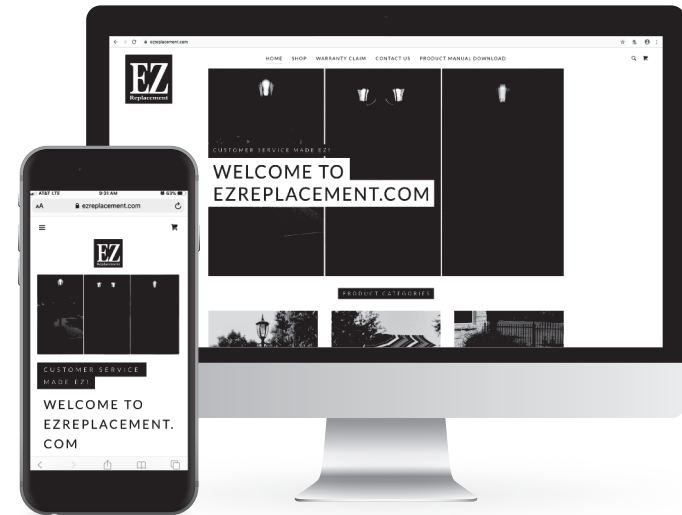

- User Friendly Interface
- Download Product Manuals
- Email your questions or concerns
- File Warranty Claim
- Follow-up within 24 Hrs
- Parts Ship within 48 Hrs.



Parts distribution made from our Carrollton, TX warehouse facility

ATTENTION!

**Please do not return this product to the retailer.
If you are missing or have damaged parts please email
contact@ezreplacement.com Or Call 877-477-2264**



52" Flickering Vittoria Solar Lamp Post

SKU: 302069, 312069, 342069



Read the instructions and precautions before use of this product

Please keep this instruction manual for future reference

For warranty information, please refer to the back page of this instruction manual.

Care Instructions

Clean any dirt and debris from the solar panels, the panels cannot recharge if the light is obstructed. Use a soft cloth to clean the panels. Do not use abrasives or chemicals that might scratch or damage the UV coating.

In a region where snow and ice are likely, and the light assembly is covered with snow for an extended period of time the batteries will require recharge for at least 8 hours.

Recycling

Please dispose of batteries properly. Consult your local telephone listing for a battery recycling center in your area.



Ambient temperature maximal 40°C (105°F)



Do not throw batteries into water!



Do not dispose of batteries in household waste







Protect batteries against heat and fire risk of explosion



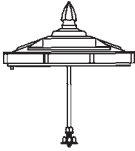

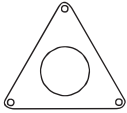

Recycling

Package Contents

| | | | |
|--------------------------------------------------------------------------------------------------------------------------------------------|--------------------------------------------------------------------------------------------------------------------------------------------|----------------------------------------------------------------------------------------------------------------------------------------|----------------------------------------------------------------------------------------------------------------------------------------|
| <p>A</p> <p>Lantern Body</p> <p>x1</p>  | <p>B</p> <p>Lantern Top</p> <p>x1</p>  | <p>C</p> <p>Upper Post</p> <p>x1</p>  | <p>D</p> <p>Lower Post</p> <p>x1</p>  |
| <p>E</p> <p>Lamp Post Base</p> <p>x1</p>  | <p>F</p> <p>Mounting Plate</p> <p>x1</p>  | | |
| | | | |

Hardware Contents

| | | | |
|-------------------------------------------------------------------------------------------------------------------------------------------|---------------------------------------------------------------------------------------------------------------------------------------|------------------------------------------------------------------------------------------------------------------------------------------|----------------------------------------------------------------------------------------------------------------------------------------------|
| <p>G</p> <p>J-Bolts</p> <p>x3</p>  | <p>H</p> <p>Hex Nut</p> <p>x3</p>  | <p>I</p> <p>Accorn Nut</p> <p>x3</p>  | <p>J</p> <p>Lantern Screws</p> <p>x2</p>  |
| <p>K</p> <p>Base Screws</p> <p>x2</p>  | | | |
| | | | |

1

Where To Place the Solar Light

Place the solar light in an area where it will receive direct sunlight for at least 8 hours per day. The number of hours the light is illuminated is directly proportional to the number of hours of sunlight it receives. If the light is placed in a shaded area, it will not be able to fully charge and its burn time will be limited. Do not place the light near other outdoor lighting like porch or streetlights. These may fool the sensor and keep the light from coming on, or cause it to turn off automatically.

2

Attach lower lamp post (D) to lamp post base (E) using bolt (K) in 3 place.

Place upper post (C) on the lower post (D) and twist clockwise to secure.

Place the completed lantern assembly (A) onto the upper lamp post (C) and twist clockwise to secure

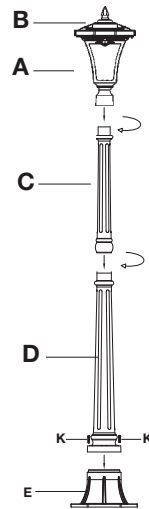

3

Allow lantern to charge for at least 8 hours in full sunlight with the ON/OFF switch in the OFF position. Before assembling the lamp post make sure the switch is set in the "OFF" position. The ON/OFF switch is located on the lantern top. Once the batteries are fully charged, set the ON/OFF switch to "W" for white light or "A" for amber light. If the lantern doesn't turn on after initial charging, ensure batteries are making contact with the terminals.

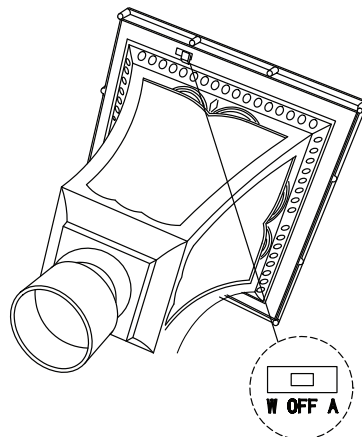

4

Remove the screws from the top of the lantern housing (A) as shown.

Carefully Lift the top of the housing (D), and open the three battery compartments.

Remove old batteries, replace batteries with new ones of same rating. Reference polarity direction inside battery compartment.

Replace lantern top and secure with screws.

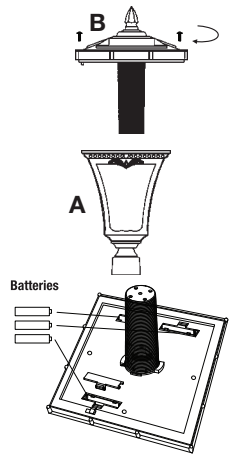

5

Thread hex nut (H) onto the j-bolt (G). Make sure the hex nut is threaded down the j-bolt far enough for the top of the j-bolt to fit through the mounting plate (F) and the lamp post base (E) with enough threads to secure the base to the j-bolts with acorn nuts (I). Repeat steps for other j-bolts.

Using mounting plate (F) as a guide insert the j-bolts with hex nuts into a wet concrete pad until the hex nuts are blow pad level.

Place the mounting plate (F) onto j-bolts forming a mounting bracket.

Align the lamp post base (E) holes with the j-bolts and secure with the acorn nuts (I).

