

### Limited Warranty

J & J Global, LLC (Seller) warrants to the original Buyer only, that each product will be free from defects in material and workmanship for a period of one (1) year from date of purchase. SELLER'S SOLE OBLIGATION AND BUYER'S EXCLUSIVE REMEDY UNDER THIS LIMITED WARRANTY SHALL BE THE REPAIR OR REPLACEMENT OF PARTS, WITHOUT CHARGE, WHICH ARE DEFECTIVE IN MATERIAL OR WORKMANSHIP. ANY PARTS AS DETERMINED BY THE SELLER WHICH HAVE BEEN MISUSED; ABUSED OR DAMAGED EITHER DIRECTLY OR INDIRECTLY FROM REPAIRS OR ALTERATIONS ATTEMPTED BY UNAUTHORIZED PERSON; IMPROPER MAINTENANCE, NEGLIGENCE OR ACCIDENT ARE NOT COVERED BY THIS LIMITED WARRANTY. This warranty does not apply to damage, heat-induced coloration changes, scratching or alteration due to normal use or weathering. To make a claim under this Limited Warranty, email [contact@ezreplacement.com](mailto:contact@ezreplacement.com) or visit [www.ezreplacement.com](http://www.ezreplacement.com) for warranty questions and claims.

#### Additional Limitations

THIS LIMITED WARRANTY DOES NOT APPLY TO ACCESSORY OR CONSUMABLE ITEMS RELATED TO THIS PRODUCT. ALL IMPLIED WARRANTIES SHALL BE LIMITED IN DURATION TO ONE (1) YEAR FROM DATE OF PURCHASE. IN NO EVENT SHALL SELLER BE LIABLE FOR ANY INCIDENTAL OR CONSEQUENTIAL DAMAGES, INCLUDING BUT NOT LIMITED TO LIABILITY FOR LOSS OF PROFITS, ARISING FROM THE SALE OR USE OF THIS PRODUCT.

If any provision of this Limited Warranty is for any reason held to be invalid or unenforceable, such provision shall not affect any other provision herein, this Limited Warranty shall be construed as if such invalid and/or unenforceable provision had never been contained herein.

This warranty gives you special legal rights, and you may also have other rights which vary from state to state.

This warranty contains the entire agreement between Seller and Buyer and supercedes any and all prior agreements, arrangements, or understandings between the parties relating to product warranty.

Due to ongoing product development the actual product or products may vary from the illustrations or photos shown within this manual.

For Manuals, Replacement Parts or Customer Service visit:  
[www.ezreplacement.com](http://www.ezreplacement.com)

This product is intended for residential, non-commercial use.

#### ⚠ WARNING

This product can expose you to lead, a chemical known to the state of California to cause cancer, birth defects and/or other reproductive harm. For more information go to [www.p65warnings.ca.gov/product](http://www.p65warnings.ca.gov/product)

**MADE IN CHINA**  
©2019 J & J Global, LLC  
Distributed By:  
J & J Global, LLC  
Carrollton, TX 75006

**EZ**  
Replacement

[www.EZreplacement.com](http://www.EZreplacement.com)

# Customer Service Made EZ!

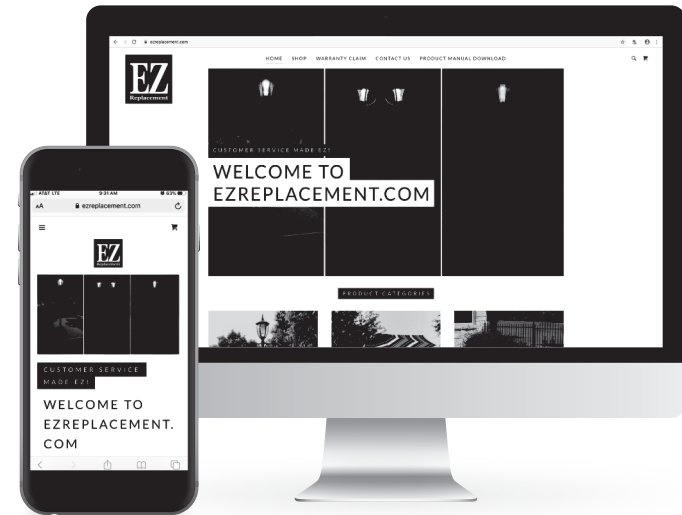

- User Friendly Interface
- Download Product Manuals
- Email your questions or concerns
- File Warranty Claim
- Follow-up within 24 Hrs
- Parts Ship within 48 Hrs.



Parts distribution made from our Carrollton, TX warehouse facility

## ATTENTION!

Please do not return this product to the retailer.  
If you are missing or have damaged parts please email  
[contact@ezreplacement.com](mailto:contact@ezreplacement.com) Or Call 877-477-2264



# RealWork Rifle Safe

SKU: 401014



Read the instructions and precautions before use of this product

Please keep this instruction manual for future reference

For warranty information, please refer to the back page of this instruction manual.

## Care Instructions

Do Not mix old batteries with new batteries.

Do not mix alkaline standard (Carbon-Zinc) or rechargeable (Nickel-Cadmium) batteries

### Recycling

Please dispose of batteries properly. Consult your local telephone listing for a battery recycling center in your area.



Ambient temperature maximum 40°C (105°F)



Do not dispose of batteries in household waste



Do not throw batteries into water!



Protect batteries against heat and fire risk of explosion



Recycling

# 4

## Opening Safe By Digital Password

Input the password you set up, then press "B". Green indicating light will light, turn the knob clockwise, then turn handle clockwise and open safe.

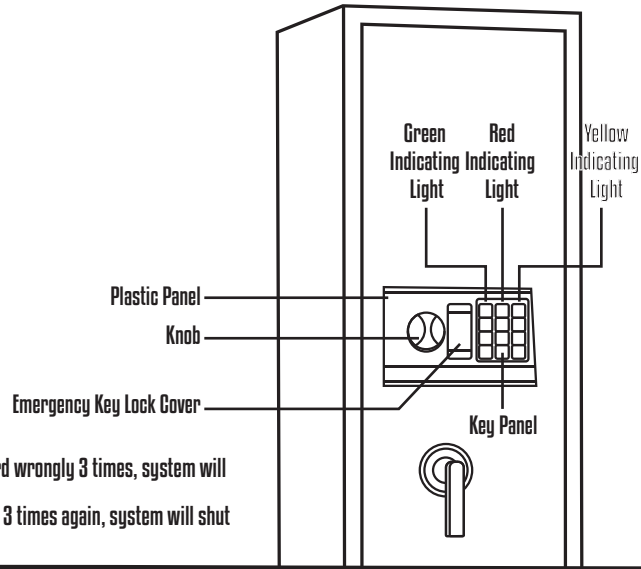

**Warning:** If input password wrongly 3 times, system will shut down in 20s.  
If input password wrongly 3 times again, system will shut down 5 minutes.

# 5

## Emergency Opening

If you forget password or there is no enough power to run system, please use emergency key to open safe. Open emergency key lock cover, insert emergency key and turn it left to end, at the same time, turn knob and handle right to open the safe.

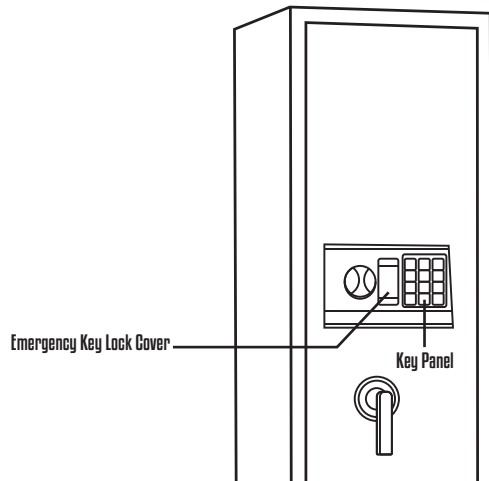

**Warning:** If red indicating light lights when you use safe, please change new batteries.

## Package Contents

### A

#### Safe

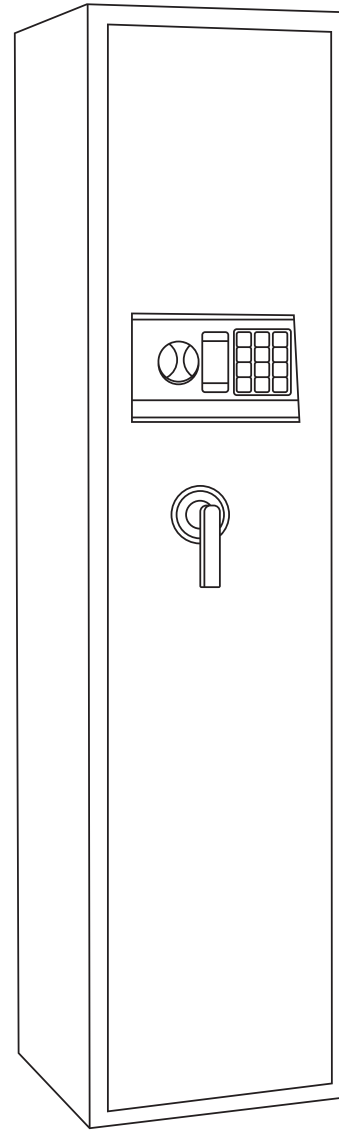

### B

#### Emergency Keys

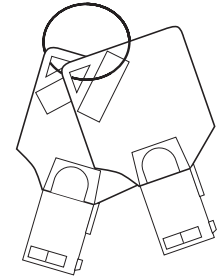

Carefully remove the contents from the package. If any parts are missing do not attempt to use the product until they have been obtained and correctly installed.

# 1

## Opening Safe for first Time

Open emergency key lock cover, insert emergency key and turn it left to unlock, at the same time, turn knob and handle right to open the safe.

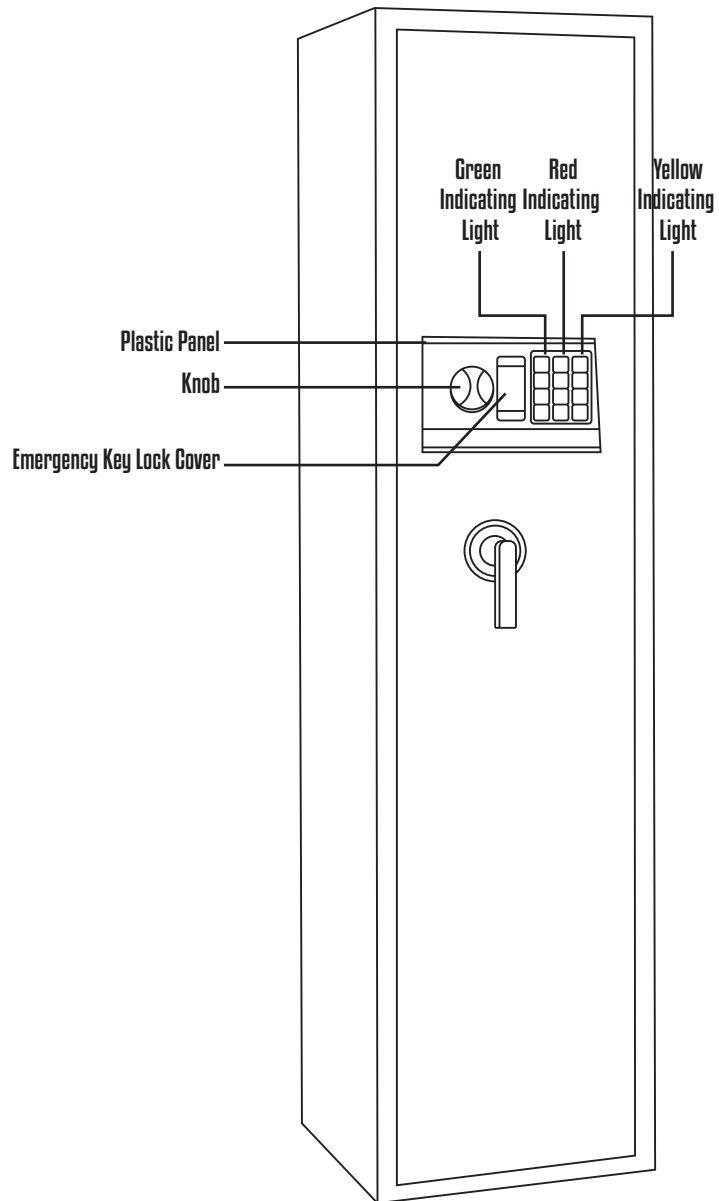

# 2

## Install Batteries

Remove the battery box cover at the backside of door and install batteries properly. (4 AA batteries included.)

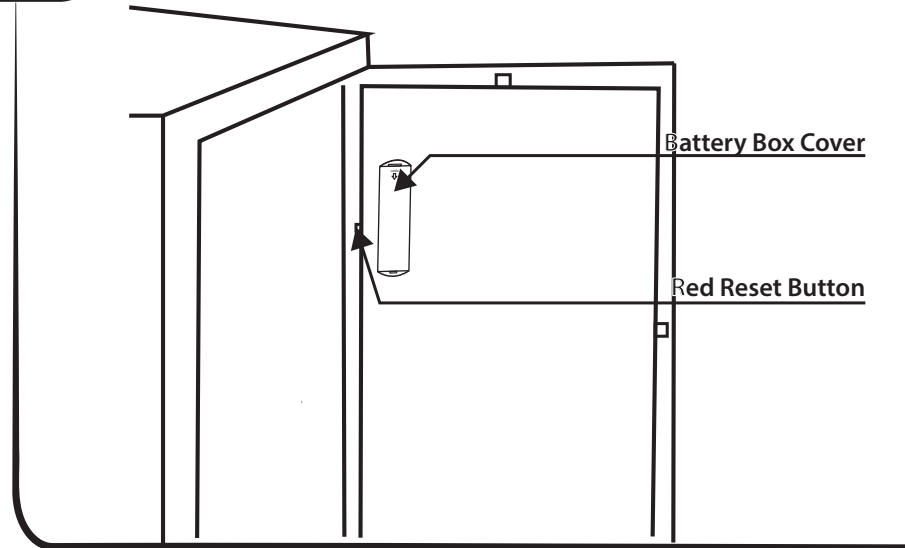

# 3

## Set Up Password

When opening, please press the red reset button at the backside of door, then yellow indicating light will light, input 3-8 expected digitals, then press "B" for setting up.

