

Limited Warranty

J & J Global, LLC (Seller) warrants to the original Buyer only, that each product will be free from defects in material and workmanship for a period of one (1) year from date of purchase. SELLER'S SOLE OBLIGATION AND BUYER'S EXCLUSIVE REMEDY UNDER THIS LIMITED WARRANTY SHALL BE THE REPAIR OR REPLACEMENT OF PARTS, WITHOUT CHARGE, WHICH ARE DEFECTIVE IN MATERIAL OR WORKMANSHIP. ANY PARTS AS DETERMINED BY THE SELLER WHICH HAVE BEEN MISUSED; ABUSED OR DAMAGED EITHER DIRECTLY OR INDIRECTLY FROM REPAIRS OR ALTERATIONS ATTEMPTED BY UNAUTHORIZED PERSON; IMPROPER MAINTENANCE, NEGLIGENCE OR ACCIDENT ARE NOT COVERED BY THIS LIMITED WARRANTY. This warranty does not apply to damage, heat-induced coloration changes, scratching or alteration due to normal use or weathering. To make a claim under this Limited Warranty, email contact@ezreplacement.com or visit www.ezreplacement.com for warranty questions and claims.

Additional Limitations

THIS LIMITED WARRANTY DOES NOT APPLY TO ACCESSORY OR CONSUMABLE ITEMS RELATED TO THIS PRODUCT. ALL IMPLIED WARRANTIES SHALL BE LIMITED IN DURATION TO ONE (1) YEAR FROM DATE OF PURCHASE. IN NO EVENT SHALL SELLER BE LIABLE FOR ANY INCIDENTAL OR CONSEQUENTIAL DAMAGES, INCLUDING BUT NOT LIMITED TO LIABILITY FOR LOSS OF PROFITS, ARISING FROM THE SALE OR USE OF THIS PRODUCT.

If any provision of this Limited Warranty is for any reason held to be invalid or unenforceable, such provision shall not affect any other provision herein, this Limited Warranty shall be construed as if such invalid and/or unenforceable provision had never been contained herein.

This warranty gives you special legal rights, and you may also have other rights which vary from state to state.

This warranty contains the entire agreement between Seller and Buyer and supercedes any and all prior agreements, arrangements, or understandings between the parties relating to product warranty.

Due to ongoing product development the actual product or products may vary from the illustrations or photos shown within this manual.

**For Manuals, Replacement Parts or Customer Service visit:
www.ezreplacement.com**

This product is intended for residential, non-commercial use.

WARNING

This product can expose you to lead, a chemical known to the state of California to cause cancer, birth defects and/or other reproductive harm. For more information go to www.p65warnings.ca.gov/product

MADE IN CHINA
©2020 J & J Global, LLC
Distributed By:
J & J Global, LLC
Irving, TX 75038



Customer Service Made EZ!

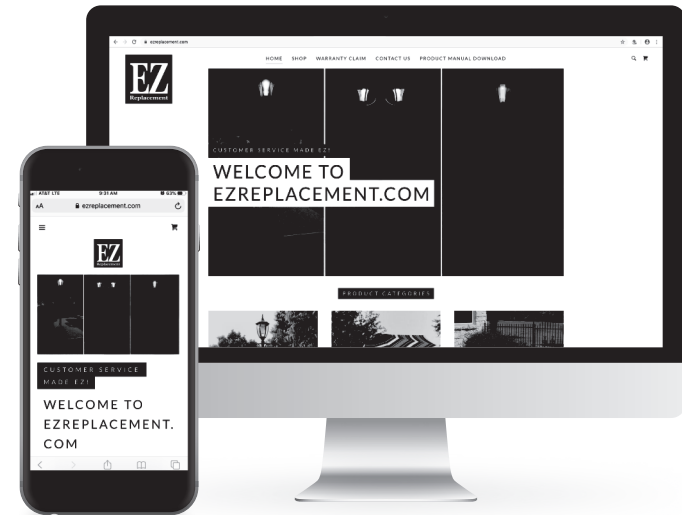

- User Friendly Interface
- Download Product Manuals
- Email your questions or concerns
- File Warranty Claim
- Follow-up within 24 Hrs
- Parts Ship within 48 Hrs.



Parts distribution made from our Carrollton, TX warehouse facility

ATTENTION!

**Please do not return this product to the retailer.
If you are missing or have damaged parts please email
contact@ezreplacement.com Or Call 877-477-2264**



Beacon Point Solar Lighted Birdbath

SKU: 801010, 801011

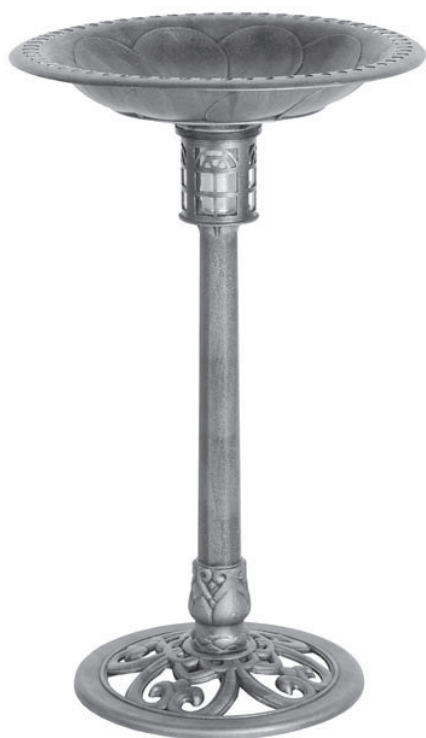

Read the instructions and precautions before use of this product

Please keep this instruction manual for future reference

For warranty information, please refer to the back page of this instruction manual.

Care Instructions

Clean any dirt and debris from the solar panels, the panels cannot recharge if the light is obstructed. Use a soft cloth to clean the panels. Do not use abrasives or chemicals that might scratch or damage the UV coating.

In a region where snow and ice are likely, and the light assembly is covered with snow for an extended period of time the batteries will require recharge for at least 8 hours.

Recycling

Please dispose of batteries properly. Consult your local telephone listing for a battery recycling center in your area.



Ambient temperature maximal 40°C (105°F)



Do not dispose of batteries in household waste



Do not throw batteries into water!







Protect batteries against heat and fire risk of explosion

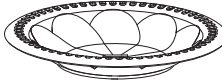
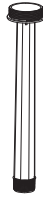

Recycling

Package Contents

A Solar Light Assembly x1 	B Basin x1 	C Post x1 	D Post Connector x1 
E Base x1 	F Rechargeable Battery x1 		

Care Instructions

1. Keep the solar panel on the solar light assembly inside the birdbath basin clear from debris.
2. Clean solar panel with a damp cloth, do not use any abrasive or chemical cleaners to clean the solar panel.

1

Operating Solar Light

NOTE: The rechargeable battery comes preinstalled inside the solar light assembly. The battery needs to be fully charged before the light will operate properly. The rechargeable battery requires at least 8-hours of full sun light to fully charge.

Place the assembled birdbath in full sun light, away from streetlight or other light sources which can cause the light to turn off.

Locate the pull tab under the basin. Remove the pull tab by pulling up on the exposed part of the tab.

Once the battery is fully charged, the LED light in the globe will automatically come on at dusk and turn off at dawn.

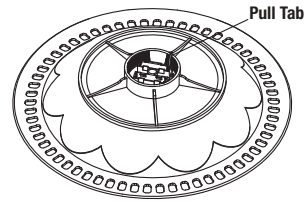

2

Thread the post (C) into the post connector (D) turning clockwise to tighten.

Thread the post connector (D) into the base (E) turning clockwise to tighten.

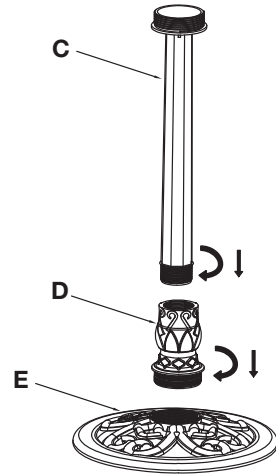

3

Thread the solar light assembly (A) onto the top of the post (C) turning clockwise to tighten.

Thread the basin (B) onto top of solar light assembly (A) threading the assembly clockwise to tighten.

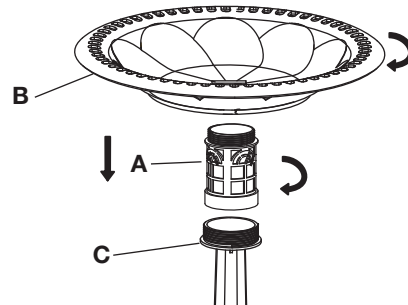

4

Battery Replacement

Remove the basin (B) from the solar light assembly (A).

Turn the basin upside down to remove the battery (F).

Remove and replace the old battery with new one of the same rating. Reference the battery compartment for proper polarity direction.

Reference the "Operating Solar Light" to restore solar light to full operation.

