

### Limited Warranty

J & J Global, LLC (Seller) warrants to the original Buyer only, that each product will be free from defects in material and workmanship for a period of one (1) year from date of purchase. SELLER'S SOLE OBLIGATION AND BUYER'S EXCLUSIVE REMEDY UNDER THIS LIMITED WARRANTY SHALL BE THE REPAIR OR REPLACEMENT OF PARTS, WITHOUT CHARGE, WHICH ARE DEFECTIVE IN MATERIAL OR WORKMANSHIP. ANY PARTS AS DETERMINED BY THE SELLER WHICH HAVE BEEN MISUSED; ABUSED OR DAMAGED EITHER DIRECTLY OR INDIRECTLY FROM REPAIRS OR ALTERATIONS ATTEMPTED BY UNAUTHORIZED PERSON; IMPROPER MAINTENANCE, NEGLIGENCE OR ACCIDENT ARE NOT COVERED BY THIS LIMITED WARRANTY. This warranty does not apply to damage, heat-induced coloration changes, scratching or alteration due to normal use or weathering. To make a claim under this Limited Warranty, email [contact@ezreplacement.com](mailto:contact@ezreplacement.com) or visit [www.ezreplacement.com](http://www.ezreplacement.com) for warranty questions and claims.

#### Additional Limitations

THIS LIMITED WARRANTY DOES NOT APPLY TO ACCESSORY OR CONSUMABLE ITEMS RELATED TO THIS PRODUCT. ALL IMPLIED WARRANTIES SHALL BE LIMITED IN DURATION TO ONE (1) YEAR FROM DATE OF PURCHASE. IN NO EVENT SHALL SELLER BE LIABLE FOR ANY INCIDENTAL OR CONSEQUENTIAL DAMAGES, INCLUDING BUT NOT LIMITED TO LIABILITY FOR LOSS OF PROFITS, ARISING FROM THE SALE OR USE OF THIS PRODUCT.

If any provision of this Limited Warranty is for any reason held to be invalid or unenforceable, such provision shall not affect any other provision herein, this Limited Warranty shall be construed as if such invalid and/or unenforceable provision had never been contained herein.

This warranty gives you special legal rights, and you may also have other rights which vary from state to state.

This warranty contains the entire agreement between Seller and Buyer and supercedes any and all prior agreements, arrangements, or understandings between the parties relating to product warranty.

Due to ongoing product development the actual product or products may vary from the illustrations or photos shown within this manual.

For Manuals, Replacement Parts or Customer Service visit:  
[www.ezreplacement.com](http://www.ezreplacement.com)

This product is intended for residential, non-commercial use.

#### ⚠ WARNING

This product can expose you to lead, a chemical known to the state of California to cause cancer, birth defects and/or other reproductive harm. For more information go to [www.p65warnings.ca.gov/product](http://www.p65warnings.ca.gov/product)

**MADE IN CHINA**  
©2019 J & J Global, LLC  
Distributed By:  
J & J Global, LLC  
Carrollton, TX 75006



# Customer Service Made EZ!

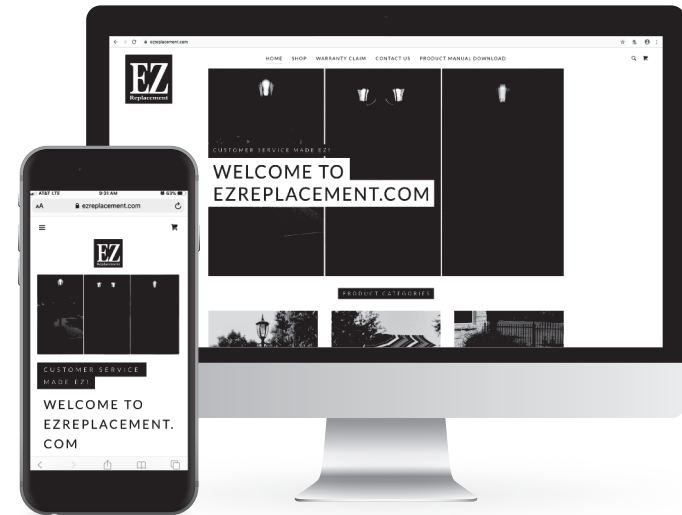

- User Friendly Interface
- Download Product Manuals
- Email your questions or concerns
- File Warranty Claim
- Follow-up within 24 Hrs
- Parts Ship within 48 Hrs.



Parts distribution made from our Carrollton, TX warehouse facility

## ATTENTION!

Please do not return this product to the retailer.  
If you are missing or have damaged parts please email  
[contact@ezreplacement.com](mailto:contact@ezreplacement.com) Or Call 877-477-2264



# 9' x 7' Rectangle Solar Lighted Umbrella

SKU: 801025, 801027, 801050, 801023



**Read the instructions and precautions before use of this product**

**Please keep this instruction manual for future reference**

For warranty information, please refer to the back page of this instruction manual.

## Care Instructions

Clean any dirt and debris from the solar panels, the panels cannot recharge if the light is obstructed. Use a soft cloth to clean the panels. Do not use abrasives or chemicals that might scratch or damage the UV coating.

### Recycling

Please dispose of batteries properly. Consult your local telephone listing for a battery recycling center in your area.



Ambient temperature maximal 40°C (105°F)



Do not dispose of batteries in household waste



Do not throw batteries into water!



Protect batteries against heat and fire risk of explosion



Recycling

# 6

## Battery Replacement

The rechargeable batteries come preinstalled from the factory. The batteries are located inside the battery compartment.

1. (See Illustration) Remove battery compartment (C) from top of umbrella, turn counter-clockwise to unlock and separate.
2. Carefully unplug connector plug from battery compartment receptacle.
3. Remove and retain the four small screws from the cover and remove the cover.
4. Remove and replace old batteries with new rechargeable batteries of the same rating.
5. Install new batteries in proper direction, reference polarity (+/-) markings for correct placement.
6. Replace the battery cover and secure with four screws retained.
7. Insert the umbrella connector plug into receptacle located on the bottom of the battery compartment.
8. Insert the solar panel back into the top of the umbrella.
9. Turn the solar panel clockwise to lock and secure.

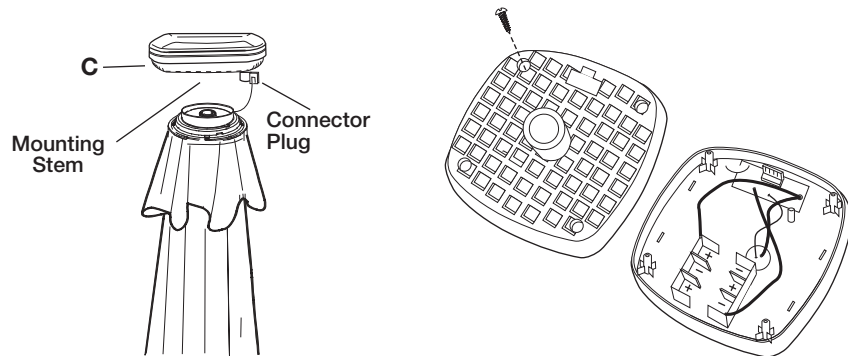

## Package Contents

A

Top Pole With Umbrella

x1



B

Bottom Pole

x1



C

Solar Panel

x1



## General Safety

- Never leave children unsupervised with the packaging material. There is a risk of suffocation.
- Improper use of this item may result in physical harm.
- Ensure that the article is properly stable before use.
- Examine the item for damage or wear before each use.
- Close and store the umbrella when not in use.
- Always securely fasten the umbrella into an umbrella base.
- DO NOT use the product in windy conditions. Excessive wind can cause damage to the product or danger to people.
- The light source of this luminaire is not replaceable. When the light source reaches its end of life the whole luminaire shall be replaced.
- The battery must be removed from the appliance before its scrapped.
- The battery is to be disposed of safely.

# 1

(See Illustration) Position battery compartment (A) at top of umbrella (B).

Insert connector plug attached to umbrella into receptacle located on battery compartment.

Insert battery compartment stem into top of umbrella. Turn battery compartment clockwise to lock and secure.

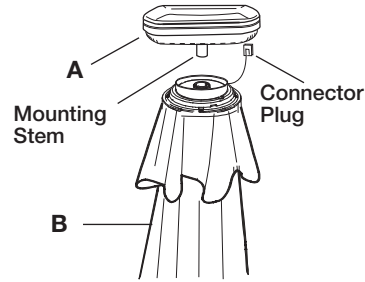

 Solar Panel receives charge from sunlight.

# 2

Secure the top pole (A) to the bottom pole (B).

 **CAUTION:** The Umbrella ribs may compress during shipping. Before opening the umbrella turn it upside down and shake it gently to separate ribs.

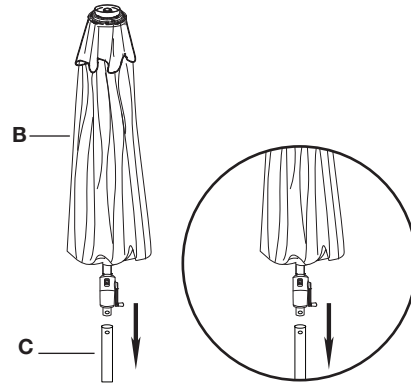

# 3

Slowly turn the crank clockwise taking up the slack of the cord.

 **CAUTION:** If you continue to turn the crank counter-clockwise after the umbrella is closed, the umbrella will start to open again it is possible to open the umbrella by turning the crank in a counter-clockwise direction. However, the umbrella will not stay open when the crank is turned in a counter-clockwise direction. The locking mechanism that keeps the umbrella open only works when the crank is turned in a clockwise direction

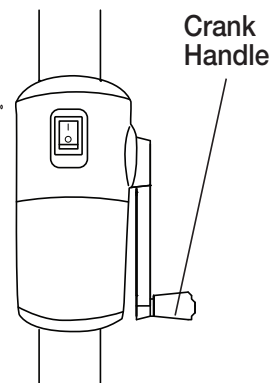

# 4

Press the button as shown to tilt the umbrella to the perfect position.

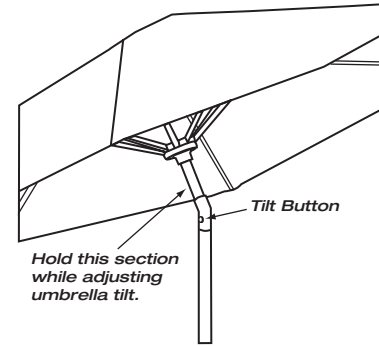

# 5

To turn LED lights on, switch the ON/OFF button located on the crank housing to the ON (I) position.

 **CAUTION:** The LED lights do not turn off automatically. Always turn the lights off when not in use.

