

GENERAL CATALOGUE ²⁰²¹/₂₀₂₂

HEATING · COOLING · LIGHTING
SOUND · MODULAR · CONTROL



NEW

RELAX GLASS COMPACT PAGE 9

io io-homecontrol® with somfy. Remote



Valid from September 2021.
(Changes and errors excepted)

BURDA WORLDWIDE TECHNOLOGIES GMBH

Rudolf-Diesel-Strasse 18 · D-65760 Eschborn · tel +49 6173 / 324 24 0 · fax +49 6173 / 324 24 24 · email info@burdawtg.de · www.burdawtg.com

Foreword

JIRI BURDA



DEAR BURDA PARTNERS AND CUSTOMERS,

I am pleased to present our current general catalogue 2021/22 to you.

Corona has presented us all with great challenges in the past few months. The withdrawal from public life has severely affected many industries, especially gastronomy. At the same time, the crisis also offered opportunities for the end customer market with the focus on furnishing the home, indoor and outdoor.

One of the most far-reaching consequences of the crisis for manufacturers, however, are global delivery bottlenecks, transport problems, material shortages and increases in cost, which also affect our productions and suppliers to a significant extent. This unfortunately also has an impact reflected in a slight increase in our prices.

Despite all the difficulties, we look to the future with optimism! I thank you, dear partners and customers, for your support and look forward to another successful business year and good cooperation.

We hope you enjoy browsing through our innovative product range.

Yours
Jiri Burda
Managing Director
Burda Worldwide Technologies GmbH

A handwritten signature in black ink, appearing to read 'Jiri Burda', written over a white background.

NEW: RELAX GLASS COMPACT – slim design with WiFi
With the new COMPACT infrared heater, we present an even slimmer WiFi version of the RELAX GLASS heater series with Schott Nextrema® glass ceramic. The new model is also ideal for installation in umbrellas, tents and as a standing solution with pole and base, RELAX GLASS STAND, with double fastening.

page 9

NEW: SMART TOWER COVER

With the new SMART TOWER protective cover, we offer the perfect solution for the weatherproof, dust-free and dirt-repellent storage of our SMART TOWER standing heaters.

page 33

NEW: Tent fixation TentFIT for heaters

The tent fastening set including Velcro fastener and safety rope is perfect for installing radiant heaters from the TERM2000 series (polished aluminum) and RELAX GLASS in small and large tents.

page 33

BESTSELLER:

Short wave radiant heaters RELAX GLASS conquer the markets

The RELAX GLASS radiant heater series is one of the TOP sales products again this year. The extremely powerful, elegant infrared heater series with Schott Nextrema® glass ceramics offers the best heat output in outdoor areas thanks to shortwave. Available with and without integrated radio dimmer or as a SMART-HOME solution with io-homecontrol® and Somfy remote control. A must-have in every high-quality retailer range.

from page 8

Content

IO-HOMECONTROL® HEATER WITH SOMFY REMOTE	page 4-5
BLUETOOTH HEATER	page 6-7
RELAX GLASS SERIES	page 8-10
NEW: RELAX GLASS COMPACT	page 9
RELAX GLASS MODULAR SERIES	page 11-12
RELAX DARK SERIES	page 13
TERM2000 SERIES	page 14-17
TERM2000 LIGHT & HEAT	page 18-19
TERM2000 MODULAR SERIES	page 20-25
SMART SERIES	page 26-27
PERFECTCLIME® SERIES	page 28-31
HEATER ACCESSORIES	page 32-37
HEATPANELS	page 38-39
HEATPANELS THERMOSTATS AND ACCESSORIES	page 40
MORE SALES THROUGH SALES PROMOTION	page 41
GOOD TO KNOW	page 42-43



SMART-HOME RADIANT HEATERS

with io-homecontrol® & Somfy remote



Our radiant heater series **RELAX GLASS io** and **TERM2000 io** with io-homecontrol® allow for an easy heater integration into **SMART HOME** solutions by Somfy. A built-in io transmitter/circuit board in the heater corresponds via radio with a remote control from Somfy, via which the infrared heaters can be switched on and off and dimmed in several stages. Every terrace landscape becomes an oasis of well-being with smart heating solutions in exclusive designs. Somfy remote controls are optionally available. Compatible with KNX and TaHoma®.

Please note: The io-homecontrol® radio protocol is not a standard in America (North/South), Canada, Australia, New Zealand, India, Israel and Cuba.



2 kW

74 cm

TERM2000 io IP67

Slow blow fuse 16 Amp (C16) recommended



CODE	EAN	POWER (in watt)	COLOR	PROTECTION CLASS	DIMENSIONS (w x h x d in cm)	WEIGHT (in g)	CABLE	CONNECTION
10URCAC200V9010	4260409696570	2000	White	IP67	74 x 10 x 12.5	2500	1.9 m 3-wire, 1.5 mm ² , Schuko plug	L/N/PE, 230-240 V ~ 50 Hz
10URCAC200V9005	4260409696587	2000	Black	IP67	74 x 10 x 12.5	2500	1.9 m 3-wire, 1.5 mm ² , Schuko plug	L/N/PE, 230-240 V ~ 50 Hz
10URCAC200V7016	4260409696594	2000	Anthracite	IP67	74 x 10 x 12.5	2500	1.9 m 3-wire, 1.5 mm ² , Schuko plug	L/N/PE, 230-240 V ~ 50 Hz

2.2 kW

3 kW

RELAX GLASS io IP65

Extremely light reduced with tinted ceramic-glass SCHOTT NEXTREMA®



Waterproof



OUTDOOR INFRARED HEATER

90 cm



Brackets included

CASE COLORS



GLASS SCREEN



128,6 cm



CODE	EAN	POWER (in watt)	COLOR (Case/Glass)	PROTECTION CLASS	DIMENSIONS (w x h x d in cm)	WEIGHT (in g)	CABLE	CONNECTION
IOBRELG2200-1	4260409696402	2200	Black/Black	IP65	90 x 17 x 15.5	5400	1.8 m 3-wire, 1.5 mm ² , Schuko plug	L/N/PE, 230-240 V ~ 50 Hz
IOBRELG2200-3	4260409696419	2200	Silver/Schwarz	IP65	90 x 17 x 15.5	5400	1.8 m 3-wire, 1.5 mm ² , Schuko plug	L/N/PE, 230-240 V ~ 50 Hz
IOBRELG2200-3W	4260409696426	2200	Silver/White	IP65	90 x 17 x 15.5	5400	1.8 m 3-wire, 1.5 mm ² , Schuko plug	L/N/PE, 230-240 V ~ 50 Hz
IOBRELG3000-1	4260409697379	3000	Black/Black	IP65	128.6 x 17 x 15.5	7100	1.8 m 3-wire, 1.5 mm ² , Schuko plug	L/N/PE, 230-240 V ~ 50 Hz
IOBRELG3000-3	4260409696501	3000	Silver/Black	IP65	128.6 x 17 x 15.5	7100	1.8 m 3-wire, 1.5 mm ² , Schuko plug	L/N/PE, 230-240 V ~ 50 Hz
IOBRELG3000-3W	4260409696686	3000	Silver/White	IP65	128.6 x 17 x 15.5	7100	1.8 m 3-wire, 1.5 mm ² , Schuko plug	L/N/PE, 230-240 V ~ 50 Hz

SOMFY WIRELESS HANDHELD TRANSMITTERS

CODE	EAN	DESCRIPTION	COLOR	PROTECTION CLASS	DIMENSIONS (w x h x d in mm)
IOSIT1VP	4260409696716	Situo 1 VAR io Pure II	White	IP30	38 x 145 x 16
IOSIT5VAMP	4260409696723	Situo 5 VAR AM io Pure II	White	IP30	38 x 145 x 16





BLUETOOTH

Our **BLUETOOTH** radiant heaters **TERM2000 BLUETOOTH** and **SMART BLUETOOTH** enable convenient, wireless heater control via smartphone with the free **BURDA APP** for iOS and Android devices. In addition to smartphone control, the **BLUETOOTH** heaters can be controlled with a un-coded infrared remote control (included in the set) or manually operated using an integrated switch on the device.



Available for Burda Bluetooth heater and Bluetooth dimmer.

BLUETOOTH DIMMER

With our **BLUETOOTH DIMMER** you can upgrade one or more radiant heaters with a total output of up to 3000 watts and thus enjoy all the advantages of **BLUETOOTH** control via smartphone via the BURDA APP.



To download the App please scan the QR-Code.

See page 34

For free for Android and iOS devices.

- ✓ Regulation for up to eight heaters
- ✓ Range: 50 m (no line of sight required)
- ✓ Timer function



Remote Control included

For an easy control of your Bluetooth heater or dimmer without smartphone.

71 cm

2 kW



TERM2000 BLUETOOTH IP67

Slow blow fuse 16 Amp (C16) recommended



- ✓ Colors: Anthracite, white and black
- ✓ Ultra Low Glare tube
- ✓ Waterproof IP67

CODE	EAN	POWER (in watt)	COLOR	PROTECTION CLASS	DIMENSIONS (w x h x d in cm)	WEIGHT (in g)	CABLE	CONNECTION
BTURCAC200V9010	4260409692442	2000	White	IP67	71 x 10 x 12.5	2500	1.9 m 3-wire 1.5 mm ² , Schuko plug	1/N/PE ~ 230 V 50 Hz
BTURCAC200V7016	4260409692459	2000	Anthracite	IP67	71 x 10 x 12.5	2500	1.9 m 3-wire 1.5 mm ² , Schuko plug	1/N/PE ~ 230 V 50 Hz
BTURCAC200V9005	4260409692435	2000	Black	IP67	71 x 10 x 12.5	2500	1.9 m 3-wire 1.5 mm ² , Schuko plug	1/N/PE ~ 230 V 50 Hz

2 kW

- ✓ Colors: Silver, white and black
- ✓ Splash water protection IP24



Remote Control included

For an easy control of your Bluetooth heater or dimmer without smartphone.



48 cm



Mounting bracket included (L-Bracket)

SMART BLUETOOTH IP24

Slow blow fuse 16 Amp (C16) recommended



CODE	EAN	POWER (in watt)	COLOR	PROTECTION CLASS	DIMENSIONS (w x h x d in cm)	WEIGHT (in g)	CABLE	CONNECTION
BTBHS2024	4260409693135	2000	White	IP24	48 x 14.5 x 9.5	2500	1.9 m 3-wire 1.5 mm ² , Schuko plug	1/N/PE ~ 230 V 50 Hz
BTBHS2024-1	4260409693142	2000	Black	IP24	48 x 14.5 x 9.5	2500	1.9 m 3-wire 1.5 mm ² , Schuko plug	1/N/PE ~ 230 V 50 Hz
BTBHS2024-3	4260409693159	2000	Silver	IP24	48 x 14.5 x 9.5	2500	1.9 m 3-wire 1.5 mm ² , Schuko plug	1/N/PE ~ 230 V 50 Hz

OUTDOOR INFRARED HEATER

126 cm

3 kW



Fits with:
SMART TOWER COVER
see page 33



Remote Control included

For an easy control of your Bluetooth heater or dimmer without smartphone.

SMART TOWER BLUETOOTH IP24

Slow blow fuse 16 Amp (C16) recommended

- ✓ Colors: Silver, white and black
- ✓ Splash water protection IP24



CODE	EAN	POWER (in watt)	COLOR	PROTECTION CLASS	DIMENSIONS (w x h x d in cm)	WEIGHT (in g)	CABLE	CONNECTION
BTBHST3024	4260409694002	2 x 1500	White	IP24	29 x 126 x 32	7300	1.9 m 3-wire 1.5 mm ² , Schuko plug	1/N/PE ~ 230 V 50 Hz
BTBHST3024-1	4260409694026	2 x 1500	Black	IP24	29 x 126 x 32	7300	1.9 m 3-wire 1.5 mm ² , Schuko plug	1/N/PE ~ 230 V 50 Hz
BTBHST3024-3	4260409694019	2 x 1500	Silver	IP24	29 x 126 x 32	7300	1.9 m 3-wire 1.5 mm ² , Schuko plug	1/N/PE ~ 230 V 50 Hz

EXTREME
LOW
GLARE



RELAX GLASS

OUTDOOR

RELAX GLASS – POWERFUL HEAT AND STRONG DESIGN WITH SCHOTT NEXTREMA® GLASS CERAMIC

With the RELAX GLASS heater series we present extremely powerful and visually sophisticated shortwave heaters (IR-A) with Schott Nextrema® ceramic glass fronts for impressive instant heat in all outdoor areas.

The waterproof radiant heater series impresses with elegance thanks to the smart glass ceramic front paired with high heat output thanks to the use of infrared shortwave technology. A special feature of the glass ceramic radiant heaters is the dimmed red light emission with up to 95% light reduction in the ambience. The designer heaters are available in different power levels (watts), sizes and in varying design colors for glass and housing. Another selection criterion is the equipment. You can choose between heaters with an integrated dimmer and remote control or without and optionally as a smart home solution with io-homecontrol® (see page 5).

RELAX GLASS heaters are suitable for wall and ceiling mounting – with the exception of models with a 2.200 watt heating tube*. Flush mounted ceiling installation is also possible for all models up to 1.800 watts. A suitable installation frame is available.

* wall mounting only!



Suitable accessories: RELAX GLASS STAND, pole and base made of stainless steel for single or double fastening of RELAX GLASS radiant heaters.

See page 32



RELAX GLASS COMPACT IRA IP65

Simple remote control via WiFi connection per app for Android or iOS with tinted glass ceramic SCHOTT NEXTREMA®.

 Waterproof
 CASE COLOR:  Black
 GLASS SCREEN:  Black







OUTDOOR INFRARED HEATER

74.2 cm

CODE	EAN	POWER (in watt)	COLOR (Case/Glass)	PROTECTION CLASS	DIMENSIONS (w x h x d in cm)	WEIGHT (in g)	CABLE	CONNECTION
BRELG2000RDW	4260409697751	2000	Black/Black	IP65	74,2 x 13,9 x 11	3300	1.8 m 3-wire 1.5 mm², Schuko plug	L/N/PE, 230-240 V ~ 50 Hz

RELAX GLASS IRA IP65

Extremely light reduced with tinted ceramic-glass SCHOTT NEXTREMA®

 Waterproof
 CASE COLORS:  Silver  Black
 GLASS SCREEN:  White  Black



CODE	EAN	POWER (in watt)	COLOR (Case/Glass)	PROTECTION CLASS	DIMENSIONS (w x h x d in cm)	WEIGHT (in g)	CABLE	CONNECTION
With Dimmer/Remote								
BRELG1500RD-1	4260409695450	1500	Black/Black	IP65	90 x 17 x 8	5200	1.8 m 3-wire 1.5 mm², Schuko plug	L/N/PE, 230-240 V ~ 50 Hz
BRELG1500RD-3	4260409695443	1500	Silver/Black	IP65	90 x 17 x 8	5200	1.8 m 3-wire 1.5 mm², Schuko plug	L/N/PE, 230-240 V ~ 50 Hz
BRELG1500RD-3W	4260409695818	1500	Silver/White	IP65	90 x 17 x 8	5200	1.8 m 3-wire 1.5 mm², Schuko plug	L/N/PE, 230-240 V ~ 50 Hz
BRELG1800RD-1	4260409695436	1800	Black/Black	IP65	90 x 17 x 8	5200	1.8 m 3-wire 1.5 mm², Schuko plug	L/N/PE, 230-240 V ~ 50 Hz
BRELG1800RD-3	4260409695429	1800	Silver/Black	IP65	90 x 17 x 8	5200	1.8 m 3-wire 1.5 mm², Schuko plug	L/N/PE, 230-240 V ~ 50 Hz
BRELG1800RD-3W	4260409695825	1800	Silver/White	IP65	90 x 17 x 8	5200	1.8 m 3-wire 1.5 mm², Schuko plug	L/N/PE, 230-240 V ~ 50 Hz
BRELG2200RD-1	4260409695412	2200	Black/Black	IP65	90 x 17 x 8	5200	1.8 m 3-wire 1.5 mm², Schuko plug	L/N/PE, 230-240 V ~ 50 Hz
BRELG2200RD-3	4260409695405	2200	Silver/Black	IP65	90 x 17 x 8	5200	1.8 m 3-wire 1.5 mm², Schuko plug	L/N/PE, 230-240 V ~ 50 Hz
BRELG2200RD-3W	4260409695832	2200	Silver/White	IP65	90 x 17 x 8	5200	1.8 m 3-wire 1.5 mm², Schuko plug	L/N/PE, 230-240 V ~ 50 Hz
Without Dimmer/Remote								
BRELG1500-1	4260409695764	1500	Black/Black	IP65	90 x 17 x 8	5100	1.8 m 3-wire 1.5 mm², Schuko plug	L/N/PE, 230-240 V ~ 50 Hz
BRELG1500-3	4260409695382	1500	Silver/Black	IP65	90 x 17 x 8	5100	1.8 m 3-wire 1.5 mm², Schuko plug	L/N/PE, 230-240 V ~ 50 Hz
BRELG1500-3W	4260409695856	1500	Silver/White	IP65	90 x 17 x 8	5100	1.8 m 3-wire 1.5 mm², Schuko plug	L/N/PE, 230-240 V ~ 50 Hz
BRELG1800-1	4260409695771	1800	Black/Black	IP65	90 x 17 x 8	5100	1.8 m 3-wire 1.5 mm², Schuko plug	L/N/PE, 230-240 V ~ 50 Hz
BRELG1800-3	4260409695375	1800	Silver/Black	IP65	90 x 17 x 8	5100	1.8 m 3-wire 1.5 mm², Schuko plug	L/N/PE, 230-240 V ~ 50 Hz
BRELG1800-3W	4260409695863	1800	Silver/White	IP65	90 x 17 x 8	5100	1.8 m 3-wire 1.5 mm², Schuko plug	L/N/PE, 230-240 V ~ 50 Hz
BRELG2200-1	4260409695788	2200	Black/Black	IP65	90 x 17 x 8	5100	1.8 m 3-wire 1.5 mm², Schuko plug	L/N/PE, 230-240 V ~ 50 Hz
BRELG2200-3	4260409695368	2200	Silver/Black	IP65	90 x 17 x 8	5100	1.8 m 3-wire 1.5 mm², Schuko plug	L/N/PE, 230-240 V ~ 50 Hz
BRELG2200-3W	4260409695870	2200	Silver/White	IP65	90 x 17 x 8	5100	1.8 m 3-wire 1.5 mm², Schuko plug	L/N/PE, 230-240 V ~ 50 Hz

RELAX GLASS MULTI IRA IP65 DOUBLE HEATER

Extremely light reduced with tinted ceramic-glass SCHOTT NEXTREMA®



Waterproof

CASE COLORS

Silver Black

GLASS SCREEN

White Black



CODE	EAN	POWER (in watt)	COLOR (Case/Glass)	PROTECTION CLASS	DIMENSIONS (w x h x d in cm)	WEIGHT (in g)	CABLE	CONNECTION
With Dimmer/Remote								
BRELG3000RD-1	4260409697386	3000	Black/Black	IP65	128.6 x 17 x 8	6800	1.8 m 3-wire, 1.5 mm ² , Schuko plug	L/N/PE, 230-240 V ~ 50 Hz
BRELG3000RD-3	4260409695252	3000	Silver/Black	IP65	128.6 x 17 x 8	6800	1.8 m 3-wire, 1.5 mm ² , Schuko plug	L/N/PE, 230-240 V ~ 50 Hz
BRELG3000RD-3W	4260051488226	3000	Silver/White	IP65	128.6 x 17 x 8	6800	1.8 m 3-wire, 1.5 mm ² , Schuko plug	L/N/PE, 230-240 V ~ 50 Hz
Without Dimmer/Remote								
BRELG3000-1	4260409697706	3000	Black/Black	IP65	128.6 x 17 x 8	6800	1.8 m 3-wire, 1.5 mm ² , Schuko plug	L/N/PE, 230-240 V ~ 50 Hz
BRELG3000-3	4260409696754	3000	Silver/Black	IP65	128.6 x 17 x 8	6800	1.8 m 3-wire, 1.5 mm ² , Schuko plug	L/N/PE, 230-240 V ~ 50 Hz
BRELG3000-3W	4260409696761	3000	Silver/White	IP65	128.6 x 17 x 8	6800	1.8 m 3-wire, 1.5 mm ² , Schuko plug	L/N/PE, 230-240 V ~ 50 Hz

RELAX GLASS BUILT-IN MODELS

All* RELAX GLASS models are also suitable for flush-mounted ceiling installation. Just select the appropriate frame!

L: Frame for 1500/1800 Watt models.

* except 2200 and 3000 Watt heaters

FRAME COLOUR SELECTION

Silver Black



CODE	EAN	DESCRIPTION	COLOR	MATERIAL	DIMENSIONS (w x h x d in cm)	WEIGHT (in g)
Frame						
BRELGFL-1	4260409695481	Frame for 1500/1800 watt models	Black	Cold-rolled steel	97.8 x 23.1 x 12.3	3200
BRELGFL-3	4260409695474	Frame for 1500/1800 watt models	Silver	Stainless steel	97.8 x 23.1 x 12.3	3500

RELAX GLASS MODULAR

The **RELAX GLASS series** can be extended to a multifunctional system with light (RELAX GLASS LIGHT), cooling (RELAX GLASS NOZZLES), loudspeakers (RELAX GLASS Sound) and PANELS. A 10 cm connecting element (MODULAR DISTANCE) with connecting screws (MODULAR CONNECTOR) is required to connect the modules on the switching page. The connection of smooth sides only requires the connecting element. All RELAX MODULES are also available as stand-alone products* for individual installation.

*except NOZZLES

RELAX GLASS LIGHT IP65

As a stand-alone product or modular extension

Light module with two LED spots and glass front.

CASE COLORS

Silver

Black

GLASS SCREEN

Black

2 x 5 W



CODE	EAN	POWER (in watt)	COLOR (Case/Glass)	PROTECTION CLASS	DIMENSIONS (w x h x d in cm)	WEIGHT (in g)	CABLE	CONNECTION
BRELGL-1	4260409696211	2 X 5 W	Black/Black	IP65	90 x 17 x 8	4150	1.8 m 3-wire, 1.5 mm ² , Schuko plug	L/N/PE, 230-240V-50 Hz
BRELGL-3	4260409696228	2 X 5 W	Silver/Black	IP65	90 x 17 x 8	4150	1.8 m 3-wire, 1.5 mm ² , Schuko plug	L/N/PE, 230-240V-50 Hz

RELAX GLASS SOUND IP65

As a stand-alone product or modular extension

Bluetooth speaker

CASE COLORS

Silver

Black

GLASS SCREEN

Black

100 W



90 cm



- Bluetooth Version 4.0
- Subwoofer-driver 66 Hz - 6K Hz
- BassUp-Technologie Digital Amplifier
- Freq Response (Hz) = 50Hz/60Hz
- Impedance (Ohm)/Sensitivity (dB) = AC85-265V/87DB
- Dual Channel 120W

CODE	EAN	POWER (in Watt)	COLOR (Case/Glass)	PROTECTION CLASS	DIMENSIONS (w x h x d in cm)	WEIGHT (in g)	CABLE	CONNECTION
BRELGS-3	4260409695351	100	Silver/Black	IP65	90 x 17 x 8	5900	1.8 m 3-wire, 1.0 mm ² , Schuko plug	L/N/PE, 230-240 V ~ 50 Hz
BRELGS-1	4260051488233	100	Black/Black	IP65	90 x 17 x 8	5900	1.8 m 3-wire, 1.0 mm ² , Schuko plug	L/N/PE, 230-240 V ~ 50 Hz

RELAX GLASS MODULAR NOZZLE

Extension with connector

Nozzle for evaporative cooling in connection with pump* and water supply*.

* not included in the delivery.

CASE COLORS

Silver

Black

GLASS SCREEN

Black



CODE	EAN	COLOR (Case/Glass)	DIMENSIONS (w x h x d in cm)	WEIGHT (in g)
BRELGD-1	4260409696297	Black/Black	10 x 17 x 8	620
BRELGD-3	4260409696303	Silver/Black	10 x 17 x 8	620

RELAX GLASS BLENDE

The systems can be extended at will with the RELAX GLASS PANEL.

CASE COLORS



GLASS SCREEN



90 cm

CODE	EAN	COLOR (Case/Glass)	DIMENSIONS (w x h x d in cm)	WEIGHT (in g)
BRELGBL-1	4260409696266	Black/Black	90 x 17 x 8	4000
BRELGBL-3	4260409696259	Silver/Black	90 x 17 x 8	4000
BRELGBL-3W	4260409696242	Silver/White	90 x 17 x 8	4000

RELAX GLASS MODULAR DISTANCE 10 CM

Connecting element with BRELGCP connector for extending the RELAX GLASS heater with RELAX GLASS SOUND, RELAX GLASS LIGHT, RELAX GLASS BLENDE or RELAX GLASS NOZZLE - only required for connection sides with switch.

CASE COLORS



GLASS SCREEN



BRELGCP
BRELGCPIO

CODE	EAN	COLOR (Case/Glass)	DIMENSIONS (w x h x d in cm)	WEIGHT (in g)
BRELGC-1	4260409696327	Black/Black	10 x 17 x 8	600
BRELGC-3	4260409696310	Silver/Black	10 x 17 x 8	600
RELAX GLASS MODULAR CONNECTOR				
BRELGCP	4260409696334	Silver	10.5 x 10 x 2.5	113
BRELGCPIO	4260409697768	Silver	10.5 x 10 x 2.5	200

SPARE PARTS

CODE	EAN	DESCRIPTION	COLOR	MATERIAL	DIMENSIONS (w x h x d in cm)	WEIGHT (in g)
Remote						
BRELGR	4260409695511	Remote for 1200 watt models, ON/OFF function, Timer 1 h.	Black	ABS: Acrylonitrile Butadiene Styrene	4.5 x 12.5	50
BRELGRD	4260409695504	Remote for 1500/1800/2200 watt models with Dimmer (33/66/100 %) and Timer (3 h.)	Black	ABS: Acrylonitrile Butadiene Styrene	4.5 x 12.5	50
Mounting bracket						
BRELGB-3	4260409695566	Mounting bracket	Silver	Stainless steel	16.6 x 11.6	450 g/set



RELAX DARK

INDOOR & OUTDOOR

Dark radiator with infrared long-wave for indoor and wind-protected outdoor areas

Powerful dark radiators distinguished by their both elegant and ergonomic design – completely without light. The waterproof long-wave heater series **RELAX DARK IRC IP55** supplies the circulating air evenly with heat (convection heat) and fits elegantly into any ambience with its flat, linear design in silver or black. Simple elegance and high functionality offer many possible uses. **Please note:** Due to the long-wave IR radiation, dark radiant heaters are only suitable for use in wind-free outdoor areas.



158 cm

212 cm



- 2.2 kW
- 2.4 kW
- 4.5 kW



Brackets included

RELAX DARK IRC IP55

NO LIGHT with intelligent long-wave technology

COLORS



INDOOR: For indoor use of the models BRELD2200 and BRELD2400, the external control BPIRF (wireless), BHCINSTAT+3R (wired) or BHC-FIT3R (wired) or equivalent must be used to comply with EU Regulation 2015/1188. Otherwise the device loses the CE mark.

- ✓ Infrared-long-wave IRC with 2200/2400 and 3000 watt for comforting warmth
- ✓ NO light emission
- ✓ High quality, waterproof design IP55
- ✓ Colors Black and Silver (4500 watt black only)
- ✓ Power connection 230/380-400 Volt with 16A fuse

CODE	EAN	POWER (in watt)	COLOR	PROTECTION CLASS	DIMENSIONS (w x h x d in cm)	WEIGHT (in g)	CABLE	CONNECTION
BRELD2200-3	4260409695580	2200	Silver	IP55	158 x 20.1 x 5.8	8100	1.90 m 3-wire, 1.5 mm ² , Schuko plug	220-240 V ~ 50-60 Hz
BRELD2400-1	4260409695573	2400	Black	IP55	158 x 20.1 x 5.8	8100	1.90 m 3-wire, 1.5 mm ² , Schuko plug	220-240 V ~ 50-60 Hz
BRELD4500-1	4260409696549	4500	Black	IP55	212 x 25 x 7	16000	3 m, 5-wire, 1 mm ² , bared and stripped, without sleeve	3/N/PE 380-400 V ~ 50-60 Hz



TERM2000

OUTDOOR

The waterproof **TERM2000** easily supplies all outdoor areas with instant and cosy warmth – for up to 5000 hours. Depending on the application area and requirement, the **TERM2000** is available in the protection category IP44 (splash water protection) or completely waterproof in the IP67 version. The powerful heaters are available both as single or double heaters as well as triple power heaters and offer a range from 1000 up to 8000 watts – depending on the configuration. The **TERM2000** series also fulfils every desire in terms of colour choice: ranging from popular standard colours in white, black or anthracite to your favourite colour.

For large outdoor areas, all the advantages of the **TERM2000** series are also available as a standing device **TERM TOWER PALMS**.

Ideal for the hotel and food service industry, **TERM TOWER PALMS** offers optimal heating performance in large areas where lacking mounting options have prevented the use of other systems so far.

*other colors are available at an additional cost



TERM TOWER
PALMS IP67



TERM2000
IP44

TERM2000
IP67



- 1 kW
- 1.5 kW
- 1.65 kW
- 2 kW



Mounting bracket included
 Aluminum-Color-Heater: T-Bracket
 Aluminum-Heater: L-Bracket

OUTDOOR INFRARED HEATER

TERM2000 IP67



All colors available!

45 cm - 61 cm

CODE	EAN	POWER (in watt)	COLOR	PROTECTION CLASS	DIMENSIONS (w x h x d in cm)	WEIGHT (in g)	CABLE	CONNECTION
RCA100	4260051480503	1000	Polished aluminum	IP67	45 x 9.5 x 12.5	2000	1.9 m 3-wire 1.5 mm ² , Schuko plug	1/N/PE ~ 230 V 50 Hz
RCA165	4260051480237	1650	Polished aluminum	IP67	61 x 9.5 x 12.5	2300	1.9 m 3-wire 1.5 mm ² , Schuko plug	1/N/PE ~ 230 V 50 Hz
RCA200V	4260051480275	2000	Polished aluminum	IP67	61 x 9.5 x 12.5	2300	1.9 m 3-wire 1.5 mm ² , Schuko plug	1/N/PE ~ 230 V 50 Hz
URCA100V	4260051485577	1000	Polished aluminum	IP67	45 x 9.5 x 12.5	2000	1.9 m 3-wire 1.5 mm ² , Schuko plug	1/N/PE ~ 230 V 50 Hz
URCA150V	4260051485386	1500	Polished aluminum	IP67	61 x 9.5 x 12.5	2300	1.9 m 3-wire 1.5 mm ² , Schuko plug	1/N/PE ~ 230 V 50 Hz
URCA165V	4260051483863	1650	Polished aluminum	IP67	61 x 9.5 x 12.5	2300	1.9 m 3-wire 1.5 mm ² , Schuko plug	1/N/PE ~ 230 V 50 Hz
URCA200V	4260051484150	2000	Polished aluminum	IP67	61 x 9.5 x 12.5	2300	1.9 m 3-wire 1.5 mm ² , Schuko plug	1/N/PE ~ 230 V 50 Hz
URCAC150V9010	4260051485607	1500	White	IP67	61 x 9.5 x 12.5	2000	1.9 m 3-wire 1.5 mm ² , Schuko plug	1/N/PE ~ 230 V 50 Hz
URCAC165V9010	4260051485614	1650	White	IP67	61 x 9.5 x 12.5	2000	1.9 m 3-wire 1.5 mm ² , Schuko plug	1/N/PE ~ 230 V 50 Hz
URCAC200V9010	4260051485621	2000	White	IP67	61 x 9.5 x 12.5	2000	1.9 m 3-wire 1.5 mm ² , Schuko plug	1/N/PE ~ 230 V 50 Hz
URCAC150V9005	4260051486222	1500	Black	IP67	61 x 9.5 x 12.5	2000	1.9 m 3-wire 1.5 mm ² , Schuko plug	1/N/PE ~ 230 V 50 Hz
URCAC165V9005	4260051486239	1650	Black	IP67	61 x 9.5 x 12.5	2000	1.9 m 3-wire 1.5 mm ² , Schuko plug	1/N/PE ~ 230 V 50 Hz
URCAC200V9005	4260051486246	2000	Black	IP67	61 x 9.5 x 12.5	2000	1.9 m 3-wire 1.5 mm ² , Schuko plug	1/N/PE ~ 230 V 50 Hz
URCAC150V7016	4260051488240	1500	Anthracite	IP67	61 x 9.5 x 12.5	2000	1.9 m 3-wire 1.5 mm ² , Schuko plug	1/N/PE ~ 230 V 50 Hz
URCAC165V7016	4260051488257	1650	Anthracite	IP67	61 x 9.5 x 12.5	2000	1.9 m 3-wire 1.5 mm ² , Schuko plug	1/N/PE ~ 230 V 50 Hz
URCAC200V7016	4260051486581	2000	Anthracite	IP67	61 x 9.5 x 12.5	2000	1.9 m 3-wire 1.5 mm ² , Schuko plug	1/N/PE ~ 230 V 50 Hz



60 cm

- 3.3 kW
- 4 kW
- 4.95 kW
- 6 kW



TERM2000 MULTI IP67



123.5 cm

CODE	EAN	POWER (in watt)	COLOR	PROTECTION CLASS	DIMENSIONS (w x h x d in cm)	WEIGHT (in g)	CABLE	CONNECTION
URCJ330V	4260051483870	2 x 1650	Polished aluminum	IP67	123.5 x 9.5 x 12.5	4900	0.65 m 5-wire 1.5 mm ² , Wire-end sleeves	2/N/PE ~ 230 (2N) V 50 Hz
URCJ400V	4260051483887	2 x 2000	Polished aluminum	IP67	123.5 x 9.5 x 12.5	4900	0.65 m 5-wire 1.5 mm ² , Wire-end sleeves	2/N/PE ~ 400 (2N) V 50 Hz
URCC495V	4260051483894	3 x 1650	Polished aluminum	IP67	60 x 29 x 12.5	6800	0.65 m 5-wire 2.5 mm ² , Wire-end sleeves	3/N/PE ~ 400 (3N) V 50 Hz
URCC600V	4260051483900	3 x 2000	Polished aluminum	IP67	60 x 29 x 12.5	6800	0.65 m 5-wire 2.5 mm ² , Wire-end sleeves	3/N/PE ~ 400 (3N) V 50 Hz

Available with table and ashtray

250-270 cm



3 kW

4 kW

6 kW

8 kW



TERM TOWER PALMS IP67



CODE	EAN	POWER (in watt)	COLOR	PROTECTION CLASS	DIMENSIONS (w x h x d in cm)	WEIGHT (in kg)	CABLE	CONNECTION
URTT300V	4260051488561	2 x 1500	Polished aluminum	IP67	110 x 250-270	ca. 45	10 m 5-wire 2.5 mm ² , Wire-end sleeves	3/N/PE ~ 400 (3N) V 50 Hz
URTT400V	4260051483917	2 x 2000	Polished aluminum	IP67	110 x 250-270	ca. 49	10 m 5-wire 2.5 mm ² , Wire-end sleeves	3/N/PE ~ 400 (3N) V 50 Hz
URTT600V	4260051483924	3 x 2000	Polished aluminum	IP67	110 x 250-270	ca. 51	10 m 5-wire 2.5 mm ² , Wire-end sleeves	3/N/PE ~ 400 (3N) V 50 Hz
URTT800V	4260051483931	4 x 2000	Polished aluminum	IP67	110 x 250-270	ca. 53	10 m 5-wire 2.5 mm ² , Wire-end sleeves	3/N/PE ~ 400 (3N) V 50 Hz
URTTTC300V9005	4260051488578	2 x 1500	Black	IP67	110 x 250-270	ca. 49	10 m 5-wire 2.5 mm ² , Wire-end sleeves	3/N/PE ~ 400 (3N) V 50 Hz
URTTTC400V9005	4260051487779	2 x 2000	Black	IP67	110 x 250-270	ca. 49	10 m 5-wire 2.5 mm ² , Wire-end sleeves	3/N/PE ~ 400 (3N) V 50 Hz
URTTTC600V9005	4260051487786	3 x 2000	Black	IP67	110 x 250-270	ca. 51	10 m 5-wire 2.5 mm ² , Wire-end sleeves	3/N/PE ~ 400 (3N) V 50 Hz
URTTTC800V9005	4260051487793	4 x 2000	Black	IP67	110 x 250-270	ca. 53	10 m 5-wire 2.5 mm ² , Wire-end sleeves	3/N/PE ~ 400 (3N) V 50 Hz
URTTTC300V9010	4260051488585	2 x 1500	White	IP67	110 x 250-270	ca. 49	10 m 5-wire 2.5 mm ² , Wire-end sleeves	3/N/PE ~ 400 (3N) V 50 Hz
URTTTC400V9010	4260051488196	2 x 2000	White	IP67	110 x 250-270	ca. 49	10 m 5-wire 2.5 mm ² , Wire-end sleeves	3/N/PE ~ 400 (3N) V 50 Hz
URTTTC600V9010	4260051488202	3 x 2000	White	IP67	110 x 250-270	ca. 51	10 m 5-wire 2.5 mm ² , Wire-end sleeves	3/N/PE ~ 400 (3N) V 50 Hz
URTTTC800V9010	4260051488219	4 x 2000	White	IP67	110 x 250-270	ca. 53	10 m 5-wire 2.5 mm ² , Wire-end sleeves	3/N/PE ~ 400 (3N) V 50 Hz
RTTT	4260051480589	Table	Black Werzalit		59 x 2.3 x 59	4.16	-	-
RTTA	4260051480596	Ashtray	Polished aluminum		6 x 12.5 x 6	1	-	-



42.5 cm

2 kW



TERM2000 CVH IP20

Infrared lacquer or building dryer – Multifunctional, portable dryer for material heating and drying

CODE	EAN	POWER (in watt)	COLOR	PROTECTION CLASS	DIMENSIONS (w x h x d in cm)	WEIGHT (in g)	CABLE	CONNECTION
RCAC020VH-1	4260051482293	2000	Black	IP20	42.5 x 15 x 21	1500	1.9 m 3-wire 1.5 mm ² , Schuko plug	1/N/PE ~ 230 V 50 Hz
RCAC020VH-4	4260051482309	2000	Red	IP20	42.5 x 15 x 21	1500	1.9 m 3-wire 1.5 mm ² , Schuko plug	1/N/PE ~ 230 V 50 Hz
RCAC-E protective grid	4260409692329	-	Silver	-	-	-	-	-



TERM2000 IP44

ULTRA LOW GLARE

Mounting bracket included (L-Bracket)



OUTDOOR INFRARED HEATER

CODE	EAN	POWER (in watt)	COLOR	PROTECTION CLASS	DIMENSIONS (w x h x d in cm)	WEIGHT (in g)	CABLE	CONNECTION
URCA01044V	4260051488653	1000	Polished aluminum	IP44	50.3 x 10 x 12.5	2300	1.9 m 3-wire 1.5 mm ² , Schuko plug	1/N/PE ~ 230 V 50 Hz
URCA01544V	4260051488509	1500	Polished aluminum	IP44	50.3 x 10 x 12.5	2300	1.9 m 3-wire 1.5 mm ² , Schuko plug	1/N/PE ~ 230 V 50 Hz



TERM2000 COLOR SHORT IP44

ULTRA LOW GLARE

Mounting bracket included (T-Bracket)



CODE	EAN	POWER (in watt)	COLOR	PROTECTION CLASS	DIMENSIONS (w x h x d in cm)	WEIGHT (in g)	CABLE	CONNECTION
URCACS01044V9010	4260051488592	1000	White	IP44	46.4 x 9.5 x 12.5	2100	1.9 m 3-wire 1.5 mm ² , Schuko plug	1/N/PE ~ 230 V 50 Hz
URCACS01544V9010	4260051488370	1500	White	IP44	46.4 x 9.5 x 12.5	2100	1.9 m 3-wire 1.5 mm ² , Schuko plug	1/N/PE ~ 230 V 50 Hz
URCACS01044V9005	4260051488608	1000	Black	IP44	46.4 x 9.5 x 12.5	2100	1.9 m 3-wire 1.5 mm ² , Schuko plug	1/N/PE ~ 230 V 50 Hz
URCACS01544V9005	4260051488394	1500	Black	IP44	46.4 x 9.5 x 12.5	2100	1.9 m 3-wire 1.5 mm ² , Schuko plug	1/N/PE ~ 230 V 50 Hz
URCACS01044V7016	4260051488615	1000	Anthracite	IP44	46.4 x 9.5 x 12.5	2100	1.9 m 3-wire 1.5 mm ² , Schuko plug	1/N/PE ~ 230 V 50 Hz
URCACS01544V7016	4260051488424	1500	Anthracite	IP44	46.4 x 9.5 x 12.5	2100	1.9 m 3-wire 1.5 mm ² , Schuko plug	1/N/PE ~ 230 V 50 Hz



TERM2000 LIGHT & HEAT

OUTDOOR

Wherever the “right” brightness counts, our patented combined heating/lighting appliances are the first choice. In terms of technology and design, they are based on the established TERM2000 series combined with 2 or 4 LED spots (240V/3.5W). The appliances are waterproof in accordance with IP65. Heating tubes and light can be controlled and dimmed analogously or separately. Especially modulated dimmers are available as accessories, see page 24/35.



4.0 kW + 14 W (LEDs)

200 cm



TERM2000 L&H XL IP65 LED



Waterproof



Mounting bracket included
aluminum colored heater: **T-Bracket**
aluminum polished heater: **L-Bracket**

CODE	EAN	POWER (in watt)	COLOR	PROTECTION CLASS	DIMENSIONS (w x h x d in cm)	WEIGHT (in g)	CABLE	CONNECTION
URLH4265	4260051484075	2 x 2000 + 14	Polished aluminum	IP65	200 x 9.5 x 12.5	7100	1.9 m 5-wire 2.5 mm ² , Wire-end sleeves	3/N/PE ~ 400 V 50 Hz
URLHC42657016	4260409692602	2 x 2000 + 14	Anthracite	IP65	200 x 9.5 x 12.5	7100	1.9 m 5-wire 2.5 mm ² , Wire-end sleeves	3/N/PE ~ 400 V 50 Hz
URLHC42659010	4260409691575	2 x 2000 + 14	White	IP65	200 x 9.5 x 12.5	7100	1.9 m 5-wire 2.5 mm ² , Wire-end sleeves	3/N/PE ~ 400 V 50 Hz
URLHC42659005	4260409691582	2 x 2000 + 14	Black	IP65	200 x 9.5 x 12.5	7100	1.9 m 5-wire 2.5 mm ² , Wire-end sleeves	3/N/PE ~ 400 V 50 Hz

1.65 kW + 7 W (LEDs)

2.0 kW + 7 W (LEDs)



OUTDOOR INFRARED HEATER

TERM2000 L&H FIX IP65 LED



78 cm



CODE	EAN	POWER (in watt)	COLOR	PROTECTION CLASS	DIMENSIONS (w x h x d in cm)	WEIGHT (in g)	CABLE	CONNECTION
URLH1765F	4260051484044	1650 + 7	Polished aluminum	IP65	78 x 9.5 x 12.5	3350	1.9 m 5-wire 1.5 mm ² , Wire-end sleeves	2/N/PE ~ 230 V 50 Hz
URLH2165F	4260051484051	2000 + 7	Polished aluminum	IP65	78 x 9.5 x 12.5	3350	1.9 m 5-wire 1.5 mm ² , Wire-end sleeves	2/N/PE ~ 230 V 50 Hz

1.65 kW + 7 W (LEDs)

2.0 kW + 7 W (LEDs)

180°

82.5 cm



TERM2000 L&H IP65 LED



CODE	EAN	POWER (in watt)	COLOR	PROTECTION CLASS	DIMENSIONS (w x h x d in cm)	WEIGHT (in g)	CABLE	CONNECTION
URLH1765	4260051484020	1650 + 7	Polished aluminum	IP65	82.5 x 9.5 x 12.5	3350	1.9 m 5-wire 1.5 mm ² , Wire-end sleeves	2/N/PE ~ 230 V 50 Hz
URLH2165	4260051484037	2000 + 7	Polished aluminum	IP65	82.5 x 9.5 x 12.5	3350	1.9 m 5-wire 1.5 mm ² , Wire-end sleeves	2/N/PE ~ 230 V 50 Hz



PATENTED



MODULARSYSTEM

OUTDOOR

YOU HAVE THE CHOICE – COMPLETELY INDIVIDUAL OR STANDARD SETS

We adjust and combine according to your needs, wishes and design – easy and completely individual! Our unique and patented modular concept with heating, LED lights and cooling systems, offer individual combinations for every project: Together with awnings, conservatories, patio roofs, i. e. also for stadiums, exhibition halls, or just stand-alone on your balcony. Combine single modules or standard sets to every desired color and length – 10, 20, 30, 50 or 100 m, no problem! Choose from our standard colors pure white (9010), Black (9005) and anthracite (7016) or with a supplementary charge for an individual color of your choice. Mounting brackets are included. Whether single modules or standard modular sets, order now!

- ✓ MODULAR ✓ INDIVIDUAL ✓ EVERY LENGTH
- ✓ EVERY COLOR ✓ WATERPROOF IP65/67 ✓ LEDS WITH 3.5 W

Standard Colors:



2 kW + 14 W



T-BRACKET INCLUDED



All colors available!

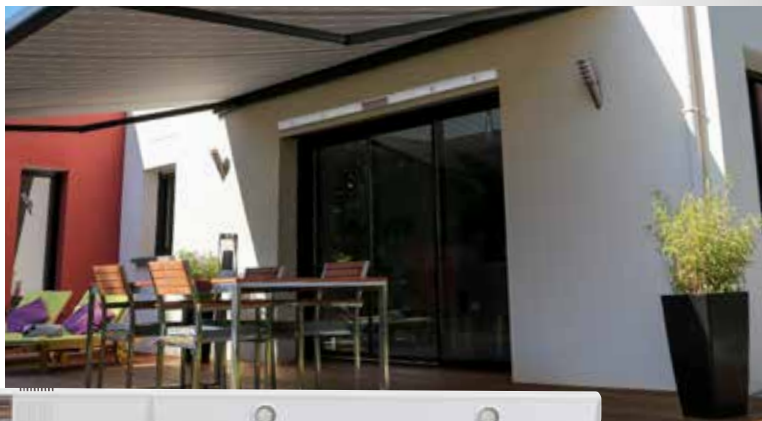

300 cm

MSET 3.1 = M1 + M2 + M1

2 x LED + 1 x Heater



Waterproof

IP65

MODULAR

CODE	EAN	POWER (in watt)	COLOR	PROTECTION CLASS	DIMENSIONS (w x h x d in cm)	WEIGHT (in g)	CABLE	CONNECTION
MSET3.1 9010	4260409691636	2000 + 14	White	IP65	300 x 9.5 x 12.5	7100	1 m 5-wire 1.5 mm ² Wieland plug	3/N/PE ~ 400 (3N) V 50 Hz
MSET3.1 9005	4260409692831	2000 + 14	Black	IP65	300 x 9.5 x 12.5	7100	1 m 5-wire 1.5 mm ² Wieland plug	3/N/PE ~ 400 (3N) V 50 Hz
MSET3.1 7016	4260409691643	2000 + 14	Anthracite	IP65	300 x 9.5 x 12.5	7100	1 m 5-wire 1.5 mm ² Wieland plug	3/N/PE ~ 400 (3N) V 50 Hz



4 kW + 7 W



T-BRACKET INCLUDED



All colors available!

300 cm

MSET 3.2 = M2 + M1 + M2

1 x LED + 2 x Heater



Waterproof

CODE	EAN	POWER (in watt)	COLOR	PROTECTION CLASS	DIMENSIONS (w x h x d in cm)	WEIGHT (in g)	CABLE	CONNECTION
MSET3.2 9010	4260409691858	4000 + 7	White	IP65	300 x 9.5 x 12.5	7000	1 m 5-wire 1.5 mm ² Wieland plug	3/N/PE ~ 400 (3N) V 50 Hz
MSET3.2 9005	4260409692848	4000 + 7	Black	IP65	300 x 9.5 x 12.5	7000	1 m 5-wire 1.5 mm ² Wieland plug	3/N/PE ~ 400 (3N) V 50 Hz
MSET3.2 7016	4260409691872	4000 + 7	Anthracite	IP65	300 x 9.5 x 12.5	7000	1 m 5-wire 1.5 mm ² Wieland plug	3/N/PE ~ 400 (3N) V 50 Hz

6 kW

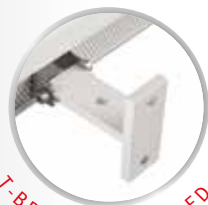

T-BRACKET INCLUDED



All colors available!



300 cm

MSET 3.3 = M2 + M2 + M2

3 x Heater

IP67



ULTRA LOW GLARE



Waterproof

CODE	EAN	POWER (in watt)	COLOR	PROTECTION CLASS	DIMENSIONS (w x h x d in cm)	WEIGHT (in g)	CABLE	CONNECTION
MSET3.3 9010	4260409692657	6000	White	IP67	300 x 9.5 x 12.5	6900	1 m 5-wire 1.5 mm ² Wieland plug	3/N/PE ~ 400 (3N) V 50 Hz
MSET3.3 9005	4260409692664	6000	Black	IP67	300 x 9.5 x 12.5	6900	1 m 5-wire 1.5 mm ² Wieland plug	3/N/PE ~ 400 (3N) V 50 Hz
MSET3.3 7016	4260409692688	6000	Anthracite	IP67	300 x 9.5 x 12.5	6900	1 m 5-wire 1.5 mm ² Wieland plug	3/N/PE ~ 400 (3N) V 50 Hz

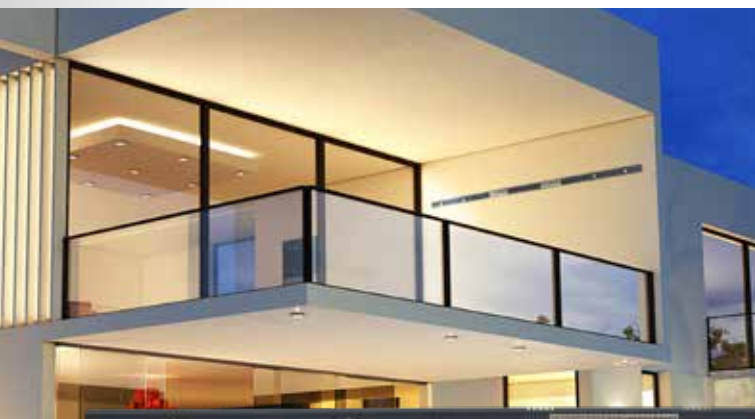

4 kW + 14 W



T-BRACKET INCLUDED



All colors available!

400 cm

MSET 4.1 = M1 + M2 + M2 + M1

2 x LED + 2 x Heater



ULTRA LOW GLARE



LIGHT



Waterproof

CODE	EAN	POWER (in watt)	COLOR	PROTECTION CLASS	DIMENSIONS (w x h x d in cm)	WEIGHT (in g)	CABLE	CONNECTION
MSET4.1 9010	4260409692695	4000 + 14	White	IP65	400 x 9.5 x 12.5	9400	1 m 5-wire 1.5 mm ² Wieland plug	3/N/PE ~ 400 (3N) V 50 Hz
MSET4.1 9005	4260409692701	4000 + 14	Black	IP65	400 x 9.5 x 12.5	9400	1 m 5-wire 1.5 mm ² Wieland plug	3/N/PE ~ 400 (3N) V 50 Hz
MSET4.1 7016	4260409692725	4000 + 14	Anthracite	IP65	400 x 9.5 x 12.5	9400	1 m 5-wire 1.5 mm ² Wieland plug	3/N/PE ~ 400 (3N) V 50 Hz



4 kW + 14 W



400 cm

MSET 4.2 = M2 + M1 + M1 + M2

2 x LED + 2 x Heater



IP65

MODULAR

CODE	EAN	POWER (in watt)	COLOR	PROTECTION CLASS	DIMENSIONS (w x h x d in cm)	WEIGHT (in g)	CABLE	CONNECTION
MSET4.2 9010	4260409692732	4000 + 14	White	IP65	400 x 9.5 x 12.5	9400	1 m 5-wire 1.5 mm ² Wieland plug	3/N/PE ~ 400 (3N) V 50 Hz
MSET4.2 9005	4260409692749	4000 + 14	Black	IP65	400 x 9.5 x 12.5	9400	1 m 5-wire 1.5 mm ² Wieland plug	3/N/PE ~ 400 (3N) V 50 Hz
MSET4.2 7016	4260409692763	4000 + 14	Anthracite	IP65	400 x 9.5 x 12.5	9400	1 m 5-wire 1.5 mm ² Wieland plug	3/N/PE ~ 400 (3N) V 50 Hz



4 kW + 21 W



500 cm

MSET 5.1 = M1 + M2 + M1 + M2 + M1

3 x LED + 2 x Heater



CODE	EAN	POWER (in watt)	COLOR	PROTECTION CLASS	DIMENSIONS (w x h x d in cm)	WEIGHT (in g)	CABLE	CONNECTION
MSET5.1 9010	4260409692770	4000 + 21	White	IP65	500 x 9.5 x 12.5	11800	1 m 5-wire 1.5 mm ² Wieland plug	3/N/PE ~ 400 (3N) V 50 Hz
MSET5.1 9005	4260409692787	4000 + 21	Black	IP65	500 x 9.5 x 12.5	11800	1 m 5-wire 1.5 mm ² Wieland plug	3/N/PE ~ 400 (3N) V 50 Hz
MSET5.1 7016	4260409692800	4000 + 21	Anthracite	IP65	500 x 9.5 x 12.5	11800	1 m 5-wire 1.5 mm ² Wieland plug	3/N/PE ~ 400 (3N) V 50 Hz

INDIVIDUAL MODULES AND EQUIPMENT

M 1 LED MODUL

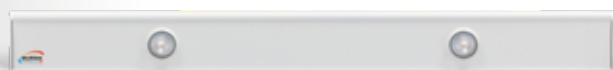

100 cm – 2 x 3.5 W LED

M 2 HEATER MODUL



100 cm – 1 x 2000 W Heater

M 3 HEATER & LED MODUL



100 cm – 2 x 3.5 W LED + 1 x 2000 W Heater

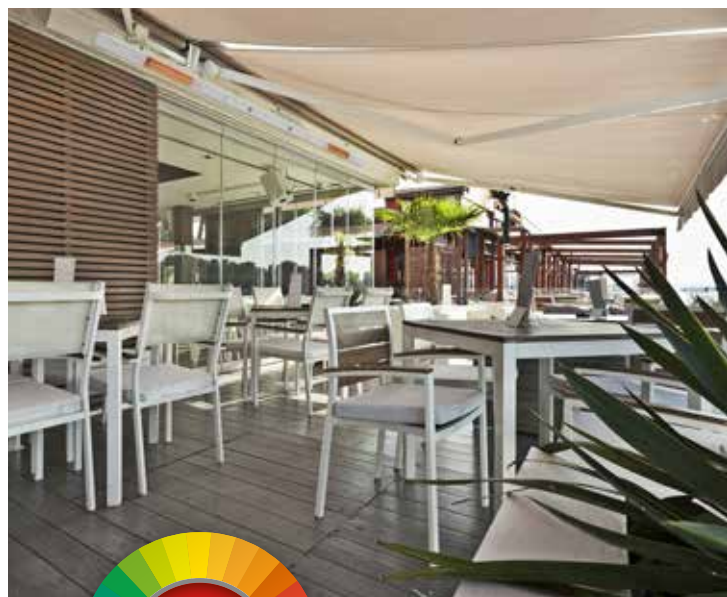

CODE	EAN	POWER/ DESCRIPTION	COLOR	PROTECTION CLASS	DIMENSIONS (w x h x d in cm)	WEIGHT (in g)	CABLE	CONNECTION
M1 LED MODUL								
MRL2C9010	4260409691605	2 x 3.5	White	IP65	100 x 9.5 x 12.5	2000	1.9 m 3-wire 1.5 mm ² , Schuko plug	1/N/PE ~ 230 V 50 Hz
MRL2C9005	4260409693098	2 x 3.5	Black	IP65	100 x 9.5 x 12.5	2000	1.9 m 3-wire 1.5 mm ² , Schuko plug	1/N/PE ~ 230 V 50 Hz
MRL2C7016	4260409691629	2 x 3.5	Anthracite	IP65	100 x 9.5 x 12.5	2000	1.9 m 3-wire 1.5 mm ² , Schuko plug	1/N/PE ~ 230 V 50 Hz
M2 HEATER MODUL								
MURCAC200V9010	4260409691520	2000	White	IP67	100 x 9.5 x 12.5	2300	1.9 m 3-wire 1.5 mm ² , Schuko plug	1/N/PE ~ 230 V 50 Hz
MURCAC200V9005	4260409693104	2000	Black	IP67	100 x 9.5 x 12.5	2300	1.9 m 3-wire 1.5 mm ² , Schuko plug	1/N/PE ~ 230 V 50 Hz
MURCAC200V7016	4260409691513	2000	Anthracite	IP67	100 x 9.5 x 12.5	2300	1.9 m 3-wire 1.5 mm ² , Schuko plug	1/N/PE ~ 230 V 50 Hz
M3 HEATER & LED MODUL								
MURLHC21659010	4260409691551	2000 + 7	White	IP65	100 x 9.5 x 12.5	2400	1 m 5-wire 1.5 mm ² , Wire-end sleeves	1/N/PE ~ 230 V 50 Hz
MURLHC21659005	4260409691544	2000 + 7	Black	IP65	100 x 9.5 x 12.5	2400	1 m 5-wire 1.5 mm ² , Wire-end sleeves	1/N/PE ~ 230 V 50 Hz
MURLHC21657016	4260409691568	2000 + 7	Anthracite	IP65	100 x 9.5 x 12.5	2400	1 m 5-wire 1.5 mm ² , Wire-end sleeves	1/N/PE ~ 230 V 50 Hz

MODULAR PANEL

The MODULAR SYSTEM can be extended at will with the MODULAR PANEL, or space out your heating, cooling and lighting modules.

Standard Colors:



CODE	EAN	DESCRIPTION	COLOR	DIMENSIONS (w x h x d in cm)	WEIGHT (in g)
M50BL9010	4260409693203	BLENDE 50 cm	White	50 x 9.5 x 12.5	80
M50BL9005	4260409693210	BLENDE 50 cm	Black	50 x 9.5 x 12.5	80
M50BL7016	4260409693227	BLENDE 50 cm	Anthracite	50 x 9.5 x 12.5	80
M75BL9010	4260409693234	BLENDE 75 cm	White	75 x 9.5 x 12.5	120
M75BL9005	4260409693241	BLENDE 75 cm	Black	75 x 9.5 x 12.5	120
M75BL7016	4260409693258	BLENDE 75 cm	Anthracite	75 x 9.5 x 12.5	120
M100BL9010	4260409693265	BLENDE 100 cm	White	100 x 9.5 x 12.5	160
M100BL9005	4260409693272	BLENDE 100 cm	Black	100 x 9.5 x 12.5	160
M100BL7016	4260409693289	BLENDE 100 cm	Anthracite	100 x 9.5 x 12.5	160

MODULAR

MODULAR SIDEPART SET

With the modular sidepart sets you can easily connect every single Modules of Heat, Light, Nozzles, Panels or even TERM Color heaters within only seconds.

Standard Colors:



CODE	EAN	DESCRIPTION	COLOR	DIMENSIONS (w x h x d in cm)	WEIGHT (in g)
MSPS9010	4260409692213	SIDEPART-SET	White	9.5 x 8 x 1	140
MSPS9005	4260409692220	SIDEPART-SET	Black	9.5 x 8 x 1	140
MSPS7016	4260409692237	SIDEPART-SET	Anthracite	9.5 x 8 x 1	140

MODULAR NOZZLES

Our special cooling nozzles can be integrated at any desired place in the system. The cooling takes places with the tried and tested PerfectClime® technology with high-pressure pump and water feed line, page 30.

Standard Colors:



CODE	EAN	DESCRIPTION	COLOR	DIMENSIONS (w x h x d in cm)	WEIGHT (in g)
MD19010	4260409692091	MD1 Nozzles	White	4.5 x 10 x 8	194
MD19005	4260409693111	MD1 Nozzles	Black	4.5 x 10 x 8	194
MD17016	4260409692107	MD1 Nozzles	Anthracite	4.5 x 10 x 8	194



SMART

OUTDOOR

Compact infrared heater with splash water protection and dimmed LOW GLARE technology

The compact infrared heaters of the SMART series, which are equipped with large reflectors, cut a fine figure wherever quick heating is required. The smart heaters are protected against splash water and can be installed onto walls in outdoor areas, under ceilings, as built-in ceiling models or set up as a **SMART TOWER** standing heater. The SMART series is exclusively manufactured with **LOW GLARE** heating tubes, which significantly minimise the infrared light.



- 1.5 kW
- 2 kW
- 3 kW
- 4 kW
- 6 kW



SMART IP24 & SMART MULTI IP24



CODE	EAN	POWER (in watt)	COLOR	PROTECTION CLASS	DIMENSIONS (w x h x d in cm)	WEIGHT (in g)	CABLE	CONNECTION
BHS1524	4260051489568	1500	White	IP24	48 x 14.5 x 9.5	2500	1.9 m 3-wire 1.5 mm ² , Schuko plug	1/N/PE ~ 230 V 50 Hz
BHS1524-3	4260051489551	1500	Silver	IP24	48 x 14.5 x 9.5	2500	1.9 m 3-wire 1.5 mm ² , Schuko plug	1/N/PE ~ 230 V 50 Hz
BHS2024	4260051489575	2000	White	IP24	48 x 14.5 x 9.5	2500	1.9 m 3-wire 1.5 mm ² , Schuko plug	1/N/PE ~ 230 V 50 Hz
BHS2024-3	4260051489582	2000	Silver	IP24	48 x 14.5 x 9.5	2500	1.9 m 3-wire 1.5 mm ² , Schuko plug	1/N/PE ~ 230 V 50 Hz
BHS2024-1	4260051480053	2000	Black	IP24	48 x 14.5 x 9.5	2500	1.9 m 3-wire 1.5 mm ² , Schuko plug	1/N/PE ~ 230 V 50 Hz
BHS3024	4260051487243	2 x 1500	White	IP24	89.5 x 14.5 x 9.5	4000	1.9 m 3-wire 1.5 mm ² , Schuko plug	1/N/PE ~ 230 V/50 Hz
BHS4024	4260051487267	2 x 2000	White	IP24	89.5 x 14.5 x 9.5	4000	0.65 m 5-adri 2.5 mm ² , Wire-end sleeves	2/N/PE ~ 230 V 50 Hz
BHS6024	4260051487281	3 x 2000	White	IP24	129 x 14.5 x 9.5	6000	0.65 m 5-wire 2.5 mm ² , Wire-end sleeves	3/N/PE ~ 400 (3N) V 50 Hz
BHSS1524	4260409694934	1500	White	IP24	48 x 14.5 x 9.5	2500	1.9 m 3-wire 1.5 mm ² , Schuko plug	1/N/PE ~ 230 V 50 Hz
BHSS1524-1	4260409694941	1500	Black	IP24	48 x 14.5 x 9.5	2500	1.9 m 3-wire 1.5 mm ² , Schuko plug	1/N/PE ~ 230 V 50 Hz
BHSS1524-3	4260409694958	1500	Silver	IP24	48 x 14.5 x 9.5	2500	1.9 m 3-wire 1.5 mm ² , Schuko plug	1/N/PE ~ 230 V 50 Hz
BHSS2024	4260409694965	2000	White	IP24	48 x 14.5 x 9.5	2500	1.9 m 3-wire 1.5 mm ² , Schuko plug	1/N/PE ~ 230 V 50 Hz
BHSS2024-1	4260409694972	2000	Black	IP24	48 x 14.5 x 9.5	2500	1.9 m 3-wire 1.5 mm ² , Schuko plug	1/N/PE ~ 230 V 50 Hz
BHSS2024-3	4260409694989	2000	Silver	IP24	48 x 14.5 x 9.5	2500	1.9 m 3-wire 1.5 mm ² , Schuko plug	1/N/PE ~ 230 V 50 Hz

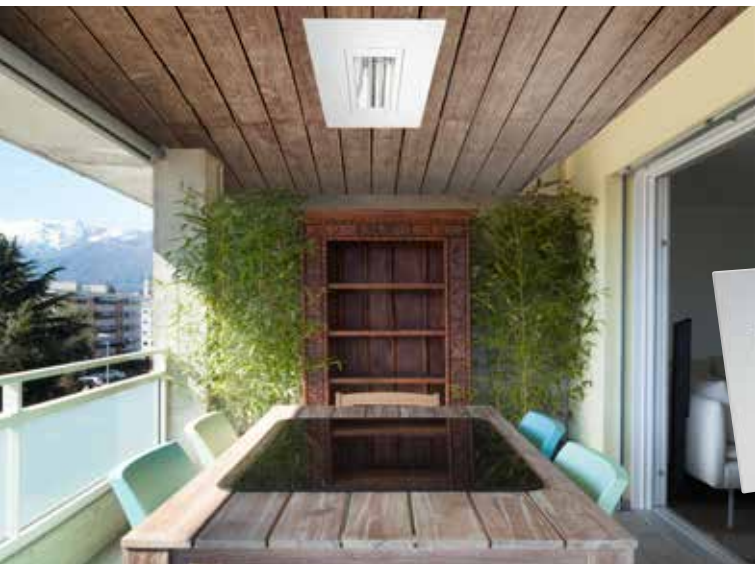

1.5 kW
2 kW



OUTDOOR INFRARED HEATER

SMART FRAME IP24 BUILT-IN HEATERS

LOW GLARE

CODE	EAN	POWER (in watt)	COLOR	PROTECTION CLASS	DIMENSIONS (w x h x d in cm)	WEIGHT (in g)	CABLE	CONNECTION
BHSF1524-2	4260409694842	1500	White	IP24	60 x 32.5 x 10	3400	1.9 m 3-wire 1.5 mm ² , Schuko plug	1/N/PE ~ 230 V 50 Hz
BHSF1524-3	4260409694859	1500	Silver	IP24	60 x 32.5 x 10	3400	1.9 m 3-wire 1.5 mm ² , Schuko plug	1/N/PE ~ 230 V 50 Hz
BHSF2024-2	4260409694835	2000	White	IP24	60 x 32.5 x 10	3400	1.9 m 3-wire 1.5 mm ² , Schuko plug	1/N/PE ~ 230 V 50 Hz
BHSF2024-3	4260409694866	2000	Silver	IP24	60 x 32.5 x 10	3400	1.9 m 3-wire 1.5 mm ² , Schuko plug	1/N/PE ~ 230 V 50 Hz



126 cm

3 kW



SMART TOWER IP24

LOW GLARE

Fits with:
SMART TOWER COVER
see page 33

CODE	EAN	POWER (in watt)	COLOR	PROTECTION CLASS	DIMENSIONS (w x h x d in cm)	WEIGHT (in g)	CABLE	CONNECTION
BHST3024-1	4260051484686	2 x 1500	Black	IP24	29 x 126 x 32	7300	1.9 m 3-wire 1.5 mm ² , Schuko plug	1/N/PE ~ 230 V 50 Hz
BHST3024	4260051484693	2 x 1500	White	IP24	29 x 126 x 32	7300	1.9 m 3-wire 1.5 mm ² , Schuko plug	1/N/PE ~ 230 V 50 Hz
BHST3024-3	4260051484709	2 x 1500	Silver	IP24	29 x 126 x 32	7300	1.9 m 3-wire 1.5 mm ² , Schuko plug	1/N/PE ~ 230 V 50 Hz
BHST3024-4	4260051484716	2 x 1500	Red	IP24	29 x 126 x 32	7300	1.9 m 3-wire 1.5 mm ² , Schuko plug	1/N/PE ~ 230 V 50 Hz

The first **Heating** & **Cooling** Sensation!

PATENTED



PERFECTCLIME®

OUTDOOR

The first heating & cooling concept combines infrared short-wave technology in one unit. Instant comfortable heat or refreshing cool air – resulting in a perfect temperature anytime and anywhere. Based on the successful TERM2000 IP67 and SMART IP24, instant heating is guaranteed and due to the integrated nozzle a fine haze leads to a comfortable atmosphere for nearly unlimited professional and private usage. PERFECTCLIME® only at Burda!

Perfectclime® COOLING

Customized atomization and cooling system made of stainless steel in modular design or as ready **BASIC COOLING SET** for the perfect humidity and cool temperatures on hot days. See page 32.



1.65 kW
2 kW



With two nozzles



Mounting bracket included
Aluminum-Color-Heater: **T-Bracket**
Aluminum-Heater: **L-Bracket**

PERFECTCLIME® TERM2000 IP67

PERFECTCLIME®



CODE	EAN	POWER (in watt)	COLOR	PROTECTION CLASS	DIMENSIONS (w x h x d in cm)	WEIGHT (in g)	CABLE	CONNECTION
UPCRCA165V2	4260051484426	1650	Polished aluminum	IP67	70 x 9.5 x 12.5	2900	1.9 m 3-wire 1.5 mm ² , Schuko plug	1/N/PE ~ 230 V 50 Hz
UPCRCA200V2	4260051484488	2000	Polished aluminum	IP67	70 x 9.5 x 12.5	2900	1.9 m 3-wire 1.5 mm ² , Schuko plug	1/N/PE ~ 230 V 50 Hz
UPCRCAC165V29010	4260409691674	1650	White	IP67	70 x 9.5 x 12.5	2900	1.9 m 3-wire 1.5 mm ² , Schuko plug	1/N/PE ~ 230 V 50 Hz
UPCRCAC200V29010	4260409691681	2000	White	IP67	70 x 9.5 x 12.5	2900	1.9 m 3-wire 1.5 mm ² , Schuko plug	1/N/PE ~ 230 V 50 Hz
UPCRCAC165V29005	4260409691698	1650	Black	IP67	70 x 9.5 x 12.5	2900	1.9 m 3-wire 1.5 mm ² , Schuko plug	1/N/PE ~ 230 V 50 Hz
UPCRCAC200V29005	4260409691704	2000	Black	IP67	70 x 9.5 x 12.5	2900	1.9 m 3-wire 1.5 mm ² , Schuko plug	1/N/PE ~ 230 V 50 Hz
UPCRCAC165V27016	4260409691711	1650	Anthracite	IP67	70 x 9.5 x 12.5	2900	1.9 m 3-wire 1.5 mm ² , Schuko plug	1/N/PE ~ 230 V 50 Hz
UPCRCAC200V27016	4260409691728	2000	Anthracite	IP67	70 x 9.5 x 12.5	2900	1.9 m 3-wire 1.5 mm ² , Schuko plug	1/N/PE ~ 230 V 50 Hz



1.65 kW + 7 W
2 kW + 7 W
4 kW + 14 W



With two nozzles



PERFECTCLIME® TERM2000 L&H IP65

PERFECTCLIME®



CODE	EAN	POWER (in watt)	COLOR	PROTECTION CLASS	DIMENSIONS (w x h x d in cm)	WEIGHT (in g)	CABLE	CONNECTION
UPCRLH1765F2	4260051484563	1650 + 7	Polished aluminum	IP65	87 x 9.5 x 12.5	4050	2 m 5-wire 1.5 mm ² , Wire-end sleeves	2/N/PE ~ 230 V/50 Hz
UPCRLH2165F2	4260051484594	2000 + 7	Polished aluminum	IP65	87 x 9.5 x 12.5	4050	2 m 5-wire 1.5 mm ² , Wire-end sleeves	2/N/PE ~ 230 V/50 Hz
UPCRLH17652	4260051484556	1650 + 7	Polished aluminum	IP65	91 x 9.5 x 12.5	4050	2 m 5-wire 1.5 mm ² , Wire-end sleeves	2/N/PE ~ 230 V/50 Hz
UPCRLH21652	4260051484570	2000 + 7	Polished aluminum	IP65	91 x 9.5 x 12.5	4050	2 m 5-wire 1.5 mm ² , Wire-end sleeves	2/N/PE ~ 230 V/50 Hz
UPCRLH42652	4260051484624	2 x 2000 + 14	Polished aluminum	IP65	200 x 9.5 x 12.5	7700	2 m 5-wire 2.5 mm ² , Wire-end sleeves	3/N/PE ~ 400 V 50 Hz

PERFECTCLIME®

PERFECTCLIME® PUMP



CODE	EAN	DESCRIPTION	PROTECTION CLASS	PRESSURE	CONSUMPTION
PCE05	4260051482347	Pumpe 05	IP21	70 Bar	0.5 l/m

PERFECTCLIME® COUPLINGS

PICTURE	CODE	EAN	DESCRIPTION
	PCKT	4260051483245	T-Coupling
	PCKL	4260051483252	L-Coupling
	PCKS	4260051483856	Straight Coupling
	PCKE	4260051483269	End Coupling
	PCKG	4260051483276	Angle Coupling
	PCIT.0330	4260409695948	Connection coupling, nickel-plated brass, 1/4" NPT M - ø6.35mm - 1/4"

PERFECTCLIME® POLYAMIDE PIPELINE

PICTURE	CODE	EAN	DESCRIPTION
	PCPS25	4260051483290	Polyamide hose 25 cm
	PCPG7	4260051483313	Polyamide hose 75 cm
	PCPC	4260051483320	Polyamide cutter
	PCPB	4260051483337	Hose clamp for polyamide hose, ø6,35 mm
	PCSS75	4260409695313	Stainless steel pipeline, 75 cm, ø6.35 mm

PERFECTCLIME® NOZZLES

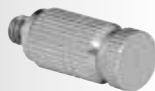

CODE	EAN	DESCRIPTION	56 BAR VERSION	70 BAR VERSION	84 BAR VERSION
PCN15	4260051483207	Nozzle 0.15 mm	0.041 l/min 0.011 US Gpm	0.046 l/min 0.0095 US Gpm	0.051 l/min 0.012 US Gpm
PCN2	4260409697904	Nozzle 0.20 mm	0.080 l/min 0.021 US Gpm	0.089 l/min 0.024 US Gpm	0.098 l/min 0.026 US Gpm
PCN30	4260051483221	Nozzle 0.30 mm	0.130 l/min 0.034 US Gpm	0.145 l/min 0.038 US Gpm	0.159 l/min 0.042 US Gpm
PCN40	4260051483238	Nozzle 0.40 mm	0.159 l/min 0.047 US Gpm	0.178 l/min 0.047 US Gpm	0.195 l/min 0.052 US Gpm

PERFECTCLIME® FILTER



CODE	EAN	DESCRIPTION
PCFKUEU	4260051483344	Particle and scale filter set
PCFS	4260051483351	Particle filter
PCFSM	4260409695955	Particle filter Mini
PCFUV4	4260051482880	UV filter 480 l/h 6 bar
PCFUV5	4260051482897	UV filter 500l/h 7-10 bar

PERFECTCLIME® COOLING KIT

Customized atomization and cooling system made of stainless steel in modular design for perfect humidity, cool temperatures in the desired cooling radius. **So simple and so effective!** The atomized water from the row of premium, stainless steel nozzles lowers the ambient temperature by up to 12°C and evaporates when it falls to the ground, without moistening objects or people in the process. The PERFECTCLIME® COOLING KIT contains premium accessories and is very easy and quick to install without the need for any special tools, making it a great option.



PICTURE	CODE	EAN	DESCRIPTION
	PCSS75	4260409695313	Stainless steel Pipeline, 75 cm, ø6.35 mm
	PCPS25	4260051483290	Polyamid Pipeline, 25 m, Black
	PCPS25-2	4260409695245	Polyamid Pipeline, 25 m, White
	PCN30	4260051483221	Nozzle 0.3 mm
	PCN2	4260409697904	Nozzle 0.2 mm
	PCN15	4260051483207	Nozzle 0.15 mm
	PCKDE	4260409695337	Nozzle Coupling, End
	PCKDM	4260409695344	Nozzle Coupling, Straight
	PCIT.0330	4260409695948	Connection coupling, nickel-plated brass, 1/4" NPT M - ø6.35 mm - 1/4"
	PCKS	4260051483856	Straight Coupling 6.35 mm
	PCKE	4260051483269	End Coupling 6.35 mm
	PCKT	4260051483245	T-Coupling 6.35 mm
	PCKL	4260051483252	L-Coupling 6.35 mm
	PCPB	4260051483337	Polyamid pipe mounting, ø6.35 mm
	PCPC	4260051483320	Polyamid cutter
ADD ON MISTING			
	PCE05	4260051482347	Pump 0.5
	PCFS	4260051483351	Particle filter
ADD ON MISTING OPTIONAL			
	PCFKUEU	4260051483344	Filter clause chalk
	PCFUV4	4260051482880	UV filter, 480 l/hr
	PCFUV5	4260051482897	UV filter, 500 l/hr

PERFECTCLIME®

PERFECTCLIME® COOLING BASIC SET

PC COOLING set in three meters total length, straight, including four nozzles. Easy installation without special tools.



CODE	EAN	DESCRIPTION
PCBASIC300	4260409697881	PERFECTCLIME® COOLING BASIC SET

BASIC SET INCLUDES: ✓ 4 x PCSS75 stainless steel pipe, ø6.35 mm ✓ 5 x PCN2 Nozzle ✓ 4 x PCKDM nozzle coupling, straight ✓ 1 x PCKDE end coupling ✓ 1 x PCKL L-Coupling 6.35 mm, connection from pipeline to pump ✓ 8 x PCPB polyamid pipe mounting ø6.35 mm ✓ 1 x PCPC Polyamid cutter ✓ 1 x PCE05 Pump 0.5 l ✓ 1x PCFS particle filter ✓ 1 x PCFSV ✓ 1 x PCPS25 polyamid hose, black, ø6.35 mm ✓ 1 x PCIT.0330 connection coupling, nickel-plated brass, 1/4" NPT M - ø6.35 mm - 1/4"

HEATER ADD ONS

Accessories and spare parts to control and install BURDA infrared heaters in order to upgrade, retrofit or expand existing systems.



FIXATIONS

All BURDA infrared heaters are equipped with a wall attachment (T- or L- bracket) in their standard configuration. However, we offer numerous alternatives such as attachments for ceiling installation, below shutters, with Velcro for installation on rods or polls for example for sun screens, or free-standing on a tripod.



CONTROL

Dimmers, timers and motion sensors do not only guarantee that our infrared heaters operate resource-efficiently but also contribute to decreased energy costs. Here you will find a large selection of control options for BURDA infrared heaters, from cable (fixed connection), to radio or Bluetooth. Enjoy the comfort of controlling your heater via a remote.

STATIVE & STANDFUSS



Tripod BHSS for TERM2000 and SMART



BRELGB pole and base stainless steel, for RELAX GLASS heaters



BRELGB pole and base stainless steel with TWIN brackets for RELAX GLASS COMPACT

CODE	EAN	DESCRIPTION	COLOR	DIMENSIONS (w x h x d in cm)	WEIGHT (in g)
BHSS-1	4260051481357	STATIV	Black	bis 210	2600
BHSS-2	4260051487144	STATIV	White	bis 210	2600
BHSS-3	4260051487151	STATIV	Silver	bis 210	2600
BRELGB-3	4260409696556	STATIV	Stainless steel, Silber	Base: Ø 500 mm Pole: Ø 38 mm Total height: 210 cm	18000
TWIN Brackets for RELAX GLASS COMPACT Stand mounting double heaters					
BRELGB-TWIN	4260409697850	STATIV	Stainless steel, Silber	-	1000

FIXATIONS

CODE	EAN	COLOR	DIMENSIONS (w x h x d in cm)	WEIGHT (in g)
T-BRACKET (standard for all TERM2000 colour heaters)				
BCTF9010	4260409692961	White	8	50
BCTF9005	4260409692978	Black	8	50
BCTF7016	4260409692985	Anthracite	8	50
L-BRACKET (standard for all aluminium heaters)				
BCLF	4260409693494	Silver	13	50
CEILING ATTACHMENT for TERM2000-Series				
BCDF20	4260409691452	Silver	20	95
BCDF209010	4260409691469	White	20	95
BCDF209005	4260409691476	Black	20	95
BCDF207016	4260409691483	Anthracite	20	95
AWNING BRACKETS for TERM2000-Series				
MB40409010	4260409692176	White	4 x 4 (B x T)	50
MB40409005	4260409692534	Black	4 x 4 (B x T)	50
MB40407016	4260409692619	Anthracite	4 x 4 (B x T)	50
MB40402009010	4260409693432	White	4 x 4 x 20 (B x H x T)	55
MB40402009005	4260409693425	Black	4 x 4 x 20 (B x H x T)	55
MB40402007016	4260409693418	Anthracite	4 x 4 x 20 (B x H x T)	55
VELCRO ATTACHMENT				
KLS1KS	4260051489186	Silver	9 x 3 x 0.2	40
TentFIT TENT FIXATION for TERM2000 and RELAX GLASS Heater				
BZFIT75	4260409693494	Silver	75	440
BZFIT100	4260409697546	Silver	75	520
BZFIT150	4260409697553	Silver	75	700
SMART TOWER PROTECTION COVER				
BHSTC	4260409697805	Black (100% polyester)	17 x 17 x 127	265gr/m ²



ADD ON

BLUETOOTH DIMMER IP65

Weather-proof BLUETOOTH DIMMER IP65 for App control of heaters with a total power of 3000 to 4000 Watt (depending on model).

Slow blow fuse 16 amp (C16) recommended



BTD3

3 kW
1 Channel



Waterproof



BTR

CODE	EAN	POWER (in watt)	COLOR	PROTECTION CLASS	DIMENSIONS (w x h x d in cm)	WEIGHT (in g)	CABLE	CONNECTION
BLUETOOTH DIMMER IP65								
BTD3	4260409691094	3000, 1 Zone	Aluminum	IP65	11.8 x 8.8 x 4.8	900	2 x 1.9 m 3-wire 1.5 mm ² , Schuko plug and socket	1/N/PE ~ 230 V 50 Hz
BLUETOOTH REMOTE								
BTR	4260409692510	-	White	IP20	11.8 x 4 x 1.5	60	-	-

RADIO DIMMER + REMOTE



BRFE20

2 kW
1 Channel



SOLO Bi-Directional



MONO/VARIO Bi-Directional

CODE	EAN	DESCRIPTION	POWER (in watt)	PROTECTION CLASS	DIMENSIONS (w x h x d in cm)	WEIGHT (in g)	CABLE	CONNECTION
RADIO DIMMER								
BRFE20	4260051489261	Radio dimmer 50/66/100%	2000	IP54	14.5 x 4.8 x 2.9	360	Power feed 490 mm (STAS 3), Line to the heater 235 mm (STAK 3)	1/N/PE ~ 230 V 50 Hz
BRHS	4260051489094	Hirschmann Set STAS 3 + STAK 3 + Stasi	-	IP54	14.5 x 2.8 x 2.3	8	-	250 V/16 A

CODE	EAN	DESCRIPTION	COLOR	PROTECTION CLASS	DIMENSIONS (w x h x d in cm)	WEIGHT (in g)
REMOTE RADIO DIMMER						
BRD-S1	4260051489209	BiDirectional Solo 1 channel	Black	IP20	7.4 x 4.4 x 1.5	120
BRD-S2	4260051489216	BiDirectional Solo 1 channel	White	IP20	7.4 x 4.4 x 1.5	120
BRD-S3	4260051489223	BiDirectional Solo 1 channel	Silver	IP20	7.4 x 4.4 x 1.5	120
BRD-BM3	4260051483801	BiDirectional Mono 1 channel	Silver	IP20	5.1 x 12 x 2.6	120
BRD-BM2	4260051483818	BiDirectional Mono 1 channel	White	IP20	5.1 x 12 x 2.6	120
BRD-BM5	4260051484204	BiDirectional Mono 1 channel	Anthracite	IP20	5.1 x 12 x 2.6	120
BRD-BV2	4260051483825	BiDirectional Vario 5 channel	White	IP20	5.1 x 12 x 2.6	120
BRD-BV3	4260051483832	BiDirectional Vario 5 channel	Silver	IP20	5.1 x 12 x 2.6	120
BRD-BV5	4260051484211	BiDirectional Vario 5 channel	Anthracite	IP20	5.1 x 12 x 2.6	120

DIMMER FIXED CONNECTION (CABLE)



BHC 4001/BHC 6001

4 kW
6 kW
1 Channel

Waterproof



BHC 4002/BHC 6003
9 Channels bus system

4 kW
2 Channel

6 kW
3 Channel

Waterproof

CODE	EAN	DESCRIPTION	POWER (in watt)	PROTECTION CLASS	DIMENSIONS (w x h x d in cm)	WEIGHT (in g)	CONNECTION
BH CONTROLLER 1 ZONE IP65 FIXED CONNECTION							
BHC4001	4260051480169	Dimmer, 10-stage	4000, 1 Channel	IP65	28 x 17 x 8.7	2150	1/N/PE ~ 230 V 50 Hz
BHC6001	4260051481562	Dimmer, 10-stage	6000, 1 Channel	IP65	28 x 17 x 8.7	2150	1/N/PE ~ 230 V 50 Hz
BHCR1	4260051480176	Remote 1	Dimmer, 10-stage	IP20	4.5 x 26 x 2	80	-
BH CONTROLLER 9 ZONE IP65 FIXED CONNECTION							
BHC4002-ER	4260051482835	Dimmer, 10-stage	4000, 2 Channels	IP65	28 x 17 x 8.7	2150	1/N/PE ~ 230 V 50 Hz
BHC6003-ER	4260051482842	Dimmer, 10-stage	6000, 3 Channels	IP65	28 x 17 x 8.7	2150	3/N/PE ~ 400 V 50 Hz
BHC4002D	4260051483443	Dimmer, 10-stage	4000, 2 Channels	IP65	28 x 17 x 8.7	2150	1/N/PE ~ 230 V 50 Hz
BHC6003D	4260051483450	Dimmer, 10-stage	6000, 3 Channels	IP65	28 x 17 x 8.7	2150	3/N/PE ~ 400 V 50 Hz
BHCK	4260051483559	Keypad	-	IP65	12 x 9 x 4	220	-
BHCR9	4260051483306	Remote 9	-	IP20	4.5 x 26 x 2	80	-

ADD ON

TIMER



2 kW
1 Channel

Timer TS2



4 kW
1 Channel

Timer TS4

Waterproof



6 kW
1 Channel

Timer TS6

Waterproof

CODE	EAN	DESCRIPTION	POWER (in watt)	PROTECTION CLASS	DIMENSIONS (w x h x d in cm)	WEIGHT (in g)	CABLE	CONNECTION
TS2-C	4260051480107	Timer 5-60 Seconds	2000	IP20	9.5 x 13 x 5.5	475	1.5 m 3-wire 1.5 mm ² PVC; with Schuko plug 0.5 m 3-wire 1.5 mm ² PVC, with socket	1/N/PE ~ 230 V 50 Hz
TS4	4260051480077	Timer 1-40 Minutes	4000	IP65	10 x 12.5 x 7	475	Fixed connection	1/N/PE ~ 230 V 50 Hz
TS6	4260409691254	Timer 1-30 Minutes	6000	IP65	13 x 13 x 7	475	Fixed connection	1/N/PE ~ 230 V 50 Hz

MOTION DETECTORS/TEMPERATURE SENSORS



BPIR4

4 kW

Waterproof



BPIR6

6 kW

Waterproof



BPIR4T

4 kW

Waterproof

CODE	EAN	POWER (in watt)	COLOR	PROTECTION CLASS	DIMENSIONS (w x h x d in cm)	WEIGHT (in g)	CABLE	CONNECTION
BPIR4	4260051485959	4000	White	IP65	10 x 11.2 x 5.5	280	Fixed connection	1/N/PE ~ 230 V 50 Hz
BPIR6	4260051485966	6000	White	IP65	13 x 13 x 7.5	600	Fixed connection	1/N/PE ~ 230 V 50 Hz
BPIR4T	4260409696730	4000	White	IP65	10 x 11.2 x 5.5	280	Fixed connection	1/N/PE ~ 230-240 V 50 Hz

SPARE TUBES

Spare tubes for TERM2000-, RELAX- and SMART-infrared heaters

CODE	EAN	DESCRIPTION	POWER (in watt)	PROTECTION CLASS	DIMENSIONS (Length in cm)	WEIGHT (in g)	CABLE	CONNECTION
LAMPS TERM2000 IP20/IP24/IP44								
LG1000	4260051486017	Cable 357.5 mm	1000	IP20	35.75	50	295 mm double-sided, Wire-end sleeves	230 V 50 Hz
LG1000V	4260051486048	Cable 357.5 mm	1000	IP20	35.75	50	295 mm double-sided, Wire-end sleeves	230 V 50 Hz
LG1500	4260051486024	Cable 357.5 mm	1500	IP20	35.75	50	295 mm double-sided, Wire-end sleeves	230 V 50 Hz
LG1500V	4260051486000	Cable 357.5 mm	1500	IP20	35.75	50	295 mm double-sided, Wire-end sleeves	230 V 50 Hz
LG2000	4260051486031	Cable 357.5 mm	2000	IP20	35.75	50	295 mm double-sided, Wire-end sleeves	230 V 50 Hz
LG2000V	4260051486055	Cable 357.5 mm	2000	IP20	35.75	50	295 mm double-sided, Wire-end sleeves	230 V 50 Hz
LG1024	4260051486123	Cable 355 mm	1000	IP24	35.5	50	235 mm and 590 mm, Wire-end sleeves	230 V 50 Hz
LG1524	4260051486130	Cable 355 mm	1500	IP24	35.5	50	295 mm double-sided, Wire-end sleeves	230 V 50 Hz
LG2024	4260051486147	Cable 355 mm	2000	IP24	35.5	50	235 mm and 590 mm, Wire-end sleeves	230 V 50 Hz
ULGS1024V	4260051485454	Cable 355 mm	1000	IP24	35.5	50	235 mm and 590 mm, Wire-end sleeves	230 V 50 Hz
ULGS1524V	4260051484129	Cable 355 mm	1500	IP24	35.5	50	235 mm and 590 mm, Wire-end sleeves	230 V 50 Hz
ULGS2024V	4260051484136	Cable 355 mm	2000	IP24	35.5	50	235 mm and 590 mm, Wire-end sleeves	230 V 50 Hz
LAMPS TERM2000 IP65/IP67								
LG1001	4260051486185	Cable 380 mm	1000	IP65/67	38	50	300 mm and 920 mm, Wire-end sleeves	230 V 50 Hz
LGS1700V	4260051485973	Cable 380 mm	1700	IP65/67	38	50	300 mm and 920 mm, Wire-end sleeves	230 V 50 Hz
LG1650	4260051486093	Cable 529 mm	1650	IP65/67	52.9	50	300 mm and 920 mm, Wire-end sleeves	230 V 50 Hz
LG2001V	4260051486109	Cable 529 mm	2000	IP65/67	52.9	50	300 mm and 920 mm, Wire-end sleeves	230 V 50 Hz
ULG1001V	4260051485508	Cable 380 mm	1000	IP65/67	38	50	300 mm and 920 mm, Wire-end sleeves	230 V 50 Hz
ULG1500V	4260051485430	Cable 529 mm	1500	IP65/67	52.9	50	300 mm and 920 mm, Wire-end sleeves	230 V 50 Hz
ULG1650V	4260051484105	Cable 529 mm	1650	IP65/67	52.9	50	300 mm and 920 mm, Wire-end sleeves	230 V 50 Hz
ULG2001V	4260051484112	Cable 529 mm	2000	IP65/67	52.9	50	300 mm and 920 mm, Wire-end sleeves	230 V 50 Hz
LAMPS NO GLARE IP20								
NLG650	4260409691018	White	0.65	IP20	Ø6.3	0.8	110 mm, Wire-end sleeves	230 V 50 Hz
NLG650-1	4260409691391	Black	0.65	IP20	Ø6.3	0.8	110 mm, Wire-end sleeves	230 V 50 Hz
LAMPS BH SMART SK15 IP20/IP24								
LGHS1500V	4260051484877	Cable 350 mm	1500	IP20	-	50	300 mm double-sided, Wire-end sleeves	230 V 50 Hz
LGHS2000	4260051488103	Cable 350 mm	2000	IP20	-	50	300 mm double-sided, Wire-end sleeves	230 V 50 Hz
LGHS1524V	4260051480770	Cable 350 mm	1500	IP24	-	50	590 mm and 240 mm, Wire-end sleeves	230 V 50 Hz
LGHS2024	4260051489605	Cable 350 mm	2000	IP24	-	50	590 mm and 240 mm, Wire-end sleeves	230 V 50 Hz
LAMPS RELAX GLASS IRA/IRB IP65								
BRELGR1200	4260409695559	RELAX GLASS Tube	1200	IP65	42.5	50 g/pc	A: 21 cm x 1.5 mm B: 78 cm x 1.5 mm	230-240 V ~ 50 Hz
BRELGR1200C	4260409696747	RELAX GLASS Tube	1200	IP65	66.5	70 g/pc	A: 21 cm x 1.5 mm B: 78 cm x 1.5 mm	230-240 V ~ 50 Hz
BRELGR1500	4260409695542	RELAX GLASS Tube	1500	IP65	66.5	70 g/pc	18 cm x 1.5 mm double-sided	230-240 V ~ 50 Hz
BRELGR1800	4260409695535	RELAX GLASS Tube	1800	IP65	66.5	70 g/pc	18 cm x 1.5 mm double-sided	230-240 V ~ 50 Hz
BRELGR2200	4260409695528	RELAX GLASS Tube	2200	IP65	66.5	70 g/pc	18 cm x 1.5 mm double-sided	230-240 V ~ 50 Hz



Panel heaters from Burda –

COSY WARMTH

like from a tiled stove

HEATPANELS

INDOOR

BURDA heatpanels function like the sun: They emit infrared beams which create warmth and work as heat accumulators when they hit people and objects. The energy-consuming „detour“ of convection heating of air in conventional rooms is no longer required. This makes Burda heatpanels economical and your heating experience refreshingly relaxing. Enjoy Burda heatpanels like the sun's rays on a clear winter's day!

APPLICATIONS

Bathroom, waiting rooms, medical practice, hotels, office and home

EU Ecodesign 2015/1188

The installation and use of the heatpanels from 1.1.2018 is only permitted in connection with external thermostats which fulfill the following functions:

- Electronic room temperature control and weekday control
- Adaptive heating control

These requirements are met i. e. with our thermostats: BHC1868, BHCINSTAT+3R, BHCFIT3R

Failure to comply with these requirements will result in the loss of the CE mark



BASIC HEAT IP54

FRAMELESS WALL HEATER

The wall heater BASIC HEAT is our cost-effective universal solution. The 500 watt heating plate in white is certified with protection class IP54 (splash water proof) and thus also suitable for use in damp areas. A toggle switch on the device allows convenient on/off switching. Please note: the heating panel is not suitable for ceiling mounting!

- ✓ ON-/OFF switch
- ✓ Painted smooth white
- ✓ Frameless
- ✓ 1.5 cm deep
- ✓ Heat dissipation at almost 100 % on the front
- ✓ Comes with wall-mounting kit
- ✓ Includes 1.9 m cable and plug
- ✓ Protection Class IP54, waterproof
- ✓ 5-year guarantee

CODE	EAN	SURFACE	DIMENSIONS (w x h x d in cm)	POWER (in watt)	PROTECTION CLASS	WEIGHT (in kg)	CONNECTION
BHPBH50100500	4260409694712	White smooth	50 x 100 x 1.5	500	IP54	10	1/N/PE ~ 230 V 50 Hz



CLASSIC HEAT IP20

FRAMELESS WALL AND CEILING HEATER

Our standard model with optimal heating performance. Robust aluminum/steel housing 1.6 cm thick. The CLASSIC HEAT guarantees particularly high heat dissipation through its specially coated surface. The heat panel is scratch resistant and non-yellowing. Suitable for wall and ceiling mounting.

Base (BHPFC) for all CLASSIC HEAT models optional, except BHPCLH4060300.

- ✓ White RAL9016, smooth
- ✓ Frameless
- ✓ 1.6 cm deep
- ✓ Heat dissipation at almost 100 % on the front
- ✓ Safety shut-down in case of overheating
- ✓ Comes with wall- or ceiling mounting kit
- ✓ Includes 1.9 m cable and plug
- ✓ Protection Class IP20
- ✓ 5-year guarantee

CODE	EAN	SURFACE	DIMENSIONS (w x h x d in cm)	POWER (in watt)	PROTECTION CLASS	WEIGHT (in kg)	CONNECTION
BHPCLH4060300	4260409694514	White smooth	40 x 60 x 1.4	300	IP20	4	1/N/PE ~ 230 V 50 Hz
BHPCLH6262400	4260409694347	White smooth	62 x 62 x 1.6	400	IP20	4	1/N/PE ~ 230 V 50 Hz
BHPCLH6060400	4260409694354	White smooth	60 x 60 x 1.6	400	IP20	4	1/N/PE ~ 230 V 50 Hz
BHPCLH6090600	4260409694361	White smooth	60 x 90 x 1.6	600	IP20	8	1/N/PE ~ 230 V 50 Hz
BHPCLH60120900	4260409694378	White smooth	60 x 120 x 1.6	900	IP20	9	1/N/PE ~ 230 V 50 Hz
BHPCLSF	4260409695979	White smooth	28.15 x 28.8	-	-	0.565	-

RADIO



BHCI868*

Radio controlled thermostat INSTAT-868 – **230 V/16 A**

INSTAT-868, the radio-controlled thermostat by Eberle, serves as a temperature and time dependent switch of electrical devices such as fan heaters, circulation pumps, radiators, etc. in conjunction with an INSTAT switching unit. Operation is very simple. Among others, daily and weekly programmes can be set. Battery powered.

CODE

EAN

BHCI868

4260409690646



BHCI868A1A

Receiver/switching unit INSTAT868-a1A – **230V/16 A**

Single channel radio controlled receiver as an additional receiver for INSTAT radio controlled thermostats. This device is the ideal surface-mounted solution and switches up to 16 A.

CODE

EAN

BHCI868a1A

4260409690660



BHCI868UP

Receiver/switching unit INSTAT-868-UP – **230 V**

Additional receiver for INSTAT radio-controlled thermostats. This device is the ideal flush-mounted solution.

CODE

EAN

BHCI868UP

4260409690677



BHCI868R1F

RF window contact INSTAT 868-r1F

Detects open windows in connection with flush-mounted receiver and switches the heater off for max. 30 minutes. Protection class: IP54, Dimensions: 65 x 12 x 28 mm, Power supply: Battery 3 V (CR 2030)

CODE

EAN

BHCI868r1F

4260409694750

WIRED



BHCRTTR-E 3311

Schuko socket thermostat – **230 V**

Room temperature regulator, surface-mounted, pure white unit. IP30, adjustable from 5 °C – 30 °C, 1.8 m cable and adapter, thermal feedback.

CODE

EAN

BHCRTTR-E 3311

4260409690684



BHCITCTI

Socket thermostat with thermo-timer – **230 V/16 A**

Temperature and time dependent switching of electrical devices such as fan heaters, circulation pumps, radiators, etc. You can set daily and weekly schedules. Battery powered. 2-year guarantee.

CODE

EAN

BHCITCTI

4260409691001



BHCINSTAT+3R*

Radio-controlled thermostat – **230 V**

INSTAT-868, the radio-controlled thermostat by Eberle, serves as a temperature and time dependent switch of electrical devices such as fan heaters, circulation pumps, radiators, etc. in conjunction with an INSTAT switching unit. Operation is very simple. Among others, daily and weekly programmes can be set. Battery powered.

CODE

EAN

BHCINSTAT+3R

4260409690998



BHCFIT3R*

Digital socket thermostat – **230 V/16 A**

Pure white colour, flush-mounted. Temperature settings between 5°C – 30°C in increments of 0.5°C. Large display with backlighting at the touch of a button, user-friendly operation, pre-set and adjustable lifestyle programmes, wide range of custom programme settings, automatic switchover to summer/winter settings, protection against unauthorised access, holiday settings by date, frost control, energy consumption indicator.

CODE

EAN

BHCFIT3R

4260409690981

* External control of indoor longwave heaters to comply with EU Regulation 2015/1188.

More Sales Through Sales Promotion



We will gladly advise
you on start-up and
language variants
+49 6173/324 24 0

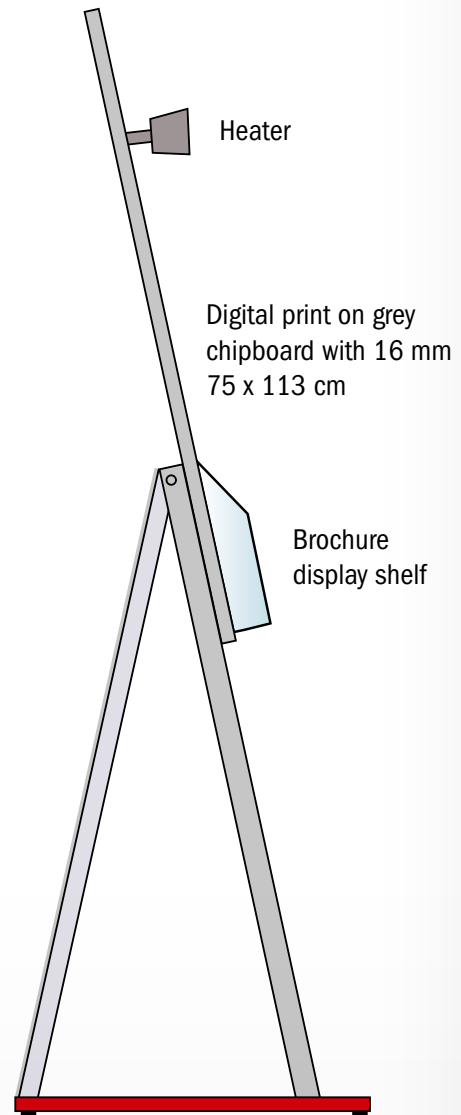

**YOU WILL BE INSPIRED BY
THE INNOVATIVE INFRARED
HEATER FROM BURDA.**

Convince your clients with intelligent comfortable heat at the push of a button. With this new professional display, guide the attention of your clients to our innovative heaters. The huge and instant heat output is most effective during this live demonstration.

A push-button timer and a display shelf for complimentary brochures is included.

Good to know

WHAT IS INFRARED?

Infrared radiation is a segment of the light spectrum created by the sun. This type of light is no longer visible to the human eye, but only acts as heat radiation. The following applies in general: the shorter the wavelength, the lighter the penetration of the air and the more intensive the heat effect in the body.

HOW DOES INFRARED RADIATION WORK?

Due to the various wavelengths and the resulting modes of action a distinction is made between three types of infrared radiation:

Infrared-A: short-wave IR-A

780 - 1.400 nm (0,8 - 1,4 μ) 3620 K - 2070 K

Short-wave infrared produces heat through heating up the body, which is hit by the radiation, without warming up the surrounding air in the process. In summary: instant heat without heat loss:

Series: TERM2000 IRA, SMART, RELAX GLASS IRA

Infrared-B: medium-wave IR-B

1.400 - 3.000 nm (1,4 - 3 μ) 2070 K - 965 K

Medium-wave infrared produces a heat radiation, which is also emitted to the surrounding air, to a small extent, and thus does not only increase the perceived temperature but also the room temperature. There is a short lead time.

Infrared-C: long-wave

3.000 - 10.000 nm (3 - 10 μ) 965 K - 290 K

Long-wave infrared is the most similar to convection heat in principle. The radiation does not penetrate the body as deeply and leads to an increase in the surrounding temperature. Lead time maximum 20 minutes.

Series: RELAX DARK, HEATPANELS

INFRARED LIGHT INTENSITY

Burda PerfectClime was the first producer of heaters with reduced infrared light using specially coated heating tubes, which, depending on the series, significantly minimise or even reduce the infrared light intensity up to 80 percent:



EXTREME LOW GLARE - up to 95% light reduction in the surrounding space. Series: RELAX GLASS



ULTRA LOW GLARE - up to 80% less red light. Series: TERM2000



LOW GLARE - strongly reduced red light. Series: SMART



NO GLARE - completely dimmed dark heater. Series: RELAX DARK



HOW TO CALCULATE THE REQUIRED RADIANT HEATER POWER!

In order to find out what power an infrared heater must have in order to supply the outdoor area with sufficient heat, various factors play a role:

- Is the terrace/balcony open or protected?
- Exposed outdoor areas require more power than protected or covered areas.
- How big is the area that needs warmth?
- Should only a certain area, for example the seating area, be in the area of thermal radiation or the entire outdoor area?
- Is the outside area exposed to the weather side?
- Wind-protected outdoor areas require less heating power than open areas.

RECOMMENDATIONS FOR CALCULATING THE HEAT OUTPUT IN WATTS (W) ACCORDING TO THE AREA IN SQM (M²):

TERM2000 and SMART IRA short-wave:

- 250 W/m² for wind-free, dry outdoor areas
- 300 W/m² for partially windy outdoor areas
- 400 W/m² for very cold, exposed outdoor areas such as sea/mountains

RELAX GLASS IRA short-wave:

- 350 W/m² for wind-free, dry outdoor areas
- 400 W/m² for partially windy outdoor areas
- 500 W/m² for very cold, exposed outdoor areas, sea/mountains

RELAX DARK IRC long-wave:

- 50-100 W/m² for home and office
- 400 W/m² for calm, dry outdoor areas

HEATPANELS IRC long-wave:

- 50-60 W/m² for home and office
- 80-100 W/m² for bathroom

PERFECTCLIME cooling nozzles:

- 1 cooling nozzle has an effective area of approx. 6 m²

Calculation examples

TERM2000 for 10sqm partly windy terrace:

300W x 10sqm = 3.000 watts. For this terrace, you need one or two radiant heaters with a total power of around 3.000 watts. For example 1 x TERM2000 MULTI or 2 x TERM2000 BLUETOOTH.

RELAX GLASS for 10sqm partly windy terrace:

400W x 10sqm = 4.000 watts. For this terrace, you need two radiant heaters BRELG2200 with 2.200 watts each.

PROTECTION CATEGORY: IP

The protection category IP first of all offers information on the particle/dust protection and second of all on the water density of the heater. The water density is especially pivotal to the use of the heater in outdoor areas.

IP20 is not water resistant.

Not suitable for outdoor areas.

Series: TERM2000 CVH

IP24 with splash water protection.

Suitable for protected outdoor areas.

Series: SMART

IP44 with splash water protection.

Suitable for protected outdoor areas.

Series: TERM2000 COLOR

IP55 Waterproof.

Suitable for all outdoor areas.

Series: RELAX DARK

IP65 Waterproof.

Suitable for all outdoor areas.

Series: TERM2000 L&H, RELAX GLASS

IP67 completely Waterproof – only by BURDA!

Also suited for unprotected outdoor areas.

Series: TERM2000 IP67

Your dealer

INTELLIGENT DECISIONS!

Our clients value the outstanding quality and the broad range of application of our products. Whether in the hotel or catering industry or in private areas the BURDA infrared short-wave technology heater and cooler product range convinces the world leading brands and industries. Choose the intelligent solutions to your needs.

SELECTION OF REFERENCES

International Cooperation

- AEG/Stiebel Eltron
- Bartscher
- FRICO
- Schwank

Worldwide first class hotels

- Adlon
- Holiday Inn
- Hilton
- Marriott
- Sheraton
- Steigenberger
- Vier Jahreszeiten ...

International and national restaurants and cafes

- Blockhouse
- Burger King
- Cafetiero
- Häagen-Dazs
- Hard Rock Cafe
- Le Crobag
- McDonald's
- Nordsee
- Starbucks ...

Superior grandhotel at sea

- AIDA Cruises
- A-Rosa Cruises
- Celebrity Cruises

TV-Studio

- Big Brother
- Endemol

Museum and events

- Louvre Paris – France
- Berlinale Berlin – Germany

Trade and industry

- Areva
- Ford
- Mercedes
- Thyssen Krupp
- Volkswagen ...

Air Traffic

- Condor
- Lufthansa
- Royal Air Force
- US Army ...

BURDA WORLDWIDE TECHNOLOGIES GMBH

Rudolf-Diesel-Strasse 18 · 65760 Eschborn · Germany
tel +49 6173 /324 24 0 · fax +49 6173 /324 24 24
email info@burdawtg.de · www.burdawtg.com