

# TY-GARD

## DOUBLE-STRENGTH

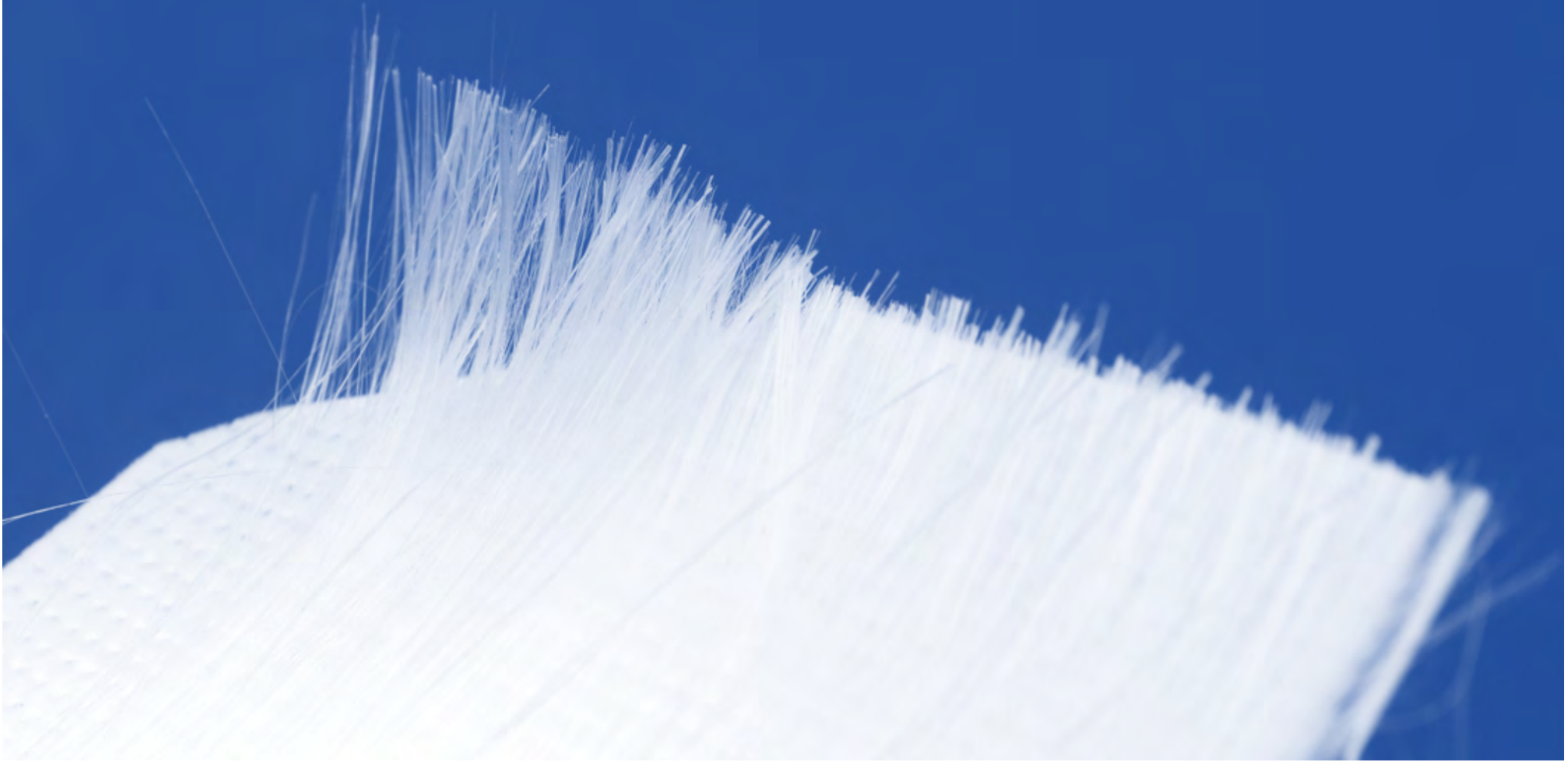

# **TY-GARD**

## **DOUBLE-STRENGTH**

### **DETAILS**

- **Ty-Gard DS<sup>®</sup> is 24" Wide**
- **New Stitch Bonded & Coated Rigid Backing Material**
- **Two bands of original Ty-Gard<sup>®</sup> (32") = 288,000 Fibers of Reinforcement**
- **One band of Ty-Gard DS<sup>®</sup> (24") = 288,000 Fibers of Reinforcement**
- **AAR Approved to substitute two bands of original Ty-Gard for one band of Ty-Gard-DS**

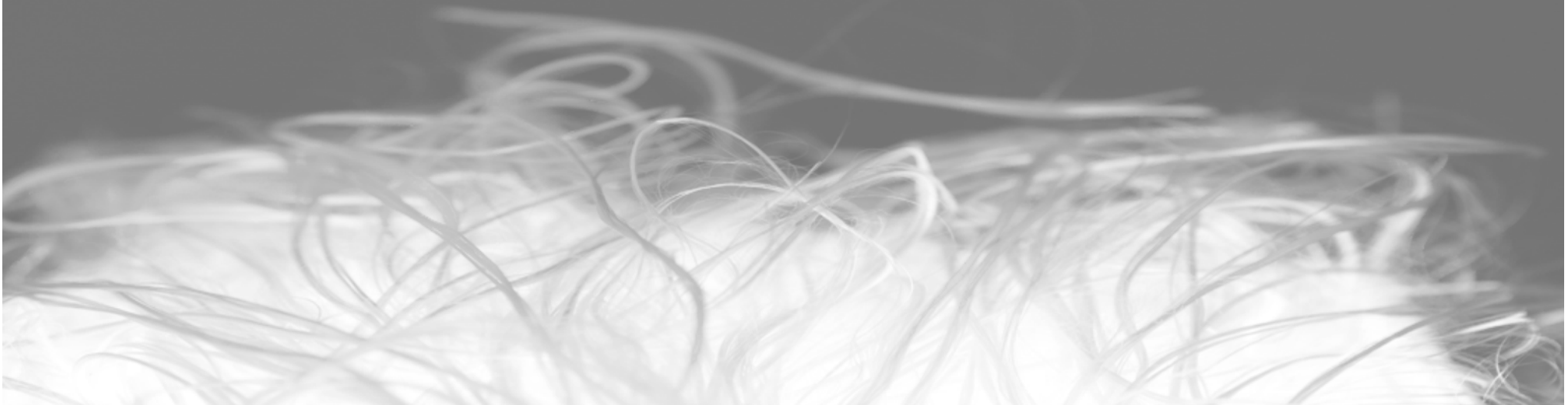

# TY-GARD

## DOUBLE-STRENGTH

### ADVANTAGES

- One band of Double Strength Ty-Gard = Two bands original version Ty-Gard
- Reduces labor / installation time by **50%** making it the quickest and easiest to install system on the market
- Same total material cost as standard Ty-Gard
- Rigid fabric easier to handle and in many cases plywood is not required
- Improved lightweight tensioning tools easier to use

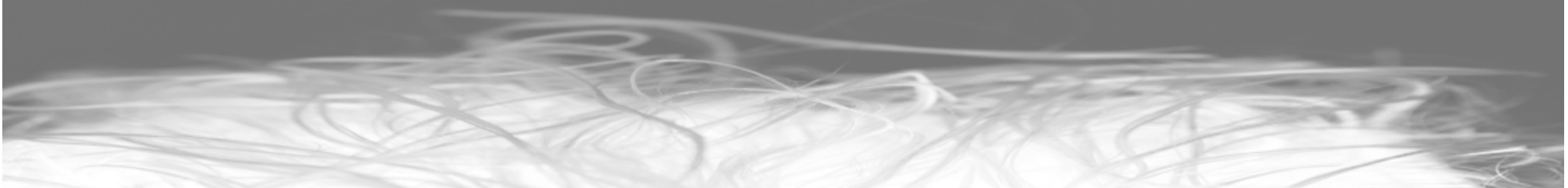

# **TY-GARD**

## **DOUBLE-STRENGTH**

### **ADVANTAGES**

- **One band per layer of cargo leads to consistent tension compared with two bands**
- **Half the number of bands to measure and mark**
- **Increased rigidity reduces wrinkling and no sagging / slack bands**
- **Passed 80 Drum AAR Impact TEST with almost no movement**
- **Pre Spliced Option**
- **Fastest to install and most effective approved system on the planet....**

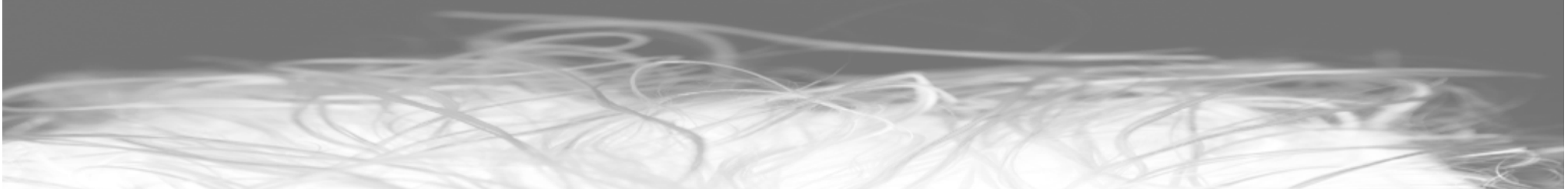



**TY-GARD**  
**DOUBLE-STRENGTH**

# TY-GARD

## DOUBLE-STRENGTH

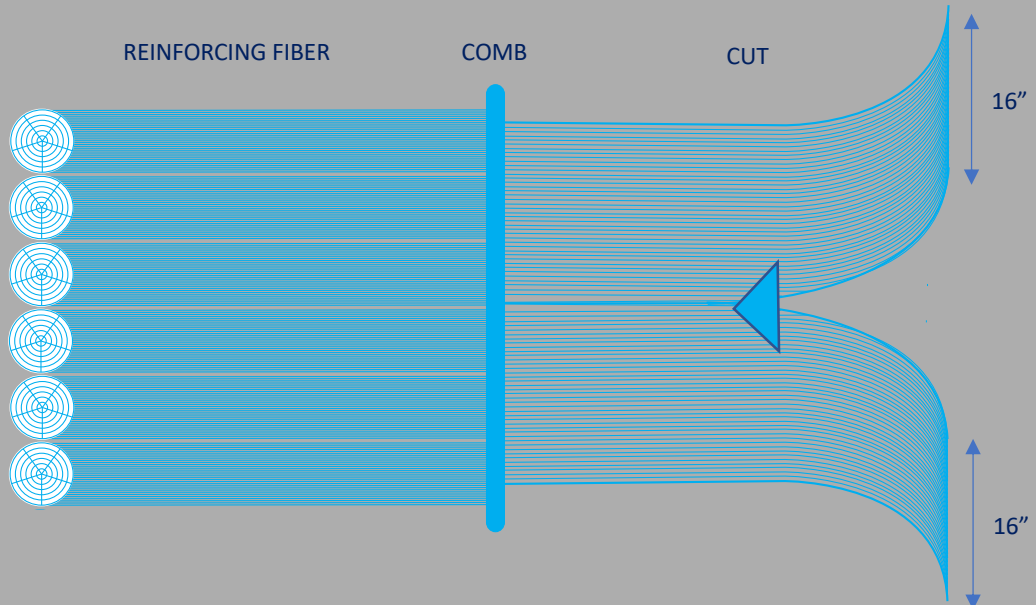

### ORIGINAL TY-GARD®

- 6 BEAMS REINFORCEMENT FIBERS
- 288,000 FIBERS TOTAL
- TWO STRIPS EACH 144,000 FIBERS

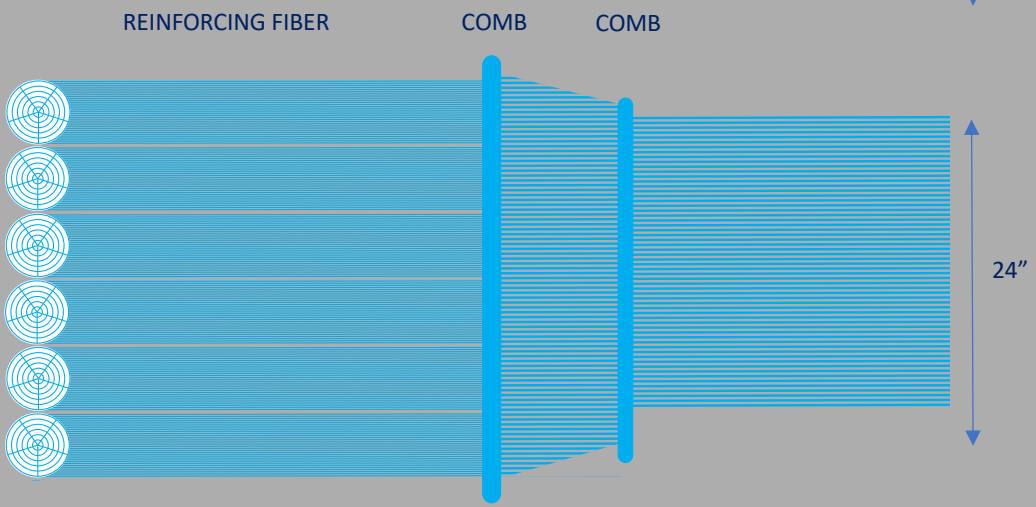

### TY-GARD DS®

- 6 BEAMS REINFORCEMENT FIBERS
- 288,000 FIBERS TOTAL
- ONE STRIP 288,000 FIBERS TOTAL

# TY-GARD

DOUBLE-STRENGTH



# TY-GARD

DOUBLE-STRENGTH

TWO BANDS ORIGINAL TY-GARD®

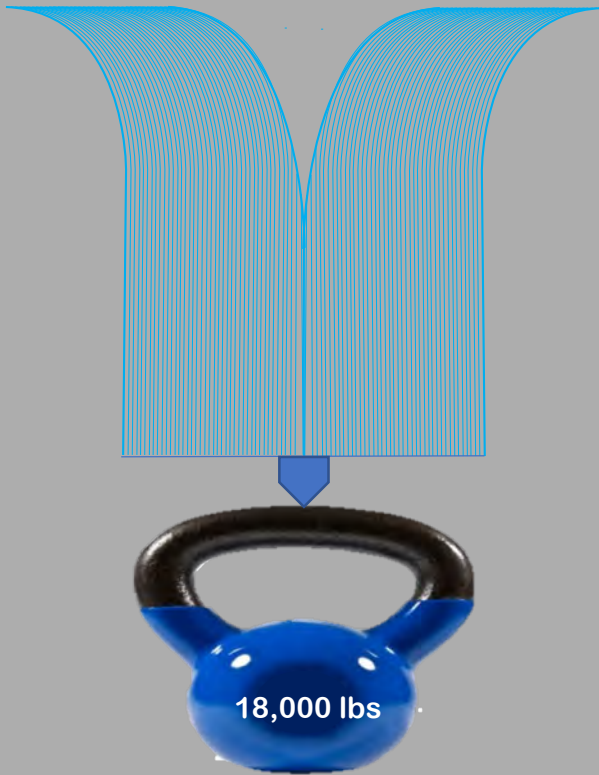

ONE BAND TY-GARD® DS

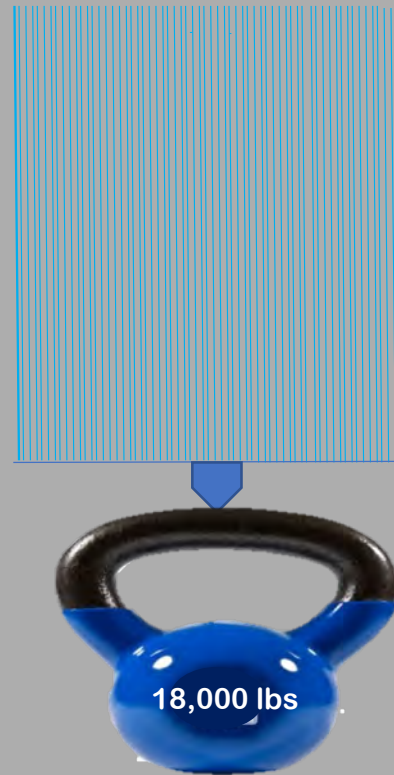



# TY-GARD

DOUBLE-STRENGTH

TWO BANDS ORIGINAL TY-GARD®

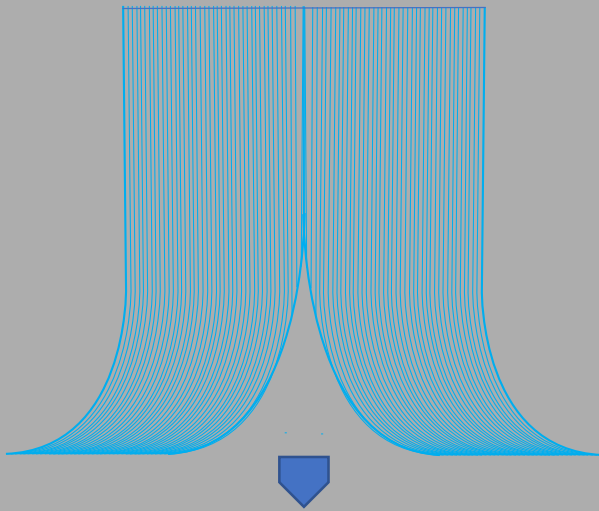

8 Minutes Labor to Install

ONE BAND TY-GARD® DS

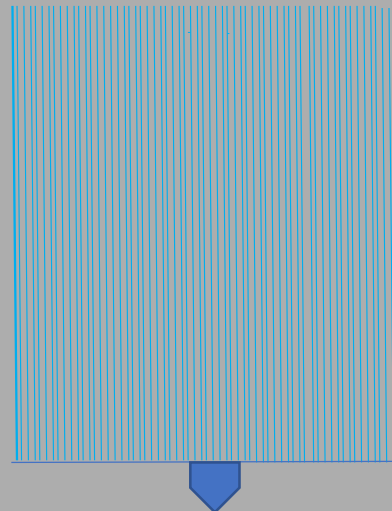

3 Minutes Labor to Install



**TY-GARD**  
DOUBLE-STRENGTH

STITCHED & COATED CARRIER



# TY-GARD

DOUBLE-STRENGTH

## 24" TOOL

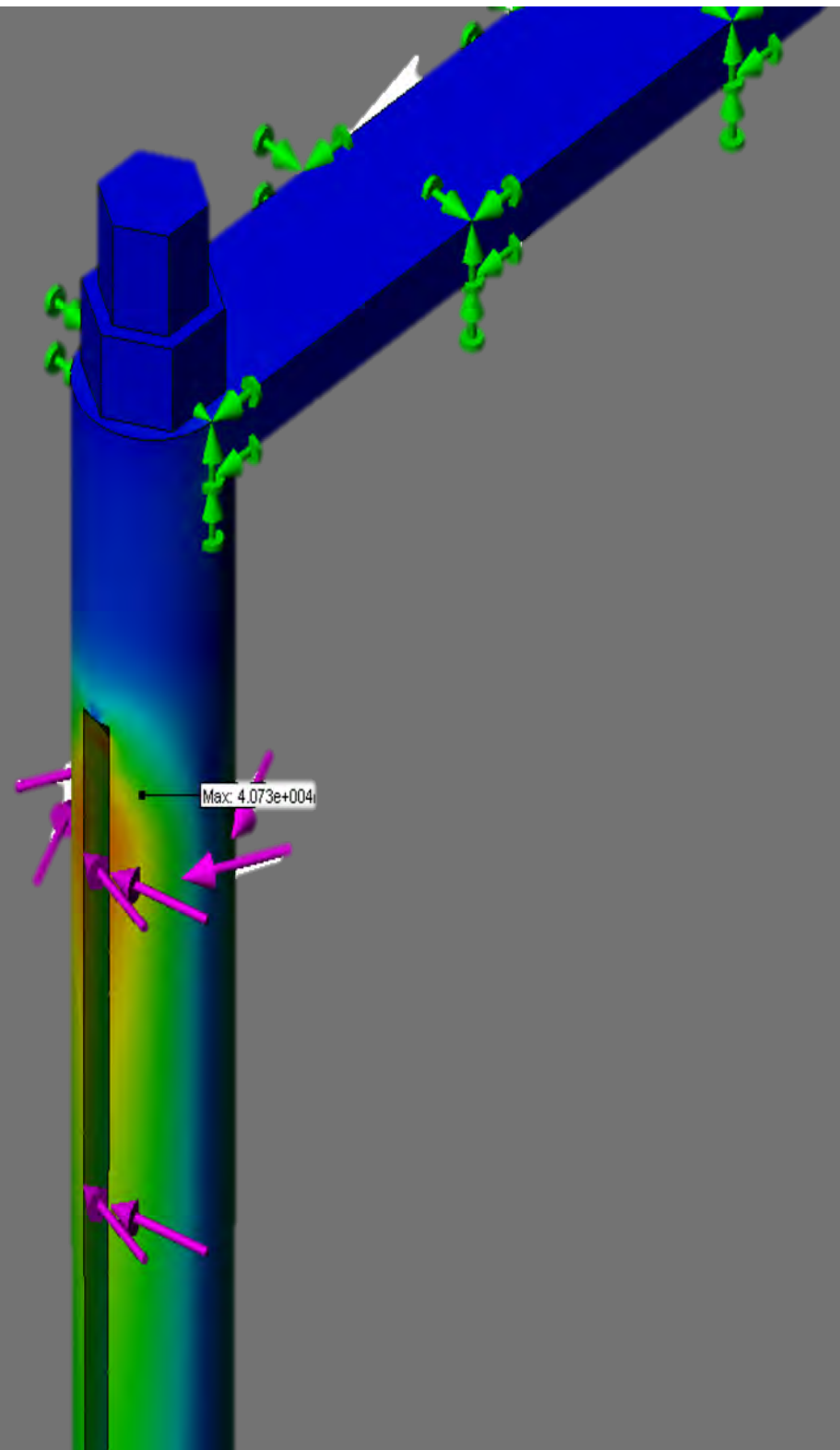
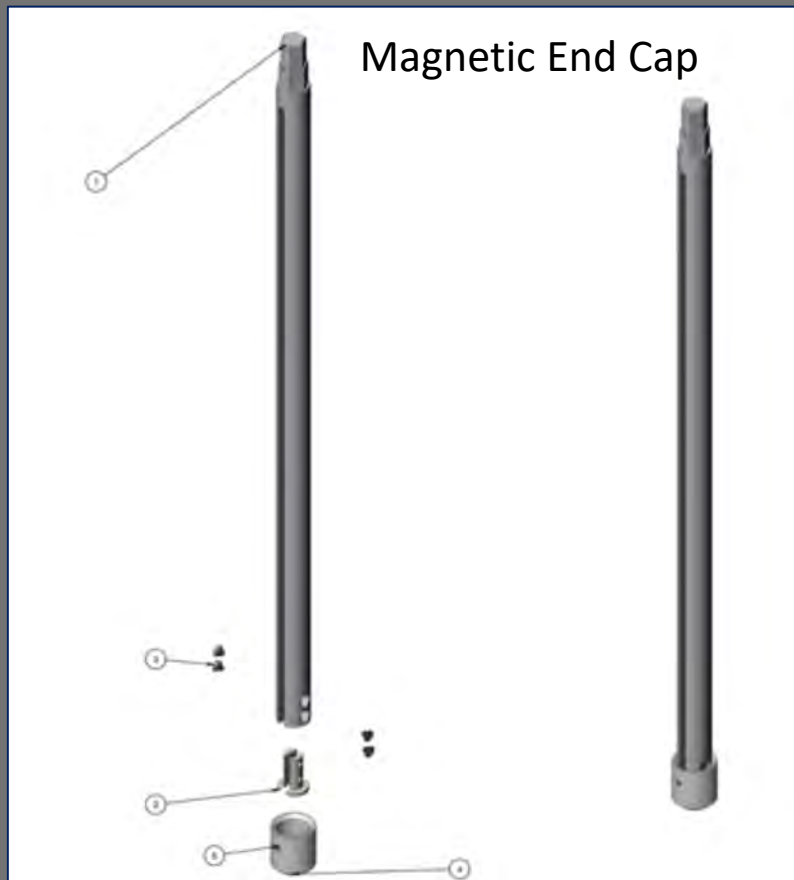

# TY-GARD

DOUBLE-STRENGTH



# TY-GARD

DOUBLE-STRENGTH



# TY-GARD

DOUBLE-STRENGTH



# TY-GARD

DOUBLE-STRENGTH





**TY-GARD**  
DOUBLE-STRENGTH





**TY-GARD**  
DOUBLE-STRENGTH



**TY-GARD**  
DOUBLE-STRENGTH



**TY-GARD**  
DOUBLE-STRENGTH

Authorised UK Distributor: Steve Wilkinson. Tel: 07836 629899  
e mail: [steve@packagingproducts.co.uk](mailto:steve@packagingproducts.co.uk)

# TY-GARD DOUBLE-STRENGTH

Authorised UK Distributor:  
Steve Wilkinson Tel: 07836 629899

78 DRUM EXAMPLE  
SECURED WITH FOUR BANDS TY-GARD ORIGINAL  
15-20 MINUTES LABOR

78 DRUM EXAMPLE  
SECURED WITH TWO BANDS TY-GARD DS  
10 MINUTES LABOR

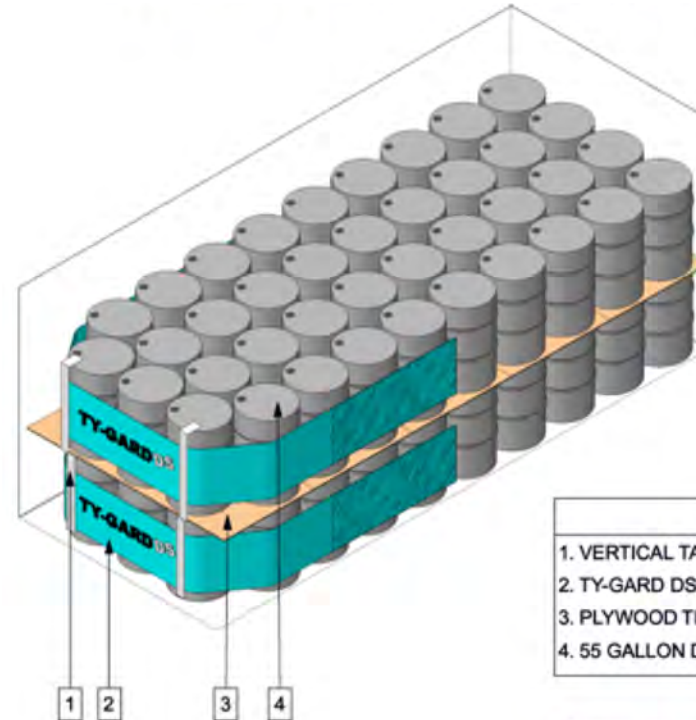
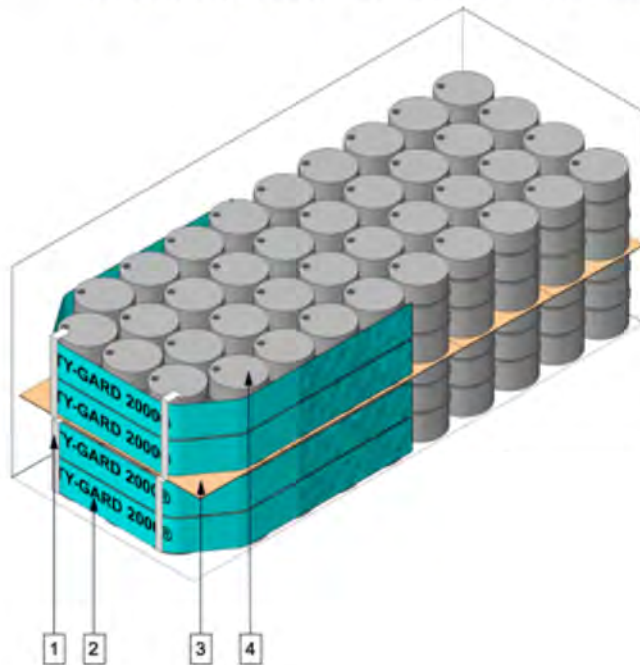

KEY	
1.	VERTICAL TAPE
2.	TY-GARD DS® BARRIER
3.	PLYWOOD TIER SEPARATOR
4.	55 GALLON DRUM - 78

