

Heritage Moulding Corporation

“Unsurpassed Quality – Outstanding Service – Competitive Pricing”

“Unsurpassed Quality” – Starts with the selection of the highest grades of the finest domestic and imported hardwoods. Continues with the constant quality control throughout the state of the art milling processes. And ends with the product produced for your project.

“Outstanding Service” - This isn't just a catch phrase for us, but an ongoing goal. Timely production and on time delivery are constantly being strived for. The old adage of time is money is never more critical than in today's business environment. Simply... we deliver on time!

“Competitive Pricing” – The selection of our mouldings are a value added part of your building project. But don't let the idea of premium mouldings be confused with premium pricing. We think you will be pleasantly surprised to find that our pricing structure rivals what you would find at public consumer outlets.

These separate, but equal, components are the cornerstones of the business philosophy and guiding principals of *Heritage Moulding Corporation*.

Your own unique sense of style can be brought to life with the use of our fine wood products. We welcome the opportunity to work with you, your architect, your designer and your builder to help you achieve just the look you are seeking.

Heritage Moulding Corporation

910-428-4555

1/2 Scale

1/2 Scale

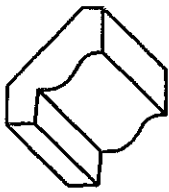

HMC-1000
(1/2" x 1-3/4")

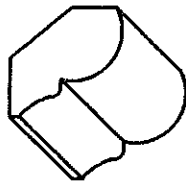

HMC-1010
(3/4" x 1-3/4")

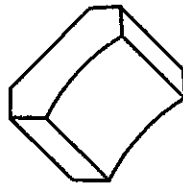

HMC-1020
(1/2" x 1-3/4")

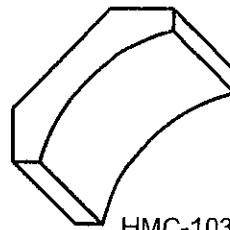

HMC-1030
(1/2" x 2-1/2")

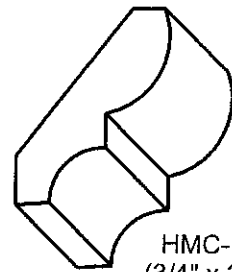

HMC-1040
(3/4" x 2-3/4")

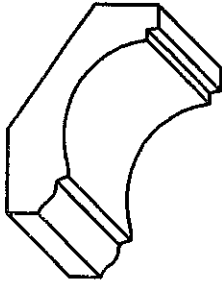

HMC-1050
(7/8" x 2-7/8")

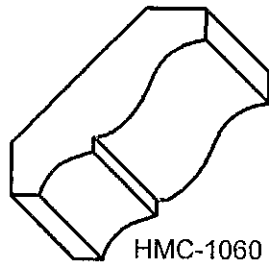

HMC-1060
(3/4" x 3")

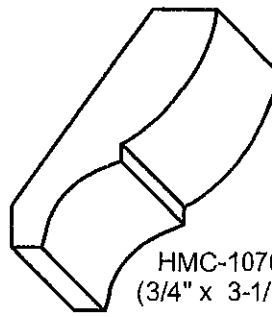

HMC-1070
(3/4" x 3-1/2")

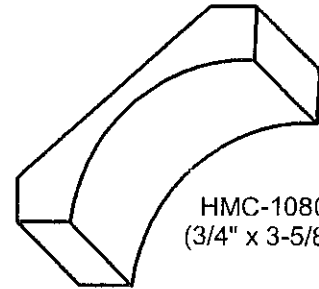

HMC-1080
(3/4" x 3-5/8")

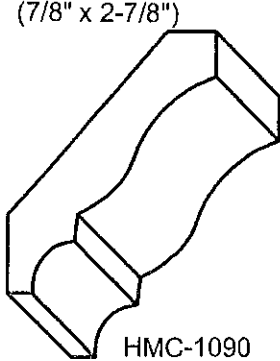

HMC-1090
(3/4" x 3-3/4")

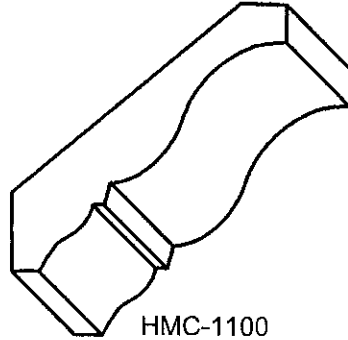

HMC-1100
(3/4" x 4-1/4")

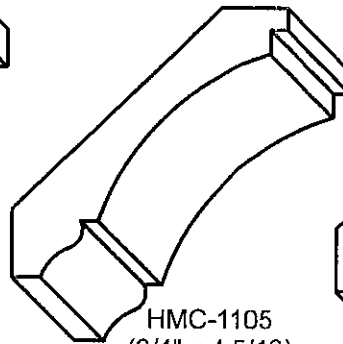

HMC-1105
(3/4" x 4-5/16)

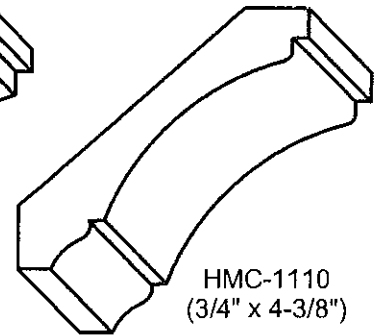

HMC-1110
(3/4" x 4-3/8")

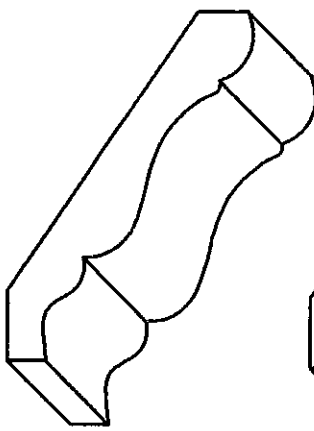

HMC-1120
(3/4" x 4-3/4")

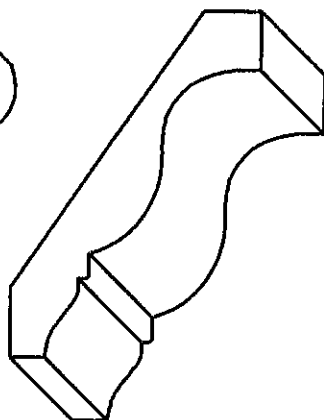

HMC-1130
(7/8" x 4-3/4")

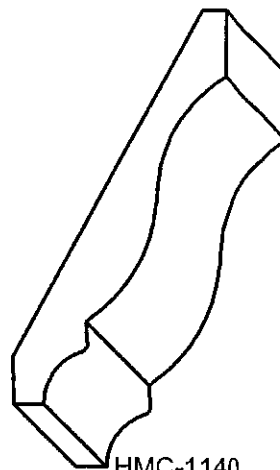

HMC-1140
(3/4" x 5")

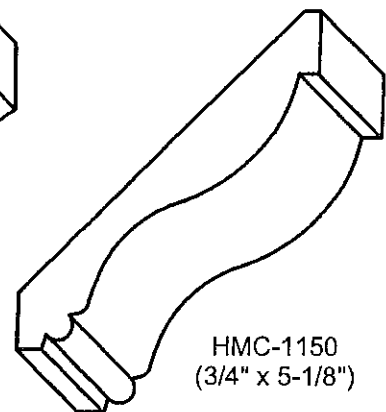

HMC-1150
(3/4" x 5-1/8")

CROWN1

Custom sizes and shapes available

CROWN1

Heritage Moulding Corporation

910-428-4555

1/2 Scale

1/2 Scale

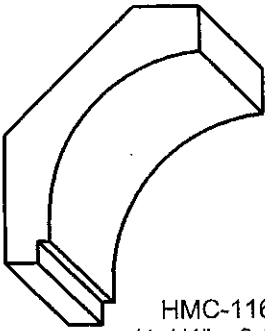

HMC-1160
(1-1/4" x 3-5/8")

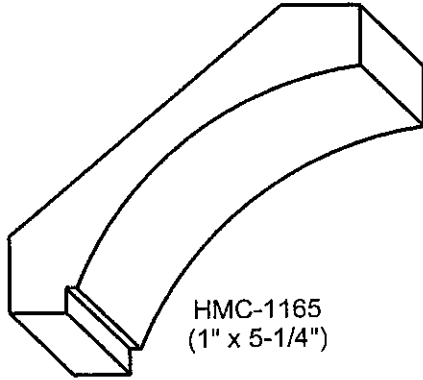

HMC-1165
(1" x 5-1/4")

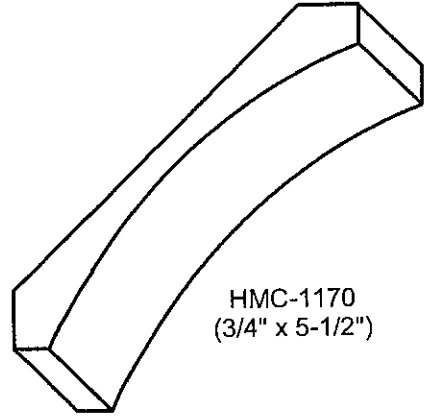

HMC-1170
(3/4" x 5-1/2")

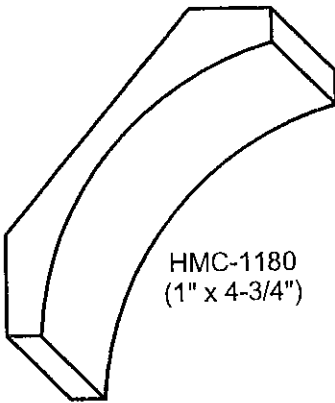

HMC-1180
(1" x 4-3/4")

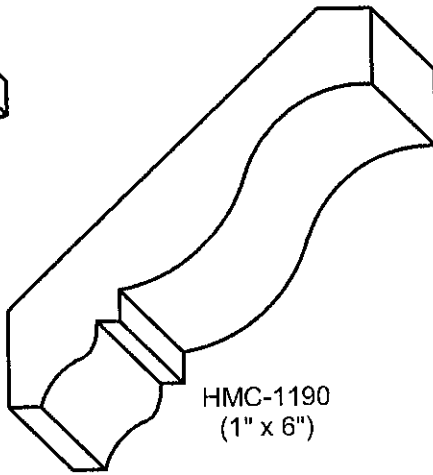

HMC-1190
(1" x 6")

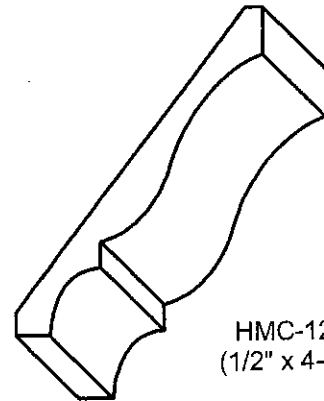

HMC-1200
(1/2" x 4-5/8")

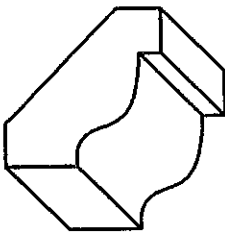

HMC-1210
(7/8" x 2-1/2")

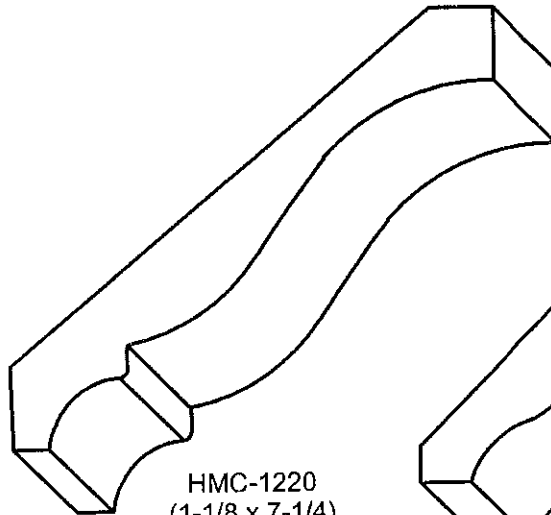

HMC-1220
(1-1/8" x 7-1/4")

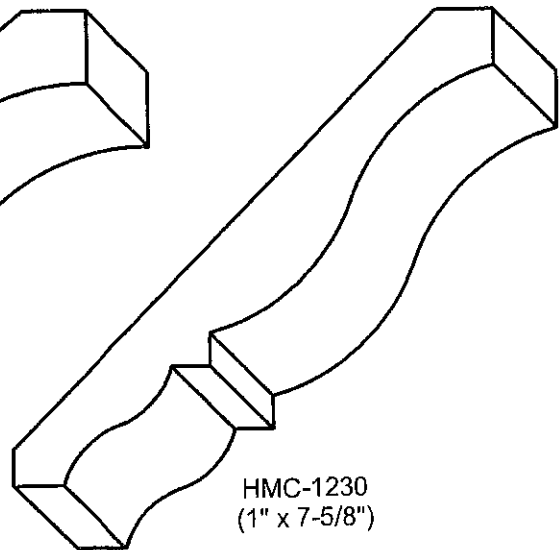

HMC-1230
(1" x 7-5/8")

CROWN2

CROWN2

Custom sizes and shapes available

Heritage Moulding Corporation

910-428-4555

1/2 Scale

1/2 Scale

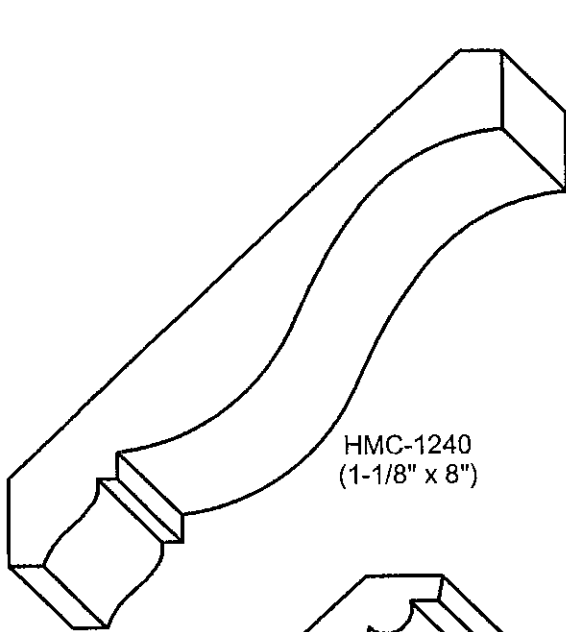

HMC-1240
(1-1/8" x 8")

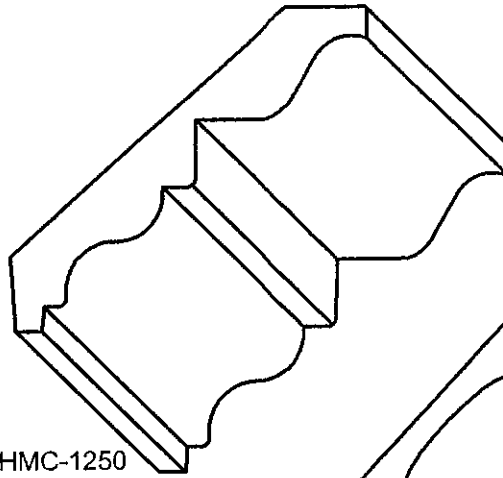

HMC-1250
(1" x 5-3/8")

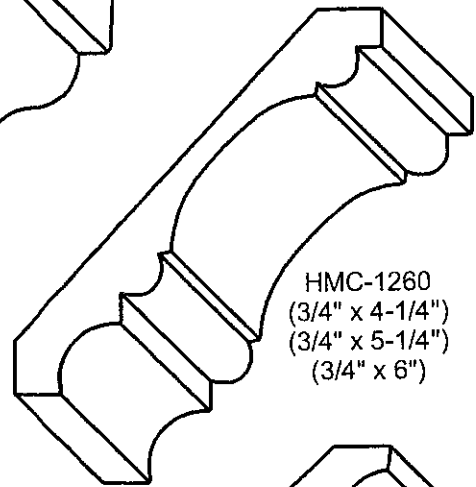

HMC-1260
(3/4" x 4-1/4")
(3/4" x 5-1/4")
(3/4" x 6")

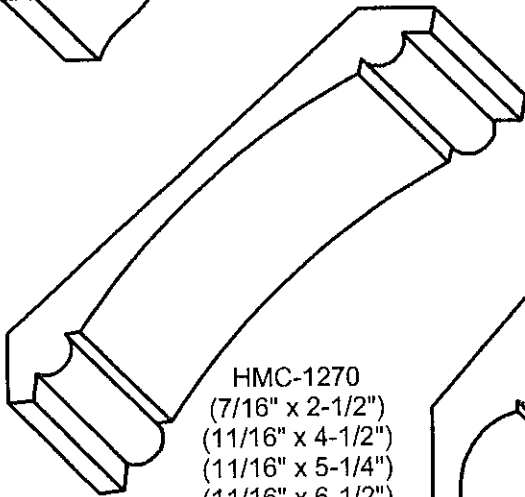

HMC-1270
(7/16" x 2-1/2")
(11/16" x 4-1/2")
(11/16" x 5-1/4")
(11/16" x 6-1/2")

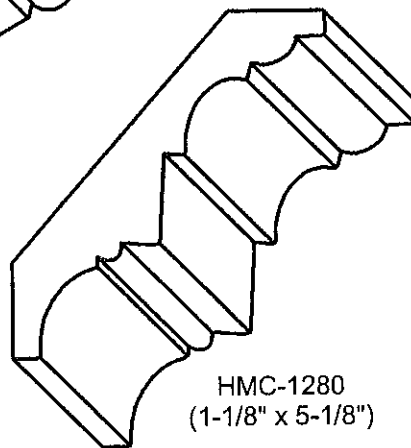

HMC-1280
(1-1/8" x 5-1/8")

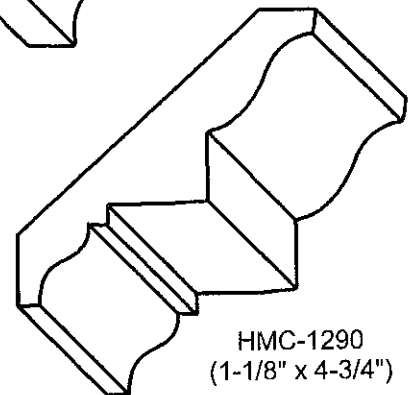

HMC-1290
(1-1/8" x 4-3/4")

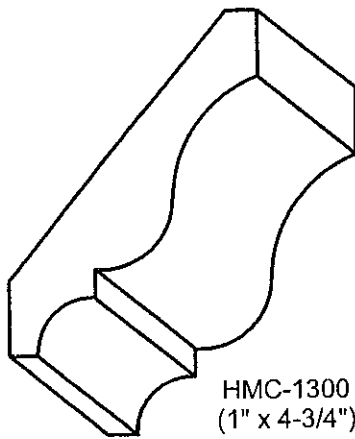

HMC-1300
(1" x 4-3/4")

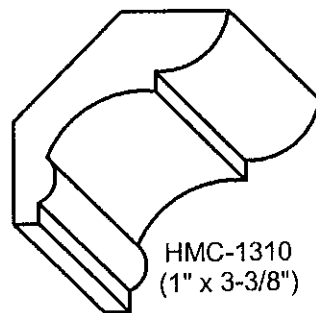

HMC-1310
(1" x 3-3/8")

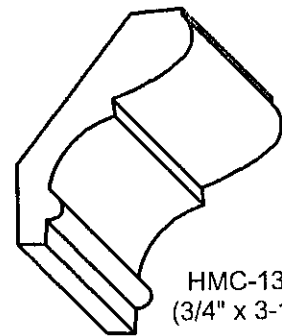

HMC-1320
(3/4" x 3-1/4")

CROWN3

CROWN3

Custom sizes and shapes available

Heritage Moulding Corporation

910-428-4555

1/2 Scale

1/2 Scale

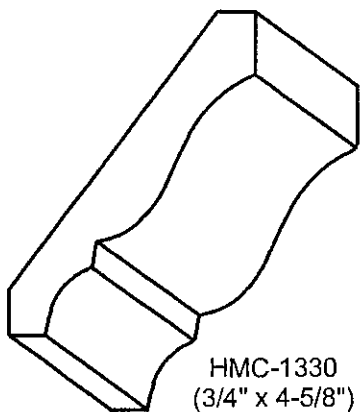

HMC-1330
(3/4" x 4-5/8")

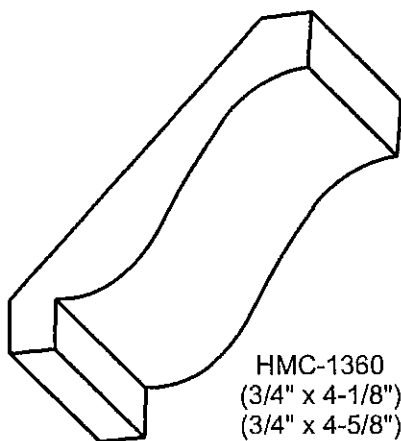

HMC-1360
(3/4" x 4-1/8")
(3/4" x 4-5/8")
(3/4" x 4-7/8")
(3/4" x 5-1/8")

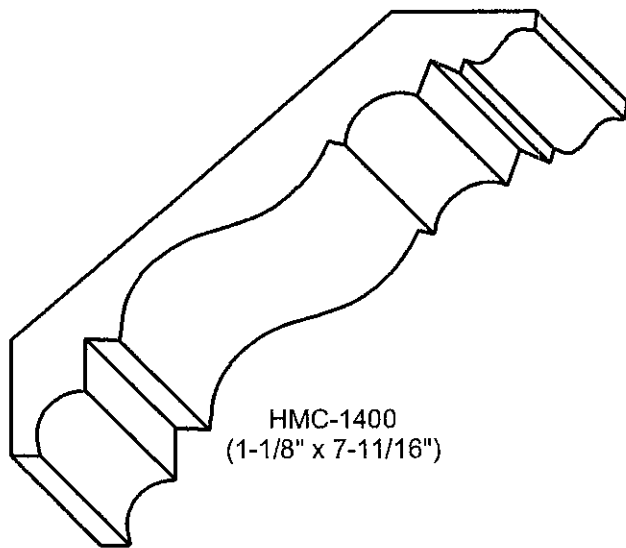

HMC-1400
(1-1/8" x 7-11/16")

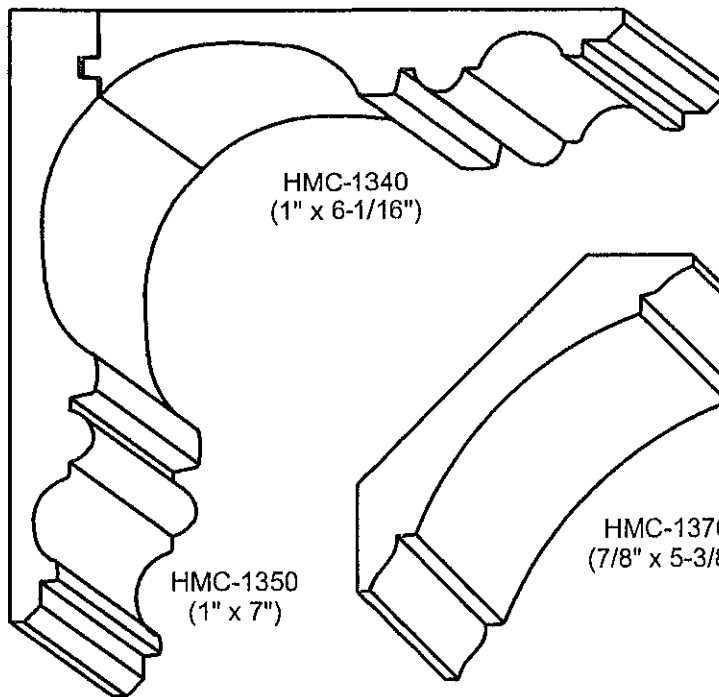

HMC-1340
(1" x 6-1/16")

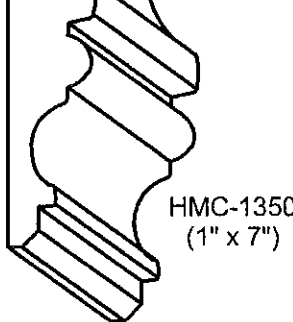

HMC-1350
(1" x 7")

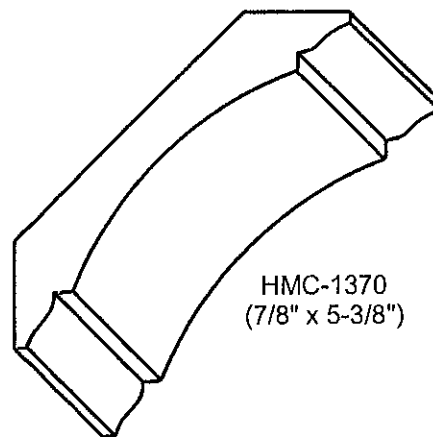

HMC-1370
(7/8" x 5-3/8")

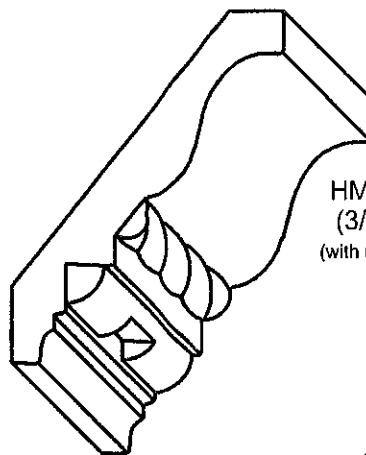

HMC-1390
(3/4" x 5")
(with rope and dentil)

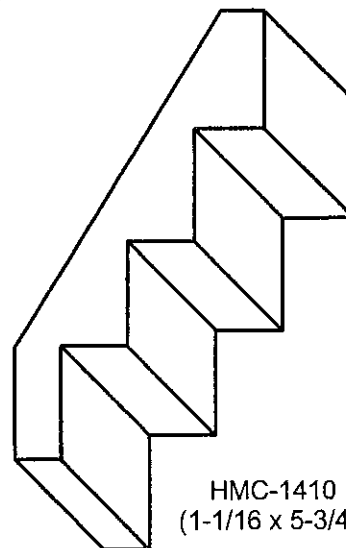

HMC-1410
(1-1/16" x 5-3/4")

CROWN4

CROWN4

Custom sizes and shapes available

Heritage Moulding Corporation

910-428-4555

1/2 Scale

1/2 Scale

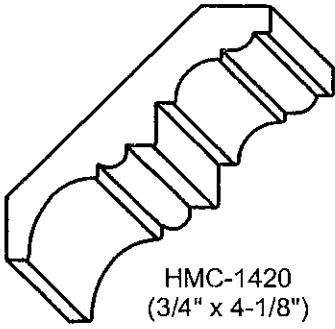

HMC-1420
(3/4" x 4-1/8")

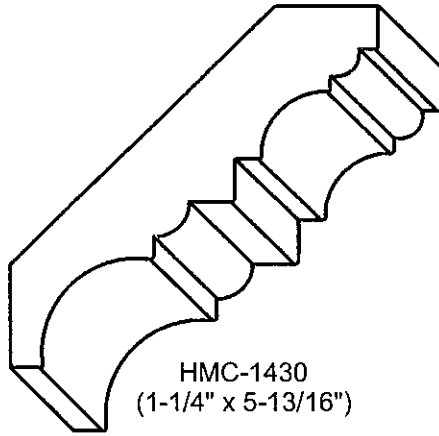

HMC-1430
(1-1/4" x 5-13/16")

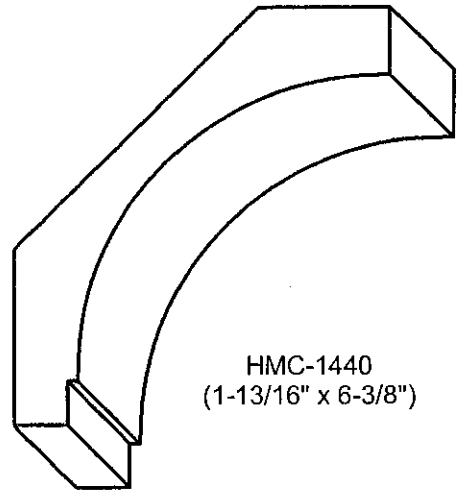

HMC-1440
(1-13/16" x 6-3/8")

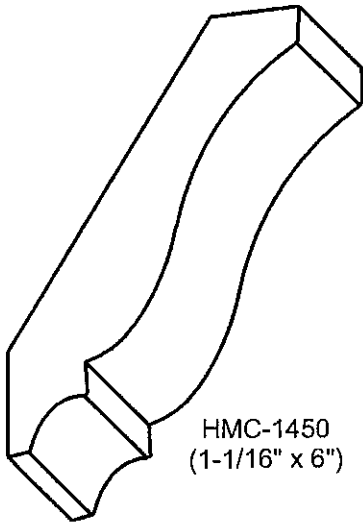

HMC-1450
(1-1/16" x 6")

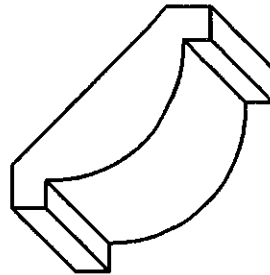

HMC-1460
(7/8" x 3-3/16")

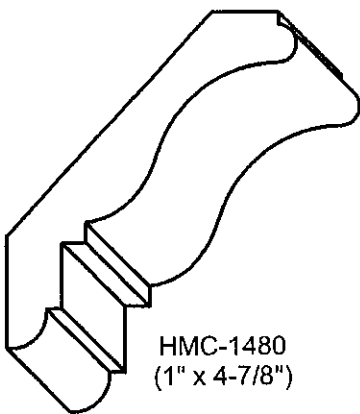

HMC-1480
(1" x 4-7/8")

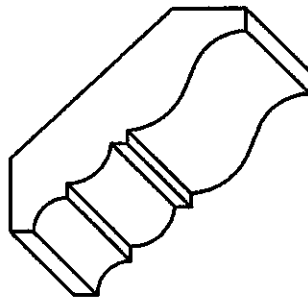

HMC-1490
(7/8" x 3-5/8")

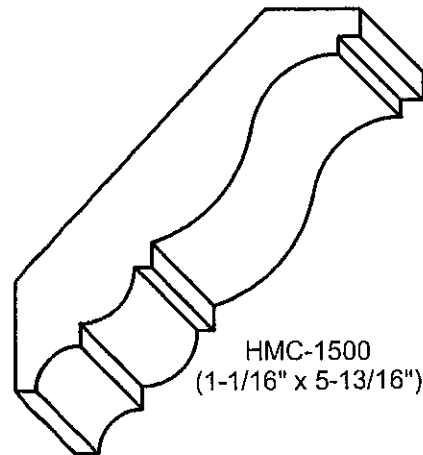

HMC-1500
(1-1/16" x 5-13/16")

CROWN5

CROWN5

Custom sizes and shapes available

Heritage Moulding Corporation

910-428-4555

1/2 Scale

1/2 Scale

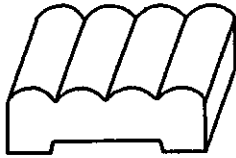

HMC-2000
(3/4" x 2-3/16")

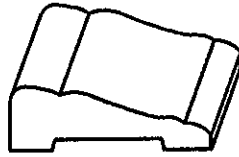

HMC-2010
(3/4" x 2-1/4")



HMC-2020
(3/4" x 2-1/4")

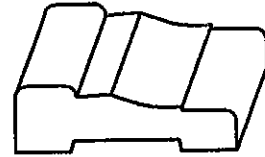

HMC-2030
(3/4" x 2-1/2")

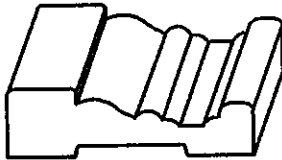

HMC-2040
(3/4" x 2-3/4")

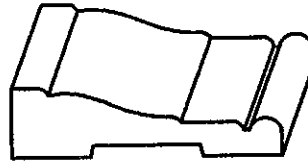

HMC-2050
(3/4" x 3")

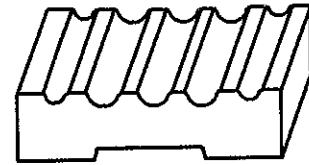

HMC-2060
(3/4" x 3")

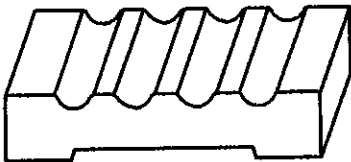

HMC-2070
(3/4" x 3-1/2")



HMC-2080
(3/4" x 3-1/2")

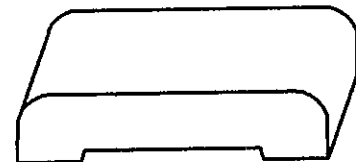

HMC-2090
(3/4" x 3-1/2")

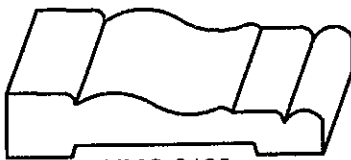

HMC-2100
(3/4" x 3-1/2")



HMC-2110
(1" x 3-1/2")

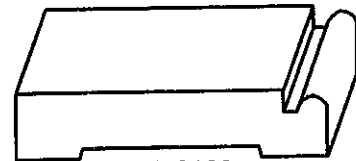

HMC-2120
(3/4" x 3-1/2")

CASING1

CASING1

Custom sizes and shapes available

Heritage Moulding Corporation

910-428-4555

1/2 Scale

1/2 Scale



HMC-2130
(1" x 3-1/2")

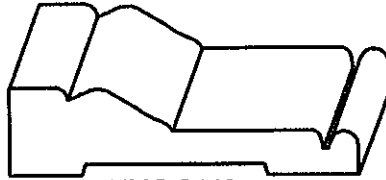

HMC-2140
(1" x 3-7/8")



HMC-2150
(1-1/8" x 4")

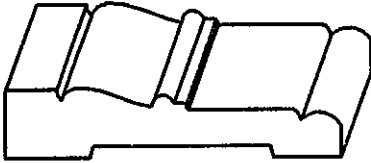

HMC-2160
(3/4" x 4")

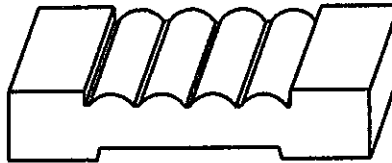

HMC-2170
(3/4" x 4")

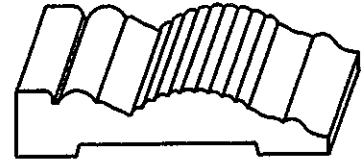

HMC-2180
(3/4" x 3-1/2")

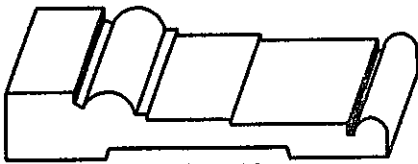

HMC-2190
(3/4" x 4-1/4")

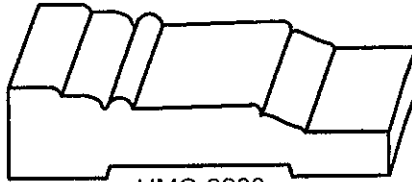

HMC-2200
(1" x 4-1/4")

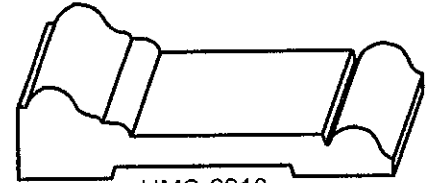

HMC-2210
(1" x 4-1/4")

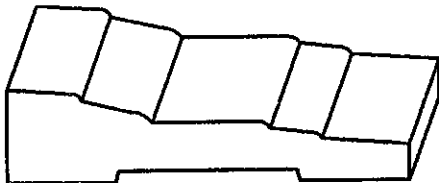

HMC-2220
(1-1/16" x 4-1/2")

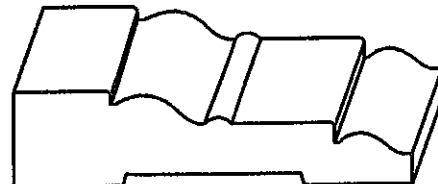

HMC-2230
(1-1/16" x 4-1/2")

CASING2

Custom sizes and shapes available

CASING2

Heritage Moulding Corporation

910-428-4555

1/2 Scale

1/2 Scale



HMC-2240
(1" x 4-1/2")

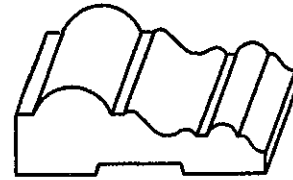

HMC-2250
(1" x 2-7/8")

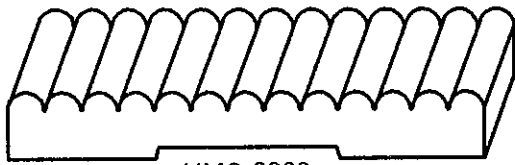

HMC-2260
(3/4" x 5-5/16")

HMC-2260 is available in various widths
Minimum width available is 1-5/8"

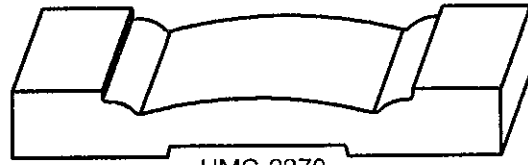

HMC-2270
(3/4" x 5-1/2")

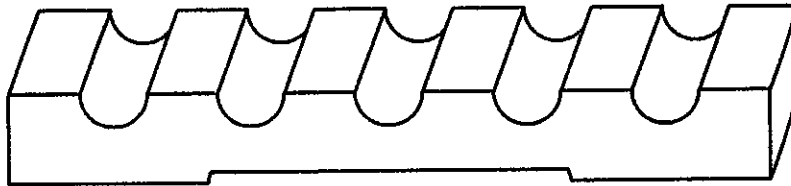

HMC-2280
(1" x 8-1/2")

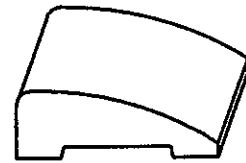

HMC-2290
(3/4" x 2-1/4")

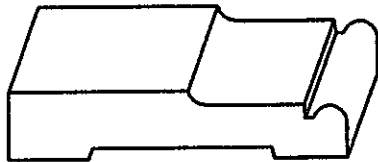

HMC-2300
(3/4" x 3-3/4")

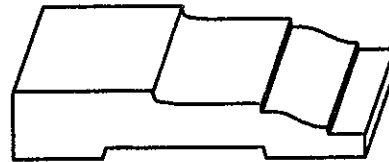

HMC-2310
(3/4" x 4")

CASING3

CASING3

Custom sizes and shapes available

Heritage Moulding Corporation

910-428-4555

1/2 Scale

1/2 Scale

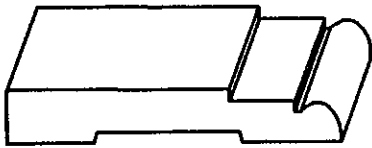

HMC-2320
(5/8" x 3-3/4")

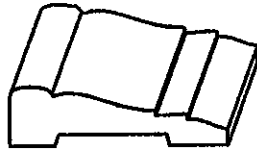

HMC-2330
(5/8" x 2-7/16")

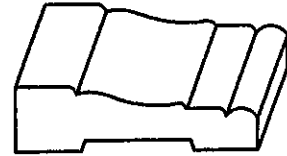

HMC-2340
(3/4" x 2-3/4")

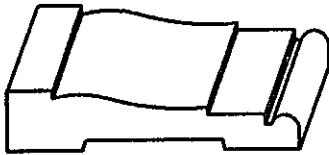

HMC-2350
(11/16" x 3-1/4")

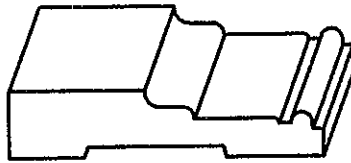

HMC-2360
(3/4" x 3-1/2")

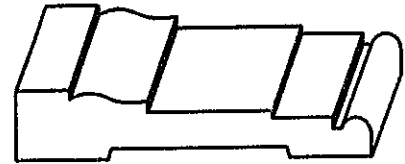

HMC-2370
(3/4" x 4")

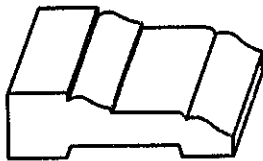

HMC-2380
(3/4" x 2-1/2")

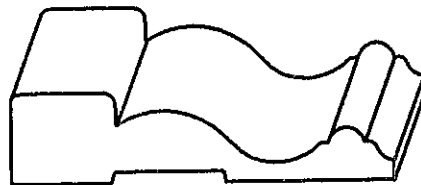

HMC-2390
(1-1/16" x 4-9/32")

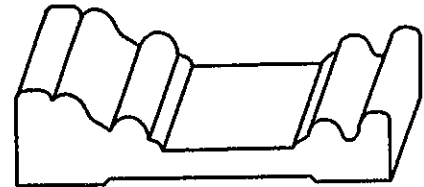

HMC-2400
(1-1/16" x 4-1/4")

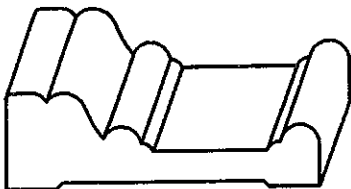

HMC-2410
(1-1/16" x 3-1/2")

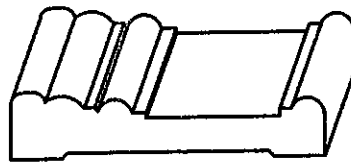

HMC-2420
(3/4" x 3-1/2")

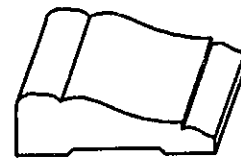

HMC-2430
(11/16" x 2-1/4")

CASING4

Custom sizes and shapes available

CASING4

Heritage Moulding Corporation

910-428-4555

1/2 Scale

1/2 Scale



HMC-2440
(3/4" x 3-1/2")

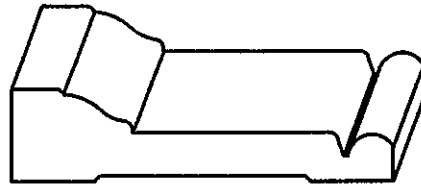

HMC-2450
(1" x 4-1/4")

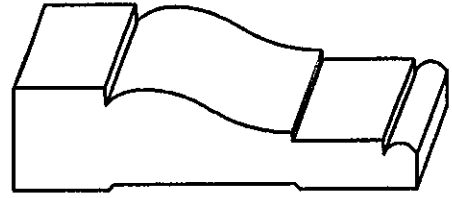

HMC-2460
(1-3/16" x 4-1/2")

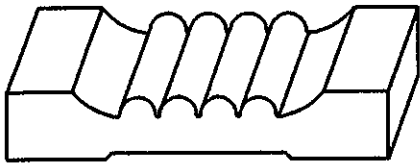

HMC-2470
(3/4" x 4-1/4")

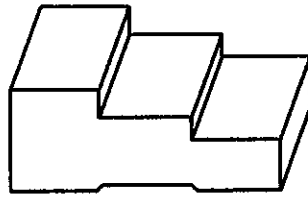

HMC-2480
(1-1/8" x 3")

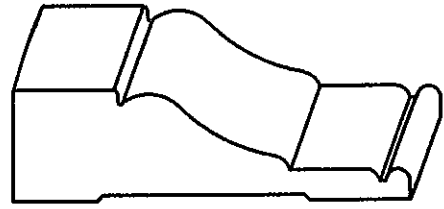

HMC-2490
(1-3/16" x 4-1/2")

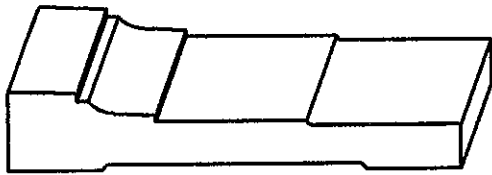

HMC-2500
(1" x 5")

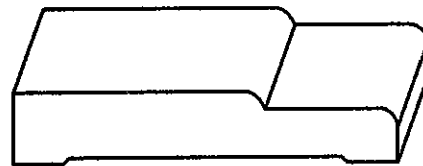

HMC-2510
(13/16" x 4-3/8")

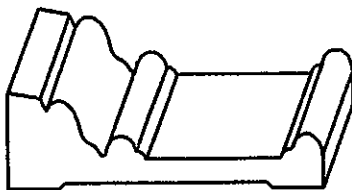

HMC-2520
(1-1/8" x 3-9/16")

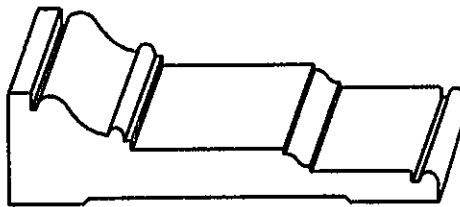

HMC-2530
(1-1/4" x 4-13/16")



HMC-2540
(1-1/16" x 3-3/8")

CASING5

Custom sizes and shapes available

CASING5

Heritage Moulding Corporation

910-428-4555

1/2 Scale

1/2 Scale

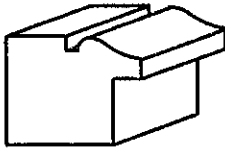

HMC-2600
(1-1/2" x 1-1/4")

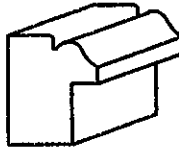

HMC-2610
(1" x 1-1/4")

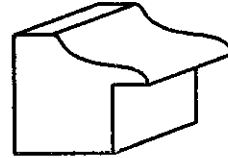

HMC-2620
(1-1/2" x 1-3/8")

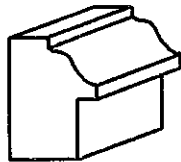

HMC-2630
(1" x 1-3/8")

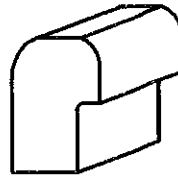

HMC-2640
(1" x 1-1/2")

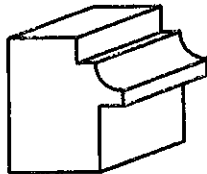

HMC-2650
(1-1/4" x 1-1/2")

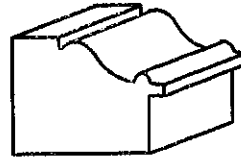

HMC-2660
(1-1/4" x 1-1/2")

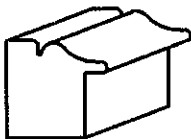

HMC-2670
(1-1/8" x 1-1/16")

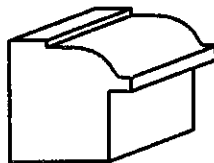

HMC-2680
(1-3/8" x 1-3/8")

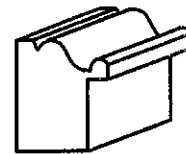

HMC-2690
(1-1/16" x 1-1/4")

BACKBAND1

BACKBAND1

Custom sizes and shapes available

Heritage Moulding Corporation

910-428-4555

1/2 Scale

1/2 Scale

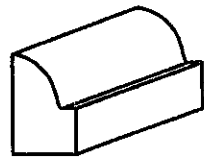

HMC-2800
(1/2" x 3/4")

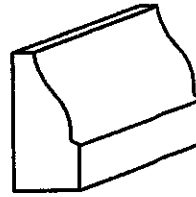

HMC-2810
(1/2" x 1-1/16")

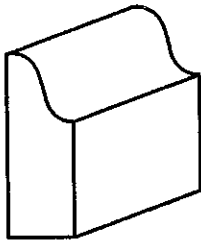

HMC-2820
(1/2" x 1-3/8")

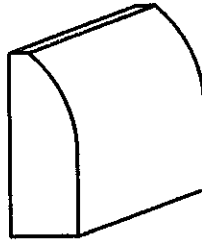

HMC-2830
(1/2" x 1-3/8")

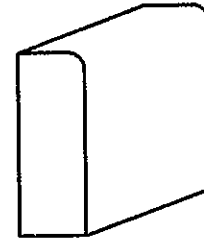

HMC-2840
(1/2" x 1-3/8")

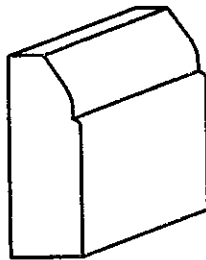

HMC-2850
(1/2" x 1-1/2")

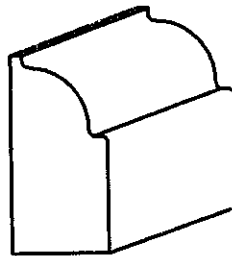

HMC-2860
(3/4" x 1-1/2")

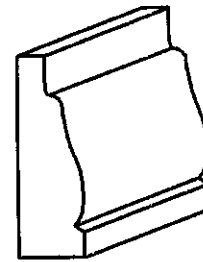

HMC-2870
(1/2" x 1-9/16")

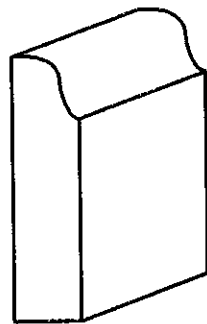

HMC-2880
(1/2" x 2")

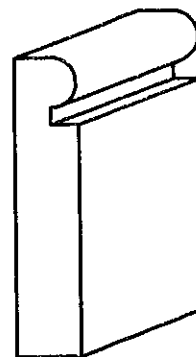

HMC-2890
(1/2" x 2-1/4")

STOPS1

STOPS1

Custom sizes and shapes available

Heritage Moulding Corporation

910-428-4555

1/2 Scale

1/2 Scale

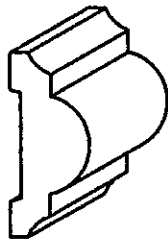

HMC-3000
(7/8" x 2-1/16")

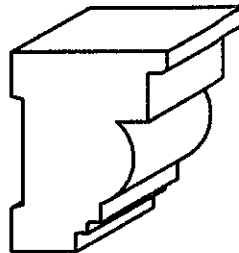

HMC-3010
(1-3/4" x 2-1/4")

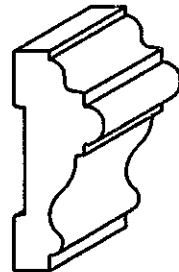

HMC-3020
(1" x 2-1/2")

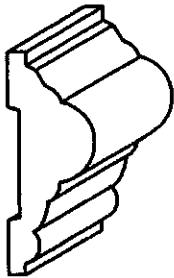

HMC-3030
(1" x 2-1/2")

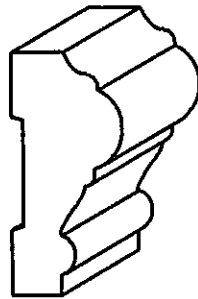

HMC-3040
(1-1/4" x 2-3/4")

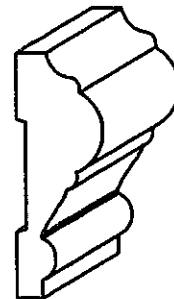

HMC-3050
(1" x 2-3/4")

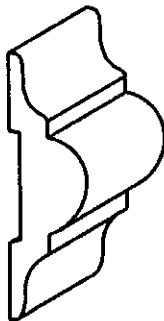

HMC-3060
(7/8" x 3")

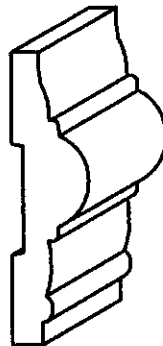

HMC-3070
(7/8" x 3-1/4")

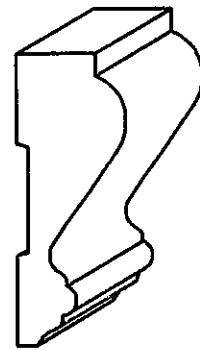

HMC-3090
(1-1/4" x 3-1/4")



HMC-3100
(7/8" x 3-3/8")

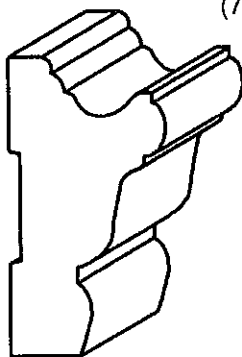

HMC-3110
(1-3/4" x 3-3/8")

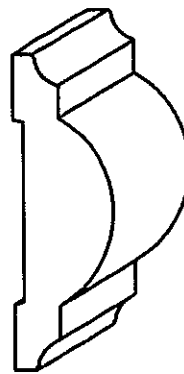

HMC-3120
(1-1/8" x 3-1/2")

CHAIR1

Custom sizes and shapes available

CHAIR1

Heritage Moulding Corporation

910-428-4555

1/2 Scale

1/2 Scale

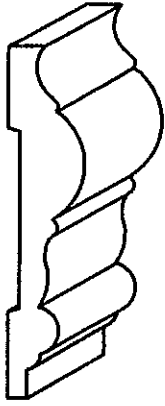

HMC-3130
(7/8" x 4")

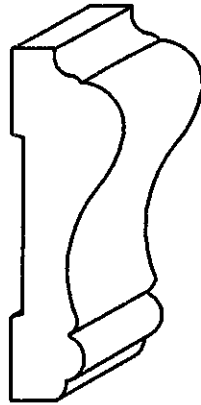

HMC-3140
(1-1/4" x 4")

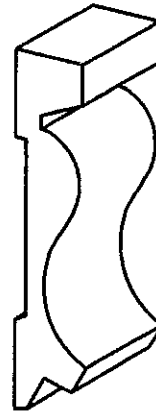

HMC-3150
(3/4" x 4-1/8")



HMC-3160
(1-1/4" x 5-1/2")



HMC-3170
(7/8" x 5-1/4")

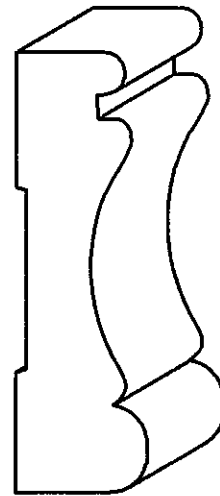

HMC-3180
(1-1/2" x 5")

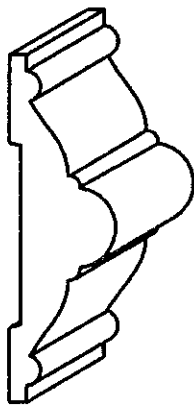

HMC-3190
(1-3/16" x 4")



HMC-3200
(1-1/8" x 4-1/4")

CHAIR2

CHAIR2

Custom sizes and shapes available

Heritage Moulding Corporation
910-428-4555

1/2 Scale

1/2 Scale

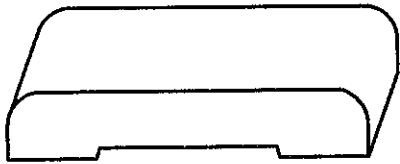

HMC-3500
(3/4" x ?)

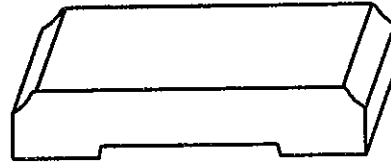

HMC-3510
(3/4" x ?)

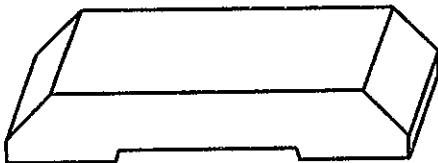

HMC-3520
(3/4" x ?)



HMC-3530
(3/4" x 4-1/2")
(3/4" x 2-1/4")

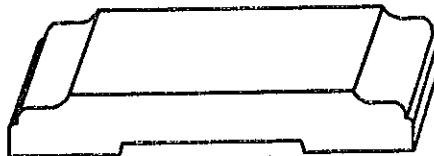

HMC-3540
(5/8" x ?)

BACKER1

BACKER1

Custom sizes and shapes available

Heritage Moulding Corporation

910-428-4555

1/2 Scale

1/2 Scale

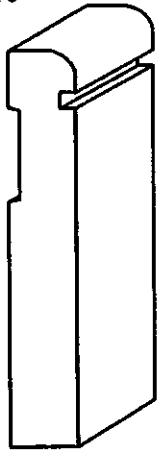

HMC-4000
(3/4" x 2-3/8")

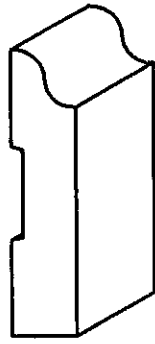

HMC-4010
(3/4" x 3-1/4")

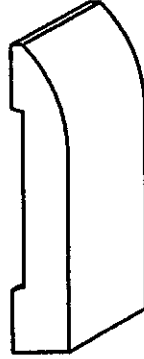

HMC-4020
(5/8" x 3-1/2")

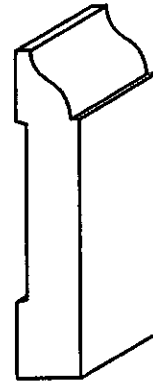

HMC-4030
(3/4" x 3-3/4")



HMC-4040
(3/4" x 4")

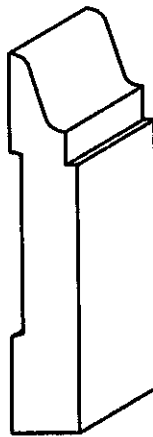

HMC-4050
(3/4" x 4-1/4")

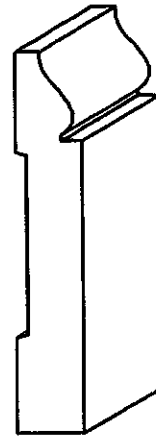

HMC-4060
(3/4" x 4-1/4")

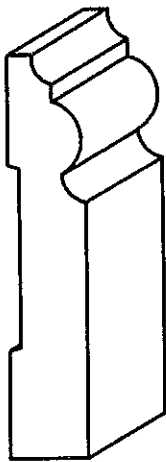

HMC-4080
(7/8" x 4-1/2")

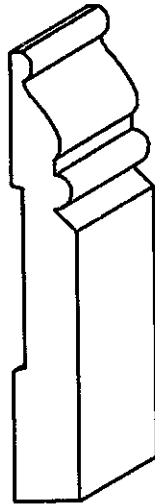

HMC-4090
(3/4" x 5")

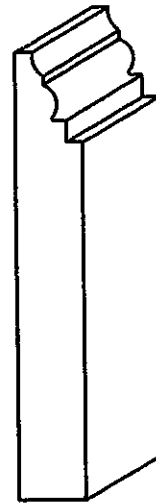

HMC-4100
(3/4" x 5")

BASE1

BASE1

Custom sizes and shapes available

Heritage Moulding Corporation

910-428-4555

1/2 Scale

1/2 Scale

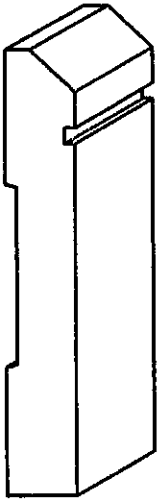

HMC-4110
(3/4" x 5")

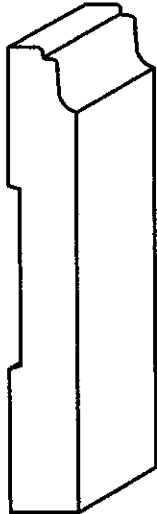

HMC-4120
(3/4" x 5-1/4")

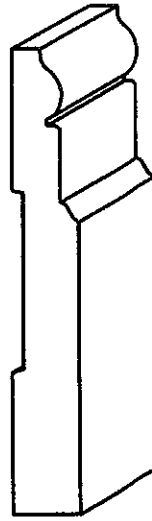

HMC-4130
(3/4" x 5-1/4")

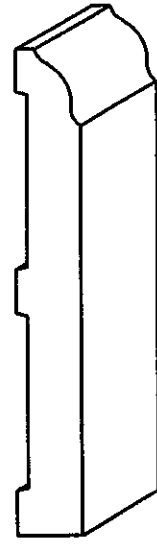

HMC-4140
(3/4" x 5-1/2")

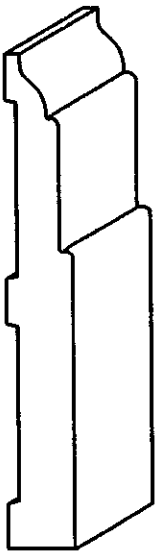

HMC-4150
(3/4" x 5-1/2")



HMC-4160
(3/4" x 6")



HMC-4170
(3/4" x 6-1/4")

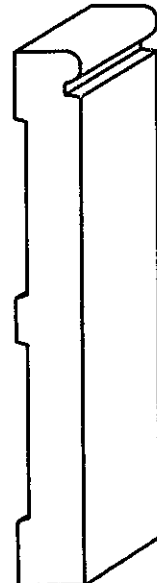

HMC-4180
(3/4" x 6")

BASE2

BASE2

Custom sizes and shapes available

Heritage Moulding Corporation
910-428-4555

1/2 Scale

1/2 Scale

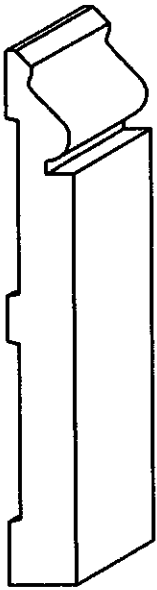

HMC-4190
(5/8" x 6")

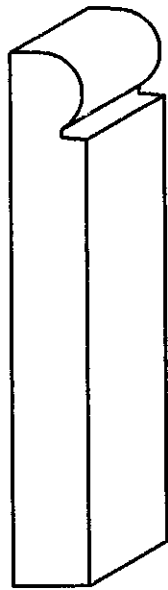

HMC-4200
(7/8" x 6")



HMC-4210
(3/4" x 6")



HMC-4220
(7/8" x 6-1/4")
w/HMC-4780

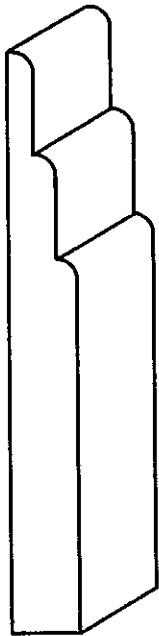

HMC-4240
(3/4" x 6-1/2")

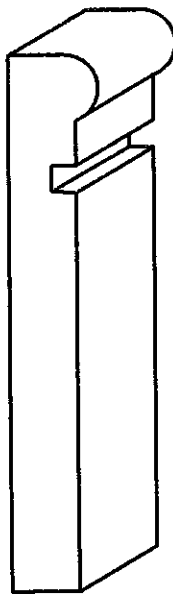

HMC-4250
(3/4" x 6")

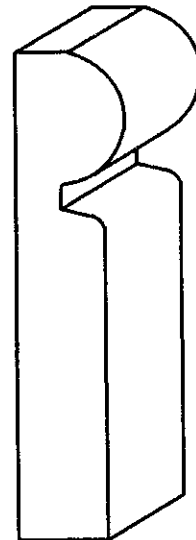

HMC-4260
(1" x 5-1/2")

BASE3

BASE3

Custom sizes and shapes available

Heritage Moulding Corporation

910-428-4555

1/2 Scale

1/2 Scale



HMC-4500
(11/16" x 3/4")

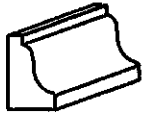

HMC-4510
(1/2" x 7/8")



HMC-4520
(5/8" x 7/8")



HMC-4530
(11/16" x 7/8")

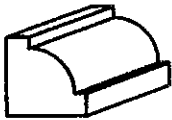

HMC-4540
(7/8" x 7/8")

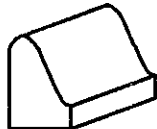

HMC-4550
(11/16" x 1-1/16")

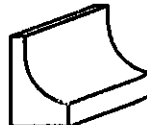

HMC-4560
(5/8" x 1")

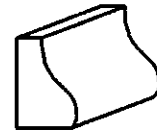

HMC-4570
(11/16" x 1")

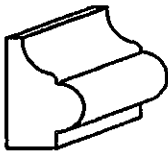

HMC-4580
(7/8" x 1-1/4")

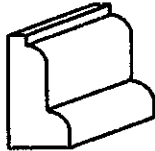

HMC-4590
(11/16" x 1-1/4")

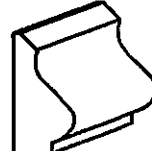

HMC-4600
(11/16" x 1-3/8")

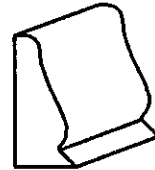

HMC-4610
(11/16" x 1-1/2")

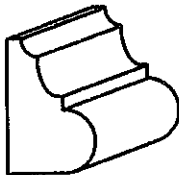

HMC-4620
(1" x 1-1/2")

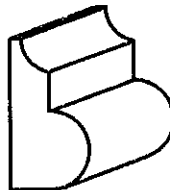

HMC-4630
(7/8" x 1-11/16")



HMC-4640
(3/4" x 1-3/4")

BASECAP1

Custom sizes and shapes available

BASECAP1

Heritage Moulding Corporation

910-428-4555

1/2 Scale

1/2 Scale



HMC-4650
(3/4" x 1-3/4")

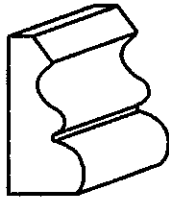

HMC-4660
(7/8" x 1-13/16")



HMC-4670
(3/4" x 1-13/16")

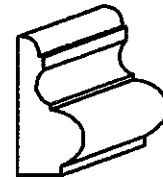

HMC-4680
(3/4" x 1-5/8")



HMC-4690
(9/16" x 3/4")



HMC-4700
(11/16" x 1-1/16")



HMC-4720
(9/16" x 1-1/4")

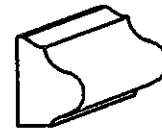

HMC-4730
(3/4" x 1")



HMC-4710
(3/4" x 3")



HMC-4740
(1" x 2")



HMC-4750
(5/8" x 7/8")

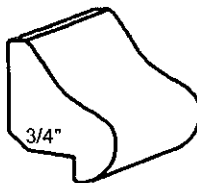

HMC-4760
(1-3/16" x 1-1/2")

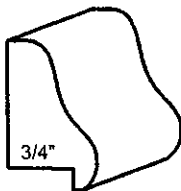

HMC-4770
(1" x 1-11/16")

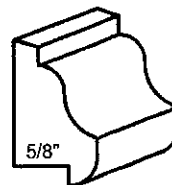

HMC-4780
(1" x 1-5/8")

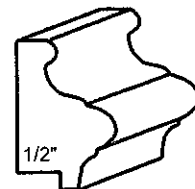

HMC-4790
(1-1/8" x 1-5/8")

BASECAP2

Custom sizes and shapes available

BASECAP2

Heritage Moulding Corporation

910-428-4555

1/2 Scale

1/2 Scale

Drip Caps

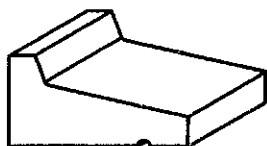

HMC-5300
(1" x 2")



HMC-5310
(1-1/8" x 2")

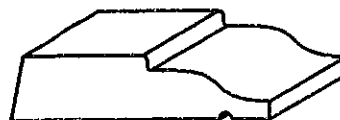

HMC-5320
(3/4" x 2-7/8")

Apron

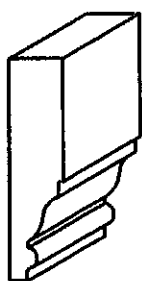

HMC-5100
(5/8" x 2-1/2")

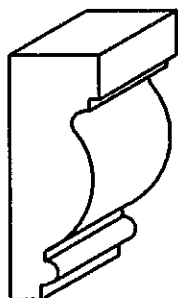

HMC-5110
(1" x 2-3/4")

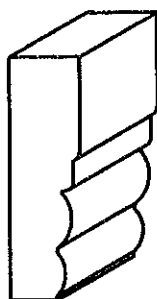

HMC-5120
(3/4" x 2-3/4")

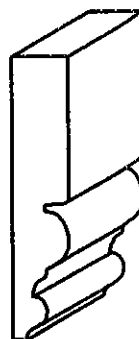

HMC-5130
(5/8" x 3-3/16")

Brick Mould

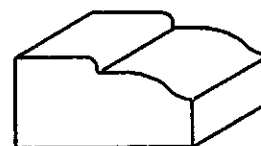

HMC-5200
(1" x 2")

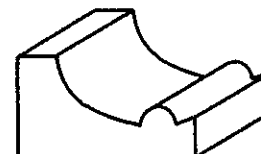

HMC-5210
(1-1/8" x 2")

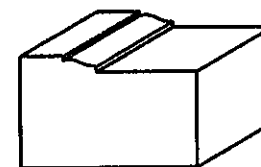

HMC-5220
(1-1/4" x 2")

Window Stool

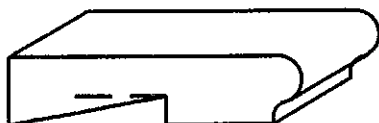

HMC-5000
(3/4" x ?)

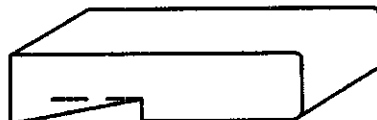

HMC-5010
(3/4" x ?)

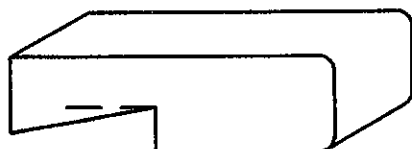

HMC-5020
(1-1/16" x ?)

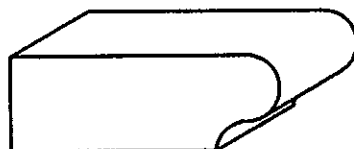

HMC-5030
(1-1/16" x ?)

WINDOW1

WINDOW1

Custom sizes and shapes available

Heritage Moulding Corporation

910-428-4555

1/2 Scale

1/2 Scale

Rosette

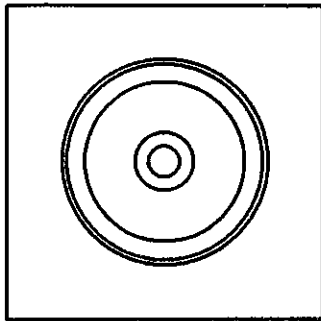

Various designs available

Shingle Mould

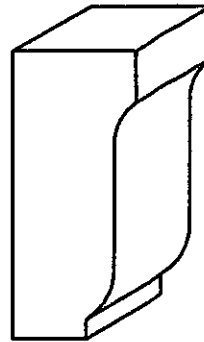

HMC-5400
(1-3/8" x 3-1/4")

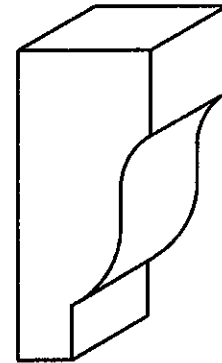

HMC-5410
(1-1/2" x 3-1/2")

Parting Bead

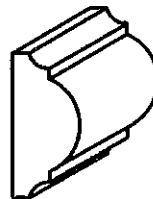

HMC-5500
(3/4" x 1-5/8")



HMC-5510
(5/8" x 1-3/4")

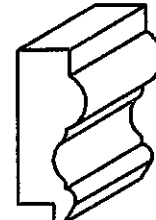

HMC-5520
(3/4" x 2")

Mullion



HMC-5600
(3/4" x 1-1/4")



HMC-5610
(3/8" x ?)

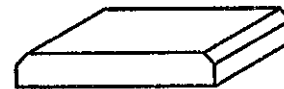

HMC-5620
(3/8" x ?)



HMC-5630
(3/8" x ?)



HMC-5640
(3/8" x 1-1/8")



HMC-5650
(13/16" x 3-1/2")

WINDOW2

WINDOW2

Custom sizes and shapes available

Heritage Moulding Corporation

910-428-4555

1/2 Scale

1/2 Scale



HMC-7000
(1-3/8" x 2-1/4")

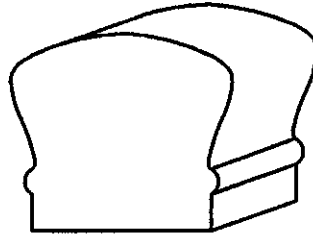

HMC-7010
(2-1/4" x 2-1/2")

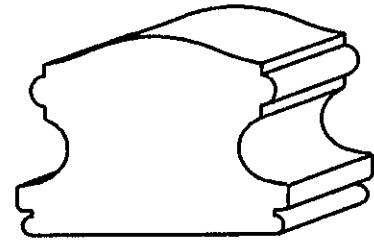

HMC-7020
(3" x 2-1/4")

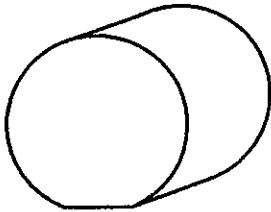

HMC-7030
(1-1/2", 2", 2-1/2", 3")

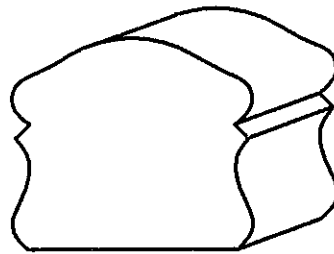

HMC-7040
(2-3/4" x 2-1/2")

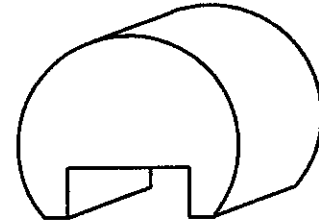

HMC-7050
(2-1/2" x 2-1/16")

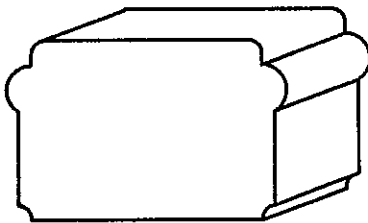

HMC-7060
(3-1/8" x 2")



HMC-7220
(1/4" x 1-1/4")



HMC-7200
(1" x 3")



HMC-7210
(3/4" x 2-1/2")

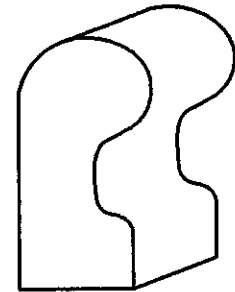

HMC-7070
(1-1/2" x 2-13/16")

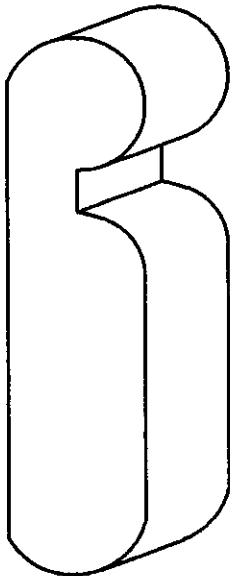

HMC-7080
(1-1/2" x 6")

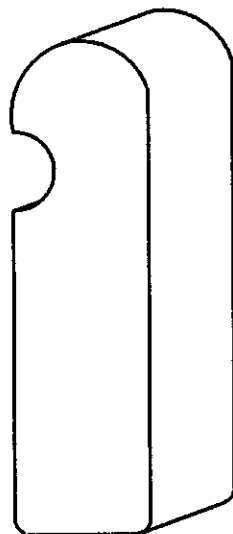

HMC-7090
(1-1/2" x 5-1/2")

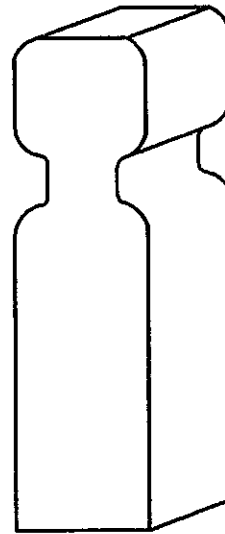

HMC-7100
(1-1/2" x 5-1/2")

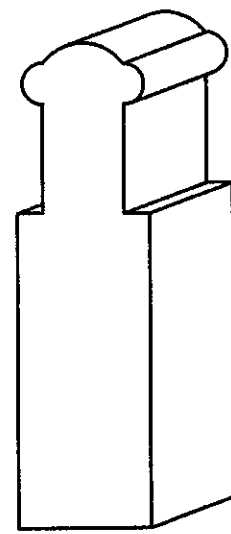

HMC-7110
(1-1/2" x 5-7/16")

HANDRAIL1

HANDRAIL1

Custom sizes and shapes available

Heritage Moulding Corporation

910-428-4555

1/2 Scale

1/2 Scale

Threshold

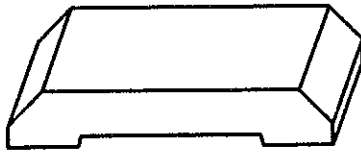

HMC-7400
(5/8" x ?)

Breast Plate

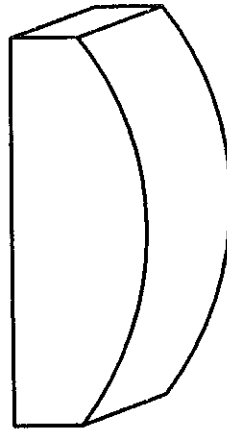

HMC-15310
(1-1/2" x 4-3/8")

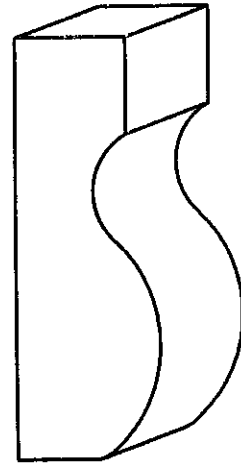

HMC-15100
(1-5/8" x 4-3/4")

Landing Tread

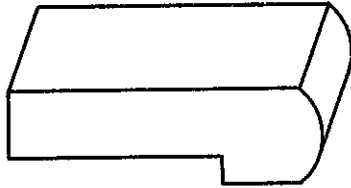

HMC-7500
(1-1/16" x ?)

Door Jamb

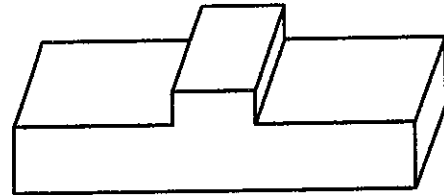

HMC-8620
(1-1/8" x 4-9/16")

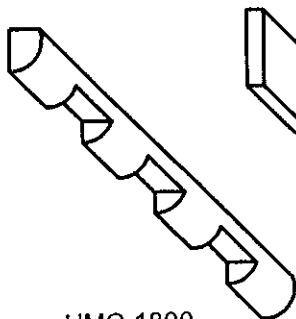

HMC-1800
(7/16" x 5/8")

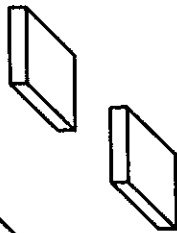

HMC-1820
(1/4" x 1" x 1-1/8" - each block)

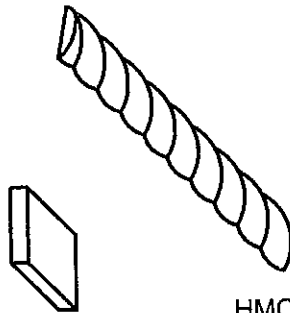

HMC-1830
ROPE

Panel Mould

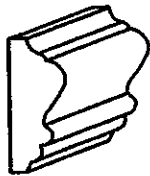

HMC-8500
(5/8" x 1-1/2")

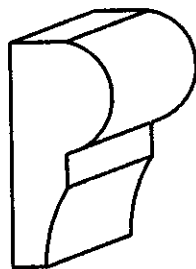

HMC-8520
(1-1/8" x 2-1/2")



HMC-8530
(5/8" x 2-3/16")



HMC-8540
(15/16" x 2-3/8")

MISC1

MISC1

Custom sizes and shapes available

Heritage Moulding Corporation

910-428-4555

1/2 Scale

1/2 Scale

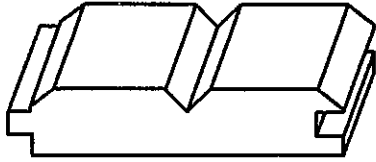

HMC-8000
(3/8" x 1-3/4" - face exposure)
(3/8" x 3-1/2" - face exposure)
(3/8" x 4-1/2" - face exposure)
(3/8" x 5-1/2" - face exposure)

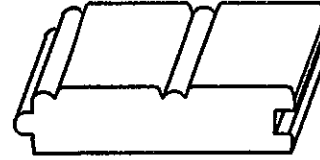

HMC-8010
(3/4" x 3" - face exposure)
(3/4" x 4-7/8" - face exposure)

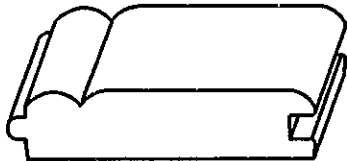

HMC-8020
(3/4" x 3-1/4")
(3/4" x 5-1/4")

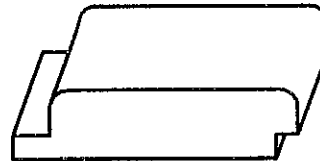

HMC-8030
(3/4" x 3" - face exposure)
(3/4" x 4" - face exposure)
(3/4" x 5" - face exposure)

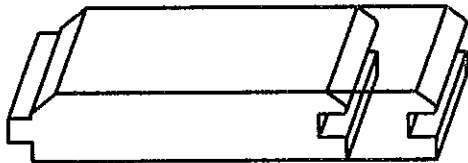

HMC-8040
(3/8" x ?)

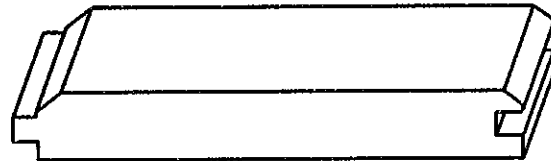

HMC-8050
(3/4" x ?)

PANELLING1

Custom sizes and shapes available

PANELLING1

Heritage Moulding Corporation

910-428-4555

1/2 Scale

1/2 Scale

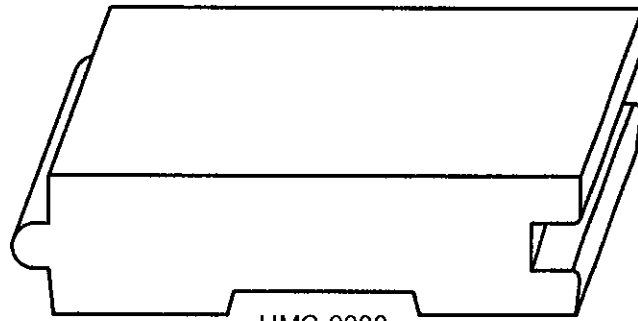

HMC-9000
(25/32" x 3")

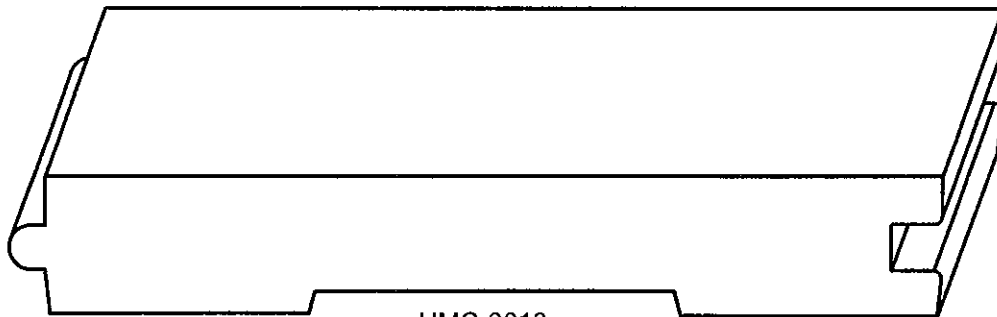

HMC-9010
(25/32" x 5")

FLOORING1

FLOORING1

Custom sizes and shapes available

Heritage Moulding Corporation

910-428-4555

1/2 Scale

1/2 Scale



HMC-15200
(3/4" x 5/8")



HMC-15210
(3/4" x 1")



HMC-15220
(3/4" x 1 1/4")

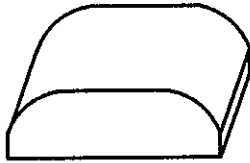

HMC-15230
(3/4" x 2 3/8")

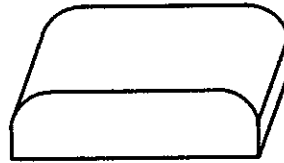

HMC-15240
(3/4" x 2 3/4")



HMC-15250
(3/4" x 3/4")



HMC-15260
(3/4" x 1 3/16")

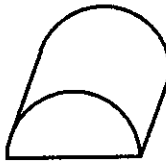

HMC-15270
(3/4" x 1 1/2")

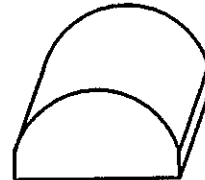

HMC-15280
(1" x 1 7/8")



HMC-15290
(13/16" x 2")



HMC-15300
(13/16" x 3")

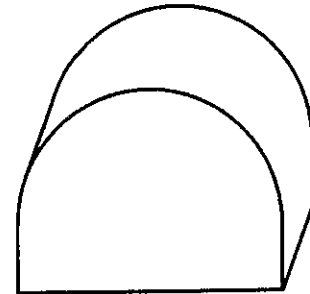

HMC-15310
(3" x 2-1/4")

ROUNDS1

ROUNDS1

Custom sizes and shapes available