

Sun City Woodworker Guild - Library Computer

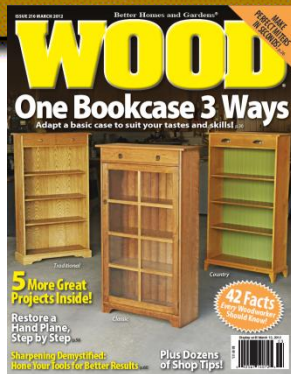
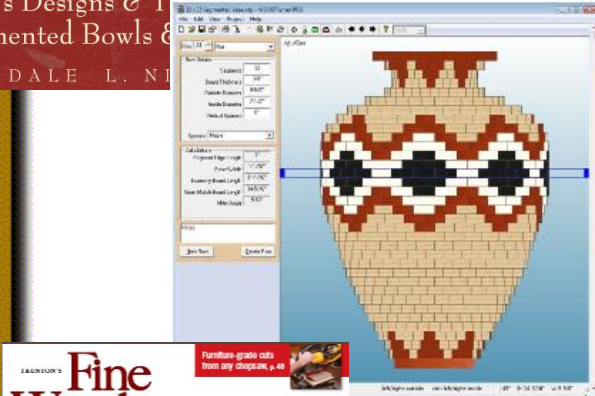
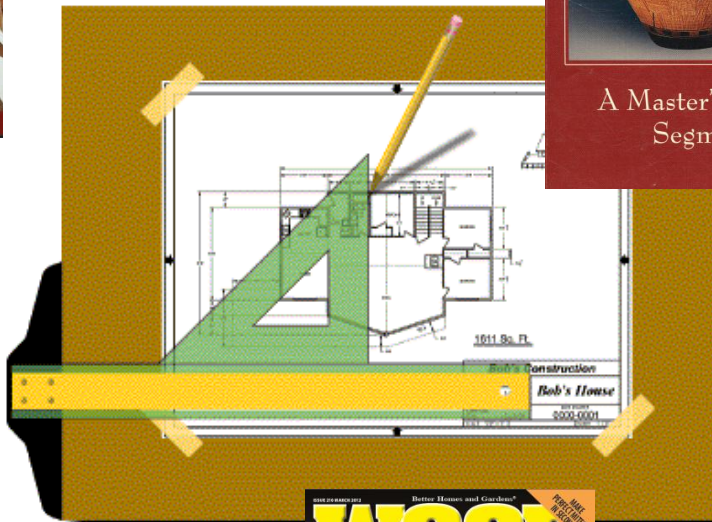
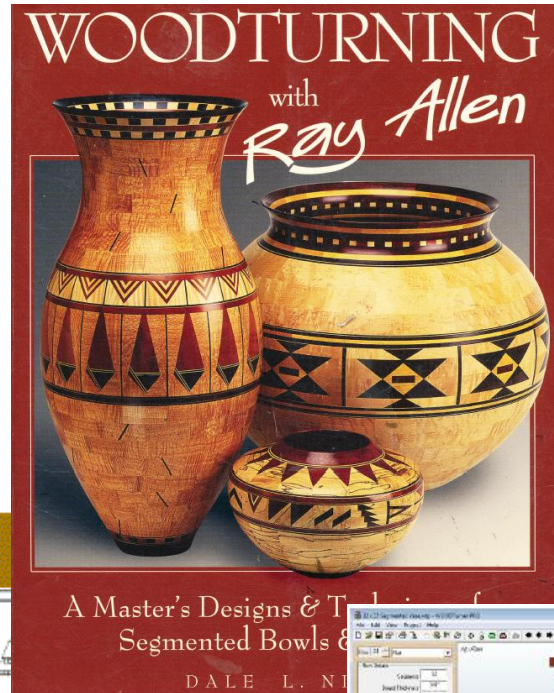
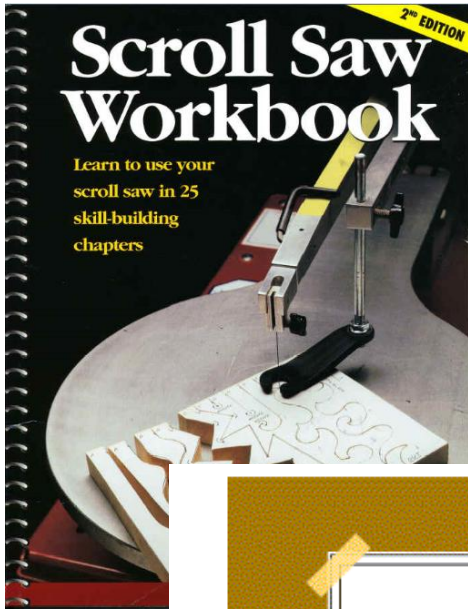

Sun City Woodworker Guild - Library Computer

Index of Programs Installed

- Safety and other woodworking Videos
- Scroll Saw Workbook
- Woodturning with Ray Allen
- Microsoft Office (Word, Excel, Access, Power Point)
- Delta CAD
- Google Sketchup 8
- Woodturner Pro
- Lamination Pro
- 3D Design Pro
- Project Plans
- Wood Magazine (1984 to 2013)
- Woodsmith - 100 Tips
- Fine Woodworking Magazine (1975 to 2013)
- Woodworkers Journal Magazine (1977 to 2013)
- New Member Cluster Lesson Plans
- e-Books for Woodworking
- American Woodturner Magazine (1986-2006)

Index of Programs Installed (Continued)

- Today's Woodworker Magazine (1989 - 1997)
- Popular Woodworking Magazine (1995 - 2010)
- Scroll Saw Woodworking & Crafts (2000 - 2012)
- Woodworking Magazine (2004 - 2009)
- American Woodworker Magazine (1985 - 2014)
- Woodsmith Magazine (1979 - 2014)
- Shop Notes Magazine (1992 - 2014)
- Workbench Magazine (1957 – 2009)
- Ted's Woodworking Web Site
- Woodworkers Guild of America – The Complete Guide to Wood finishing

Safety and other Woodworking Videos

The woodshop Safety Administrator produces safety videos on various topics. All videos in the series are in this folder. View them at your leisure.

There is also a link to these videos on the Woodworker's Web page.

In addition to safety videos, various informative videos are included.

Scroll Saw Workbook

Learn to use your scroll saw in 25 skill-building chapters.

Each exercise has an "Objective." The objective explains what we want you to learn in this exercise. Note each objective before starting so you will know exactly what you will be doing in each exercise.

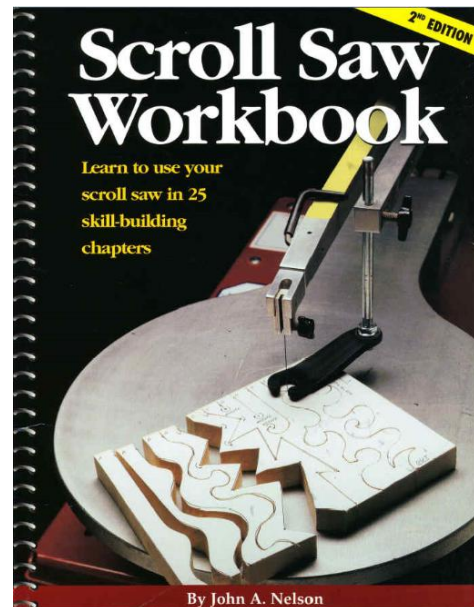

After studying the exercise, select and prepare the wood and or materials needed for the exercise. Follow each step in the exercise in the order given.

When completed, compare your finished exercise with the "objective."

Woodturning with Ray Allen

This book provides a glimpse of Mr. Allen's work. He discusses tools and techniques.

There are many pictures of his work.

He provides some patterns and gives simple design assistance.

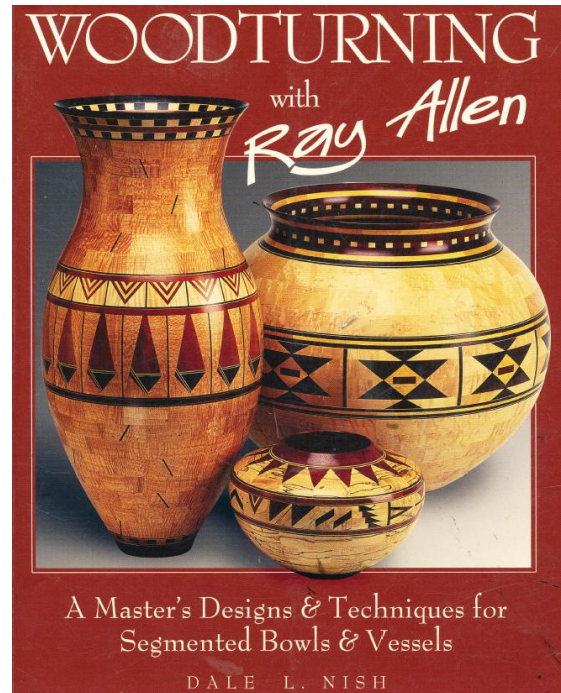

CHAPTER 5
Bowl Plans

HALF DIAMOND/BLOCK

SECTION	DIAMETER	#PCS.	THICKNESS	LENGTH	WIDTH	ANGLE*
1	2.875	16	.250	.564	.750	11.25
2	3.00	16	.250	.589	.750	11.25
3	3.37	16	.625	.662	1.00	11.25
4	4.375	16	.625	.859	1.25	11.25
5 dark	5.375	16	.500	.263	1.50	5.625
5 light		16	.500	.791	1.50	5.625
6 dark	6.75	16	.500	.662	1.50	5.625
6 light		16	.500	.662	1.50	5.625
7 dark	8.25	16	.625	1.215	1.75	5.625
7 light		16	.625	.405	1.75	5.625
8	8.375	16	.125	1.644	1.125	11.25
9	8.875	16	1.125	1.742	1.00	11.25
10	8.375	16	.125	1.644	1.00	11.25
11	8.250	16	.750	1.620	2.50	11.25
12	6.250	1	.750	Solid stock-base		

WOODTURNING WITH RAY ALLEN 113

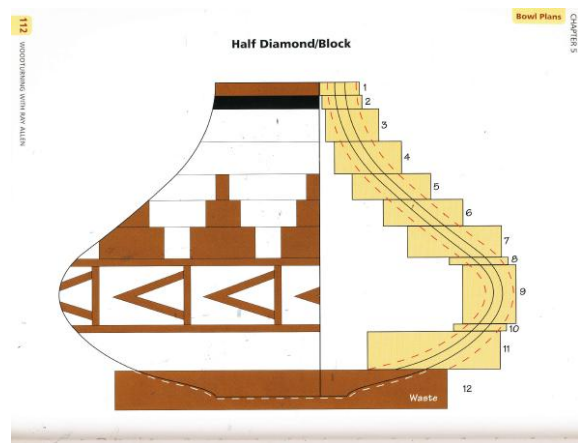

Microsoft Office

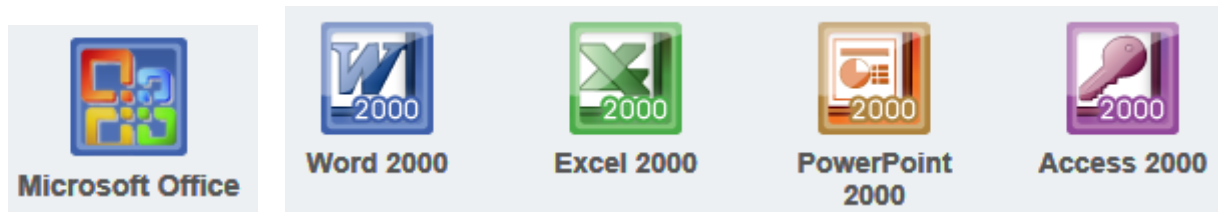

Microsoft Office suite of programs is available for Guild members use on this computer.

Programs in the suite are

- Word - creates text documents
- Excel - a spreadsheet program
- Power Point - a presentation program
- Access - a database program

Delta CAD

Delta Cad® is a powerful, easy to learn CAD (Computer Aided Design) program designed to meet all of your CAD needs. It can produce accurately scaled architectural or mechanical drawings, or just pretty pictures to paste into your favorite word processor. Delta Cad is more than just a paint program, because you can edit, scale, move, rotate, copy, etc. individual objects, not just paint pixels. DeltaCad allows you to zoom in to draw fine details or zoom out to see the whole drawing.

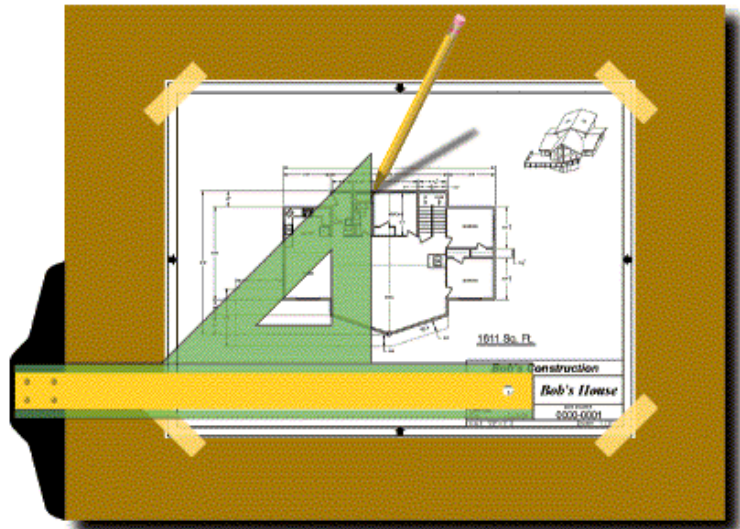

Advance training is available. Look in the large white advance training sign up book.

Google Sketchup

SketchUp



Google SketchUp is an easy to use application that will help you learn to create 3D models of houses, sheds, decks, home additions, woodworking projects – even space ships.

You can add details, textures and glass to your models, design with dimensional accuracy, and place your finished models in Google Earth, share them with others by posting them to the 3D Warehouse, or print hard copies.

Google SketchUp is a great way to discover if 3D modeling is right for you.

SketchUp includes these tools:

- Drawing and modifying geometry: Polygon, Follow Me, Offset, and Intersect with Model.
- Construction: Dimension, Tape Measure, Protractor, Section Slice, Layers, Area & Length Calculation.

Using SketchUp you can: Draw, modify, measure, rotate, and scale geometry. Place section slices to view and work on model interiors. Add pre-made textures to your models, or create new ones.

Woodturner Pro

Woodturner Pro has been designed for ease of entering and modifying ring details and displaying results in a visual as well as a printed output. As you add rows of rings to your drawing, you can specify the wood species which will paint each segment in that ring using a photo image file. Dozens of species are included in the software.

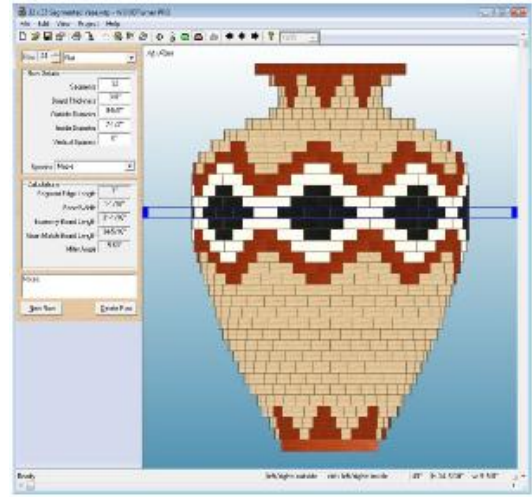

Arrow keys give you a quick way to modify ring diameters and navigate between the rings. Toolbars give you quick access to aids such as grid lines, glue surface widths and wall profiles. The calculations window shows the exact segment cutting instructions necessary to create a ring of the specified dimensions.

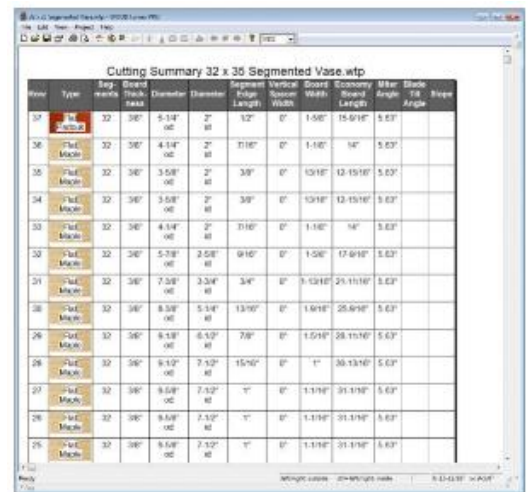

Row	Type	Seg-ments	Start Thick (mm)	Diameter	Thickness	Segment Edge Length	Vertical Splice Width	Start Width	End Width	Geometry Start Length	Angle	Slide Angle	Flip
32	Flat-Misc	32	36"	8.54" OC	2" H	12"	0"	1.08"	15.816"	5.63"			
31	Flat-Misc	32	36"	4.14" OC	2" H	118"	0"	1.18"	14"	5.63"			
30	Flat-Misc	32	36"	3.58" OC	2" H	38"	0"	13.18"	12.1516"	5.63"			
29	Flat-Misc	32	36"	3.02" OC	2" H	38"	0"	13.18"	12.1516"	5.63"			
28	Flat-Misc	32	36"	4.54" OC	2" H	118"	0"	1.18"	14"	5.63"			
27	Flat-Misc	32	36"	5.78" OC	2.58" H	910"	0"	1.08"	17.816"	5.63"			
26	Flat-Misc	32	36"	7.28" OC	3.24" H	34"	0"	1.1816"	24.1516"	5.63"			
25	Flat-Misc	32	36"	8.58" OC	5.14" H	1370"	0"	1.0816"	25.816"	5.63"			
24	Flat-Misc	32	36"	8.58" OC	6.52" H	78"	0"	1.0816"	28.1516"	5.63"			
23	Flat-Misc	32	36"	9.12" OC	7.12" H	1570"	0"	1"	30.1516"	5.63"			
22	Flat-Misc	32	36"	9.68" OC	7.12" H	1"	0"	1.1816"	31.1516"	5.63"			
21	Flat-Misc	32	36"	9.68" OC	7.12" H	1"	0"	1.1816"	31.1516"	5.63"			
20	Flat-Misc	32	36"	9.68" OC	7.12" H	1"	0"	1.1816"	31.1516"	5.63"			

Lamination Pro

Lamination Pro is used in conjunction with Woodturner Pro. This program walks you thru multiple cuts of a single lamination to create segmented bowls feature rings.

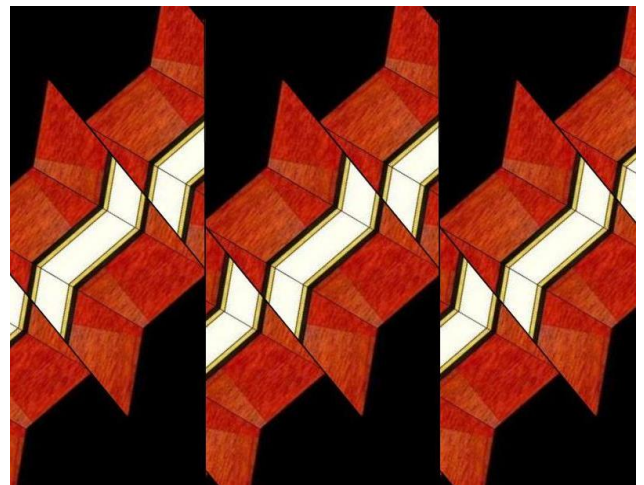
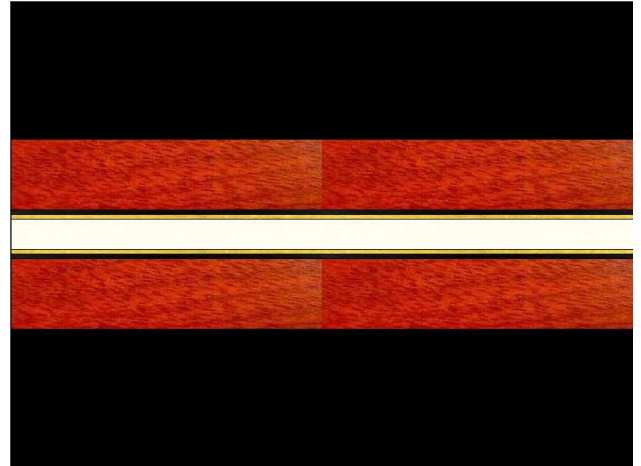

3D Design Pro

3D Design Pro is utilized in conjunction with Woodturner Pro. You can create 3D designs examine and modify in this software then import into Woodturner Pro.

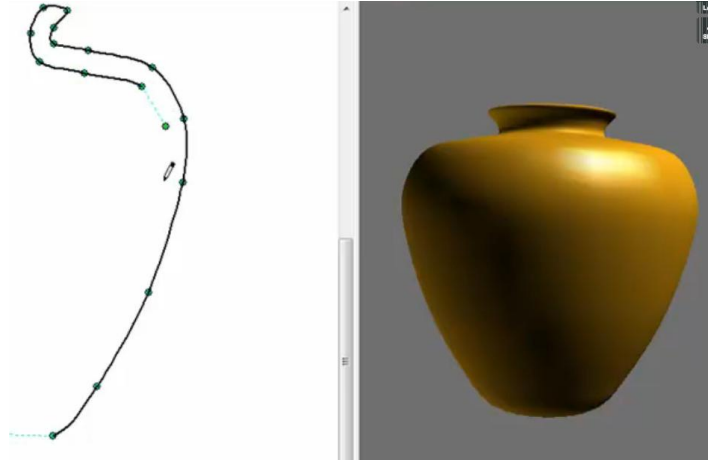

Project Plans

This folder in the computer holds hundreds of plans for all sorts of projects. Plans from various magazines are captured and saved in individual files. Simply click on a project that looks interesting to you and print out the plans.

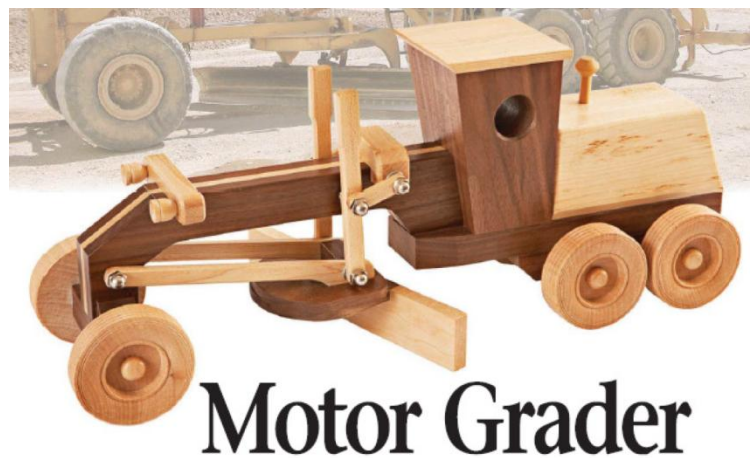
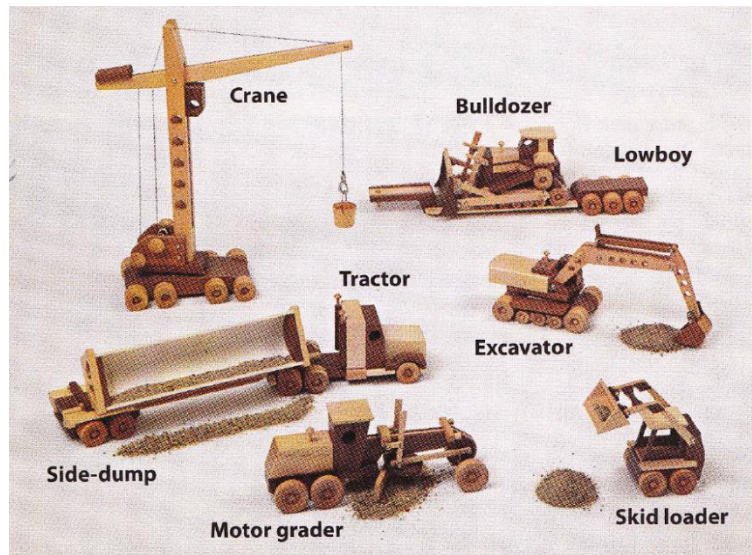

all-aboard animal train

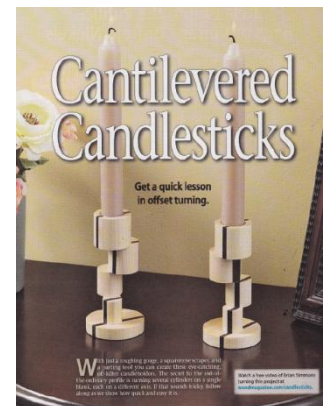
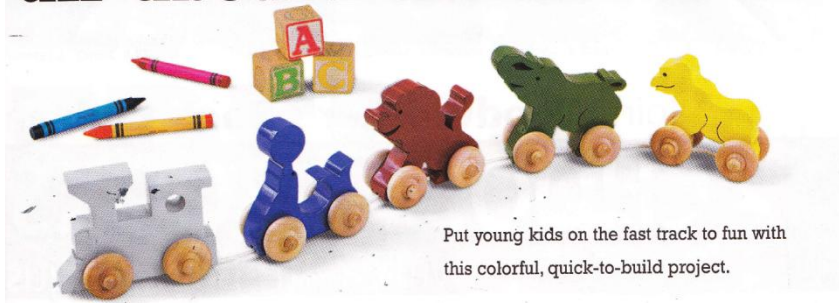

Wood Magazine (1984 to 2013)

The complete collection of Wood Magazine is contained in this easy to use program. All issues can be searched for a key wood, article or plan. When found, you can print out the specific article you want.

Navigating

There are several ways to navigate the issues on this disk:

1. Click on a selection on the following page to browse issues of the magazine.
2. Click on the **Article Index** link on the following page to search for a specific article.
3. Click on a bookmark in the panel, *left*, to jump directly to that article.

To page through an issue, click on the left and right arrows at the bottom of the Adobe

Reader window.

Searching

Enter a search phrase into Reader's **Find** field to jump to subsequent occurrences of that phrase. Or choose **Edit** then **Search**. Enter a phrase to show all occurrences of that phrase in the issue.

Printing

To print an article from this disc, locate the article and click on the first page of the article. Your print dialog box should appear with the proper page-range fields pre-populated.

Note: Choosing the **Print** command from the **File** menu *without* entering a page range will print *all* of the pages in the issue. Also, due to variances in printers, full-size patterns may not print at exactly 100 percent. Double-check pattern dimensions against the project article, and rescale drawings if necessary to match those dimensions.

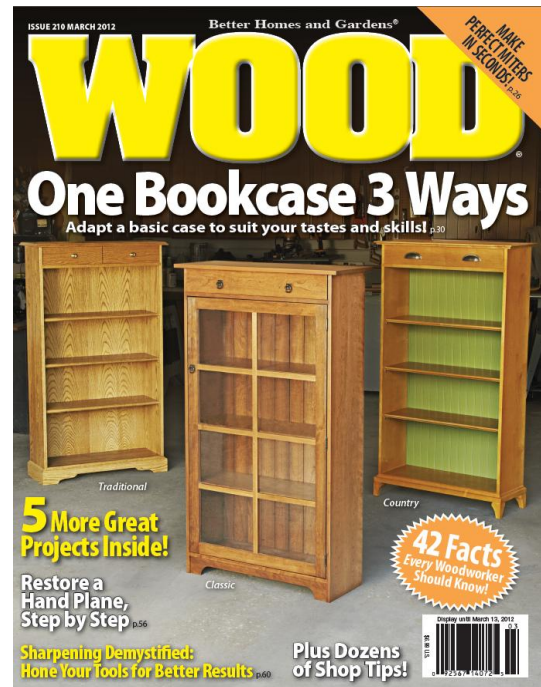

Woodsmith - 100 Tips

This program contains 100 woodworking tips, 10 how to videos, and 10 table saw jig plans with full color photos and illustrations

The banner features a navigation bar with links for HOME, TIPS, VIDEOS, FREE E-TIPS, WOODSMITH MAGAZINE, and WOODSMITH SHOP on TV. The main headline reads "100+ BONUS WOODWORKING TIPS" in large, bold letters. Below the headline is a large image of a wooden jig on a table saw. Three columns of text and images are arranged below the main image:

- 100 BONUS TIPS**: Accompanied by a small image of a person using a table saw. Below the image is the text "View the bonus tips" and a copyright notice "©2011 August Home Publishing Company".
- 10 HOW-TO VIDEOS**: Accompanied by a small image of a person using a jig on a table saw. Below the image is the text "View the how-to videos".
- 10 TABLE SAW JIG PLANS**: Accompanied by a small image of a wooden jig on a table saw. Below the image is the text "View our website for free plans".

On the right side of the banner, there are two video thumbnails:

- The top video thumbnail shows a person using a router on a wooden surface. Below it is the text: "VIDEO: Get Free Woodworking Tips delivered to you by Email each week. Sign up for Free Woodsmith eTips".
- The middle video thumbnail shows a stack of Woodsmith magazine covers. Below it is the text: "VIDEO: About Woodsmith magazine. Learn More about Woodsmith Magazine, Books, & Plans".
- The bottom video thumbnail shows a man, Don Peschke, standing next to a wooden cabinet. Below it is the text: "VIDEO: Don Peschke, publisher of Woodsmith, invites you to tune in to the Woodsmith Shop TV show. WoodsmithShop.com".

Fine Woodworking Magazine (1975 to 2013)

All 237 issues of Fine Woodworking Magazine are contained in this program.

Get every copy of Fine Woodworking magazine (Issues 1- 237 – that’s 38 years!) in one small searchable DVD. Do you ever want to find an article but

can’t remember what issue it was in? Well, this DVD will find it for you. Then you can read the article on the computer, print it out, save it to your favorites, or find your copy of the magazine and read the hard copy. The

2011 Fine Woodworking Archive DVD-ROM (1975 – 2013) has every page of every Fine Woodworking issue at your fingertips – it even includes the advertisements!

This is a great resource to have in or near your shop. I use it all the time to find things we’ve written about over the years.



Woodworkers Journal Magazine (1977 to 2013)

Browsing An Issue

You can simply browse a single issue like you would in your own library. Click on a selection you are interested in on the following page, and it will open automatically in Adobe Reader. Use the up/down or left/right arrow buttons in Adobe Reader to move through pages sequentially.

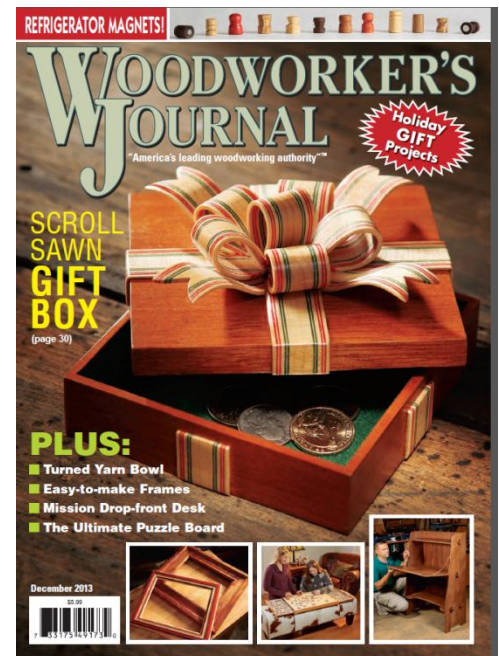

• Using the Bookmarks

The Bookmarks panel to the left will take you to a specific issue or article.

• Searching Issues

You can search all issues in this collection for topics or keywords by clicking any link labeled "Search", either in the Bookmarks bar at left or on the following page. This is a large collection of files, so searches can take some time. For faster, more efficient searches, make sure the "Whole words only" box is checked in the search window. Type in what you are looking for, and the search engine will show you the results. Click on the result and the search engine will display the article on your screen in Adobe Reader. You can access files as they appear in the search window while you wait for more articles to appear.

New Member Cluster Lesson Plans

New members are instructed on the safe use of all equipment in the woodshop. During each cluster class, a handout is provided to each student. The handouts are assembled here if you need to revisit them.

CLUSTER 1 – TABLE SAWS

STUDENT HANDOUT

GENERAL INFORMATION

Woodshop hours of operation: 9:00 a.m. - 4:30 p.m. Monday, Wednesday, Friday and 1:00 p.m. - 4:30 p.m. Saturday.

Safety glasses are required at all times while in the woodshop

The Woodworkers Guild is a 100% volunteer organization! Each of you are being ask to volunteer – if possible 4 hours a month. Clipboards are located on the display case in the front office for you to sign up for the following volunteer positions:

-) Front desk receptionist
-) Tool room monitor
-) Shop manager (must pass qualifications)
-) Assistant shop manager
-) Mentor (must pass qualifications)
-) Maintenance (every Saturday 8:30-11AM)

Woodworker and Modelmaker Guild Web Page - www.schhca.org

Reference materials available – Machine tools manufacturer's manuals, woodworking books, DVD's, magazines and VHS tapes available in the woodshop library. DVD and VHS viewing equipment is also available.

Advance classes are available – see signup book in the woodshop library

If you have completed all cluster classes, place your white member training badge in BoD Secretary's Mail Slot in the credenza to the right of the front door as you exit. Your new gold badge will be placed in the badge storage case to the right of the machine room entrance door, usually within 10 days. Should you wish to visit the shop before the gold badge is issued, you may bring your signed "Woodworkers Class Record & Receipt" (yellow copy) to the shop for admittance.

During the Class

SAFETY

If someone is injured serious enough to require medical attention – including the instructor, the cluster class instructor will assign a student at the beginning of this class to place the calls listed on the wall chart. **THESE CALLS ARE MANDATORY.** The phones are located right outside the library room, in the front office and next to the restroom.

UNDER NO CIRCUMSTANCES IS THE INSTRUCTOR OR ANY STUDENT TO TRANSPORT THE INJURED PERSON TO THE HOSPITAL OR IMMEDIATE CARE FACILITY. By doing this one assumes a liability. Emergency Response 911 has the training and equipment to facilitate transportation to a hospital if required.

- 1) Follow the accident procedures posted above the sink in the machine room next to the restroom
- 2) Open the overhead garage door next to the dog park for the emergency personnel to enter
- 3) Station a student in the parking lot to direct the emergency personnel thru the overhead door
- 4) From the accident investigation kit (located in the Shop Managers podium) place yellow tape 10 feet around scene
- 5) Do not move anything or mop up any blood

Anytime while in the shop

A HEART DEFIBRILLATOR is available (located on the machine room wall adjacent to the restroom door). It is extremely easy to use and needs no operational class. An instructional DVD is available in the library.

CLUSTER 1

TABLE SAW

PREPARATION (WHAT YOU WILL NEED)

Eye Protection (mandatory) & Ear Protection (optional)	Practice stock
Safety First – Accident Procedure Poster	6" combo square & angle cube
INCRA (lt. & rt.) & STD miter gauges	Rip fence stop block
Combo, ripping & fine tooth blades	Sled
Variety of push sticks	Feather boards
	Thin-rip jig

Introduction to the Table Saw

The table saw is one of the most used machines in the woodshop. Almost every project will require its use. Used improperly it can also be one of the most dangerous. Proper use, however, will provide a safe and effective tool.

Controls

Point out and explain controls to students

1. Blast gate.
2. Power switch
3. Blade Guard
4. Throat plate
5. Splitter / Riving knife (**critical**)
6. Depth-of-cut hand wheel raises or lowers the blade to properly accommodate the cut.
7. Tilt hand wheel tilts the blade to make angle cuts on material.
8. Miter gauge: The miter gauge can also be used on either side of the blade.
9. Ripping fence (used when ripping material)
 - A. Locking lever
 - B. Can be used on either side of blade

General Safety

- > Proper Apparel – loose clothing, dangling jewelry, long hair, etc. has the potential to attract moving machine parts. No gloves while operating machines.
- > Keep work area clean – clean up as you go and when you are done.
- > Turn power off & never leave a machine or remove material until machine comes to a complete stop.
- > Insure material work piece is secure.
- > Insure machine is unplugged before changing blade or splitter
- > Stay attentive and focused whenever machine is running (where are your fingers?).
- > Your safety and the safety of others in the shop is your responsibility.

e-Books for Woodworking

Woodworking books in PDF format are contained in the "Documents/Books" folder. You will find dozens of books on:

- Making toys
- Turning bowls
- Making wooden puzzles
- Making wooden boxes
- Intarsia
- Making picture frames
- Outdoor projects
- Making pens

and many other topics

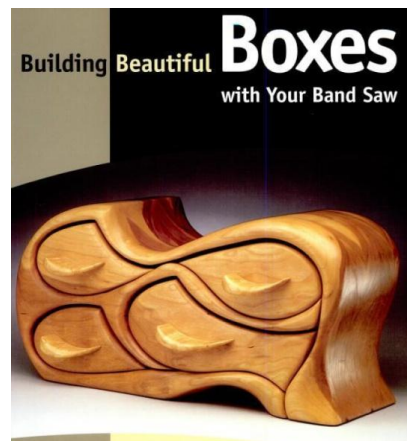
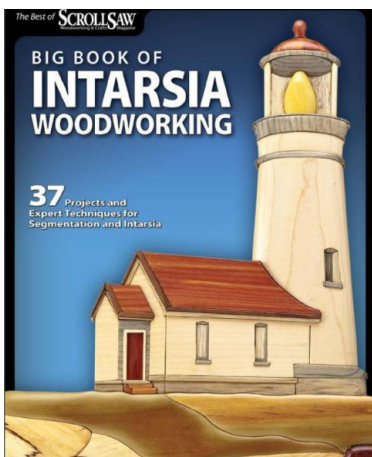
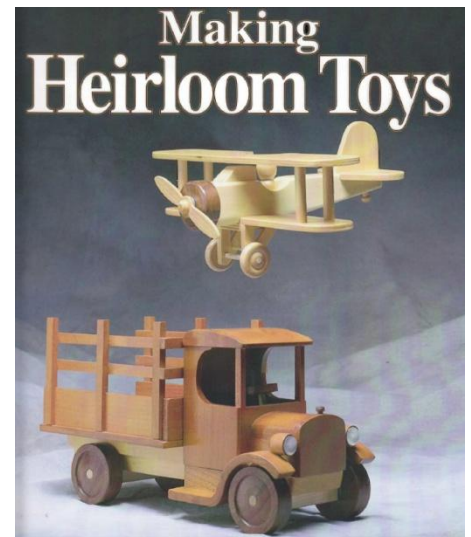
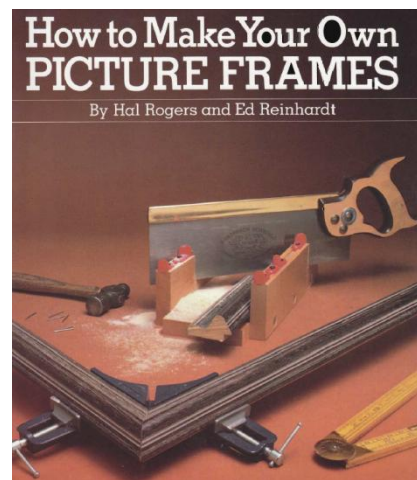

American Woodturner Magazine 1986-2006

This is the official magazine of
The American Association of
Woodturners.

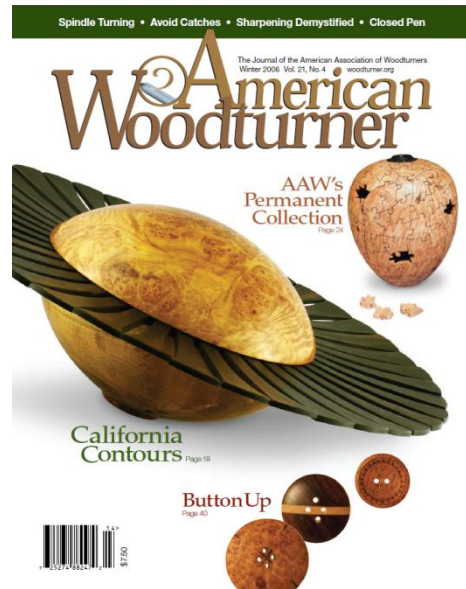

Turning in 2010 • Grinding Gouges • Alabaster Gallery • Parent & Child Class



The write stuff
Pen turners have taken their creativity to new levels with innovative techniques, shapes, and an array of materials. Turn to page 36 for details on this soaring interest group.

Instant Gallery

Overland Park

Here are more pieces that John Jordan and Arthur and Jane Mason crafted at the Overland Park symposium. To view other images from the Instant Gallery visit woodturner.org and click on the "Symposium" link.



"Gleaming Medusa" by Gary Sanders of Greenville, Texas. John Jordan noted that "the contrast of the stand is perfect." The handstop is not overdone. Gary showed restraint in all the right places."



"Stampede" by Molly Winton of Edmonds, Washington. "The division of space is interesting," Jane Mason noted. "It has nice proportions. I like the narrative. I like the figure running around a humped bowl. This is even more spectacular when viewed from above." John Jordan added, "This is a texture I haven't seen before. Well done with a nice feel to it. I would like to know more about the use of the horse imagery (Native American?) and how Molly relates to it."



"Salsa Set #20" by Dan Bailey of Fort Collins, Colorado. Set of 11 honey locust bowls. Arthur: "This is wonderful to have in your home." John: "This is as good as it gets." And from Jane: "This is a tour de force. Its reminder of a theater piece where everything fits so well."

THE AMERICAN WOODTURNER
THE AMERICAN ASSOCIATION OF WOODTURNERS

NEWSLETTER JUNE 1986

Dedicated To Providing

- EDUCATION
- INFORMATION
- ORGANIZATION

AMONG THOSE INTERESTED IN WOODTURNING.

Today's Woodworker (1989 - 1997)

All 57 issues from 1989 to 1998 (over 9 years) are contained in this collection. This magazine is no longer in print but contained over 200 woodworking projects ranging from toys, to shop jigs, to furniture - and more.

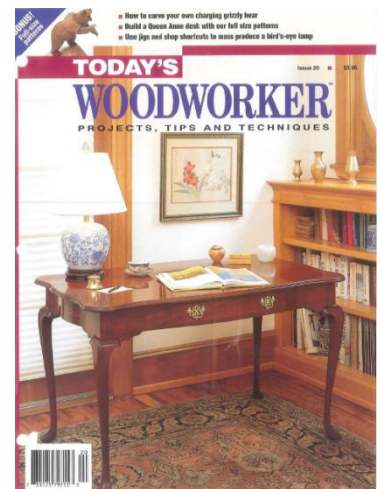
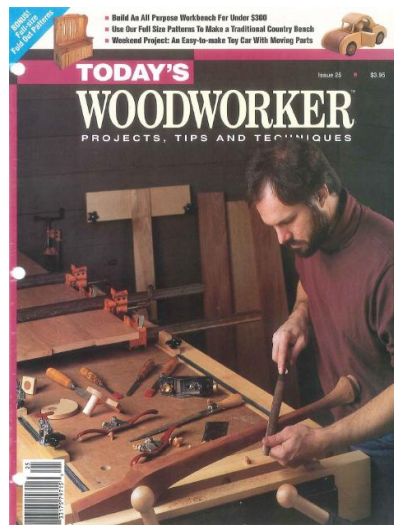
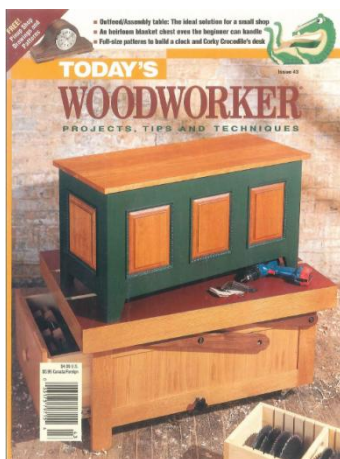
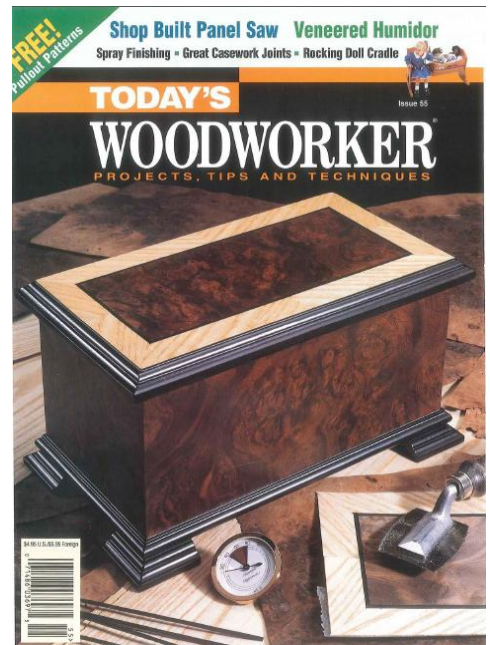

Popular Woodworking (1995 - 2010)

This collection contains over 250 plans for furniture, jigs, toys, and more. Step-by-step instruction and drawings for good-looking beginner builds to masterpiece projects.

As a bonus, there is also "Exercises in Wood-Working" a 1989 e-book.

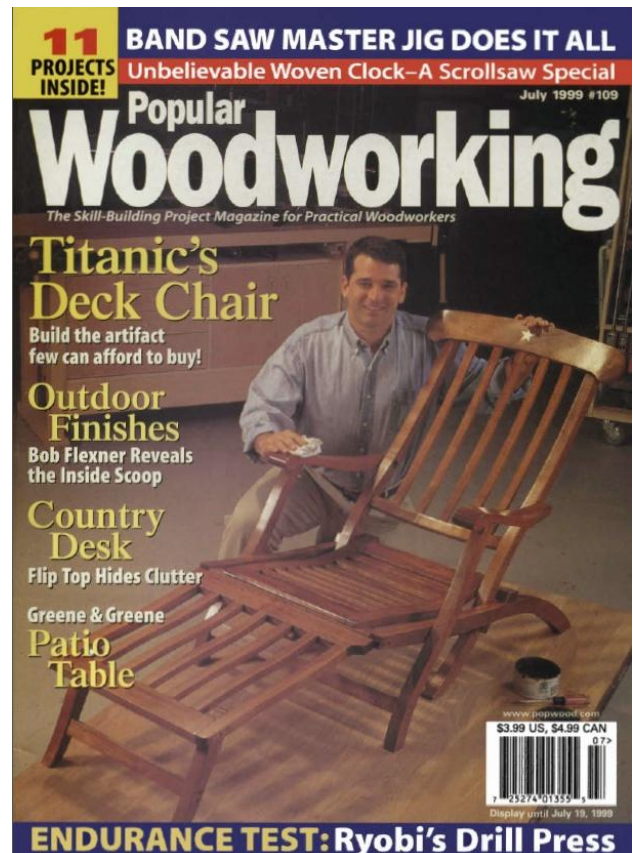
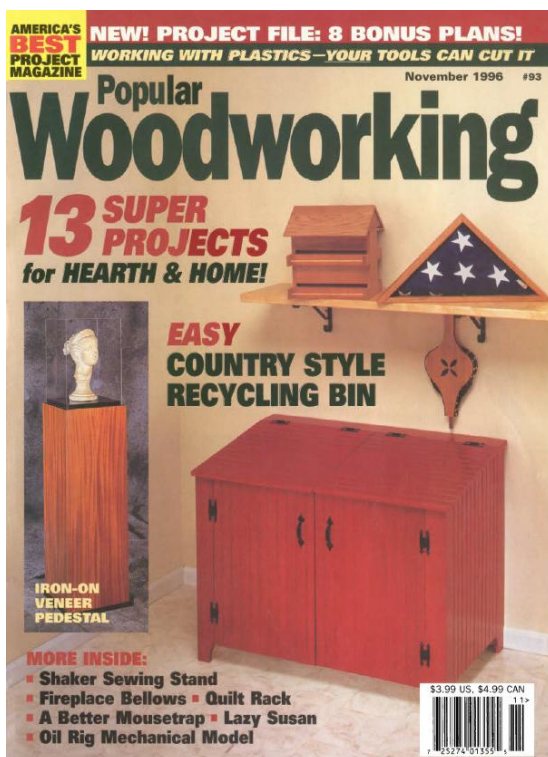

Scroll Saw Woodworking (2000 - 2012)

Issues from #1 in 2000 to the fall 2012 issue are available.

This magazine is the premier publication devoted to the art and hobby of scroll saw cutting and design.

Complete original page files are provided for every issue. Each pattern pull-out section of the original magazine has been reformatted for easy printing, and is included along with additional bonus patterns. All material is in searchable PDF format.

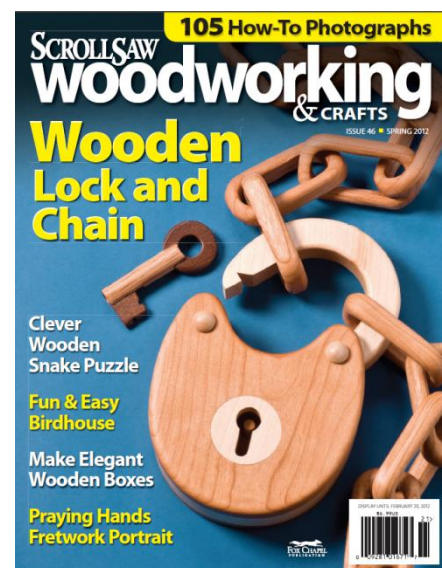
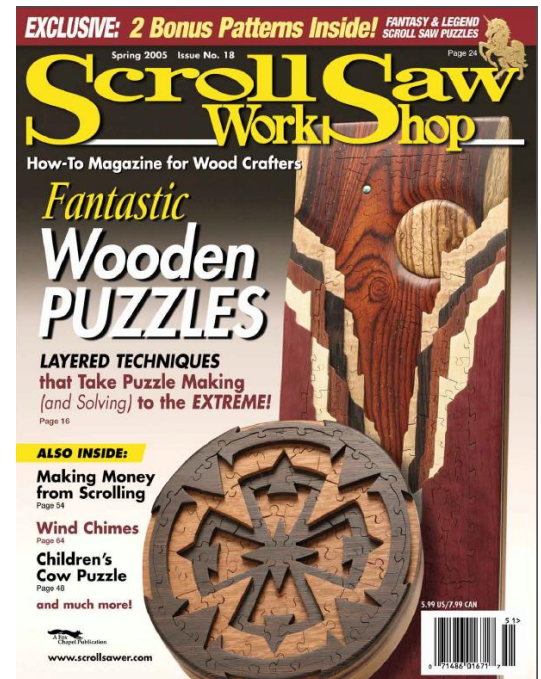

Woodworking Magazine (2004 - 2009)

Issues from #1 in 2004 to #16 in 2009 are available.

This magazine offers many tips and techniques to the experienced woodworker. There are no advertisements

All material is in searchable PDF format.

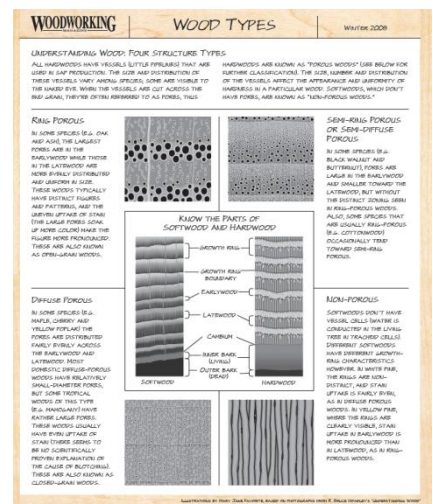
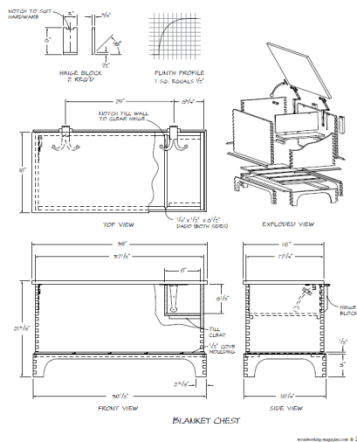

American Woodworker Magazine (1985 - 2014)

Originally titled The American Woodworker

Issues from #1 in 1985 to #173 in 2014 are available.

This magazine offers many tips and techniques to the experienced woodworker

All material is in searchable PDF format.



the American Woodworker

\$2.95

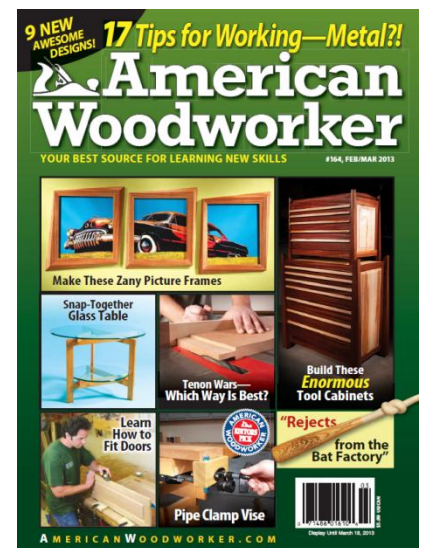
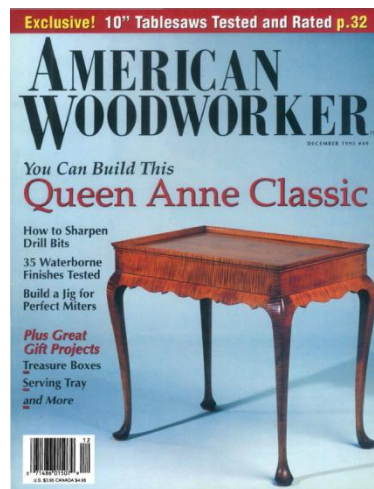

Woodsmith Magazine

(1979 - 2014)

Issues 1 thru 216 are available. 36 YEARS of the magazine woodworkers trust most.

Articles are fully searchable and printer friendly.

All material is in searchable PDF format.



Shop Notes Magazine

(1992 - 2014)

Issues 1 thru 138 are available.

13 YEARS of the sister companion to Woodsmith Magazine

Additionally, Guild members can access all issues on line from home by loading the following link into their internet browser:

<http://www.shopnoteslibrary.com/>

user name – See computer info book in library

password = See computer info book in library

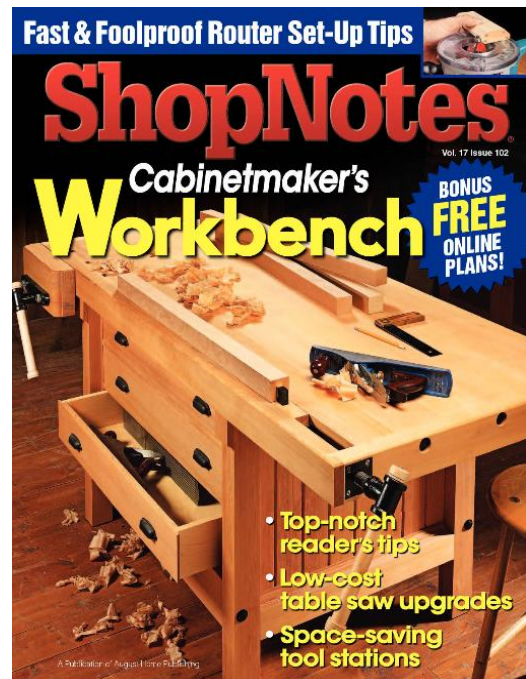

Workbench Magazine

(1957 - 2009)

Issues 1 thru 317 are available.

53 YEARS of this great magazine are available

Additionally, Guild members can access all issues on line from

home by loading the following link into their internet browser:

www.workbenchlibrary.com

user name - See computer info book in library

password = See computer info book in library

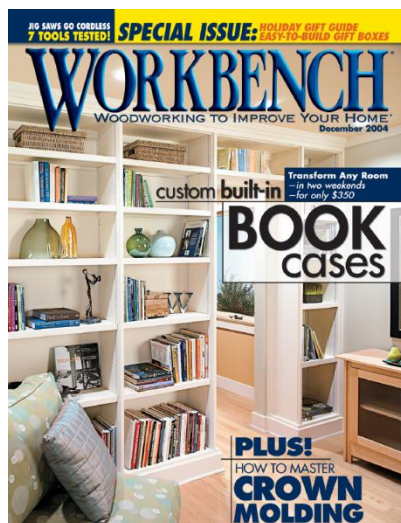

Ted's Woodworking

Web Page

What Your Membership Includes:

 <p>Lifetime Access To Everything With your single one-time purchase, you'll get lifetime access to the members area. <i>(as long as your account is active and not cancelled)</i></p> <p>There are no expiry dates, no recurring fees. You have the option to download the files in one go, or take as long as you like to download each section.</p>	 <p>Free Updates For Members Your membership doesn't simply include all the plans here. Every couple of months, we'll release new plans, drawings and we'll update the members page accordingly.</p> <p>You'll get an email notification and you can get back here to download the new plans.</p>
 <p>VIP Newsletter You get subscription to our premium VIP "members-only" newsletter. Our email newsletter contains free plans, techniques, woodworking guides, product reviews, interviews and much more!</p> <p>These will be sent periodically to the email address you've entered at the payment page. So do keep a lookout in your mailbox!</p>	 <p>Free Bonuses Every Month As long as you remain a member, you'll get free bonuses to download each and every month. You'll get an email notification once these bonuses are updated on your members hub.</p> <p>Free bonuses include books on woodworking techniques, new projects to try and other exciting resources you'll love!</p>

URL - <http://www.tedswoodworking.com/members/login>

User name - **See computer info book in library**

Password = **See computer info book in library**

Our membership includes

- Teds Handy Dad Plans
- Teds Vintage Woodworking Books
- Teds VIP Deluxe D Software
- Teds VIP Deluxe Woodworking Reference
- Teds Woodworking Guides
- Teds Woodworking Guides, Tips & Plans
- Teds Woodworking Monthly Bonus
- Teds Woodworking Plans from ZIPS
- Teds Woodworking TIPS
- Teds Handy Dad Plans\Bonus Books
- Teds Handy Dad Plans\Build Your Own - Projects For Kids
- Teds Handy Dad Plans\DIY Home Repair Collection
- Teds Handy Dad Plans\Gorgeous Toys You Can Make
- Teds Handy Dad Plans\The Big Book of 700 Boys Projects
- Teds Handy Dad Plans\The Big Book Of Science Projects
- Teds Handy Dad Plans\Tree Houses And Kids Structure Plans
- Teds VIP Deluxe Woodworking Reference\Home DIY Guides
- Teds VIP Deluxe Woodworking Reference\WoodWorking-Guides

Woodworkers Guild of America – The Complete Guide to Wood finishing



TOP NOTCH FINISHING TECHNIQUES – 64 MINUTES.

SANDING, STAINS & TOP COATS – 92 MINUTES.

SPRAYING – 53 MINUTES.

SHELLAC – 76 MINUTES.

WOOD COLORING TECHNIQUES – 62 MINUTES.

ADVANCED SANDING TECHNIQUES – 86 MINUTES.

GLUING & CLAMPING SKILLS – 67 MINUTES.

CONTROLLING COLOR WITH SUCCESS – 74 MINUTES.

GENERAL TIPS & TRICKS – 85 MINUTES.

Sun City Woodworker Guild - Library Computer