

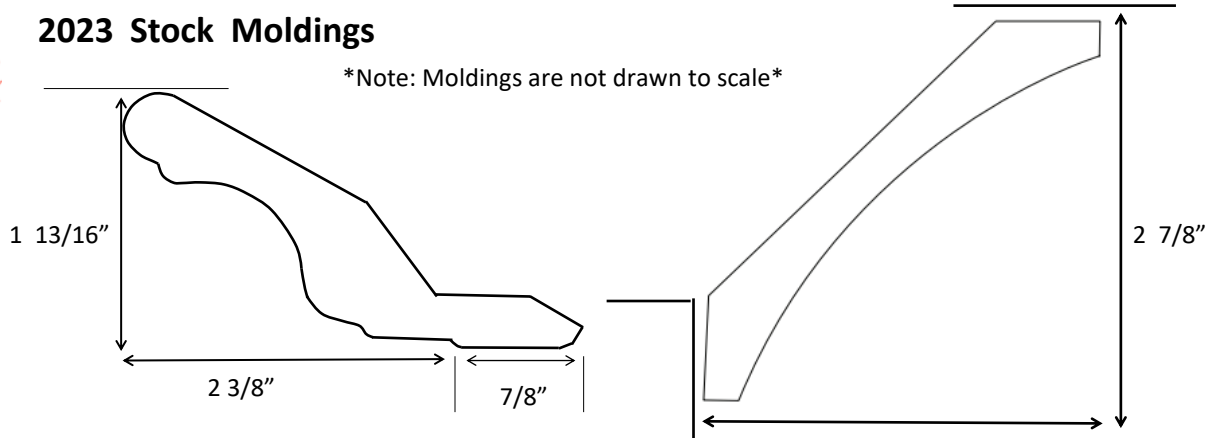

2023 Stock Moldings

Note: Moldings are not drawn to scale



CR1
Top Mount Crown

CR2
4 1/4" Cove Crown

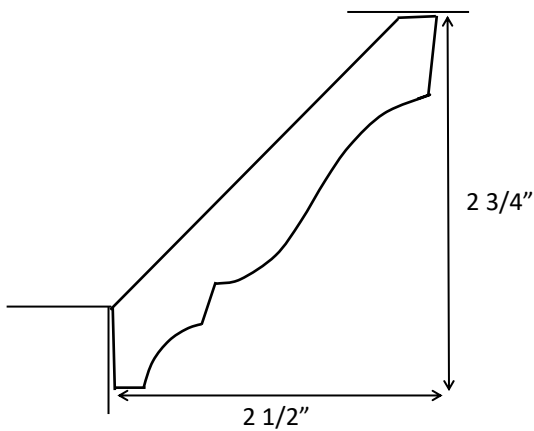

CR4
3 5/8" Wall Mount Crown

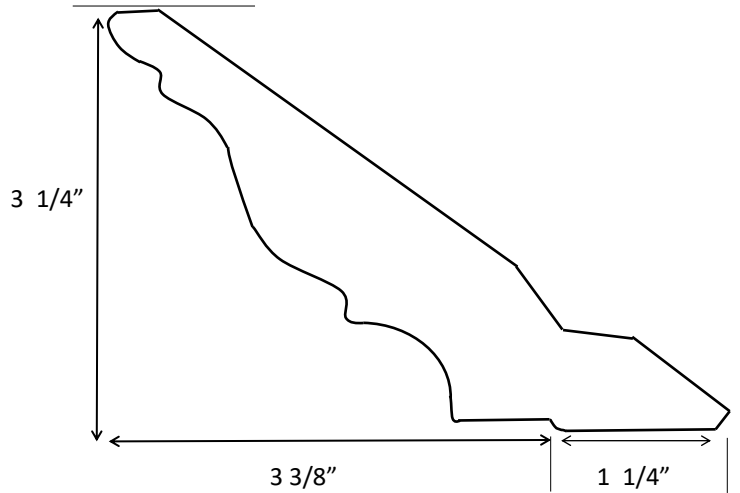

CR5
Top Mount Crown

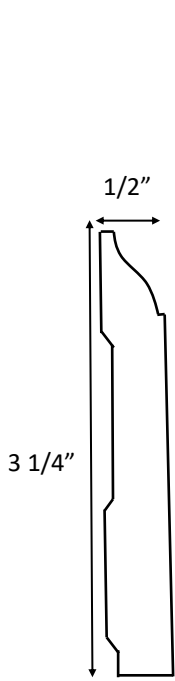

B1
Base Molding

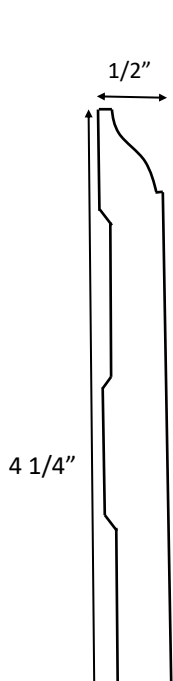

B2
Base Molding

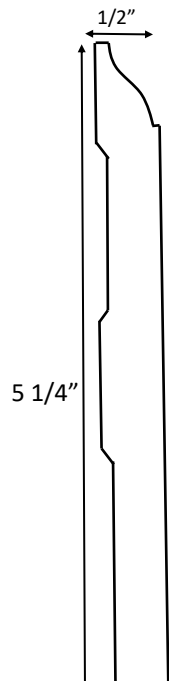

B3
Base Molding

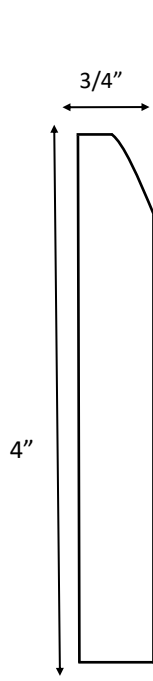

P4
Base Molding

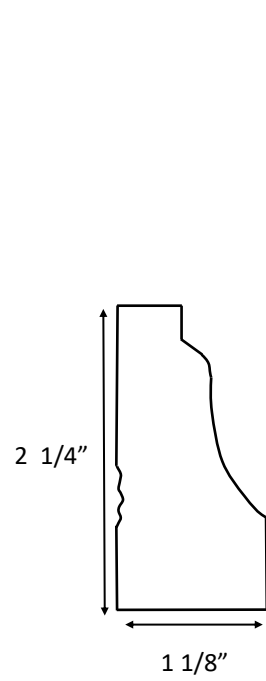

CR8
Crown/Base Molding

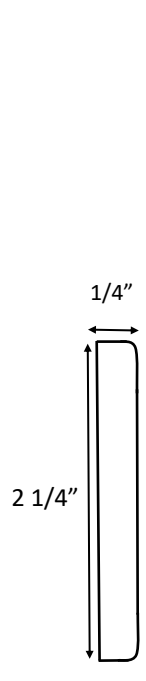

M2
Scribe/Batten